



Welded Fittings

Catalog 4280

November 2011

aerospace
climate control
electromechanical
filtration
fluid & gas handling
hydraulics
pneumatics
process control
sealing & shielding



ENGINEERING YOUR SUCCESS.

Welded Fittings

Catalog 4280



Huntsville, Alabama, USA

WARNING – USER RESPONSIBILITY

FAILURE OR IMPROPER SELECTION OR IMPROPER USE OF THE PRODUCTS DESCRIBED HEREIN OR RELATED ITEMS CAN CAUSE DEATH, PERSONAL INJURY AND PROPERTY DAMAGE.

This document and other information from Parker-Hannifin Corporation, its subsidiaries and authorized distributors provide product or system options for further investigation by users having technical expertise.

The user, through its own analysis and testing, is solely responsible for making the final selection of the system and components and assuring that all performance, endurance, maintenance, safety and warning requirements of the application are met. The user must analyze all aspects of the application, follow applicable industry standards, and follow the information concerning the product in the current product catalog and in any other materials provided from Parker or its subsidiaries or authorized distributors.

To the extent that Parker or its subsidiaries or authorized distributors provide component or system options based upon data or specifications provided by the user, the user is responsible for determining that such data and specifications are suitable and sufficient for all applications and reasonably foreseeable uses of the components or systems.

Offer of Sale

The items described in this document are hereby offered for sale by Parker-Hannifin Corporation, its subsidiaries or its authorized distributors. This offer and its acceptance are governed by the provisions stated in the detailed "Offer of Sale" elsewhere in this document or available at www.parker.com/ipdus.

© Copyright 2011, Parker Hannifin Corporation. All Rights Reserved



Parker Hannifin Corporation
Instrumentation Products Division
Huntsville, AL USA
<http://www.parker.com/ipdus>

Welded Fittings

Visual Index

Weld-lok® Socket Weld Tube Fittings

Union

HW..... page 5



Tube Reducer

TRW..... page 5

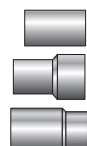

Elbow

EW..... page 6



45° Elbow

NW..... page 6



Tee

JW..... page 7

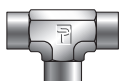

Cross

KW..... page 7



Male Elbow

CW..... page 8



Male Connector

FW..... page 8



Female Connector

GW..... page 9



Female Elbow

DW..... page 9



Male Run Tee

RW..... page 10



Male Branch Tee

SW..... page 10

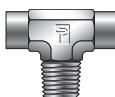

Adapter

AW..... Page 11



Adapter

AW2..... page 12

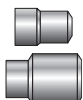

Weld-lok® To Compression

Socket Weld Connector

ZHBW..... page 13



Buttweld Connector

ZHBW2..... page 14

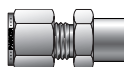

Socket Weld Elbow

ZEBW..... page 15

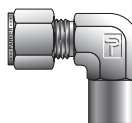

Buttweld Elbow

ZEBW2..... page 15

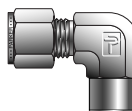

Welded Fittings

Introduction

In the chemical industry, process pressures are climbing higher and higher. The utility field, with its high steam pressures and hydraulic and pneumatic shutdown systems, demands the utmost in reliability. Nuclear power plants with their "hot" materials also have massive reliability problems. Such problem areas have given rise to the increased use of the permanent-weld-type tube fittings which provide a sturdy, tight integral line system that remains unaffected by shock, vibration or thermal distortion. The Parker Weld-lok® line of permanent socket weld tube fittings meets the most exacting requirements of any system.

Heat Code Traceability

Parker Hannifin's Instrumentation Products Division offers Heat Code Traceability (HCT) on CPI™, A-LOK®, Instrumentation Pipe, Automatic Butt weld, and Weld-lok®.

HCT refers to the fact that a specific part can be traced back to the original mill heat of metal from which it was made. Beginning with the original melt, a package of documents is created which completely describes the metal in physical and chemical terms. The end result is that a number, which is permanently stamped to the part, refers back to the document package.

The HCT number is stamped on the material (bar stock or forging) prior to manufacturing. The concept is useful because it provides a method for complete material accountability for the manufacturer and end customer.

HCT offers these advantages:

- ▶ Raw materials for manufacture must meet code requirements. This can be verified through documentation so that the customer is certain that what is ordered is received.
- ▶ HCT provides a record of chemical analysis with the raw material. Thus, in areas requiring welding, the correct welding technique is applied.
- ▶ HCT relieves the user of Parker instrumentation tube fittings of any doubts. It acts as an assurance for today and for tomorrow.

The material used in Parker Hannifin instrumentation fitting components is 316 stainless steel as specified and referenced in Section III of the ASME Boiler and Pressure Vessel code.

The American Society of Mechanical Engineers (ASME) Boiler and Vessel Code, Section III, latest issue, entitled Rules for Construction of Nuclear Power Plant Components, is the principal document covering this type of fitting in the nuclear field. ANSI Standard B.31.1, Power Piping, and ANSI Standard B.31.7, Nuclear Power Piping, are also important documents in the field.

In addition to the documentation of chemical and physical properties, great care is taken throughout the manufacture of Parker's tube fittings to ensure that potential stress corrosion will not be a problem in normal usage of the parts. Manufacturing processes avoid exposure of the parts to mercury or halogens, and control of thermal treatment avoids the condition known as continuous grain boundary carbide precipitation (see page 4).

For additional information please contact your local authorized Parker Instrumentation distributor or call Parker Instrumentation Products Division.



Weld-lok® Socket Weld Tube Fittings

Weld-lok® Socket Weld Fittings

The weld used in joining a tube to a socket weld tube fitting is like any other type of “tee” weld. The root (i.e., the point of intersection of the outside of the tube and annular end area of the fitting) must be included in the weld zone.

Careful welding procedures are normally followed to assure that this root area is included in the weld. If penetration is not achieved, the joint will have two built-in stress risers which may greatly reduce the strength of the weld. Upon application of an extreme load, these stress risers could result in cracks which could propagate out through the weld or tube depending upon the direction of the greatest load.

Often to achieve full root penetration in TIG welding of stainless steels, a fusion pass will be made first, followed by a final pass utilizing a filler rod to achieve the desired fillet size.

Assembly

The codes applicable to the welding of socket weld fittings require that the tube be inserted into the socket until bottomed against the stop. The tube is then to be backed out approximately 1/16 of an inch and then welded.

If the tube is not backed out, but welded when against a flat bottom stop, the contraction of the weld fillet and fitting socket can combine to produce a static stress on the weld. During thermal transients, the fitting and the portion of the tube within the fitting may experience a differential rate of heating or cooling, again adding to the stress level in the weld.

Tacking

If the weld joint is to be “tacked” before welding, it is recommended that the “tack” weld build-up be held to a minimum.

Excessive build-up on the “tack” may cause an interrupted final bead and a stress riser or lack of complete fusion.

Backing Gas

Backing gas is an inert (no active properties) gas used to flood the interior of the fittings and tube system during welding. It serves the same purpose internally as the shielding gas used in TIG or MIG welding. By reducing the interior oxygen level to as low as practicable, it also serves to control the combustion of contaminants that could affect weld quality.

When a backing gas is not used and nearly 100% weld penetration is achieved, blisters will tend to form on the internal tube wall. This will result in scale which

may later break loose. Therefore, in 0.050 wall or thinner tube or where the wall thickness is such that the selected weld process may burn through, the use of a backing gas is required.

In most cases the backing gas will be argon or helium connected to the system through a control regulator. Flow rates, while small, should be high enough to purge the system. Welds should be made in downstream sequence from the gas connection.

Note that the entire system should be purged to insure that there are no openings that will allow air to be drawn into the system.

The use of backing gas, while often not mandatory, will give a better weld joint. This is because the effects of contaminate combustion by-products are eliminated and because the welds are made and cooled under a shielded atmosphere, thus eliminating internal scaling or blistering.

Welding Methods Arc Polarity

When welding Weld-lok® fittings, best results will be obtained by the following arc polarities:

TIG – Direct Current, straight polarity
MIG – Direct Current, reverse polarity
STICK – Polarity dependent on rod used.

300 Series Stainless Steels

May be welded by the TIG, MIG, or stick arc-weld process.

TIG welding is recommended as being best for welding Weld-lok® systems because it allows better operator control of heat penetration and filler material deposition.

Stick arc welding is not recommended in many cases because of the likelihood of excessive burn-through and improper root penetration. In all cases where stick welding is used, it is recommended that backing gas be used.

MIG welding gives the same characteristics as stick electrode welding with faster deposition of the filler material. As this process runs “hotter” than the stick process, the use of a backing gas is mandatory. It should be noted that in welding the relatively small fitting sizes found in the Weld-lok® line, filler deposition rate economies are not a factor and therefore the MIG method is not commonly applied.

C1018 Steel Fittings

May be welded by the TIG, MIG, stick and oxyacetylene methods. As scale formation remains a problem, the use of a backing gas is still recommended.



Weld-lok® Socket Weld Tube Fittings

Catalog 4280

Carbide Precipitation

When unstabilized stainless steels are heated to 800°–1500°F during welding, the chromium in the steel combines with the carbon to form chrome carbides which tend to form along the grain boundaries of the metal (carbide precipitation). This lowers the dissolved chromium content in these areas and thus lowers their corrosion resistance, making them vulnerable to intergranular corrosion. Carbide precipitation is reduced by holding the carbon content of the material to a very low value. This limits the amount of carbon available to combine

with the chromium. The “L” series (extra low carbon) stainless steels are often used for this purpose, but their use reduces system design stress by approximately 15%. Parker Weld-lok® fittings are made from a select 316 series with carbon content in the low range of 0.04 to 0.07 percent. This results in a welded fitting with good corrosion resistance and a high strength factor.

All Parker Weld-lok® fittings in stainless steel are supplied in the solution-treated condition, capable of passing ASTM-A-262 Tests for Detecting Susceptibility to Intergranular Corrosion.

How To Order

Parker Weld-lok® components are ordered by part number easily derived from the following example and ordering chart. The five product characteristics required are coded as shown in the chart.

The example below describes a 90° elbow fitting going from 1/4" tubing to 1/4" tubing.

Example: 4-4 EW-SS

4	-	4	E	W	-	SS
Fitting Size		Fitting Size ¹	Fitting Type	Machining Type		Material
Fitting Size		Fitting Size	Welded Fitting Type	Machining Type		Material
The first two numbers denote the fitting size which matches the tubing O.D.			H Straight J Union T Tee E Union Elbow	W Weld-lok®		SS Stainless Steel 316 304 ² Stainless Steel 304 316L ² Stainless Steel 316L 316H ² Stainless Steel 316H
4	1/4" tube					
6	3/8" tube					
8	1/2" tube					

Special fittings: If a special fitting configuration is required, it is suggested that a sketch or drawing be submitted for review.

Availability: Only items listed in current price list (4280) are carried in stock. Customer Specials may be quoted through Parker IPD Customer Service.

¹ When both ends of the fittings are the same size and configuration, the size is only called out once.

² Can be supplied upon request.

Typical Raw Material Specifications

Fitting Material	Bar Stock	Forgings	Recommended Tubing Specifications	
Stainless Steel 316	ASTM A-276 TYPE 316 ASME SA-479 TYPE 316	ASME SA-182 GRADE 316	ASME SA-213	ASTM A-269
			ASTM A-213	MIL T-8504
			ASTM A-249	MIL T-8506

Where To Order

Parker Weld-lok® components are ordered from:
Instrumentation Products Division.
1005 A Cleaner Way
Huntsville, AL 35805
Phone: 256-881-2040

thickness meeting the related (3000-psi pipe class) pressure requirements. Strong, full section forgings are used for all “shape” fittings.

User Specification Requirements

The 316 stainless steel Weld-lok® fittings fully conforms to the applicable specifications covered in:

- ANSI B31.1 “Power Piping”
- ANSI B31.7 “Nuclear Power Piping”
- Section III, “Nuclear Power Plant Component,” ASME Boiler and Pressure Vessel Code

Customer Specials may be quoted through the Parker Quick Response Department.



Weld-lok® Socket Weld Tube Fittings

Union, Tube Socket End – Both Ports

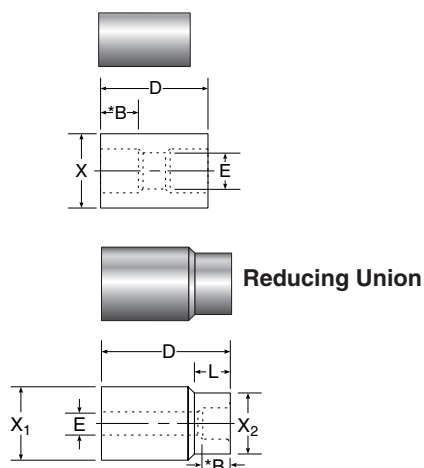

Part Number	Inches								Work. Press.
	Tube O.D.	Tube O.D.	E Small Bore	*B	D	L	X Dia.		
2 HW	1/8	1/8	.09	.156	.69		.375	10,200	
3 HW	3/16	3/16	.14	.203	.78		.438	9,600	
4-3 HW	1/4	3/16	.14	.25-.20	.85	.39	.50-.44	9,600	
4 HW	1/4	1/4	.19	.250	.88		.500	9,600	
5 HW	5/16	5/16	.25	.313	1.00		.594	9,900	
6-4 HW	3/8	1/4	.19	.34-.25	1.00	.44	.63-.50	8,100	
6 HW	3/8	3/8	.31	.344	1.06		.625	8,100	
8-4 HW	1/2	1/4	.19	.41-.25	1.11	.44	.78-.50	7,300	
8-6 HW	1/2	3/8	.31	.41-.34	1.17	.53	.78-.63	7,300	
8 HW	1/2	1/2	.44	.406	1.19		.781	7,300	
10-6 HW	5/8	3/8	.31	.47-.34	1.28	.53	.94-.63	6,600	
10 HW	5/8	5/8	.50	.469	1.31		.938	6,600	
12-4 HW	3/4	1/4	.19	.50-.25	1.30	.44	1.09-.50	6,000	
12-8 HW	3/4	1/2	.44	.50-.41	1.37	.59	1.09-.78	6,000	
12-10 HW	3/4	5/8	.50	.50-.47	1.39	.66	1.09-.94	6,000	
12 HW	3/4	3/4	.66	.500	1.38		1.094	6,000	
14 HW	7/8	7/8	.78	.500	1.38		1.312	5,700	
16-8 HW	1	1/2	.44	.56-.41	1.53	.59	1.44-.78	4,900	
16-12 HW	1	3/4	.66	.56-.50	1.54	.69	1.44-1.09	4,900	
16 HW	1	1	.91	.563	1.50		1.44	4,900	
20-12 HW	1-1/4	3/4	.66	.63-.50	1.69	.69	1.75-1.09	4,600	
20-16 HW	1-1/4	1	.91	.63-.56	1.65	.75	1.75-1.44	4,600	
20 HW	1-1/4	1-1/4	1.06	.625	1.625		1.750	4,600	
24-8 HW	1-1/2	1/2	.44	.67-.41	1.80	.59	2.0-.78	3,700	
24-16 HW	1-1/2	1	.91	.67-.56	1.77	.75	2.0-1.44	3,700	
24-20- HW	1-1/2	1-1/4	1.06	.67-.63	1.74	.81	2.0-1.75	3,700	
24 HW	1-1/2	1-1/2	1.31	.670	1.84		2.0	3,700	
32-16 HW	2	1	.91	.78-.56	2.06	.75	2.62-1.44	3,300	
32 HW	2	2	1.81	.781	2.13		2.625	3,300	

*Socket Depth.

Tube Reducer, Tube Socket Reducer

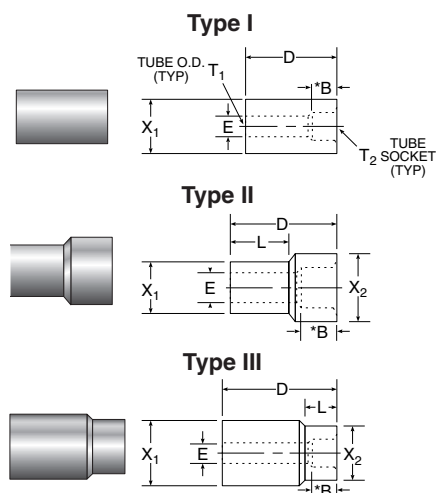

Part Number	Inches									Work. Press.
	T ₁ Size	T ₂ Tube Sock.	Type	D	X ₁ Dia.	X ₂ Dia.	L	E Small Bore	*B	
6-4 TRW	3/8	1/4	II	.94	.375	.500	.47	.19	.250	9,600
8-4 TRW	1/2	1/4	I	.88	.500	.50	-	.19	.250	9,600
8-6 TRW	1/2	3/8	II	1.13	.500	.63	.56	.31	.344	7,800
10-4 TRW	5/8	1/4	III	1.22	.623	.50	.44	.19	.250	9,600
10-6 TRW	5/8	3/8	I	1.03	.623	.62	-	.31	.344	8,100
10-8 TRW	5/8	1/2	II	1.26	.623	.78	.63	.41	.406	6,100
12-4 TRW	3/4	1/4	III	1.32	.750	.50	.44	.19	.250	9,600
12-6 TRW	3/4	3/8	III	1.38	.750	.63	.53	.31	.344	8,100
12-8 TRW	3/4	1/2	II	1.29	.750	.78	.69	.44	.406	7,300
12-10 TRW	3/4	5/8	II	1.40	.750	.94	.69	.50	.469	6,600
16-4 TRW	1	1/4	III	1.44	1.000	.50	.44	.19	.250	9,600
16-6 TRW	1	3/8	III	1.50	1.000	.63	.53	.31	.344	8,100
16-8 TRW	1	1/2	III	1.51	1.000	.78	.59	.44	.406	7,300
16-10 TRW	1	5/8	III	1.52	1.000	.94	.66	.50	.469	6,600
16-12 TRW	1	3/4	II	1.47	1.000	1.09	.75	.66	.500	6,000
20-4 TRW	1-1/4	1/4	III	1.65	1.250	.50	.44	.19	.250	9,600
20-6 TRW	1-1/4	3/8	III	1.68	1.250	.63	.53	.31	.344	8,100
20-8 TRW	1-1/4	1/2	III	1.73	1.250	.78	.59	.44	.406	7,300
20-12 TRW	1-1/4	3/4	III	1.73	1.250	1.09	.69	.66	.500	6,000
20-16 TRW	1-1/4	1	II	1.68	1.250	1.44	.88	.91	.563	4,900
24-12 TRW	1-1/2	3/4	III	1.85	1.500	1.09	.69	.66	.500	6,000
24-16 TRW	1-1/2	1	III	1.81	1.50	1.44	.75	.91	.563	4,900
24-20 TRW	1-1/2	1-1/4	II	1.70	1.500	1.75	.81	1.06	.625	4,600

*Socket Depth.

NOTE: Other drop sizes available upon request. Dimensions for reference only, subject to change.



Weld-lok® Socket Weld Tube Fittings

Catalog 4280

Elbow, Tube Socket End – Both Ports

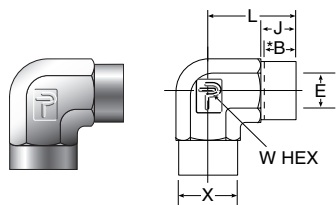

Part Number	Inches								
	Tube O.D.1	Tube O.D.2	E Small Bore	*B	L	J	W Hex	X Dia.	Work. Press.
2 EW	1/8	1/8	.09	.156	.70	.34	1/2	.375	10,200
3 EW	3/16	3/16	.14	.203	.75	.39	1/2	.438	9,600
4 EW	1/4	1/4	.19	.250	.84	.44	9/16	.500	9,600
5 EW	5/16	5/16	.25	.313	.90	.50	9/16	.594	9,900
6-4 EW	3/8	1/4	.19	.344	1.08-.98	.53-.44	13/16	.63-.50	8,100
6 EW	3/8	3/8	.31	.344	1.08	.53	13/16	.625	8,100
8-4 EW	1/2	1/4	.19	.406	1.14-.98	.59-.44	7/8	.78-.50	7,300
8-6 EW	1/2	3/8	.31	.406	1.14-1.08	.59-.53	7/8	.78-.63	7,300
8 EW	1/2	1/2	.44	.406	1.14	.59	7/8	.781	7,300
10 EW	5/8	5/8	.50	.469	1.36	.66	1-1/16	.938	6,600
12 EW	3/4	3/4	.66	.500	1.39	.69	1-1/16	1.094	6,000
14 EW	7/8	7/8	.78	.500	1.58	.69	1-5/16	1.312	5,700
16 EW	1	1	.91	.563	1.84	.75	1-5/8	1.438	4,400
20 EW	1-1/4	1-1/4	1.06	.625	2.10	.81	1-7/8	1.750	4,600
24 EW	1-1/2	1-1/2	1.31	.670	2.54	.86	2-1/2	2.000	3,700
32 EW	2	2	1.81	.781	2.78	.97	2-13/16	2.625	3,300

*Socket Depth.

45° Elbow, Tube Socket – Both Ends

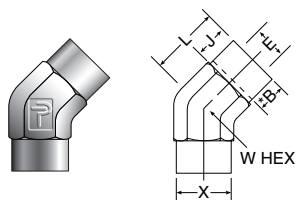

Part Number	Inches								
	Tube O.D.	Tube O.D.	E Small Bore	L	X Dia.	W Hex	*B	J	Work. Press.
2 NW	1/8	1/8	.09	.53	.375	7/16	.156	.34	10,200
3 NW	3/16	3/16	.14	.73	.438	9/16	.203	.39	9,600
4 NW	1/4	1/4	.19	.84	.500	9/16	.250	.44	9,600
5 NW	5/16	5/16	.25	.86	.594	9/16	.313	.50	9,900
6 NW	3/8	3/8	.31	1.08	.625	7/8	.344	.53	8,100
8 NW	1/2	1/2	.44	1.14	.781	7/8	.406	.59	7,300
10 NW	5/8	5/8	.50	1.34	.938	1-1/16	.469	.66	6,600
12 NW	3/4	3/4	.66	1.34	1.094	1-1/16	.500	.69	6,000
16 NW	1	1	.91	1.63	1.438	1-5/8	.563	.75	4,400
20 NW	1-1/4	1-1/4	1.06	1.63	1.75	1-7/8	.625	.81	4,600
24 NW	1-1/2	1-1/2	1.31	1.67	2.00	2-1/2	.670	.86	3,700
32 NW	2	2	1.81	1.67	2.63	2-1/2	.781	.97	3,300

*Socket Depth.

NOTE: Other drop sizes available upon request.
Dimensions for reference only, subject to change.



Weld-lok® Socket Weld Tube Fittings

Tee, Tube Socket End – All 3 Ports

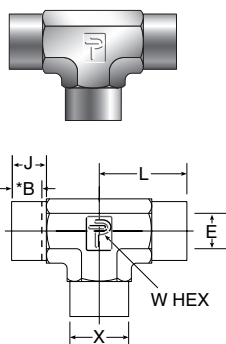

Part Number	Inches									
	Tube O.D. ₁	Tube O.D. ₂	Tube O.D. ₃	E Small Bore	*B	J	L	W Hex	X Dia.	Work. Press.
2 JW	1/8	1/8	1/8	.09	.156	.34	.70	1/2	.375	10,200
3 JW	3/16	3/16	3/16	.14	.203	.39	.75	1/2	.438	9,600
4 JW	1/4	1/4	1/4	.19	.250	.44	.84	9/16	.500	9,600
5 JW	5/16	5/16	5/16	.25	.313	.50	.90	9/16	.594	9,900
6-6-4 JW	3/8	3/8	1/4	.19	.34-.25	.53-.44	1.08-.99	13/16	.63-.50	8,100
6 JW	3/8	3/8	3/8	.31	.344	.53	1.08	13/16	.625	8,100
8-4-4 JW	1/2	1/4	1/4	.19	.41-.25	.59-.44	1.14-.98	7/8	.78-.50	7,300
8-6-6 JW	1/2	3/8	3/8	.31	.41-.34	.59-.53	1.14-1.08	7/8	.78-.63	7,300
8-8-4 JW	1/2	1/2	1/4	.19	.41-.25	.59-.44	1.14-.98	7/8	.78-.50	7,300
8-8-6 JW	1/2	1/2	3/8	.31	.41-.34	.59-.53	1.14-1.08	7/8	.78-.63	7,300
8 JW	1/2	1/2	1/2	.44	.406	.59	1.14	7/8	.781	7,300
10 JW	5/8	5/8	5/8	.50	.469	.66	1.36	1-1/16	.938	6,600
12-8-12 JW	3/4	1/2	3/4	.44	.50-.41	.69-.59	1.39-1.29	1-1/16	1.09-.78	6,000
12 JW	3/4	3/4	3/4	.66	.500	.69	1.39	1-1/16	1.094	6,000
14 JW	7/8	7/8	7/8	.78	.500	.69	1.58	1-3/8	1.312	5,700
16-8-16 JW	1	1/2	1	.44	.56-.41	.75-.59	1.84-1.68	1-5/8	1.44-.78	4,400
16-12-16 JW	1	3/4	1	.66	.56-.50	.75-.69	1.84-1.77	1-5/8	1.44-1.09	4,400
16 JW	1	1	1	.91	.563	.750	1.84	1-5/8	1.44	4,400
20-16-20 JW	1-1/4	1	1-1/4	.91	.63-.56	.81-.75	2.10-2.04	1-7/8	1.75-1.44	4,600
20 JW	1-1/4	1-1/4	1-1/4	1.06	.625	.812	2.102	1-7/8	1.750	4,600
24-16-24 JW	1-1/2	1	1-1/2	.91	.67-.56	.86-.75	2.54-2.44	2-1/2	2.00-1.44	3,700
24 JW	1-1/2	1-1/2	1-1/2	1.31	.670	.857	2.54	2-1/2	2.000	3,700
32 JW	2	2	2	1.81	.781	.968	2.78	2-13/16	2.625	3,300

*Socket Depth.

Cross, Tube Socket End – All 4 Ports

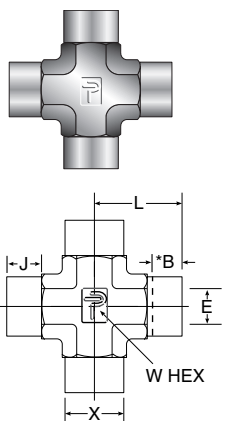

Part Number	Inches								
	Tube O.D.	E Small Bore	*B	J	L	W Hex	X Dia.	Work. Press.	
2 KW	1/8	.09	.156	.34	.70	1/2	.375	10,200	
3 KW	3/16	.14	.203	.39	.75	1/2	.438	9,600	
4 KW	1/4	.19	.250	.44	.84	9/16	.500	9,600	
5 KW	5/16	.25	.313	.50	.90	9/16	.594	9,900	
6 KW	3/8	.31	.344	.53	1.07	13/16	.625	8,100	
8 KW	1/2	.44	.406	.59	1.14	7/8	.781	7,300	
10 KW	5/8	.50	.469	.66	1.36	1-1/16	.938	6,600	
12 KW	3/4	.66	.500	.69	1.39	1-1/16	1.094	6,000	
16 KW	1	.91	.563	.75	1.84	1-5/8	1.438	4,400	
20 KW	1-1/4	1.06	.625	.81	2.10	1-7/8	1.750	4,600	
24 KW	1-1/2	1.31	.670	.86	2.54	2-9/16	2.000	3,700	
32 KW	2	1.81	.781	.97	2.78	2-9/16	2.625	3,300	

*Socket Depth.

NOTE: Other drop sizes available upon request.
Dimensions for reference only, subject to change.



Weld-lok® Socket Weld Tube Fittings

Catalog 4280

Male Elbow, Tube Socket End – Male Pipe End

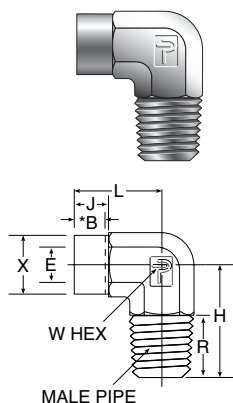

Part Number	Inches										
	Tube O.D. ₁	Male Pipe	E Small Bore	*B	H	J	L	R	W Hex	X Dia.	Work. Press.
2 CW	1/8	1/8	.09	.156	.74	.34	.70	.38	1/2	.375	9,100
2-4 CW	1/8	1/4	.09	.156	.93	.34	.70	.56	1/2	.375	7,500
3 CW	3/16	1/8	.14	.203	.74	.39	.75	.38	1/2	.438	9,100
4 CW	1/4	1/8	.19	.250	.79	.44	.84	.38	9/16	.500	9,100
4-4 CW	1/4	1/4	.19	.250	.97	.44	.84	.56	9/16	.500	7,500
5 CW	5/16	1/8	.25	.313	.79	.50	.90	.38	9/16	.594	9,100
6 CW	3/8	1/4	.31	.344	1.12	.53	1.08	.56	13/16	.625	7,500
6-6 CW	3/8	3/8	.31	.344	1.12	.53	1.08	.56	13/16	.625	7,200
6-8 CW	3/8	1/2	.31	.344	1.31	.53	1.08	.75	13/16	.625	5,800
8-4 CW	1/2	1/4	.44	.406	1.12	.59	1.14	.56	7/8	.78	7,300
8 CW	1/2	3/8	.44	.406	1.12	.59	1.14	.56	7/8	.78	7,200
8-8 CW	1/2	1/2	.44	.406	1.31	.59	1.14	.75	13/16	.78	5,800
10 CW	5/8	1/2	.50	.469	1.46	.66	1.36	.75	1-1/16	.94	5,800
12-4 CW	3/4	1/4	.66	.500	1.27	.69	1.39	.56	1-1/16	1.09	6,000
12-8 CW	3/4	1/2	.66	.500	1.46	.69	1.39	.75	1-1/16	1.09	5,800
12 CW	3/4	3/4	.66	.500	1.46	.69	1.39	.75	1-1/16	1.09	6,000
16-12 CW	1	3/4	.72	.563	1.84	.75	1.84	.75	1-5/8	1.44	4,900
16 CW	1	1	.91	.563	2.03	.75	1.84	.94	1-5/8	1.44	4,400
20 CW	1-1/4	1-1/4	1.06	.625	2.27	.81	2.10	.97	1-7/8	1.750	3,500
24 CW	1-1/2	1-1/2	1.31	.670	2.69	.86	2.54	1.00	2-1/2	2.000	2,900

*Socket Depth.

Male Connector, Tube Socket End – Male Pipe End

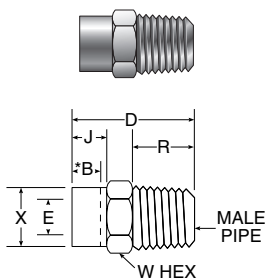

Part Number	Inches										
	Tube O.D.	Male Pipe	E Small Bore	*B	D	J	R	W Hex	X Dia.	Work. Press.	
2 FW	1/8	1/8	.09	.156	.94	.34	.38	7/16	.375	9,100	
2-4 FW	1/8	1/4	.09	.156	1.14	.34	.56	9/16	.375	7,500	
3 FW	3/16	1/8	.14	.203	.98	.39	.38	1/2	.438	9,100	
3-4 FW	3/16	1/4	.14	.203	1.19	.39	.56	9/16	.438	7,500	
4 FW	1/4	1/8	.19	.250	1.05	.44	.38	9/16	.500	9,100	
4-4 FW	1/4	1/4	.19	.250	1.23	.44	.56	9/16	.500	7,500	
4-8 FW	1/4	1/2	.19	.250	1.50	.44	.75	7/8	.500	6,600	
5 FW	5/16	1/8	.25	.313	1.13	.50	.38	5/8	.594	9,100	
6-2 FW	3/8	1/8	.19	.344	1.16	.53	.38	11/16	.625	8,100	
6 FW	3/8	1/4	.28	.344	1.34	.53	.56	11/16	.625	7,500	
6-6 FW	3/8	3/8	.31	.344	1.34	.53	.56	11/16	.625	7,200	
6-8 FW	3/8	1/2	.31	.344	1.59	.53	.75	7/8	.625	6,600	
6-12 FW	3/8	3/4	.31	.344	1.66	.53	.75	1-1/16	.625	6,400	
8-2 FW	1/2	1/8	.19	.406	1.25	.59	.38	13/16	.781	7,300	
8-4 FW	1/2	1/4	.28	.406	1.44	.59	.56	13/16	.781	7,300	
8 FW	1/2	3/8	.41	.406	1.44	.59	.56	13/16	.781	7,200	
8-8 FW	1/2	1/2	.44	.406	1.66	.59	.75	7/8	.781	6,600	
8-12 FW	1/2	3/4	.44	.406	1.72	.59	.75	1-1/16	.781	6,400	
10-4 FW	5/8	1/4	.28	.469	1.56	.66	.56	1	.938	6,600	
10-6 FW	5/8	3/8	.41	.469	1.56	.66	.56	1	.938	6,600	
10 FW	5/8	1/2	.50	.469	1.75	.66	.75	1	.938	6,600	
10-12 FW	5/8	3/4	.50	.469	1.78	.66	.75	1-1/16	.938	6,400	
12-8 FW	3/4	1/2	.50	.500	1.81	.69	.75	1-1/8	1.094	6,000	
12 FW	3/4	3/4	.66	.500	1.81	.69	.75	1-1/8	1.094	6,000	
12-16 FW	3/4	1	.66	.500	2.09	.69	.94	1-3/8	1.094	4,600	
14 FW	7/8	3/4	.72	.500	1.91	.69	.75	1-3/8	1.312	5,700	
16-8 FW	1	1/2	.50	.563	2.02	.75	.75	1-5/8	1.438	4,900	
16-12 FW	1	3/4	.72	.563	2.02	.75	.75	1-5/8	1.438	4,900	
16 FW	1	1	.91	.563	2.20	.75	.94	1-5/8	1.438	4,600	
20-12 FW	1-1/4	3/4	.72	.625	2.14	.81	.75	1-7/8	1.750	4,600	
20-16 FW	1-1/4	1	.94	.625	2.33	.81	.94	1-7/8	1.750	4,600	
20 FW	1-1/4	1-1/4	1.06	.625	2.36	.81	.97	1-7/8	1.750	3,500	
20-24 FW	1-1/4	1-1/2	1.06	.625	2.42	.81	1.00	2	1.750	2,900	
24-20 FW	1-1/2	1-1/4	1.25	.670	2.49	.86	.97	2-1/8	2.000	3,500	
24 FW	1-1/2	1-1/2	1.31	.670	2.52	.86	1.00	2-1/8	2.000	2,900	
32 FW	2	2	1.81	.781	2.97	.97	1.03	2-3/4	2.625	2,600	

*Socket Depth.

NOTE: Other drop sizes available upon request. Dimensions for reference only, subject to change.



Weld-lok® Socket Weld Tube Fittings

Female Connector, Tube End Socket – Female Pipe End

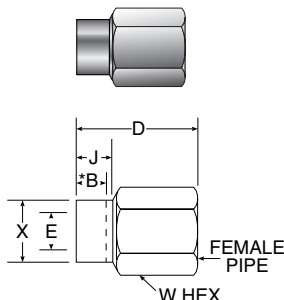

Part Number	Inches								
	Tube O.D.	Female Pipe	E Small Bore	*B	D	J	W Hex	X Dia.	Work. Press.
2 GW	1/8	1/8	.09	.156	.95	.34	9/16	.375	6,400
3 GW	3/16	1/8	.14	.203	.98	.39	9/16	.438	6,400
4 GW	1/4	1/8	.19	.250	1.01	.44	9/16	.500	6,400
4-4 GW	1/4	1/4	.19	.250	1.26	.44	3/4	.500	6,600
4-12 GW	1/4	3/4	.19	.250	1.80	.44	1-1/4	.500	4,300
5 GW	5/16	1/8	.25	.313	1.07	.50	5/8	.594	6,400
6-2 GW	3/8	1/8	.31	.344	1.11	.53	11/16	.625	6,400
6 GW	3/8	1/4	.31	.344	1.32	.53	3/4	.625	6,600
6-6 GW	3/8	3/8	.31	.344	1.42	.53	7/8	.625	5,300
6-8 GW	3/8	1/2	.31	.344	1.67	.53	1-1/16	.625	5,200
6-12 GW	3/8	3/4	.31	.344	1.86	.53	1-1/4	.625	4,300
6-16 GW	3/8	1	.31	.344	2.30	.53	1-5/8	.625	4,500
8-2 GW	1/2	1/8	.34	.406	1.17	.59	13/16	.781	6,400
8-4 GW	1/2	1/4	.44	.406	1.36	.59	13/16	.781	6,600
8 GW	1/2	3/8	.44	.406	1.44	.59	7/8	.781	5,300
8-8 GW	1/2	1/2	.44	.406	1.69	.59	1-1/16	.781	5,200
10-6 GW	5/8	3/8	.50	.469	1.52	.66	1-1/16	.938	5,300
10 GW	5/8	1/2	.50	.469	1.71	.66	1-1/16	.938	5,200
10-16 GW	5/8	1	.50	.469	2.33	.66	1-5/8	.938	4,500
12-8 GW	3/4	1/2	.66	.500	1.72	.69	1-1/8	1.094	5,200
12 GW	3/4	3/4	.66	.500	1.88	.69	1-1/4	1.094	4,300
14 GW	7/8	3/4	.78	.500	1.86	.69	1-3/8	1.312	4,300
16-8 GW	1	1/2	.72	.563	1.85	.75	1-5/8	1.438	4,900
16-12 GW	1	3/4	.92	.563	1.97	.75	1-5/8	1.438	4,300
16 GW	1	1	.92	.563	2.28	.75	1-5/8	1.438	4,500
20 GW	1-1/4	1-1/4	1.06	.625	2.39	.81	2	1.750	3,500

*Socket Depth.

Female Elbow, Tube Socket End – Female Pipe End

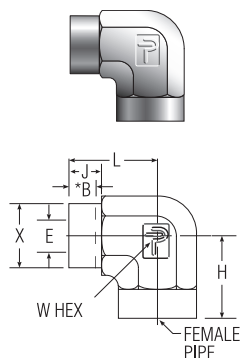

Part Number	Inches									
	Tube O.D.	Female Pipe	E Small Bore	*B	H	J	L	W Hex	X Dia.	Work. Press.
2 DW	1/8	1/8	.09	.156	.75	.34	.70	1/2	.375	5,500
3 DW	3/16	1/8	.14	.203	.75	.39	.75	1/2	.438	5,500
4 DW	1/4	1/8	.19	.250	.75	.44	.84	9/16	.500	5,500
4-4 DW	1/4	1/4	.19	.250	.88	.44	.91	11/16	.500	5,600
5 DW	5/16	1/8	.25	.313	.75	.50	.90	9/16	.594	5,500
6 DW	3/8	1/4	.31	.344	.88	.53	1.00	11/16	.625	5,600
6-6 DW	3/8	3/8	.31	.344	.88	.53	1.08	13/16	.625	5,000
6-8 DW	3/8	1/2	.31	.344	1.12	.53	1.19	1	.625	4,500
8-4 DW	1/2	1/4	.44	.406	.88	.59	1.14	7/8	.781	5,600
8 DW	1/2	3/8	.44	.406	.88	.59	1.14	7/8	.781	5,000
8-8 DW	1/2	1/2	.44	.406	1.12	.59	1.29	1-1/16	.781	4,500
10 DW	5/8	1/2	.50	.469	1.12	.66	1.36	1-1/16	.938	4,500
12-4 DW	3/4	1/4	.44	.500	1.12	.69	1.39	1-1/16	1.094	5,600
12 DW	3/4	3/4	.66	.500	1.25	.69	1.58	1-5/16	1.094	3,500
14-12 DW	7/8	3/4	.78	.500	1.25	.69	1.58	1-3/8	1.312	3,500
16-6 DW	1	3/8	.58	.563	1.75	.75	1.84	1-5/8	1.438	4,900
16 DW	1	1	.91	.563	1.50	.75	1.84	1-5/8	1.438	3,900
20 DW	1-1/4	1-1/4	1.06	.625	1.88	.81	2.10	1-7/8	1.750	3,100
24-16 DW	1-1/2	1	1.16	.670	2.08	.86	2.54	2-1/2	2.000	3,700
24 DW	1-1/2	1-1/2	1.31	.670	2.13	.86	2.54	2-1/2	2.000	2,500

*Socket Depth.

NOTE: Other drop sizes available upon request. Dimensions for reference only, subject to change.



Weld-lok® Socket Weld Tube Fittings

Catalog 4280

Male Run Tee, Socket Weld – Male Run Tee

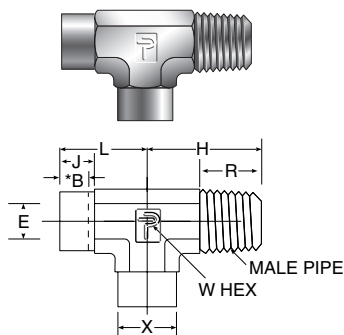

Part Number	Inches										
	Tube O.D.	Male Pipe	E Small Bore	L	H	X Dia.	W Hex	*B	J	R	Work. Press.
2 RW	1/8	1/8	.09	.70	.74	.375	1/2	.156	.34	.38	9,100
3 RW	3/16	1/8	.14	.75	.74	.438	1/2	.203	.39	.38	9,100
4 RW	1/4	1/8	.19	.84	.79	.500	9/16	.250	.44	.38	9,100
5 RW	5/16	1/8	.19	.90	.79	.594	9/16	.313	.50	.38	9,100
6 RW	3/8	1/4	.28	1.08	1.12	.625	13/16	.344	.53	.56	7,500
8 RW	1/2	3/8	.41	1.14	1.12	.781	7/8	.406	.59	.56	7,200
10 RW	5/8	1/2	.50	1.36	1.46	.938	1-1/16	.469	.66	.75	5,800
12 RW	3/4	3/4	.656	1.39	1.46	1.094	1-1/16	.500	.69	.75	6,000
14 RW	7/8	3/4	.719	1.58	1.65	1.312	1-3/8	.500	.69	.75	5,700
16 RW	1	1	.906	1.84	2.03	1.438	1-5/8	.563	.75	.94	4,400
20 RW	1-1/4	1-1/4	1.063	2.10	2.27	1.750	1-7/8	.625	.81	.97	3,500
24 RW	1-1/2	1-1/2	1.313	2.54	2.70	2.000	2-1/2	.670	.86	1.00	2,900
32 RW	2	2	1.813	2.78	2.85	2.625	2-13/16	.781	.97	1.03	2,600

*Socket Depth.

Male Branch Tee, Socket Weld – Male Outlet Tee

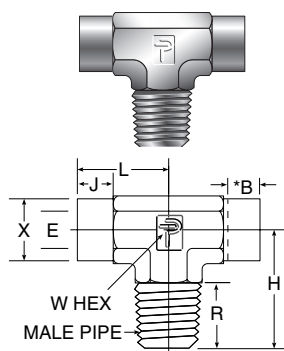

Part Number	Inches										
	Tube O.D.	Male Pipe	E Small Bore	L	H	X Dia.	W Hex	*B	J	R	Work. Press.
2 SW	1/8	1/8	.09	.70	.74	.375	1/2	.156	.34	.38	9,100
3 SW	3/16	1/8	.14	.74	.75	.438	1/2	.203	.39	.38	9,100
4 SW	1/4	1/8	.19	.84	.79	.500	9/16	.250	.44	.38	9,100
5 SW	5/16	1/8	.19	.90	.79	.594	9/16	.313	.50	.38	9,100
6 SW	3/8	1/4	.28	1.08	1.12	.625	13/16	.344	.53	.56	7,500
8 SW	1/2	3/8	.41	1.14	1.12	.781	7/8	.406	.59	.56	7,200
10 SW	5/8	1/2	.50	1.36	1.46	.938	1-1/16	.469	.66	.75	5,800
12 SW	3/4	3/4	.66	1.39	1.46	1.094	1-1/16	.500	.69	.75	6,000
14 SW	7/8	3/4	.72	1.58	1.65	1.312	1-3/8	.500	.69	.75	5,700
16 SW	1	1	.91	1.84	2.03	1.438	1-5/8	.563	.75	.94	4,400
20 SW	1-1/4	1-1/4	1.06	2.10	2.27	1.750	1-7/8	.625	.81	.97	3,500
24 SW	1-1/2	1-1/2	1.31	2.54	2.70	2.000	2-1/2	.670	.86	1.00	2,900
32 SW	2	2	1.81	2.78	2.85	2.625	2-13/16	.781	.97	1.03	2,600

*Socket Depth.

NOTE: Other drop sizes available upon request.
Dimensions for reference only, subject to change.



Weld-lok® Socket Weld Tube Fittings

Adapter, Tube Socket End – Adapter End for Welding into a Female Pipe Size Welding Boss

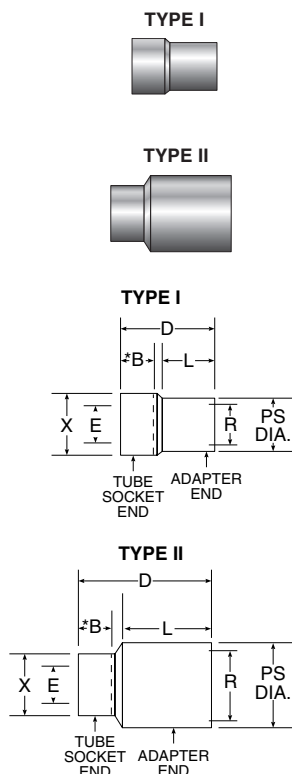

Part Number	Type	Inches									
		Tube O.D.	Pipe Size	Pipe Size O.D.	R Bore	X Dia.	L	D	*B	E Bore	Work. Press.
2-1/8 AW	II	1/8	1/8	.41	.21	.38	.38	.73	.16	.09	8,700
2-1/4 AW	II	1/8	1/4	.54	.30	.38	.56	.92	.16	.09	8,200
3-1/8 AW	I	3/16	1/8	.41	.21	.44	.38	.78	.20	.14	8,700
3-1/2 AW	II	3/16	1/2	.84	.55	.44	.75	1.26	.20	.14	6,400
3-3/4 AW	II	3/16	3/4	1.05	.73	.44	.75	1.32	.20	.14	5,300
4-1/8 AW	I	1/4	1/8	.41	.21	.50	.38	.84	.25	.19	8,700
4-1/4 AW	II	1/4	1/4	.54	.30	.50	.56	1.01	.25	.19	8,200
4-3/8 AW	II	1/4	3/8	.68	.42	.50	.56	1.05	.25	.19	6,900
4-1/2 AW	II	1/4	1/2	.84	.55	.50	.75	1.29	.25	.19	6,400
4-3/4 AW	II	1/4	3/4	1.05	.73	.50	.75	1.35	.25	.19	5,300
4-1 AW	II	1/4	1	1.31	.95	.50	.94	1.61	.25	.19	4,900
5-1/8 AW	I	5/16	1/8	.41	.21	.59	.38	.93	.31	.21	8,700
5-1/2 AW	II	5/16	1/2	.84	.55	.59	.75	1.32	.31	.25	6,400
6-1/4 AW	I	3/8	1/4	.54	.30	.63	.56	1.12	.34	.30	8,100
6-3/8 AW	II	3/8	3/8	.68	.42	.63	.56	1.11	.34	.31	6,900
6-1/2 AW	II	3/8	1/2	.84	.55	.63	.75	1.34	.34	.31	6,400
6-3/4 AW	II	3/8	3/4	1.05	.73	.63	.75	1.40	.34	.31	5,300
6-1 AW	II	3/8	1	1.31	.95	.63	.94	1.67	.34	.31	4,900
6-1 1/2 AW	II	3/8	1-1/2	1.90	1.50	.63	1.03	1.93	.34	.31	3,700
8-1/4 AW	I	1/2	1/4	.54	.30	.78	.56	1.23	.41	.30	8,100
8-3/8 AW	I	1/2	3/8	.68	.42	.78	.56	1.19	.41	.41	6,900
8-1/2 AW	II	1/2	1/2	.84	.55	.78	.75	1.36	.41	.44	6,400
8-3/4 AW	II	1/2	3/4	1.05	.73	.78	.75	1.42	.41	.44	5,300
8-1 AW	II	1/2	1	1.31	.95	.78	.94	1.69	.41	.44	4,900
10-1/2 AW	I	5/8	1/2	.84	.55	.94	.75	1.43	.47	.50	4,900
10-3/4 AW	II	5/8	3/4	1.05	.73	.94	.75	1.44	.47	.50	5,300
10-1 AW	II	5/8	1	1.31	.95	.94	.94	1.70	.47	.50	4,900
12-1/4 AW	I	3/4	1/4	.54	.30	1.09	.56	1.41	.50	.30	6,000
12-3/8 AW	I	3/4	3/8	.68	.42	1.09	.56	1.37	.50	.42	6,000
12-1/2 AW	I	3/4	1/2	.84	.55	1.09	.75	1.51	.50	.55	6,000
12-3/4 AW	I	3/4	3/4	1.05	.73	1.09	.75	1.45	.50	.66	5,300
12-1 AW	II	3/4	1	1.31	.95	1.09	.94	1.69	.50	.66	4,900
16-1/4 AW	I	1	1/4	.54	.30	1.44	.56	1.57	.56	.30	4,900
16-3/8 AW	I	1	3/8	.68	.42	1.44	.56	1.53	.56	.42	4,900
16-1/2 AW	I	1	1/2	.84	.55	1.44	.75	1.67	.56	.55	4,900
16-3/4 AW	I	1	3/4	1.05	.73	1.44	.75	1.61	.56	.73	4,900
16-1 AW	I	1	1	1.31	.95	1.44	.94	1.72	.56	.91	4,900
16-1 1/4 AW	II	1	1-1/4	1.66	1.28	1.44	.94	1.75	.56	.91	4,100
16-1 1/2 AW	II	1	1-1/2	1.90	1.50	1.44	1.03	1.91	.56	.91	3,700
20-1 1/4 AW	II	1-1/4	1-1/4	1.66	1.28	1.75	.94	1.78	.63	1.06	4,100
20-1 1/2 AW	II	1-1/4	1-1/2	1.90	1.50	1.75	1.03	1.89	.63	1.06	3,700
24-1 1/2 AW	I	1-1/2	1-1/2	1.90	1.50	2.00	1.03	1.92	.67	1.31	3,700
32-2 AW	I	2	2	2.38	1.94	2.63	1.06	2.10	.78	1.81	3,200

NOTE: "R" bore diameter will conform to Schedule 80 pipe wall thickness unless otherwise noted.
*Socket Depth.

NOTE: Other drop sizes available upon request.
Dimensions for reference only, subject to change.



Weld-lok® Socket Weld Tube Fittings

Catalog 4280

Adapter, Tube Socket to Pipe Butt Weld

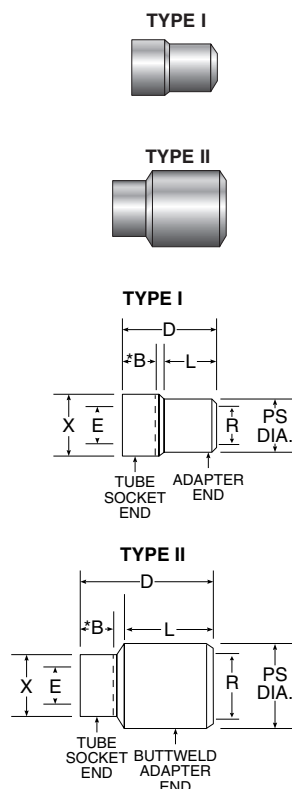

Part Number	Inches										
	Type	Tube O.D.	Pipe Size	Pipe Size O.D.	R Bore	X Dia.	L	D	*B	E Bore	Work. Press.
2-1/8 AW2	II	1/8	1/8	.41	.21	.38	.38	.73	.16	.09	8,700
2-1/4 AW2	II	1/8	1/4	.54	.30	.38	.56	.95	.16	.09	8,200
3-1/8 AW2	I	3/16	1/8	.41	.21	.44	.38	.78	.20	.14	8,700
3-1/2 AW2	II	3/16	1/2	.84	.55	.44	.75	1.26	.20	.14	6,400
3-3/4 AW2	II	3/16	3/4	1.05	.73	.44	.75	1.32	.20	.14	5,300
4-1/8 AW2	I	1/4	1/8	.41	.21	.50	.38	.84	.25	.19	8,700
4-1/4 AW2	II	1/4	1/4	.54	.30	.50	.56	1.01	.25	.19	8,200
4-3/8 AW2	II	1/4	3/8	.68	.42	.50	.56	1.05	.25	.19	6,900
4-1/2 AW2	II	1/4	1/2	.84	.55	.50	.75	1.29	.25	.19	6,400
4-3/4 AW2	II	1/4	3/4	1.05	.73	.50	.75	1.35	.25	.19	5,300
4-1 AW2	II	1/4	1	1.31	.95	.50	.94	1.61	.25	.19	4,900
5-1/8 AW2	I	5/16	1/8	.41	.21	.59	.38	.93	.31	.21	8,700
5-1/2 AW2	II	5/16	1/2	.84	.55	.59	.75	1.32	.31	.25	6,400
6-1/4 AW2	I	3/8	1/4	.54	.30	.63	.56	1.12	.34	.30	8,100
6-3/8 AW2	II	3/8	3/8	.68	.42	.63	.56	1.11	.34	.31	8,900
6-1/2 AW2	II	3/8	1/2	.84	.55	.63	.75	1.34	.34	.31	6,400
6-3/4 AW2	II	3/8	3/4	1.05	.73	.63	.75	1.40	.34	.31	5,300
6-1 AW2	II	3/8	1	1.31	.95	.63	.94	1.67	.34	.31	4,900
6-1 1/2 AW2	II	3/8	1-1/2	1.90	1.50	.63	1.03	1.93	.34	.31	3,700
8-1/4 AW2	I	1/2	1/4	.54	.30	.78	.56	1.23	.41	.30	8,100
8-3/8 AW2	I	1/2	3/8	.68	.42	.78	.56	1.19	.41	.41	6,900
8-1/2 AW2	II	1/2	1/2	.84	.55	.78	.75	1.36	.41	.44	6,400
8-3/4 AW2	II	1/2	3/4	1.05	.73	.78	.75	1.42	.41	.44	5,300
8-1 AW2	II	1/2	1	1.31	.95	.78	.94	1.69	.41	.44	4,900
10-1/2 AW2	I	5/8	1/2	.84	.55	.94	.75	1.43	.47	.50	4,900
10-3/4 AW2	II	5/8	3/4	1.05	.73	.94	.75	1.44	.47	.50	5,300
10-1 AW2	II	5/8	1	1.31	.95	.94	.94	1.70	.47	.50	4,900
12-1/4 AW2	I	3/4	1/4	.54	.30	1.09	.56	1.41	.50	.30	6,000
12-3/8 AW2	I	3/4	3/8	.68	.42	1.09	.56	1.37	.50	.42	6,000
12-1/2 AW2	I	3/4	1/2	.84	.55	1.09	.75	1.51	.50	.55	6,000
12-3/4 AW2	I	3/4	3/4	1.05	.73	1.09	.75	1.45	.50	.66	5,300
12-1 AW2	II	3/4	1	1.31	.95	1.09	.94	1.69	.50	.66	4,900
16-1/4 AW2	I	1	1/4	.54	.30	1.44	.56	1.57	.56	.30	4,900
16-3/8 AW2	I	1	3/8	.68	.42	1.44	.56	1.53	.56	.42	4,900
16-1/2 AW2	I	1	1/2	.84	.55	1.44	.75	1.67	.56	.55	4,900
16-3/4 AW2	I	1	3/4	1.05	.73	1.44	.75	1.61	.56	.73	4,900
16-1 AW2	I	1	1	1.31	.95	1.44	.94	1.72	.56	.91	4,900
16-1 1/4 AW2	II	1	1-1/4	1.66	1.28	1.44	.94	1.75	.56	.91	4,100
16-1 1/2 AW2	II	1	1-1/2	1.90	1.50	1.44	1.03	1.91	.56	.91	3,700
20-1 1/4 AW2	II	1-1/4	1-1/4	1.66	1.28	1.75	.94	1.78	.63	1.06	4,100
20-1 1/2 AW2	II	1-1/4	1-1/2	1.90	1.50	1.75	1.03	1.89	.63	1.06	3,700
24-1 1/2 AW2	I	1-1/2	1-1/2	1.90	1.50	2.00	1.03	1.92	.67	1.31	3,700
32-2 AW2	I	2	2	2.38	1.94	2.63	1.06	2.10	.78	1.81	3,200

NOTE: "R" bore diameter will conform to Schedule 80 pipe wall thickness unless otherwise noted.
*Socket Depth.

NOTE: Other drop sizes available upon request.
Dimensions for reference only, subject to change.



Weld-lok® to Compression

Socket Weld Connector for Fractional Tube For CPI™ to tubing socket weld connection

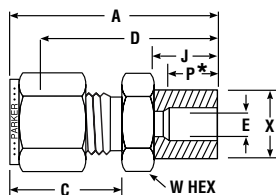
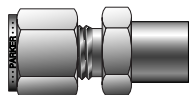

Part Number	Interchanges with	Tube O.D.	Inches							
			A	C	D	J	*P	X	E Bore	W Hex
1-2 ZHBW	100-6-2W	1/16	.99	.43	.84	.34	.16	.38	.09	7/16
1-4 ZHBW	100-6-4W	1/16	1.10	.43	.95	.44	.25	.50	.19	9/16
2-2 ZHBW	200-6-2W	1/8	1.16	.60	.90	.34	.16	.38	.09	7/16
3-3 ZHBW	300-6-3W	3/16	1.25	.64	.98	.39	.20	.44	.13	1/2
4-4 ZHBW	400-6-4W	1/4	1.37	.70	1.07	.44	.25	.50	.19	9/16
4-6 ZHBW	400-6-6W	1/4	1.47	.70	1.18	.53	.34	.63	.31	11/16
4-8 ZHBW	400-6-8W	1/4	1.56	.70	1.27	.59	.41	.78	.44	13/16
4-10 ZHBW	400-6-10W	1/4	1.60	.70	1.31	.66	.47	.94	.50	1
4-12 ZHBW	400-6-12W	1/4	1.75	.70	1.46	.69	.50	1.09	.66	1-1/8
4-16 ZHBW	400-6-16W	1/4	1.88	.70	1.59	.75	.56	1.44	.91	1-1/2
6-2 ZHBW	600-6-2W	3/8	1.35	.76	1.06	.34	.16	.38	.09	5/8
6-6 ZHBW	600-6-6W	3/8	1.53	.76	1.24	.53	.34	.63	.28	11/16
6-8 ZHBW	600-6-8W	3/8	1.63	.76	1.34	.59	.41	.78	.44	13/16
6-12 ZHBW	600-6-12W	3/8	1.81	.76	1.52	.69	.50	1.09	.66	1-1/8
6-16 ZHBW	600-6-16W	3/8	2.02	.76	1.73	.75	.56	1.44	.91	1-5/8
8-2 ZHBW	800-6-2W	1/2	1.49	.87	1.09	.34	.16	.38	.09	13/16
8-4 ZHBW	800-6-4W	1/2	1.58	.87	1.18	.44	.25	.50	.19	13/16
8-6 ZHBW	800-6-6W	1/2	1.67	.87	1.27	.53	.34	.63	.31	13/16
8-8 ZHBW	800-6-8W	1/2	1.74	.87	1.34	.59	.41	.78	.41	13/16
8-12 ZHBW	800-6-12W	1/2	1.92	.87	1.52	.69	.50	1.09	.66	1-1/8
8-16 ZHBW	800-6-16W	1/2	2.13	.87	1.73	.75	.56	1.44	.91	1-5/8
10-10 ZHBW	1010-6-10W	5/8	1.86	.87	1.46	.66	.47	.94	.50	1
10-12 ZHBW	1010-6-12W	5/8	1.92	.87	1.52	.69	.50	1.09	.66	1-1/8
12-4 ZHBW	1210-6-4W	3/4	1.68	.87	1.28	.44	.25	.50	.19	1-1/16
12-8 ZHBW	1210-6-8W	3/4	1.84	.87	1.44	.59	.41	.78	.44	1-1/16
12-12 ZHBW	1210-6-12W	3/4	1.92	.87	1.52	.69	.50	1.09	.63	1-1/8
12-16 ZHBW	1210-6-16W	3/4	2.13	.87	1.73	.75	.56	1.44	.91	1-5/8
16-4 ZHBW	1610-6-4W	1	1.95	1.05	1.46	.44	.25	.50	.19	1-3/8
16-6 ZHBW	1610-6-6W	1	2.05	1.05	1.56	.53	.34	.63	.31	1-3/8
16-12 ZHBW	1610-6-12W	1	2.20	1.05	1.71	.69	.50	1.09	.66	1-3/8
16-16 ZHBW	1610-6-16W	1	2.31	1.05	1.82	.75	.56	1.44	.88	1-5/8
16-20 ZHBW	1610-6-20W	1	2.43	1.05	1.94	.81	.63	1.75	.88	1-7/8
20-16 ZHBW	2000-6-16W	1-1/4	2.81	1.52	1.95	.75	.56	1.44	.91	1-3/4
20-20 ZHBW	2000-6-20W	1-1/4	2.90	1.52	2.04	.81	.63	1.75	1.09	1-7/8
24-12 ZHBW	2400-6-12W	1-1/2	3.15	1.77	2.09	.69	.50	1.09	.66	2-1/8
24-20 ZHBW	2400-6-20W	1-1/2	3.27	1.77	2.21	.81	.63	1.75	1.06	2-1/8
24-24 ZHBW	2400-6-24W	1-1/2	3.32	1.77	2.26	.86	.67	2.00	1.31	2-1/8
32-32 ZHBW	3200-6-32W	2	4.40	2.47	2.93	.97	.78	2.63	1.81	2-3/4

NOTE: A and C dimensions are typical finger-tight.
For A-LOK® tube fitting two-ferrule system, replace "B" (ZHBW) with a "L" (ZHLW)
*Socket Depth

NOTE: Dimensions for reference only, subject to change.



Weld-lok® to Compression

Catalog 4280

Butt Weld Connector for Fractional Pipe For CPI™ to pipe butt weld connection

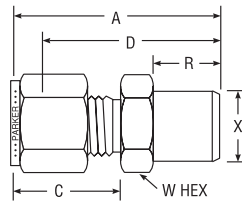
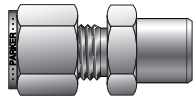

Part Number	Interchanges with	Tube O.D.	Butt Weld Pipe Size	Inches					X Butt Weld O.D.	W Hex
				A	C	D	R			
1-1/8 ZHBW2	00-1-2W	1/16	1/8	1.03	.43	.88	.38	.41	7/16	
2-1/8 ZHBW2	200-1-2W	1/8	1/8	1.20	.60	.94	.38	.41	7/16	
2-1/4 ZHBW2	200-1-4W	1/8	1/4	1.40	.60	1.14	.56	.54	9/16	
2-1/2 ZHBW2	200-1-8W	1/8	1/2	1.67	.60	1.41	.75	.84	7/8	
3-1/8 ZHBW2	300-1-2W	3/16	1/8	1.24	.64	.97	.38	.41	7/16	
4-1/8 ZHBW2	400-1-2W	1/4	1/8	1.29	.70	1.00	.38	.41	1/2	
4-1/4 ZHBW2	400-1-4W	1/4	1/4	1.50	.70	1.20	.56	.54	9/16	
4-3/8 ZHBW2	400-1-6W	1/4	3/8	1.54	.70	1.25	.56	.68	3/4	
4-1/2 ZHBW2	400-1-8W	1/4	1/2	1.76	.70	1.47	.75	.84	7/8	
4-3/4 ZHBW2	400-1-12W	1/4	3/4	1.82	.70	1.53	.75	1.05	1-1/8	
4-1 ZHBW2	400-1-16W	1/4	1	2.10	.70	1.81	.94	1.32	1-3/8	
5-1/8 ZHBW2	500-1-2W	5/16	1/8	1.34	.73	1.05	.38	.41	9/16	
5-1/4 ZHBW2	500-1-4W	5/16	1/4	1.52	.73	1.23	.56	.54	9/16	
5-1/2 ZHBW2	500-1-8W	5/16	1/2	1.79	.73	1.50	.75	.84	7/8	
6-1/4 ZHBW2	600-1-4W	3/8	1/4	1.57	.76	1.28	.56	.54	5/8	
6-3/8 ZHBW2	600-1-6W	3/8	3/8	1.57	.76	1.28	.56	.68	3/4	
6-1/2 ZHBW2	600-1-8W	3/8	1/2	1.82	.76	1.53	.75	.84	7/8	
6-3/4 ZHBW2	600-1-12W	3/8	3/4	1.88	.76	1.59	.75	1.05	1-1/8	
6-1 ZHBW2	600-1-16W	3/8	1	2.17	.76	1.88	.94	1.32	1-3/8	
6-1-1/2 ZHBW2	600-1-24W	3/8	1-1/2	2.39	.76	2.10	1.03	1.90	2	
6-2 ZHBW2	600-1-32W	3/8	2	2.58	.76	2.29	1.06	2.38	2-1/2	
8-1/8 ZHBW2	810-1-2W	1/2	1/8	1.53	.87	1.13	.38	.41	13/16	
8-1/4 ZHBW2	810-1-4W	1/2	1/4	1.71	.87	1.31	.56	.54	13/16	
8-3/8 ZHBW2	810-1-6W	1/2	3/8	1.71	.87	1.31	.56	.68	13/16	
8-1/2 ZHBW2	810-1-8W	1/2	1/2	1.93	.87	1.53	.75	.84	7/8	
8-3/4 ZHBW2	810-1-12W	1/2	3/4	1.99	.87	1.59	.75	1.05	1-1/8	
8-1 ZHBW2	81-1-16W	1/2	1	2.28	.87	1.88	.94	1.32	1-3/8	
8-1-1/2 ZHBW2	810-1-24W	1/2	1-1/2	2.50	.87	2.10	1.03	1.90	2	
10-1/4 ZHBW2	1010-1-4W	5/8	1/4	1.74	.87	1.34	.56	.54	15/16	
10-3/8 ZHBW2	1010-1-6W	5/8	3/8	1.74	.87	1.34	.56	.68	15/16	
10-1/2 ZHBW2	1010-1-8W	5/8	1/2	1.93	.87	1.53	.75	.84	15/16	
10-3/4 ZHBW2	1010-1-12W	5/8	3/4	1.99	.87	1.59	.75	1.05	1-1/8	
12-3/8 ZHBW2	1210-1-6W	3/4	3/8	1.81	.87	1.41	.56	.68	1-1/8	
12-1/2 ZHBW2	1210-1-8W	3/4	1/2	1.99	.87	1.59	.75	.84	1-1/8	
12-3/4 ZHBW2	1210-1-12W	3/4	3/4	1.99	.87	1.59	.75	1.05	1-1/8	
12-1 ZHBW2	1210-1-16W	3/4	1	2.28	.87	1.88	.94	1.32	1-3/8	
16-1/2 ZHBW2	1610-1-8W	1	1/2	2.27	1.05	1.78	.75	.84	1-3/8	
16-3/4 ZHBW2	1610-1-12W	1	3/4	2.27	1.05	1.78	.75	1.05	1-3/8	
16-1 ZHBW2	1610-1-16W	1	1	2.46	1.05	1.97	.94	1.32	1-3/8	
16-1-1/4 ZHBW2	1610-1-20W	1	1-1/4	2.56	1.05	2.07	.94	1.66	1-3/4	
16-1-1/2 ZHBW2	1610-1-24W	1	1-1/2	2.68	1.05	2.19	1.03	1.90	2	
20-1 ZHBW2	2000-1-16W	1-1/4	1	3.06	1.52	2.20	.94	1.32	1-3/4	
20-1-1/4 ZHBW2	2000-1-20W	1-1/4	1-1/4	3.03	1.52	2.17	.94	1.66	1-3/4	
20-1-1/2 ZHBW2	2000-1-24W	1-1/4	1-1/2	3.16	1.52	2.30	1.03	1.90	2	
24-1 ZHBW2	2400-1-16W	1-1/2	1	3.50	1.77	2.44	.94	1.32	2-1/8	
24-1-1/4 ZHBW2	2400-1-20W	1-1/2	1-1/4	3.36	1.77	2.30	.94	1.66	2-1/8	
24-1-1/2 ZHBW2	2400-1-24W	1-1/2	1-1/2	3.50	1.77	2.44	1.03	1.90	2-1/8	
32-2 ZHBW2	3200-1-32W	2	2	4.47	2.47	3.00	1.06	2.38	2-3/4	

NOTE: A and C dimensions are typical finger-tight.
Pipe Butt weld end will conform to Schedule 80 unless otherwise noted.
For A-LOK® tube fitting two-ferrule system, replace "B" (ZHBW2) with a "L" (ZHLW2).

NOTE: Dimensions for reference only, subject to change.



Weld-lok® to Compression

For Fractional Tube For CPI™ to tubing socket weld connection

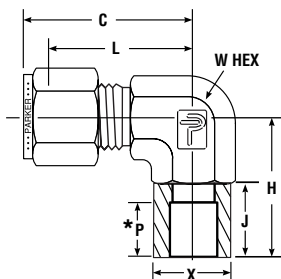
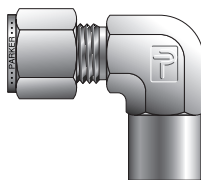

Part Number	Interchanges with	Inches							
		Tube O.D.	C	L	H	J	*P	X Dia.	W Hex
2-2 ZEBW	200-9-2W	1/8	.96	.70	.70	.34	.16	.38	1/2
3-3 ZEBW	300-9-3W	3/16	1.01	.74	.75	.39	.20	.44	1/2
4-4 ZEBW	400-9-4W	1/4	1.07	.78	.84	.44	.25	.50	9/16
6-6 ZEBW	600-9-6W	3/8	1.31	1.02	1.08	.53	.34	.63	3/4
6-12 ZEBW	600-9-12W	3/8	1.46	1.17	1.39	.69	.50	1.09	1-1/16
6-16 ZEBW	600-9-16W	3/8	1.84	1.55	1.84	.75	.56	1.44	1-5/8
8-4 ZEBW	800-9-4W	1/2	1.42	1.02	.99	.44	.25	.50	13/16
8-8 ZEBW	800-9-8W	1/2	1.42	1.02	1.14	.59	.41	.78	13/16
8-10 ZEBW	800-9-10W	1/2	1.57	1.17	1.36	.66	.47	.94	1-1/16
8-12 ZEBW	800-9-12W	1/2	1.57	1.17	1.34	.69	.50	1.09	1-1/16
8-16 ZEBW	800-9-16W	1/2	1.95	1.55	1.84	.75	.56	1.44	1-5/8
10-6 ZEBW	1010-9-6W	5/8	1.50	1.10	1.16	.53	.34	.63	15/16
10-8 ZEBW	1010-9-8W	5/8	1.50	1.10	1.22	.59	.41	.78	15/16
10-10 ZEBW	1010-9-10W	5/8	1.57	1.17	1.36	.66	.47	.94	1-1/16
10-16 ZEBW	1010-9-16W	5/8	1.95	1.55	1.84	.75	.56	1.44	1-5/8
12-12 ZEBW	1210-9-12W	3/4	1.57	1.17	1.39	.69	.50	1.09	1-1/16
14-12 ZEBW	1410-9-12W	7/8	1.76	1.36	1.58	.69	.50	1.09	1-3/8
16-14 ZEBW	1610-9-14W	1	1.94	1.45	1.58	.69	.50	1.31	1-3/8
16-16 ZEBW	1610-9-16W	1	2.14	1.65	1.84	.75	.56	1.44	1-5/8

NOTE: C dimension is typical finger-tight.
For A-LOK® tube fitting two-ferrule system, replace "B" (ZEBW) with a "L" (ZHLW).
*Socket Depth.

Buttweld Elbow for Fractional Pipe For CPI™ to pipe connection

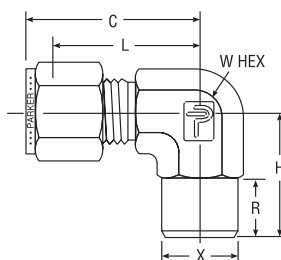
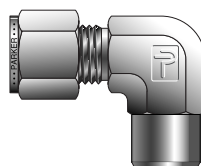

Part Number	Interchanges with	Tube O.D.	Buttweld Pipe Size	Inches				X Buttweld O.D.	W Hex
				C	H	L	R		
2-1/8 ZEBW2	200-2-2W	1/8	1/8	.93	.70	.67	.38	.41	7/16
3-1/8 ZEBW2	300-2-2W	3/16	1/8	1.01	.74	.74	.38	.41	1/2
4-1/8 ZEBW2	400-2-2W	1/4	1/8	1.06	.74	.77	.38	.41	1/2
4-1/4 ZEBW2	400-2-4W	1/4	1/4	1.10	.97	.81	.56	.54	9/16
4-3/4 ZEBW2	400-2-12W	1/4	3/4	1.40	1.45	1.11	.75	1.05	1-1/16
6-1/4 ZEBW2	600-2-4W	3/8	1/4	1.20	1.00	.91	.56	.54	5/8
6-3/8 ZEBW2	600-2-6W	3/8	3/8	1.31	1.11	1.02	.56	.68	13/16
6-1/2 ZEBW2	600-2-8W	3/8	1/2	1.31	1.30	1.02	.75	.84	7/8
6-3/4 ZEBW2	600-2-12W	3/8	3/4	1.46	1.45	1.17	.75	1.05	1-1/16
6-1 ZEBW2	600-2-16W	3/8	1	1.65	1.83	1.36	.94	1.32	1-3/8
8-1/4 ZEBW2	810-2-4W	1/2	1/4	1.42	1.11	1.02	.56	.54	13/16
8-3/8 ZEBW2	810-2-6W	1/2	3/8	1.42	1.11	1.02	.56	.68	13/16
8-1/2 ZEBW2	810-2-8W	1/2	1/2	1.42	1.30	1.02	.75	.84	7/8
8-3/4 ZEBW2	810-2-12W	1/2	3/4	1.57	1.45	1.17	.75	1.05	1-1/16
8-1 ZEBW2	810-W-16W	1/2	1	1.76	1.86	1.36	.94	1.32	1-3/8
10-1/2 ZEBW2	1010-2-8W	5/8	1/2	1.50	1.39	1.10	.75	.84	15/16
12-1/2 ZEBW2	1210-2-8W	3/4	1/2	1.66	1.45	1.26	.75	.84	1-1/16
12-3/4 ZEBW2	1210-2-12W	3/4	3/4	1.57	1.45	1.17	.75	1.05	1-1/16
14-3/4 ZEBW2	1410-2-12W	7/8	3/4	1.76	1.64	1.36	.75	1.05	1-3/8
14-1 ZEBW2	1410-W-16W	7/8	1	1.76	1.83	1.36	.94	1.32	1-3/8
16-1/2 ZEBW2	1610-2-8W	1	1/2	1.94	1.64	1.45	.75	.84	1-3/8
16-3/4 ZEBW2	1610-2-12W	1	3/4	1.94	1.64	1.45	.75	1.05	1-3/8
16-1 ZEBW2	1610-2-16W	1	1	1.94	1.83	1.45	.94	1.32	1-3/8
16-1-1/4 ZEBW2	1610-2-20W	1	1-1/4	2.14	1.88	1.65	.94	1.66	1-5/8
20-1-1/4 ZEBW2	2000-2-20W	1-1/4	1-1/4	2.61	2.02	1.75	.94	1.66	1-5/8
24-1-1/2 ZEBW2	2400-2-24W	1-1/2	1-1/2	3.06	2.38	2.00	1.03	1.90	1-7/8

NOTE: C dimension is typical finger-tight.
Pipe Buttweld end will conform to Schedule 80 unless otherwise noted.
For A-LOK® tube fitting two-ferrule system, replace "B" (ZEBW2) with a "L" (ZELW2).

NOTE: Dimensions for reference only, subject to change.



Offer of Sale

Catalog 4280

Offer of Sale

The items described in this document and other documents and descriptions provided by Parker Hannifin Corporation, its subsidiaries and its authorized distributors ("Seller") are hereby offered for sale at prices to be established by Seller. This offer and its acceptance by any customer ("Buyer") shall be governed by all of the following Terms and Conditions. Buyer's order for any item described in its document, when communicated to Seller verbally, or in writing, shall constitute acceptance of this offer. All goods or work described will be referred to as "Products".

1. Terms and Conditions. Seller's willingness to offer Products, or accept an order for Products, to or from Buyer is expressly conditioned on Buyer's assent to these Terms and Conditions and to the terms and conditions found on-line at www.parker.com/saleterms/. Seller objects to any contrary or additional term or condition of Buyer's order or any other document issued by Buyer.

2. Price Adjustments; Payments. Prices stated on the reverse side or preceding pages of this document are valid for 30 days. After 30 days, Seller may change prices to reflect any increase in its costs resulting from state, federal or local legislation, price increases from its suppliers, or any change in the rate, charge, or classification of any carrier. The prices stated on the reverse or preceding pages of this document do not include any sales, use, or other taxes unless so stated specifically. Unless otherwise specified by Seller, all prices are F.O.B. Seller's facility, and payment is due 30 days from the date of invoice. After 30 days, Buyer shall pay interest on any unpaid invoices at the rate of 1.5% per month or the maximum allowable rate under applicable law.

3. Delivery Dates; Title and Risk; Shipment. All delivery dates are approximate and Seller shall not be responsible for any damages resulting from any delay. Regardless of the manner of shipment, title to any products and risk of loss or damage shall pass to Buyer upon tender to the carrier at Seller's facility (i.e., when it's on the truck, it's yours). Unless otherwise stated, Seller may exercise its judgment in choosing the carrier and means of delivery. No deferment of shipment at Buyers' request beyond the respective dates indicated will be made except on terms that will indemnify, defend and hold Seller harmless against all loss and additional expense. Buyer shall be responsible for any additional shipping charges incurred by Seller due to Buyer's changes in shipping, product specifications or in accordance with Section 13, herein.

4. Warranty. Seller warrants that the Products sold here-under shall be free from defects in material or workmanship for a period of twelve months from the date of delivery to Buyer or 2,000 hours of normal use, whichever occurs first. This warranty is made only to Buyer and does not extend to anyone to whom Products are sold after purchased from Seller. The prices charged for Seller's products are based upon the exclusive limited warranty stated above, and upon the following disclaimer: **DISCLAIMER OF WARRANTY: THIS WARRANTY COMPRISES THE SOLE AND ENTIRE WARRANTY PERTAINING TO PRODUCTS PROVIDED HEREUNDER. SELLER DISCLAIMS ALL OTHER WARRANTIES, EXPRESS AND IMPLIED, INCLUDING MERCHANTABILITY AND FITNESS FOR A PARTICULAR PURPOSE.**

5. Claims; Commencement of Actions. Buyer shall promptly inspect all Products upon delivery. No claims for shortages will be allowed unless reported to the Seller within 10 days of delivery. No other claims against Seller will be allowed unless asserted in writing within 60 days after delivery or, in the case of an alleged breach of warranty, within 30 days after the date within the warranty period on which the defect is or should have been discovered by Buyer. Any action based upon breach of this agreement or upon any other claim arising out of this sale (other than an action by Seller for any amount due to Seller from Buyer) must be commenced within thirteen months from the date of tender of delivery by Seller or, for a cause of action based upon an alleged breach of warranty, within thirteen months from the date within the warranty period on which the defect is or should have been discovered by Buyer.

6. LIMITATION OF LIABILITY. UPON NOTIFICATION, SELLER WILL, AT ITS OPTION, REPAIR OR REPLACE A DEFECTIVE PRODUCT, OR REFUND THE PURCHASE PRICE. IN NO EVENT SHALL SELLER BE LIABLE TO BUYER FOR ANY SPECIAL, INDIRECT, INCIDENTAL OR CONSEQUENTIAL DAMAGES ARISING OUT OF, OR AS THE RESULT OF, THE SALE, DELIVERY, NON-DELIVERY, SERVICING, USE OR LOSS OF USE OF THE PRODUCTS OR ANY PART THEREOF, OR FOR ANY CHARGES OR EXPENSES OF ANY NATURE INCURRED WITHOUT SELLER'S WRITTEN CONSENT, EVEN IF SELLER HAS BEEN NEGLIGENT, WHETHER IN CONTRACT, TORT OR OTHER LEGAL THEORY. IN NO EVENT SHALL SELLER'S LIABILITY UNDER ANY CLAIM MADE BY BUYER EXCEED THE PURCHASE PRICE OF THE PRODUCTS.

7. Contingencies. Seller shall not be liable for any default or delay in performance if caused by circumstances beyond the reasonable control of Seller.

8. User Responsibility. The user, through its own analysis and testing, is solely responsible for making the final selection of the system and Product and assuring that all performance, endurance, maintenance, safety and warning requirements of the application are met. The user must analyze all aspects of the application and follow applicable industry standards and Product information. If Seller provides Product or system options, the user is responsible for determining that such data and specifications are suitable and sufficient for all applications and reasonably foreseeable uses of the Products or systems.

9. Loss to Buyer's Property. Any designs, tools, patterns, materials, drawings, confidential information or equipment furnished by Buyer or any other items which become Buyer's property, may be considered obsolete and may be destroyed by Seller after two consecutive years have elapsed without Buyer placing an order for the items which are manufactured using such property. Seller shall not be responsible for any loss or damage to such property while it is in Seller's possession or control.

10. Special Tooling. A tooling charge may be imposed for any special tooling, including without limitation, dies, fixtures, molds and patterns, acquired to manufacture Products. Such special tooling shall be and remain Seller's property notwithstanding payment of any charges by Buyer. In no event will Buyer acquire any interest in apparatus belonging to Seller which is utilized in the manufacture of the Products, even if such apparatus has been specially converted or adapted for such manufacture and notwithstanding any charges paid by Buyer. Unless otherwise agreed, Seller shall have the right to alter, discard or otherwise dispose of any special tooling or other property in its sole discretion at any time.

11. Buyer's Obligation; Rights of Seller. To secure payment of all sums due or otherwise, Seller shall retain a security interest in the goods delivered and this agreement shall be deemed a Security Agreement under the Uniform Commercial Code. Buyer authorizes Seller as its attorney to execute and file on Buyer's behalf all documents Seller deems necessary to perfect its security interest. Seller shall have a security interest in, and lien upon, any property of Buyer in Seller's possession as security for the payment of any amounts owed to Seller by Buyer.

12. Improper use and Indemnity. Buyer shall indemnify, defend, and hold Seller harmless from any claim, liability, damages, lawsuits, and costs (including attorney fees), whether for personal injury, property damage, patent, trademark or copyright infringement or any other claim, brought by or incurred by Buyer, Buyer's employees, or any other person, arising out of: (a) improper selection, improper application or other misuse of Products purchased by Buyer from Seller; (b) any act or omission, negligent or otherwise, of Buyer; (c) Seller's use of patterns, plans, drawings, or specifications furnished by Buyer to manufacture Product; or (d) Buyer's failure to comply with these terms and conditions. Seller shall not indemnify Buyer under any circumstance except as otherwise provided.

13. Cancellations and Changes. Orders shall not be subject to cancellation or change by Buyer for any reason, except with Seller's written consent and upon terms that will indemnify, defend and hold Seller harmless against all direct, incidental and consequential loss or damage. Seller may change product features, specifications, designs and availability with notice to Buyer.

14. Limitation on Assignment. Buyer may not assign its rights or obligations under this agreement without the prior written consent of Seller.

15. Entire Agreement. This agreement contains the entire agreement between the Buyer and Seller and constitutes the final, complete and exclusive expression of the terms of the agreement. All prior or contemporaneous written or oral agreements or negotiations with respect to the subject matter are herein merged.

16. Waiver and Severability. Failure to enforce any provision of this agreement will not waive that provision nor will any such failure prejudice Seller's right to enforce that provision in the future. Invalidation of any provision of this agreement by legislation or other rule of law shall not invalidate any other provision herein. The remaining provisions of this agreement will remain in full force and effect.

17. Termination. This agreement may be terminated by Seller for any reason and at any time by giving Buyer thirty (30) days written notice of termination. In addition, Seller may by written notice immediately terminate this agreement for the following: (a) Buyer commits a breach of any provision of this agreement (b) the appointment of a trustee, receiver or custodian for all or any part of Buyer's property (c) the filing of a petition for relief in bankruptcy of the other Party on its own behalf, or by a third party (d) an assignment for the benefit of creditors, or (e) the dissolution or liquidation of the Buyer.

18. Governing Law. This agreement and the sale and delivery of all Products hereunder shall be deemed to have taken place in and shall be governed and construed in accordance with the laws of the State of Ohio, as applicable to contracts executed and wholly performed therein and without regard to conflicts of laws principles. Buyer irrevocably agrees and consents to the exclusive jurisdiction and venue of the courts of Cuyahoga County, Ohio with respect to any dispute, controversy or claim arising out of or relating to this agreement. Disputes between the parties shall not be settled by arbitration unless, after a dispute has arisen, both parties expressly agree in writing to arbitrate the dispute.

19. Indemnity for Infringement of Intellectual Property Rights. Seller shall have no liability for infringement of any patents, trademarks, copyrights, trade dress, trade secrets or similar rights except as provided in this Section. Seller will defend and indemnify Buyer against allegations of infringement of U.S. patents, U.S. trademarks, copyrights, trade dress and trade secrets ("Intellectual Property Rights"). Seller will defend at its expense and will pay the cost of any settlement or damages awarded in an action brought against Buyer based on an allegation that a Product sold pursuant to this Agreement infringes the Intellectual Property Rights of a third party. Seller's obligation to defend and indemnify Buyer is contingent on Buyer notifying Seller within ten (10) days after Buyer becomes aware of such allegations of infringement, and Seller having sole control over the defense of any allegations or actions including all negotiations for settlement or compromise. If a Product is subject to a claim that it infringes the Intellectual Property Rights of a third party, Seller may, at its sole expense and option, procure for Buyer the right to continue using the Product, replace or modify the Product so as to make it noninfringing, or offer to accept return of the Product and return the purchase price less a reasonable allowance for depreciation. Notwithstanding the foregoing, Seller shall have no liability for claims of infringement based on information provided by Buyer, or directed to Products delivered hereunder for which the designs are specified in whole or part by Buyer, or infringements resulting from the modification, combination or use in a system of any Product sold hereunder. The foregoing provisions of this Section shall constitute Seller's sole and exclusive liability and Buyer's sole and exclusive remedy for infringement of Intellectual Property Rights.

20. Taxes. Unless otherwise indicated, all prices and charges are exclusive of excise, sales, use, property, occupational or like taxes which may be imposed by any taxing authority upon the manufacture, sale or delivery of Products.

21. Equal Opportunity Clause. For the performance of government contracts and where dollar value of the Products exceed \$10,000, the equal employment opportunity clauses in Executive Order 11246, VEVRRA, and 41 C.F.R. §§ 60-1.4(a), 60-741.5(a), and 60-250.4, are hereby incorporated.

01/09



Parker's Motion & Control Technologies

At Parker, we're guided by a relentless drive to help our customers become more productive and achieve higher levels of profitability by engineering the best systems for their requirements. It means looking at customer applications from many angles to find new ways to create value. Whatever the motion and control technology need, Parker has the experience, breadth of product and global reach to consistently deliver. No company knows more about motion and control technology than Parker. For further info call 1-800-C-Parker.



AEROSPACE

Key Markets

- Aircraft engines
- Business & general aviation
- Commercial transports
- Land-based weapons systems
- Military aircraft
- Missiles & launch vehicles
- Regional transports
- Unmanned aerial vehicles

Key Products

- Flight control systems & components
- Fluid conveyance systems
- Fluid metering delivery & atomization devices
- Fuel systems & components
- Hydraulic systems & components
- Inert nitrogen generating systems
- Pneumatic systems & components
- Wheels & brakes



CLIMATE CONTROL

Key Markets

- Agriculture
- Air conditioning
- Food, beverage & dairy
- Life sciences & medical
- Precision cooling
- Processing
- Transportation

Key Products

- CO₂ controls
- Electronic controllers
- Filter driers
- Hand shut-off valves
- Hose & fittings
- Pressure regulating valves
- Refrigerant distributors
- Safety relief valves
- Solenoid valves
- Thermostatic expansion valves

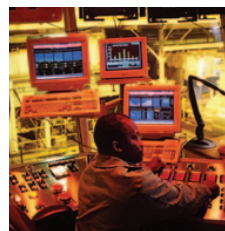

ELECTROMECHANICAL

Key Markets

- Aerospace
- Factory automation
- Life science & medical
- Machine tools
- Packaging machinery
- Paper machinery
- Plastics machinery & converting
- Primary metals
- Semiconductor & electronics
- Textile
- Wire & cable

Key Products

- AC/DC drives & systems
- Electric actuators, gantry robots & slides
- Electrohydraulic actuation systems
- Electromechanical actuation systems
- Human machine interface
- Linear motors
- Stepper motors, servo motors, drives & controls
- Structural extrusions

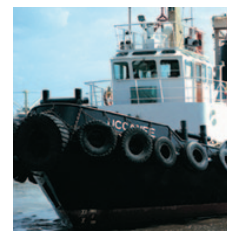

FILTRATION

Key Markets

- Food & beverage
- Industrial machinery
- Life sciences
- Marine
- Mobile equipment
- Oil & gas
- Power generation
- Process
- Transportation

Key Products

- Analytical gas generators
- Compressed air & gas filters
- Condition monitoring
- Engine air, fuel & oil filtration & systems
- Hydraulic, lubrication & coolant filters
- Process, chemical, water & microfiltration filters
- Nitrogen, hydrogen & zero air generators



FLUID & GAS HANDLING

Key Markets

- Aerospace
- Agriculture
- Bulk chemical handling
- Construction machinery
- Food & beverage
- Fuel & gas delivery
- Industrial machinery
- Mobile
- Oil & gas
- Transportation
- Welding

Key Products

- Brass fittings & valves
- Diagnostic equipment
- Fluid conveyance systems
- Industrial hose
- PTFE & PFA hose, tubing & plastic fittings
- Rubber & thermoplastic hose & couplings
- Tube fittings & adapters
- Quick disconnects



HYDRAULICS

Key Markets

- Aerospace
- Aerial lift
- Agriculture
- Construction machinery
- Forestry
- Industrial machinery
- Mining
- Oil & gas
- Power generation & energy
- Truck hydraulics

Key Products

- Diagnostic equipment
- Hydraulic cylinders & accumulators
- Hydraulic motors & pumps
- Hydraulic systems
- Hydraulic valves & controls
- Power take-offs
- Rubber & thermoplastic hose & couplings
- Tube fittings & adapters
- Quick disconnects

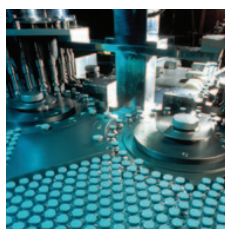

PNEUMATICS

Key Markets

- Aerospace
- Conveyor & material handling
- Factory automation
- Life science & medical
- Machine tools
- Packaging machinery
- Transportation & automotive

Key Products

- Air preparation
- Brass fittings & valves
- Manifolds
- Pneumatic accessories
- Pneumatic actuators & grippers
- Pneumatic valves & controls
- Quick disconnects
- Rotary actuators
- Rubber & thermoplastic hose & couplings
- Structural extrusions
- Thermoplastic tubing & fittings
- Vacuum generators, cups & sensors



PROCESS CONTROL

Key Markets

- Chemical & refining
- Food, beverage & dairy
- Medical & dental
- Microelectronics
- Oil & gas
- Power generation

Key Products

- Analytical sample conditioning products & systems
- Fluoropolymer chemical delivery fittings, valves & pumps
- High purity gas delivery fittings, valves & regulators
- Instrumentation fittings, valves & regulators
- Medium pressure fittings & valves
- Process control manifolds

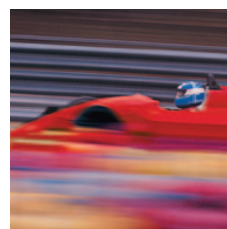

SEALING & SHIELDING

Key Markets

- Aerospace
- Chemical processing
- Consumer
- Energy, oil & gas
- Fluid power
- General industrial
- Information technology
- Life sciences
- Military
- Semiconductor
- Telecommunications
- Transportation

Key Products

- Dynamic seals
- Elastomeric o-rings
- EMI shielding
- Extruded & precision-cut, fabricated elastomeric seals
- Homogeneous & inserted elastomeric shapes
- High temperature metal seals
- Metal & plastic retained composite seals
- Thermal management



ENGINEERING YOUR SUCCESS.

Sales Offices Worldwide

Parker Hannifin Corporation
Instrumentation Products Division
1005 A Cleaner Way
Huntsville, AL 35805
USA
phone 256 881 2040
fax 256 881 5072
www.parker.com/ipdus

Parker Hannifin Corporation
Instrumentation Products Division
2651 Alabama Highway 21 North
Jacksonville, AL 36265-9681
USA
phone 256 435 2130
fax 256 435 7718
www.parker.com/ipdus

Parker Hannifin Corporation
Instrumentation Products Division
6575 Tram Road
Beaumont, TX 77713
USA
phone 409 924 0300
fax 409 924 0301
www.parker.com/ipdus

Parker Hannifin plc
Instrumentation Products Division
Riverside Road
Pottington Business Park
Barnstaple, Devon EX31 1NP
England
phone +44 0 1271 313131
fax +44 0 1271 373636
email ipd@parker.com
www.parker.com/ipd

Catalog 4280 May 2011



Parker Hannifin Corporation
Instrumentation Products Division
1005 A Cleaner Way
Huntsville, AL 35805
phone 256 881 2040
fax 256 881 5072
www.parker.com/ipdus

Your Local Authorized Parker Distributor