



HIGH PERFORMANCE PNEUMATIC VALVES VIKING XTREME SERIES



Table of Contents

Product information.....	3
Working medium, air quality	6
Material specification	7
Flow characteristics.....	8
Order chart Viking Xtreme air pilot & manual valves	9
Pneumatic pilot operated valves	10
Lever 90° to ports operated directional control valves	11
Pneumatic twist operated valves.....	12
Lever in line with ports operated directional control valves	13
Order chart Viking Xtreme Normal Operating	14
Solenoid operated directional control valves.....	15
Order chart Viking Xtreme Valves.....	21
Solenoid operated directional control valves.....	22
Solenoid operators - 15mm.....	25
Order key	26
Technical data	26
Solenoid operators - 22mm	28
Order key	29
Technical data	29
Spare Solenoid	31
Sub-bases & Manifolds	33
P2LAX - 5/2 and 5/3	33
P2LAX / P2LBX - 3/2	36
P2LAX - 5/2 and 5/3	37
P2LBX - 5/2 and 5/3.....	38
Accessories.....	39
Dimensions	40
Cable Plug Dimensions (mm)	64

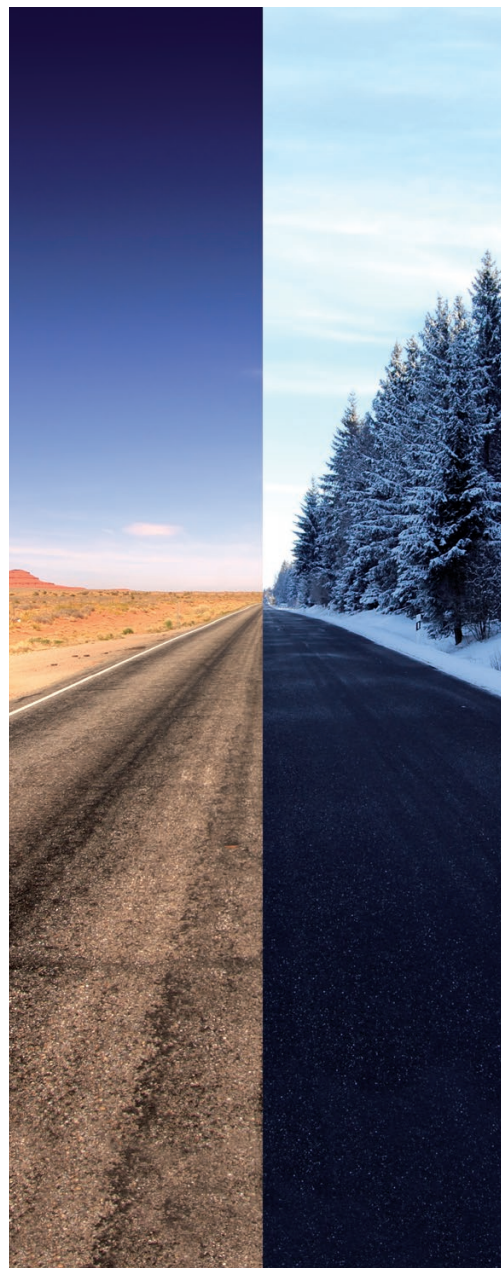

If you have questions about the products contained in this catalog, or their applications, please contact:
Parker Hannifin EMEA Sàrl European Headquarters
parker.com/msgc

PRODUCT INFORMATION

Extreme Environments Demand The Viking Xtreme

The Viking Xtreme valve range is robust, versatile and combines high performance with compact installation dimensions. Large flow capacity, short change-over times and low change-over pressure are important characteristics of this valve range.

The 1/8 & 1/4 sizes are designed to operate with pressures up to 16 bar and the 3/8 & 1/2 sizes up to 12 bar in ambient temperatures -40 °C to + 70 °C when fitted with suitable solenoid operators.

Viking Xtreme range

P2LAX. dimension G1/8

P2LBX. dimension G1/4

P2LCX. dimension G3/8

P2LDX. dimension G1/2

Manually operated range

The complete range includes lever operated versions. They feature a rugged hand lever specifically designed for gloved hands and are available in 3/2, 5/2 and 5/3 functions

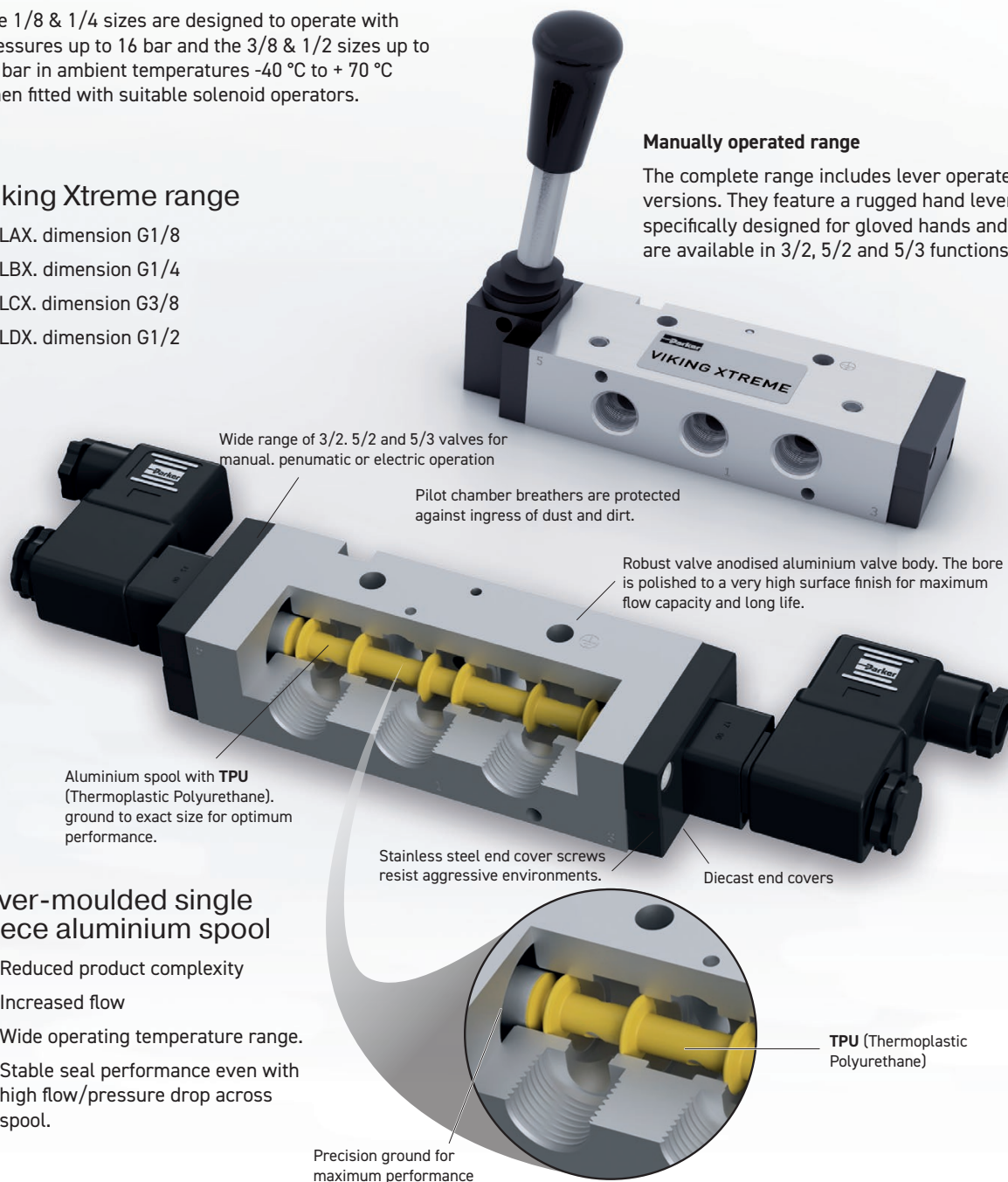

Wide range of 3/2, 5/2 and 5/3 valves for manual, pneumatic or electric operation

Pilot chamber breathers are protected against ingress of dust and dirt.

Robust valve anodised aluminium valve body. The bore is polished to a very high surface finish for maximum flow capacity and long life.

Aluminium spool with TPU (Thermoplastic Polyurethane), ground to exact size for optimum performance.

Stainless steel end cover screws resist aggressive environments.

Diecast end covers

Over-moulded single piece aluminium spool

- Reduced product complexity
- Increased flow
- Wide operating temperature range.
- Stable seal performance even with high flow/pressure drop across spool.

TPU (Thermoplastic Polyurethane)

Precision ground for maximum performance

PRODUCT INFORMATION

Whatever the environment. Push it to the Xtreme

Compact installation dimensions - flexible installation

Compact dimensions direct body porting and integral mounting holes are all features of the Viking Xtreme range. In addition to single valve installation, the Viking valve may be installed on manifolds so that the valves have a common supply and manifolded exhausts.

Mobile applications

The Viking Xtreme valves have a robust body which is machined out of solid aluminium bar and then anodised. Valves have passed aggressive salt spray, and demanding vibration tests and will operate in ambient temperatures of -40 °C to +60 °C. Solenoids are available having wide voltage tolerance for mobile applications.

Maintenance

The Viking Xtreme valve range has been developed from the very successful VGD15 and P2L-A product ranges which have a history of reliable and long service life in demanding and difficult applications. Spares kits are available for the valve and solenoid operators.

Manually operated versions

The range has now been extended to include lever operated versions. The rugged lever actuator has been specifically designed for gloved hands to suit mobile applications in the most arduous of environments.

Available in 3/2, 5/2 and 5/3 functions with either spring return or detented lever and with a choice of mid position function in the 5/3 versions. The lever actuated versions are available across the entire range of port sizes G1/8, G1/4, G3/8 and G1/2.

High reliability

Valves easily comply with the requirements for the component reliability in accordance with EU Machinery

Directive standards EN292-2 and EN983. The valves have passed Shocks & Vibrations tests IEC 61373 : 2010 cat. 1 class B.

The Viking Xtreme valves have few moving parts combined with short spool movement, these features combine to give valves having high reliability and long service life. The valves are designed for use with or without supplementary lubrication.

Rust and corrosion resistant designs.

Viking valves are made entirely of anodized aluminium, for good corrosion resistance. The smooth design, with no dirt-collecting pockets, makes the valve suitable for most environments, including applications with stringent hygiene requirements. The valve has stainless steel fixing screws for the end covers, to withstand aggressive environments.

Insensitive to dirty air

Thanks to large flow passage areas and the large flow diameter of 1.0 in the pilot valves, the P2LA and P2LB can be used in normal industrial or mobile environments without any problems of blocking. However the service life of the valve depends on the cleanliness of the air. Please refer to ISO 8573.

Valves having ATEX approval.

ATEX approved options are available for use in explosive atmospheres. Consult our Technical Sales Department for further information.

Complete range

Manual, pneumatic, electric, 3/2, 5/2 & 5/3; the Viking Xtreme valve range is suitable for a multiple application. For mobile or industrial applications, all functions are available from G1/8 to G1/2 using the same design and technology.



Road

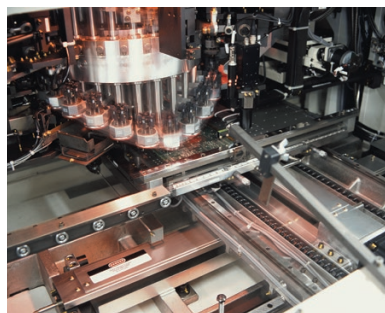

Industrial



Oil & Gas

PDE2569TCUK - Viking Xtreme Series

Electric Motion and Pneumatic Division - Europe



Flexible multiple installation

There is a system of multiple installation plates, intermediate blocks and several variants of connectors for the P2LA.

Several variants of connectors are available, which permit connection from above, beneath, straight from the side or in the middle of a valve block. Using the type L manifold, valve blocks may be constructed for supplying several different pressures.

Manifold bar installation

A manifold bar, with common ducts for ports 1, 3 and 5 gives simple, time saving and easily serviced installation.

Manifold bars are available in several different sizes, with space for between 2 and 14 valves. They are designed for simple handling and are entirely serviced from the front.

Pressure bar installation

A pressure bar for common primary air supply gives a simple, robust, time saving and easily serviced installation. When pressure bars are used, restrictor-silencers can be installed in the exhaust ports of each valve, for individual adjustment of cylinder/air motor speed. Pressure bars are available in a number of different sizes, with space ranging from 2 to 10 valves.



Rail



Agri-Food



Forestry

PDE2569TCUK - Viking Xtreme Series

Electric Motion and Pneumatic Division - Europe

WORKING MEDIUM. AIR QUALITY

Working medium:
Dry. filtered compressed air to ISO 8573-1:2010 [4:2:4].

Recommended air quality for valves

For best possible service life and trouble free operation. ISO 8573-1:2010 [4:2:4] should be used (see table below), which is what a standard compressor with a standard filter gives.

ISO8573-1:2010 CLASS	Solid Particulate				Water		Oil
	Maximum number of particles per m ³			Mass Concentration mg/m ³	Vapour Pressure Dewpoint	Liquid g/m ³	Total Oil (aerosol liquid and vapour)
	0.1 - 0.5 micron	0.5 - 1 micron	1 - 5 micron				mg/m ³
0	As specified by the equipment user or supplier and more stringent than Class 1						
1	≤ 20 000	≤ 400	≤ 10	-	≤ -70 °C	-	0.01
2	≤ 400 000	≤ 6 000	≤ 100	-	≤ -40 °C	-	0.1
3	-	≤ 90 000	≤ 1 000	-	≤ -20 °C	-	1
4	-	-	≤ 10 000	-	≤ +3 °C	-	5
5	-	-	≤ 100 000	-	≤ +7 °C	-	-
6	-	-	-	≤ 5	≤ +10 °C	-	-
7	-	-	-	5 - 10	-	≤ 0.5	-
8	-	-	-	-	-	0.5 - 5	-
9	-	-	-	-	-	5 - 10	-
X	-	-	-	> 10	-	> 10	> 10

Typical cylinders speeds which can be achieved with Viking valves and different tube sizes.

In the chart below you can find the suitable valves, tubes etc. for each cylinder size. If you have a tube length over 2 m. choose one tube size larger than in the chart.

Following data is valid:

Supply pressure: min 7.0 bar

Regulator pressure setting: 6.0 bar

Pipe length between air treatment unit and valve: max 1 m

Pipe length between valve and cylinder: max 2 m

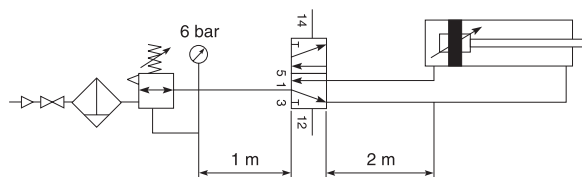

Cylinder bore	<20	20-32	40-50	63	80	100	125	160	200
Cylinder port	M5	G1/8	G1/4	G3/8	G3/8	G1/2	G1/2	G3/4	G3/4
Tubing Ext/Int	4/2.7	6/4	8/6	10/8	10/8	12/9	14/11	18/15	20/18
P2LAX	G1/8	G1/8	G1/8	G1/8	G1/8				
P2LBX	G1/4	G1/4	G1/4	G1/4	G1/4	G1/4			
P2LCX			G3/8	G3/8	G3/8	G3/8	G3/8		
P2LDX				G1/2	G1/2	G1/2	G1/2	G1/2	G1/2

	Cylinder speed < 0.5 m/s		Cylinder speed < 1 m/s
	Oversized		Cylinder speed > 1 m/s

MATERIAL SPECIFICATION

P2LAX

Valve	
Valve body	Anodised aluminium
End covers	Anodised aluminium
Lever housing	Acetal plastic
Spool	Aluminium + TPU (Thermoplastic Polyurethane)
Piston	Acetal plastic/ Anodised aluminium
End cover sealings	Nitrile rubber
End cover screws	Stainless steel
Springs	Dacromet® - processed steel. Stainless steel
Lever	Reinforced polyamid plastic
Panel mounting nut	Polycarbonate plastic
Gaiter	Chloroprene rubber
Mounting screws for solenoid	Stainless steel
Accessories	
Manifold bar	Anodised aluminium
Pressure bar	Anodised aluminium
Multiple manifolds	Anodised aluminium
End and intermediate blocks	Anodised aluminium

P2LBX

Valve	
Valve body	Anodised aluminium
End covers	Anodised aluminium
Lever housing	Anodised aluminium
Spool	Aluminium + TPU (Thermoplastic Polyurethane)
Piston	Acetal plastic/ Anodised aluminium
End cover sealings	Nitrile rubber
End cover screws	Stainless steel
Springs	Dacromet® - processed steel. Stainless steel
Lever	Steel Zinc Plated
Gaiter	Chloroprene rubber
Mounting screws for solenoid	Stainless steel
Panel Washer	Nitrile
Twist Bush	Acetal
Helix Bush	Brass
Pin	Plated Steel
Twist Housing	Anodised Aluminium
Twist Knob	Polyamide 6
Panel mounting ring	Acetal
Lever Housings	Anodised Aluminium
Lever selector	Zinc Diecast
Accessories	
Manifold bar	Anodised aluminium
Pressure bar	Anodised aluminium

P2LCX

Valve	
Valve body	Anodised aluminium
End covers	Anodised aluminium
Spool	Aluminium + TPU (Thermoplastic Polyurethane)
Piston	Acetal plastic/ Anodised aluminium
End cover sealings	Nitrile rubber
End cover screws	Stainless steel
Springs	Dacromet® - processed steel. Stainless steel
Lever	Steel Zinc Plated
Gaiter	Chloroprene rubber
Mounting screws for solenoid	Stainless steel

P2LDX

Valve	
Valve body	Anodised aluminium
End covers	Anodised aluminium
Spool	Aluminium + TPU (Thermoplastic Polyurethane)
Piston	Acetal plastic/ Anodised aluminium
End cover sealings	Nitrile rubber
End cover screws	Stainless steel
Springs	Dacromet® - processed steel. Stainless steel
Lever	Steel Zinc Plated
Gaiter	Chloroprene rubber
Mounting screws for solenoid	Stainless steel

OPERATING PRESSURE AND TEMPERATURE CHARACTERISTICS

Valve Variant	Maximum Operating Pressure	Operating Temperature Range
Manual / Mechanical	Sizes 1/8 & 1/4 : 16 bar Sizes 3/8 & 1/2 : 12 bar	-40°C to +70°C
Pneumatic Remote Pilot		-40°C to +60°C
Electric Pilot - Mobile 22x22 mm operator - Mobile DIN A Coil	10 bar	
Electric Pilot - Mobile 22x22 mm operator - Industrial DIN B Coil		-40°C to +70°C
Electric Pilot - Mobile 22x22 mm operator - Mobile DIN B Coil		-15°C to +60°C
Electric Pilot - Industrial 22x22 mm operator		
Electric Pilot - Mobile 15 mm operator		
Electric Pilot - Industrial 15 mm operator		

FLOW CHARACTERISTICS

Flow capacities in accordance with ISO6358

All pressures = effective pressure

The curves in the diagram below are typical only

P2LAX - G1/8

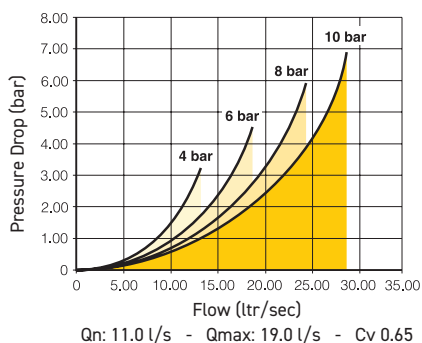

P2LBX - G1/4

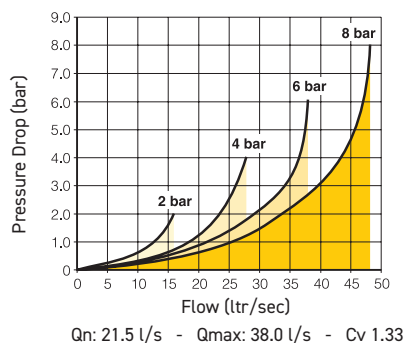

P2LCX - G3/8

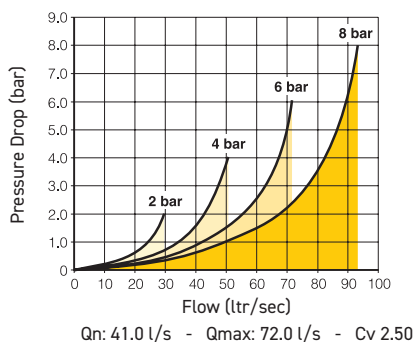

P2LDX - G1/2

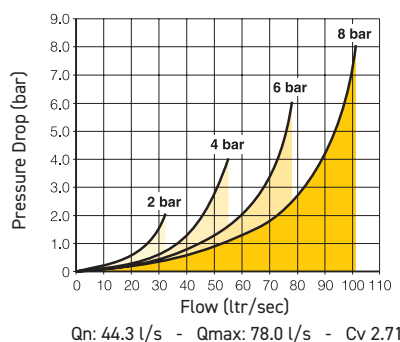

PDE2569TCUK - Viking Xtreme Series

Electric Motion and Pneumatic Division - Europe

AIR PILOT AND MANUAL ACTING VALVE

Xtreme operating pressure / temperature

Valve Variant	Maximum Operating Pressure	Operating Temperature Range
Manual / Mechanical	Sizes 1/8 & 1/4 : 16 bar	-40°C to +70°C
Pneumatic Remote Pilot	Sizes 3/8 & 1/2 : 12 bar	

Ordering Chart

P	2	L	A	X	5	1	1	P	S
---	---	---	---	---	---	---	---	---	---

Valve family	
P2L	Viking inline valve

Size	
A	1/8
B	1/4
C	3/8
D	1/2

Version	
X	Xtreme duty spool

* Xtreme duty spool suitable for max operating pressure 16 bar.
(P2LAX + P2L BX) 12 bar (P2LCX + P2LDX)
Temperature range -400C to +600C

Valve type function		
Manual and pneumatic operated		
3		3/2 valve (Compatible NC / NO)
5		5/2 valve
6		5/3 valve closed centre position
7		5/3 valve pressurised centre
8		5/3 valve vented centre

Port thread	
11	G1/8
12	G1/4
13	G3/8
14	G1/2
91	1/8 NPT
92	1/4 NPT
93	3/8 NPT
94	1/2 NPT
1N *	Namur G1/4
9N *	Namur 1/4 NPT

* Not available in 3/2 version

Pilot main actuator/return	
P	Air signal
S	Spring (return only)
Lever 90° to ports	
V	2 positions
1 **	3 positions self centred
2 **	Held 3 positions
Lever in line with port	
Z ***	2 positions
5 ***	3 positions. self centered
6 ***	Held 3 position
Twist button	
J ***	2 positions
7 ***	Held 3 positions

Shaded part numbers are standard

** Not available in 3/2 version
*** Only Available with port threads G1/4 and 1/4 NPT

PNEUMATIC PILOT OPERATED VALVES

Xtreme operating pressure / temperature







Maximum operating pressure :

- Sizes 1/8 & 1/4 : 16 bar
- Sizes 3/8 & 1/2 : 12 bar

Operating Temperature Range :

- -40°C to +70°C



Symbol	Size	Actuation	Return	Min Operating Pressure (bar)	Changeover time (ms) at 6 bar @20°C actua./return	Weight Kg	Order code
3/2 valves							
	G1/8	Air signal	Air signal	1.5	5/5	0.30	P2LAX311PP
	G1/4			1.5	5/5	0.30	P2LBX312PP
	G3/8			1.5	8/8	0.45	P2LCX313PP
	G1/2			1.5	9/9	0.45	P2LDX314PP
	G1/8	Air signal	Spring	3.2	8/15	0.30	P2LAX311PS
	G1/4			3.5	10/20	0.30	P2LBX312PS
	G3/8			3.5	10/30	0.45	P2LCX313PS
	G1/2			3.5	10/30	0.45	P2LDX314PS
5/2 valves							
	G1/8	Air signal	Air signal	1.5	5/5	0.14	P2LAX511PP
	G1/4			1.5	6/6	0.30	P2LBX512PP
	G3/8			1.5	8/8	0.45	P2LCX513PP
	G1/2			1.5	9/9	0.45	P2LDX514PP
	G1/8	Air signal	Spring	3.2	8/15	0.15	P2LAX511PS
	G1/4			3.5	10/20	0.32	P2LBX512PS
	G3/8			3.5	10/30	0.45	P2LCX513PS
	G1/2			3.5	10/30	0.45	P2LDX514PS
5/3 valves							
	G1/8	Air signal Closed centre position	Air signal Self centring	3.5	10/20	0.15	P2LAX611PP
	G1/4			3.5	12/22	0.33	P2LBX612PP
	G3/8			3.5	15/35	0.50	P2LCX613PP
	G1/2			3.5	15/35	0.50	P2LDX614PP
	G1/8	Air signal Pressurised centre position	Air signal Self centring	3.5	10/20	0.15	P2LAX711PP
	G1/4			3.5	12/22	0.33	P2LBX712PP
	G3/8			3.5	15/35	0.50	P2LCX713PP
	G1/2			3.5	15/35	0.50	P2LDX714PP
	G1/8	Air signal Vented centre position	Air signal Self centring	3.5	10/20	0.15	P2LAX811PP
	G1/4			3.5	12/22	0.33	P2LBX812PP
	G3/8			3.5	15/35	0.50	P2LCX813PP
	G1/2			3.5	15/35	0.50	P2LDX814PP

LEVER 90° TO PORTS OPERATED DIRECTIONAL CONTROL VALVES

Xtreme operating pressure / temperature











Maximum operating pressure :

- Sizes 1/8 & 1/4 : 16 bar
- Sizes 3/8 & 1/2 : 12 bar

Operating Temperature Range :

- -40°C to +70°C



Symbol	Size	Actuation	Return	Changeover angle	Changeover Force	Type	Weight Kg	Order code
3/2 valves								
	G1/8	Lever	Lever	20°	9 N	Std.	0.33	P2LAX311VV
	G1/4			20°	9 N	Std.	0.33	P2LBX312VV
	G3/8			32°	25 N	Std.	0.40	P2LCX313VV
	G1/2			32°	25 N	Std.	0.60	P2LDX314VV
	G1/8	Lever	Spring	20°	10 N	Std.	0.33	P2LAX311VS
	G1/4			20°	10 N	Std.	0.33	P2LBX312VS
	G3/8			32°	15 N	Std.	0.40	P2LCX313VS
	G1/2			32°	15 N	Std.	0.60	P2LDX314VS
5/2 valves								
	G1/8	Lever	Lever	28°	9 N	Std.	0.18	P2LAX511VV
	G1/4			20°	9 N	Std.	0.33	P2LBX512VV
	G3/8			32°	25 N	Std.	0.40	P2LCX513VV
	G1/2			32°	25 N	Std.	0.60	P2LDX514VV
	G1/8	Lever	Spring	28°	10 N	Std.	0.18	P2LAX511VS
	G1/4			20°	10 N	Std.	0.33	P2LBX512VS
	G3/8			32°	15 N	Std.	0.40	P2LCX513VS
	G1/2			32°	15 N	Std.	0.60	P2LDX514VS
5/3 valves								
	G1/8	Lever	Lever	±14°	15 N	Std.	0.18	P2LAX61122
	G1/4	Closed centre position held in three positions		±12°	15 N	Std.	0.33	P2LBX61222
	G3/8			±16°	17 N	Std.	0.71	P2LCX61322
	G1/2			±16°	17 N	Std.	0.73	P2LDX61422
	G1/8	Lever	Lever	±14°	15 N	Std.	0.18	P2LAX71122
	G1/4	Pressure applied centre position held in three positions		±12°	15 N	Std.	0.33	P2LBX71222
	G3/8			±16°	17 N	Std.	0.71	P2LCX71322
	G1/2			±16°	17 N	Std.	0.73	P2LDX71422
	G1/8	Lever	Lever	±14°	15 N	Std.	0.18	P2LAX81122
	G1/4	Exhausted centre position held in three positions		±12°	15 N	Std.	0.33	P2LBX81222
	G3/8			±16°	17 N	Std.	0.71	P2LCX81322
	G1/2			±16°	17 N	Std.	0.73	P2LDX81422
	G1/8	Lever	Lever	±14°	16 N	Std.	0.18	P2LAX61111
	G1/4	Closed centre position Self centring		±12°	16 N	Std.	0.33	P2LBX61211
	G3/8			±16°	30 N	Std.	0.71	P2LCX61311
	G1/2			±16°	30 N	Std.	0.73	P2LDX61411
	G1/8	Lever	Lever	±14°	16 N	Std.	0.18	P2LAX71111
	G1/4	Pressure applied centre position Self centring		±12°	16 N	Std.	0.33	P2LBX71211
	G3/8			±16°	30 N	Std.	0.71	P2LCX71311
	G1/2			±16°	30 N	Std.	0.73	P2LDX71411
	G1/8	Lever	Lever	±14°	16 N	Std.	0.18	P2LAX81111
	G1/4	Exhausted centre position Self centring		±12°	16 N	Std.	0.33	P2LBX81211
	G3/8			±16°	30 N	Std.	0.71	P2LCX81311
	G1/2			±16°	30 N	Std.	0.73	P2LDX81411





PNEUMATIC TWIST OPERATED VALVES

Xtreme operating pressure / temperature

Maximum operating pressure : 16 bar

Operating Temperature Range : -40°C to +70°C



Symbol	Size	Actuation	Return	Changeover Angle	Weight Kg	Order code
3/2 valves						
	G1/4	Twist	Twist	45	0.34	P2LBX312JJ
5/2 valves						
	G1/4	Twist	Twist	45	0.37	P2LBX512JJ
5/3 valves						
	G1/4	Twist	Twist	54	0.41	P2LBX61277
	G1/4	Twist	Twist	54	0.41	P2LBX71277
	G1/4	Twist	Twist	54	0.41	P2LBX81277





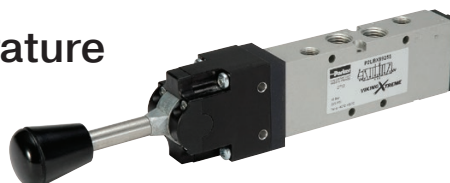

LEVER IN LINE WITH PORTS OPERATED DIRECTIONAL CONTROL VALVES

Xtreme operating pressure / temperature

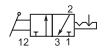
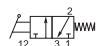
Maximum operating pressure : 16 bar

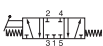
Operating Temperature Range : -40°C to +70°C

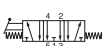

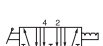
Symbol	Size	Actuation	Return	Changeover Angle	Changeover Force	Type	Weight Kg	Order code
3/2 valves								
	G1/4	Lever	Lever	26°	18 N	Std.	0.42	P2LBX312ZZ
	G1/4	Lever	Spring	26°	18 N	Std.	0.42	P2LBX312ZS
5/2 valves								
	G1/4	Lever	Lever	26°	18 N	Std.	0.45	P2LBX512ZZ
	G1/4	Lever	Spring	26°	18 N	Std.	0.45	P2LBX512ZS
5/3 valves								
	G1/4	Lever	Lever	15° / 15°	24 N	Std.	0.51	P2LBX61255
	G1/4	Lever	Lever	15° / 15°	24 N	Std.	0.51	P2LBX71255
	G1/4	Lever	Lever	15° / 15°	24 N	Std.	0.51	P2LBX81255
	G1/4	Lever	Lever	15° / 15°	18 N	Std.	0.48	P2LBX61266
	G1/4	Lever	Lever	15° / 15°	18 N	Std.	0.48	P2LBX71266
	G1/4	Lever	Lever	15° / 15°	18 N	Std.	0.48	P2LBX81266

PDE2569TCUK - Viking Xtreme Series

Electric Motion and Pneumatic Division - Europe

SOLENOID OPERATED VALVE

Normal operating pressure / temperature

Valve Variant	Maximum Operating Pressure	Operating Temperature Range
Electric Pilot - Industrial 15 mm operator	10 bar	-15°C to +60°C
Electric Pilot - Industrial 22x22 mm operator		-10°C to +50°C

Ordering Chart

P	2	L	A	X	5	1	1	E	S	N	D	D	B	4	9
---	---	---	---	---	---	---	---	---	---	---	---	---	---	---	---

Valve family	
P2L	Viking inline valve

Size	
A	1/8
B	1/4
C	3/8
D	1/2

Version	
X	Xtreme duty spool

Port thread	
11	G1/8
12	G1/4
13	G3/8
14	G1/2
91	1/8 NPT
92	1/4 NPT
93	3/8 NPT
94	1/2 NPT
1N *	Namur G1/4
9N *	Namur 1/4 NPT

* Namur version not available in 3/2 function

Solenoïd pilot type	
N	Industrial Operator

Solenoïd exhaust	
22x22 mm Industrial operator	
D	Vented
N	Captured/tapped M5
15 mm Industrial operator	
X	Vented

Valve type function		
Solenoïd operated with internal supply to solenoïd		
3		3/2 valve
5		5/2 valve
6		5/3 valve closed centre position
7		5/3 valve pressurised centre
8		5/3 valve vented centre
Solenoïd operated with external pilot supply to solenoïds through ports 10 & 12 for 3/2 version and through ports 12 & 14 for 5/2 & 5/3 version		
L		3/2 valve
N		5/2 valve
P		5/3 valve closed centre position
Q		5/3 valve pressurised centre
R		5/3 valve vented centre

Overrides	
A	None
B*	Flush - non locking
C	Flush - locking
D	Extended non-locking
E*	Extended - locking
X	Less 15mm solenoïd

* Only available with enclosure 5

Industrial Voltages			
	AC		DC
	60Hz	50Hz	
40	12		
42	24	22	
45			12
47			12
49			24
53	120	110	
57	240	230	
XX	valve less solenoïd/coil		

Solenoïd enclosure	
15 mm Industrial Operator	
X	Valve less 15 mm solenoïd
5	15 mm. 3 pin Form C/ISO15217 in line with body
22x22 mm Industrial Operator	
B	with 3-pin Industrial Form B solenoïd
N	without solenoïd

Pilot main actuator/return	
E	Solenoïd operated valve
S	Spring (return only)
P	Press (return only)

Shaded part numbers are available from stock Unshaded part numbers are available on request but can be subject to minimum order quantities. Otherwise coil/solenoïd operator can be ordered separately.

SOLENOID OPERATED DIRECTIONAL CONTROL VALVES

Fitted with Industrial 15 mm DIN C solenoid operator(s) 24V DC







INTERNAL supply to operator valve(s) via port 1

Maximum operating pressure : 10 bar

Operating Temperature Range : -15°C to +60°C

Solenoid plug/connector to be ordered separately



Symbol	Size	Actuation	Return	Min Operating Pressure (bar)	Changeover time (ms) at 6 bar @20°C actua./return	Weight Kg	Order code
3/2 valves. internal air. standard temperature							
	G1/8	Electric signal	Electric signal	1.5	10/10	0.42	P2LAX311EENXB549
	G1/4			1.5	10/12	0.42	P2LBX312EENXB549
	G3/8			1.5	17/17	0.53	P2LCX313EENXB549
	G1/2			1.5	17/17	0.53	P2LDX314EENXB549
	G1/8	Electric signal	Spring	3.2	18/40	0.38	P2LAX311ESNXB549
	G1/4			3.5	18/45	0.38	P2LBX312ESNXB549
	G3/8			3.5	25/75	0.50	P2LCX313ESNXB549
	G1/2			3.5	25/75	0.50	P2LDX314ESNXB549
5/2 valves. internal air. standard temperature							
	G1/8	Electric signal	Electric signal	1.5	10/10	0.27	P2LAX511EENXB549
	G1/4			1.5	12/12	0.42	P2LBX512EENXB549
	G3/8			1.5	17/17	0.53	P2LCX513EENXB549
	G1/2			1.5	17/17	0.53	P2LDX514EENXB549
	G1/8	Electric signal	Spring	3.2	15/35	0.22	P2LAX511ESNXB549
	G1/4			3.5	18/45	0.38	P2LBX512ESNXB549
	G3/8			3.5	25/75	0.50	P2LCX513ESNXB549
	G1/2			3.5	25/75	0.50	P2LDX514ESNXB549
5/3 valves. internal air. standard temperature							
	G1/8	Electric signal Closed centre position	Electric signal Self centring	3.5	18/40	0.28	P2LAX611EENXB549
	G1/4			3.5	22/55	0.44	P2LBX612EENXB549
	G3/8			3.5	30/90	0.55	P2LCX613EENXB549
	G1/2			3.5	30/95	0.55	P2LDX614EENXB549
	G1/8	Electric signal Pressurised centre position	Electric signal Self centring	3.5	18/40	0.28	P2LAX711EENXB549
	G1/4			3.5	22/55	0.44	P2LBX712EENXB549
	G3/8			3.5	30/90	0.55	P2LCX713EENXB549
	G1/2			3.5	30/95	0.55	P2LDX714EENXB549
	G1/8	Electric signal Vented centre position	Electric signal Self centring	3.5	18/40	0.28	P2LAX811EENXB549
	G1/4			3.5	22/55	0.44	P2LBX812EENXB549
	G3/8			3.5	30/90	0.55	P2LCX813EENXB549
	G1/2			3.5	30/95	0.55	P2LDX814EENXB549

SOLENOID OPERATED DIRECTIONAL CONTROL VALVES

Fitted with adapter to accept 15 mm DIN C solenoid operator(s)







INTERNAL supply to operator valve(s) via port 1

Maximum operating pressure : 10 bar

Operating Temperature Range : -15°C to +60°C

Solenoid operator(s) and plug(s)/connector(s) to be ordered separately



Symbol	Size	Actuation	Return	Min Operating Pressure (bar)	Changeover time (ms) at 6 bar @20°C actua./return	Weight Kg	Order code
3/2 valves. internal air. standard temperature							
	G1/8	Electric signal	Electric signal	1.5	10/10	0.34	P2LAX311 EENXXX
	G1/4			1.5	10/12	0.34	P2L BX312 EENXXX
	G3/8			1.5	17/17	0.45	P2L CX313 EENXXX
	G1/2			1.5	17/17	0.45	P2L DX314 EENXXX
	G1/8	Electric signal	Spring	3.2	18/40	0.34	P2LAX311 ESNXXX
	G1/4			3.5	18/45	0.34	P2L BX312 ESNXXX
	G3/8			3.5	25/75	0.42	P2L CX313 ESNXXX
	G1/2			3.5	25/75	0.42	P2L DX314 ESNXXX
5/2 valves. internal air. standard temperature							
	G1/8	Electric signal	Electric signal	1.5	10/10	0.19	P2LAX511 EENXXX
	G1/4			1.5	12/12	0.34	P2L BX512 EENXXX
	G3/8			1.5	17/17	0.45	P2L CX513 EENXXX
	G1/2			1.5	17/17	0.45	P2L DX514 EENXXX
	G1/8	Electric signal	Spring	3.2	15/35	0.18	P2LAX511 ESNXXX
	G1/4			3.5	18/45	0.34	P2L BX512 ESNXXX
	G3/8			3.5	25/75	0.42	P2L CX513 ESNXXX
	G1/2			3.5	25/75	0.42	P2L DX514 ESNXXX
5/3 valves. internal air. standard temperature							
	G1/8	Electric signal Closed centre position	Electric signal Self centring	3.5	18/40	0.20	P2LAX611 EENXXX
	G1/4			3.5	22/55	0.36	P2L BX612 EENXXX
	G3/8			3.5	30/90	0.55	P2L CX613 EENXXX
	G1/2			3.5	30/95	0.55	P2L DX614 EENXXX
	G1/8	Electric signal Pressurised centre position	Electric signal Self centring	3.5	18/40	0.20	P2LAX711 EENXXX
	G1/4			3.5	22/55	0.36	P2L BX712 EENXXX
	G3/8			3.5	30/90	0.55	P2L CX713 EENXXX
	G1/2			3.5	30/95	0.55	P2L DX714 EENXXX
	G1/8	Electric signal Vented centre position	Electric signal Self centring	3.5	18/40	0.20	P2LAX811 EENXXX
	G1/4			3.5	22/55	0.36	P2L BX812 EENXXX
	G3/8			3.5	30/90	0.55	P2L CX813 EENXXX
	G1/2			3.5	30/95	0.55	P2L DX814 EENXXX

SOLENOID OPERATED DIRECTIONAL CONTROL VALVES

Fitted with adapter to accept 15 mm DIN C solenoid operator(s)

EXTERNAL supply to operator valve(s)*







Maximum operating pressure : 10 bar

Operating Temperature Range : -15°C to +60°C

Solenoid operator(s) and plug(s)/connector(s) to be ordered separately

*) via ports 10 & 12 for 3/2 version - via port 12 & 14 for 5/2 and 5/3 version



Symbol	Size	Actuation	Return	Min Operating Pressure (bar)	Changeover time (ms) at 6 bar @20°C actua./return	Weight Kg	Order code
3/2 valves. internal air. standard temperature							
	G1/8	Electric signal	Electric signal	1.5	10/10	0.34	P2LAXL11EENXXX
	G1/4			1.5	10/12	0.34	P2LBXL12EENXXX
	G3/8			1.5	17/17	0.45	P2LCXL13EENXXX
	G1/2			1.5	17/17	0.45	P2LDXL14EENXXX
	G1/8	Electric signal	Spring	3.2	18/40	0.34	P2LAXL11ESNXXX
	G1/4			3.5	18/45	0.34	P2LBXL12ESNXXX
	G3/8			3.5	25/75	0.42	P2LCXL13ESNXXX
	G1/2			3.5	25/75	0.42	P2LDXL14ESNXXX
5/2 valves. internal air. standard temperature							
	G1/8	Electric signal	Electric signal	1.5	10/10	0.19	P2LAXN11EENXXX
	G1/4			1.5	12/12	0.34	P2LBXN12EENXXX
	G3/8			1.5	17/17	0.45	P2LCXN13EENXXX
	G1/2			1.5	17/17	0.45	P2LDXN14EENXXX
	G1/8	Electric signal	Spring	3.2	15/35	0.18	P2LAXN11ESNXXX
	G1/4			3.5	18/45	0.34	P2LBXN12ESNXXX
	G3/8			3.5	25/75	0.42	P2LCXN13ESNXXX
	G1/2			3.5	25/75	0.42	P2LDXN14ESNXXX
5/3 valves. internal air. standard temperature							
	G1/8	Electric signal Closed centre position	Electric signal Self centring	3.5	18/40	0.20	P2LAXP11EENXXX
	G1/4			3.5	22/55	0.36	P2LBXP12EENXXX
	G3/8			3.5	30/90	0.55	P2LCXP13EENXXX
	G1/2			3.5	30/95	0.55	P2LDXP14EENXXX
	G1/8	Electric signal Pressurised centre position	Electric signal Self centring	3.5	18/40	0.20	P2LAXQ11EENXXX
	G1/4			3.5	22/55	0.36	P2LBXQ12EENXXX
	G3/8			3.5	30/90	0.55	P2LCXQ13EENXXX
	G1/2			3.5	30/95	0.55	P2LDXQ14EENXXX
	G1/8	Electric signal Vented centre position	Electric signal Self centring	3.5	18/40	0.20	P2LAXR11EENXXX
	G1/4			3.5	22/55	0.36	P2LBXR12EENXXX
	G3/8			3.5	30/90	0.55	P2LCXR13EENXXX
	G1/2			3.5	30/95	0.55	P2LDXR14EENXXX

SOLENOID OPERATED DIRECTIONAL CONTROL VALVES

Fitted with Industrial 22 mm operator and 24 Vdc DIN B solenoid







INTERNAL supply to operator valve(s) via port 1

Maximum operating pressure : 10 bar

Operating Temperature Range : -10°C to +50°C

Solenoid plug/connector to be ordered separately



Symbol	Size	Actuation	Return	Min Operating Pressure (bar)	Changeover time (ms) at 6 bar @20°C actua./return	Weight Kg	Order code
3/2 valves. internal air. standard temperature							
	G1/8	Electric signal	Electric signal	1.5	10/10	0.42	P2LAX311EENDDB49
	G1/4			1.5	10/12	0.42	P2LXB312EENDDB49
	G3/8			1.5	17/17	0.81	P2LCX313EENDDB49
	G1/2			1.5	17/17	0.81	P2LDX314EENDDB49
	G1/8	Electric signal	Spring	3.2	18/40	0.38	P2LAX311ESNDDB49
	G1/4			3.5	18/45	0.38	P2LXB312ESNDDB49
	G3/8			3.5	25/75	0.76	P2LCX313ESNDDB49
	G1/2			3.5	25/75	0.76	P2LDX314ESNDDB49
5/2 valves. internal air. standard temperature							
	G1/8	Electric signal	Electric signal	1.5	10/10	0.27	P2LAX511EENDDB49
	G1/4			1.5	12/12	0.42	P2LXB512EENDDB49
	G3/8			1.5	17/17	0.81	P2LCX513EENDDB49
	G1/2			1.5	17/17	0.81	P2LDX514EENDDB49
	G1/8	Electric signal	Spring	3.2	15/35	0.22	P2LAX511ESNDDB49
	G1/4			3.5	18/45	0.38	P2LXB512ESNDDB49
	G3/8			3.5	27/75	0.76	P2LCX513ESNDDB49
	G1/2			3.5	25/75	0.76	P2LDX514ESNDDB49
5/3 valves. internal air. standard temperature							
	G1/8	Electric signal Closed centre position	Electric signal Self centring	3.5	18/40	0.28	P2LAX611EENDDB49
	G1/4			3.5	22/55	0.44	P2LXB612EENDDB49
	G3/8			3.5	30/90	1.11	P2LCX613EENDDB49
	G1/2			3.5	30/90	1.11	P2LDX614EENDDB49
	G1/8	Electric signal Pressurised centre position	Electric signal Self centring	3.5	18/40	0.28	P2LAX711EENDDB49
	G1/4			3.5	22/45	0.44	P2LXB712EENDDB49
	G3/8			3.5	30/90	1.11	P2LCX713EENDDB49
	G1/2			3.5	30/90	1.11	P2LDX714EENDDB49
	G1/8	Electric signal Vented centre position	Electric signal Self centring	3.5	18/40	0.28	P2LAX811EENDDB49
	G1/4			3.5	22/45	0.44	P2LXB812EENDDB49
	G3/8			3.5	30/90	1.11	P2LCX813EENDDB49
	G1/2			3.5	30/90	1.11	P2LDX814EENDDB49

SOLENOID OPERATED DIRECTIONAL CONTROL VALVES

Supplied with Industrial 22 mm operator - without solenoid







INTERNAL supply to operator valve(s) via port 1

Maximum operating pressure : 10 bar

Operating Temperature Range : -10°C to +50°C

Solenoid and plug/connector to be ordered separately



Symbol	Size	Actuation	Return	Min Operating Pressure (bar)	Changeover time (ms) at 6 bar @20°C actua./return	Weight Kg	Order code
3/2 valves. internal air. standard temperature							
	G1/8	Electric signal	Electric signal	1.5	10/10	0.31	P2LAX311EENDDN
	G1/4			1.5	10/12	0.31	P2LBX312EENDDN
	G3/8			1.5	17/17	0.41	P2LCX313EENDDN
	G1/2			1.5	17/17	0.41	P2LDX314EENDDN
	G1/8	Electric signal	Spring	3.2	18/40	0.31	P2LAX311ESNDDN
	G1/4			3.5	18/45	0.31	P2LBX312ESNDDN
	G3/8			3.5	25/75	0.40	P2LCX313ESNDDN
	G1/2			3.5	25/75	0.40	P2LDX314ESNDDN
5/2 valves. internal air. standard temperature							
	G1/8	Electric signal	Electric signal	1.5	9/9	0.16	P2LAX511EENDDN
	G1/4			1.5	10/10	0.31	P2LBX512EENDDN
	G3/8			1.5	13/13	0.41	P2LCX513EENDDN
	G1/2			1.5	13/13	0.41	P2LDX514EENDDN
	G1/8	Electric signal	Spring	3.2	12/38	0.16	P2LAX511ESNDDN
	G1/4			3.5	14/42	0.31	P2LBX512ESNDDN
	G3/8			3.5	16/60	0.40	P2LCX513ESNDDN
	G1/2			3.5	16/60	0.40	P2LDX514ESNDDN
5/3 valves. internal air. standard temperature							
	G1/8	Electric signal Closed centre position	Electric signal Self centring	3.5	15/40	0.17	P2LAX611EENDDN
	G1/4			3.5	18/50	0.33	P2LBX612EENDDN
	G3/8			3.5	20/65	1.00	P2LCX613EENDDN
	G1/2			3.5	20/70	1.00	P2LDX614EENDDN
	G1/8	Electric signal Pressurised centre position	Electric signal Self centring	3.5	15/40	0.17	P2LAX711EENDDN
	G1/4			3.5	18/50	0.33	P2LBX712EENDDN
	G3/8			3.5	20/65	1.00	P2LCX713EENDDN
	G1/2			3.5	20/70	1.00	P2LDX714EENDDN
	G1/8	Electric signal Vented centre position	Electric signal Self centring	3.5	15/40	0.17	P2LAX811EENDDN
	G1/4			3.5	18/50	0.33	P2LBX812EENDDN
	G3/8			3.5	20/65	1.00	P2LCX813EENDDN
	G1/2			3.5	20/70	1.00	P2LDX814EENDDN

SOLENOID OPERATED DIRECTIONAL CONTROL VALVES

Supplied with Industrial 22 mm operator - without solenoid

EXTERNAL supply to Operator valve(s)*

Maximum operating pressure : 10 bar

Operating Temperature Range : -10°C to +50°C

Solenoid and plug/connector to be ordered separately

*) via ports 10 & 12 for 3/2 version - via port 12 & 14 for 5/2 and 5/3 version



Symbol	Size	Actuation	Return	Min Operating Pressure (bar)	Changeover time (ms) at 6 bar @20°C actua./return	Weight Kg	Order code
3/2 valves. external air. standard temperature							
	G1/8	Electric signal	Electric signal	1.5	10/10	0.31	P2LAXL11EENDDN
	G1/4			1.5	10/12	0.31	P2LBXL12EENDDN
	G3/8			1.5	17/17	0.70	P2LCXL13EENDDN
	G1/2			1.5	17/17	0.70	P2LDXL14EENDDN
	G1/8	Electric signal	Spring	3.2	18/40	0.30	P2LAXL11ESNDDN
	G1/4			3.5	18/45	0.30	P2LBXL12ESNDDN
	G3/8			3.5	25/75	0.70	P2LCXL13ESNDDN
	G1/2			3.5	25/75	0.70	P2LDXL14ESNDDN
5/2 valves. external air. standard temperature							
	G1/8	Electric signal	Electric signal	1.5	9/9	0.16	P2LAXN11EENDDN
	G1/4			1.5	10/10	0.31	P2LBXN12EENDDN
	G3/8			1.5	13/13	0.70	P2LCXN13EENDDN
	G1/2			1.5	13/13	0.70	P2LDXN14EENDDN
	G1/8	Electric signal	Spring	3.2	12/38	0.16	P2LAXN11ESNDDN
	G1/4			3.5	14/42	0.30	P2LBXN12ESNDDN
	G3/8			3.5	16/60	0.70	P2LCXN13ESNDDN
	G1/2			3.5	16/60	0.70	P2LDXN14ESNDDN
5/3 valves. external air. standard temperature							
	G1/8	Electric signal Closed centre position	Electric signal Self centring	3.5	15/40	0.17	P2LAXP11EENDDN
	G1/4			3.5	18/50	0.33	P2LBXP12EENDDN
	G3/8			3.5	20/65	1.00	P2LCXP13EENDDN
	G1/2			3.5	20/70	1.00	P2LDXP14EENDDN
	G1/8	Electric signal Pressurised centre position	Electric signal Self centring	3.5	15/40	0.17	P2LAXQ11EENDDN
	G1/4			3.5	18/50	0.33	P2LBXQ12EENDDN
	G3/8			3.5	20/65	1.00	P2LCXQ13EENDDN
	G1/2			3.5	20/70	1.00	P2LDXQ14EENDDN
	G1/8	Electric signal Vented centre position	Electric signal Self centring	3.5	15/40	0.17	P2LAXR11EENDDN
	G1/4			3.5	18/50	0.33	P2LBXR12EENDDN
	G3/8			3.5	20/65	1.00	P2LCXR13EENDDN
	G1/2			3.5	20/70	1.00	P2LDXR14EENDDN

SOLENOID OPERATED VALVE

Xtreme operating pressure / temperature

Valve Variant	Maximum Operating Pressure	Operating Temperature Range
Electric Pilot - Mobile 22x22 mm operator - Mobile DIN A Coil	Sizes 1/8 & 1/4 : 16 bar Sizes 3/8 & 1/2 : 12 bar	-40°C to +60°C
Electric Pilot - Mobile 22x22 mm operator - Industrial DIN B Coil		
Electric Pilot - Mobile 22x22 mm operator - Mobile DIN B Coil	10 bar	
Electric Pilot - Mobile 22x22 mm operator Metal - Mobile DIN A Coil		
Electric Pilot - Mobile 15 mm operator		

Ordering Chart

P	2	L	A	X	5	1	1	E	S	H	D	D	B	4	9
----------	----------	----------	----------	----------	----------	----------	----------	----------	----------	----------	----------	----------	----------	----------	----------

Valve family	
P2L	Viking inline valve

Size	
A	1/8
B	1/4
C	3/8
D	1/2

Version	
X	Xtreme duty spool

Port thread		
11	G1/8	
12	G1/4	
13	G3/8	
14	G1/2	
91	1/8 NPT	
92	1/4 NPT	
93	3/8 NPT	
94	1/2 NPT	

Operator pilot type	
H ¹	Mobile 22x22 mm operator

¹Other variants mobile 22 mm operator metal (option J) or 15 mm operator (option M) on request

Solenoïd exhaust	
D	Vented
N	Captured/tapped M5

Overrides	
D	Extended non-locking

³ Shaded part numbers are available from stock Unshaded part numbers are available on request but will be subject to minimum order quantities Otherwise order coil and valve separately.

Voltage ³			
	AC		DC
	60Hz	50Hz	
40	12		
42	24	22	
45			12
47*			12
48*			24
49			24
53	120	110	
57	240	230	
72			110
XX	valve less solenoid/coil		

* Mobile voltage see page 51 operating parameters.

Valve type function		
Solenoid operated with internal supply to solenoid		
3		3/2 valve
5		5/2 valve
6		5/3 valve closed centre position
7		5/3 valve pressurised centre
8		5/3 valve vented centre
Solenoid operated with external pilot supply to solenoids through ports 10 & 12 for 3/2 version and through ports 12 & 14 for 5/2 & 5/3 version		
L		3/2 valve
N		5/2 valve
P		5/3 valve closed centre position
Q		5/3 valve pressurised centre
R		5/3 valve vented centre

Pilot main actuator/return	
E	Solenoid operated valve
S	Spring (return only)
P	Press (return only)

Solenoid enclosure	
A	22mm Solenoid pilot & 30mm coil Form A
B	22mm Solenoid pilot & 22mm coil Industrial Form B
N	22mm Solenoid pilot less coil

Shaded part numbers are standard

PDE2569TCUK - Viking Xtreme Series

Electric Motion and Pneumatic Division - Europe

SOLENOID OPERATED DIRECTIONAL CONTROL VALVES

Fitted with Mobile 22 mm operator and industrial 24 Vdc DIN B solenoid

INTERNAL supply to operator valve(s) via port 1







Maximum operating pressure :

- Sizes 1/8 & 1/4 : 16 bar
- Sizes 3/8 & 1/2 : 12 bar

Operating Temperature Range : -40°C to +60°C

Solenoid plug/connector to be ordered separately



Symbol	Size	Actuation	Return	Min Operating Pressure (bar)	Changeover time (ms) at 6 bar @20°C actua./return	Weight Kg	Order code
3/2 valves. internal air. low temperature							
	G1/8	Electric signal	Electric signal Low temp.	1.5	11/11	0.42	P2LAX311EEHDB49
	G1/4			1.5	13/13	0.42	P2LBX312EEHDB49
	G3/8			1.5	18/18	0.48	P2LCX313EEHDB49
	G1/2			1.5	18/18	0.48	P2LDX314EEHDB49
	G1/8	Electric signal	Spring Low temp.	3.2	15/45	0.38	P2LAX311ESHDB49
	G1/4			3.5	25/65	0.38	P2LBX312ESHDB49
	G3/8			3.5	25/85	0.46	P2LCX313ESHDB49
	G1/2			3.5	25/85	0.46	P2LDX314ESHDB49
5/2 valves. internal air. low temperature							
	G1/8	Electric signal	Electric signal Low temp.	1.5	11/11	0.27	P2LAX511EEHDB49
	G1/4			1.5	13/13	0.42	P2LBX512EEHDB49
	G3/8			1.5	18/18	0.48	P2LCX513EEHDB49
	G1/2			1.5	18/18	0.48	P2LDX514EEHDB49
	G1/8	Electric signal	Spring Low temp.	3.2	15/45	0.22	P2LAX511ESHDB49
	G1/4			3.2	20/55	0.38	P2LBX512ESHDB49
	G3/8			3.2	25/85	0.46	P2LCX513ESHDB49
	G1/2			3.2	25/85	0.46	P2LDX514ESHDB49
5/3 valves. internal air. low temperature							
	G1/8	Electric signal Closed centre position	Electric signal Self centring Low temp.	3.5	18/50	0.28	P2LAX611EEHDB49
	G1/4			3.5	25/65	0.45	P2LBX612EEHDB49
	G3/8			3.5	30/90	0.55	P2LCX613EEHDB49
	G1/2			3.5	30/95	0.55	P2LDX614EEHDB49
	G1/8	Electric signal Pressurised centre position	Electric signal Self centring Low temp.	3.5	18/50	0.28	P2LAX711EEHDB49
	G1/4			3.5	25/65	0.45	P2LBX712EEHDB49
	G3/8			3.5	30/90	0.55	P2LCX713EEHDB49
	G1/2			3.5	30/95	0.55	P2LDX714EEHDB49
	G1/8	Electric signal Vented centre position	Electric signal Self centring Low temp.	3.5	18/50	0.28	P2LAX811EEHDB49
	G1/4			3.5	25/65	0.45	P2LBX812EEHDB49
	G3/8			3.5	30/90	0.55	P2LCX813EEHDB49
	G1/2			3.5	30/95	0.55	P2LDX814EEHDB49

SOLENOID OPERATED DIRECTIONAL CONTROL VALVES

Fitted with Mobile 22 mm operator - without solenoid

INTERNAL supply to operator valve(s) via port 1







Maximum operating pressure :

- Sizes 1/8 & 1/4 : 16 bar
- Sizes 3/8 & 1/2 : 12 bar
- All sizes with Mobile DIN B solenoid : 10 bar

Operating Temperature Range : -40°C to +60°C

Solenoid plug/connector to be ordered separately



Symbol	Size	Actuation	Return	Min Operating Pressure (bar)	Changeover time (ms) at 6 bar @20°C actua./return	Weight Kg	Order code
3/2 valves. internal air. low temperature							
	G1/8	Electric signal	Electric signal	1.5	11/11	0.31	P2LAX311EEHDDN
	G1/4			1.5	13/13	0.31	P2LBX312EEHDDN
	G3/8			1.5	18/18	0.41	P2LCX313EEHDDN
	G1/2			1.5	18/18	0.41	P2LDX314EEHDDN
	G1/8	Electric signal	Spring	3.2	15/45	0.31	P2LAX311ESHDDN
	G1/4			3.5	25/65	0.31	P2LBX312ESHDDN
	G3/8			3.5	25/85	0.40	P2LCX313ESHDDN
	G1/2			3.5	25/85	0.40	P2LDX314ESHDDN
5/2 valves. internal air. low temperature							
	G1/8	Electric signal	Electric signal	1.5	11/11	0.16	P2LAX511EEHDDN
	G1/4			1.5	13/13	0.31	P2LBX512EEHDDN
	G3/8			1.5	18/18	0.41	P2LCX513EEHDDN
	G1/2			1.5	18/18	0.41	P2LDX514EEHDDN
	G1/8	Electric signal	Spring	3.2	15/45	0.16	P2LAX511ESHDDN
	G1/4			3.2	20/55	0.31	P2LBX512ESHDDN
	G3/8			3.2	25/85	0.40	P2LCX513ESHDDN
	G1/2			3.2	25/85	0.40	P2LDX514ESHDDN
5/3 valves. internal air. low temperature							
	G1/8	Electric signal Closed centre position	Electric signal Self centring	3.5	18/50	0.17	P2LAX611EEHDDN
	G1/4			3.5	25/65	0.33	P2LBX612EEHDDN
	G3/8			3.5	30/90	0.42	P2LCX613EEHDDN
	G1/2			3.5	30/95	0.42	P2LDX614EEHDDN
	G1/8	Electric signal Pressurised centre position	Electric signal Self centring	3.5	18/50	0.17	P2LAX711EEHDDN
	G1/4			3.5	25/65	0.33	P2LBX712EEHDDN
	G3/8			3.5	30/90	0.42	P2LCX713EEHDDN
	G1/2			3.5	30/95	0.42	P2LDX714EEHDDN
	G1/8	Electric signal Vented centre position	Electric signal Self centring	3.5	18/50	0.17	P2LAX811EEHDDN
	G1/4			3.5	25/65	0.33	P2LBX812EEHDDN
	G3/8			3.5	30/90	0.42	P2LCX813EEHDDN
	G1/2			3.5	30/95	0.42	P2LDX814EEHDDN

SOLENOID OPERATED DIRECTIONAL CONTROL VALVES

Fitted with Mobile 22 mm operator - without solenoid

EXTERNAL supply to operator valve(s)*

Maximum operating pressure :







- Sizes 1/8 & 1/4 : 16 bar
- Sizes 3/8 & 1/2 : 12 bar
- All sizes with Mobile DIN B solenoid : 10 bar

Operating Temperature Range : -40°C to +60°C

Solenoid plug/connector to be ordered separately

*) via ports 10 & 12 for 3/2 version - via port 12 & 14 for 5/2 and 5/3 version



Symbol	Size	Actuation	Return	Min Operating Pressure (bar)	Changeover time (ms) at 6 bar @20°C actua./return	Weight Kg	Order code
3/2 valves. external air standard temperature							
	G1/8	Electric signal	Electric signal	1.5	10/10	0.42	P2LAXL11EEHDDN
	G1/4			1.5	10/12	0.42	P2LBXL12EEHDDN
	G3/8			1.5	17/17	0.81	P2LCXL13EEHDDN
	G1/2			1.5	17/17	0.81	P2LDXL14EEHDDN
	G1/8	Electric signal	Spring	3.2	18/40	0.42	P2LAXL11ESHDDN
	G1/4			3.5	18/45	0.42	P2LBXL12ESHDDN
	G3/8			3.5	25/75	0.76	P2LCXL13ESHDDN
	G1/2			3.5	25/75	0.76	P2LDXL14ESHDDN
5/2 valves. external air to pilot operators							
	G1/8	Electric signal	Electric signal	1.5	11/11	0.27	P2LAXN11EEHDDN
	G1/4			1.5	13/13	0.42	P2LBXN12EEHDDN
	G3/8			1.5	18/18	0.81	P2LCXN13EEHDDN
	G1/2			1.5	18/18	0.81	P2LDXN14EEHDDN
	G1/8	Electric signal	Spring	3.2	15/45	0.22	P2LAXN11ESHDDN
	G1/4			3.2	20/55	0.38	P2LBXN12ESHDDN
	G3/8			3.2	25/85	0.76	P2LCXN13ESHDDN
	G1/2			3.2	25/85	0.76	P2LDXN14ESHDDN
5/3 valves. external air to pilot operators							
	G1/8	Electric signal Closed centre position	Electric signal Self centring	3.5	18/50	0.28	P2LAXP11EEHDDN
	G1/4			3.5	25/65	0.44	P2LBXP12EEHDDN
	G3/8			3.5	30/90	1.11	P2LCXP13EEHDDN
	G1/2			3.5	30/95	1.11	P2LDXP14EEHDDN
	G1/8	Electric signal Pressurised centre position	Electric signal Self centring	3.5	18/50	0.28	P2LAXQ11EEHDDN
	G1/4			3.5	25/65	0.44	P2LBXQ12EEHDDN
	G3/8			3.5	30/90	1.11	P2LCXQ13EEHDDN
	G1/2			3.5	30/95	1.11	P2LDXQ14EEHDDN
	G1/8	Electric signal Vented centre position	Electric signal Self centring	3.5	18/50	0.28	P2LAXR11EEHDDN
	G1/4			3.5	25/65	0.44	P2LBXR12EEHDDN
	G3/8			3.5	30/90	1.11	P2LCXR13EEHDDN
	G1/2			3.5	30/95	1.11	P2LDXR14EEHDDN

SOLENOID OPERATORS - 15 MM

The P2E-•V solenoid operator range

The P2E-•V range of operators are normally closed (NC) 3/2 solenoid valves, with exceedingly compact dimensions in relation to their capacity.

International standard

The port connection pattern complies with a new French CNOMO standard (in process of drafting), with cable plug connections in accordance with Form C/ISO15217.

Compact design

Overall dimensions of the P2E-•V operators are substantially less than those of earlier generations of solenoid operators.

High flow capacity

High flow capacity relative to the electrical operating power as a result of optimised internal flow paths.

Corrosion-resistant design

The valve is made of thermoplastic material and stainless steel, with Viton™ and nitrile rubber seals for excellent corrosion resistance.

Clean lines suitable for food industry applications. P2E-QV

The valve has been designed in conjunction with several machine manufacturers and organisations in the food processing industry, with corrosion-resistant materials and smooth lines being important starting points. The valve and its accessories have been designed so that there are no gaps or crevices in which dirt could collect.

High reliability

Few moving parts result in high reliability, rapid changeover and very long life.

Low power demand

The solenoids have a power demand of 1.2 W at 24 V DC and 1.6 VA at 24 V AC, 115 V AC and 230 V AC.

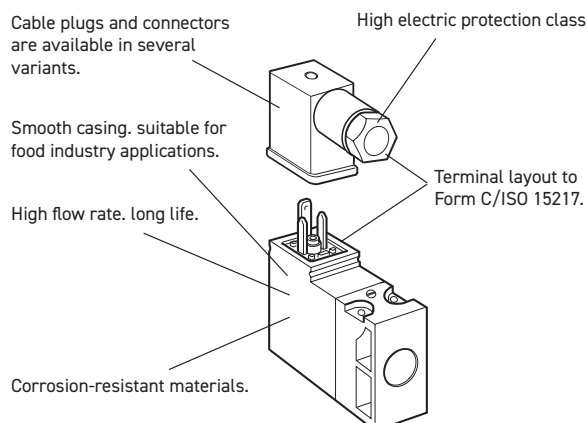

High protection class

The protection class is IP 65 when connected using the cable plug with a moulded cable. When using the standard cable plug for fitting by the user, the protection class is IP65, the bare valve, with Fast-on connectors, has an encapsulation class of IP 20.

Insensitive to dirty air

The use of generously sized flow paths (1.0 mm diameter) means that the valve can be used in normal industrial environments without problems of blocking.

Manual override as option

The operators can be supplied with our without manual override. The manual override device is available as a screwdriver groove or with a control arm, and is either spring return (blue) or lockable (yellow).

SOLENOID OPERATORS - 15 MM

Order key

P	2	E	-	Q	V	3	2	C	3
----------	----------	----------	----------	----------	----------	----------	----------	----------	----------

Valve family	
P2E	Solenoid operator

Subfamily	
	Solenoid operator. 15 mm wide Electric connection acc. to ISO 15217 Form C EI/supply connection on opposite side
K	Standard version
M	Mobile version
Q	Food industry version

Port thread	
1	AC 50 Hz
2	DC
4	AC 50/60 Hz
5	Mobile and wide band only

Voltage	
B	12 V
C	24 V
D	48 V
F	115 V*
J	230 V*
W	37.5 V**
T	72 V**
Y	78 V**
V	96 V**
E	110 V**

Overriders	
0	Without
1	Non locking (blue)
2	Locking (yellow)
3	Extended non locking (blue)
4	Extended locking (yellow)

Valvetype/Function	
3	 3/2 valve, normally closed (NC)

* For standard and food type only
 ** For mobile "M" version only

Technical data

	Standard Version (K)	Food industry version (Q) ¹⁾	Mobile Version (M) ²⁾
Working pressure	0 to 10 bar	0 to 10 bar	0 to 10 bar
Working temperature	-15 °C to +60 °C	-15 °C to +60 °C	-40 °C to +70 °C
Orifice	1.0 mm	1.0 mm	1.0 mm
Flow Qmax	33 NI/min	33 NI/min	22 NI/min
Power. hold	DC 1.2 W / AC 1.6 VA *	DC 1.2 W / AC 1.6 VA *	DC 1.4 W
Power. surge	DC 1.2 W / AC 3.5 VA *	DC 1.2 W / AC 3.5 VA *	DC 1.4 W
Connection time	100%	100%	100%
Voltage tolerance	+10%/-15%	+10%/-15%	+25%/-30%
Electric connection:	Form C/ISO15217		
Port pattern:	To future CNOMO standard		
Protection:	IP 65		
Approval:	Some valves are UL 429 recognised and marked with the following symbol 		
Working media:	All neutral media, such as compressed air, water, hydraulic oil and many gases.		

¹⁾ Design: Completely smooth exterior, suitable for food industry.
²⁾ Mobile standard: According to European standard EN 50 155.
 * Power. hold for 230VAC 2.4VA, Power. surge for 230VAC 5.5VA

Transients

Interrupting the current through the solenoid coil produces momentary voltage peaks which, under unfavourable conditions, can amount to several hundred times the rated operating voltage. Normally, these transients do not cause problems, but to achieve the maximum life of relays in the circuit (and particularly of transistors, thyristors and integrated circuits) it is desirable to provide protection by means of voltage-dependent resistors (varistors). All cable plugs with a yellow LED also incorporate such protection.

Service life

With compressed air at 6 bar, 20 °C and complying with the requirements for compressed air quality as set out in ISO8573-1 norm (class 4 for dry and class 5 for filtered air), the valves should have a life of at least 50 million cycles.

Materials

Operator	
Body, coil casing	Thermoplastic
Internal metal parts	Steel
Screws	Stainless steel
Bottom plug	Thermoplastic
Sealing materials	FPM (Viton™) and nitrile rubber

Cable head	
Sheath	Thermoplastic
Retaining screw	Stainless steel, zinc-plated steel

SOLENOID OPERATORS - 15 MM

Electrical connection EN175301-803 C/ISO15217
(Ex DIN 43650C)

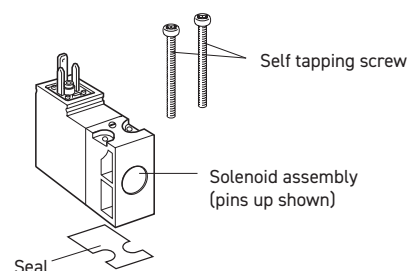

Solenoids 15 mm NC. standard

	Voltage	Weight Kg	Order code Without manual override	Order code Override. blue. non locking flush	Order code Override. yellow. locking flush	Order code Override extended. non locking flush	Order code Override extended. locking flush
	12 V DC	0.038	P2E-KV32B0	P2E-KV32B1	P2E-KV32B2		
24 V DC	0.038	P2E-KV32C0	P2E-KV32C1	P2E-KV32C2	P2E-KV32C3	P2E-KV32C4	
48 V DC	0.038	P2E-KV32D0	P2E-KV32D1	P2E-KV32D2			
24 V AC 50Hz	0.038	P2E-KV31C0	P2E-KV31C1	P2E-KV31C2	P2E-KV31C3	P2E-KV31C4	
48 V AC 50/60Hz	0.038	P2E-KV34D0	P2E-KV34D1	P2E-KV34D2			
115 V AC 50Hz/ 120 V AC 60Hz	0.038	P2E-KV31F0	P2E-KV31F1	P2E-KV31F2			
230 V AC 50Hz/ 240 V AC 60Hz	0.038	P2E-KV31J0	P2E-KV31J1	P2E-KV31J2			

Solenoids 15 mm NC. mobile

(Note! Mounting screws included in basic valve)

	Voltage	Weight Kg	Order code Without manual override	Order code Override. blue. non locking flush	
	12 V DC	0.038	P2E-MV35B0	P2E-MV35B1	
24 V DC	0.038	P2E-MV35C0	P2E-MV35C1		
37.5 V DC	0.038	P2E-MV35W0	P2E-MV35W1		
48 V DC	0.038	P2E-MV35D0	P2E-MV35D1		
72 V DC	0.038	P2E-MV35T0	P2E-MV35T1		
78 V DC	0.038	P2E-MV35Y0	P2E-MV35Y1		
96 V DC	0.038	P2E-MV35V0	P2E-MV35V1		
110 V DC	0.038	P2E-MV35E0	P2E-MV35E1		

Solenoids 15 mm NC. food industry version

(Note! Mounting screws included in basic valve)

	Voltage	Weight Kg	Order code Without manual override	Order code Override. blue. non locking flush	Order code Override. yellow. locking flush	Order code Override extended. non locking flush	Order code Override extended. locking flush
	24 V DC	0.038	P2E-QV32C0	P2E-QV32C1	P2E-QV32C2	P2E-QV32C3	P2E-QV32C4
48 V DC	0.038	P2E-QV32D0	P2E-QV32D1	P2E-QV32D2			
24 V AC 50Hz	0.038	P2E-QV31C0	P2E-QV31C1	P2E-QV31C2	P2E-QV31C3	P2E-QV31C4	
48 V AC 50/60Hz	0.038	P2E-QV34D0	P2E-QV34D1	P2E-QV34D2			
115 V 50Hz/ 120 V 60Hz	0.038	P2E-QV31F0	P2E-QV31F1	P2E-QV31F2	P2E-QV31F3	P2E-QV31F4	
230 V AC 50Hz/ 240 V AC 60Hz	0.038	P2E-QV31J0	P2E-QV31J1	P2E-QV31J2	P2E-QV31J3	P2E-QV31J4	

In accordance with the EU Machine Directive. EN 983. solenoid valves with manual override should have spring-return operating arms for safety.

SOLENOID OPERATORS - 22 MM

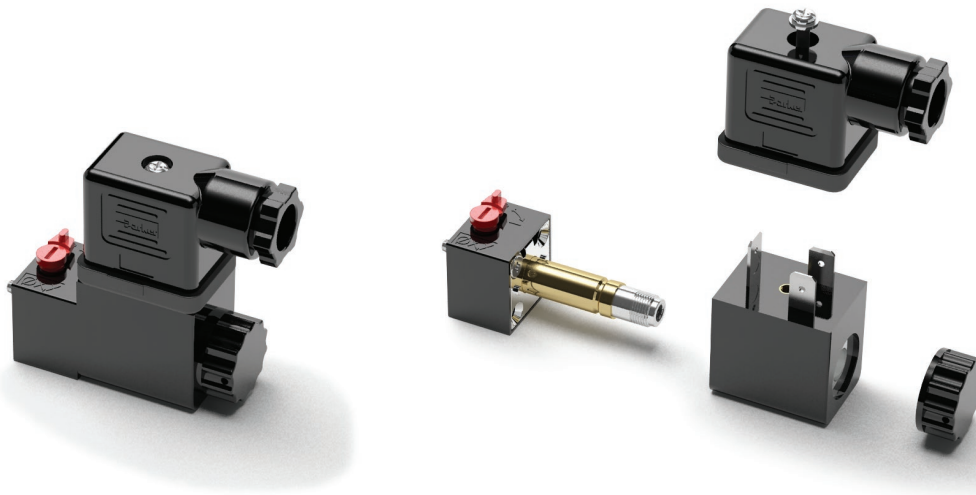

22mm Solenoid pilot options

The P2F P13*4* (NC) 3/2 solenoid pilot operators are designed for piloting pneumatic control valves with compressed air or other inert gases.

The P2F P operator is available for Normal operating pressures up to 10 bar having an outlet orifice 1.3 mm and exhaust orifice 1.5 mm. An alternative operator is also available having an outlet orifice of 0.8 mm and exhaust orifice of 1.0mm for Xtreme maximum operating pressure of 16 bar and wide band voltage tolerances required for mobile applications.

For hard environment, a metal operator (anodised aluminium) with brass manual override is available with a 1.2 mm outlet orifice and 1.3 mm exhaust orifice. Different temperature range is covering inside . outside application.

Corrosion resistant design

The pilot operator body is manufactured in thermoplastic PA 6 material and the core tube brass/stainless steel. The plunger/core is made from stainless steel and the valve seats from FKM.

Solenoid Pilot Exhaust

These operators all exhaust out of the top of the core tube which is tapped M5. The standard solenoid nut fitted to the core tube is the Diffuser nut which allows the exhaust to escape to atmosphere. This nut also minimises ingress of dirt into the valve through this port. The alternative plastic knurled nut can be specified (refer to part number system) if the exhaust air needs to be captured and piped away using the M5 tapped port.

Coils

Coils are wound with enameled copper wire, having temperature index 180 °C with class F insulation (155 °C) and are encapsulated in Thermoplastic resin. When fitted with suitable connector and correct gasket they give protection to IP65.

Mobile Applications

Viking Xtreme valves are tested to +5 g shock and vibration. Solenoid operated valves are designed to operate with wide voltage tolerance bands within the ambient temperature ranges stated in the technical section.

Manual Override options

The pilot operators can be supplied with or without manual override. The standard manual override is the monostable (spring return) extended brass override. Alternatively the bistable (locking) override can be specified as an alternative for the Normal duty 10bar option.

Spares

Solenoid operators are available as spares complete with mounting screws and seals. Coils and connectors should be ordered separately.

SOLENOID OPERATORS - 22 MM

Operators Order Key

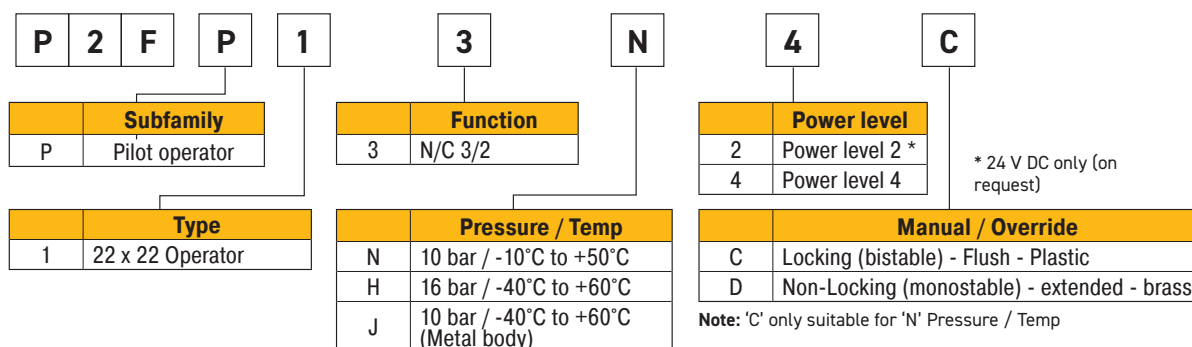

Coils and Operators Technical Data

Operator Features	Industrial Operator P2FP13N4x	Mobile Operator P2FP13H4D		Metal Mobile Operator P2FP13J4x
Working pressure	0 to 10 bar	0 to 16 bar	0 to 10 bar	0 to 16 bar
Ambient temperature	-10 °C to +50 °C	-40 °C to +60 °C		-40 °C to +60 °C
Orifice	1.3/1.5 mm	0.8/1.0 mm		1.2 /1.3 mm
Flow Qn @ 6 bar input 1 bar press drop. 1-2 l/m	55	20		60
Flow Qn @ 6 bar input 1 bar press drop. 2-3 l/m	70	30		70
Shock & Vibration	-	0 to +5 g	0 to +5 g	0 to +5 g
Coil Features	Industrial Coils		Mobile Coils	
Electric connection	Ind Form B		Ind Form B	
Power (DC)	4.8 W		6.0 W	
Power (AC)	8.5 VA		-	
Voltage tolerance (Standard)	+/- 10 %		-	
Voltage tolerance (Mobile)	-		-10 to +30 %	
Duty cycle	100 %		100 %	
Insulation class	F		F	
Protection	IP65		IP65	
Approval	UL coil version available on request			
Working media	All neutral media such as compressed air and inert gases.			

Mobile applications

Solenoid operated Viking Xtreme duty valves for mobile applications are fitted with the P2FP13H4D solenoid pilot operator. It has a 22 mm footprint with 0.8/1.0 mm orifice and will accept 22 mm or 30 mm coil options. The choice of coil option will depend on the voltage tolerance, operating ambient temperature range and maximum operating pressure. Use the technical data in the table above before selecting the coil type required or contact our technical department.

Transients

Interrupting the current through the solenoid coil produces momentary voltage peaks which, under unfavourable conditions, can amount to several hundred times the rated operating voltage. Normally, these transients do not cause problems, but to achieve the maximum life of relays in the circuit (and particularly of transistors, thyristors and

integrated circuits) it is desirable to provide protection by means of voltage-dependent resistors (varistors). All connectors/cable plugs with LED's listed on page 54 include this type of circuit protection.

Materials

Pilot Valve

Body:	Polyamide
Body:	Anodised aluminium for J type
Armature tube:	Brass (Normal) Stainless Steel
	16 bar mobile
Plunger & core:	Corrosion resistant Cr-Ni steel
Seals:	FKM (Viton™)
Screws:	Stainless steel

Coil

Encapsulation material: Thermoplastic

SOLENOID OPERATORS - 22 MM

Solenoids coil standard 22 mm

Voltage	Voltage tolerance	Temperature	Order code Form B	Power	Weight (Kg)	Use with Operator type
12V 50Hz	+/- 10 %	-10 °C / 50 °C	P2FCB440	8.5 VA	0.053	P2FP13N4x
24V 50/60Hz	+/- 10 %	-10 °C / 50 °C	P2FCB442	8.5 VA	0.053	P2FP13N4x
48V 50/60Hz	+/- 10 %	-10 °C / 50 °C	P2FCB449	8.5 VA	0.053	P2FP13N4x
120V/50Hz. 120V/60Hz	+/- 10 %	-10 °C / 50 °C	P2FCB453	8.5 VA	0.053	P2FP13N4x
230V/50Hz. 230V/60Hz	+/- 10 %	-10 °C / 50 °C	P2FCB457	8.5 VA	0.053	P2FP13N4x
12V DC	+/- 10 %	-10 °C / 50 °C	P2FCB445	4.8 W	0.053	P2FP13N4x
24V DC	+/- 10 %	-10 °C / 50 °C	P2FCB449	4.8 W	0.053	P2FP13N4x
48V DC	+/- 10 %	-10 °C / 50 °C	P2FCB451	4.8 W	0.053	P2FP13N4x

For pressure 0 to 10 bar

Solenoids coil 22 mm Xtreme

Voltage	Voltage tolerance	Temperature	Order code Form B	Power	Weight (Kg)	Use with Operator type
12V 50Hz	+/- 10 %	-40 °C / 60 °C	P2FCB440	8.5 VA	0.053	P2FP13H4D
24V 50/60Hz	+/- 10 %	-40 °C / 60 °C	P2FCB442	8.5 VA	0.053	P2FP13H4D
48V 50/60Hz	+/- 10 %	-40 °C / 60 °C	P2FCB449	8.5 VA	0.053	P2FP13H4D
120V/50Hz. 120V/60Hz	+/- 10 %	-40 °C / 60 °C	P2FCB453	8.5 VA	0.053	P2FP13H4D
230V/50Hz. 230V/60Hz	+/- 10 %	-40 °C / 60 °C	P2FCB457	8.5 VA	0.053	P2FP13H4D
12V DC	+/- 10 %	-40 °C / 60 °C	P2FCB445	4.8 W	0.053	P2FP13H4D
24V DC	+/- 10 %	-40 °C / 60 °C	P2FCB449	4.8 W	0.053	P2FP13H4D
48V DC	+/- 10 %	-40 °C / 60 °C	P2FCB451	4.8 W	0.053	P2FP13H4D

For pressure 0 to 16 bar for A+B & 12 bar for C+D

Solenoids coil mobile voltage 22mm

Voltage	Voltage tolerance	Temperature	Order code Form B	Power	Weight (Kg)	Use with Operator type
12V DC	-10 % / +30 %	-40 °C / +60 °C	P2FCA447	6 W	0.053	P2FP13H4D
24V DC	-10 % / +30 %	-40 °C / +60 °C	P2FCA448	6 W	0.053	P2FP13H4D

For pressure 0 to 16 bar for A+B & 12 bar for C+D

Solenoids coil Mobile voltage 30mm

Voltage	Voltage tolerance	Temperature	Order code Form B	Power	Weight (Kg)	Use with Operator type
12V DC	+/- 30 %	-40 °C / +60 °C	P2FCA447	6.2 W	0.09	P2FP13H4D
24V DC	+/- 30 %	-40 °C / +60 °C	P2FCA448	6.8 W	0.09	P2FP13H4D
48V DC	+/- 30 %	-40 °C / +60 °C	P2FCA474	6.6 W	0.09	P2FP13H4D
72V DC	+/- 30 %	-40 °C / +60 °C	P2FCA470	6.0 W	0.09	P2FP13H4D
96V DC	+/- 30 %	-40 °C / +60 °C	P2FCA471	5.7 W	0.09	P2FP13H4D
110V DC	+/- 30 %	-40 °C / +60 °C	P2FCA472	6.2 W	0.09	P2FP13H4D

For pressure 0 to 16 bar for A+B & 12 bar for C+D

Solenoids coil Mobile voltage 30mm

Voltage	Voltage tolerance	Temperature	Order code Form B	Power	Weight (Kg)	Use with Operator type
12V DC	+/- 30 %	-40 °C / +60 °C	P2FCA447	6.2 W	0.09	P2FP13J4x
24V DC	+/- 30 %	-40 °C / +60 °C	P2FCA448	6.8 W	0.09	P2FP13J4x
48V DC	+/- 30 %	-40 °C / +60 °C	P2FCA474	6.6 W	0.09	P2FP13J4x
72V DC	+/- 30 %	-40 °C / +60 °C	P2FCA470	6.0 W	0.09	P2FP13J4x
96V DC	+/- 30 %	-40 °C / +60 °C	P2FCA471	5.7 W	0.09	P2FP13J4x
110V DC	+/- 30 %	-40 °C / +60 °C	P2FCA472	6.2 W	0.09	P2FP13J4x

In accordance with the EU Machine Directive, EN 983, solenoid valves with manual override should have spring-return operating arms for safety.

SPARE SOLENOID

Spare Solenoid Nuts

Valves requiring captured exhaust should be fitted with plastic knurled nut

Order code	
P2FNP	

Valves with vented exhaust are fitted with diffuser plastic nut

Order code	
P2FND	

Spare Solenoid Operators

Solenoid pilot operator 22 mm NC. Normal duty (Max Operating pressure 10 bar. Temp -10 °C to +50 °C)

Order code (with locking bi-stable m/o)	weight Kg	Order code (with Non-locking monostable m/o)	weight Kg
P2FP13N4C	0.05	P2FP13N4D	0.05

Low power pilot operator NC. Normal duty (Max Operating pressure 10 bar. Temp -10 °C to +50 °C)

Order code (with locking bi-stable m/o)	weight Kg	Order code (with Non-locking monostable m/o)	weight Kg
P2FP13N2C	0.05	P2FP13N2D	0.05

Solenoid pilot operator 22 mm NC. Xtreme duty (Max Operating pressure 16 bar. Temp -40 °C to +60 °C)

Order code (with Non-locking monostable m/o)	weight Kg
P2FP13H4D	0.05

Solenoid pilot operator 22 mm NC Mobile metal (Max Operating pressure 10 bar. Temp -40 °C to +60 °C)

Order code (with brass non locking m/o)	weight Kg	Order code (with brass locking m/o)	weight Kg	Order code No manual override	weight Kg
P2FP13J4B	0.04	P2FP13J4C	0.04	P2FP13J4A	0.04



Note.

Solenoid pilot operators are fitted to the Viking valve range. Order the above part numbers for spares. The operators are supplied with mounting screws and interface 'O' rings.

Coils and connectors must be ordered separately.

SOLENOID OPERATORS

Solenoid Connectors / Cable Plugs EN175301-803

	Description	Order code 15 mm Form C/ISO15217	Order code 22 mm Industrial Form B	Order code 30 mm Form A/ISO4400
With large headed screw suitable for mounting in inaccessible or recess position 	Standard IP65	P8C-C		
	24V DC LED and protection IP65	P8C-C26C		
	110V AC LED and protection IP65	P8C-C21E		
With standard screw 	Standard IP65 without flying lead	P8C-D	3EV10V10	3EV290V10
	With LED and protection 24V AC/DC	P8C-D26C	3EV10V20-24	3EV290V20-24
	With LED and protection 110V AC/DC	P8C-D21E	3EV10V20-110	3EV290V20-110
	With LED and protection 230V AC		3EV10V20-230	
With cable 	Standard with 2 m cable IP65	P8L-C2		
	Standard with 5 m cable IP65	P8L-C5		
	24V AC/DC. 2 m cable LED and protection IP65	P8L-C226C		
	24V AC/DC. 5 m cable LED and protection IP65	P8L-C526C	3EV10V20-24L5	3EV290V20-24L5
	24V AC/DC. 10 m cable LED and protection IP65	P8L-CA26C		
	110V AC/DC. 2 m cable LED and protection IP65	P8L-C221E		
	110V AC/DC. 5 m cable LED and protection IP65	P8L-C521E	3EV10V20-110L5	
	230V AC. 5 m cable LED and protection IP65		3EV10V20-230L5	

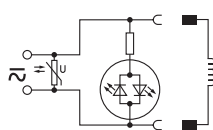
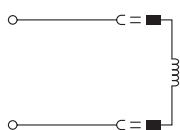

P8C-C
P8C-D
P8L-C2
P8L-C5
3EV10V10
3EV290V10

P8C-D26C	P8L-C226C
P8C-D21E	P8L-C526C
P8C-C26C	P8L-CA26C
P8C-C21E	P8L-C221E
	P8L-C521E
3EV10V20-24	3EV10V20-24L5
3EV10V20-110	3EV10V20-110L5
3EV10V20-230	3EV10V20-230L5

SUB-BASES & MANIFOLDS

P2LAX - 5/2 and 5/3

P2LAX. flexible manifold assembly

A practical system solution with the aid of connection pieces. The manifolds can easily be assembled from the top to form a compact and stable block. The block can then be installed in cabinets or directly on the machine frame as shown in the example in the bottom of this page.

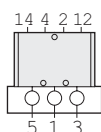

Valve:
with cylinder ports 2 and 4 and signal ports 12 and 14 facing upwards. enabling easily access to connection ports. All ports are G1/8 threaded to simplify choice of connectors.

Manifold:
with common channels for ports 1, 3 and 5.

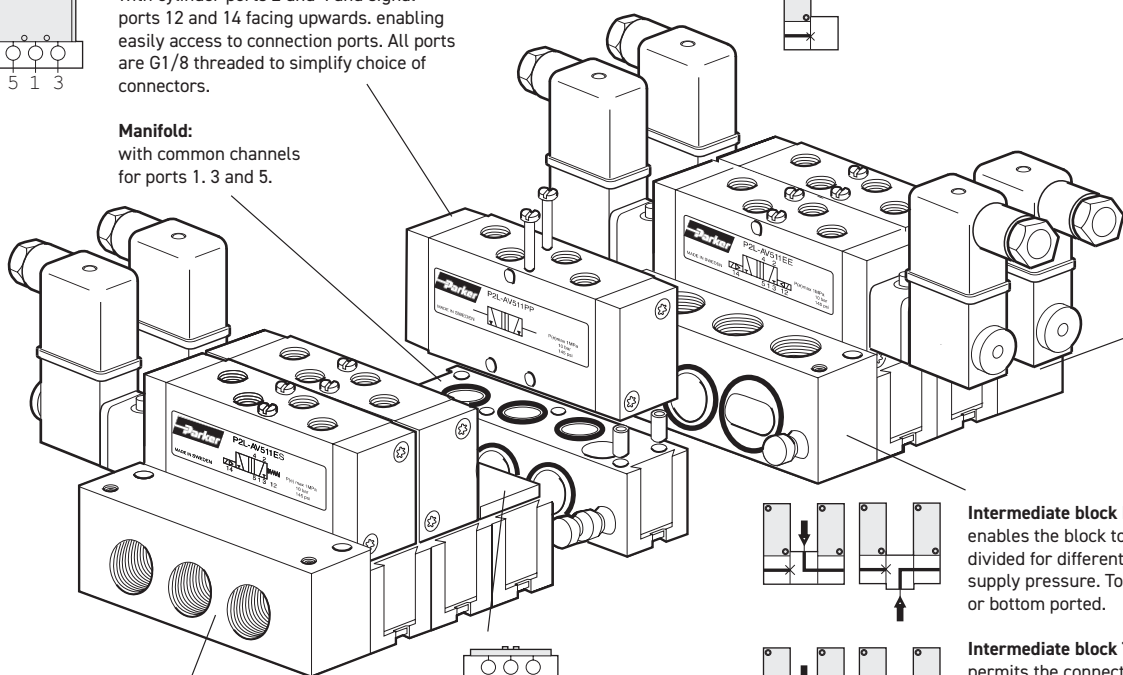

Connection block S:
straight connection block with a side ports for common air supply and exhaust.

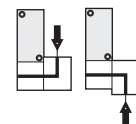

Connection block L:
angled connection block for top or bottom ported.



End cover



Blanking plate:
To incorporate spare positions.

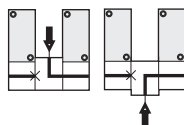

Intermediate block L:
enables the block to be divided for different supply pressure. Top or bottom ported.

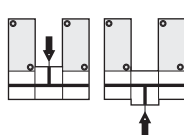

Intermediate block T:
permits the connection of air between two manifolds. Top or bottom ports.



Connection block S:
straight connection block with a side ports for common air supply and exhaust.

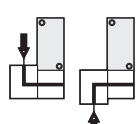

Connection block L:
angled connection block for top or bottom ported.

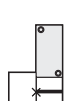

End cover

Various mounting options

1. With M6 screws for installation from the connection blocks.







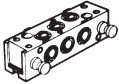
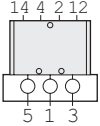
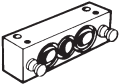
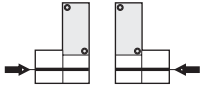

2. With M5 screws from the top in any manifold

3. With a self-tapping M6 screw from below to any manifold.

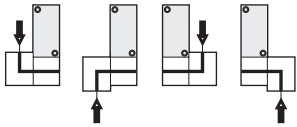
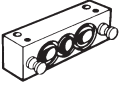
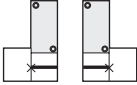
Assemble with the indication line (10 mm long line) on the same side on all blocks.

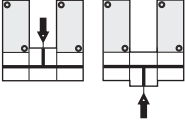
SUB-BASES & MANIFOLDS

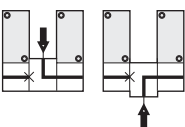
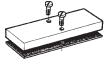
P2LAX - 5/2 and 5/3

Accessories P2LA	Connection alternatives	Type	Weight Kg	Order code
		Multiple manifold including seals. mounting screws. and guiding pins.	0.11	9121658060
		Connection block S including seals. mounting screws. and guiding pins. G1/4	0.15	9121658064
		Connection block L including seals. mounting screws. and guiding pins. G1/4	0.15	9121658061
		End cover including seals. mounting screws. and guiding pins.	0.16	9121658066
		Intermediate block T including seals. mounting screws. and guiding pins. G1/4	0.17	9121658062
		Intermediate block L including seals. mounting screws. and guiding pins. G1/4	0.17	9121658065
		Blanking plate including seals. mounting screws.	0.05	9121658063

SUB-BASES & MANIFOLDS

P2LAX - 5/2 and 5/3

Dimensions

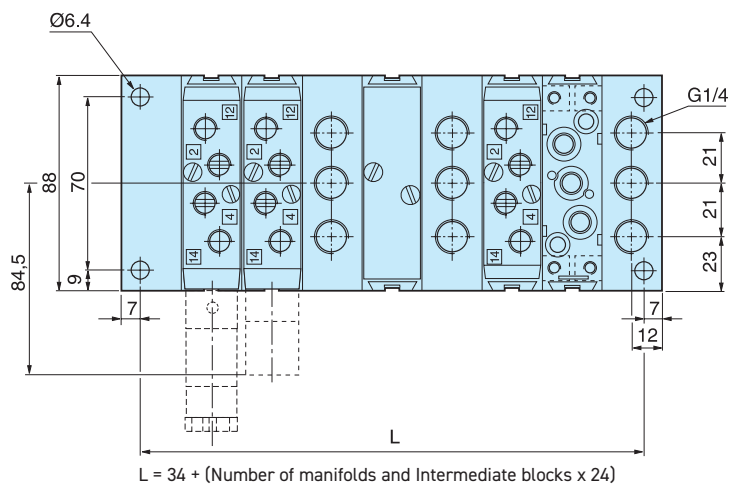

Connection block L and intermediate blocks

L and T can be turned so that connection can be made from above or below.

Multiple manifolds must be fitted with the top indication line (a 10 mm long line) facing the same side on all manifolds.

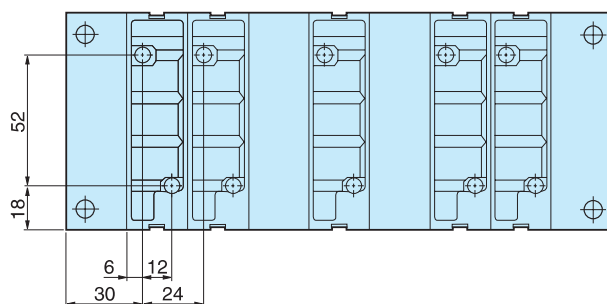
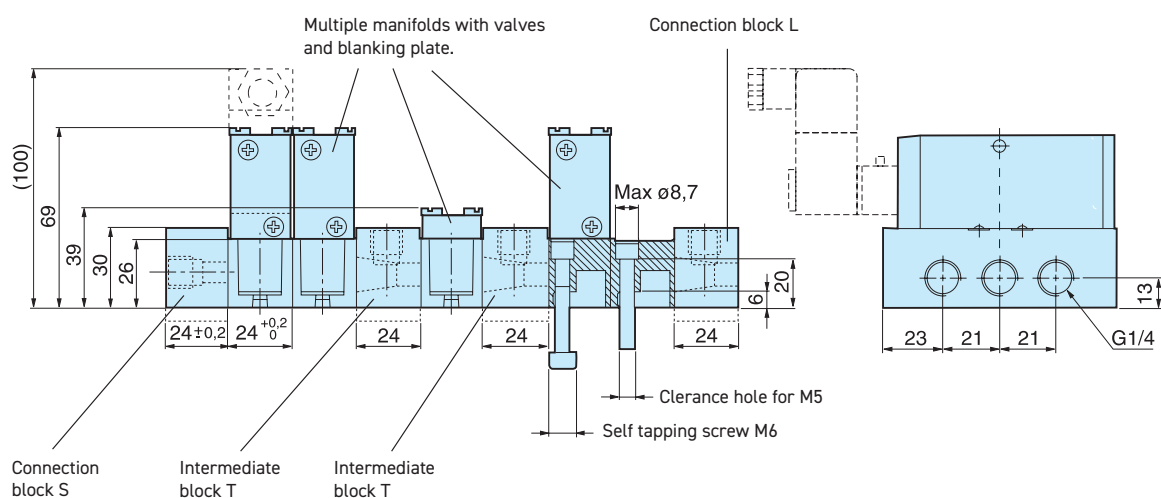

SUB-BASES & MANIFOLDS

P2LAX - 5/2 and 5/3

Accessories	Type	Weight Kg	Order code
	Manifold bar. P2LA including seals, mounting screws. G3/8 For 4 valves For 6 valves For 8 valves For 10 valves For 12 valves For 14 valves	0.48 0.63 0.80 0.98 1.10 1.23	9121658075 9121658076 9121658077 9121658078 9121658079 9121658099
	Blanking plate. P2LA for Manifold bar	0.10	9121658063
	Pressure bar. P2LA for common air supply incl. O-rings and mounting screws. G1/4 For 2 valves For 4 valves For 6 valves For 8 valves	0.13 0.20 0.26 0.33	9121658070 9121658071 9121658072 9121658073
	Blanking plate. P2LA for Pressure bar	0.05	9121658074
	Assembly screws. P2LA in stainless steel for valve	0.02	9121658043
	Assembly screws. P2LA in stainless steel for blanking plate	0.01	9121658044
	O-ring kit. P2LA O-rings between valve and manifold bar/Pressure bar	0.01	9121658046

Dimensions

Manifold bar. P2LA

No. of valves	L mm
4	126
6	174
8	222
10	270
12	318
14	366

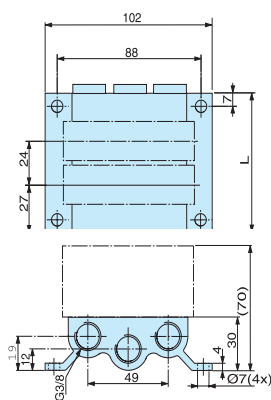

Blanking plate for manifold bar. P2LA

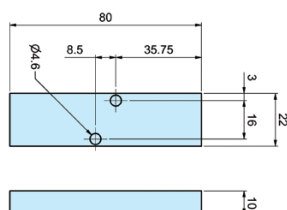

Pressure bar. P2LA

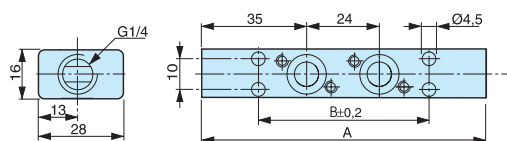

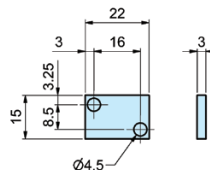

Blanking plate for pressure bar. P2LA



No. of valves	A mm	B mm
2	94	56
4	142	104
6	190	152
8	238	200

ACCESSORIES

Sintered bronze series

	Port	Order code	Pack Qty
 	M5	9721900005	1
	G1/8	9090050700	1
	G1/4	P6M-BAA2	1
	G3/8	9090050900	1
	G1/2	9090051000	1

Male straight connectors - Parallel thread

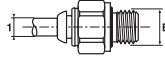
	Tube Ø1	Thread B	Order code	Box Qty
	4	1/8	F4PMB4-1/8	20
	6	1/8	F4PMB6-1/8	30
	6	1/4	F4PMB6-1/4	30
	8	1/8	F4PB8-1/8	40
	8	1/4	F4PB8-1/4	30
	8	3/8	F4PB8-3/8	20
	10	1/4	F4PB10-1/4	20
	10	3/8	F4PB10-3/8	20
	10	1/2	F4PB10-1/2	10
	12	1/4	F4PB12-1/4	10
	12	3/8	F4PB12-3/8	10
	12	1/2	F4PB12-1/2	10
	14	3/8	F4PB14-3/8	10
	14	1/2	F4PB14-1/2	10

DIMENSIONS

P2LAX... all

3/2 valves

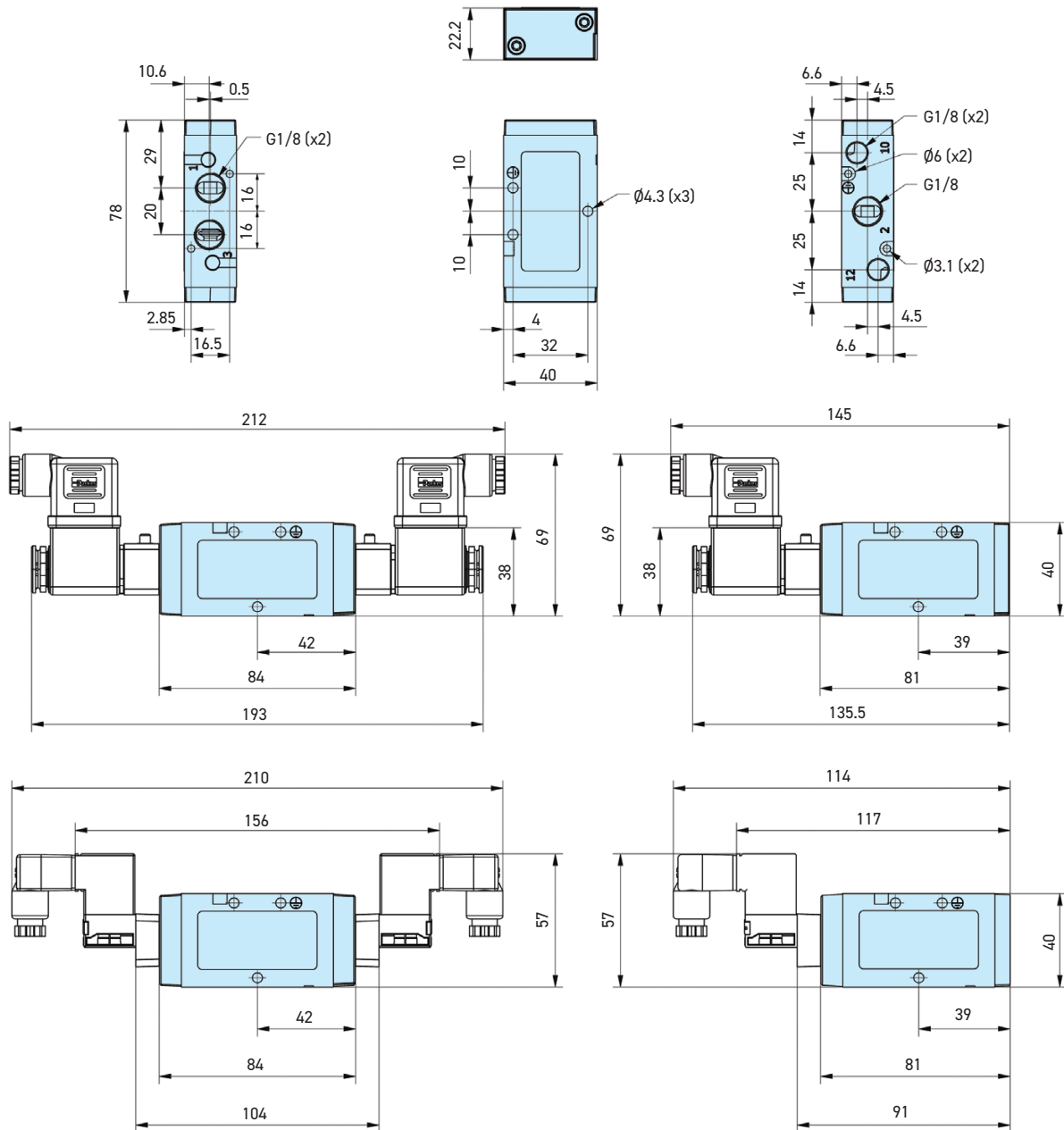

Solenoid valves

Cable plugs must be ordered separately.

One pilot valve is required for each E in the valve order code.

PDE2569TCUK - Viking Xtreme Series

Electric Motion and Pneumatic Division - Europe

DIMENSIONS

P2LAX... all
5/2 and 5/3 valves

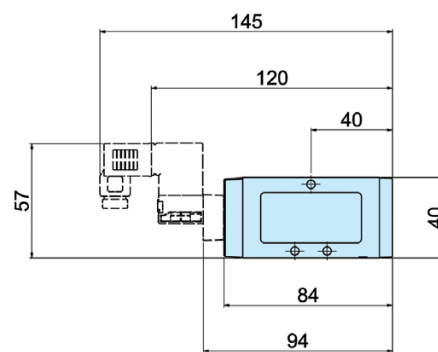
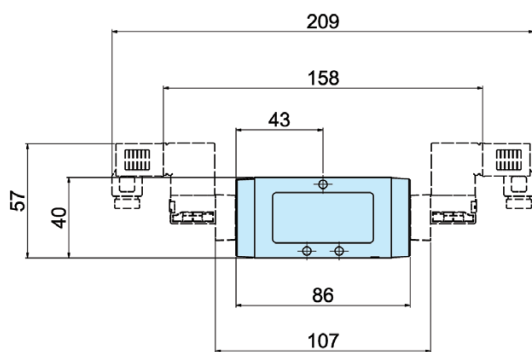
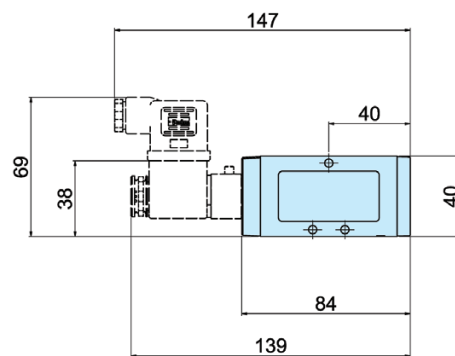
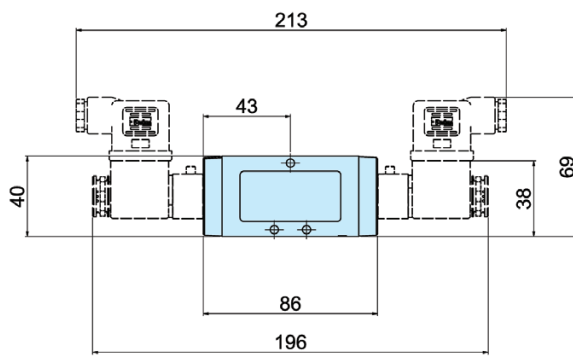
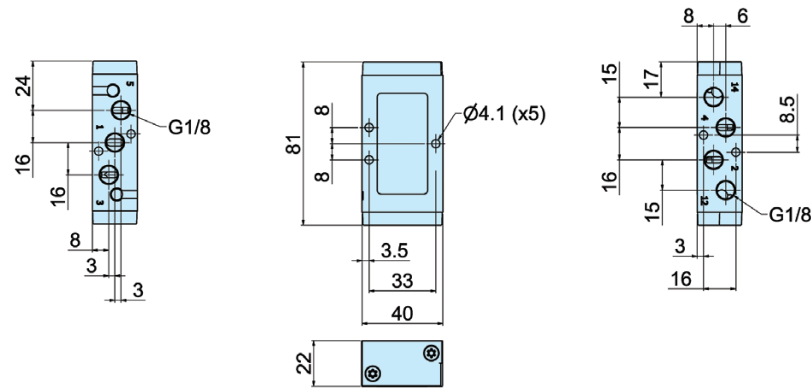

Solenoid valves

Cable plugs must be ordered separately.

One pilot valve is required for each E in the valve order code.

PDE2569TCUK - Viking Xtreme Series

Electric Motion and Pneumatic Division - Europe

DIMENSIONS

P2LAX - 3/2 Lever operated directional control valves

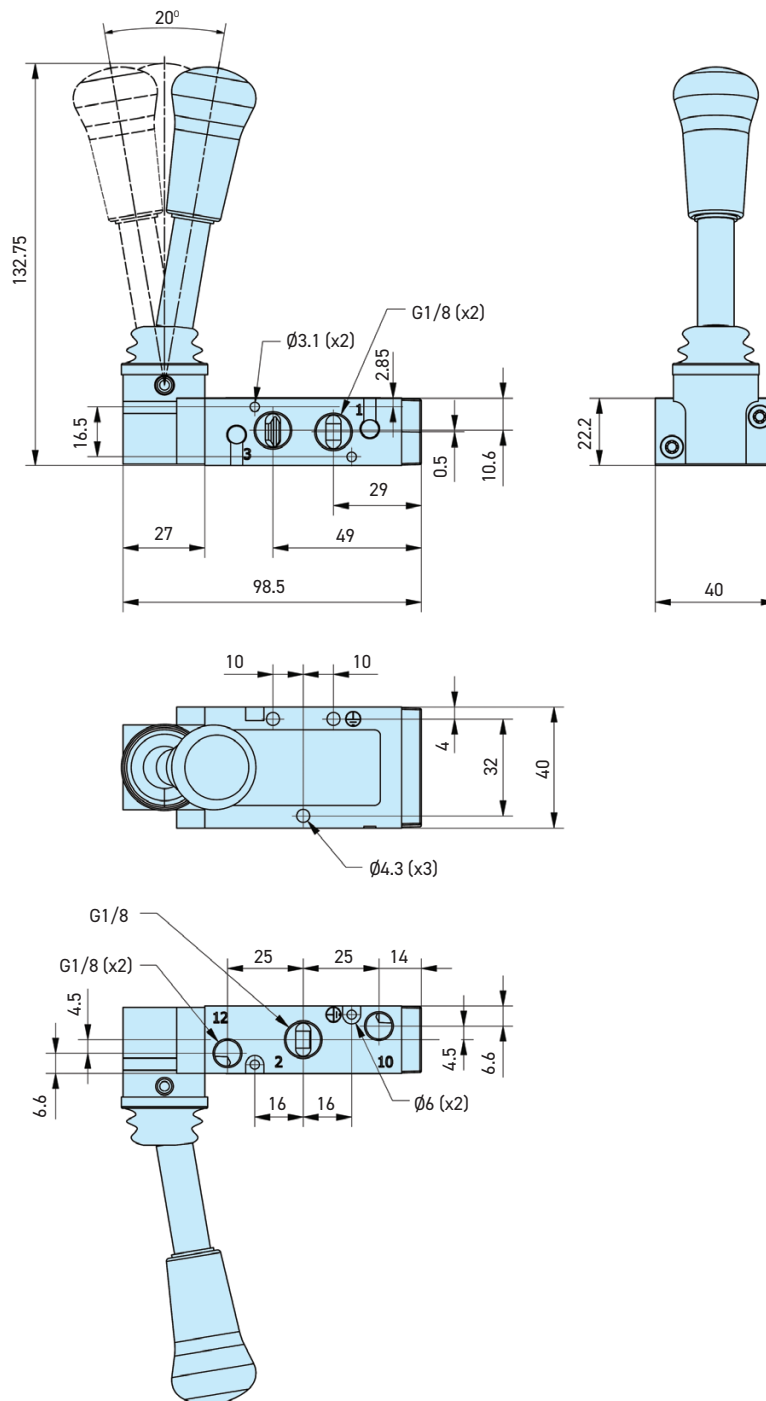

DIMENSIONS

P2LAX - 5/2 & 5/3 Lever operated directional control valves

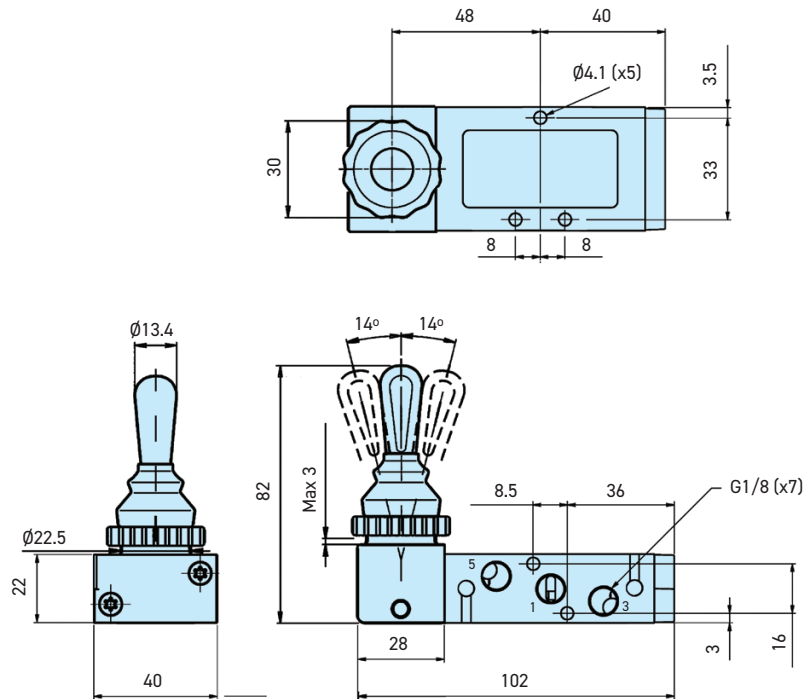

DIMENSIONS

P2LBX - 3/2 Lever operated directional control valves

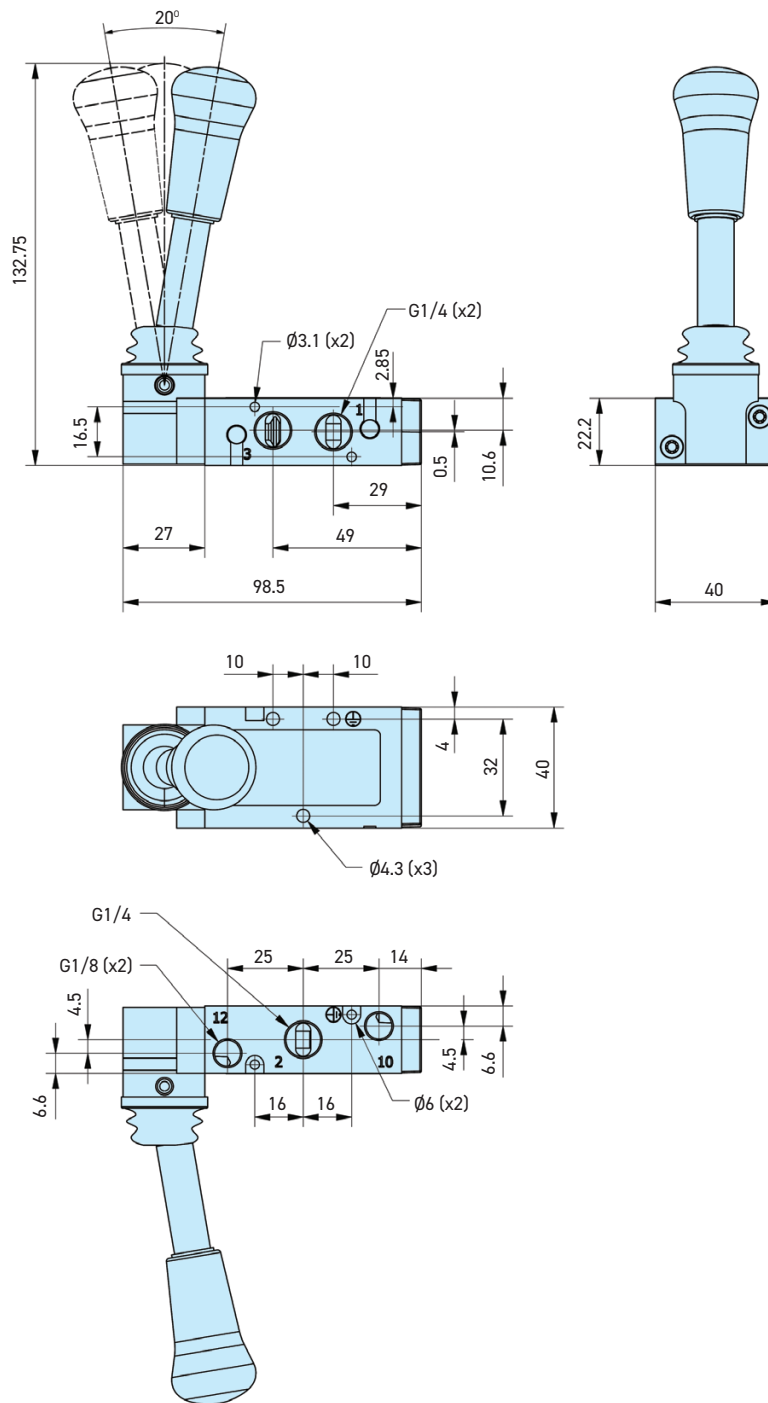

DIMENSIONS

P2LBX - 5/2 Lever operated directional control valves

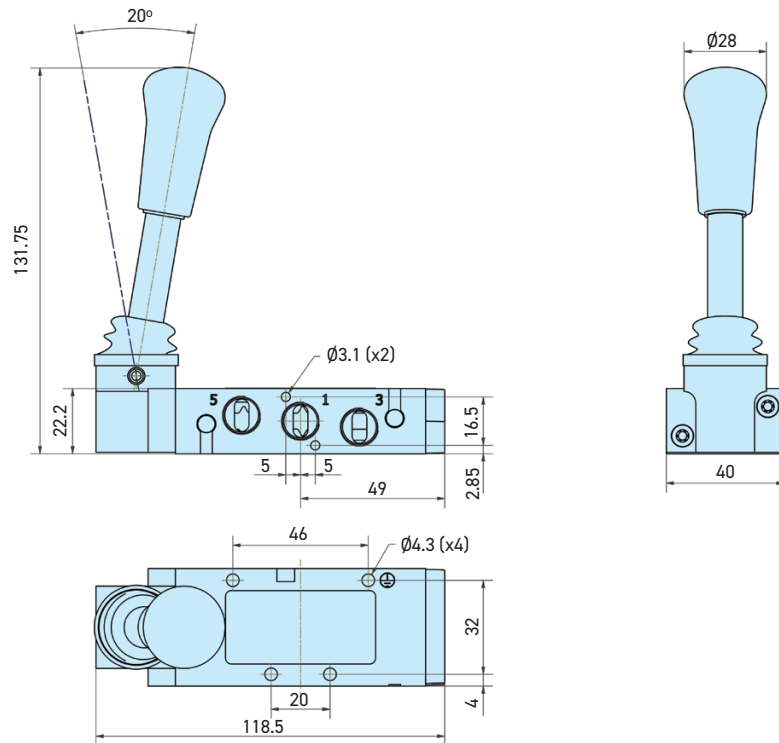

P2LBX - 5/3 Lever operated directional control valves

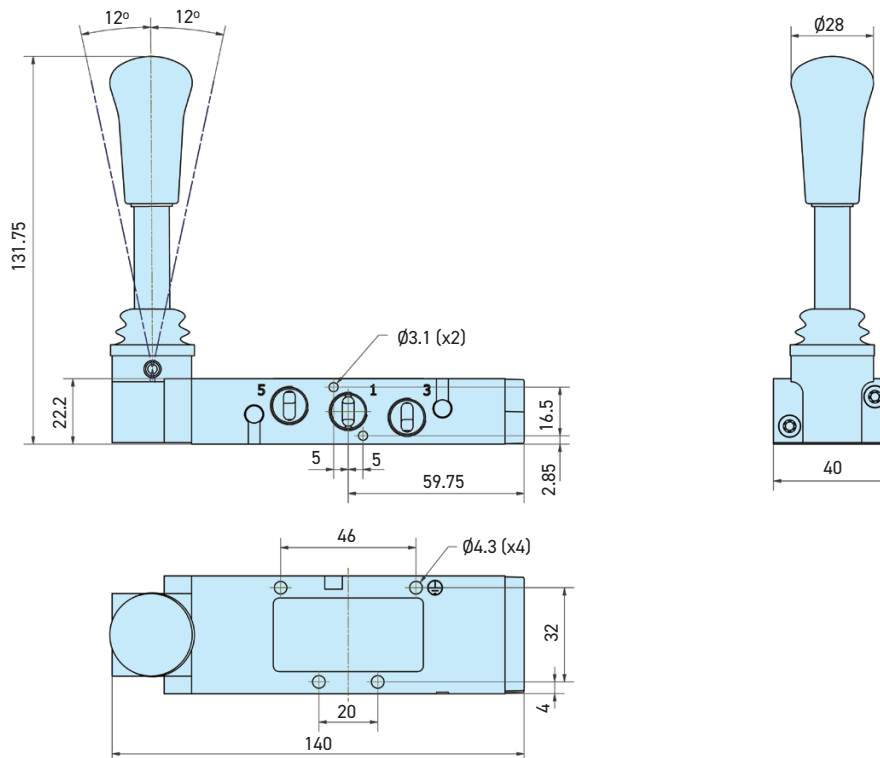

DIMENSIONS

P2LCX - 3/2 Lever operated directional control valves

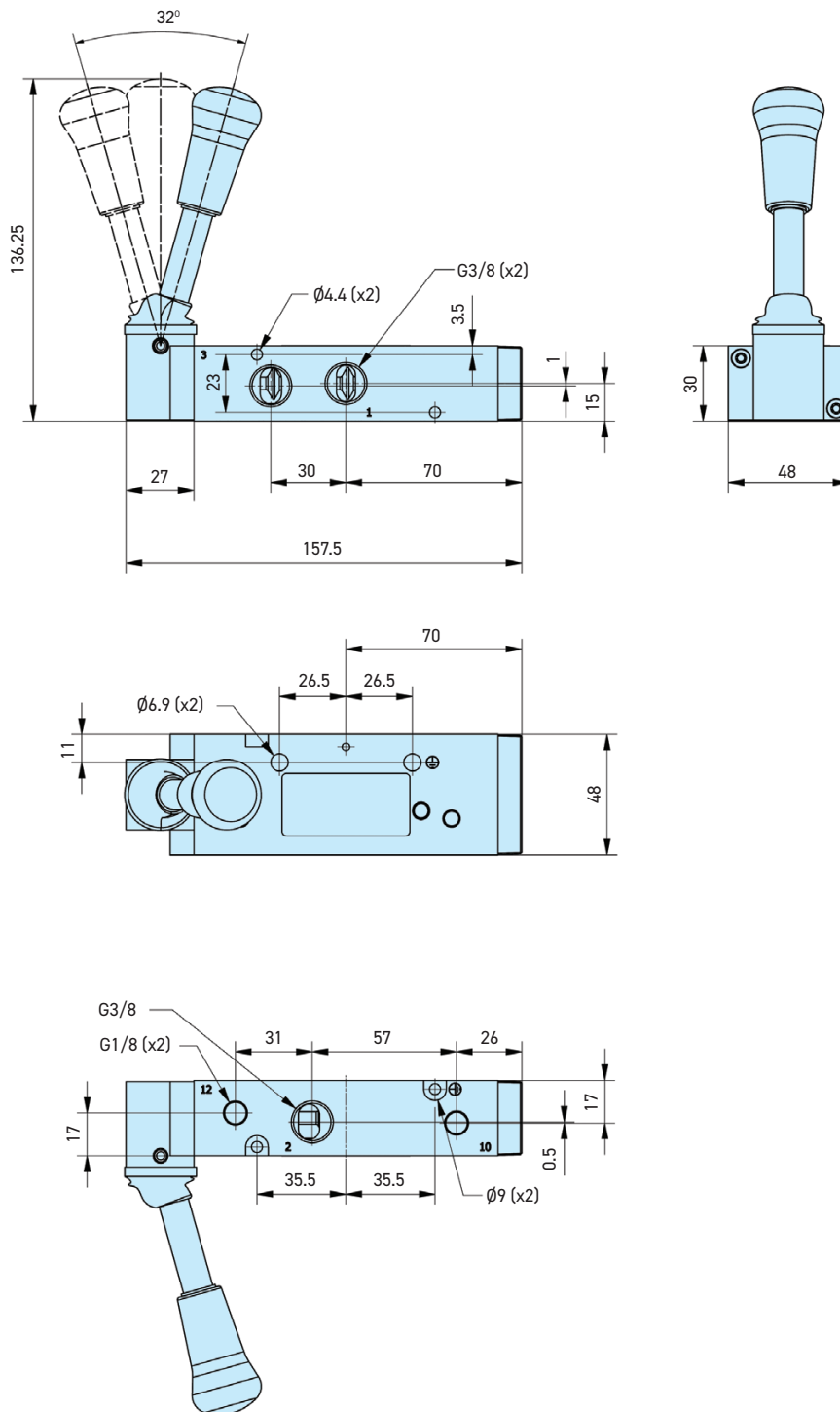

DIMENSIONS

P2LCX - 5/2 Lever operated directional control valves

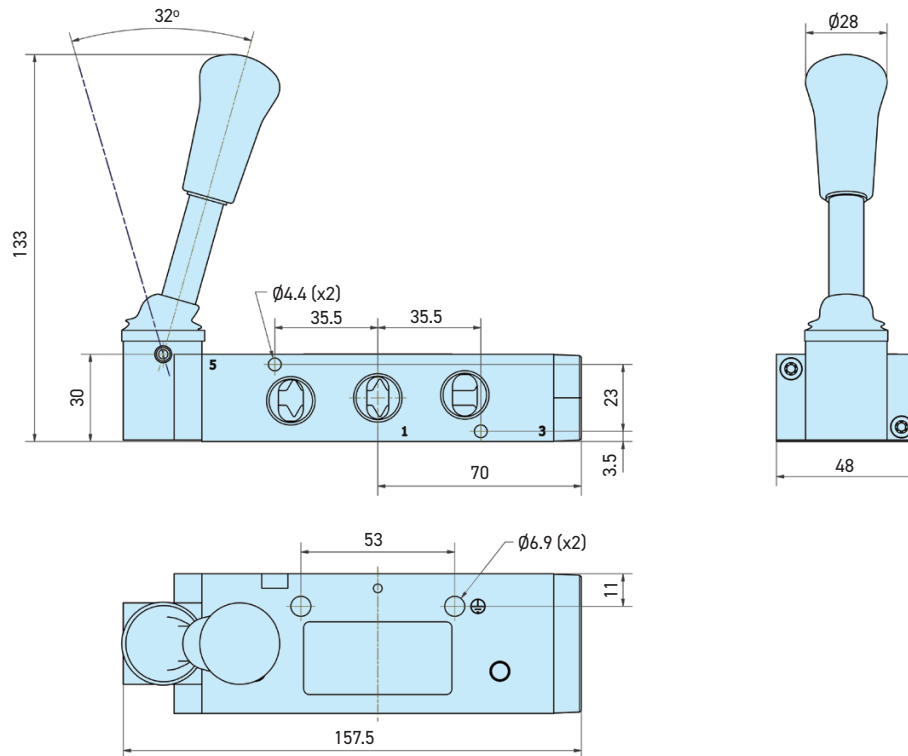

P2LCX - 5/3 Lever operated directional control valves

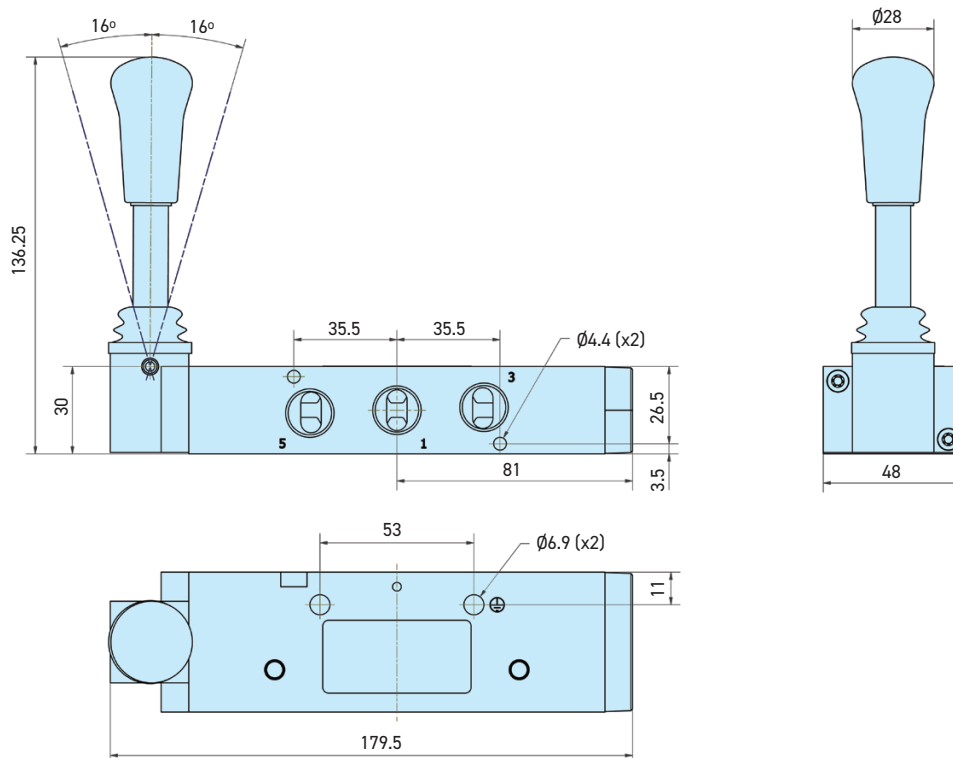

DIMENSIONS

P2LDX - 3/2 Lever operated directional control valves

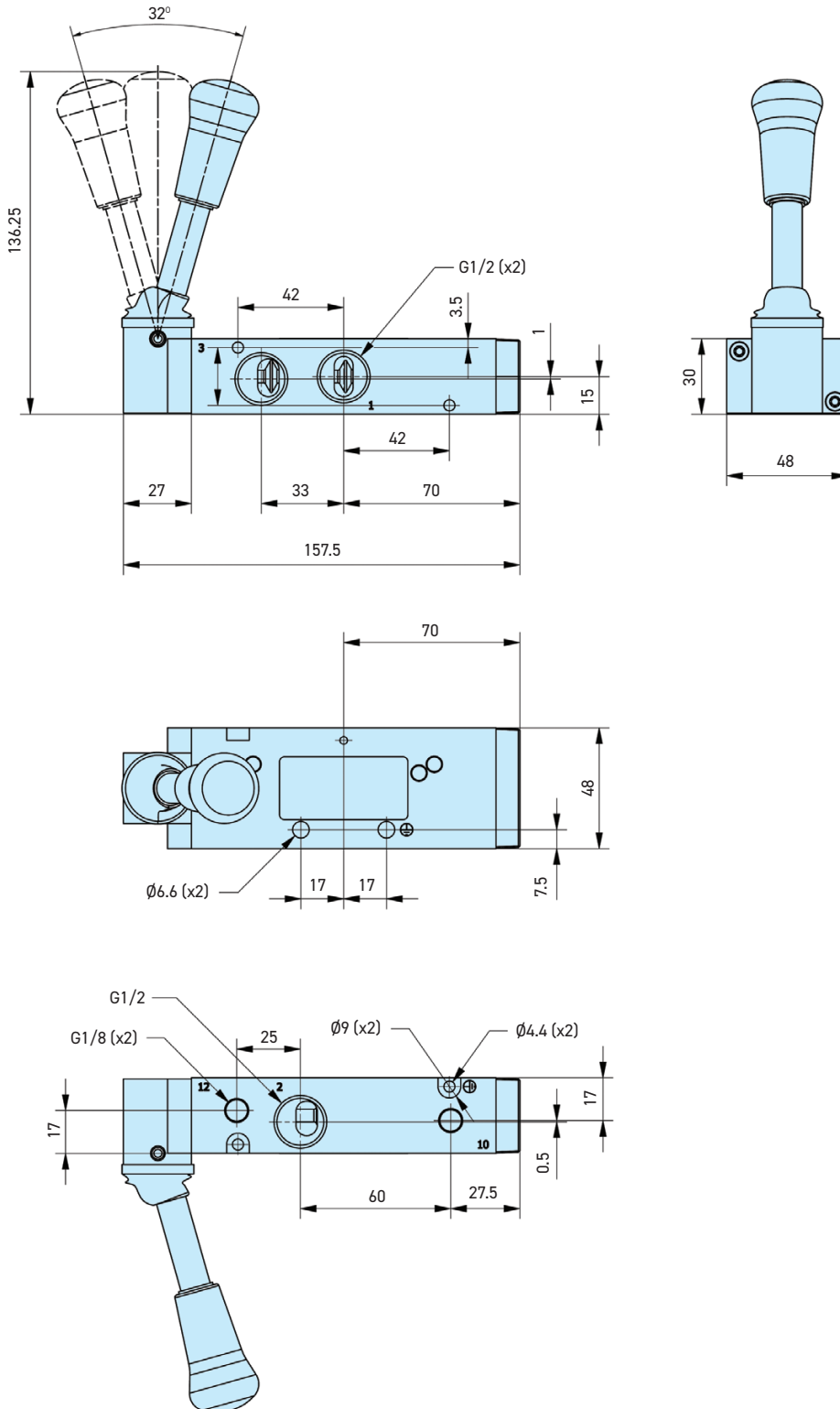

PDE2569TCUK - Viking Xtreme Series

Electric Motion and Pneumatic Division - Europe

DIMENSIONS

P2LDX - 5/2 Lever operated directional control valves

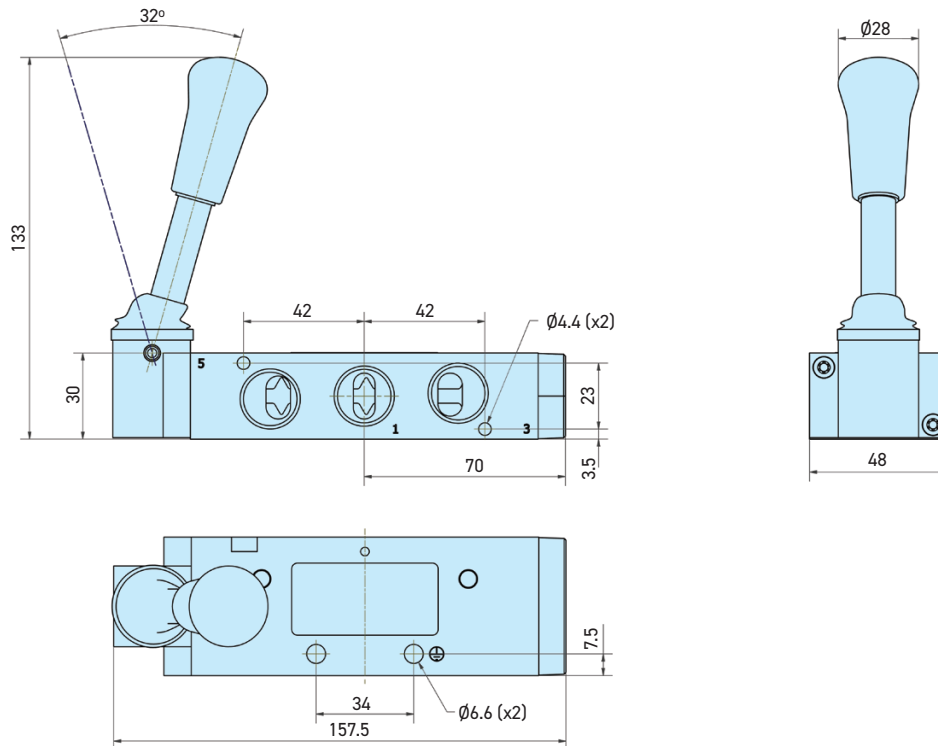

P2LDX - 5/3 Lever operated directional control valves

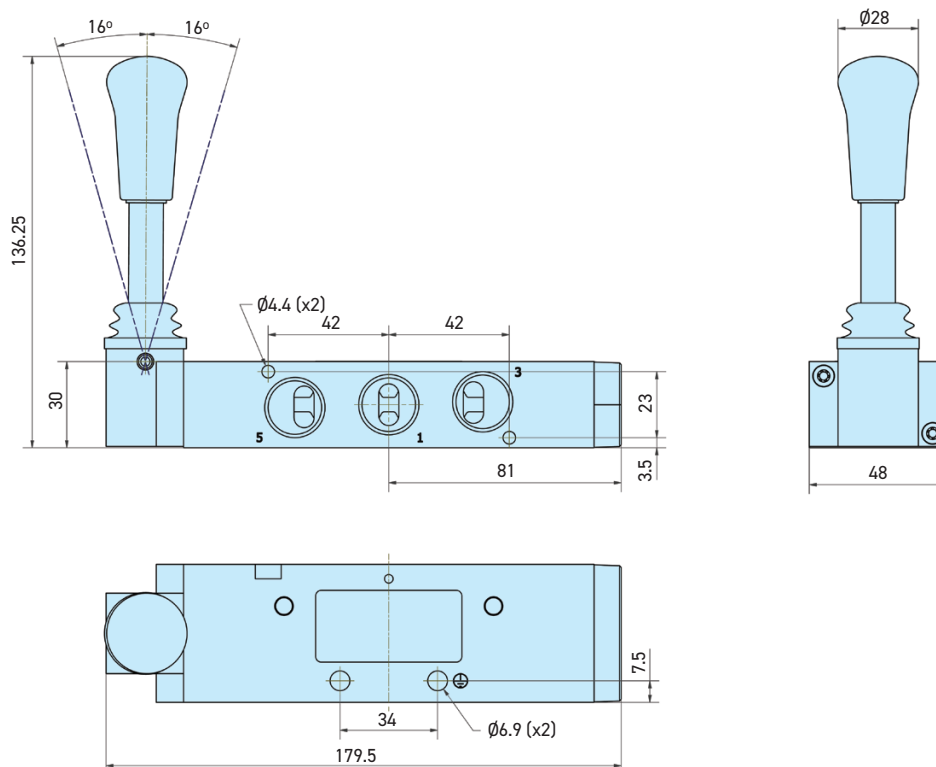

DIMENSIONS

P2LBX - 3/2 Twist operated directional control valves

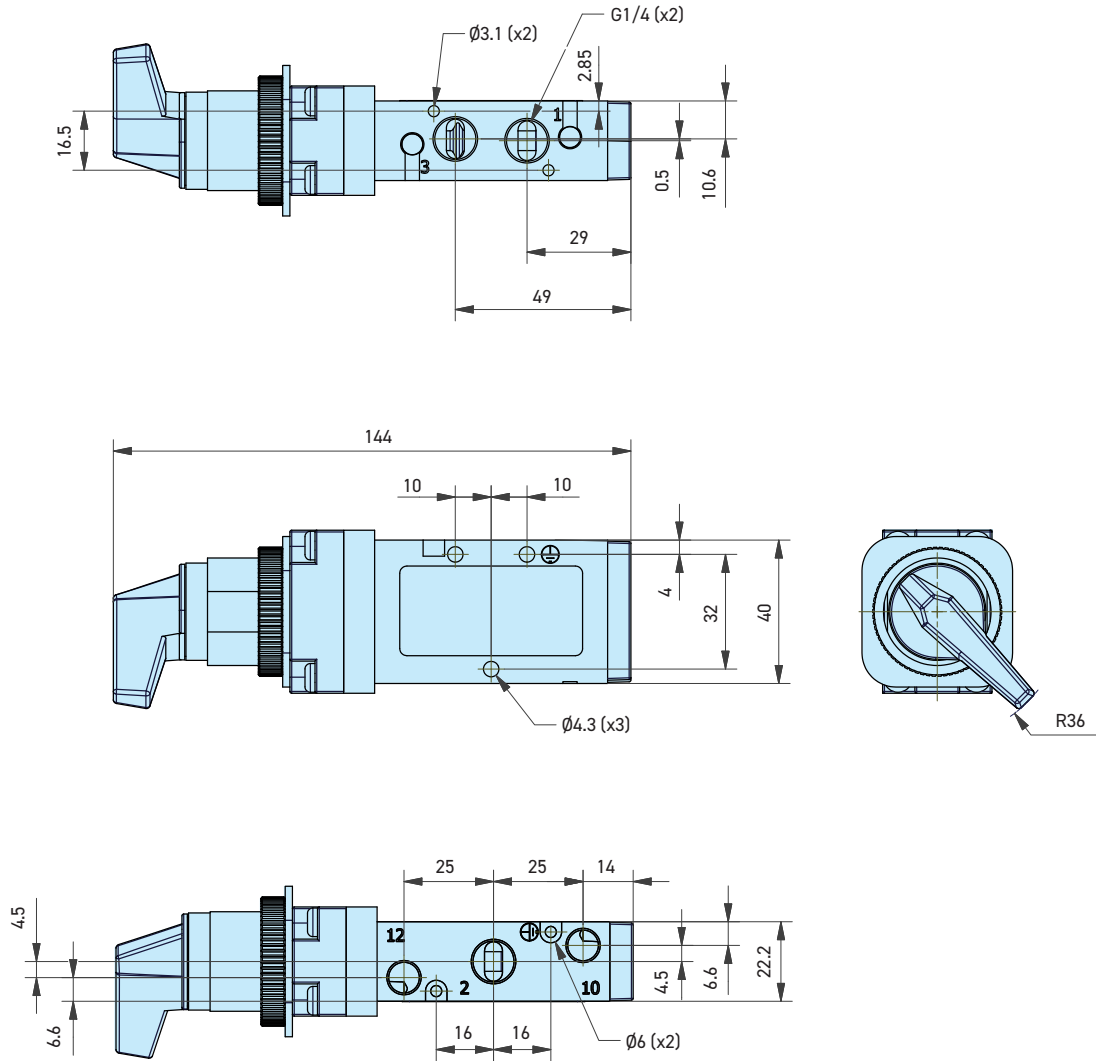

Panel cut-out details

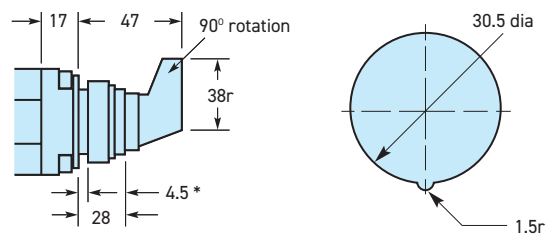

* Max panel thickness

DIMENSIONS

P2LBX - 5/2 Twist operated directional control valves

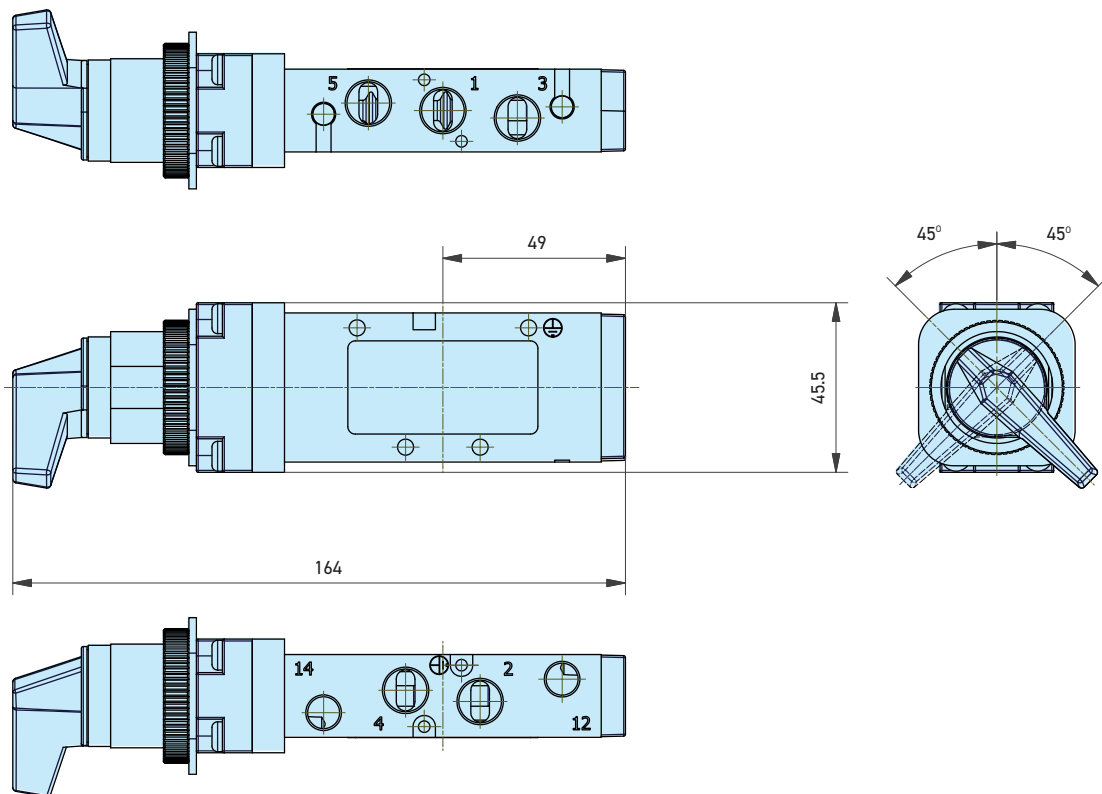

DIMENSIONS

P2LBX - 5/3 Twist operated directional control valves

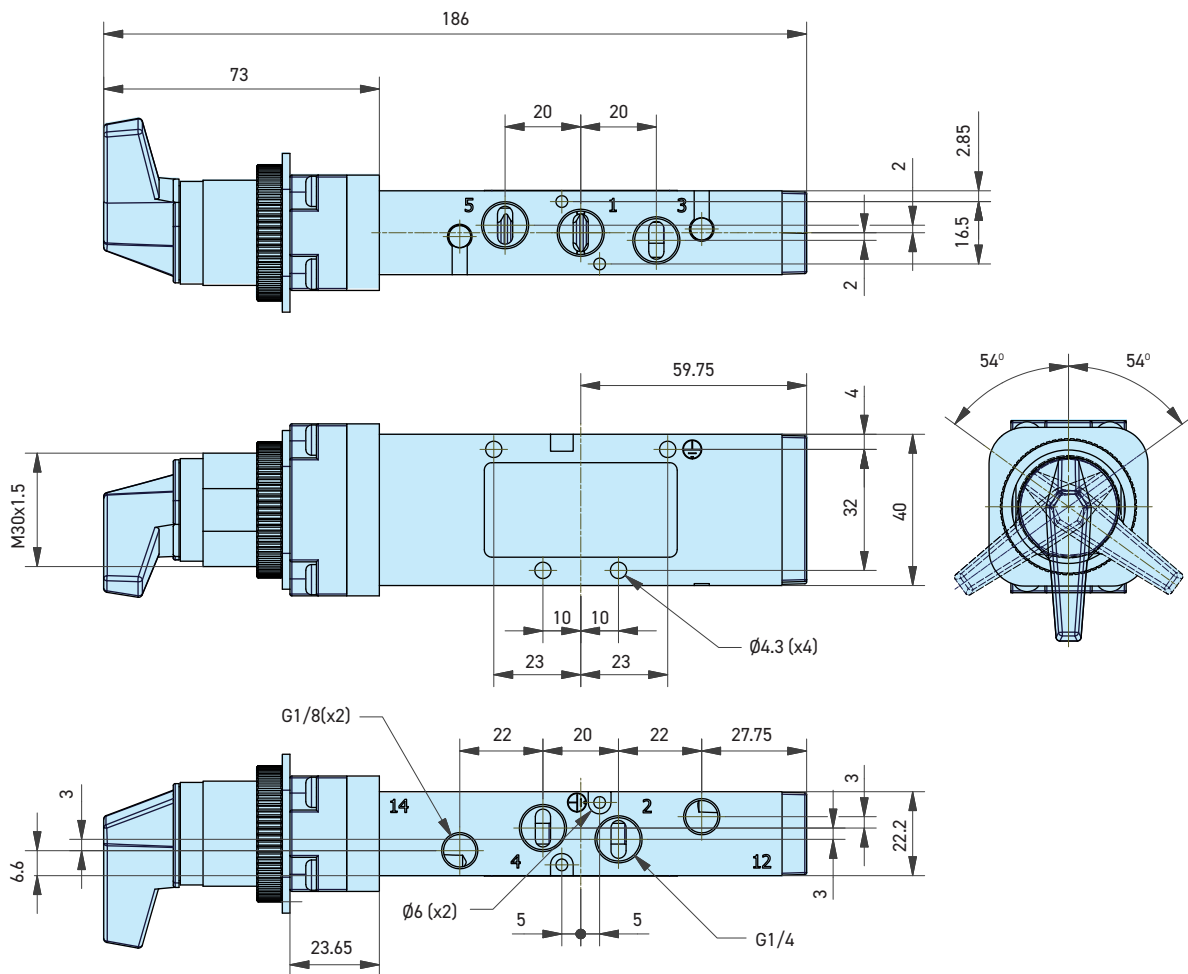

DIMENSIONS

P2LBX - 3/2 Lever

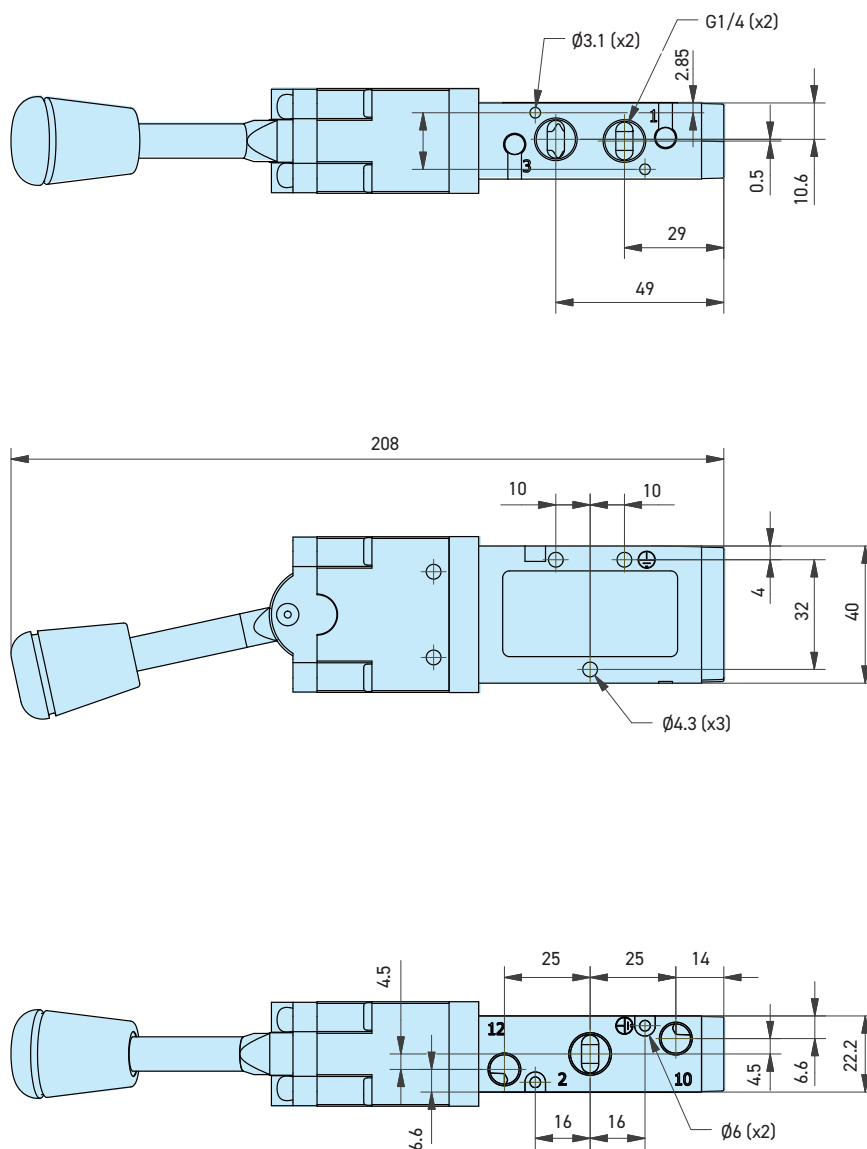

DIMENSIONS

P2LBX - 5/2 Lever

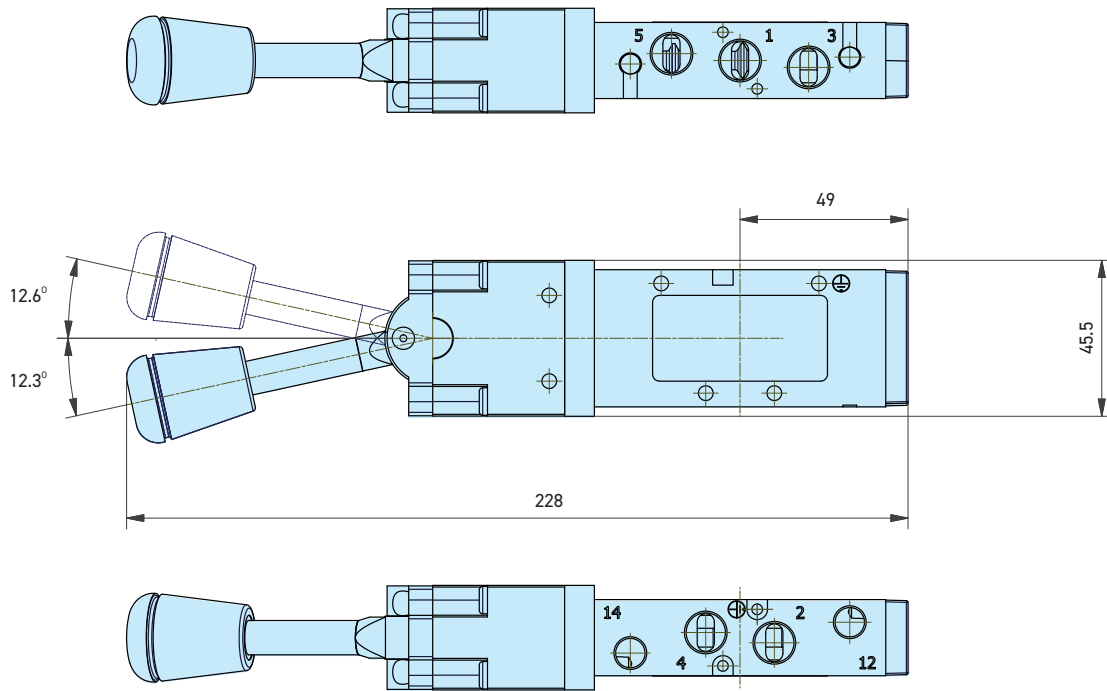

DIMENSIONS

P2LBX - 5/3 Lever

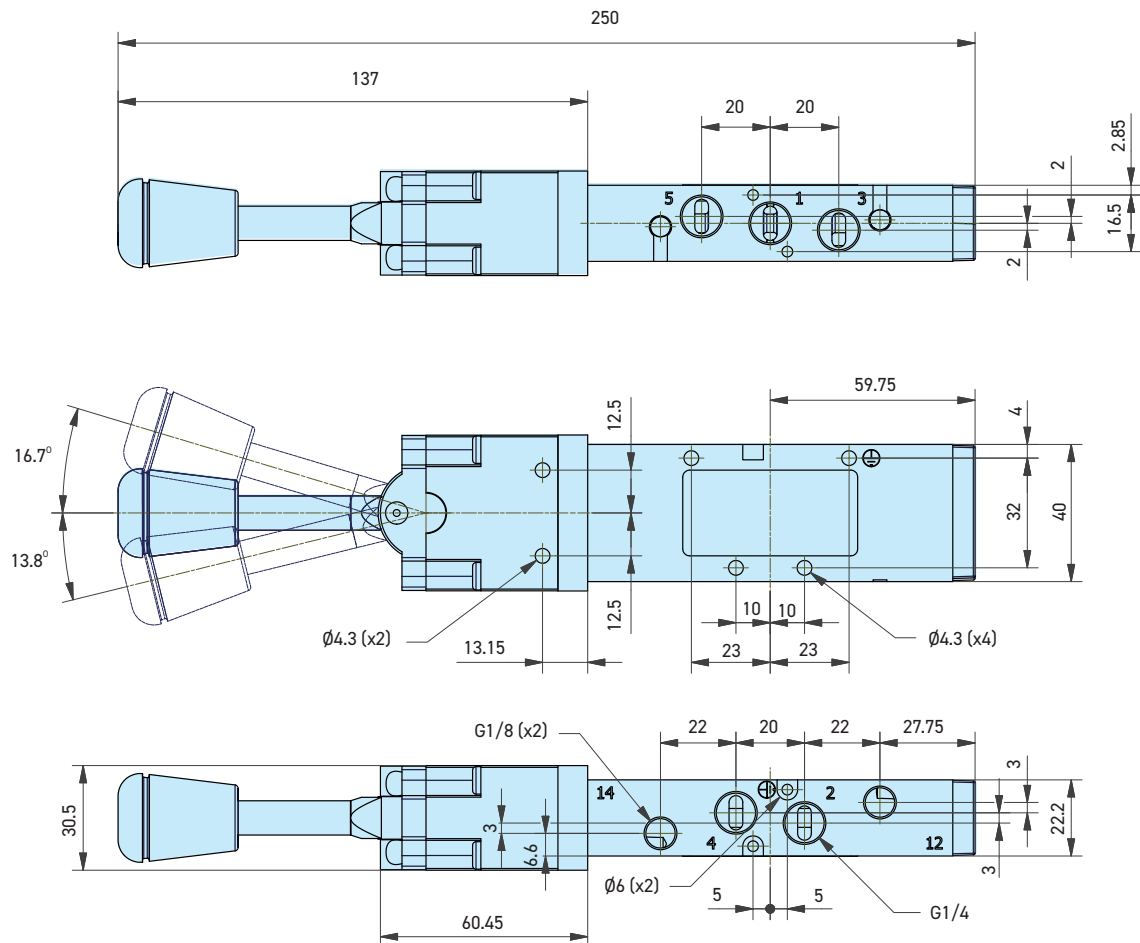

DIMENSIONS

P2LBX... all

3/2 valves

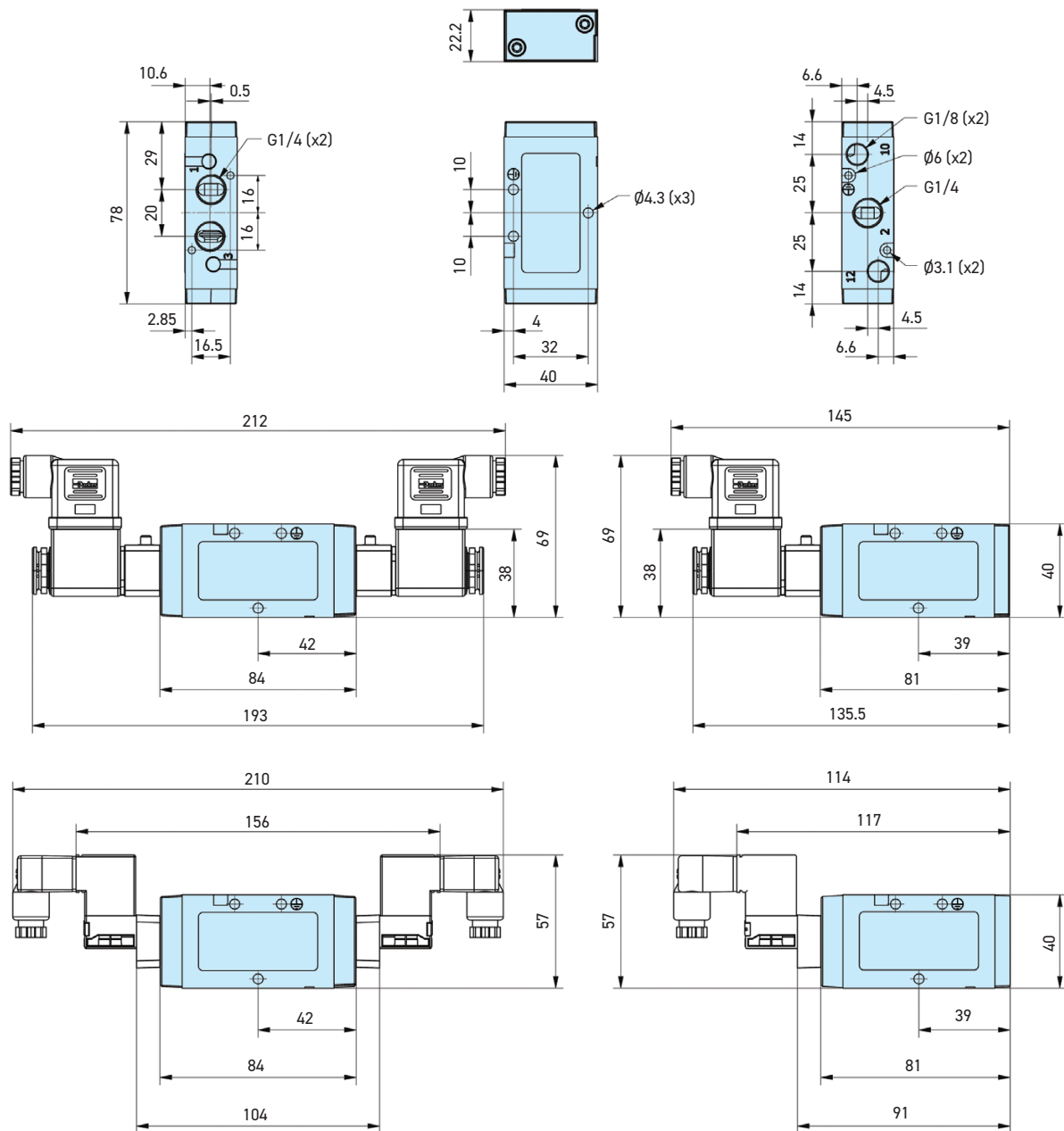

DIMENSIONS

P2LBX... all
5/2 and 5/3 valves

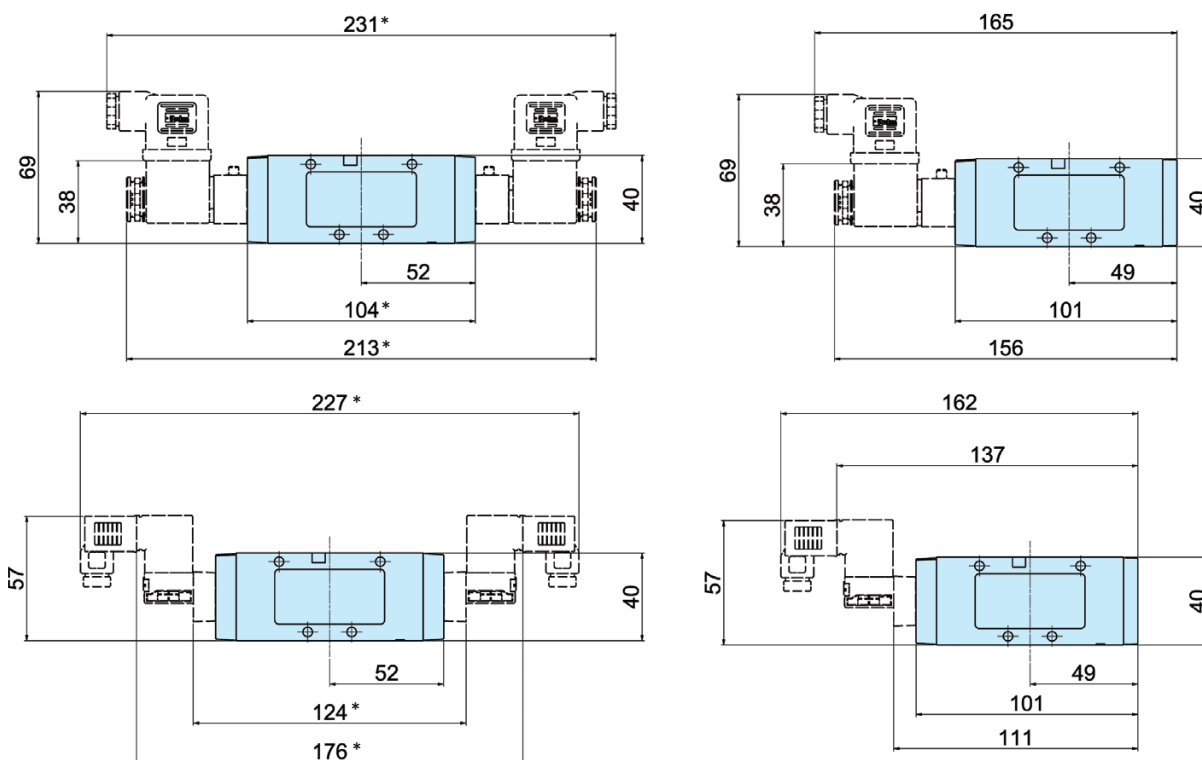
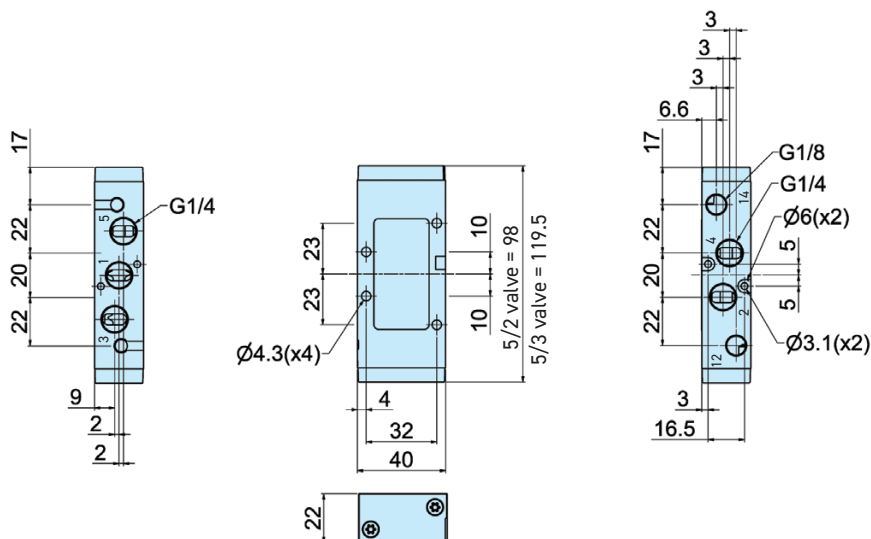

* Note: 5/3 valves - add 21.5mm

DIMENSIONS

NAMUR

5/2 valves

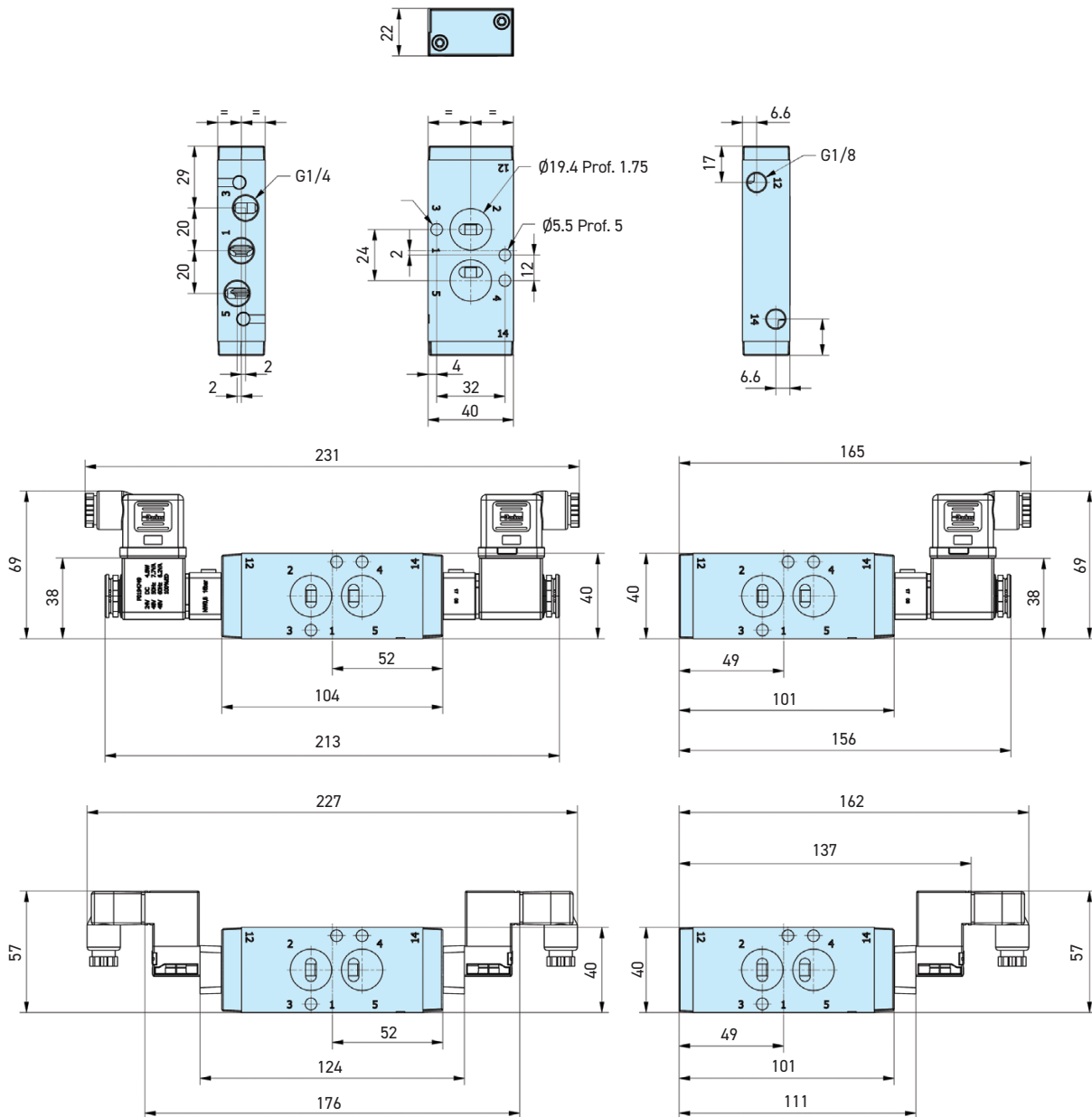

DIMENSIONS

P2LCX... all

3/2 valves

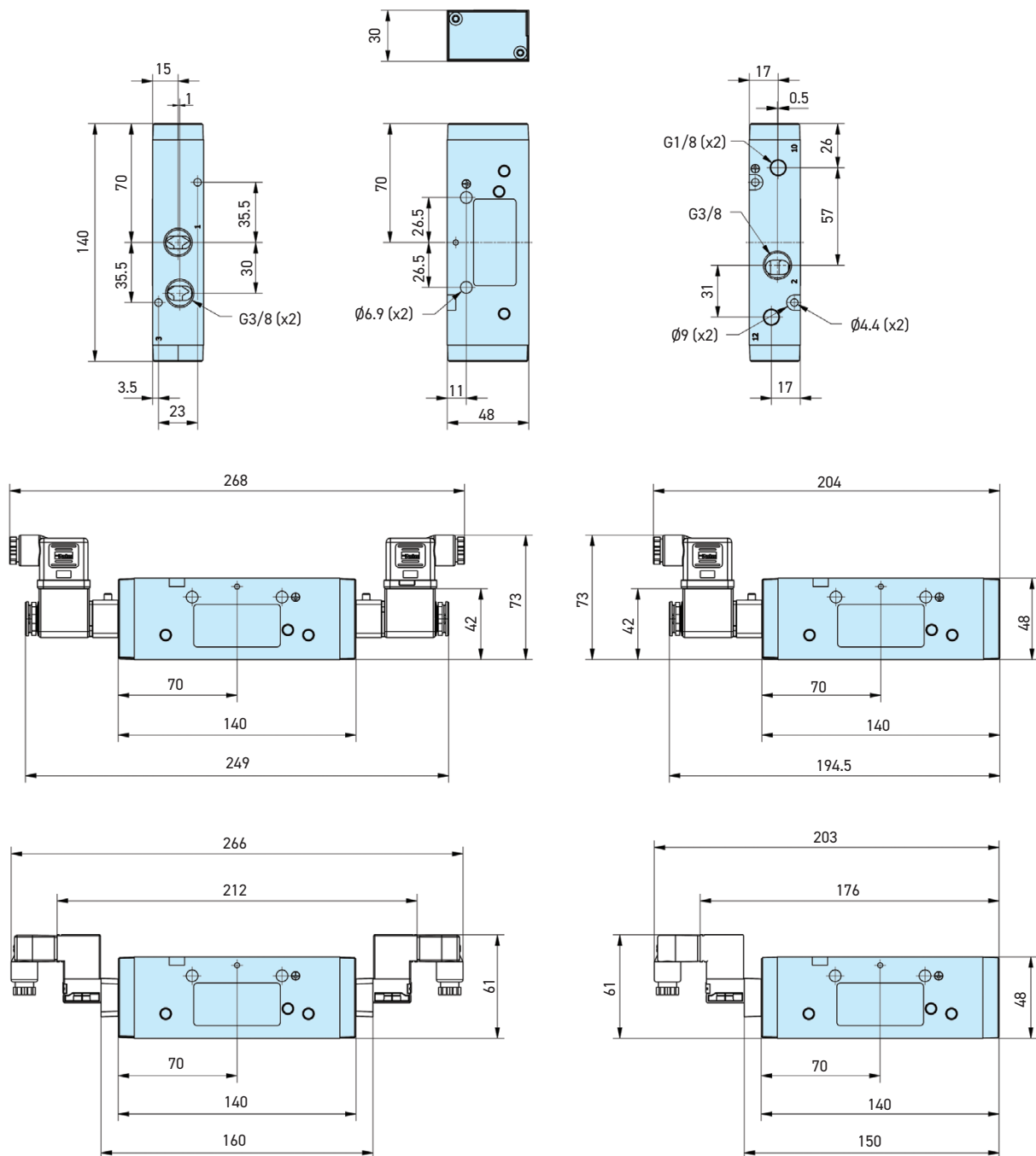

DIMENSIONS

P2LCX... all
5/2 and 5/3 valves

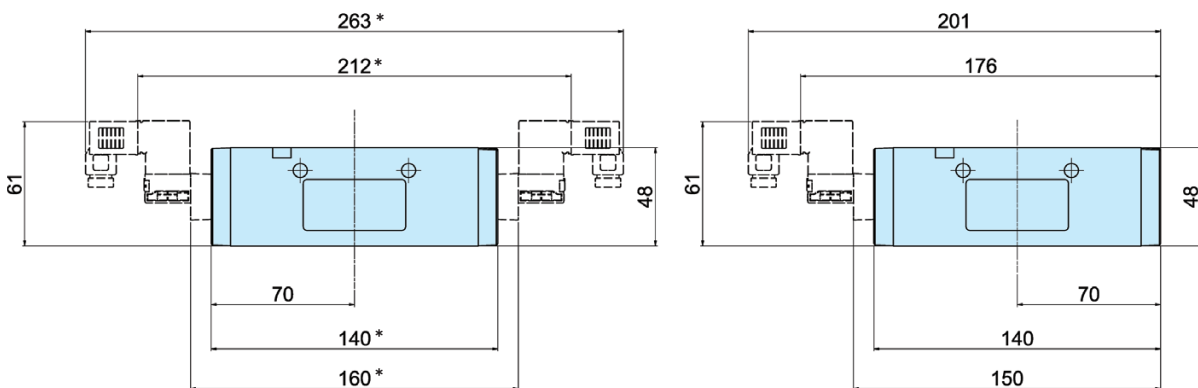
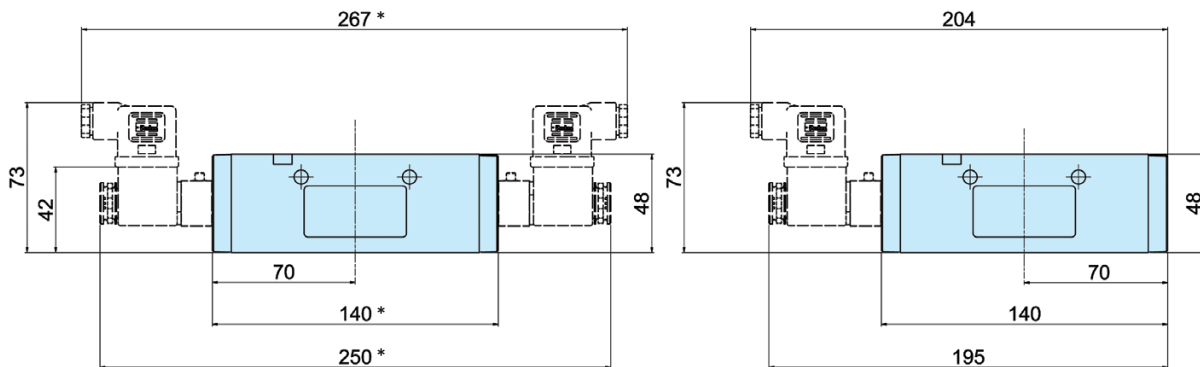
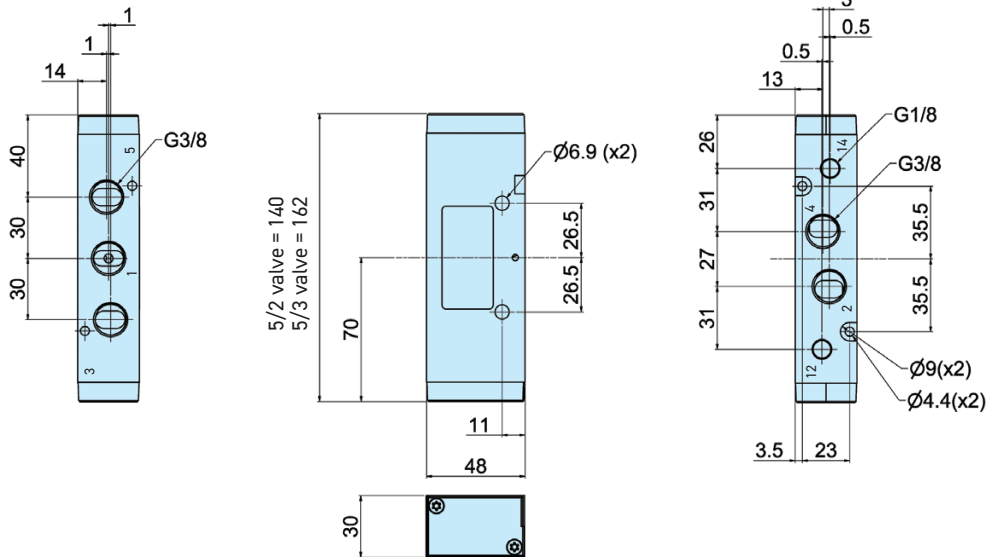

* Note: 5/3 valves - add 22.0mm

PDE2569TCUK - Viking Xtreme Series

Electric Motion and Pneumatic Division - Europe

DIMENSIONS

P2LCX... all

3/2 valves

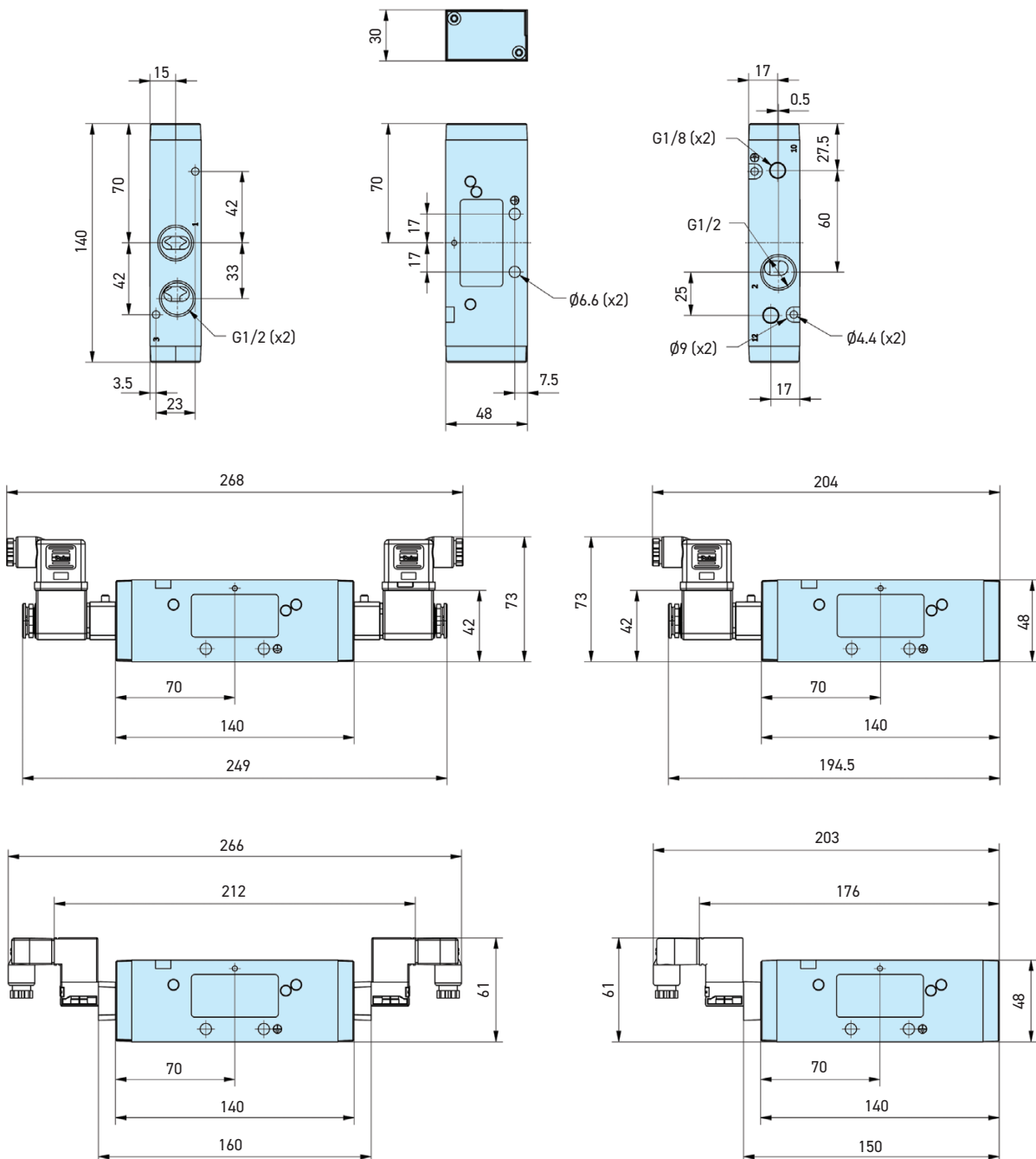

DIMENSIONS

P2LDX... all
5/2 and 5/3 valves

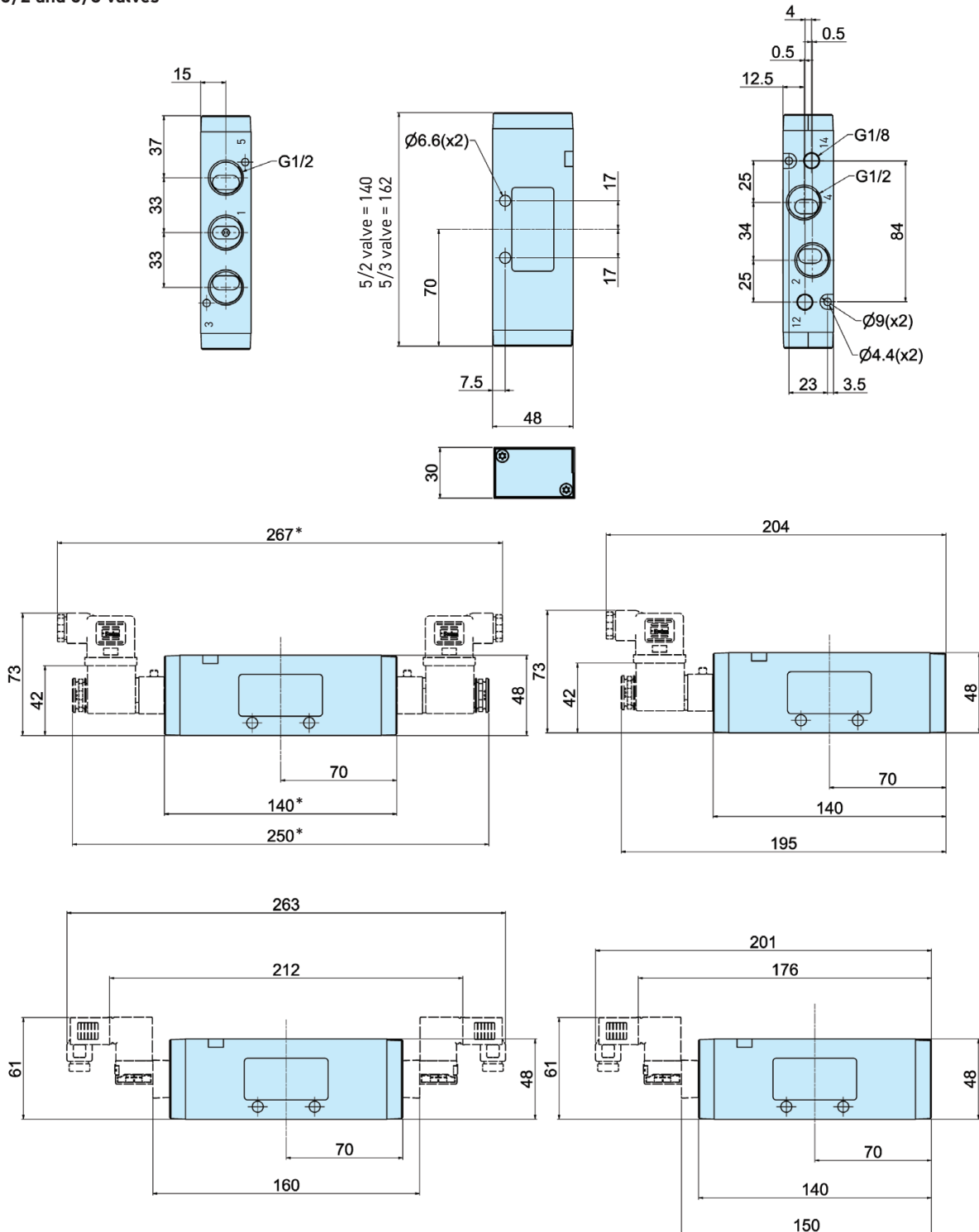

* Note: 5/3 valves - add 22.0mm

PDE2569TCUK - Viking Xtreme Series

Electric Motion and Pneumatic Division - Europe

DIMENSIONS

NAMUR

5/2 and 5/3 valves

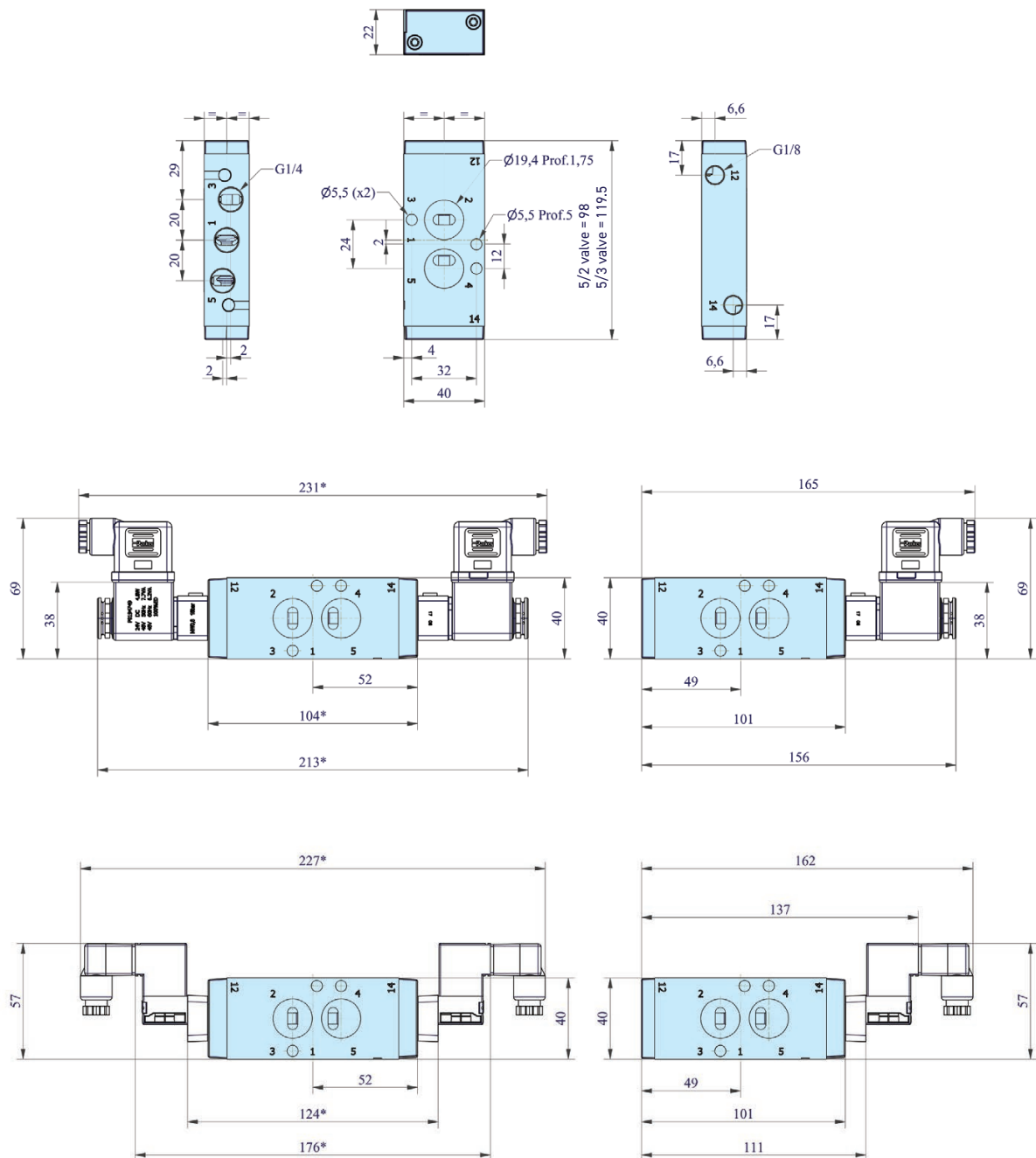

CABLE PLUG DIMENSIONS (MM)

Solenoid operators P2E-•V...

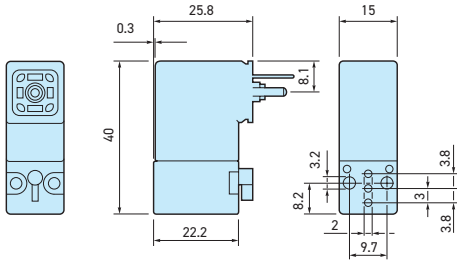

Solenoid operators P2E-•V...

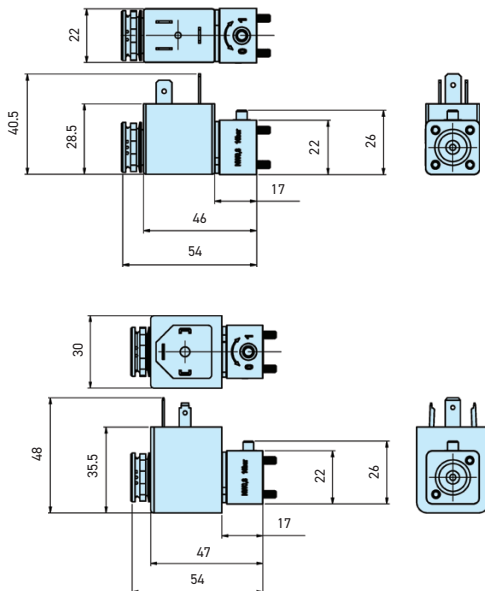

Cable plugs

P8C-C
P8C-C26C
P8C-C21E
P8C-D
P8C-D26C
P8C-D21E

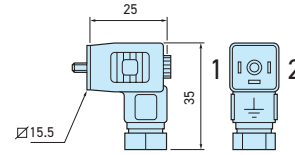

Cable plugs with cables

P8L-C2
P8LC5
P8L-C226C
P8L-C526C
P8L-CA26C
P8L-C221E
P8L-C521E

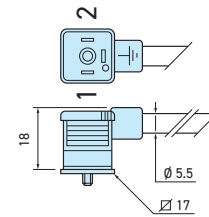

Cable plugs Form B

3EV10V10
3EV10V20-24
3EV10V20-110
3EV10V20-230
3EV10V20-24L5
3EV10V20-110L5
3EV10V20-230L5

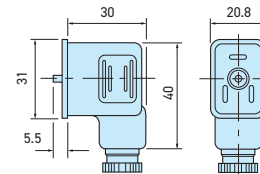

Cable plugs Form A

3EV290V10
3EV290V20-24
3EV290V20-24L5

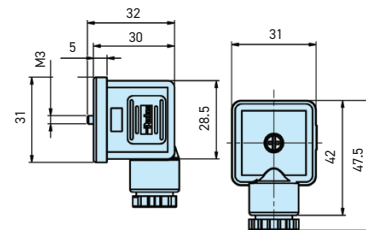

**WARNING — USER RESPONSIBILITY****FAILURE OR IMPROPER SELECTION OR IMPROPER USE OF THE PRODUCTS DESCRIBED HEREIN OR RELATED ITEMS CAN CAUSE DEATH. PERSONAL INJURY AND PROPERTY DAMAGE.**

- This document and other information from Parker-Hannifin Corporation, its subsidiaries and authorized distributors provide product or system options for further investigation by users having technical expertise.
- The user, through its own analysis and testing, is solely responsible for making the final selection of the system and components and assuring that all performance, endurance, maintenance, safety and warning requirements of the application are met. The user must analyze all aspects of the application, follow applicable industry standards, and follow the information concerning the product in the current product catalog and in any other materials provided from Parker or its subsidiaries or authorized distributors.
- To the extent that Parker or its subsidiaries or authorized distributors provide component or system options based upon data or specifications provided by the user, the user is responsible for determining that such data and specifications are suitable and sufficient for all applications and reasonably foreseeable uses of the components or systems.

Offer of Sale

Please contact your Parker representation for a detailed "Offer of Sale".



www.parker.com

PDE2569TCUK

11/2025

© 2025 Parker Hannifin EMEA Sarl. All Rights Reserved.