

# SENSORS AND SWITCHES

for pressure, temperature, level and flow.



## Sensors and switches for Pressure, Temperature, Level and Flow

All the instruments meet the guidelines of the European Community (EU).  
It is confirmed that these products are approved acc. to following standards.



DIN/EN 61000-6-2  
DIN/EN 61000-6-3



**Note!**

This document and other information from Parker Hannifin GmbH, provide product or system options for further investigation by users having technical expertise. Before you select or use any product or system it is important that you analyse all aspects of your application and review the information concerning the product or system in the current product catalogue. Due to the variety of operating conditions and applications for these products or systems, the user, through his own analysis and testing, is solely responsible for making the final selection of the products and systems and assuring that all performance and safety requirements of the application are met. The products are subject to change by Parker Hannifin GmbH at any time without notice.

Technical subject to change. April 2025.

© Copyright 2025, Parker Hannifin Corporation. All Rights Reserved.









## Table of Contents

	Page
Product overview	4-5
Selection guide pressure sensors	6
Selection guide pressure controller	7
<b>Pressure sensors</b>	<b>9-31</b>
SCP03 pressure sensor	12-16
SCP04 pressure sensor	17-21
SCP08 pressure sensor	22-23
SCP09 pressure sensor	24-28
SCP10 pressure sensor	29-33
SCP11 pressure sensor	34-37
SCPSi pressure switch	38-40
<b>Volumetric flow rate sensors</b>	<b>41-56</b>
SCQ flow meter	43-46
SCFT measurement turbine	47-50
SCVF volume counter	51-56
<b>The Controller Family</b>	<b>57-84</b>
SCPSDI pressure switch	59-62
SCTSD-L combination switch	63-66
SCLSD LevelController	67-72
SCLTSD LevelTempController	73-78
SCOTC OilTankController	79-84
<b>Accessories</b>	<b>85-90</b>
SCK cable	85-86
SCA adapter	87-88
Software ControllerWIN	89-90
<b>Installation and safety instructions</b>	<b>91</b>
EMC	91
Compatibility with media (substances)	91
Pressure range selection	91
<b>Appendix</b>	<b>92-93</b>
Conversion charts	92
Index	93
Old and new references	93



# Product overview

## Measurement

### Pressure and temperature sensors

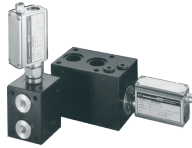

SCP03	SCP04	SCP08
		
Pressure sensor for mobile and industrial applications	Pressure transmitter for hydrogen applications	Pressure sensor for press construction and die-casting
Page 12-16	Page 17-21	Page 22-23
SCP09	SCP10	SCP11
		
Pressure sensor for industrial applications in the mid and high pressure ranges	For explosive environment with ATEX	Pressure Transmitter for hydrogen applications with ATEX approval
Page 24-28	Page 29-33	Page 34-37
SCPSi		
		
Pressure switch with IO-Link		
Page 38-40		



### Volumetric flow rate sensors

SCQ	SCFT	SCVF
		
For quick flow changes Measures in both directions	Low loss measuring of volume flow	Measures different substances Measures lower volume flows (leakage measurements)
Page 43-46	Page 47-50	Page 51-56

# Product overview

## Measurement, display and switching

	SCPSDI	SCTSD-L	SCLSD
<b>The Controller Family</b>			
	Pressure display and monitoring	Temperature display and level monitoring	Level display and monitoring
	Page 59-62	Page 63-66	Page 67-72

SCLTSD	SCOTC
	
Level/temperature display and monitoring	
Page 73-78	Page 79-84

## Accessories

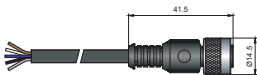
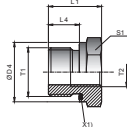
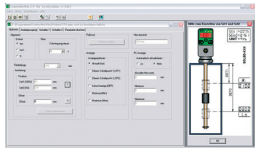
SCK cable	SCA adapter	Software ControllerWIN
		
Page 85-86	Page 87-88	Page 89-90

## Selection guide pressure sensors

		SCP03	SCP04	SCP08	SCP09
<b>Pressure-range</b>	0...bar / (psi) relative	04...1000 (58...14,504)	04...1000 (58...14,504)	250/400/600/1000 (3626...14,504)	10...600 (145...8702)
	-1...bar / -14.5 (psi) relative	3...24 (43,5...348)			
	0...bar / (psi) absolut				
<b>Order qty.</b>		50 pcs	50 pcs	1 / 5 / 50 pcs	
<b>Accuracy</b>		0,5 %	0,5 %	0,5 %	0,5 %
<b>Display</b>					
<b>Output</b>	Switching Output				
	IO-Link				
	0,5...4,5 V (ratiometric 5V)	•	•		•
	0,5...4,5 V (nominal 24V)	•			•
	0...5 V	•			•
	1...6 V	•			
	0...10 V	•	•	•	•
	0...20 mA	•			
	4...20 mA (3-wire)	•			
	4...20 mA (2-wire)	•	•	•	•
CAN					
<b>Electrical Plug</b>	M12	•	•	•	•
	DIN EN 175301-803 Form A	•	•	•	•
	DIN Micro 9.4				
	AMP Superseal	•			
	Deutsch DT04 4-pin	•			
	Deutsch DT04 3-pin	•	•		
	Junior Timer	•			
	Cable 2m	•			
<b>Thread</b>	G1/4 BSPP ED	•	•	•	•
	G 1/4 O-ring	•			
	1/4 NPT	•	•		•
	7/16-20 UNF	•	•		•
	9/16-20 UNF	•			
<b>Wetted parts</b>	Stainless steel/ Soft sealing	<b>FKM</b>		<b>FKM</b>	<b>FKM</b>
	Stainless steel/ Metall sealing		•		
<b>Approvals</b>	CE	•		•	•
	Marine				
	Safety SIL / PL				

## Selection guide pressure controller

		SCPSi	SCPSDi
<b>Pressure-range</b>	0...(bar) / (psi) relative		
	-1...bar / -14.5 (psi) relative		
	0...(bar) / (psi) absolut		
<b>Order qty.</b>			
<b>Accuracy</b>			
<b>Display</b>			•
<b>Output</b>	Switching	•	•
	IO-Link	•	•
	0,5...4,5 V (ratiometric 5V)		
	0,5...4,5 V (nominal 24V)		
	0...5 V		
	1...6 V		
	0...10 V		
	0...20 mA		•
	4...20 mA (3-wire)		
	4...20 mA (2-wire)		
CAN			
<b>Electrical Plug</b>	M12	•	•
	DIN EN 175301-803 Form A		•
	DIN Micro 9.4		
	AMP Superseal		
	Deutsch DT04 4-pin		
	Deutsch DT04 3-pin		
	Junior Timer		
	Cable 2m		
<b>Thread</b>	G1/4 BSPP ED	•	
	G 1/4 O-Ring		
	1/4 NPT		
	7/16-20 UNF		
	9/16-20 UNF		
<b>Wetted parts</b>	Stainless steel/ Soft sealing	<b>NBR</b>	<b>NBR</b>
	Stainless steel/ Metall sealing		•
<b>Approvals</b>	CE		•
	Marine		•
	Safety SIL / PL		

# Certified sensors and switches for maritime applications



The products designed for maritime use meet the current international approvals:

- **ABS** American Bureau of Shipping
- **DNV** Det Norske Veritas
- **GL** Germanischer Lloyd

The portfolio extends from pressure sensors to electronic switches with display for pressure / level / temperature. Parker offers the chance to upgrade from mechanical to electronic measuring devices in the hydraulic system, with the following advantages:

- |                 |                          |
|-----------------|--------------------------|
| ■ High accuracy | ■ Safety                 |
| ■ Long lifetime | ■ Comfortable functions  |
| ■ Reliability   | ■ High quality standards |

These certified products will enhance the safety and reliability of maritime hydraulic systems:

**SCPSD / SCLTSD / SCTSD-L**



## Pressure sensors

### Device features

- Long-term stability
- Immune to interference
- Rugged design
- Reliable



Pressure and temperature sensors

**SensoControl**® sensors feature long-term stability, interference immunity, a sturdy high-quality construction and a wide range of variants.

The sensors are designed and manufactured in our own production facilities under established standards for the industrial instrumentation and control systems. This allows us to easily adapt them to customer requirements or to critical applications.

We carefully consider the special requirements for automation and mobile hydraulics during the design phase. So our **SensoControl**® sensors are ideally suitable for the permanent series use in industrial and mobile applications.

### Pressure sensors

The housing and all parts of the pressure sensors that touch the substances are manufactured from stainless steel. This provides a large range of media tolerability. A wide range of applications is possible due to the combination of high interference immunity and high resistance to external influences (shock, vibration and temperature).

The application areas are varied: from process engineering test rigs, conveying and lifting equipment, mobile hydraulics, general machine construction, pneumatic construction and hydraulic plant construction.



The SCP should be used when the pressure needs to be monitored reliably for long periods.

In this case the optimal sensor type can be selected from different product series according to the needs of the application. Different connecting plugs, output signals and connection threads are also available.



# Pressure sensors - Overview

Pressure and temperature sensors

	SCP03	SCP04	SCP08
			
<b>Range of use</b>	Pressure sensor for mobile and industrial applications <ul style="list-style-type: none"> <li>Up to 1000 bar</li> <li>G1/4 DIN 3852-11 (E)</li> <li>Compact design</li> <li>Long term stability</li> <li>Wide temperature range -40...125°C</li> </ul>	Pressure sensor for hydrogen applications <ul style="list-style-type: none"> <li>Stainless steel measuring cell</li> <li>Small design</li> <li>Stainless steel housing</li> <li>Up to 1000 bar</li> <li>EC79/2009 (up to 600 bar)</li> <li>High protection degree</li> <li>Resistant to shock and vibration</li> </ul>	Pressure sensor for press construction and die-casting <ul style="list-style-type: none"> <li>250 / 400 / 600 / 1000 bar G1/4"</li> <li>0-10 V / 4...20 mA 2-wire</li> <li>M12x1 / DIN</li> <li>Reinforced internal design</li> <li>Persistence against shock &amp; vibration</li> <li>Made for high pressure acceleration</li> <li>High dynamic signal</li> </ul>
<b>Application</b>	<ul style="list-style-type: none"> <li>Mobile hydraulic</li> <li>Transport vehicles</li> <li>Conveyor vehicles</li> <li>Commercial vehicles</li> <li>Automotive technology</li> <li>Brake systems</li> <li>Oil pressure</li> <li>Test equipment and technology</li> <li>Gearbox control</li> </ul>	<ul style="list-style-type: none"> <li>Hydrogen applications</li> </ul>	<ul style="list-style-type: none"> <li>Press construction</li> <li>Die-casting</li> </ul>
<b>Order code</b>	SCP03-xxx-xx-xx	SCP04-xxx-xx-0xQ8	SCP08-xxxx-x4-0x
<b>Refer to page</b>	12-16	17-21	22-23



## SCPSi



<b>Range of use</b>	IO-Link Pressure sensor or switch <ul style="list-style-type: none"> <li>Pressure sensor / -switch</li> <li>Temperature measurement</li> <li>Industry 4.0-ready</li> <li>IO-Link 1.1</li> <li>Smart Sensor Profile 2<sup>nd</sup> edition</li> <li>Plug &amp; Play</li> <li>Compact</li> <li>Optimized design</li> <li>Adjustable via IO-link</li> <li>Readable via IO-Link</li> <li>Useable as IO-Link sensor or switch</li> <li>Monolithic pressure cell</li> </ul>
<b>Application</b>	<ul style="list-style-type: none"> <li>Injection-mould machines</li> <li>Tool-making machines</li> <li>Power packs</li> <li>Special machine construction</li> <li>Replacement for mechanical pressure switches</li> </ul>
<b>Order code</b>	SCPSi-xxx-04-07
<b>Refer to page</b>	38-40



## Pressure sensors - Overview

	SCP09	SCP10	SCP11
			
<b>Range of use</b>	<p>Pressure sensor for industrial applications, inc. injection molding</p> <ul style="list-style-type: none"> <li>Up to 600 bar</li> <li>G1/4 DIN 3852-11 (E)"</li> <li>0-10 V / 4...20 mA 2-wire</li> <li>M12x1 / DIN</li> <li>Reinforced internal design</li> <li>Extreme persistence against shock &amp; vibration</li> <li>Made for mid and high pressure acceleration</li> </ul>	<p>Pressure transmitter for use with liquid and gaseous media in hazardous areas</p> <ul style="list-style-type: none"> <li>Up to 1000 bar</li> <li>Monolithic design</li> <li>High media compatibility</li> <li>Negative pressure resistant</li> <li>ATEX approved</li> </ul>	<p>Pressure transmitter for chemical and physical requirements of hydrogen</p> <ul style="list-style-type: none"> <li>For Hydrogen</li> <li>Optimized media connections</li> <li>High media compatibility</li> <li>EC79/2009 (up to 600 bar)</li> <li>Negative pressure resistant</li> <li>Monolithic design</li> </ul>
<b>Application</b>	<ul style="list-style-type: none"> <li>Hydraulics and pneumatics</li> <li>Mobile hydraulics and Off-High-way Vehicles</li> <li>Pumps and Compressors</li> <li>Air Conditioning and Refrigeration Systems</li> <li>Plant Engineering and Automation</li> </ul>	<ul style="list-style-type: none"> <li>For explosive environment</li> <li>ATEX approved</li> <li>Universal applicable</li> <li>Mobile hydraulic</li> <li>Industrial hydraulic</li> <li>Off and onshore</li> </ul>	<ul style="list-style-type: none"> <li>Hydrogen application with ATEX approval</li> </ul>
<b>Order code</b>	SCP09-xxx-xx-xx	SCP10-xxx-xx-xx	SCP11-xxx-xx-xx
<b>Refer to page</b>	24-28	29-33	34-37

## SCP03 pressure sensor

### Device features

- Monolithic design
  - No internal seal
  - No material mix
  - No weld seam
- High media compatibility
- Measuring range from -1 to 1000 bar / -14.5 to 14,504 psi
- Negative pressure resistant
- Many connections



The SCP03 is a pressure sensor for liquid and gaseous media.

The digitally calibrated piezoresistive measuring cell detects negative pressures from -1 bar up to high pressures of 1000 bar.

The pressure connection in contact with the medium has a monolithic design. This eliminates the need for internal seals and weld seams. A mix of materials is avoided.

The resulting low permeability in combination with the stainless steel results in broad media resistance.

The compact stainless-steel housing allows space-saving use, even in harsh environmental conditions. With its wide range of pressure ranges, output signals and connectors, the SCP03 can be used in industrial and mobile applications.

The packaging variant optimized for OEM's is environmentally friendly, cost-optimized and facilitates handling.

### Typical application range

- Mobile hydraulics
- Transport vehicles
- Conveyor vehicles
- Commercial vehicles
- Automotive technology
- Brake systems
- Oil pressure
- Test equipment and technology
- Gearbox control

# SCP03 pressure sensor

## Technical data

SCP03-	004R	010R	010R	025R
Pressure range -1 ... bar	3	9	15	24
P <sub>n</sub> relative (-14.5 ... psi)	(43,5)	(130)	(218)	(348)

SCP03-	004	010	016	025	035	040	060	100	250	400	500	600	1000
Pressure range	4	10	16	25	35	40	60	100	250	400	500	600	1000
P <sub>n</sub> relative 0 ... bar / (psi)	(58)	(145)	(232)	(363)	(500)	(580)	(870)	(1450)	(3626)	(5800)	(7300)	(8702)	(14,504)
Overload pressure P <sub>max</sub> DIN EN 60770-1 (bar) relative	2 x P <sub>n</sub>											1,4 x P <sub>n</sub>	
Burst pressure P <sub>burst</sub> DIN EN 60770-1 (bar) relative	3 x P <sub>n</sub>											2 x P <sub>n</sub>	

SCP03-	0150P	0250P	1000P	3000P	5000P	9000P
Pressure range						
P <sub>n</sub> relative 0... (psi)	150	250	1000	3000	5000	9000
Overload pressure* P <sub>max</sub>	2 x P <sub>n</sub>					
Burst pressure** P <sub>burst</sub>	3 x P <sub>n</sub>					

### General

Response time	≤1 ms
Load change	> 100 million
Material Housing	EN/DIN 1.4301
Material Electr. Connector	PBT-GF30 black
Weight	Approx. 80 g

### Accuracy parameter

Non-linearity + Hysteresis + Repeatability	≤0.35 %FS
Long-term stability	≤ ± 0.25 %FS / year

### Overall Accuracy

	< 10 bar (145 psi)	≥ 10 bar (145 psi)
@ 25°C	≤ 0.5 %FS	≤ 0.5 %FS
-40°C bis 105°C	+2,5%	
@ 0°C...+85°C	≤ 2 %FS	≤ 1 %FS

### Ambient conditions

Media temperature	-40...+125 °C / (-40...257°F)
Operation / Ambient temperature	-40...+105 °C / (-40...221°F)
Storage temperature	-40...+125 °C / (-40...257°F)
Vibration resistance	IEC 60068-2-6: 20 g
Shock resistance	IEC 60068-2-27: 1000 g

### Conformity

CE	EN 61326-1 EN61326-3-1
RoHs	Yes
MTTFd	> 100 years

Process connection	Torque	Seal	Wetted parts
G1/4A BSPP; DIN 3852 T11, Form E	25 Nm	DIN 3869-14-FKM	EN/DIN 1.4404 / FKM
SAE-4: 7/16-20 UNF O-ring	25 Nm	FKM	EN/DIN 1.4404 / FKM
SAE 6: 9/16-18 UNF O-ring	25 Nm	FKM	EN/DIN 1.4404 / FKM
G1/4 DIN ISO 228-1 O-ring	25 Nm	FKM	EN/DIN 1.4404 / FKM
1/4 NPT	25 Nm		EN/DIN 1.4404



# SCP03 pressure sensor

Pressure and temperature sensors

## Pin assignment

Output signal	(2 wire) 4...20 mA	0...20 mA 4...20 mA	0.5...4.5 V 0...5 V	1...6 V 0...10 V	0.5...4.5 V ratio.
Supply Voltage $V_+$	10...32 VDC	12...32 VDC	8...32 VDC	12...32 VDC	5 V $\pm$ 10%
Load <sub>max</sub>	$\leq (V_+ - 10V) / 20 \text{ mA}$ [k $\Omega$ ]		4.7 [k $\Omega$ ]		
Overvoltage	50 VDC				
Short circuit	Yes				
Reverse polarity	Yes				
Signal on GND / $V_+$	Yes				
<b>M12x1 4-pole</b>					
Pin 1			$V_+$		
Pin 2			P-Signal		
Pin 3	n.c.			0 V / GND	
Pin 4	n.c.			n.c.	
IP65 (for $p \geq 60$ bar IP67)*					
<b>DIN EN 175301-803 Form A 4-pole (old 43650)</b>					
Pin 1			P-Signal		
Pin 2	n.c.			0 V / GND	
Pin 3			$V_+$		
Pin 4 / GND			n.c.		
IP54					
<b>AMP Superseal 1.5</b>					
Pin 1	P-Signal			0 V / GND	
Pin 2	n.c.			P-Signal	
Pin 3			$V_+$		
IP65 (for $p \geq 60$ bar IP67)*					
<b>DT04-4P</b>					
Pin 1			$V_+$		
Pin 2	P-Signal			0 V / GND	
Pin 3	n.c.			P-Signal	
Pin 4 / GND			n.c.		
IP65 (for $p \geq 60$ bar IP67)*					
<b>DT04-3P</b>					
A			$V_+$		
B	n.c.			P-Signal	
C	P-Signal			0 V / GND	
IP 67					
<b>Junior Timer</b>					
Pin 1	P-Signal			0 V / GND	
Pin 2	n.c.			P-Signal	
Pin 3			$V_+$		
IP65 (for $p \geq 60$ bar IP67)*					
<b>Cable</b>					
Bn			$V_+$		
Black			P-Signal		
Blue	n.c.			0 V / GND	
IP 67					

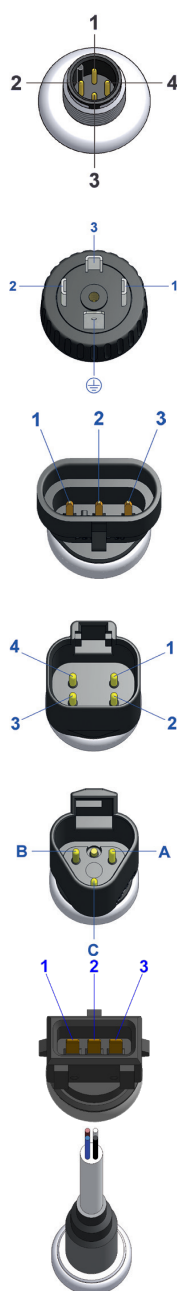

\*IP67 when plugged

# SCP03 pressure sensor

## Pin assignment

Connectors & Ports

### SCP03-...-x7

M12 4P

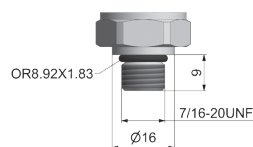

### SCP03-...-x6

DIN EN 175301-803

Form A

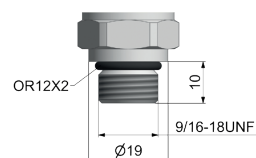

### SCP03-...-xD

DT04 4P

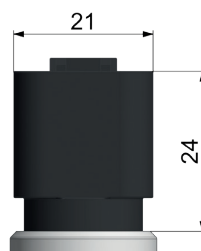

### SCP03-...-xE

DT04 3P

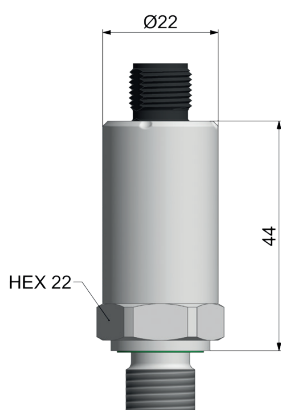
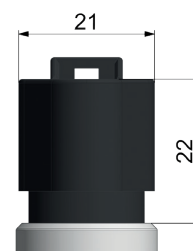

### SCP03-...-xA

Superseal

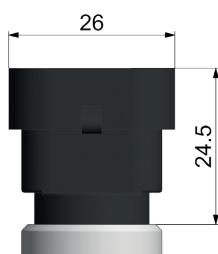

### SCP03-...-xJ

Junior Timer 3P

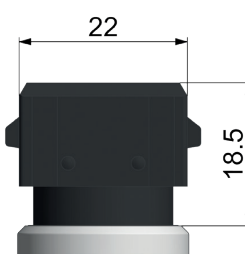

### SCP03-...-x0

Kabel

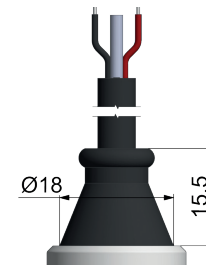

### SCP03-xxx-x6-xx

SAE 06 - O-ring

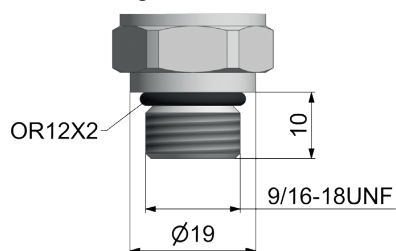

### SCP03-xxx-x7-xx

SAE 04 - O-ring

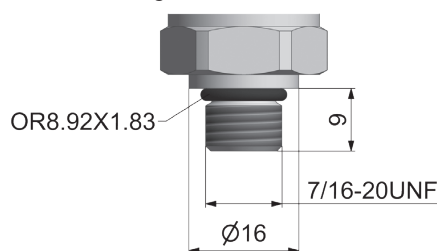

### SCP03-xxx-x5-xx

1/4 NPT

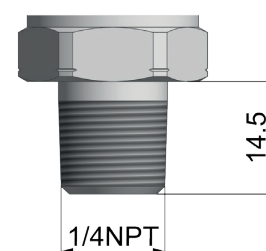

### SCP03-xxx-x4-xx

G 1/4, DIN 3852 T 11 (Form E)

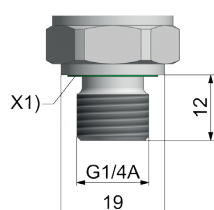

### SCP03-xxx-x8-xx

G 1/4, O-ring

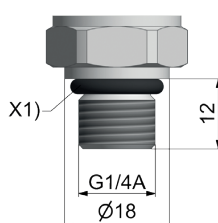

### SCP03-xxx-xx-Dx

G 1/4, with damping

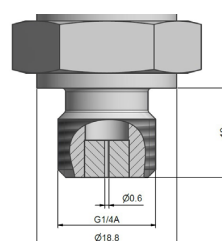

### SCP03-xxx-xx-xx

G 1/4, without damping

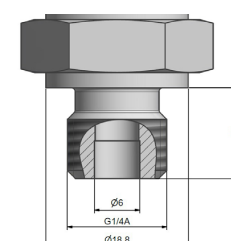

X1) = ED-Seal

X1) = O-ring



# SCP03 pressure sensor

## Order code

### Order quantity

Available single versions

#### Pressure sensor SCP03 Industrial SCP03-xxx-xx-Dx

##### Pressure range

0...10 bar	010
0...25 bar	025
0...60 bar	060
0...250 bar	250
0...400 bar	400
0...600 bar	600

##### Output signal

4...20 mA (3-wire)	2
4...20 mA (2-wire)	3
0...10 V	4

##### Process connection

G1/4 BSPP	4
-----------	---

With damping D

##### Connecting plug

Device connector DIN EN 175301-803 Form A 4-pole	6
Circular connector M12x1 4-pole	7

#### Pressure sensor SCP03 Mobile SCP03-xxx-xx-Dx

##### Pressure range

0...10 bar	010
0...25 bar	025
0...60 bar	060
0...250 bar	250
0...400 bar	400
0...600 bar	600

##### Output signal

4...20 mA (2-wire)	3
0.5...4.5 V (ratiometric)	R

##### Process connection

G1/4 BSPP	4
-----------	---

With damping D

##### Connecting plug

Device plug DT04 4 pole	D
-------------------------	---

## Order example

### 150x SCP03-400-34-07Q8

150 Single sensors (multiple of 50's)

Pressure range 0...400 bar

Output signal 4 to 20 mA (2-wire)

G1/4 BSPP

Without damping

M12 connecting plug 4-pole



## Pressure sensor SCP03

## SCP03-xxx-xx-xxQ8

### Pressure range

-1...3 bar	004R
-1...9 bar	010R
-1...15 bar	016R
-1...24 bar	025R
0...4 bar	004
0...10 bar	010
0...16 bar	016
0...25 bar	025
0...35 bar	035
0...60 bar	060
0...100 bar	100
0...160 bar	160
0...250 bar	250
0...400 bar	400
0...500 bar	500
0...600 bar	600
0...1000 bar	1000
0...150 psi	0150P
0...250 psi	0250P
0...1000 psi	1000P
0...3000 psi	3000P
0...5000 psi	5000P
0...9000 psi	9000P

### Output signal

0...20 mA	1
4...20 mA (3-wire)	2
4...20 mA (2-wire)	3
0...10 V	4
0...5 V	A
1...6 V	B
0.5...4.5 V (ratiometric)	R
0.5...4.5 V (nom.)	S

### Process connection

G1/4 BSPP	4
1/4 NPT (P <sub>n</sub> max. = 600 bar)	5
9/16-18 UNF, SAE 6 O-ring (P <sub>n</sub> max. = 400 bar)	6
7/16-20 UNF SAE-4 O-ring (P <sub>n</sub> max. = 400 bar)	7
G1/4 O-ring (P <sub>n</sub> max. = 600 bar)	8

### Damping

Without damping	0
With damping	D

### Connecting plug

Device connector DIN EN 175301-803 Form A 4-pole	6
Circular connector M12x1 4-pole	7
Stationary cable 2 m	0
Device plug AMP Superseal	A
Device plug DT04 4 pole	D
Device plug DT04 3 pole	E
Junior Timer 3-pole	J

### Minimum order qty:

Q8: Multiple of 50 pcs.

## SCP04 pressure sensor

### Device features

- Monolithic design
  - No internal seal
  - No material mix
  - No weld seam
- EC79/2009 approved (up to 600 bar)
- High media compatibility (hydrogen)
- Up to 1000 bar (up to 14,504 psi)
- Negative pressure resistant
- Special connections



The SCP04 pressure sensor is designed to meet the chemical and physical requirements of hydrogen applications.

The digitally calibrated piezoresistive stainless steel measuring cell detects pressures up to 1000 bar. The connection to the sensing elements is made via a special bonding and thus remains stable even at low temperatures, shocks or vibrations.

The measuring cell and the pressure connection in contact with the medium are made in one piece. This eliminates the need for internal seals and weld seams. A mix of materials is avoided. The construction was designed to prevent embrittlement of the metal surface by ionized hydrogen.

The monolithic design eliminates leakage due to material fatigue at internal seals. The SCP04 has no pressure transfer fluid, no large pressurized areas, and is vacuum-tight and elastomer-free.

The resulting low permeability in combination with the stainless steel results in a wide media resistance. The process connections have been designed to be gasket-free for hydrogen applications.

The compact stainless steel housing allows space-saving use, even under harsh environmental conditions.

### Typical application range

- Hydrogen applications

# SCP04 pressure sensor

## Technical data

SCP04-	004	025	400	500	600	1000
Pressure range P <sub>n</sub> relative 0 ... bar / (psi)	4 (58)	25 (363)	400 (5800)	500 (7300)	600 (8702)	1000 (14,504)
Overload pressure P <sub>max</sub> DIN EN 60770-1 (bar) relative	2 x P <sub>n</sub>					1,4 x P <sub>n</sub>
Burst pressure P <sub>burst</sub> DIN EN 60770-1 (bar) relative	3 x P <sub>n</sub>					2 x P <sub>n</sub>

General		
Response time	≤1 ms	
Load change	> 10 million	
Material Housing	EN/DIN 1.4301	
Weight	Approx. 120 g	
MTTFd	> 100 years	
Accuracy parameter		
BFSL: Non-linearity, Zero-point error, Hysteresis, Repeatability	≤0.35 %FS	
Limit-point setting	≤0.5 %FS	
Resolution	FS/1500 digit	
Long-term stability	≤0.3 %FS / year	
Overall Accuracy		
	< 10 bar (145 psi)	≥ 10 bar (145 psi)
@ 25°C	≤0.5 %FS	≤0.5 %FS
@ -5°C...+85°C	≤2 %FS	≤1.5 %FS
@ -40°C...+105°C	≤3 %FS	≤2 %FS

Ambient conditions	
Media temperature	-40...+125 °C / (-40...257°F)
Operation / Ambient temperature	-40...+105 °C / (-40...221°F)
Storage temperature	-40...+125 °C / (-40...257°F)
Vibration resistance	IEC 60068-2-6: 20 g
Shock resistance	IEC 60068-2-27: 100 g
Conformity	
CE	EN 61326-1 EN 61326-2-3
RoHs	2011/65/EU

Process connection	Torque	Wetted parts
7/16"-20UNF-2A	25 Nm	316L; EN/DIN 1.4404 / FKM
9/16"-18UNF-2A	35 Nm	316L; EN/DIN 1.4404 / FKM
9/16"-18UNF-2A / 59°	25 Nm	316L; EN/DIN 1.4404
G1/4 B (EN 837)	25 Nm	316L; EN/DIN 1.4404
1/4 NPT	25 Nm	316L; EN/DIN 1.4404

# SCP04 pressure sensor

## Pin assignment

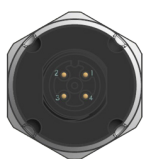

M12x1 (S763)



DIN EN 175301-803 Form A



DT04-3P

Output signal	(2 wire) 4...20 mA	0...10 V	0.5...4.5 V ratio.
Supply Voltage $V_+$	10...32 VDC	12...32 VDC	5 V $\pm$ 10%
Load <sub>max</sub>	$\leq (V_+ - 10V) / 20 \text{ mA}$ [k $\Omega$ ]		4,7 [k $\Omega$ ]
Overvoltage	50 VDC		
Short circuit	Yes		
Rever polarity	Yes		
Signal on GND / $V_+$	Yes		
<b>M12x1 4-pole</b>			
Pin 1	$V_+$		
Pin 2	P-Signal		
Pin 3	n.c.	0 V / GND	
Pin 4	n.c.	n.c.	
IP65 (for $p \geq 50 \text{ bar}$ IP67)*			
<b>DIN EN 175301-803 Form A 4-pole (old 43650)</b>			
Pin 1	P-Signal		
Pin 2	n.c.	0 V / GND	
Pin 3	$V_+$		
Pin 4 / GND	n.c.		
IP 54			
<b>DT04-3P</b>			
A	$V_+$		
B	n.c.	P-Signal	
C	P-Signal	0 V / GND	
IP 67			

\*IP67 when plugged

# SCP04 pressure sensor

Pressure and temperature sensors

## Pin assignment

Connectors & Ports

### SCP04-...-07

M12 4P

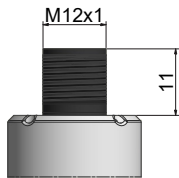

### SCP04-...-06

DIN EN 175301-803

Form A

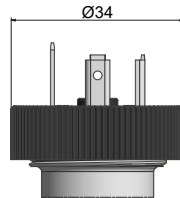

### SCP04-...-0E

DT04 3P

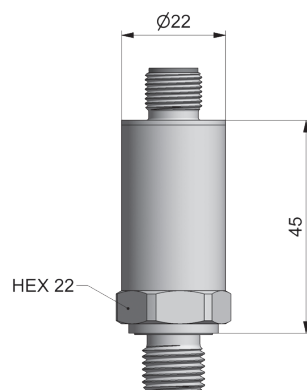
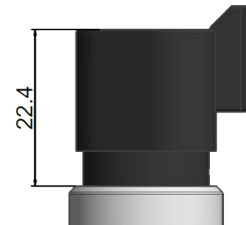

### SCP04-xxx-x7-0x

7/16"-20UNF-2A

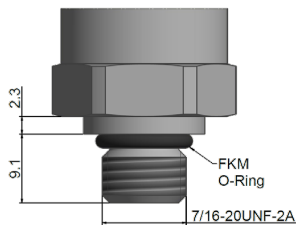

### SCP04-xxx-x6-0x

9/16"-18UNF-2A

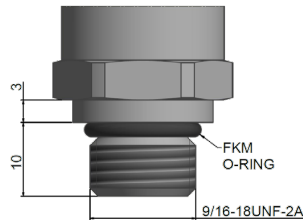

### SCP04-xxx-x6M-0x

9/16"-18UNF-2M / 59°

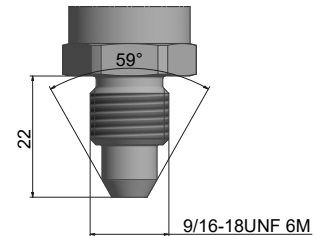

### SCP04-xxx-xA-0x

G 1/4 B (EN 837)

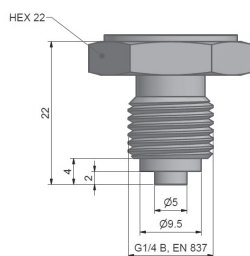

### SCP04-xxx-x5-0x

1/4 NPT

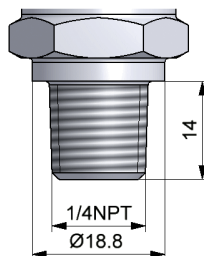

# SCP04 pressure sensor

## Order code

Pressure sensor SCP04	SCP04-xxx-xx-0xQ8
<b>Pressure range (bar)</b>	
0...4 bar	004
0...25 bar	025
0...400 bar	400
0...500 bar	500
0...600 bar	600
0...1000 bar**	1000
<b>Output signal</b>	
4...20 mA (2-wire)	3
0...10 V	4
0.5...4.5 V (ratiometric)	R
<b>Process connection</b>	
G1/4 B (EN 837)	A
1/4 NPT	5
7/16"-20UNF-2A	7
9/16"-18UNF-2A	6
9/16"-18UNF-2A / 59°	M
<b>Connecting plug</b>	
Device connector DIN EN 175301-803 Form A 4-pole	6
Circular connector M12x1 4-pole	7
Device plug DT04 3 pole	E
<b>Minimum order qty:</b>	
Q8: Multiple of 50 pcs.	

### Additional Variances

Individual Pressure-ranges / calibration	available
Additional Ports	available
Individual Pin configuration	available
Brand label	available

\*Up to EC79 600 bar approved

\*\*Only thread 9/16"-18UNF-2M / 59°

## Pressure sensor SCP08 for presses

### Device features

- 250 / 400 / 600 / 1000 bar  
(3,626 / 5,802 / 8,702 / 14,504 psi)
- G1/4"
- 0-10V / 4...20mA 2-wire
- M12x1 / DIN
- Reinforced internal design
- Persistence against shock & vibration
- Made for high pressure acceleration
- High dynamic signal



Particularly in die-casting applications the controlling for the piston requires a high dynamic pressure sensor. During this fast, high energetic process the components are stressed by shock, vibration and pressure acceleration.

The pressure sensor SCP08 measures the pressure via a special designed measurement cell and has a high adapted overload pressure to withstand the pressure peaks.

To avoid abrasion of the cell due to Diesel or similar effects, the process connection is protected by an adjusted drilling. The dimension of the drilling still guaranties an instantaneous pressure response.

To increase shock and vibration resistance, the relevant internal components are covered and reinforced. The speed of the sensor influences directly the quality of the production process.

The unique combination of accuracy, durability and high dynamic response makes the SCP08 ideal for the requirements of die-casting applications.

### Typical applications

- Press construction
- Die-casting

# Pressure sensor SCP08

## Technical data

SCP08-	250	400	600	1000
Pressure range P <sub>n</sub> 0... bar / (psi) relative	250 (3626)	400 (5802)	600 (8702)	1000 (14,504)
Overload pressure P <sub>max</sub> bar / (psi) relative	1000 (14,504)	1200 (17,405)	1200 (17,405)	1500 (21,756)
Burst pressure P <sub>burst</sub> bar / (psi) relative	1500 (21,756)	1500 (21,756)	1800 (26,107)	2000 (29,008)

### General

Response time	0...10 V ≤0,3 ms 4...20 mA 2-Leiter ≤0,5 ms*
---------------	---

Load change	>10 million.
-------------	--------------

Material Housing	Stainless steel 304
------------------	---------------------

Weight	Approx. 80 g
--------	--------------

### Ambient Conditions

Media temperature	-40...125°C / (-40...257°F)
-------------------	-----------------------------

Operation- / Ambient temperature	-40 to 105°C / (-40...221°F)
----------------------------------	------------------------------

Storage temperature	-40 to 125°C / (-40...257°F)
---------------------	------------------------------

Vibration	20 g rms
-----------	----------

Shock	1 m on concrete
-------	-----------------

### Conformity

CE	yes
----	-----

### Overall Accuracy

@ RT *1	≤0,5 %FS
---------	----------

@ -10°C...85°C *1 *2	≤2 %FS
----------------------	--------

@ -40...105°C *1 *2	≤2,5 %FS
---------------------	----------

Long-term stability	≤0,2 %FS / year
---------------------	-----------------

\*1 incl. Non-linearity + Hysteresis + Offset + Gain

\*2 incl. Repeatability + Temperature effects

RT = Room Temperature 20°C

### Process Connection

Thread	G1/4, DIN 3852 T11 (E)
--------	------------------------

Eroding milling	0,6 mm
-----------------	--------

Volume measured	<1 mm <sup>3</sup>
-----------------	--------------------

Seal	ED Type: FKM
------	--------------

Material	Stainless steel 17-4 PH
----------	-------------------------

Material diaphragm	Stainless steel 17-4 PH
--------------------	-------------------------

Wetted parts	FKM Stainless steel 17-4 PH
--------------	-----------------------------

### Installation

Installation torque	Max. 35 Nm
---------------------	------------

General	no restriction
---------	----------------

Recommended preventive activities to avoid air inclusion:

- Bleed air
- Installation with Process connection on top

\*with 2 m cable



Output signal	0...10 V	4...20 mA 2-wire
Supply voltage V <sub>+</sub>	12...32 VDC	10...32 VDC
Load <sub>max</sub>	10 kΩ	(V <sub>+</sub> - 10 V) / 20 mA
Protection	Overvoltage	36 signal on GND/V <sub>+</sub>
	Short circuit	yes
	Reverse polarity	yes
	Signal on GND/V <sub>+</sub>	yes

### M12x1

Protection class (mounted connector)	IP67	0...10 V	4...20 mA 2-wire
	Pin 1	V <sub>+</sub>	V <sub>+</sub>
	Pin 2	P-signal	P-signal
	Pin 3	V <sub>-</sub>	Do not connect
	Pin 4	Do not connect	Do not connect

### DIN EN 175301-803 Form A

Protection class (mounted connector)	IP65	0...10 V	4...20 mA 2-wire
	Pin 1	V <sub>+</sub>	V <sub>+</sub>
	Pin 2	V <sub>-</sub>	P-signal
	Pin 3	P-signal	Do not connect
	Pin 4	Do not connect	Do not connect

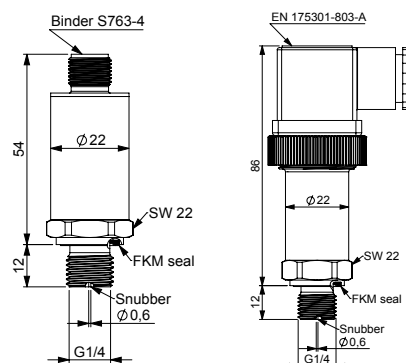

## Order code

### Pressure sensor SCP-08

4...20 mA; 2-wire

### Pressure range (bar)

0...250 bar	250
0...400 bar	400
0...600 bar	600
0...1000 bar	1000

### Output signal

4...20 mA (2-wire)	3
0...10V	4

### Connecting plug

DIN EN 175301-803 Form A 4 pole	6
M12x1 4 pole	7

### Order quantity

Q2: Multiple of 5 pcs.

Q8: Multiple of 50 pcs.

SCP08-xxxx-x4-0xQ

## Pressure sensor SCP09

### Device features

- Measuring range
  - from 0-10 bar to 0-600 bar  
(0-145 psi to 0-8700 psi)
- Wide range of
  - Ports
  - Connectors
  - Electrical outputs
- Stainless steel design
- Hermetic port
- Storage and operating media temperature
  - -40 to 125°C
- Operating ambient temp. range
  - -40 to 100°C
- Snubber option
- REACH/RoHS/CE/UKCA



The SCP09 pressure sensor is the ideal solution for customers with challenging measuring requirements for general industrial applications in the mid and high pressure ranges. The SCP09 features a wide range of ports, connectors, and analog electrical outputs for ease of integration in various industrial applications.

The SCP09's high quality stainless steel design features a hermetic port with no internal O-ring seals making it compatible with most media and suitable for harsh environments. With extreme shock and vibration capabilities, a wide operating temperature range, and high proof and burst pressures; the SCP09 is ideal for industrial applications including injection molding, CO<sub>2</sub>, HVAC systems, and other hydraulic or pneumatic applications.

For dampening of pressure spikes due to hammer and cavitation a optional damping (Snubber) can be provided.

### Typical applications

- Hydraulics and Pneumatics
- Mobile Hydraulics and Off-Highway Vehicles
- Pumps and Compressors
- Air Conditioning and Refrigeration Systems
- Plant Engineering and Automation

# Pressure sensor SCP09

## Technical data

SCP09-	010	016	025	040	050	060	100	160	200	250	350	400	500	600
Pressure range P <sub>n</sub> relative 0 ... bar / (psi)	10 (145)	16 (232)	25 (363)	40 (580)	50 (725)	60 (870)	100 (1450)	160 (2321)	200 (2901)	250 (3626)	350 (5076)	400 (5802)	500 (7252)	600 (8702)
Overload pressure P <sub>max</sub> DIN EN 60770-1 (bar) relative	60 (870)	60 (870)	60 (870)	200 (2901)	200 (2901)	200 (2901)	200 (2901)	500 (7252)	500 (7252)	500 (7252)	800 (11603)	800 (11603)	1200 (17405)	1200 (17405)
Burst pressure P <sub>burst</sub> DIN EN 60770-1 (bar) relative	200 (2901)	200 (2901)	200 (2901)	2000 (29008)	2000 (29008)	2000 (29008)	2000 (29008)	2500 (36259)	2500 (36259)	2500 (36259)	4000 (58015)	4000 (58015)	4000 (58015)	4000 (58015)

General	
Response time	≤2 ms
Durability	> 10 million
Accuracy parameter	
Basic Accuracy IEC 61298-2 (Non-linearity + Hysteresis + zero & span)	± 0.5 %FS @ 25°C
BFSL Accuracy IEC 60770-1 (Non-linearity + Hysteresis + repeatability, excluding zero & span)	± 0.25 %FS @ 25°C
Non-linearity BFSL	± 0.2 % FS
Non-repeatability	± 0.1 % FS
Overall Accuracy	
@ -20°C...+85°C	± 1.5 %FS
Ambient conditions	
Media temperature	-40...+125 °C / (-40...257°F)
Operation temperature	-40...+100 °C / (-40...212°F)
Storage temperature	-40...+125 °C / (-40...257°F)
Vibration resistance	IEC 60068-2-6: 30 g (10...2000Hz)
Shock resistance	IEC 60068-2-27: 500 g
Conformity	
CE Emission / Immunity	EN 61326
RoHs / REACH	Yes
UKCA	Yes
Radiated Immunity	100V/m @80...200MHz 200V/m @200...2700MHz

Process connection	Torque	Seal	Wetted parts
G1/4A DIN3852 T11, Form E	25 Nm	FKM	17-4PH EN/DIN 1.4542 ; FKM
7/16-20 UNF-2A J1926-3 O-ring	25 Nm	HNBR	17-4PH EN/DIN 1.4542 ; HNBR
1/4-19 PT (BSPT) (R1/4)	25 Nm	–	17-4PH EN/DIN 1.4542
1/4-18 NPTF	25 Nm	–	17-4PH EN/DIN 1.4542



# Pressure sensor SCP09

Pressure and temperature sensors

## Pin assignment

Output signal	(2 wire) 4...20 mA	0.5...4.5 V 0...5 V 1...5 V	0...10 V	0.5...4.5 V ratio.
Supply Voltage $V_+$	8...32 VDC	8...32 VDC	12...32 VDC	5 V $\pm$ 0.25 VDC
Overtoltage	36 VDC	36 VDC	36 VDC	–
Short circuit	–	Yes	Yes	Yes
Reverse polarity	Yes	Yes	Yes	Yes
Load <sub>max</sub>	$\leq (V_+ - 8V) / 20mA$ [k $\Omega$ ]	$\geq 4.7$ [k $\Omega$ ]	$\geq 4.7$ [k $\Omega$ ]	$\geq 4.7$ [k $\Omega$ ]
<b>M12x1 4-pole</b>				
Pin 1	$V_+$	$V_+$	$V_+$	$V_+$
Pin 2	n.c.	n.c.	n.c.	n.c.
Pin 3	P-Signal	0 V / GND	0 V / GND	0 V / GND
Pin 4	n.c.	P-Signal	P-Signal	P-Signal
IP 67				
<b>DIN EN 175301-803 Form A 4-pole (old 43650)</b>				
Pin 1	$V_+$	$V_+$	$V_+$	$V_+$
Pin 2	P-Signal	0 V / GND	0 V / GND	0 V / GND
Pin 3	n.c.	P-Signal	P-Signal	P-Signal
Pin 4 / GND	n.c.	n.c.	n.c.	n.c.
IP 65				
<b>DT04-3P</b>				
A	$V_+$	$V_+$	$V_+$	$V_+$
B	P-Signal	0 V / GND	0 V / GND	0 V / GND
C	n.c.	P-Signal	P-Signal	P-Signal
IP 67				
<b>Metri-Pack 150</b>				
A	P-Signal	0 V / GND	0 V / GND	0 V / GND
B	$V_+$	$V_+$	$V_+$	$V_+$
C	n.c.	P-Signal	P-Signal	P-Signal
IP 67				

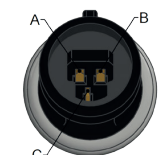
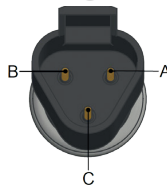
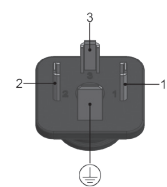
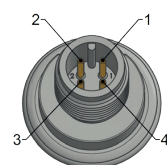

# Pressure sensor SCP09

## Pin assignment Connectors & Ports

Pressure and temperature sensors

**SCP09-...-...-07**  
M12 4P

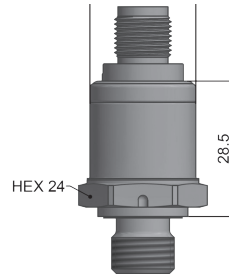

**SCP09-...-...-07**  
M12x1 4-pole

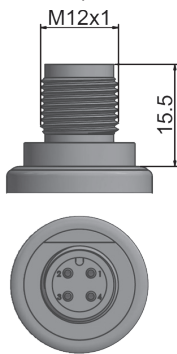

M12 4P

**SCP09-...-...-06**  
DIN EN 175301-803 - Form A



DIN EN 175301-803  
FORM A

**SCP09-...-...-0E**  
DT04 3P

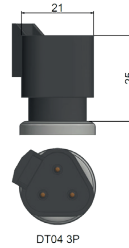

DT04 3P

**SCP09-...-...-0P**  
Packard Metri Pack 150

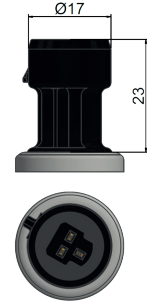

Packard Metri Pack 150

**SCP09-xxx-x4-xx**  
G 1/4, DIN 3852 T 11 (Form E)

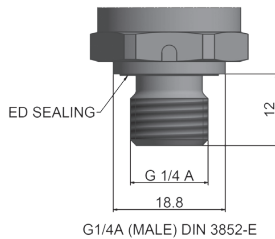

G1/4A (MALE) DIN 3852-E

**SCP09-xxx-x7-xx**  
7/16-20 UNF-2A

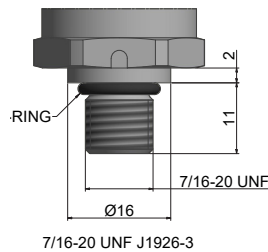

7/16-20 UNF J1926-3

**SCP09-xxx-xR-xx**  
1/4-19PT (R1/4)

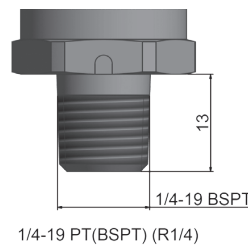

1/4-19 PT(BSPT) (R1/4)

**SCP09-xxx-x5-xx**  
1/4-18NPT

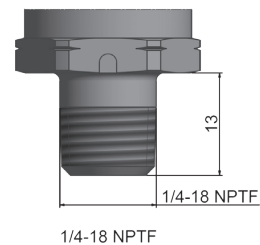

1/4-18 NPTF

### Optional with damping (Snubber)

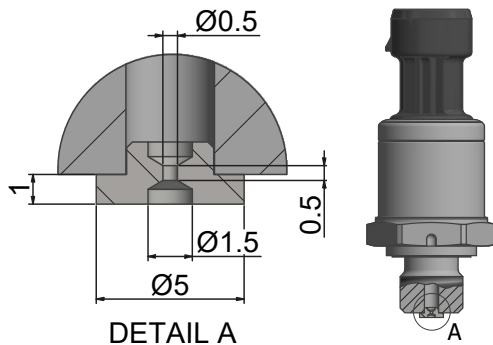

DETAIL A



# Pressure sensor SCP09

Pressure and temperature sensors

## Order code

Pressure sensor SCP09	SCP09-xxx-xx-xxQ
<b>Pressure range</b>	
0...10 bar	010
0...16 bar	016
0...25 bar	025
0...40 bar	040
0...50 bar	050
0...60 bar	060
0...100 bar	100
0...160 bar	160
0...250 bar	250
0...350 bar	350
0...400 bar	400
0...500 bar	500
0...600 bar	600
<b>Output signal</b>	
4...20 mA (2-wire)	3
0...10 V	4
0...5 V	A
1...5 V	D
0.5...4.5 V @ 5±0.25VDC (ratiometric)	R
0.5...4.5 V @ 8-32VDC (nom.)	S
<b>Process connection</b>	
G1/4A DIN 3852-E	4
1/4-18 NPT	5
7/16-20 UNF -2A	7
1/4 -19PT (R1/4)	R
<b>Damping</b>	
Without damping	0
With damping	D
<b>Connecting plug</b>	
Device connector DIN EN 175301-803 Form A 4-pole	6
Circular connector M12x1 4-pole	7
DT04 3 pole	E
Packard	P
<b>Order quantity:</b>	
Q8: Multiple of 50 pcs.	
Q10: Multiple of 500 pcs.	

## Pressure transmitter SCP10

### Device features

- ATEX
  - II 1G Ex ia IIC T4 Ga
  - II 2G Ex ia IIC T4 Gb
  - II 1G Ex ia IIB T4 Ga
- Monolithic design
  - No internal seal
  - No material mix
  - No weld seam
- High media compatibility
- Up to 1000 bar
- Negative pressure resistant



The intrinsically safe pressure sensor SCP10 has been specially developed for use with liquid and gaseous media in hazardous areas. It fulfills the requirements for conditions in:

Zone 0: II 1G Ex ia IIC T4 Ga

II 1G Ex ia IIB T4 Ga

Zone 1: II 2G Ex ia IIC T4 Gb

This sensor ensures maximum safety in critical environments.

The digitally calibrated piezoresistive stainless steel measuring cell detects pressures from 4 bar up to 1000 bar. The connection to the sensing elements is made via a special bonding and therefore remains stable even at low temperatures, shocks or vibrations.

The measuring cell and the pressure connection in contact with the medium are made from a single piece. This eliminates the need for internal seals and weld seams. A mix of materials is avoided.

Due to the monolithic design, leaks caused by material fatigue at joints are excluded by design.

The SCP10 has no pressure transmission fluid, no large pressurized surfaces and is absolutely vacuum-tight and elastomer-free.

The resulting low permeability in combination with the stainless steel results in broad media resistance.

The compact stainless steel housing enables space-saving use, even in harsh environmental conditions.

With the wide range of pressure ranges, output signals and connectors, the SCP10 can be used in industrial and mobile applications.

# Pressure transmitter SCP10

## Technical data

SCP10-	004	010	016	025	060	100	250	400	600	1000
Pressure range 0... bar P <sub>n</sub> relative 0... (psi)	4 (580)	10 (145)	16 (232)	25 (362)	60 (870)	100 (1450)	250 (3625)	400 (5801)	600 (8702)	1000 (14503)
Overload pressure P <sub>max</sub> (bar) relative	8	20	32	50	120	200	500	800	1200	1400
Burst pressure P <sub>burst</sub> (bar) relative	12	30	48	75	180	500	1000	1400	1800	2000

### Accuracy

Long-term stability	± 0.5 %FS @ 25°C	
Overall Accuracy	@ 25°C	≤ ± 0,5 %FS
	@ -5°C ...+85°C	≤ ± 1.5 %FS
	@ -40°C...+85 °C	≤ ± 2.5 %FS

### General

Response time	≤2 ms
Pressure cycles	> 100 million
Material Housing	EN/DIN 1.4301
Weight	Approx. 100 g
RoHs	Yes
MTTFd	>100 years

### ATEX

M12 metallic connector	II 1G Ex ia IIC T4 Ga
Other connector	II 1G Ex ia IIB T4 Ga II 2G Ex ia IIC T4 Gb
Certificate	IBExU24ATEX1042 EN IEC 60079-0 EN 60079-11

### Ambient conditions

Media temperature	-40 to 100 °C (-40 to 212 °F)
Operation / Ambient temperature	
Zone 0	-20 to 60 °C
Zone 1 / 2	-40 to 85 °C (-40 to 185 °F)
Storage temperature	-40 to 85 °C (-40 to 185 °F)
Vibration	IEC 60068-2-6: 20 g / 3 axes
Shock	IEC 60068-2-31 (1m free fall)
CE emission	EN 61326-1:2013 - section 7 EN 61326-2-3:2013
CE susceptibility	EN 61326-1:2013 - section 6 EN 61326-2-3:2013

Process connection	Torque	Seal	Wetted parts
7/16-20UNF-2A	25 Nm	FKM	316L (EN/DIN 1.4404) / FKM
9/16-18UNF-2A	35 Nm	FKM	316L (EN/DIN 1.4404) / FKM
G1/4 Form E	25 Nm	FKM	316L (EN/DIN 1.4404) / FKM
G1/4 O-ring	25 Nm	FKM	316L (EN/DIN 1.4404) / FKM
G1/4 B	25 Nm	none	316L (EN/DIN 1.4404)
¼ NPT	25 Nm	none	316L (EN/DIN 1.4404)



# Pressure transmitter SCP10

## Electrical Connection



Output signal	4...20 mA (2wire)
Supply Voltage $V_+$	20 ... 27 VDC
Load <sub>max</sub>	$< (V_{cc}-10 V) / 20 \text{ mA}$
Current consumption	3.6 ... 21.4 mA
Reverse polarity	Yes
Overvoltage protection	Yes
<b>M12x1 4-pole</b>	
Pin 1	V+
Pin 2	P-Signal
Pin 3	n.c.
Pin 4	n.c.
Protection Class (connected)	IP 67
ATEX	II 1G Ex ia IIC T4 Ga
<b>DT04-3P</b>	
A	V+
B	n.c.
C	P-Signal
Protection Class (connected)	IP 67
ATEX	II 2G Ex ia IIC T4 Gb
	II 1G Ex ia IIB T4 Ga
<b>DIN EN 175301-803 Form A 4-pole</b>	
1	P-Signal
2	n.c.
3	V+
GND	n.c.
Protection Class (connected)	IP 65
ATEX	II 2G Ex ia IIC T4 Gb
	II 1G Ex ia IIB T4 Ga
<b>Conduit</b>	
Red	V+
Black	P-Signal
Protection Class (connected)	IP68
ATEX	II 2G Ex ia IIC T4 Gb
	II 1G Ex ia IIB T4 Ga
<b>Cable</b>	
Red	V+
Black	P-Signal
Protection Class (connected)	IP 67
ATEX	II 2G Ex ia IIC T4 Gb
	II 1G Ex ia IIB T4 Ga

# Pressure transmitter SCP10

Pressure and temperature sensors

## Drawings

**M12x1**  
Metallic

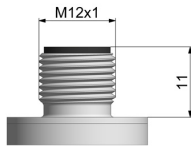

**EN 175301**

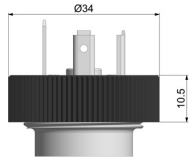

**DT04**  
3pole

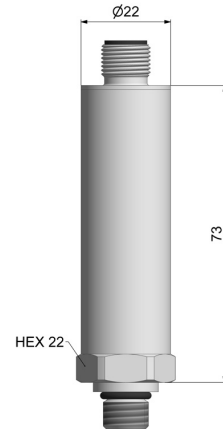
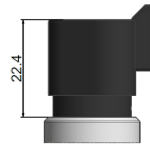

**Cable (2m)**

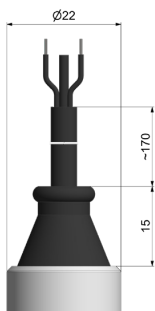

**Conduit**  
1/2"-14 NPT (2m)

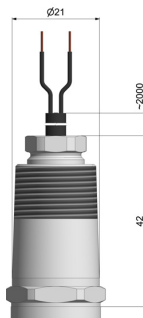

**G1/4"A Form E**  
DIN EN ISO 1179-2

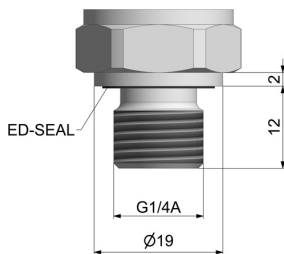

**1/4"-18 NPT**

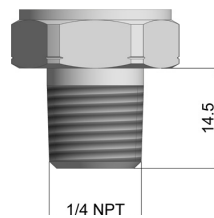

**9/16-18UNF-2A**

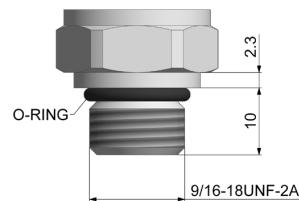

**7/16-20UNF-2A**

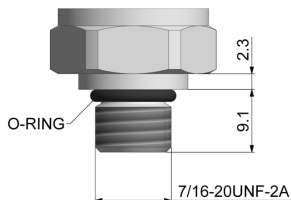

**G1/4"A Form G**  
DIN EN ISO 1179-3

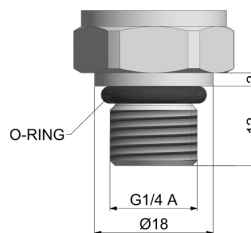

**G1/4"B**  
EN 827

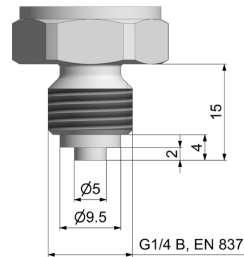

**Snubber**

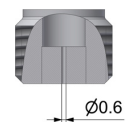

# Pressure transmitter SCP10

## Order code

Pressure sensor SCP10	SCP10-xxx	-3x	-x	x	EXi0S
<b>Pressure range</b>					
0...4 bar	004				
0...10 bar	010				
0...16 bar	016				
0...25 bar	025				
0...60 bar	060				
0...100 bar	100				
0...250 bar	250				
0...400 bar	400				
0...600 bar	600				
0...1000 bar	1000				
<b>Output signal</b>					
4...20 mA (2-wire)		3			
<b>Process connection</b>					
G1/4"A DIN EN ISO 1179-2 Form E		4			
1/4-18 NPT		5			
9/16-18UNF-2A		6			
7/16-20UNF-2A		7			
G1/4"A DIN EN ISO 1179-3 Form G		8			
G1/4"B EN 827		A			
<b>Damping</b>					
Without damping			0		
With damping				D	
<b>Connecting plug</b>					
Cable 2m				0	
Cable 5m				005	
Cable 10m				010	
DIN EN 175301-803 Form A 4-pole					6
M12x1 4-pole metallic					7
DT04 3pole					E
Conduit 1/2"-14 NPT (2m)					K

Pressure and temperature sensors

## Pressure transmitter SCP11

### Device features

- ATEX
  - II 1G Ex ia IIC T4 Ga
  - II 2G Ex ia IIC T4 Gb
- Monolithic design
  - No internal seal
  - No material mix
  - No weld seam
- EC79/2009 (up to 600 bar)
- High media compatibility (hydrogen)
- Up to 1000 bar
- Negative pressure resistant
- Special connections



The intrinsically safe SCP11 pressure sensor is designed to meet the chemical and physical requirements of hydrogen applications. It fulfills the requirements for conditions in:

Zone 0: II 1G Ex ia IIC T4 Ga

Zone 1: II 2G Ex ia IIC T4 Gb

This sensor ensures maximum safety in critical environments.

The digitally calibrated piezoresistive stainless steel measuring cell detects pressures from 4 bar up to 1000 bar. The connection to the sensing elements is made via a special bonding and thus remains stable even at low temperatures, shocks or vibrations.

The measuring cell and the pressure connection in contact with the medium are made in one piece. This eliminates the need for internal seals and weld seams. A mix of materials is avoided. The construction was designed to prevent embrittlement of the metal surface by ionized hydrogen.

The monolithic design eliminates leakage due to material fatigue at internal seals.

The SCP11 has no pressure transfer fluid, no large pressurized areas, and is vacuum-tight and elastomer-free.

The resulting low permeability in combination with the stainless steel results in a wide media resistance. Specifically for hydrogen applications, a seal-free process connection has been implemented.

The compact stainless steel housing allows space-saving use, even under harsh environmental conditions.

# Pressure transmitter SCP11

## Technical data

SCP11-	004	025	400	500	600	1000
Pressure range 0... (bar) P <sub>n</sub> relative 0 ... (psi)	4 (58)	25 (363)	400 (5800)	500 (7300)	600 (8702)	1000*1 (14503)
Overload pressure P <sub>max</sub> (bar) relative	2 x P <sub>n</sub>					1,4 x P <sub>n</sub>
Burst pressure P <sub>burst</sub> (bar) relative	3 x P <sub>n</sub>					2 x P <sub>n</sub>

\*1 Only in combination with 9/16-18UNF-6M / 59°

Accuracy		
Long-term stability	≤ ± 0.25 %FS / year	
Overall Accuracy	@ 25°C	≤ ± 0,5 %FS
	@ -5°C ...+85°C	≤ ± 1.5 %FS
	@ -40°C...+85 °C	≤ ± 2,5 %FS
General		
Response time	≤2 ms	
Pressure cycles	>100 million	
Material Housing	EN/DIN 1.4301	
Weight	Approx. 100 g	
RoHs	Yes	
MTTFd	>100 years	
ATEX		
M12 metallic connector	II 1G Ex ia IIC T4 Ga	
Other connector	II 2G Ex ia IIC T4 Gb	
Certificate	IBExU24ATEX1042 EN IEC 60079-0 EN 60079-11	
Ambient conditions		
Media temperature	-40 to 100 °C (-40 to 212 °F)	
Operation / Ambient temperature	Zone 0	-20 to 60 °C
	Zone 1 / 2	-40 to 85 °C (-40 to 185 °F)
Storage temperature	-40 to 85 °C (-40 to 185 °F)	
Vibration	IEC 60068-2-6 : 20 g / 3 axes	
Shock	IEC 60068-2-31 (1m free fall)	
CE emission	EN 61326-1:2013-section 7 EN 61326-2-3:2013	
CE susceptibility	EN 61326-1:2013 - section 6 EN 61326-2-3:2013	

Process connection	Torque	Seal	Wetted parts
7/16-20UNF-2A	25 Nm	HNBR	316L (EN/DIN 1.4404) / HNBR
9/16-18UNF-2A	35 Nm	HNBR	316L (EN/DIN 1.4404) / HNBR
9/16-18UNF 6M	25 Nm	none	316L (EN/DIN 1.4404)
1/4 NPT	25 NM	none	316L (EN/DIN 1.4404)



# Pressure transmitter SCP11

Pressure and temperature sensors

## Electrical Connection

Output signal	4...20 mA (2wire)
Supply Voltage $V_+$	20 ... 27 VDC
Load <sub>max</sub>	$< (V_{cc}-10 V)/20 \text{ mA}$
Current consumption	3.6 ... 21.4 mA
Reverse polarity	Yes
Overvoltage protection	Yes
M12x1 4-pole	
Pin 1	V+
Pin 2	P-Signal
Pin 3	n.c.
Pin 4	n.c.
Protection Class (connected)	IP 67
ATEX	II 1G Ex ia IIC T4 Ga
DT04-3P	
A	V+
B	n.c.
C	P-Signal
Protection Class (connected)	IP 67
ATEX	II 2G Ex ia IIC T4 Gb

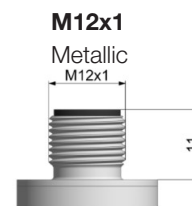
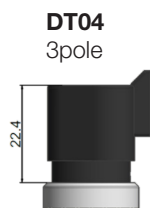

**1/4"-18 NPT**

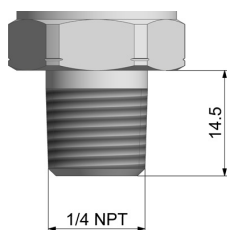

**7/16-20UNF-2A**

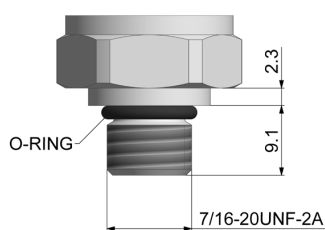

**9/16-18UNF-6M**

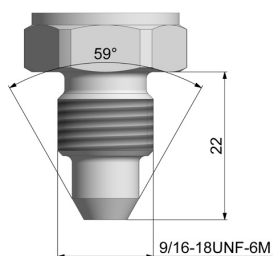

**9/16-18UNF-2A**

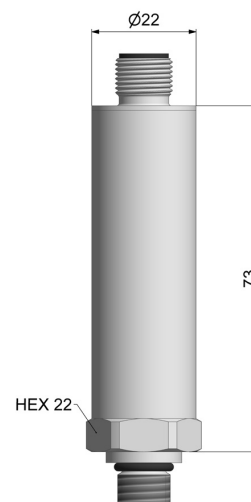
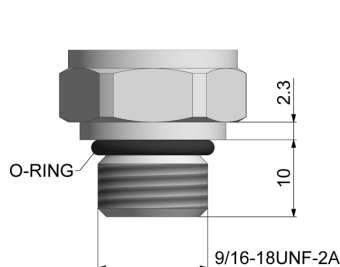

# Pressure transmitter SCP11

## Order code

Pressure sensor SCP11	SCP11-xxx	-3x	0 x	-EXi0S
<b>Pressure range</b>				
0...4 bar	004			
0...25 bar	025			
0...400 bar	400			
0...600 bar	600			
0...1000 bar* <sup>1</sup>	1000			
<b>Output signal</b>				
4...20 mA (2-wire)		3		
<b>Process connection</b>				
1/4"-18 NPT			5	
7/16-20UNF-2A			7	
9/16-18UNF-2A			6	
9/16-18UNF-6M / 59°			M	
<b>Connecting plug</b>				
M12x1 4-pole metallic				7
DT04 3pole				E

\*<sup>1</sup> Only in combination with 9/16-18UNF-6M / 59°

Pressure and temperature sensors

# SCPSi pressure switch

## Device features

- Pressure sensor / -switch
- Temperature measurement
- Industry 4.0-ready
- IO-Link 1.1
- Smart Sensor Profile 2<sup>nd</sup> edition
- Plug & Play
- Compact
- Optimized design
- Adjustable via IO-Link
- Readable via IO-Link
- Useable as IO-Link sensor or switch
- Monolithic pressure cell



The fully electronic pressure switch SCPSi is adjustable and free from susceptible mechanical and moving components.

With its digital interface and smart functions, the SCPSi is future-proof for the increasing demands of automation solutions.

The 2 switching outputs are individually and safely parameterized from the machine control system via the standardized digital IO-Link interface (IEC 61131-9). This replaces manual programming and the commissioning phase is considerably shortened. Devices can be replaced during operation without the need for reparameterization. In order to react promptly to machine status changes or process adjustments, the re-parameterization is carried out during operation.

As an alternative to the switching functions, diagnostic values, process data and status messages are recorded directly via IO-Link and enable subsequent more complex analyses. Via the integrated temperature measurement of the pressure measuring cell, the media or ambient temperature is recorded.

IO-Link replaces time-consuming manual programming and eliminates the need for a sensitive key display with the manufacturer-dependent setting menu. This more compact, more resistant design without key display, in combi-

nation with the smart functions & setting options, opens up new possibilities in machine design for the machine designer, with considerable savings potential.

The compact stainless steel housing allows space-saving use, even in harsh environments.

The proven stainless steel measuring cell with the wide pressure range (from -1 up to 600 bar) allows a wide range of applications for liquid and gaseous media. The media-contacting pressure connection with the pressure measuring cell is monolithically manufactured from a stainless steel without welds and sets new standards in media compatibility and pressure resistance.

The packaging variant optimized for OEM's is environmentally friendly, cost-optimized and facilitates handling.

### Application examples

- Injection-mould machines
- Tool-making machines
- Power packs
- Special machine construction
- Replacement for mechanical pressure switches



# SCPSi pressure switch

## Technical data

SCPSi		001	004	010	025	060	100	250	400	600
Pressure range P <sub>n</sub> vacuum tight / relative P <sub>n</sub>	bar (psi)	-1...1 (-14...14)	-1...4 (-14...58)	-1...10 (14...145)	-1...25 (-14...362)	0...60 (0...870)	0...100 (0...1450)	0...250 (0...3625)	0...400 (0...5801)	0...600 (0...8702)
Overload pressure relative P <sub>max</sub>	bar (psi)	6 (87)	10 (145)	030 (435)	80 (1160)	200 (2900)	300 (4351)	750 (10877)	1200 (17404)	1400 (20305)
Burst pressure relative P <sub>burst</sub>	bar (psi)	9 (130)	15 (217)	100 (1450)	150 (2175)	500 (7251)	800 (11603)	1000 (14504)	2000 (29007)	2200 (31908)
Wetted parts		1.4542 (17-4PH); 1.4548; FKM			Monolitisch 316L; FKM					
Set point SP Range		1 - 100 %								
Reset point rP Range		0 - 99 %								
Steps / Incremental	mbar	0,1	1	1	1	10	10	10	100	100
Smallest hysteresis (SP-rP) & (FH-FL)	bar	0,001	0,01	0,01	0,01	0,1	0,1	0,1	1	1

General	
Overall Accuracy @ RT <sup>[1]</sup>	≤ 0,5 %FS
Min. pressure cycles	> 100 million
Material housing	Stainless steel 1.4404
Weight	approx. 80 g
Conformity	
RoHS	2011/65/EU, 2015/863
CE	Yes
UKCA	Yes
Process connection	
Thread	G1/4, DIN 3852 T11 (E)
Seal	ED type: FKM
Installation torque	Max. 35 Nm
Ambient conditions	
Media temperature	-25 to 85 °C (-13 to 185°F)
Operation / Ambient temperature	-25 to 85 °C (-13 to 185°F)
Storage temperature	-40 to 85 °C (-40 to 185°F)
Vibration	DIN EN 60068-2-6, 20 g
Shock	DIN EN 60068-2-27, 500 g
MTTFd	>100 year
Accuracy	
@ -40°C...-25°C	≤ 2,5 %FS
@ -25...0°C	≤ 1,5 %FS
@ 0...85°C	≤ 1 %FS
Temperature signal	
Output	Via IO-Link
Short circuit	-40 to 125 °C
Resolution	1 K
Accuracy	± 10°K
t <sub>0,9</sub>	80 sek.
Protection	
Overvoltage	70 V
Short circuit	yes
Reverse polarity	yes
Signal on GND/V <sub>+</sub>	yes
Factory setting	
SP1 / rP1	40 / 60% FS; Hno
SP2 / rP2	30 / 70% FS; Hno

Electronic Connectivity	
Power supply voltage V <sub>(+)</sub>	18...30VDC
Connector	M12
Consumption	< 15 mA @ 24V
Output	2 switching outputs, NPN / PNP, 1 IO-Link output
Switch current	Max. 200mA
Max. switch frequency	200 Hz
Response time	≥ 3 ms
IO-Link Interface	
Revision	IO-Link V1.1 Process Data Variable; Device Identification; Device Diagnosis
Min. process cycle time	4 ms
Transmission type	COM2, 38.4kBaund
Profile	Smart Sensor Profile 2 <sup>nd</sup> Edition v1.1.2
SIO-Mode	yes
Master port type	A
Process data analogue (in Pa)	2 Byte Process data 1 Byte scaling factor
Process data binary	1 byte
SDCI Standard	IEC 61131-9
Vendor ID	271 / 10f (hex)
Device IODD	<a href="https://ioddfinder.io-link.com/#/">https://ioddfinder.io-link.com/#/</a>
M12x1	
Protection class (mounted connector)	IP67
	Pin 1 V <sub>(+)</sub>
	Pin 2 S2 out
	Pin 3 0V / GND
	Pin 4 S1 out / IO-Link

# SCPSi pressure switch

Pressure and temperature sensors

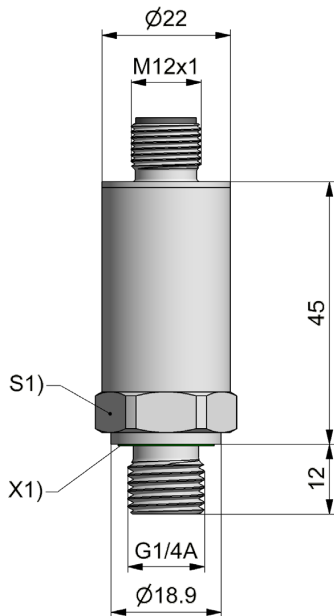

## Order code

SCPSi Pressure switch

SCPSi-xxx-04-07

Druckbereich

0...001 bar	001
0...004 bar	004
0...010 bar	010
0...025 bar	025
0...060 bar	060
0...100 bar	100
0...250 bar	250
0...400 bar	400
0...600 bar	600



## Volumetric flow rate sensors

### Device features

- Different measurement techniques
  - Quick
  - Not dependent on viscosity
  - Without loss
- Many measurement ranges
- Analogue output signal
- M12 connecting plug
- 24 VDC

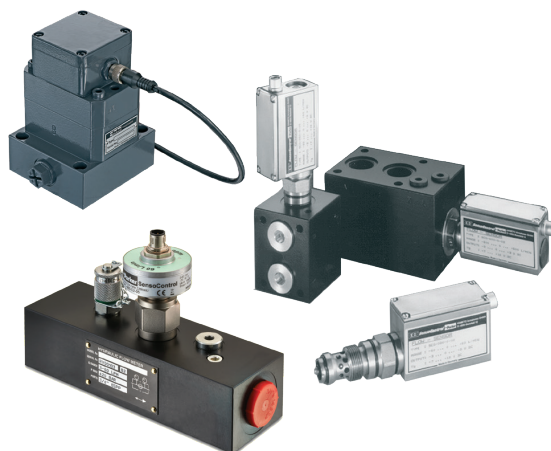

The flow sensors used in **SensoControl®** provide accurate volume flow information in hydraulic systems (e.g. in testing equipment).

The sensors deliver a output signal that is proportional to the volumetric flow rate for further processing to an electronic system. They are compatible with conventional, well-known standards.

- M12 connecting plug
- 24 VDC
- 0/4 to 20 mA

The volumetric flow rate can be easily displayed when using the **SCE-020** panel meter.

In order to meet the many different application requirements, three different measuring principles are available:

- **SCVF** geared counter
- **SCFT** turbine
- **SCQ** spring/piston

The volumetric flow rate sensors are used in control, regulation or monitoring systems where analogue signals are needed to capture the volume flow.

# Volumetric flow rate sensors

## Overview

### SCQ

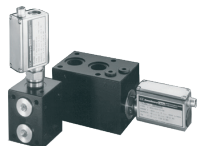

### SCFT



### SCVF



#### Range of use

For quick flow changes  
Measures in both directions

- Response speed  $\leq 2$  ms
- Reverse operation
- Wide viscosity range
- Compact size
- Up to 420 bar (6092 psi)

Low loss measuring of volume flow

- Response speed  $\leq 50$  ms
- Many measurement ranges
- Low flow resistance
- Up to 800 l/min
- Up to 420 bar (6092 psi)

Measures different substances  
Measures lower volume flows (leakage measurements)

- Very wide measurement range
- Not dependent on viscosity
- Up to 400 bar (5802 psi)

#### Applications

- Test rigs
- General machine construction
- Hydraulic plant construction

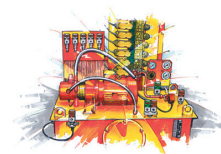

#### Order code

SCQ-xxx-10-07

SCFT-xxx-22-07

SCVF-xxx-10-07

#### Refer to page

34-37

38-41

42-47

# SCQ flow meter

## Device features

- Measurement principle Spring/piston principle
- Response time  $\leq 2$  ms
- Measurement in both directions
- Wide viscosity range
- Compact design
- Withstands pressures up to 420 bar (6092 psi)

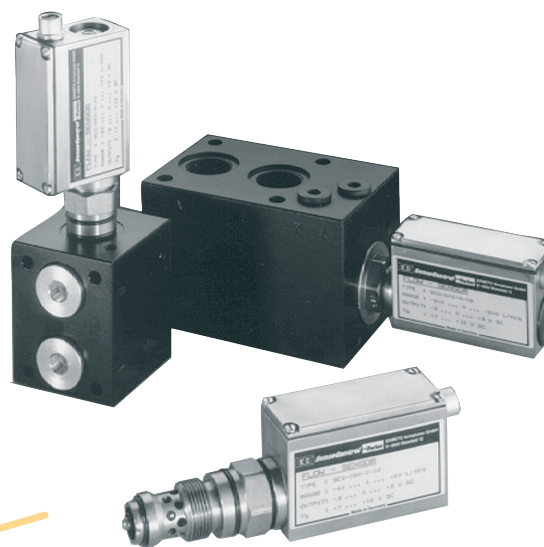

Volumetric flow rate sensors

## Function

The piston (K) is moved due to a flow from A to B or from B to A. In the idle state, the spring (F) and the piston (K) are in equilibrium. The delta (S) is proportional to the flow and is converted to a value through the built-in electronics. Through the change in direction of the piston (B to A), the flow direction can be indicated. (e.g. -45.8 l/min) The reaction time of the piston movement is less than 2 ms.

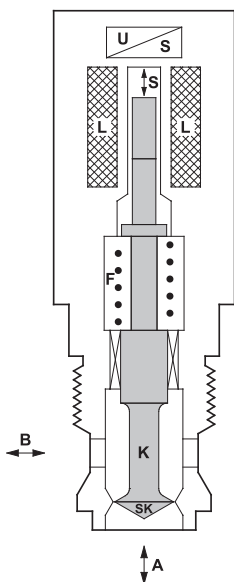

SCQ measurement principle

## Application

When working with high-pressure hydraulics, it is very important to be able to quickly detect the flow rate.

Installation with a connection block permits the combined measurement of p, T and Q. Rapid assembly of the **SCQs** is achieved with an in-line adaptor for tube or hose installation. Use under extreme conditions (such as high load changes or rapid pressure increases) is possible because of the sturdy construction.

The **SCQ** is the perfect solution when recording highly dynamic volume flow changes. Rapid load changes, which can cause damage for example in valves and pumps, can be safely detected. Due to its unique measurement process, the **SCQ** can capture volume flow in both directions.

# SCQ flow meter

## Technical data

SCQ-	150
Measuring range QN	-150...+150 l/min
Qmax	-165...+165 l/min
Substance connection	M42 (NG16)
Weight (g)	1050

Accuracy	
Deviation from characteristic curve	±2 % FS @ 46cSt.
Response time	2 ms
Thermal drift	±0.05 % FS/°C
Repeat accuracy	± 0.5 % FS
Resistance to pressure	
Pressure range	3...420 bar
Operating pressure P <sub>n</sub>	315 bar / (4569 psi)
Overload pressure P <sub>max</sub>	420 bar / (6092 psi)
Pressure drop ΔP (bar) @ (FS)	Refer to diagram
Material	
Housing	Steel
Seal	NBR
Parts in contact with substances	Steel, NBR
Ambient conditions	
Operating temperature	+10...+60 °C / (50...140°F)
Storage temperature	-20...80 °C / (-4...176°F)
Tmax Fluid	+80 °C / (176°F)
Filtration	25 μm

Viscosity range	15...100 cSt.
Protection degree	IP67 DIN EN 60529
Electrical connection	
Plug	M12x1; 4-pole
Supply voltage	+18...+30 VDC
Current consumption	40 mA
Output	0...20 mA = -FS...+FS (10 mA = 0 l/min)
Load	≤ 150 Ω
Signal noise	< 5 mV
EM compatibility	
Disturbance emissions	EN 61000-6-3
Resistance to interference	EN 61000-6-2

Volumetric flow rate sensors

## Pin assignment

M12x1; 4-pole

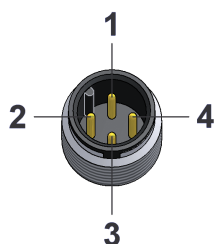

PIN	Assignment
1	V <sub>+</sub>
2	Q signal
3	0 V / GND
4	-

# SCQ flow meter

Screw plug hole and pressure-drop curve **SCQ-150**

30 Nm torque

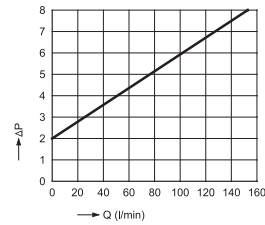
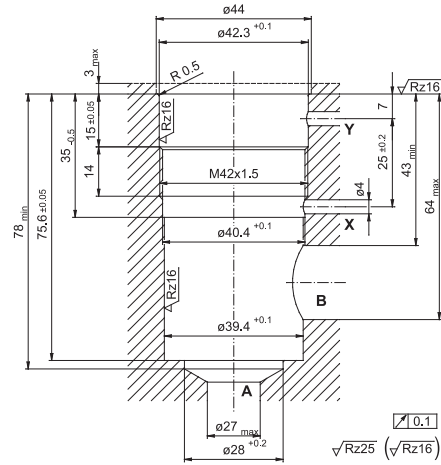
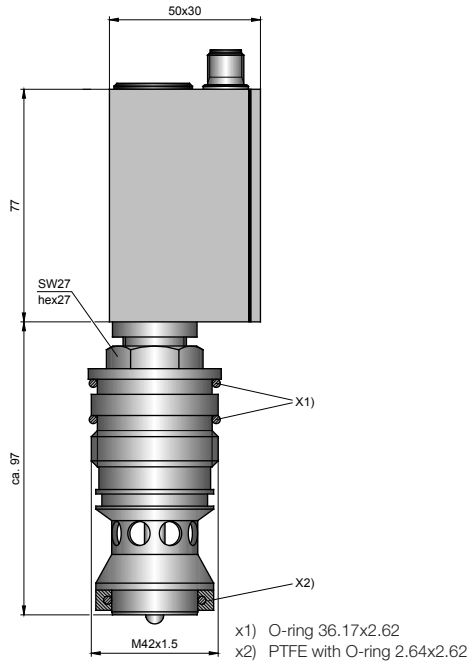

Volumetric flow rate sensors

# SCQ flow meter

## SCAQ-GI-R1/2

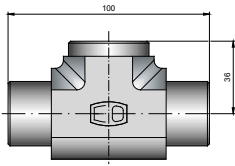

## SCAQ-150

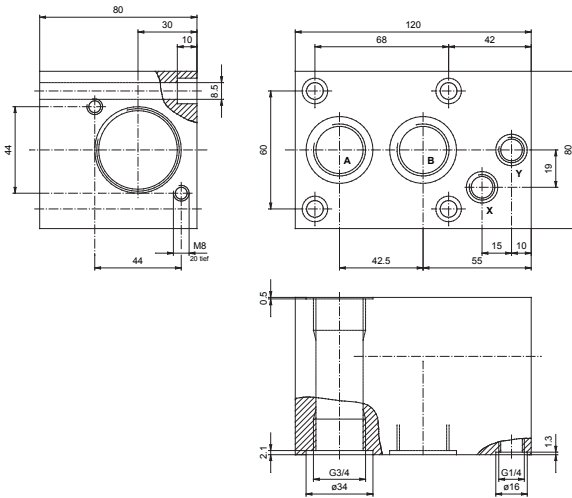

Volumetric flow rate sensors

## Order code

### SCQ-150 (-150 to +150 l/min)

M12x1, 4-pole; connecting plug; IP67  
0 to 20 mA; -150...+150 l/min

**SCQ-150-10-07**

### Accessories SCQ-150

Connector block  
G3/4 BSPP inner (A-B) and M42 inner  
With screw plug:  
M42 outer and  
G3/4 BSPP outer (A-B)

**SCAQ-150**

### Spare parts

Spacer ring for SCQ-060  
Seal kit for SCQ-060  
Seal kit for SCQ-150

**SC-910**

**SC-911**

**SC-912**

## Connection cable and single plug

**Connection cable, assembled**  
(open cable end)

**SCK-400-xx-xx**

### Cable length (m)

2 m	<b>02</b>
5 m	<b>05</b>
10 m	<b>10</b>

### Connecting plug

M12 cable jack; straight	<b>45</b>
M12 cable jack; 90° angled	<b>55</b>

### Single connector

M12 cable jack; straight	<b>SCK-145</b>
M12 cable jack; 90° angled	<b>SCK-155</b>

## SCFT measurement turbine

### Device features

- Measurement principle: Turbine
- Response speed  $\leq 50$  ms
- Measurement range from 1 to 800 l/min
- Low flow resistance
- Suitable for reverse operation
- Built-in pressure and temperature ports

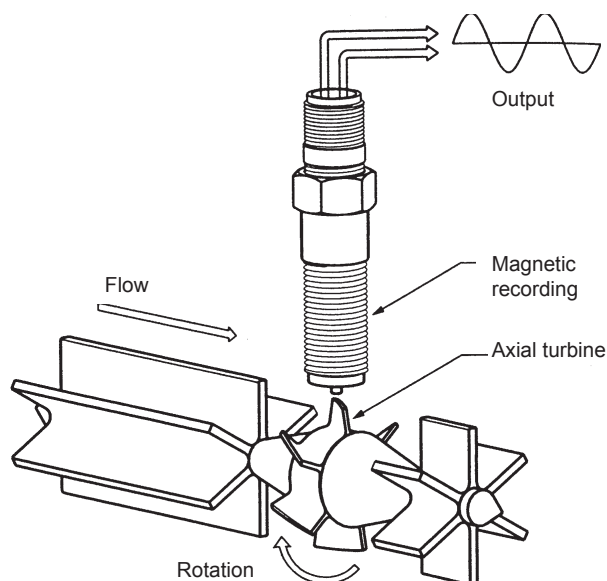

### Function

The turbine wheel is driven by the oil flow. The generated frequencies are processed through the digital electronics and influences from the disturbing flow effects are compensated for. Because of the low flow resistance  $Q_R$ , the hydraulic circuit operates with very low losses.

Reverse operation is also possible because of the special vane (winged) design - so the turbine can be operated in both directions.

The turbine is fitted with an EMA-3 screw coupling for measuring pressure. Oil temperature can be measured directly in the oil flow of the turbine by connecting the temperature sensor (SCT-150). This provides all important measurements at the installation location.

### Application

The SCFT is the ideal solution if the volumetric flow rate needs to be recorded loss-free across a wide flow range (up to 800 l/min.).

# SCFT measurement turbine

## Technical data

SCFT-	015	060	150	300	600	800
Flow measuring range Q <sub>n</sub> (l/min) (US Gal/min)	1...15 (0.25...4)	3...60 (0.8...16)	5...150 (1.3...40)	8...300 (2...80)	15...600 (4...160)	20...800 (5...210)
Accuracy (± %) FS/IR @ 21cSt.	± 1 % FS	± 1 % IR	± 1 % IR	± 1 % IR	± 1 % IR	± 1 % IR
Operating pressure P <sub>n</sub> bar / (psi)	350 (5076)	350 (5076)	350 (5076)	350 (5076)	290 (4206)	400 (5801)
Ports (A - B)	G1/2 BSPP	G3/4 BSPP	G3/4 BSPP	G1 BSPP	G1 1/4 BSPP	G1 7/8 UNF
Pressure drop ΔP (bar) @ (FS)	1.5	1.5	1.5	4	4	5
Weight (g)	700	1600	1600	1700	2700	5000

FS = Full Scale  
IR = Indicated Reading

Volumetric flow rate sensors

Accuracy	
Response time	50 ms
Thermal drift	±0.05 % FS/°C
Repeat accuracy	± 0.5 % FS
Resistance to pressure	
Q <sub>max</sub> (l/min)	Q <sub>N</sub> × 1.1
Overload pressure P <sub>max</sub>	P <sub>N</sub> × 1.2
Material	
Housing	Aluminium
Seal	FKM
Parts in contact with sub- stances	Aluminium, steel, FKM
Ambient conditions	
Ambient temperature	-10...+50 °C / (14...122°F)
Storage temperature	-20...+80 °C / (-4...176°F)
T <sub>max</sub> Fluid	-20...+80 °C / (-4...176°F)
Filtration	25 µm (10 µm for SCFT-015)
Viscosity range	15...100 cSt.
Protection class	IP66 EN60529

Ports	
Temperature measurement (SCT-150-14-07)	M10x1 OR
Pressure connection	EMA3
Pressure (VSTI)	G1/4 BSPP
Electrical connection	
Plug	M12x1; 5-pole
Power supply V <sub>+</sub>	18...30 V
Output signal	4...20 mA ± 0...FS l/min
Complete output current range	0...21 mA
Current consumption	< 30 mA
Protection degree	IP66 EN60529

## Pin assignment

M12x1; 5-pole

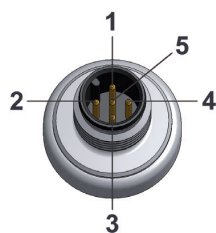

PIN	Assignment
1	V <sub>+</sub>
2	n.c.
3	Q signal
4	n.c.*
5	0 V / GND

\*n.c. = do not connect



# SCFT measurement turbine

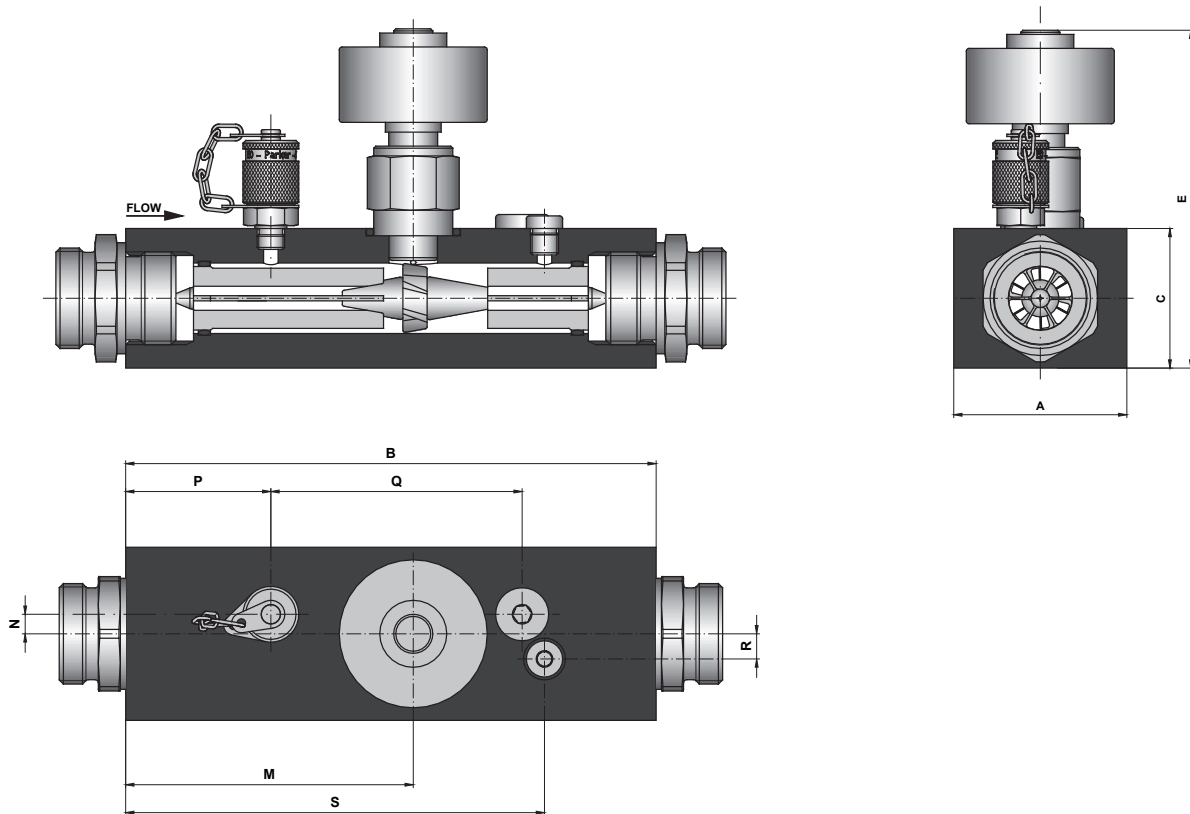

Volumetric flow rate sensors

#	SCFT-015	SCFT-060	SCFT-150	SCFT-300	SCFT-600	SCFT-800
A	37	62	62	62	62	100
B	136	190	190	190	212	212
C	37	50	50	50	75	75
E	115	130	130	134	149	152
M	70	103	103	103	127	126
N	0	5	5	7	9	10
P	25	50	50	52	62	60
Q	N/A	92	92	90	106	104
R	0	5	5	9	11	10
S	115	157	157	150	168	181



# SCFT measurement turbine

## Order code

### SCFT

M12x1, 5-pole; connecting plug; IP66  
4...20 mA (3-wire)

### BSPP:

1...15 l/min	<b>SCFT-015-22-07</b>
3...60 l/min	<b>SCFT-060-22-07</b>
5...150 l/min	<b>SCFT-150-22-07</b>
8...300 l/min	<b>SCFT-300-22-07</b>
15...600 l/min	<b>SCFT-600-22-07</b>
20...800 l/min	<b>SCFT-800-22-07</b>

### UNF:

0.25...4 US Gal/min	<b>SCFT-004G-2U-07</b>
0.8...16 US Gal/min	<b>SCFT-016G-2U-07</b>
1.3...40 US Gal/min	<b>SCFT-150G-2U-07</b>
2...80 US Gal/min	<b>SCFT-080G-2U-07</b>
4...160 US Gal/min	<b>SCFT-160G-2U-07</b>
5...210 US Gal/min	<b>SCFT-210G-2U-07</b>

## Connection cable and single plug

### Connection cable, assembled

(open cable end)

#### Cable length (m)

2 m	<b>02</b>
5 m	<b>05</b>
10 m	<b>10</b>

#### Connecting plug

M12 cable jack; straight	<b>45</b>
M12 cable jack; 90° angled	<b>55</b>

**SCK-400-xx-xx**

### Single connector

M12 cable jack; straight	<b>SCK-145</b>
M12 cable jack; 90° angled	<b>SCK-155</b>

## SCVF volume counter

### Device features

- Measurement principle: Volume/geared counter
- Eight measurement ranges from 0.01 - 2 to 1 - 300 l/min
- Accuracy  $\pm 0.5$  % FS
- Withstands pressures up to 400 bar (5802 psi)
- High viscosity range
- Low noise
- Exact flow rate measurement over a wide viscosity range
- Versatile usage for different substances

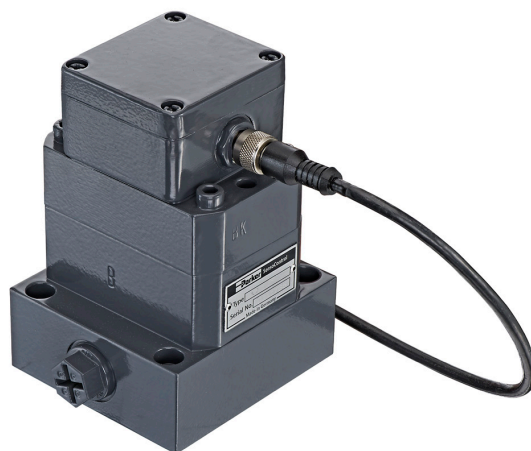

### Gear counter for highly accurate flow rate measurements in hydraulic systems

#### Function

The SCVF geared counter functions as a volume flow meter. A very precisely crafted pair of geared wheels is driven by the fluid flow.

The SCVF works over a wide viscosity range. Different seals permit usage in many different applications.

#### Applications

Due to the wide viscosity range, any liquid can be measured that can be pumped and has a certain degree of lubricating capability.

- Brake fluid (EPDM seal)
- Skydrol
- Mineral oils
- Hydraulic oil and
- Grease

The SCVF is the ideal solution when carrying out precise flow rate measurements over a wide viscosity range.

# SCVF volume counter

## Technical data

SCVF-	002	004	015	040	060	080	150	300
Flow measuring range (l/min)	0.01...2.0	0.02...4.0	0.2...15	0.4...40	0.4...60	0.4...80	0.6...150	1.0...300
Pressure range P <sub>N</sub> bar / (psi)	400 (5802)	315 (4569)	400 (5802)	400 (5802)	400 (5802)	400 (5802)	315 (4569)	315 (4569)
Overload pressure P <sub>O</sub> bar / (psi)	480 (6962)	400 (5802)	480 (6962)	480 (6962)	480 (6962)	480 (6962)	350 (5076)	350 (5076)
Connection	G3/8 BSPP	G3/8 BSPP	G3/8 BSPP	G1/2 BSPP	G1/2 BSPP	G1/2 BSPP	G1 BSPP	G1 BSPP
Sound level dB (A)	< 60	< 60	< 60	< 70	< 70	< 70	< 70	< 72
Resolution (pulses / litre)	40,000	25,000	4082	965	965	965	333.33	191

Volumetric flow rate sensors

### Accuracy

Deviation from characteristic curve	± 0.3 % FS ≥ 20 cSt. ± 0.5 % FS ≥ 20 cSt.
Response time	< 10 ms
Repeat accuracy	0.01 % FS
Substance *)	Hydraulic oil (25 micron filter)

### Material

	Material 1.7139 Contains no non-ferrous metal or silicone
Housing	Steel
Seal	FKM EPDM on request

### Ambient conditions

Ambient temperature	0...+55 °C / (32...131°F)
Storage temperature	-25...+85 °C / (-13...185°F)
Fluid temperature	-30...120 °C / (-22...148°F)
Viscosity range	Refer to diagram p. 44
Protection degree	IP65 DIN EN 60529

FS = Full scale value

\*) When using other substances, please state the viscosity range and the type of seals. (Attach the data sheet of the substance if possible)

### Electrical connection

Plug	M12x1; 4-pole
Power supply V <sub>+</sub>	+18...+30 VDC
Current consumption	< 28 mA
Output signal	0...20 mA ± 0...FS l/min
Load	≤ 150 Ω

### EM compatibility

Disturbance emissions	EN 61000-6-3
Resistance to interference	EN 61000-6-2

## Pin assignment

M12x1; 4-pole

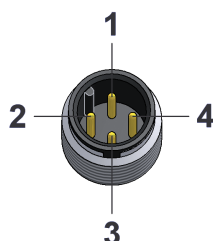

PIN	Assignment
1	V <sub>+</sub>
2	Q-signal
3	0 V / GND
4	-



# SCVF volume counter

## Technical data

SCVF-002  $\Delta p$  - Viscosity

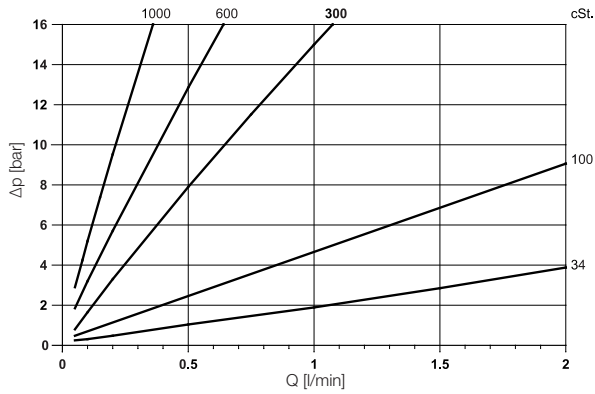

SCVF-004  $\Delta p$  - Viscosity

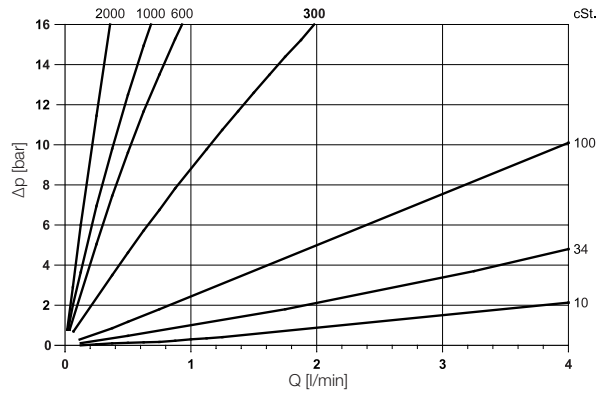

SCVF-015  $\Delta p$  - Viscosity

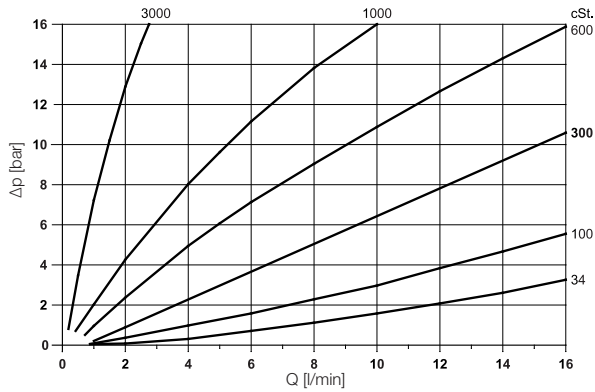

SCVF-040/060/080  $\Delta p$  - Viscosity

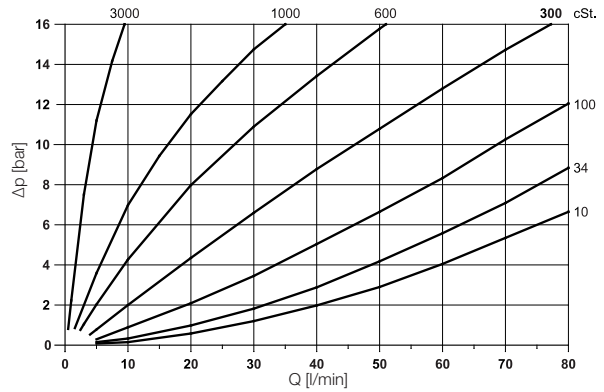

SCVF-150  $\Delta p$  - Viscosity

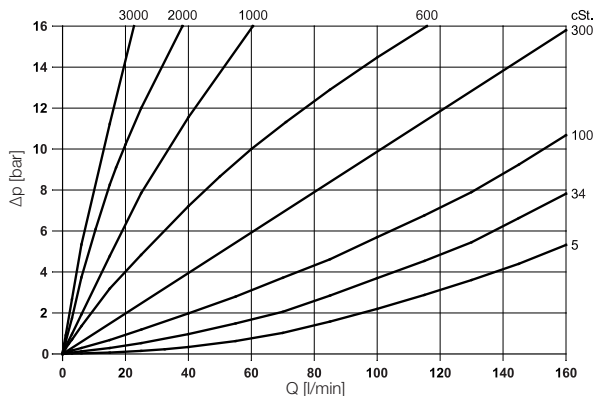

SCVF-300  $\Delta p$  - Viscosity

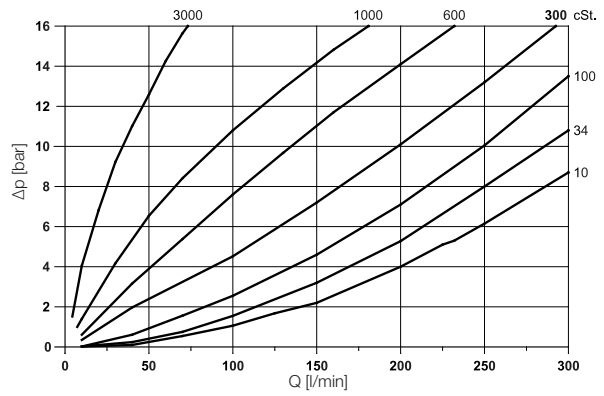

$\Delta p$  = pressure loss



# SCVF volume counter

Volumetric flow rate sensors

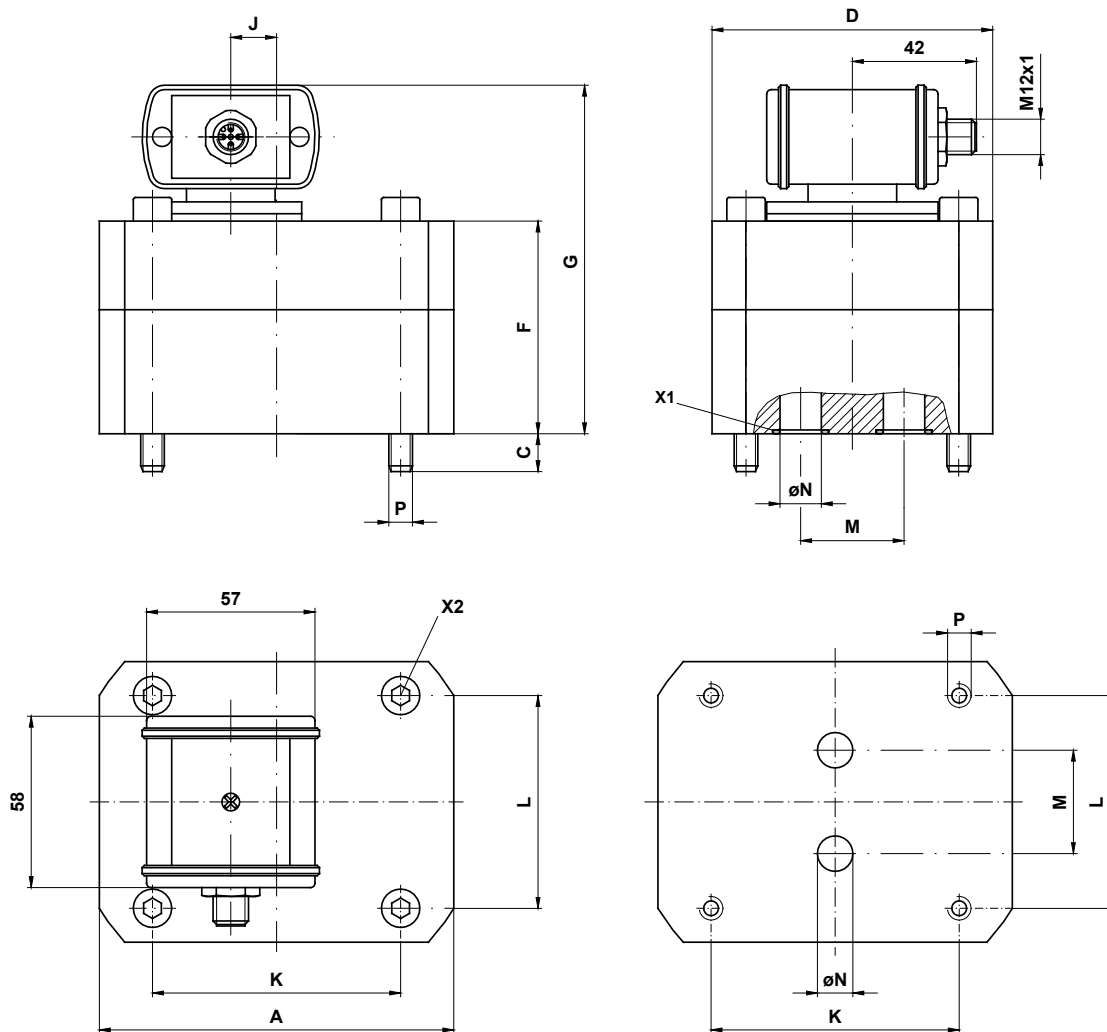

Type	Weight [kg]	Torque [Nm]	A	C	D	F	G	J	K	L	M	ØN	P
SCVF-002	1.8	14	85	10	60	50	87	-	70	40	20	6.5	M6
SCVF-004	2	14	85	9	60	56		-	70	40	20	6.5	M6
SCVF-015	2	14	85	13	60	57	94	-	70	40	20	9	M6
SCVF-040	5.2	35	120	13	95	72	109	10.5	84	72	35	16	M8
SCVF-060													
SCVF-080													
SCVF-150	9	120	170	18	120	89	140	46.5	46	95	50	25	M12
SCVF-300	13	120	170	22	120	105	142	40	46	95	50	25	M12

All measurements in mm



# SCVF volume counter

## Dimensioned drawings connection plate

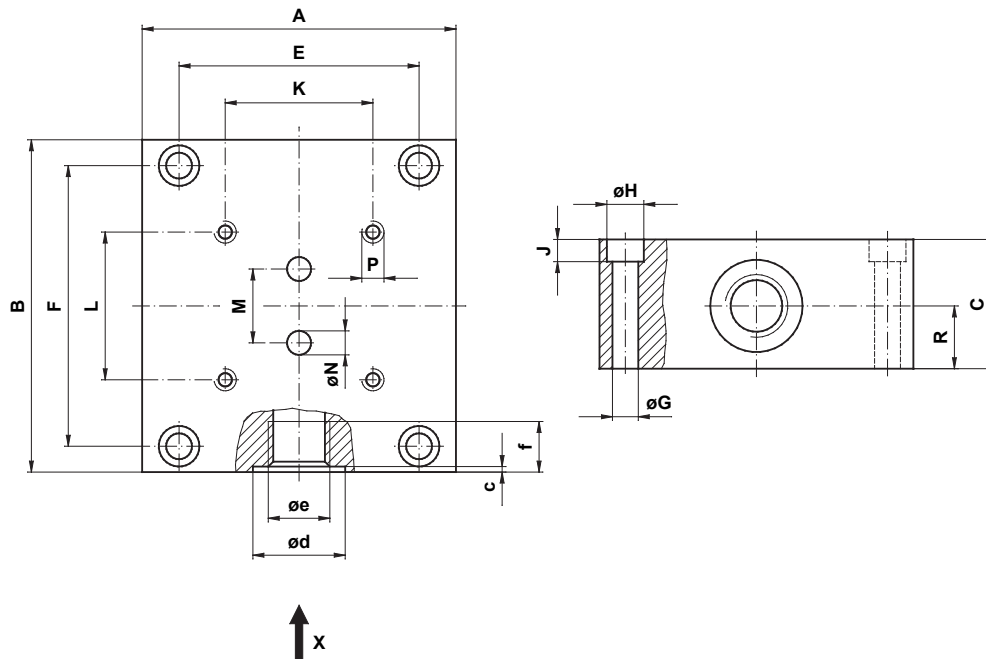

Volumetric flow rate sensors

Type	kg	A	B	C	E	F	øG	øH	J	K	L	M	øN	P	R	c	ød	øe BSPP	f
SCVF-002 SCVF-004 SCVF-015	1.8	85	90	35	65	76	7	11	7	70	40	20	6.5	M6/t = 14	17	0.7	25	G3/8	13
SCVF-040 SCVF-060 SCVF-080	2.9	100	120	37	80	106	7	11	7	84	72	35	12	M8/t = 18	17.5	0.7	29	G 1/2	15
SCVF-150 SCVF-300	14	160	165	80	140	145	9	15	9	46	95	50	25	M12/t = 24	28	1	42	G1	19

All measurements in mm



# SCVF volume counter

## Order code

### SCVF

M12x1, 4-pole; connecting plug; IP65; incl. connection plate

0...20 mA

0.01...2 l/min

**SCVF-002-10-07**

0.02...4 l/min

**SCVF-004-10-07**

0.2...15 l/min

**SCVF-015-10-07**

0.4...40 l/min

**SCVF-040-10-07**

0.4...60 l/min

**SCVF-060-10-07**

0.4...80 l/min

**SCVF-080-10-07**

0.6...150 l/min

**SCVF-150-10-07**

1...300 l/min

**SCVF-300-10-07**

Volumetric flow rate sensors

## Connection cable and single plug

### Connection cable, assembled

**SCK-400-xx-xx**

(open cable end)

#### Cable length (m)

2 m

**02**

5 m

**05**

10 m

**10**

#### Connecting plug

M12 cable jack; straight

**45**

M12 cable jack; 90° angled

**55**

### Single connector

M12 cable jack; straight

**SCK-145**

M12 cable jack; 90° angled

**SCK-155**

## The Controller Family

### Device features

- Large display
- Freely adjustable
- Rugged metal construction
- Compact size
- Long-term stability
- Dependable
- Immune to interference



This controller is used in control, regulation or monitoring systems where switching signals or analogue signals are used or a display is required.

The controller can replace the following:

- Mechanical switches
- Mechanical displays  
(pressure gauges, thermometers, inspection glass)
- Sensors

All the above mentioned functions can be combined in one device.

All control devices have a compact and pivoting metal housing so that they can be mounted optimally under adverse installation conditions. The large display can always be perfectly positioned so that it is easy to read even at longer distances.

Both of the switching outputs can be set individually either as NO or NC. They also both have hysteresis and the window functions. Therefore the on and off switching values as well as delay times (attenuation) for each of the switching points can be chosen freely.



Thanks to these easy switching functions, intelligent adjustments can be set which are normally not possible using a mechanical switch. Therefore, many switches can be replaced with one controller.



The controllers offer good practical characteristics combined with diverse mounting and setting options.

Because of its compact design, long lifespan and high functionality, this controller is ideal for the permanent series use in hydraulic and pneumatic applications.

# The Controller Family

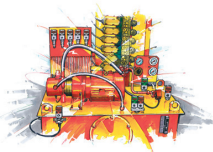
## Overview

	SCPSDI	SCTSD-L
		
<b>Range of use</b>	Pressure display and monitoring <ul style="list-style-type: none"> <li>Compact size</li> <li>Resistant to pressure peaks</li> <li>Resistant to shock and vibration</li> <li>IO-Link interface</li> </ul>	Temperature display and level monitoring <ul style="list-style-type: none"> <li>Temperature display</li> <li>Fixed level contacts</li> </ul>
<b>Applications</b>	<ul style="list-style-type: none"> <li>Test benches</li> <li>Processing equipment</li> <li>Conveying and lifting equipment</li> <li>General machine construction</li> <li>Pneumatic plant construction</li> <li>Hydraulic plant construction</li> </ul>	
<b>Order code</b>	SCPSDI-xxx-x4-xx	SCTSD-L-xxxxx-xxxxxQ2
<b>Refer to page</b>	59-62	63-66

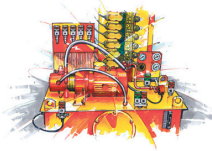
	SCLSD	SCLTSD	SCOTC
			
<b>Range of use</b>	Level indication and monitoring <ul style="list-style-type: none"> <li>Level display</li> <li>Practical monitoring with window function</li> <li>Continuous level measurement</li> </ul>	Level/temperature display and monitoring <ul style="list-style-type: none"> <li>Level display</li> <li>Temperature display</li> <li>Continuous level measurement</li> <li>One bore hole</li> </ul>	Level/temperature display and monitoring <ul style="list-style-type: none"> <li>Level display</li> <li>Temperature display</li> <li>Continuous level measurement</li> <li>One bore hole</li> <li>Connection to the filling coupling</li> <li>Connection to the air filter</li> </ul>
<b>Applications</b>	<ul style="list-style-type: none"> <li>Test benches</li> <li>Processing equipment</li> <li>Conveying and lifting equipment</li> <li>General machine construction</li> <li>Pneumatic plant construction</li> <li>Hydraulic plant construction</li> </ul>		
<b>Order code</b>	SCLSD-xxx-x0-07	SCLTSD-xxx-x0-07	SCOTC-xxx-x0-07
<b>Refer to page</b>	67-72	73-78	79-84

# SCPSDI PressureSwitch

## Device features

### Display

- Large Display
- 2-color switching status display
- Reversal of viewing direction by 180°
- Beveled for better readability
- Units in bar, MPa and psi

### Easy to use

- 3 tactile buttons
- VDMA-Menu navigation

### Outputsignal

- IO-Link interface
- Stable metallic M12x1 thread
- Pin assignment according to VDMA
- Can be selected between switching output, current output and voltage output

### Measuring element

- Pressure range up to 600 bar possible
- High compressive strength
- High accuracy up to 0,5% FS
- Long-term stable measuring cell

### Thread

- G1/4 internal and external thread
- Stainless steel 17-4PH = /1.4542
- Broad media compatibility

### Housing

- Metallic housing
- High quality surface
- 240° rotatable
- IP67 protection
- Increased temperature range between -40°C up to +85°C



Volumetric flow rate sensors

# SCPSDI PressureSwitch

## Technical data

SCPSDI-	004	010	016	060	100	250	400	600
Pressure range $P_n$	-1...4	-1...10	-1...16	0...60	0...100	0...250	0...400	0...600
Overload pressure $P_{max}$	50	50	50	500	500	800	1200	1200
Burst pressure $P_{burst}$	1500	1500	1500	2500	2500	3000	3500	3500
Display resolution	0,001	0,01	0,01	0,01	0,1	0,1	0,1	0,1
Min. adjustable difference SP and rSP	0,01	0,01	0,01	0,1	0,1	0,1	1	1

All units in bar

### Process connection

Process connection	G1/4 BSPP Internal/External
Tightening torque	35 Nm

### Parts in contact with media

Internal thread	Stainless Steel: 17-4PH = / 1.4542
External thread	Stainless Steel: 17-4PH = / 1.4542 Sealing: ED FKM SH75
Sampling rate	≤3 ms
Medium temperature	-40...+85 °C
Switching cycles	≥10 Mio.

### Output variables

Current output	0..20mA or 4..20mA (programmable)
Voltage output	0..10V

### Switching point

Switching current:	max. 200 mA
Short circuit current:	400mA (short term), short circuit proof
Switching voltage:	Supply voltage - 0,5 VDC
Execution:	PNP/ NPN (programmable)
Max switching frequency	250 Hz

### Accuracy

@ 25°C	±0,5% FS
@ -20...+85°C	±1,5% FS

### Display accuracy

@ 25°C	±0,5% FS ±1 Digit
@ -20...+85°C	±1,5% FS ±1 Digit

### Response speed

Switching output	≤3 ms
Analogue output	≤3 ms

### Electrical connection

Supply voltage $V_+$	18...30 VDC
Connector	M12x1; 4pol / M12x1; 5pol
Short circuit protection	Yes
Reverse polarity protection	Yes
Overload protection	Yes
Overvoltage	50 V
Current consumption	<40 mA @24V
Inrush current	<100 mA @24V

### IO-Link

Profile:	Smart Sensor Profile 2nd Edition V1.1.2
Process Cyklustime	4 ms
SIO-Mode	Yes
SIO-Mod	A
Process data analogue	2 Byte Process data 1 Byte Scaling factor
Process data binary	1 Byte
SDCI Standard	IEC 61131-9
Vendor ID	271 (dec) / 10f (hex)
Device IO-Link	<a href="https://parker.com/">https://parker.com/</a>

# SCPSDI PressureSwitch

## Technical data

Housing	
Rotatability	>240°
Readability display	Reversal of viewing direction by 180° (programmable)
Display	7-Segment-LED (4-digit)
	2-color switching status display (red/yellow)
Buttons	Digit height : 8 mm
	3 tactile buttons for up, down, enter
Material	
Housing	Zinc die-cast (bright nickel-plated)
Display cover	Polyester Autotex V207
Protection class	IP67
Weight	150 g
Environmental conditions	
Ambient temperature	-40...+85 °C
Operating temperature	-40...+85 °C
Storage temperature	-40...+85 °C
Vibration resistance	DIN EN 60068-2-6, 20 g
Shock resistance	DIN EN 60068-2-27, 50 g

EM compatibility	
Immunity to interference	
Emission of interference	EN 55011
ESD	EN 61000-4-2
high-frequency electro-magnetic fields	EN 61000-4-3
fast transient electrical disturbances	EN 61000-4-4
Conducted disturbances induced by high-frequency fields	EN 61000-4-6
General	
MTTFd	>100 Jahre
RoHS-Conformity	2011/65/EU, 2024/232

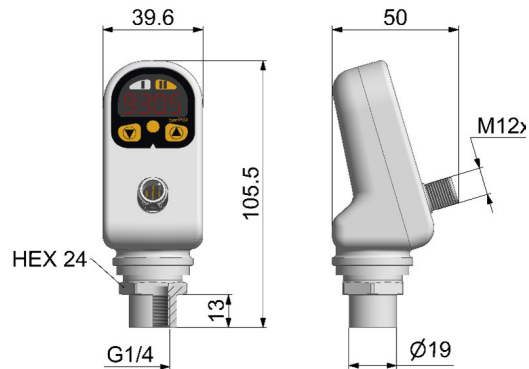
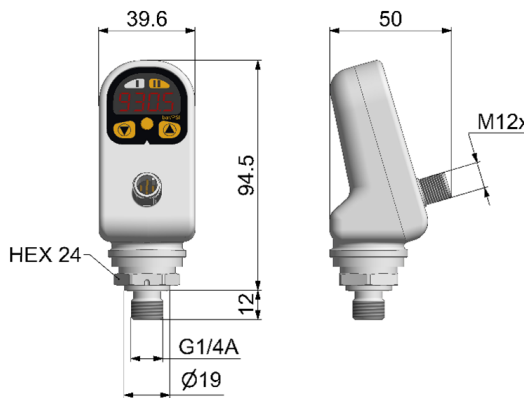

Volumetric flow rate sensors

# SCPSDi PressureSwitch

## Order code

### Digital PressureSwitch SCPSDI

**2 switching points; no analogue output** SCPSDI-xxx - 04 -x7  
M12x1 connector; 4-Pin

**1 switching point; with current output** SCPSDI-xxx - 04 -x7  
M12x1 connector; 4-Pin

**2 switching points; with current output or voltage output** SCPSDI-xxx - 04 -x7  
M12x1 connector; 5-Pin

### Pressure range

004 bar	004
010 bar	010
016 bar	016
025 bar	025
060 bar	060
100 bar	100
250 bar	250
400 bar	400
600 bar	600

### Analogue output

No analogue output	0
0..20 mA / 4..20 mA	1
0..10 V	4

### Version

G1/4 BSPP External thread	1
G1/4 BSPP Internal thread	2

### Accessory

Securing clamp  
Reducing adapter M22x1,5  
Reducing adapter G1/2 BSPP  
Attenuation adapter

SCSD-S24  
RI22X1.5EDX1/4CF  
SCA-1/4-ED-1/2-ED  
SCA-1/4EDX1/4-D

### Order example

#### SCPSDI-100-04-27

Pressure range 100 bar  
2 switching points  
G1/4 BSPP Internal thread  
M12 Connector 4-Pin

#### SCPSDI-004-44-15

Pressure range 4 bar  
2 switching points  
1 analogue output 0..10V  
G1/4 BSPP External thread  
M12 Connector 5-Pin

## Connection cable and single plug

Connection cable, assembled SCK-400 - xx - xx  
(open cable end)

### Cable length (m)

2 m	02
5 m	05
10 m	10

### Connector

M12 cable jack; straight	45
12 cable jack; 90° angled	55

### Single connector

M12 cable jack; straight	SCK-145
M12 cable jack; 90° angled	SCK-155

## Connection

PIN	Assignment SCPSDI-xxx-x4-x7
1	V <sub>+</sub>
2	Analogue out
3	0 V/GND
4	S1 out / IO-Link

PIN	Assignment SCPSDI-xxx-04-x7
1	V <sub>+</sub>
2	S2 out
3	0 V/GND
4	S1 out / IO-Link

PIN	Assignment SCPSDI-xxx-x4-x5
1	V <sub>+</sub>
2	S2 out
3	0 V/GND
4	S1 out / IO-Link
5	Analogue out

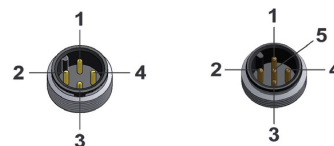

Volumetric flow rate sensors

## SCTSD-L combination switch

### Device features

- Compact design
- Temperature display
- Individually adjustable temperature switching outputs
- Small switching hysteresis
- Preset
  - For standard oils
  - For cooling
  - For switching off ( $T_{max}$ )
- Fixed level contacts
- Only one float
- Preset level
  - Warning and shutdown min.
  - Shut-down min./max.
- Up to one meter probe length



The SCTSD-L combination switch was designed to meet the requirements of hydraulic facility construction. It combines the functions of a fixed mechanical level switch with an adjustable temperature switch with display.

### Level

The tank level is measured using a highly dynamic, fully encapsulated magnetic float which switches the bi-stable reed contacts. The M12 pin assignments are compatible with conventional existing systems. The level contacts are pre-determined according to the normal tank sizes. There are two standard switch output versions available:

- Warning minimum level and shutdown minimum level
- Shutdown maximum and minimum levels

The switching positions were chosen according to the proven experiences of plant constructors and the DIN. For safety reasons (fail-safe / closed circuit), the switching behaviour of the standard switch is an NC contact.

Optionally the contacts can be changed at the factory and pre-set in line with the customer's requirements.

### Temperature

The temperature is detected using a sensor; it is then evaluated and constantly displayed using the SCTSD TemperatureController (as described in the SCTSD section). Thanks to the easy switching functions (e.g. switching windows), intelligent switching settings can be achieved that are not possible using a mechanical temperature switch.

Normally the outputs for the normal temperature functions cooling on/off and shutdown are pre-installed as standard. The temperature thresholds were designed for standard oils (HLP).

It is possible to adjust the temperature monitoring temperature limits (e.g. cooling and shutdown) for each output individually using the keys:

- On/off switching temperature limits
- NO/NC contact
- Hysteresis / window function
- Time delay and attenuation

Optional (see: SCTSD-L-....-KIT5 ) 3 different versions of temperature switching outputs are available:

- 2 switching outputs
- 1 switching and 1 analogue output
- 2 switching outputs and one analogue output

# SCTSD-L combination switch

## Technical data

General	
Measurement principle	Magnetic float reed switches
Float	NBR, Ø 18 mm, length 25 mm, magnetic
Viscosity	Max. 250 cSt at 25 °C
Density	at least 0.750 g/cm <sup>3</sup>
Connector thread	G3/4 outer thread
Protection tube	Ø 8 mm
Probe length Lmax	Lowest switching point + 35 mm
Operating pressure	1 bar max. / (14,5 psi)
Accuracy	±2 mm
Material	
Protection tube	Brass
Connector thread	Brass
Ambient conditions	
Temperature of substance	-20...+85 °C / (-4...185°F)
Storage temperature	-40...+100 °C / (-40...212°F)

Preset temperatures	
Switching output 1*	50 °C (122°F) contact closed (cooling on)
	45 °C (113°F) contact open (cooling off)
Switching output 2*	63 °C (145°F) contact open (shutdown)
	60 °C (140°F) contact closed
Level switching outputs	
Switching current:	0.5 A max.
Switching voltage	100 V max.
Switching power	10 W max.
Switching function	NO or NC (bi-stable)
Contact material	Rhodium
Plug	M12x1; 4 pin
Smallest difference between L1 and L2	30 mm
Smallest switching position L1	30 mm from the tank lid

\*) Each temperature switching output can be individually re-programmed or adjusted:

- NO/NC contact
- On/off switching temperature
- Hysteresis / window function
- Time delay and attenuation

## Fill level pin assignments

M12x1; 4-pole

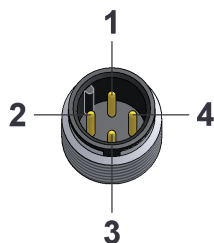

PIN	Assignment
1	IN
2	OUT S2
3	n.c.*
4	OUT S1

\*n.c. = do not connect

# SCTSD-L combination switch

## Temperature pin assignment

**SCTSD-150-0X-0X**  
(Refer chapter SCTSD)

**SCTSD-L-xxxxO-xxFO**  
**SCTSD-L-xxxxx-xxxxx-KIT5**  
2 switching outputs  
M12x1; 4-pole

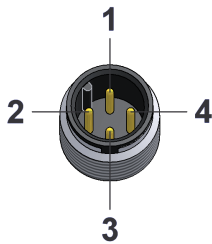

PIN	Assignment
1	V <sub>+</sub>
2	S2 out
3	0 V / GND
4	S1 out

**SCTSD-L-xxxxx-xxxxx-17-KIT5**  
1 switching output, 1 analogue output  
M12x1; 4-pole

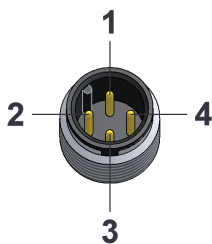

PIN	Assignment
1	V <sub>+</sub>
2	Analogue out
3	0 V / GND
4	S1 out

**SCTSD-L-xxxxO-xxFO**  
**SCTSD-L-xxxxx-xxxxx-15-KIT5**  
2 switching outputs, 1 analogue output  
M12x1; 5-pole

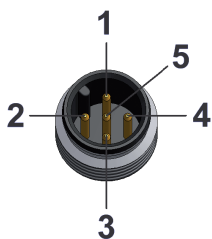

PIN	Assignment
1	V <sub>+</sub>
2	S2 out
3	0 V / GND
4	S1 out
5	Analogue out

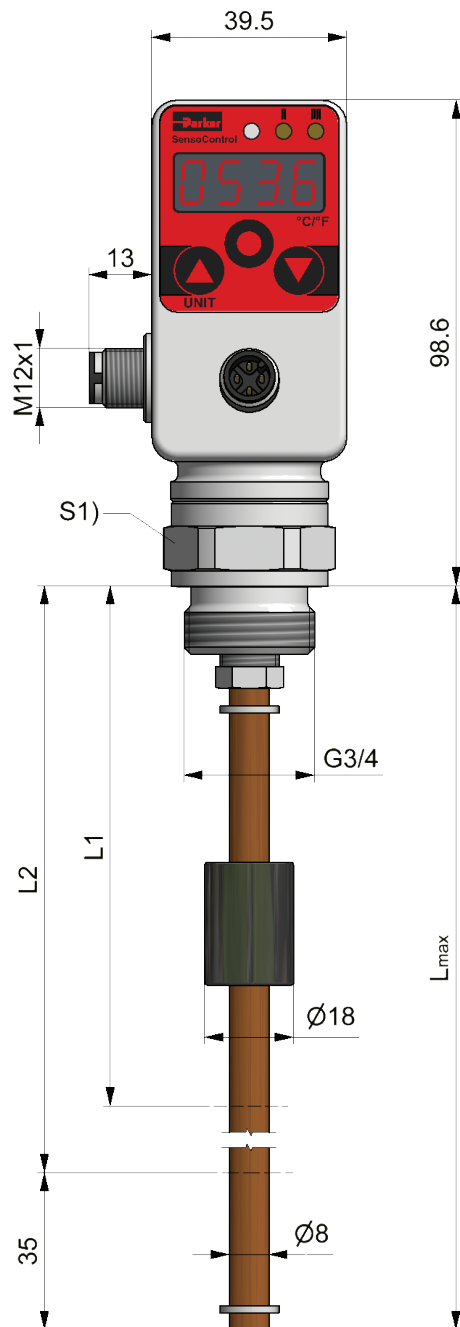

The Controller Family



# SCTSD-L combination switch

## Order code

**Combination switch** ———— **SCTSD-L-xxxxx-xxxxxQ2**

**Combination switch Marine** ———— **SCTSD-L-xxxxx-xxxxx-MAQ2**

(approved by DNV/GL/ABS)

2 level outputs, temperature display

2 temperature switching outputs

**Combination switch** ———— **SCTSD-L-xxxxx-xxxxx-1xQ2**

**Combination switch Marine** ———— **SCTSD-L-xxxxx-xxxxx-1x-MAQ2**

(approved by DNV/GL/ABS)

2 level outputs, temperature display

1 temperature-analogue output

(0/4..20 mA)

Length (L1 mm)\*

min. 40 mm / max. 950 mm

xxx

### Version

Falling closing ———— **FC**

Falling open ———— **FO**

Rising closing ———— **RC**

Rising open ———— **RO**

Length (L2 in mm)\*

min. 40 mm / max. 950 mm

xxx

### Version

Falling closing ———— **FC**

Falling open ———— **FO**

Rising closing ———— **RC**

Rising open ———— **RO**

### Plug-in connection

M12; 4-pole (1 temperature switching output) ———— **7**

M12; 5-pole (2 temperature switching outputs) ———— **5**

**Q2**: Minimum order qty. 5 pcs.

\*Switching output 1 (L1) can be above or below switching output 2 (L2)

L1 and L2 are multiples of 10 mm

Smallest difference between L1 and L2 = 30 mm

# SCLSD LevelController

## Device features

- Proven measuring system
- Level display
- mm / inch / % display
- High and low display
- Analogue output
- Switching outputs
- No surge pipe necessary
- Replacement for several mechanical switches
- Pivoting



The LevelController combines the functions of a level switch, a level sensor and a level display.

- Level display (inspection glass)
- Switching outputs
- Analogue signal

The LevelController is ideal for the monitoring tank contents.

### Easy to use

The parameters are set using the keys or over a programming module.

### High functionality

Each switching output can be adjusted individually:

- NO/NC contact
- Upper and lower level switching point
- Delay times
- Hysteresis / window function
- Attenuation

The analogue output is individually adjustable:

- 0/4...20 mA switchable
- Upper level adjustable
- Lower level adjustable

### Reliable and safe

The position of the float is finely ( $\geq 5$  mm) and continuously recorded and shown in the display in mm or inch. Through this continuous recording, the danger of individual mechanical contacts "sticking" no longer exists. Therefore the operational reliability of the monitored plant is increased. Parameters can be password protected to avoid unauthorised changes.

### Everything at a glance

The display can be read from long distances. Using the selectable percent display the full level is uniformly displayed independent of the tank shape. An offset can also be entered (difference from the sensor to the tank bottom) to give a realistic indication of the level from the tank bottom.

Different uses can easily be implemented or corrected at a later date using the menu-driven level switching points. As the switching point no longer needs to be specified at the time of order, the versions of mechanical level switches required is reduced.

### Universal

Thanks to these easy switching functions (hysteresis and window functions, NC or NO functions), intelligent adjustments can be set which are normally not possible using a mechanical level switch. Therefore, many switches can be replaced with one controller. With the optional analogue output, the level and temperature can be monitored easily with a controller (e.g. for leakage monitoring).

# SCLSD LevelController

## Application example: Tank temperature monitoring

Since the conventional specifications for mechanical level switches (the mm data from the tank lid) are often used during project planning, these data are selected here for a practical example.

### Facility off

If the tank level falls below 310 mm (measured from the tank top / dry run) or climbs above 70 mm (measured from the tank top / overflow), switch off should occur. A protective wire-break mechanism should be considered to improve safety.

### Automatic tank filling

If the tank level falls below 240 mm (measured from the tank top), the tank should be automatically filled to 110 mm (measured from the tank top) with a pump.

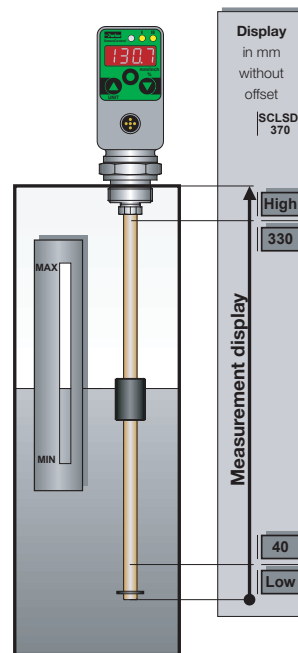

### Resulting switch value for a SCLSD-370 mm

Stop above:  
370 mm - 70 mm = 300 mm  
Stop below:  
370 mm - 310 mm = 60 mm  
Window function, NO contact

The output S1 is closed, if the level is between 300 and 60 mm.

Load stop:  
370 mm - 110 mm = 260 mm  
Load on:  
370 mm - 240 mm = 130 mm  
Hysteresis function, NC contact

If the level falls below 130 mm, the contact closes and opens again when 260 mm is exceeded.

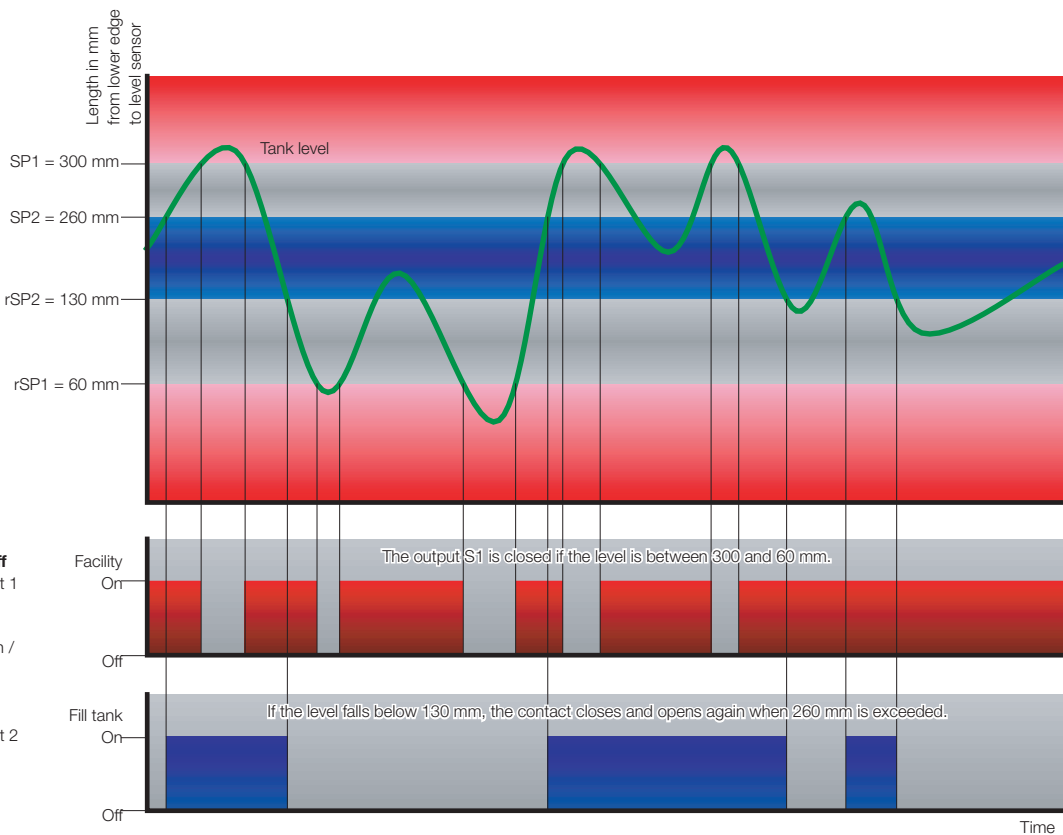

**Facility On / Off**  
Switching output 1  
SP1 = 300 mm  
rSP1 = 60 mm  
Window function /  
NO contact

**Fill tank**  
Switching output 2  
SP2 = 260 mm  
rSP2 = 130 mm  
Hysteresis NC  
contact

# SCLSD LevelController

## Device features

### Everything at a glance

- Sloped display
- Digital display
  - Large
  - Illuminated
- Display
  - mm, inch, or %
  - Actual level
  - High and low display
  - Switching points

### Rugged

- Metal housing
- Waterproof
- Excellent interference immunity
- Vibration proof
- Shock proof

### Variable installation

- Compact size
- 290° pivotable
- G3/4 BSPP
- Flange for DIN

### Programming module

- Adjustable with ControllerWIN Software

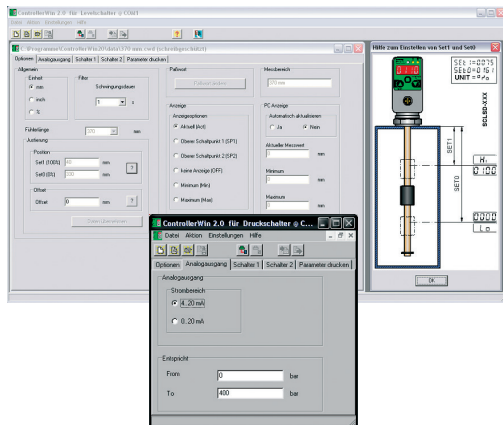

### Optical interface

- Switch status is shown

### Easy to use

- 3 large buttons
- Display of the unit

### Connect as required

- 2 switching outputs
- Analogue output
- 0...20 or 4...20 mA
- Freely programmable
- Scalable
- M12 connecting plugs



### No surge pipe necessary

- Electronic attenuation adjustable attenuation

### Proven measuring system

- High float dynamics
- Small design
- Universal usage

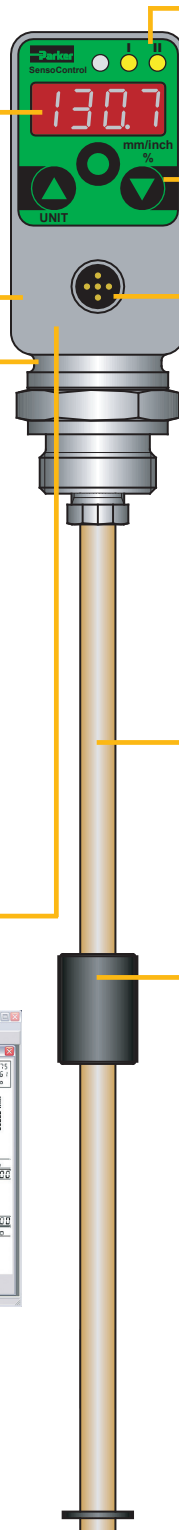

The Controller Family



# SCLSD LevelController

## Technical data

Input parameters	
Measuring component	Resistance reed chain with float
Connector thread	G3/4 BSPP; nickel-plated brass; ED soft seal NBR*
Parts in contact with substances	Brass; nickel-plated brass; NBR*
Temperature range of substance	-20...+85 °C / (-4...185°F)
Output values	
Switching point accuracy	± 1 % FS at 25 °C (77°F)
Display accuracy	± 1 % FS ± 1 Digit at 25 °C (77°F)
Response speed	≤ 700 ms
Resolution	7.5 mm
Float	
Material	NBR
Dimensions	For 250, 370 and 520: Ø 17.8 mm, Length 32 mm; 800 and 1000: Ø21 mm, Length 35 mm
Viscosity	Max. 250 cSt at 25 °C (77°F)
Density	at least 0.750 g/cm <sup>3</sup>
Level rod	
Material	Stainless steel
Dimensions	Ø 8 mm
Operating pressure	1 bar
Electrical connection	
Supply voltage V <sub>+</sub>	15...30 VDC nominal 24 VDC; Protection class 3
Electrical connection	M12x1; 4-pole; 5-pole; with gold-plated contacts
Short-circuit protection	Yes
Protection against wrong insertion	Yes
Overload protection	Yes
Current consumption	< 100 mA

Housing	
	Adjustable direction to 290°C
Material	Die-cast zinc Z 410; painted
Foil material	Polyester
Display	4-digit 7-segment LED; red; digit height 9 mm
Protection degree	IP67 DIN EN 60529
Ambient conditions	
Ambient temperature range	-20...+85 °C / (-4...185°F)
Storage temperature range	-40...+100 °C / (-40...212°F)
EM compatibility	
Disturbance emissions	EN 61000-6-3
Resistance to interference	EN 61000-6-2
Outputs	
Switching outputs	Two MOSFET high-side switches (PNP)
Contact functions	NO / NC contact; window / hysteresis function freely adjustable
Switching voltage	V <sub>+</sub> - 1.5 VDC
Switching current max.	0.5 A per switch
Short-circuit current	2.4 A per switch
Analogue output	0/4...20 mA; programmable; freely scalable RL ≤ (power supply - 8 V) / 20 mA (≤ 500 Ω)

\* different sealing material (FKM, EPDM etc.) upon request

# SCLSD LevelController

## Display possibilities

### Example of a percent display

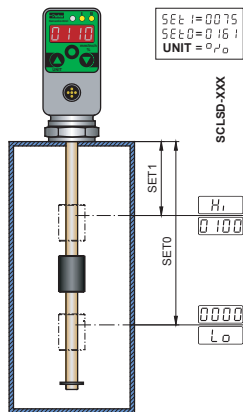

### Example of a mm display

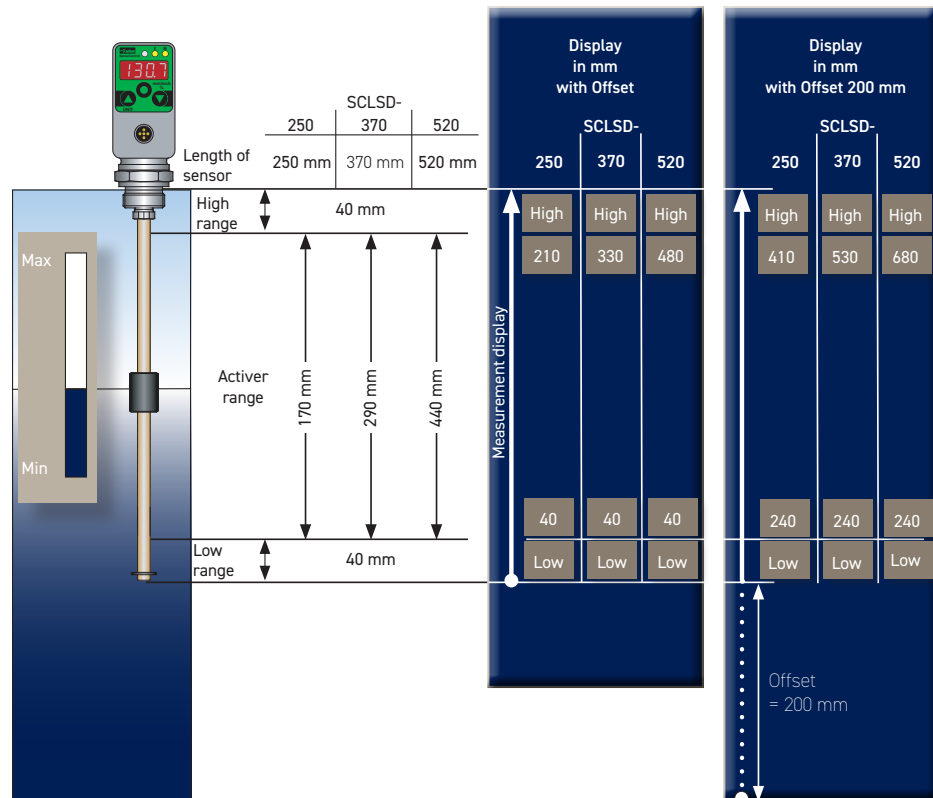

L1 Sensor length Measurement range	L2 active range	Display resolution Increment size	Incre- ment size	Lowest reset switch point RSP	Largest switch- ing value SP	Smallest adjustable difference between SP and RSP (SP-RSP)
250 mm	40...210 mm	1 mm	5 mm	40 mm	210 mm	5 mm
370 mm	40...330 mm	1 mm	5 mm	40 mm	330 mm	5 mm
520 mm	40...480 mm	1 mm	5 mm	40 mm	480 mm	5 mm
800 mm	40...760 mm	1 mm	10 mm	40 mm	760 mm	10 mm
1000 mm	40...960 mm	1 mm	10 mm	40 mm	960 mm	10 mm

## Pin assignment

### SCLSD-xxx-00-07

2 switching outputs; M12x1; 4-pole

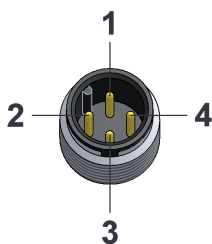

PIN	Assignment
1	V <sub>+</sub>
2	S2 out
3	0 V / GND
4	S1 out

### SCLSD-xxx-10-07

1 switching output, 1 analogue output, M12x1; 4-pole

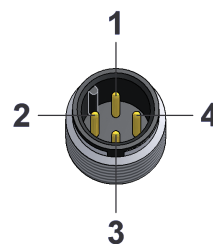

PIN	Assignment
1	V <sub>+</sub>
2	Analogue out
3	0 V / GND
4	S1 out



# SCLSD LevelController

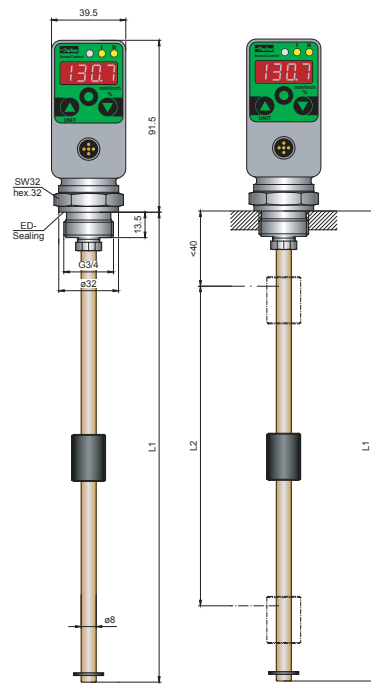

L1 = length of the sensor (mm)  
L2 = active range (mm)

## Order code

**SCLSD LevelController**  
**2 switching outputs;**  
**2 switching outputs Marine;**  
 (approved by DNV/GL/ABS)  
**no analogue output**  
 M12x1 connecting plug; 4-pole

SCLSD-xxx-00-07  
 SCLSD-xxx-00-07-MA

**1 switching output;**  
**1 switching output Marine;**  
 (approved by DNV/GL/ABS)  
**with analogue output**  
 M12x1 connecting plug; 4-pole

SCLSD-xxx-10-07  
 SCLSD-xxx-00-07-MA

**2 switching outputs;**  
**2 switching outputs Marine;**  
 (approved by DNV/GL/ABS)  
**with analogue output**  
 M12x1 connecting plug; 5-pole

SCLSD-xxx-10-05  
 SCLSD-xxx-10-05-MA

Length (Installation length L1 mm)

250 mm	250
370 mm	370
520 mm	520
800 mm	800
1000 mm	1000

## Accessories

**PC Programming Kit**  
**Flange adapter**  
 6-hole connection DIN 24557, part 2

SCSD-PRG-KIT  
 SCAF-3/4-90

## Connection cable and single plug

**Connection cable, assembled**  
 (open cable end)

SCK-400-xx-xx

Cable length (m)

2 m	02
5 m	05
10 m	10

### Connecting plug

M12 cable jack; straight — 45  
 M12 cable jack; 90° angled — 55

### Single connector

M12 cable jack; straight — SCK-145  
 M12 cable jack; 90° angled — SCK-155

The Controller Family

### SCLSD-xxx-10-05

2 switching outputs, 1 analogue output  
 M12x1; 5-pole

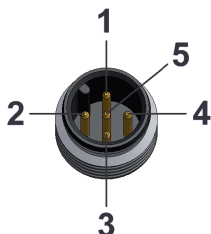

PIN	Assignment
1	V+
2	S2 out
3	0 V / GND
4	S1 out
5	Analogue out



# SCLTSD LevelTempController

## Device features

- Proven measuring system
- Pivoting
- Level display
- mm / inch / % display
- High and low display
- Analogue output
- Switching outputs
- Only one hole
- No surge pipe necessary
- Replacement for several mechanical switches

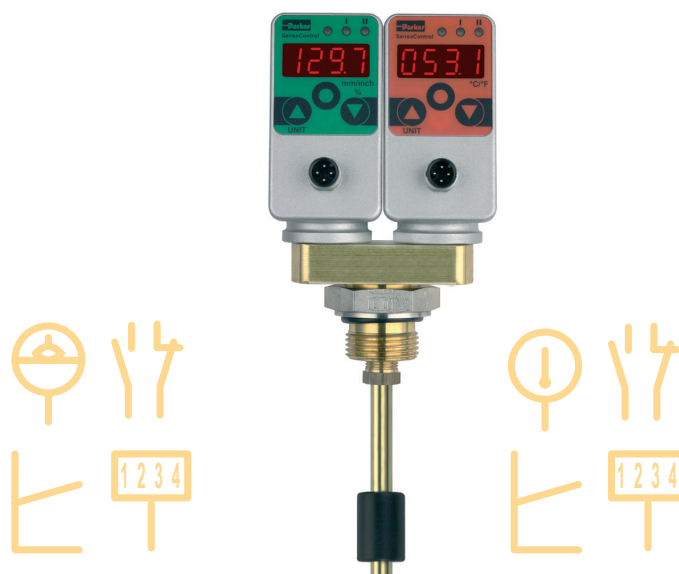

With the **LevelTempController**, you can set up and display the temperature and the level individually using a common platform. When monitoring the tank, this integration of level and temperature functionality opens up many possibilities.

The **LevelTempController** combines the functions of a level and temperature switch, a level and temperature sensor and a level and temperature indicator:

- Level and temperature display (thermometer / inspection glass)
- Switching outputs
- Analogue signal

### Level

The position of the float is finely ( $\geq 5$  mm) and continuously recorded and shown in the display in mm or inch. Because the level is continuously recorded, the danger of individual mechanical contacts "sticking" no longer exists. Therefore the operational reliability of the monitored plant is greatly increased.

Using the selectable percent display, the full level is uniformly displayed for the users, independent of the tank shape. An offset can also be entered (difference from the sensor to the tank bottom) to give a realistic indication of the level from the tank bottom.

Different uses can easily be implemented or corrected at a later date using the menu-driven level switching points.

As the switching point no longer needs to be specified at the time of order, the versions of mechanical level switches required is reduced.

### Temperature

The temperature in the substance is continuously recorded and displayed. The switching outputs can be individually set up just like the LevelController. Naturally all the convenient switching functions are available: window, hysteresis function and open / close as well as an analogue output for temperature.

### Reliable and safe

Parameters can be password protected to avoid unauthorised changes.

### Universal

Thanks to these easy switching functions (hysteresis and window functions, NC or NO functions), intelligent adjustments can be set on the LevelTempController which are normally not possible using a mechanical level switch. Therefore, many switches can be replaced with one controller. With the optional analogue outputs, the level and temperature can be monitored easily with a controller.

Level: e.g. for leakage monitoring

Temperature: e.g. coolers, heating, alarm, shutdown



# SCLTSD LevelTempController

## Application examples

### SCLSD



Application example  
Refer to page 61

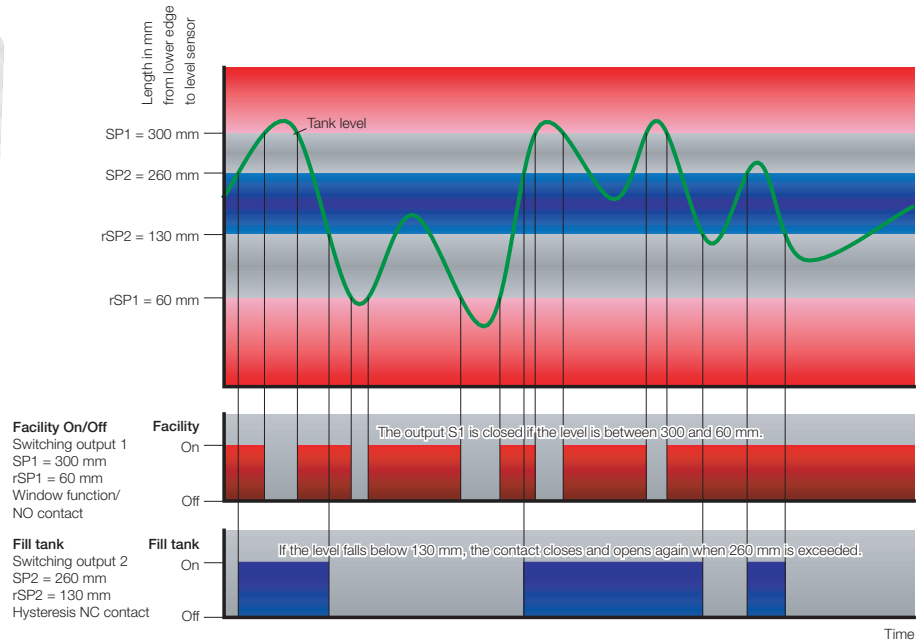

# SCLTSD LevelTempController

## Device features

### Everything at a glance

- Sloped display
- Digital display
  - Large
  - Illuminated
  - Switching points
- Display level
  - mm, inch, or %
  - Actual level
  - High and low display
- Temperature display
  - °C, °F
  - Current temperature

### Rugged

- Metal housing
- Waterproof
- Excellent interference immunity
- Vibration proof
- Shock proof

### Variable installation

- A coupling hole
- Compact size
- 290° pivotable
- G3/4 BSPP
- DIN flange

### Programming module

- Adjustable with ControllerWIN Software

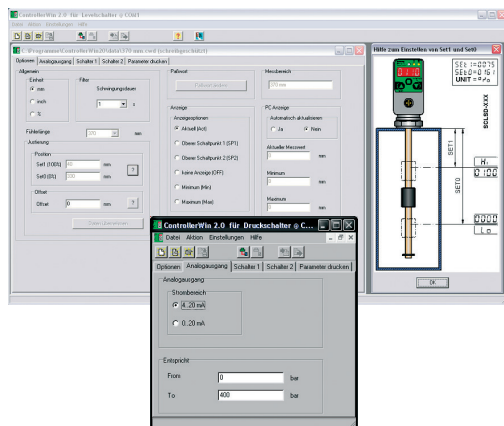

### Optical interface

- Switch status is shown

### Easy to use

- 3 large buttons
- Display of the unit

### Connect as required

- 2 switching outputs
- Analogue output
- 0...20 or 4...20 mA
- Freely programmable
- Scalable
- M12 connecting plugs



### Twin concept

- 2 in 1

### No surge pipe necessary

- Electronic attenuation adjustable attenuation

### Level

- Proven measuring system
- High float dynamics
- Small design
- Universal usage

### Temperature sensor

- Integrated in the rod end

# SCLTSD LevelTempController

## Technical data

Electrical connection	
Supply voltage $V_+$	15...30 VDC nominal 24 VDC; Protection class 3
Electrical connection	M12x1; 4-pole; 5-pole; with gold-plated contacts
Short-circuit protection	Yes
Protection against wrong insertion	Yes
Overload protection	Yes
Current consumption	< 100 mA
Housing	
	Adjustable direction to 290°C
Material	Die-cast zinc Z 410; painted
Foil material	Polyester
Display	4-digit 7-segment LED; red; digit height 9 mm
Protection degree	IP67 DIN EN 60529
Ambient conditions	
Ambient temperature range	-20...+85 °C / (-4...185°F)
Temperature range of substance	≤ 80 °C / (≤ 176°F)
Storage temperature range	-40...+100 °C / (-40...212°F)
EM compatibility	
Disturbance emissions	EN 61000-6-3
Resistance to interference	EN 61000-6-2
Outputs	
Switching outputs	Two MOSFET high-side switches (PNP)
Contact functions	NO / NC contact; window / hysteresis function freely adjustable
Switching voltage	$V_+ - 1.5$ VDC
Switching current max.	0.5 A per switch
Short-circuit current	2.4 A per switch
Analogue output	0/4 to 20 mA; programmable; freely scalable $RL \leq (V_+ - 8 \text{ V}) / 20 \text{ mA} (\leq 500 \Omega)$

## Level

Input parameters	
Measuring component	Resistance reed chain with float
Connector thread	G3/4 BSPP; nickel-plated brass; ED soft seal NBR*
Parts in contact with substances	Brass; nickel-plated brass; NBR*
Temperature range of substance	≤ 80 °C / (≤ 176°F)

Output values	
Switching point accuracy	± 1 % FS at 25 °C / (77°F)
Display accuracy	± 1 % FS ± 1 Digit at 25 °C / (77°F)
Response speed	≤ 700 ms
Resolution	7.5 mm

Float	
Material	NBR
Dimensions	For 250, 370 and 520: Ø 17.8 mm, Length 32 mm; 800 and 1000: Ø 21 mm, Length 35 mm
Viscosity	Max. 250 cSt at 25 °C / (77°F)
Density	at least 0.750 g/cm <sup>3</sup>

Level rod	
Material	Stainless steel
Dimensions	Ø 8 mm
Operating pressure	1 bar

Temperature	
Output values	
Switching point accuracy	± 0.35 % FS at 25 °C / (77°F)
Display accuracy	± 0.35 % FS ± 1 Digit at 25 °C / (77°F)
Response speed	≤ 300 ms
Analogue output	0/4...20 mA; programmable; freely scalable; 4...20 mA = -40...125 °C / (-40...257°F)

\* different sealing material (FKM, EPDM etc.) upon request

# SCLTSD LevelTempController

## Display possibilities

Example of a percent display

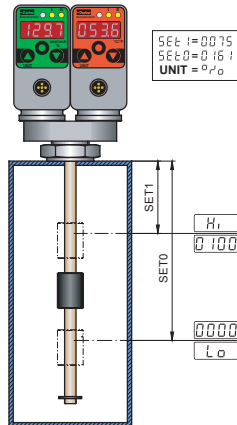

Example of a mm display

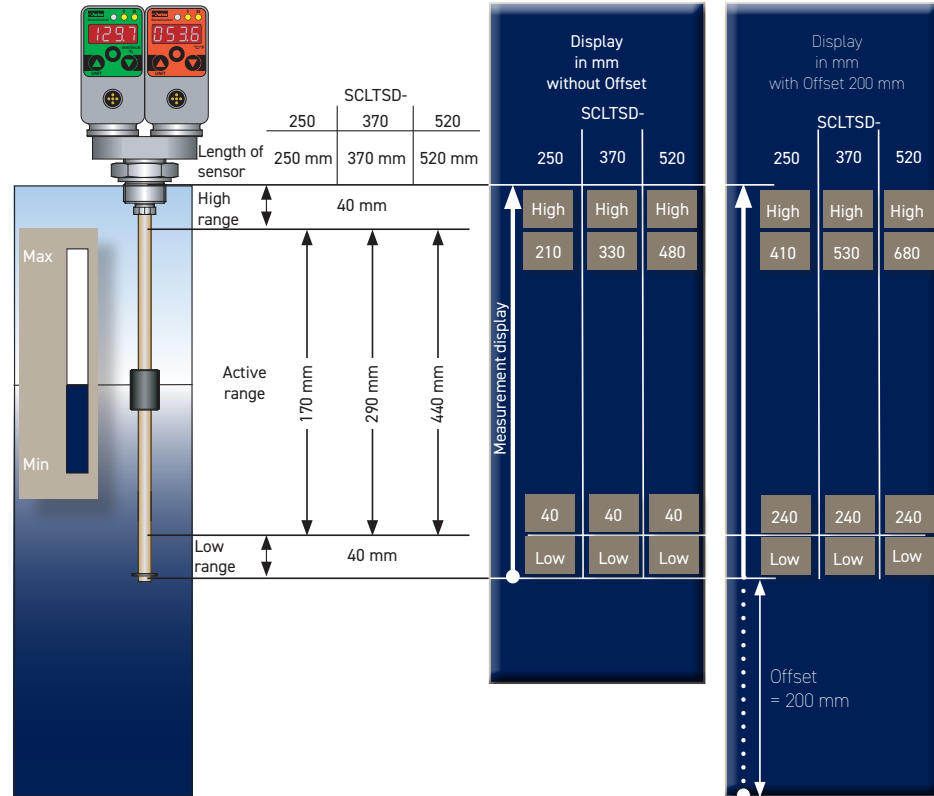

L1 Sensor length Measurement range	L2 active range	Display resolution Increment size	Increment size	Lowest reset switch point RSP	Largest switching value SP	Smallest adjustable difference between SP and RSP (SP-RSP)
250 mm	40...210 mm	1 mm	5 mm	40 mm	210 mm	5 mm
370 mm	40...330 mm	1 mm	5 mm	40 mm	330 mm	5 mm
520 mm	40...480 mm	1 mm	5 mm	40 mm	480 mm	5 mm
800 mm	40...760 mm	1 mm	10 mm	40 mm	760 mm	10 mm
1000 mm	40...960 mm	1 mm	10 mm	40 mm	960 mm	10 mm

## Pin assignment

SCLTSD-xxx-00-07 for temperature and level  
2 switching outputs; M12x1; 4-pole

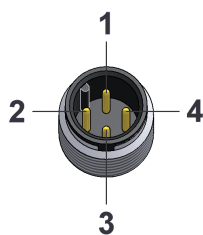

PIN	Assignment
1	V <sub>+</sub>
2	S2 out
3	0 V / GND
4	S1 out

SCLTSD-xxx-10-07 for temperature and level  
1 switching output, 1 analogue output, M12x1; 4-pole

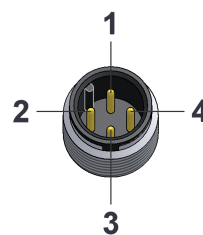

PIN	Assignment
1	V <sub>+</sub>
2	Analogue out
3	0 V / GND
4	S1 out



# SCLTSD LevelTempController

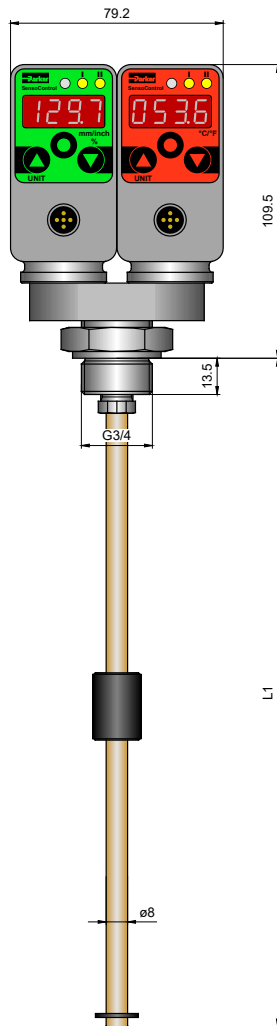

L1 = length of the sensor (mm)  
L2 = active range (mm)

## Order code

### SCLTSD LevelTempController

**2 switching outputs;**  
**2 switching outputs Marine;**  
(approved by DNV/GL/ABS)  
**no analogue output**  
M12x1 connecting plug; 4-pole

SCLTSD-xxx-00-07  
SCLTSD-xxx-00-07-MA

**1 switching output;**  
**1 switching output Marine;**  
(approved by DNV/GL/ABS)  
**with analogue output**  
M12x1 connecting plug; 4-pole

SCLTSD-xxx-10-07  
SCLTSD-xxx-10-07-MA

**2 switching output;**  
**2 switching output Marine**  
(approved by DNV/GL/ABS)  
**with analogue output**  
M12x1 connecting plug; 5-pole

SCLTSD-xxx-10-05  
SCLTSD-xxx-10-05-MA

Installation length (L1 mm)

250 mm	250
370 mm	370
520 mm	520
800 mm	800
1000 mm	1000

## Accessories

**PC Programming Kit**

SCSD-PRG-KIT

**Flange adapter**

SCAF-3/4-90

6-hole connection DIN 24557, part 2

## Connection cable and single plug

**Connection cable, assembled**

SCK-400-xx-xx

(open cable end)

**Cable length (m)**

2 m	02
5 m	05
10 m	10

**Connecting plug**

M12 cable jack; straight	45
M12 cable jack; 90° angled	55

**Single connector**

M12 cable jack; straight	SCK-145
M12 cable jack; 90° angled	SCK-155

The Controller Family

**SCLTSD-xxx-10-05** for temperature and level

2 switching outputs, 1 analogue output; M12x1; 5-pole

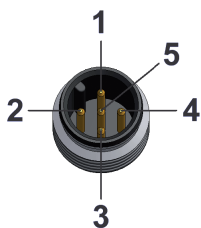

PIN	Assignment
1	V <sub>+</sub>
2	S2 out
3	0 V / GND
4	S1 out
5	Analogue out



# SCOTC OilTankController

## Device features

- Proven measuring system
- Level and temperature display
- mm / inch / % display
- High and low display
- Only one hole
- Continuous level measurement
- Connection
  - Filling coupling
  - Air filter
  - Low pressure
- No surge pipe necessary

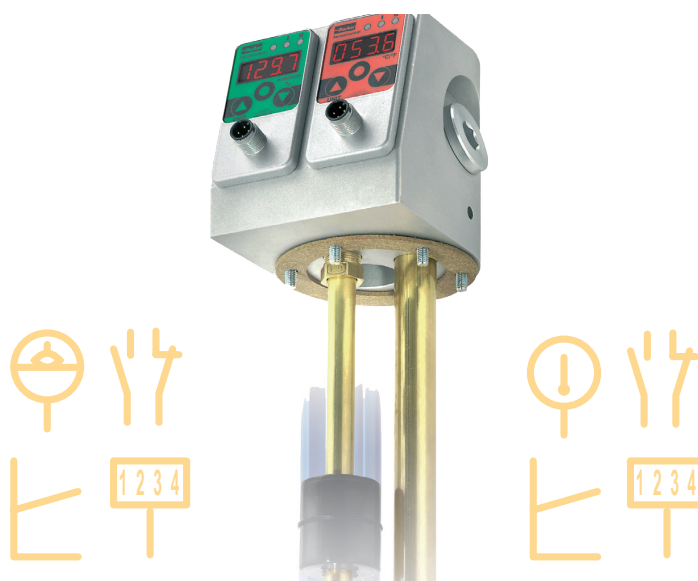

In addition to the **LevelTempController**, the **OilTankController** also offers standardised connections for an air filter and a fill coupling.

When monitoring the tank for series use, this integration of level and temperature functionality together with air filter and fill adapter port opens up many possibilities. An additional connecting hole is required for the four functions.

**The OilTankController combines the functions of a level and temperature switch, a level and temperature sensor and a level and temperature display:**

- Level and temperature display (thermometer / inspection glass)
- Switching outputs
- Analogue signal

### Level

The position of the float is finely ( $\geq 5$  mm) and continuously recorded and shown in the display in mm or inch. Because the level is continuously recorded, the danger of individual mechanical contacts "sticking" no longer exists. Therefore the operational reliability of the monitored plant is greatly increased.

Using the selectable percent display, the full level is uniformly displayed for the users, independent of the tank shape. An offset can also be entered (difference from the sensor to the tank bottom) to give a realistic indication of the level from the tank bottom.

Different uses can easily be implemented or corrected at a later date using the menu-driven level switching points.

As the switching point no longer needs to be specified at the time of order, the versions of mechanical level switches required is reduced.

### Temperature

The temperature in the substance is continuously recorded and displayed. The switching outputs can be individually set up just like the LevelController. Naturally all the convenient switching functions are available: window, hysteresis function and open/close as well as an analogue output for temperature.

### Reliable and safe

Parameters can be password protected to avoid unauthorised changes.

### Universal

In combination with the comfortable switch functions like hysteresis and window function, open/close contact functions **LevelTempController** intelligent settings can be made which are not possible with a mechanical level/temperature switch. Therefore, many switches can be replaced with one controller. With the optional analogue outputs, the level and temperature can be monitored easily with a controller.

Level: e.g. for leakage monitoring

Temperature: e.g. coolers, heating, alarm, shutdown

# SCOTC OilTankController

## Application examples

### SCLSD



Application example  
Refer to page 61

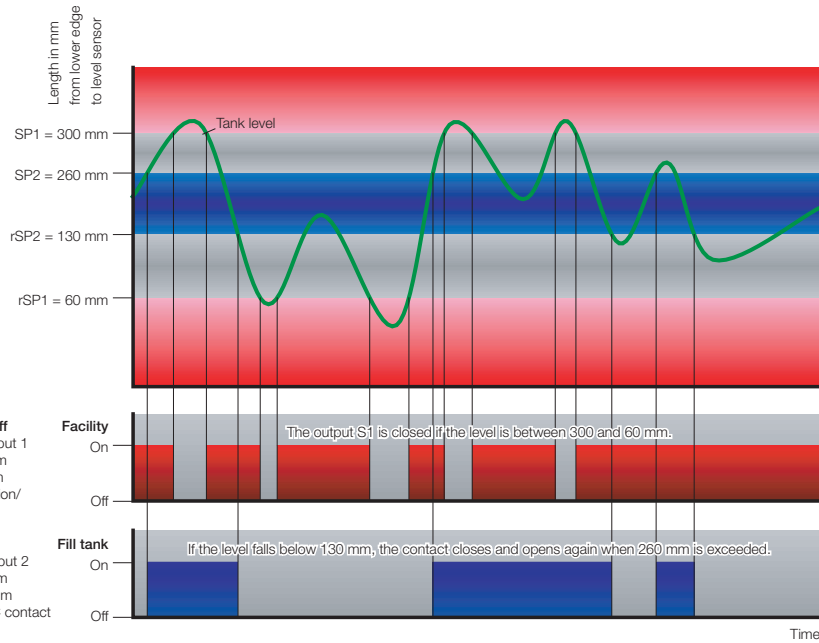

# SCOTC OilTankController

## Device features

### Getting to the point

- Compact construction (4 in 1)
- Easy adjustment of the switching points using the menu
- Analogue output
- Safety control
- Cost savings in the logistics, assembly and maintenance

### Level and temperature

- Display
- Adjustable switching output
- Analogue output

### The extended version

with safety control

- Additional fixed switching contacts
- Level min/max
- Temperature too high

### Real fill level

- The level controller continuously measures the position of the float and continuously shows the position in the display.
- Up to 1000 mm

### No surge pipe necessary

- Electronic attenuation
- adjustable attenuation

### Temperature sensor

- Integrated in the rod end

### 6-hole standard for

- Ventilation filter\* (DIN 24557, part 2)

### G3/4 BSPP for

- Filling coupling\*

### G1/8 BSPP for

- Low pressure switch\*
- Clogging indicator\*

### 6-hole standard for

- Tank connection (DIN 24557, part 2)

### Filling tube

### No whirl-up

- Whirl-up protection

### Programming module

- Adjustable with ControllerWIN Software

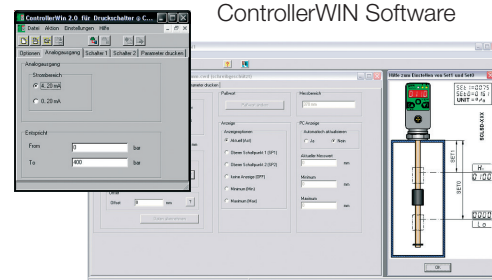

\* Venting filter, filling coupling, low pressure switch and clogging indicator are not included in the delivery.



# SCOTC OilTankController

## Technical data

SCOTC	250	370	520	800	1000
Tank installation length	250 mm	370 mm	520 mm	800 mm	1000 mm
Adjustment range	40...210 mm	40...330 mm	40...480 mm	40...760 mm	40...960 mm

Electrical connection	
Supply voltage $V_+$	15 to 30 VDC nominal 24 VDC; Protection class 3
Electrical connection	M12x1; 4-pole; 5-pole; with gold-plated contacts
Short-circuit protection	Yes
Protection against wrong insertion	Yes
Overload protection	Yes
Current consumption	< 100 mA
Housing	
Material	Die-cast zinc Z 410; painted Aluminium
Foil material	Polyester
Display	4-digit 7-segment LED; red; digit height 9 mm
Protection degree	IP67 DIN EN 60529
Ambient conditions	
Ambient temperature range	-20...+80 °C / (-4...176°F)
Temperature range of substance	≤ 80 °C / (≤ 176°F)
Storage temperature range	-40...+100 °C / (-40...212°F)
Sampling period	300 ms
Display refresh	1 s
EM compatibility	
Disturbance emissions	EN 61000-6-3
Resistance to interference	EN 61000-6-2
Outputs	
Switching outputs	Two MOSFET high-side switches (PNP)
Contact functions	NO / NC contact; window / hysteresis function freely adjustable
Switching voltage	$V_+$ -1.5 VDC
Switching current max.	0.5 A per switch
Short-circuit current	2.4 A per switch
Optional analogue output	
Measuring range	0/4...20 mA; programmable
Response speed (0 to 95%)	≤ 300 ms
Error	± 1 % FS
Load	≤ 500 Ω from $V_b$ > 18 VDC

Level	
Input variables	
Measuring component	Reed chain resistance
Connector thread	6 hole standard- DIN 24557, part 2
Output variables	
Switching point accuracy	± 1 % FS at 25 °C / (77°F)
Display accuracy	± 1 % FS ± 1 Digit at 25 °C / (77°F)
Response speed	≤ 700 ms
Resolution	5 mm...520 mm; 10 mm > 520 mm
Float	
Material	Polypropylene
Dimensions	Ø 35 mm, Length 40 mm
Level rod	
Material	Brass
Dimensions	Ø 12 mm
Operating pressure	1 bar max.
Optional Lo-Hi contact (S3 out)	
Alarm contact	In series switched Lo and Hi NC contact
Maximum load current	0.7 A
Temperature	
Input variables	
Sensor element	PT1000
Filling tube	Ø 18x1 mm
Response time	$\tau_{0.9} = 60$ s
Output variables	
Switching point accuracy	± 0.5 % FS at 25 °C / (77°F)
Display accuracy	± 0.5 % FS ± 1 Digit at 25 °C / (77°F)
Response speed	≤ 300 ms
Analogue output	0/4...20 mA; programmable; freely scalable; 4...20 mA = -40...125 °C / (-40...257°F)
Optional temperature switch (S3 out)	
Alarm contact with > 65 °C	Open contact
Maximum charging current	0.7 A

# SCOTC OilTankController

## Pin assignment

### Without safety-control-output

**SCOTC-xxxx-00-07**  
for temperature and level  
2 switching outputs  
M12x1; 4-pole

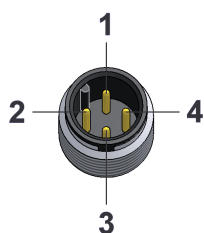

PIN	Assignment
1	V <sub>+</sub>
2	S2 out
3	0 V / GND
4	S1 out

### SCOTC-xxxx-10-07

for temperature and level  
1 switching outputs, 1 analogue output  
M12x1; 5-pole

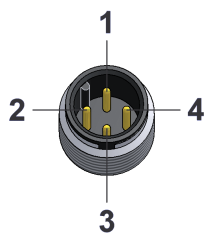

PIN	Assignment
1	V <sub>+</sub>
2	Analogue out
3	0 V / GND
4	S1 out

### SCOTC-xxxx-10-05

for temperature and level  
2 switching outputs, 1 analogue output  
M12x1; 5-pole

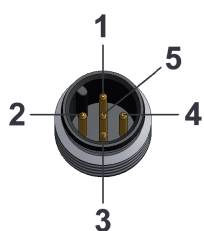

PIN	Assignment
1	V <sub>+</sub>
2	S2 out
3	0 V / GND
4	S1 out
5	Analogue out

### With safety-control-output

**SCOTC-xxxx-00-05**  
Level:  
Two variable switching outputs,  
One fixed safety-control-output level min/max;  
M12x1; 5-pole

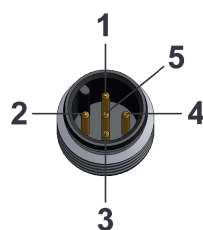

PIN	Assignment
1	V <sub>+</sub>
2	S2 out
3	0 V / GND
4	S1 out
5	S3 out (L-Low / L-High)

### SCOTC-xxxx-00-05

Temperature:  
Two variable switching outputs,  
One fixed safety-control-output temperature max. 65 °C  
M12x1; 5-pole

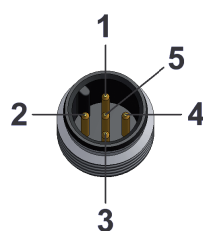

PIN	Assignment
1	V <sub>+</sub>
2	S2 out
3	0 V / GND
4	S1 out
5	S3 out (T-High)

L1 Sensor length Measurement range	L2 active range	Display resolu- tion increment size	Increment size	Lowest reset switch point RSP	Largest switch- ing value SP	Smallest adjustable difference between SP and RSP (SP-RSP)
250 mm	170 mm	1 mm	5 mm	40	210	5 mm
370 mm	290 mm	1 mm	5 mm	40	330	5 mm
520 mm	440 mm	1 mm	5 mm	40	480	5 mm
800 mm	720 mm	1 mm	10 mm	40	760	10 mm
1000 mm	920 mm	1 mm	10 mm	40	960	10 mm



# SCOTC OilTankController

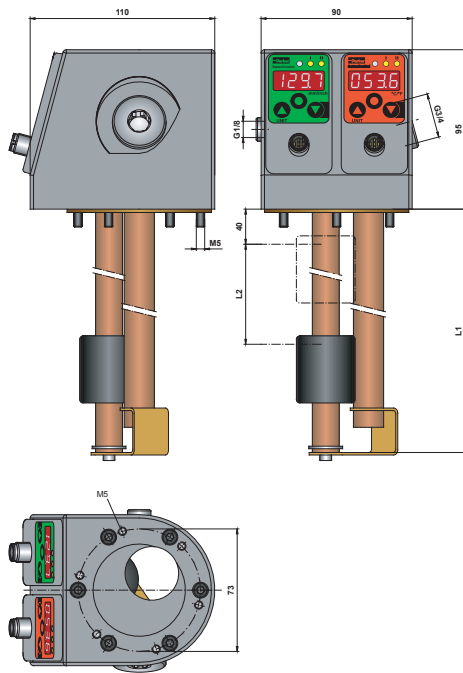

L1 = length of the sensor (mm)  
L2 = active range (mm)

## Order code

### SCOTC OilTankController \*

**2 switching outputs; no analogue output** SCOTC-xxxx-00-07  
M12x1 connecting plug; 4-pole

**2 switching outputs; with analogue output** SCOTC-xxxx-10-07  
M12x1 connecting plug; 4-pole

**1 switching output; with analogue output** SCOTC-xxxx-10-05  
M12x1 connecting plug; 5-pole

**3 switching outputs; no analogue output** SCOTC-xxxx-00-05  
M12x1 connecting plug; 5-pole  
with safety control

Length (Installation length L1 mm)

250 mm	250
370 mm	370
520 mm	520
800 mm	800
1000 mm	1000

## Accessories

**PC Programming Kit**

**SCSD-PRG-KIT**

## Connection cable and single plug

### Connection cable, assembled

**SCK-400-xx-xx**

(open cable end)

#### Cable length (m)

2 m	02
5 m	05
10 m	10

#### Connecting plug

M12 cable jack; straight	45
M12 cable jack; 90° angled	55

### Single connector

M12 cable jack; straight	<b>SCK-145</b>
M12 cable jack; 90° angled	<b>SCK-155</b>

\* Venting filter, filling coupling, low pressure switch and clogging indicator are not included in the delivery.

# SCK cable

## Device features

- One cable for all
- Compact size
- Interference-free
- Compatible to:
  - Sensors
  - Controllers
- M12 plug
- DIN EN 175301 (Device plug)
- Available in a variety of lengths



Accessories

The **SensoControl**® cable was designed for use with the industrial sensors and switches.

Thus the M12 cable and M12 plug are

- Compact
- Shielded
- Five-pole

### 5-pole version

The 5-pole cable is suitable for both 4-pole and 5-pole connections. The sensor variants with a 4-pole connector are fully compatible with the 5-pole cable.

So despite different pin counts on the pressures switch (Controller Family SCxSD and SCOTC) and sensors, it is always possible to use just one cable version (5-pole) regardless of the plug version.

The SCK-400-xxx-x5 cables fit to all components in this catalogue using M12 connectors.

### Shielding

Shielding protects against interference and ensures improved operational safety.

- Higher EMC protection

## Pin assignment

### SCK-400-xx-x5

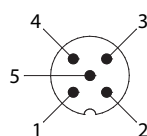

PIN			
1	bn	brown	braun
2	wh	white	weiß
3	bu	blue	blau
4	bk	black	schwarz
5	gy	grey	grau

### SCK-400-xx-56



PIN			
1	ye	yellow	gelb
2	gn	green	grün
3	bn	brown	braun

# SCK cable

Accessories

## Connection cable

SCK-400-xx-45

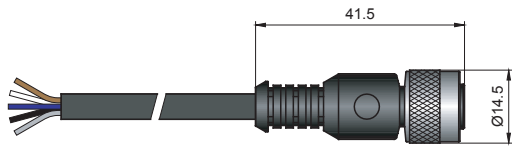

SCK-400-xx-55

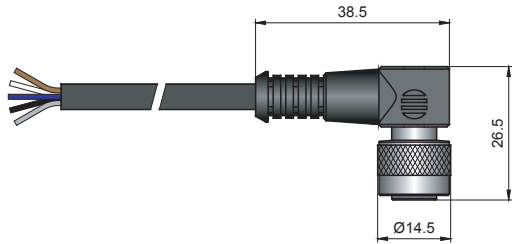

SCK-400-xx-56

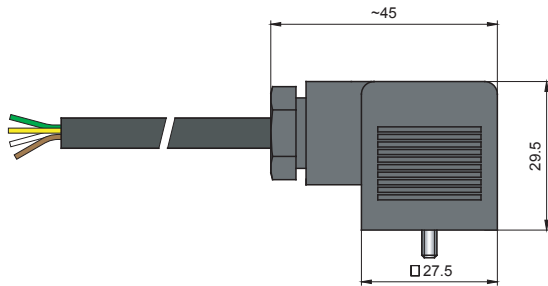

## Single connector

SCK-145

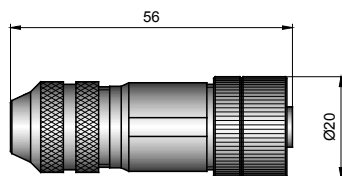

SCK-155

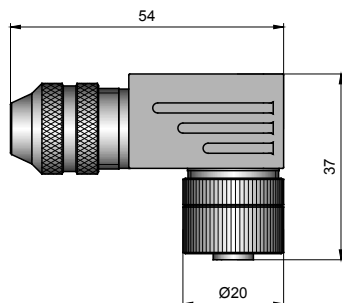

## Single connector

SCK-006 (Device plug)

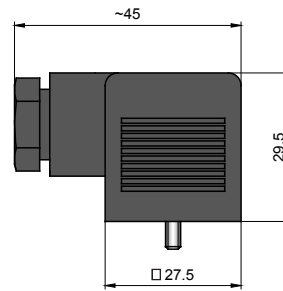

## Connection cable and single plug

### Connection cable, assembled

(open cable end)

#### Cable length (m)

2 m	02
5 m	05
10 m	10

#### Connecting plug

M12 cable jack; straight	45
M12 cable jack; 90° angled	55
Cable socket DIN EN 175301-803 Form A (old DIN 43650)	56

### Single connector

M12 cable jack; straight	SCK-145
M12 cable jack; 90° angled	SCK-155
Cable socket DIN EN 175301-803 Form A (old DIN 43650)	SCK-006



# SCA adapter

## SCA-1/4 reduction adapter

The SCA-1/4 provides compatibility for earlier sensor versions with the hydraulic connection M22x1.5 or G1/2 BSPP.

- When replacing earlier versions

This allows facilities to be updated without major planning overhead.

SCA-1/4-M22x1.5-ED  
SCA-1/4-ED-1/2-ED

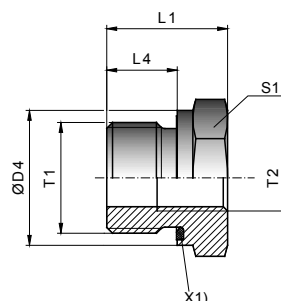

X1) EOLASTIC-seal

	T1	T2	ØD4	L1	L4	S1	Weight (g/1 St)	PN (bar) <sup>1)</sup>	DF **
<b>SCA-1/4-M22x1.5-ED</b>	M22x1.5	G1/4 BSPP	27	24	14	27	56	400	4
<b>SCA-1/4ED1/2-ED</b>	G1/2 BSPP	G1/4 BSPP	27	24	14	27	56	400	4

## SCA-1/4 attenuation adapter

System-related pressure spikes are reduced with the SCA-1/4-EDX-1/4-D.

- Attenuation for pressure peaks

The G1/2 BSPP version ensures compatibility for earlier sensor versions to the G1/2 BSPP hydraulic connection.

- When replacing earlier versions

SCA-1/4-EDX-1/4-D

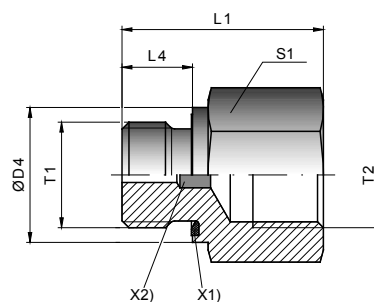

X1) EOLASTIC-seal

	T1	T2	ØD4	L1	L4	S1	Weight (g/1 St)	PN (bar) <sup>1)</sup>	DF **
<b>SCA-1/4EDX1/4-D</b>	G1/4A BSPP	G1/4 BSPP	19	34	12	22	61	630	3.5

# SCA adapter

Accessories

## SCPSD flange adapter SCAF-1/4-40 for mechanical pressure switch

When replacing existing mechanical pressures switches with 40x40mm flange connections SCAF-1/4-40

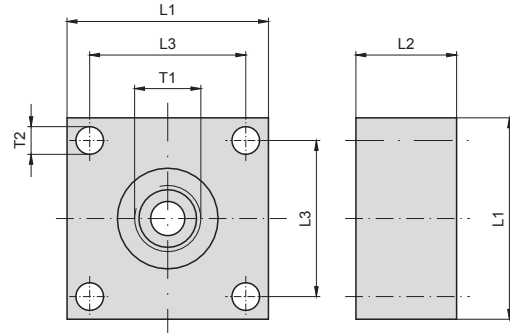

**SCAF-1/4-40**  
for mechanical pressure switch

**SCAF-1/4-40**

T1	T2	L1	L2	L3	Weight (g/1 St)	PN (bar) <sup>1)</sup> Alu	DF **
G1/4 BSPP	5.5	40	20	31	15	400	4

## SCLSD/SCLTSD flange adapter SCAF-3/4-90 6-hole connection DIN 24557, part 2

For LevelController and LevelTemp Controller (SCLSD and SCLTSD), a compatibility to the tank connections 6-hole DIN 24557, part 2, is ensured. SCAF-3/4-90

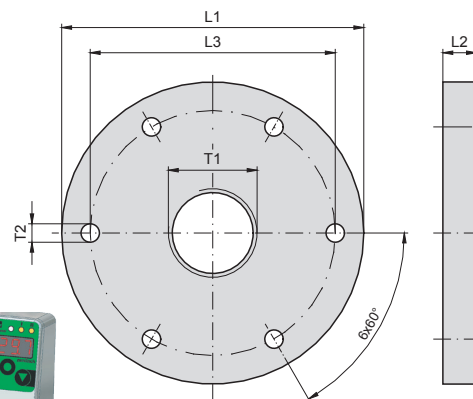

**SCAF-3/4-90**  
6-hole connection DIN 24557, part 2

**SCAF-3/4-90**



T1	T2	L1	L2	L3	Weight (g/1 St)	Material
G3/4 BSPP	5.5	90	10	73	520	Stainless steel

\*\* DF = Design Factor (safety factor)



# ControllerWIN software

## Device features

- Suitable for the Controller Family
- Simple adjustment of all parameters
- Saving of the parameters
- Adjustment with PC/laptop
  - at the workbench
  - at the desk
  - in the plant

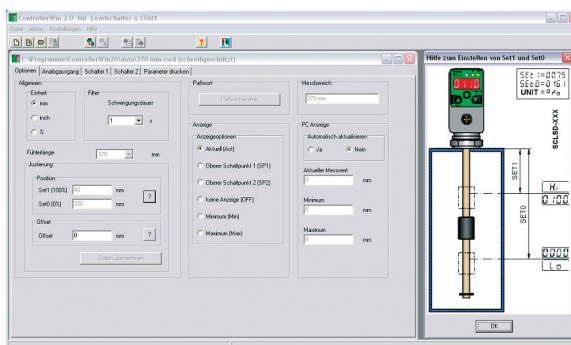

The ControllerWIN software allows the adjustment and saving of all parameters, including:

- Switching points
- NO / NC contact function
- Window / hysteresis
- Scaling of the analogue output
- Passwords

From the Controller Family product series:

- SCPSD
- SCLSD
- SCLTSD
- SCOTC

## Function

A no-contact infra-red interface is used to compare the data with the corresponding functional controller. This can take place directly in the facility or externally using a power supply unit (not included in the delivery).

- It is not necessary to disconnect the power supply or pull the cable out (operations are not interrupted).

A programming adapter is connected to the corresponding controller and the data is transmitted to a PC.

The SCSD-PRG\_KIT programming kit includes all components (adapter, software and power supply) required for adjusting the controller with the PC or laptop:

- At the workbench
- At the desk
- In the plant

## Application

- Saving and logging the adjusted values
- Programming multiple controllers
- Easy exchange of existing controllers

The programming kit is the ideal solution in each of these cases.

# ControllerWIN software

Accessories

## Technical data

### System requirements

Operating system	PC / laptop connection	Controller connection
WIN 98/2000/ME/NT/XP	RS232 (USB using conventional adapter)	Parker infra-red interface SCxSD/SCOTC

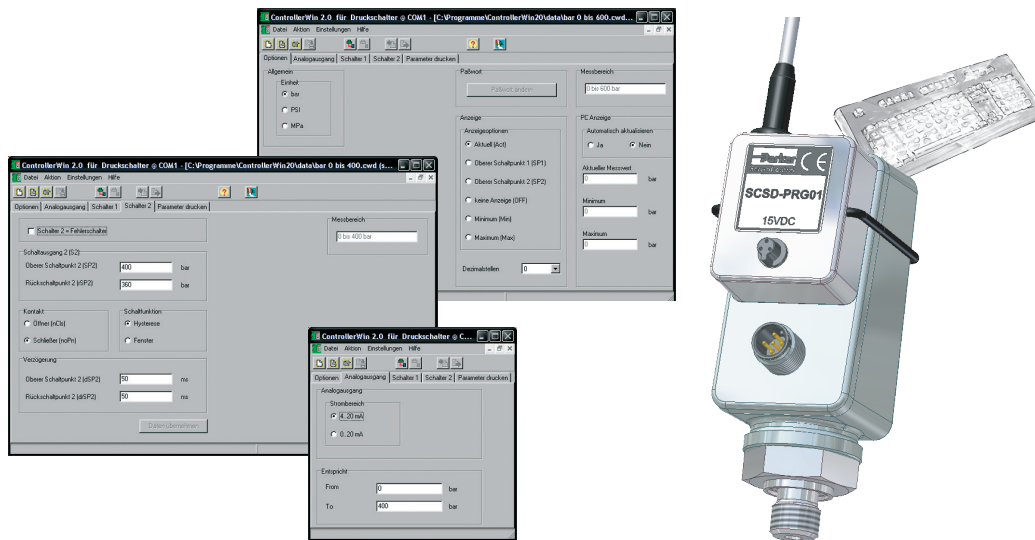

### Accessories for:

PressureController	LevelController	LevelTempController	OilTankController
Pressure display and monitoring	Level indication and monitoring	Level and temperature display and monitoring	

### Order code

PC Programming KIT

SCSD-PRG-KIT



# Installation and safety instructions

**CE** The CE mark indicates a high-quality device that complies with the European directive 89/336/EEG and EMVG.

We confirm that these products comply with the following standards:

### EMC

- Electromagnetic emission: EN 61000-6-3
- Electromagnetic immunity: EN 61000-6-2

### Important

- Electromagnetic disturbances can affect the desired signal.
- Apply all general EMC strategies when planning facilities and machines.
- We recommend using shielded cables (SCK-400-xx-x5) in order to achieve better EMC immunity.
- Make sure you route analogue and data cables so that there is a sufficient gap between them.
- An effective earthing strategy will help you to avoid measuring errors.

Always connect metal housings with the reference ground. The PE protective earth should have a low-ohm connection. According to VDE 0701, the PE resistance must be measured.

### Power feed voltage



Each sensor series specifies the recommended feed voltage to be used when operating the standard sensor. We recommend using a low-noise, high-quality, constant voltage source. Certain specifications (such as sensitivity and thermal sensitivity shift) may change when other power feeds are used. Each sensor is trimmed to its peak performance. The sensor's performance may change when other power feed types are used. Make sure you comply with the polarity and earthing regulations.

Improperly connected feed wires can damage sensors and amplifiers!

If one pole of the sensor feed is automatically earthed via the sensor's processing system, then you should avoid an additional earth on the sensor signal wire. This would cause the sensor to short circuit and damage the sensor.

Do not apply feed-in voltage to the output wires. This will permanently damage the sensors!



The sensor will be damaged if the data sheet specifications and maximum recommended feed voltage levels are exceeded!

### Compatibility with media (substances)

**SensoControl®** products which come into contact with the substance are not produced in an oil-free or fat-free environment.

Therefore these products are **not** suitable for use in applications which use explosive mixtures of oil and gas (e.g. oxygen or compression). This could lead to a danger of explosion!

### Danger of explosion!

Only use substances which are compatible with the components that come into contact with the substance. (Refer to the data sheets)

Please consult with the plant manufacturer or the manufacturer of the substance if you have any questions. (Refer to catalogue 4100 chapter C).

### Pressure range selection

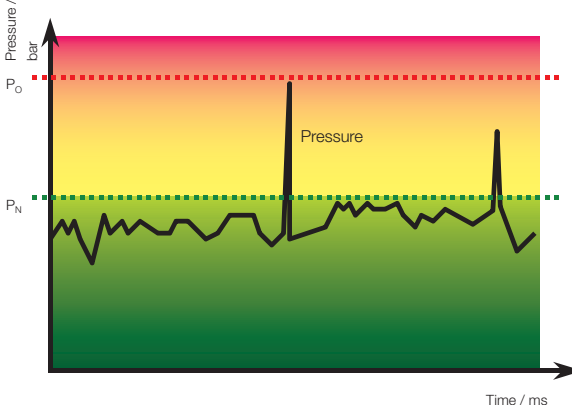

When selecting pressure components, ensure that the overload pressure  $P_{max}$  will not be exceeded.

It is possible that the pressure cell can be deformed when the overload pressure  $P_{max}$  is exceeded (depending on the duration, frequency and level of the pressure spike).

Note: The "diesel effect" caused by entrapped air can result in pressure spikes that far exceed the maximum pressure.

The nominal pressure  $P_N$  of the pressure component (sensor/switch) should be higher than the nominal pressure of the system to be measured.

# Appendix

## Temperature conversion table

Celsius to Fahrenheit

°C	°F
150	302
145	293
140	284
135	275
130	266
125	257
120	248
115	239
110	230
105	221
100	212
95	203
90	194
85	185
80	176
75	167
70	158
65	149
60	140
55	131
50	122
45	113
40	104
35	95
30	86
25	77
20	68
15	59
10	50
5	41
0	32
-5	23
-10	14
-15	5
-20	-4
-25	-13
-30	-22
-35	-31
-40	-40
-45	-49
-50	-58

Fahrenheit to celsius

°F	°C
340	171
330	166
320	160
310	154
300	149
290	143
280	138
270	132
260	127
250	121
240	116
230	110
220	104
210	99
200	93
190	88
180	82
170	77
160	71
150	66
140	60
130	54
120	49
110	43
100	38
90	32
80	27
70	21
60	16
50	10
40	4
30	-1
20	-7
10	-12
0	-18
-10	-23
-20	-29
-30	-34
-40	-40
-50	-46
-60	-51

## Pressure conversion table

bar to psi

bar	psi
1000	14505
800	11604
600	8703
500	7253
400	5802
250	3626
160	2321
100	1451
60	870
40	580
35	508
25	363
16	232
10	145
6	87
4	58
2.5	36
1.6	23
1	15

psi to bar

psi	bar
10000	689
9000	620
7000	483
6000	414
4000	276
3000	207
2500	172
1000	69
900	62
600	41
500	34
400	28
250	17
150	10.3
100	6.9
90	6.2
60	4.1
40	2.8
25	1.7
10	0.7

## Examples

### Temperature conversion

Initial value: 100  
 °C in °F: 212 °F  
 °F in °C: 37.78 °C

### Pressure conversion

Initial value: 35  
 bar in psi: 507.675 psi  
 psi in bar: 2.41296 bar

# Appendix

## Index

SCxSD	48-49	SCPSD-...	59-64
SC-910	37	SCPSi	29-31
SC-911	37	SCQ-150-10-07	37
SC-912	37	SCSD-PRG-KIT	91
SCA-1/4EDX1/2-ED	80	SCTSD-L-...	65-68
SCA-1/4EDX1/4-D	80	SCVF-...	51-56
SCA-1/4-M22x1.5-ED	80		
SCAF-1/4-40	81		
SCAF-3/4-90	81		
SCAQ-150	37		
SCAQ-GI-R1/2	37		
SCFT-...	38-41		
SCK-006	79		
SCK-145	79		
SCK-155	79		
SCK-400-...	79		
SCLSD-...	60-65		
SCLTSD-...	66-71		
SCOTC-...	72-77		
SCP03-...	12-16		
SCP04-...	17-21		
SCP08	22-23		
SCP09	24-28		
SCP10	29-33		
SCP11	34-37		

## Old and new references

Old order number	New order number	Old order number	New order number
SCK-007	SCK-145	SCP-xxx-x4-0x-MO	SCP03-xxx-x4-0x
SCK-045	SCK-145	SCP-xxx-x4-0x	SCP03-xxx-x4-0x
SCK-047	SCK-145	SCP-xxx-10-06	SCP03-xxx-14-06 + SCA-1/4-M22x1.5-ED
SCK-055	SCK-155	SCP-xxx-10-07	SCP03-xxx-14-07 + SCA-1/4-M22x1.5-ED
SCK-057	SCK-155	SCP-xxx-12-06	SCP03-xxx-14-06 + SCA-1/4-ED-1/2-ED
SCK-147	SCK-145	SCP-xxx-12-07	SCP03-xxx-14-07 + SCA-1/4-ED-1/2-ED
SCK-157	SCK-155	SCP-xxx-20-06	SCP03-xxx-24-06 + SCA-1/4-M22x1.5-ED
SCK-200-xxx-45	SCK-400-xxx-45	SCP-xxx-20-07	SCP03-xxx-24-07 + SCA-1/4-M22x1.5-ED
SCK-200-xxx-47	SCK-400-xxx-45	SCP-xxx-22-06	SCP03-xxx-24-06 + SCA-1/4-ED-1/2-ED
SCK-200-xxx-55	SCK-400-..55	SCP-xxx-22-07	SCP03-xxx-24-07 + SCA-1/4-ED-1/2-ED
SCK-200-xxx-56	SCK400-xxx-56	SCP-xxx-30-06	SCP03-xxx-34-06 + SCA-1/4-M22x1.5-ED
SCK-200-xxx-57	SCK-400-..55	SCP-xxx-30-07	SCP03-xxx-24-07 + SCA-1/4-M22x1.5-ED
SCK-400-xxx-06	SCK-400-xxx-56	SCP-xxx-32-06	SCP03-xxx-34-06 + SCA-1/4-ED-1/2-ED
SCK-400-xxx-07	SCK-400-xxx-45	SCP-xxx-32-07	SCP03-xxx-24-07 + SCA-1/4-ED-1/2-ED
SCK-400-xxx-47	SCK-400-xxx-45	SCP-xxx-40-06	SCP03-xxx-44-06 + SCA-1/4-M22x1.5-ED
SCK-400-xxx-57	SCK-400-..55	SCP-xxx-40-07	SCP03-xxx-44-07 + SCA-1/4-M22x1.5-ED
SCPSD-xxx-04-05	SCPSD-xxx-04-17	SCP-xxx-42-06	SCP03-xxx-44-06 + SCA-1/4-ED-1/2-ED
SCPSD-xxx-04-06	SCPSD-xxx-04-16	SCP-xxx-42-07	SCP03-xxx-44-07 + SCA-1/4-ED-1/2-ED
SCPSD-xxx-04-07	SCPSD-xxx-04-17	SCP01	SCP03
SCPSD-xxx-14-05	SCPSD-xxx-14-15	SCP02	SCP03

Please ask about compatible products for non-listed items.

Parker Hannifin Corporation  
**Parker Hannifin Manufacturing  
Germany GmbH & Co. KG**  
Am Metallwerk 9  
D-33659 Bielefeld  
Germany  
[www.parker.com](http://www.parker.com)

CAT/4083/UK April 2025

Your Local Authorized Parker Distributor

© 2025 Parker Hannifin Corporation

