



High Pressure Bladder Accumulators - EHV Series

330 bar to 690 bar



ENGINEERING YOUR SUCCESS.

CADE - Cylinder and Accumulator Division Europe

Made in Europe - serving all markets and industries

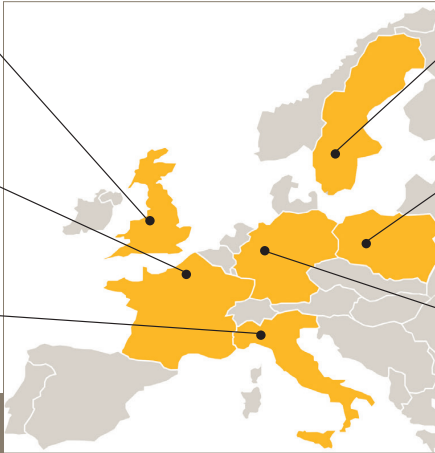

Parker CADE UK
Sandycroft, (Chester)

Parker CADE Sweden
Falköping

Parker CADE France
Colombes

Parker CADE Poland
Wroclaw















Parker CADE Italy
Arsago

Parker CADE Germany
Cologne

www.parker/acde



Our product range - click for more detail:

 Bladder Accumulators	 Piston Accumulators	 Membrane Accumulators	 Pulsation Dampers	 Gas Bottles	 Accessories
 Air-Oil Coolers	 Water-Oil Cooler	 QPM Pump	 Tierod Cylinders	 Mill-type Cylinders	 Helical Actuators
 Service Center			 Service and Support		 Cross Reference Tool

Contents

	Page
Introduction	5
Features and Benefits	6
Technical Specifications	7
Industrial Range	
EHV, 330 bar / 10 - 50 L	10
EHV, 350 bar / 0.2 - 10 L	12
Accessories: Safety Block SB Series	15
EHV, 690 bar / 1 - 54 L	16
Marine Range	
EHV Marine, 330 bar / 10 - 50 L	18
EHV Marine, 350 bar / 0.5 - 10 L	20
Accessories: SC-VGU Super Complete Charging Set	22
Flanged Fluid Port	
EHVF, 330 bar / 10 - 50 L Flanged Fluid Port	24
EHVF, 350 bar / 2.5 - 10 L Flanged Fluid Port	26
Accessories: SensoNode	27
High Flow Fluid Port	
EHV, 330 bar / 10 - 57 L High Flow Fluid Port	28
EHV, 350 bar / 2.5 - 10 L High Flow Fluid Port	30
EHV Adapter Range	32
EHVF Flanges	33
Anti Corrosion Materials	34
Bladder Materials and Types	35
EHV configurator+ on parker.com	36
How to order	37

If you are using an electronic version of this catalogue this icon will take you back to this **CONTENTS** page upon clicking.



If you are using an electronic version of this catalogue this icon will take you back to this **HOW TO ORDER** page upon clicking.



If you are using an electronic version of this catalogue this icon will take you to the **EHV CONFIGURATOR** on parker.com.



Parker – committed to your success

Parker Hannifin is the global leader in motion and control technologies. We employ more than 58,000 people in 48 countries, providing our customers with technical excellence and first class customer service. Parker is the world's largest supplier of hydraulic cylinders for industrial applications.

When you partner with Parker, you gain access to a vast range of resources designed to increase your productivity and profitability.

Online Support

You can find the latest product information on the Parker website. Designed to be accessible via desktops, tablets and smart phones you can download software, brochures, manuals and 3D models.

All of the latest product news and contact information is also included on the website.

www.parker.com/acde

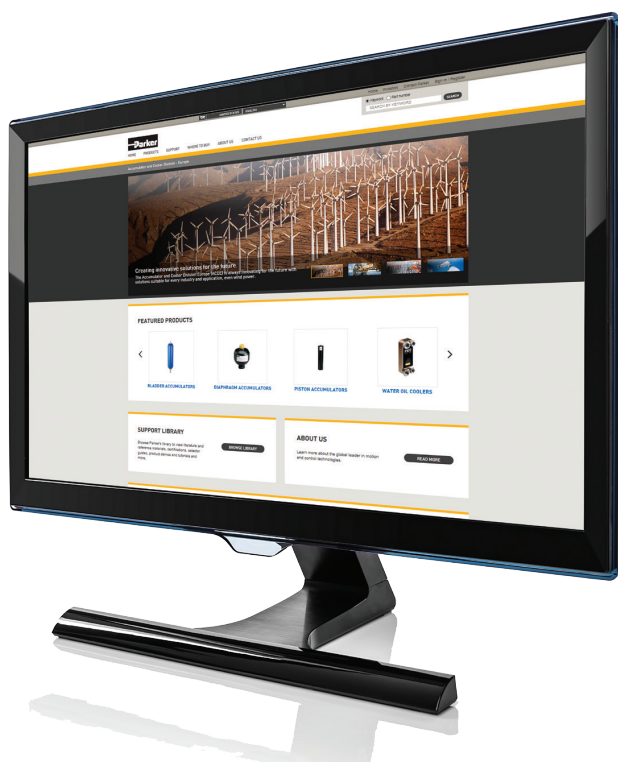

WARNING – USER RESPONSIBILITY

FAILURE OR IMPROPER SELECTION OR IMPROPER USE OF THE PRODUCTS DESCRIBED HEREIN OR RELATED ITEMS CAN CAUSE DEATH, PERSONAL INJURY AND PROPERTY DAMAGE.

This document and other information from Parker-Hannifin Corporation, its subsidiaries and authorized distributors provide product or system options for further investigation by users having technical expertise.

The user, through its own analysis and testing, is solely responsible for making the final selection of the system and components and assuring that all performance, endurance, maintenance, safety and warning requirements of the application are met. The user must analyze all aspects of the application, follow applicable industry standards, and follow the information concerning the product in the current product catalog and in any other materials provided from Parker or its subsidiaries or authorized distributors.

To the extent that Parker or its subsidiaries or authorized distributors provide component or system options based upon data or specifications provided by the user, the user is responsible for determining that such data and specifications are suitable and sufficient for all applications and reasonably foreseeable uses of the components or systems.

Offer of Sale

Please contact your Parker representation for a detailed 'Offer of Sale'.



Introduction: High Pressure Bladder Accumulators

Designed for high pressure hydraulic systems the EHV bladder accumulator is available in carbon & stainless steel.

The EHV bladder accumulator offers a reliable and efficient solution for storing energy under pressure. Utilizing comprehensive tools and resources including an applications database, CAD/CAM, finite element analysis, reliability studies and simulation we have optimized the design and performance of the accumulator. Parker Olaer bladder accumulators are suitable for use in more than 35 countries (all hydraulic accumulators for Europe are CE marked) and they can meet an extensive range of international and industry approvals.

Rigorous product testing and continuous product development help to ensure our hydraulic accumulators operate at optimum efficiency and can perform in the most demanding environments. Parker accumulator accessories such as Safety Blocks, Burst Discs and Permanent Charging Sets, can aid the safe installation and operation of the accumulators in any hydraulic system.

Target Markets

Industrial - Defense - Renewable Energy - Marine - Mining - Off-Road - Oil & Gas - Processing - Rail

Applications

Hydraulic Power Units - Ship Cranes - Wind Turbines - Plastic Presses - Tooling Machines - Construction / Offroad Machinery - Machine Tools





Features/Benefits

- Extensive range of international and industry approvals (PED 2014/68/EU, EN 14359, ATEX, ASME VIII div 1, SELO, CRN, AS1210, NR13, CUTR, DNV, BV Marine, ABS and DNV GL)
- Rigorous product testing and continuous product development
- Large selection of materials and fittings to suit every hydraulic system.
- Parker Olaer offers a wealth of product knowledge and experience thus enabling us to provide first class technical support and customer service.
- Parker Olaer offer a wide range of accessories for bladder accumulator utilization (e.g. burst disk, pressure gauge adaptor, etc...)
Please, consult PARKER



See the CADE
Accumulator Technology Brochure

Parker Accumulator Technology has many years of experience in the research & development, design and production of hydraulic accumulators. Bladder, piston and membrane accumulators, plus accessories from Parker form an highly competitive range. Our products support hydraulic systems in almost all sectors.

Using accumulators improves the performance of the whole system, on the one hand, this means greater safety and comfort for operator and machine. On the other hand, Parker accumulators enable efficient working in all applications.

Technical Specifications

The accumulator comprises a forged or welded steel shell, a rubber bladder and anti-extrusion system. The standard range, as presented in this catalogue, features*:

Volume:	0.2 to 57 Liters
Pressure:	330 to 690 bar
Shell Material:	Shell carbon steel with primar coating , fluid port and stem valve cabrbon steel zinc plated. Optional other materials
Bladder Materials:	Various bladder materials available which are compatible with a wide range of fluids and temperatures.
Fluid Port:	including anti-extrusion system
Approvals:	PED 2014/68/EU, ATEX, ASME VIII div 1, SELO, CUTR, DNV, BUREAU VERITAS MARINE, ABS, DNV GL.
Specials:	For special constructions please consult Parker.
Maximum pressure differential (P2/P0):	4:1
Nitrogen gas pressure:	The maximum pressure (PS) with nitrogen purity > 99.8% N2 class 2.8, is indicated on the accumulator.

Check that the maximum allowable pressure is greater than that of the hydraulic system.

*For more options please see the configurator on parker.com or consult your Parker representative.

ACCUMULATOR WORKING TEMPERATURE DETERMINATION EXAMPLE :

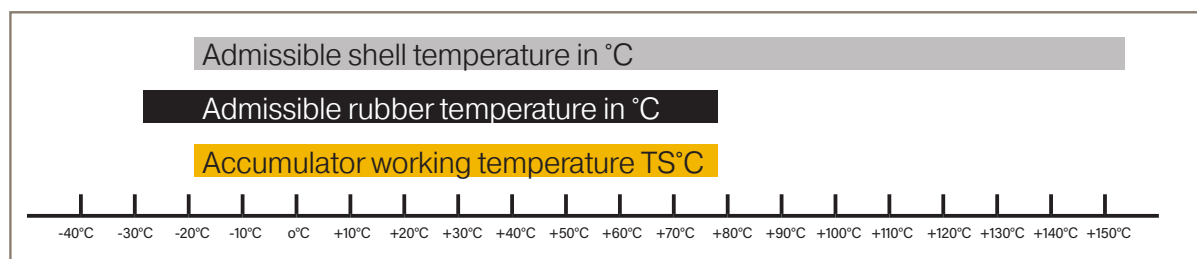



VALVE TYPE C: NEW STANDARD FOR EHV BLADDER ACCUMULATORS*



The new standard features an internal valve, thus

- no radial stress applied to valve
- no risk of disconnecting the gas valve when unscrewing the charging kit
- same length with protective cap; shorter valve means more space for charging kit connection
- avoiding fracture in case of shock
- charging adapter included in standard charging kit
- single adapter for controlling and refilling gas - fits the complete EHV and range

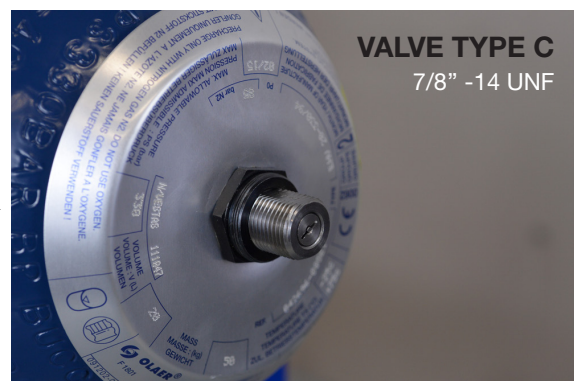
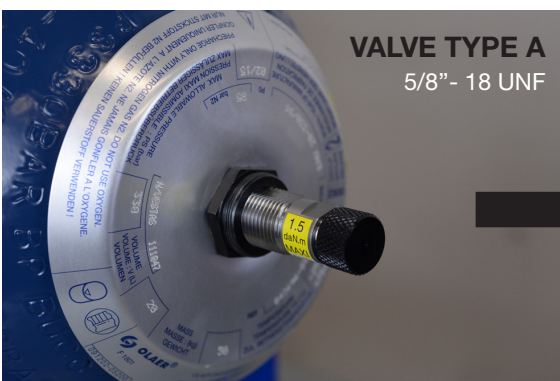

***All EHV (1L - 57L) bladder accumulators will be supplied with valve type C from now on.**



Spare Parts

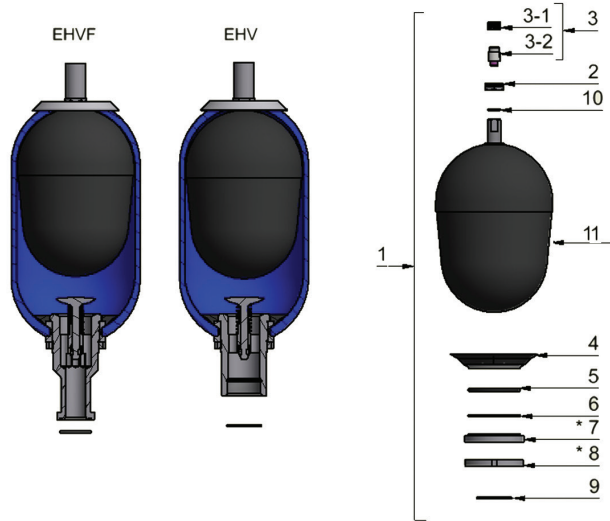

Item	Spare parts
1	Spare Parts Kit
2	Valve nut
3	Gas valve Assembly
3.1	Gas valve
3.2	Gas valve plug
4	Anti-extrusion ring
5	Fluid port seal
6	Back up seal ring
7*	Spacer
8*	Locking nut
9	O-ring fluid port
10	Back up ring (depending on the model)
11	Bladder

* Not included in the bladder kit

RCC-M

Accumulator Regulations and Protections

Due to our vast experience in demanding markets such as aerospace, military, nuclear, renewable energies and formula one racing, we are offering an unmatched range of rubber compounds to meet the most difficult applications.

Parker Olaer products are supported all over the globe, and we will meet customer requirements wherever needed. We therefore offer the complete range of approvals, such as all key Marine approvals (BV, DNV, ABS, LR, ...), over and above all country specific approvals (PED, AS 1210, ASME, SELO, CRN, ARH, CUTR, ...)

please refer to this document for further information

MSG01-6975

Regulations and Protections

EBV and EHV series

Parker

ENGINEERING YOUR SUCCESS.

EHV series 330 bar, 10 to 50 Liters

Standard version (Carbon Steel shell/NBR mix) compatible with mineral oils².
 According to PED 2014/68/EU, EN 14359, Fluid Group 2³.

Max. working pressure: 330 bar	Temperature Range: -20°C to 80°C ¹
Max. flow rate: 900 l/min ⁴	Gas Connection: 7/8" 14 UNF

Type Part number	Valve type, (see drawing)	Effective Gas vol. Liters	Weight kg	A max. Height*
EHV 10-330/90-A25GC-200 10837001125	C	9.2	31	587
EHV 10-330/90-A25GB-200 10865401125	B			
EHV 12-330/90-A25GC-200 10867101125	C	11.0	36	687
EHV 12-330/90-A25GB-200 10867401125	B			
EHV 20-330/90-A25GC-200 10837101125	C	17.8	49	897
EHV 20-330/90-A25GB-200 10865501125	B			
EHV 24,5-330/90-A25GC-200 10837201125	C	22.5	56	1032
EHV 24,5-330/90-A25GB-200 10865601125	B			
EHV 32-330/90-A25GC-200 10837301125	C	32	81	1420
EHV 32-330/90-A25GB-200 10865701125	B			
EHV 50-330/90-A25GC-200 11076701125	C	48.5	110	1936
EHV 50-330/90-A25GB-200 11076801125	B			

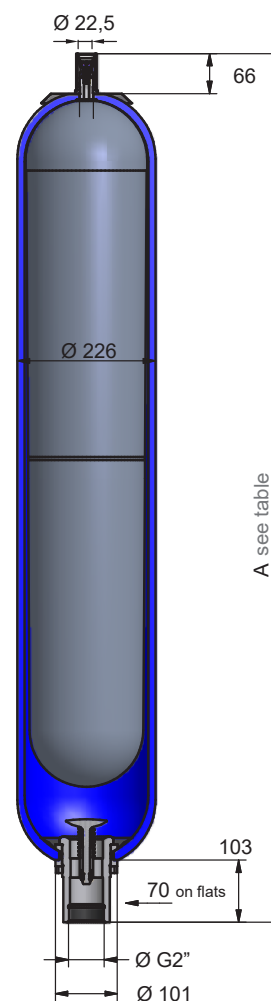

* All dimensions in mm and are subject to manufacturing tolerances

¹ Temperature range can change depending on shell and elastomer material.
 Please see bladder materials and Type (page 35)

² For other fluids: consult Parker | ³ For Fluid group 1 consideration: consult Parker

⁴ Port & fitting size will become limiting factors for flow rate in most applications.

Model of valve stem

B-type
7/8" 14 UNF



C-type
7/8" 14 UNF
(integrated)

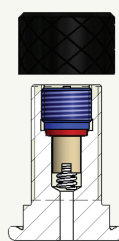

EHV series 330 bar, 10 to 50 Liters / Spare Parts & Accessories

Type Part Number	Adaptor* Threaded Part number	Clamps Model (quantity) Part number	Support Bracket Model Part number	Mounting Frame Model Part number	Lifting Eye Part number	Complete Repair Kit Model Part Number
EHV 10-330/90-A25GC-200 10837001125	G 1" cyl 04557000223	D226 2 20251503648	CE159A 20109003620	EF2 20217600125	10912700200	KIT EHV 10-330 DIA22 VALVE C 19028900225
EHV 10-330/90-A25GB-200 10865401125						KIT EHV 10-330 DIA22 VALVE B 19035800225
EHV 12-330/90-A25GC-200 10867101125	G 1" cyl 04557000223	D226 2 20251503648	CE159A 20109003620	EF2 20217600125	10912700200	KIT EHV 12-330 DIA22 VALVE C 19032100225
EHV 12-330/90-A25GB-200 10867401125						KIT EHV 12-330 DIA22 VALVE B 19035900225
EHV 20-330/90-A25GC-200 10837101125	G 1" cyl 04557000223	D226 2 20251503648	CE159A 20109003620	EF2 20217600125	10912700200	KIT EHV 20-330 DIA22 VALVE C 19029000225
EHV 20-330/90-A25GB-200 10865501125						KIT EHV 20-330 DIA22 VALVE B 19036000225
EHV 24,5-330/90-A25GC-200 10837201125	G 1" cyl 04557000223	D226 2 20251503648	CE159A 20109003620	EF2 20217600125	10912700200	KIT EHV 24,5-330 DIA22 VALVE C 19029400225
EHV 24,5-330/90-A25GB-200 10865601125						KIT EHV 24,5-330 DIA22 VALVE B 19036300225
EHV 32-330/90-A25GC-200 10837301125	G 1" cyl 04557000223	D226 2 20251503648	CE159A 20109003620	EF3 20217700125	10912700200	KIT EHV 32-330 DIA22 VALVE C 19029100225
EHV 32-330/90-A25GB-200 10865701125						KIT EHV 32-330 DIA22 VALVE B 19036100225
EHV 50-330/90-A25GC-200 11076701125	G 1" cyl 04557000223	D226 2 20251503648	CE159A 20109003620	EF3 20217700125	10912700200	KIT EHV 50-330 DIA22 VALVE C 19054100225
EHV 50-330/90-A25GB-200 11076801125						KIT EHV 50-330 DIA22 VALVE B 19054200225

*For more adaptor options see page 32

EHV series 350 bar, 0.2 to 10 Liters

Standard version (Carbon Steel shell/NBR mix) compatible with mineral oils ².
 According to PED 2014/68/EU, EN 14359, Fluid Group 2 ³.

Max. working pressure: 350 bar	Temperature Range: -20°C to 80°C
	Gas Connection: 7/8" 14 UNF

Type Part number	Valve type (see drawing)	Effective Gas vol. Liters	Max Flow Rate l/min ⁴	Weight kg
EHV 0.2-350/00-A20AD-200* ⁵ 10876301120	D	0.17	120	2,5
EHV 0.5-350/00-A25BD-200* 10876401125	D	0.6	240	3
EHV 1-350/00-A25BC-200* 10845601125	C	1	240	6
EHV 1-350/00-A25BB-200* 10866901125	B			
EHV 1.6-350/90-A25BC-200 10998301125	C	1.6	240	8
EHV 1.6-350/90-A25BB-200 11123501125	B			
EHV 2.5-350/90-A25DC-200 10854701125	C	2	450	11
EHV 2.5-350/90-A25DB-200 10866601125	B			
EHV 4-350/90-A25DC-200 10845401125	C	3.7	450	15
EHV 4-350/90-A25DB-200 10866101125	B			
EHV 5-350/90-A25DC-200 10861201125	C	5	450	17
EHV 5-350/90-A25DB-200 10866701125	B			
EHV 6-350/90-A25DC-200 10857401125	C	6.0	450	20
EHV 6-350/90-A25DB-200 10866201125	B			
EHV 10-350/90-A25DC-200 10859701125	C	10	450	31
EHV 10-350/90-A25DB-200 10866301125	B			

Model of valve stem

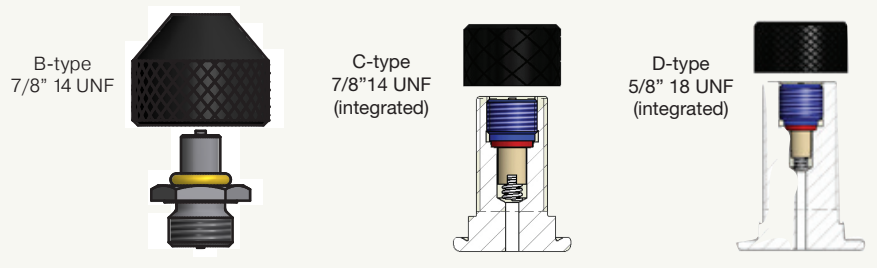

* According to Article 4.3 PED 2014/68/EU
¹ Temperature range can change depending on shell and elastomer material.
 Please see bladder materials and Type (page 35)
² For other fluids: consult Parker | ³ For Fluid group 1 consideration: consult Parker
⁴ Port & fitting size will become limiting factors for flow rate in most applications.
⁵ Gas connection: 5/8" 18 UNF, temperature range: -6°C to 80°C

High Pressure Bladder Accumulators - EHV 330 bar to 690 bar

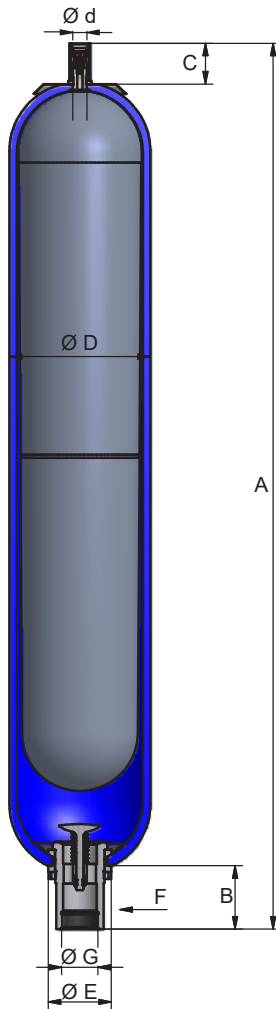

Type	Dimensions in mm							
	A max Height	B	C	$\varnothing D$	$\varnothing d$	$\varnothing E$	F on flats	G connection
EHV 0.2	268	38	27	58	16	39	24	G 1/2"
EHV 0.5	260	54	27	91	16	50	32	G 3/4"
EHV 1	330	54	66	116	22.5	50	32	G 3/4"
EHV 1.6	442	54	66	116	22.5	50	32	G 3/4"
EHV 2.5	549	66	66	116	22.5	68	50	G 1 1/4"
EHV 4	434	65	66	170	22.5	68	50	G 1 1/4"
EHV 5	898	66	66	116	22.5	68	50	G 1 1/4"
EHV 6	560	65	66	170	22.5	68	50	G 1 1/4"
EHV 10	825	65	66	170	22.5	68	50	G 1 1/4"

EHV series 350 bar, 0.2 to 10 Liters / Spare Parts & Accessories

Type	Adaptor**/ Threaded Part number	Clamps / Model (quantity) Part number	Support Bracket / Model Part number	Mounting Frame / Model Part number	Lifting Eye on gas side / Model Part number	Complete Repair Kit / Model Part number
EHV 0.2-350/00-A20AD-200*	G 1/4" cyl 04556500223	A56 1 20149203625				KIT EHV 0.2-350 D16 VALVE D 19001000220
EHV 0.5-350/00-A25BD-200*	G 3/8" cyl 04556400223	E95 1 20250803648				KIT EHV 0.5-350 D16 VALVE D 19001100225
EHV 1-350/00-A25BC-200*	G 3/8" cyl 04556400223	E114 1 20251003648	CE 89 20151903620			KIT EHV 1-350 DIA22 VALVE C 19029700225
EHV 1-350/00-A25BB-200*						KIT EHV 1-350 DIA22 VALVE B 19036400225
EHV 1.6-350/90-A25BC-200	G 3/8" cyl 04556400223	E114 1 20251003648	CE 89 20151903620			KIT EHV 1.6-350 DIA22 VALVE C 19060700225
EHV 1.6-350/90-A25BB-200						KIT EHV 1.6-350 DIA22 VALVE B 19061000225
EHV 2.5-350/90-A25DC-200	G 3/4" cyl 04555200223	E114 2 20251003648	CE 89 20151903620		10912700200	KIT EHV 2.5-350 DIA22 VALVE C 19029800225
EHV 2.5-350/90-A25DB-200						KIT EHV 2.5-350 DIA22 VALVE B 19036500225
EHV 4-350/90-A25DC-200	G 3/4" cyl 04555200223	E168 1 20251303648	CE108 20118703620	EF1 20217500125	10912700200	KIT EHV 4-350 DIA22 VALVE C 19029900225
EHV 4-350/90-A25DB-200						KIT EHV 4-350 DIA22 VALVE B 19036600225
EHV 5-350/90-A25DC-200	G 3/4" cyl 04555200223	E114 2 20251003648	CE 89 20151903620		10912700200	KIT EHV 5-350 DIA22 VALVE C 19030000225
EHV 5-350/90-A25DB-200						KIT EHV 5-350 DIA22 VALVE B 19036700225
EHV 6-350/90-A25DC-200	G 3/4" cyl 04555200223	E168 2 20251303648	CE108 20118703620	EF1 20217500125	10912700200	KIT EHV 6-350 DIA22 VALVE C 19030100225
EHV 6-350/90-A25DB-200						KIT EHV 6-350 DIA22 VALVE B 19036800225
EHV 10-350/90-A25DC-200	G 3/4" cyl 04555200223	E168 2 20251303648	CE108 20118703620	EF1 20217500125	10912700200	KIT EHV 10-350 DIA22 VALVE C 19030200225
EHV 10-350/90-A25DB-200						KIT EHV 10-350 DIA22 VALVE B 19036900225

** for more adaptors option see page 32



NEW

Safety Block SB Series

The new SB safety block for accumulator is engineered for industrial applications, protecting accumulators against pressure peaks according to PED 2014/68/EU including CE marked pressure relief valve.

- Setted and sealed safety valve to protect against pressure peak
- Zinc plated for optimum corrosion resistance, conforms to ISO 9227
- Manual drain control or electrical drain control option
- Approved process for the settings of pressure relief valve

KEY FEATURES

- ✓ Easy Designing
- ✓ Easy Engineering
- ✓ Easy Selection
- ✓ Easy Installation
- ✓ Easy Usage
- ✓ Easy Maintenance

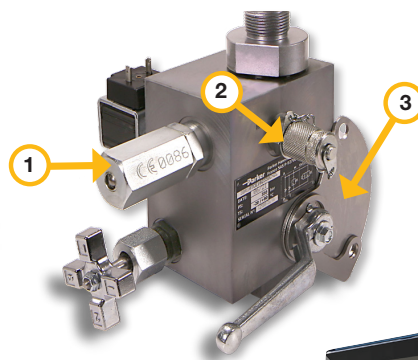

Unique Parker Features

1. Pressure Relief Valve
2. Pressure Test Point
3. Hex Head Screw



See Parker's cross reference tool on parker.com to find a SB replacement for all previous safety block series or competitor interchange.



EHV series 690 bar, 1 to 5 Liters

Standard version (Carbon Steel shell/NBR mix) compatible with mineral oils ².
According to PED 2014/68/EU, EN 14359, Fluid Group 2 ³.

Max. working pressure: 690 bar	Temperature Range: -20°C to 80°C ¹
Max. flow rate: 360 l/min ⁴	Gas Connection: 7/8" 14 UNF

Type	Gas Valve (see drawing)	Effective Gas vol. Liters	Weight kg	Dimensions in mm A (max Height)
EHV 1-690/00-A25CE-200*	E	1.1	9	376
EHV 2.5-690/90-A25CE-200	E	2.4	15	551
EHV 5-690/90-A25CE-200	E	5	29	900

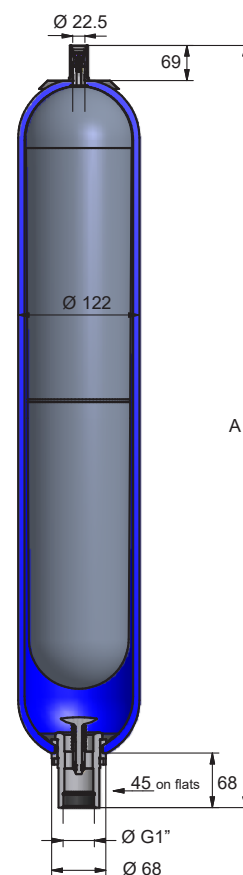
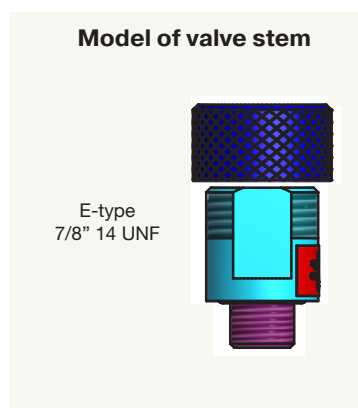

EHV series 690 bar, 1 to 5 Liters / Spare Parts & Accessories

Type Part number	Adaptor** / Threaded Part number	Clamps / Model (quantity) Part number	Support Bracket / Model Part number	Lifting Eye on gas side / Model Part number	Complete Repair Kit / Model Part number
EHV 1-690/00-A25CE-200* 10910101125	04579500223	20251003648	20151903620	10912700200	KIT EHV 1-690 Dia22 Valve E 19043500225
EHV .5-690/90-A25CE-200 10910201125	04579500223	20251003648	20151903620	10912700200	KIT EHV 2,5-690 Dia22 Valve E 19043600225
EHV 5-690/90-A25CE-200 10910301125	04579500223	20251003648	20151903620	10912700200	KIT EHV 5-690 Dia22 Valve E 19043700225

¹Temperature range can change depending on shell and elastomer material. Please see bladder materials and Type (page 35) |

² For other fluids consult Parker

³ For Fluid group 1 consideration : consult Parker | For pre-charge over 300 bar please consult Parker

*according to article 4.3 PED 2014/68/EU | **For more adaptor options see page 32

Above dimensions are in mm and are subject to manufacturing tolerances.



EHV series 690 bar, 12 to 54 Liters

Standard version (Carbon Steel shell/NBR mix) compatible with mineral oils ².
 According to PED 2014/68/EU, EN 14359, Fluid Group 2 ³.

Max. working pressure: 690 bar	Temperature Range: -20°C to 80°C ¹
Max. flow rate: 300 l/min ⁴	Gas Connection: 7/8" 14 UNF

Type	Gas Valve (see drawing)	Effective Gas vol. Liters	Weight kg	Dimensions in mm A (max Height)
EHV 12-690/90-A25GE-200	E	11	97	682
EHV 20-690/90-A25GE-200	E	16.5	134	892
EHV 37-690/90-A25GE-200	E	33.4	227	1417
EHV 54-690/90-A25GE-200	E	48	318	1932

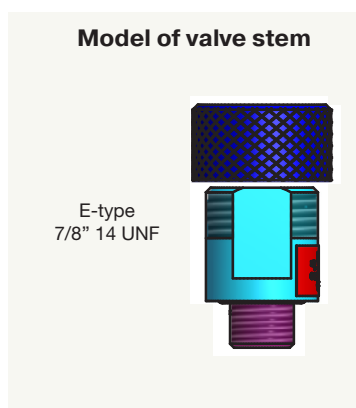
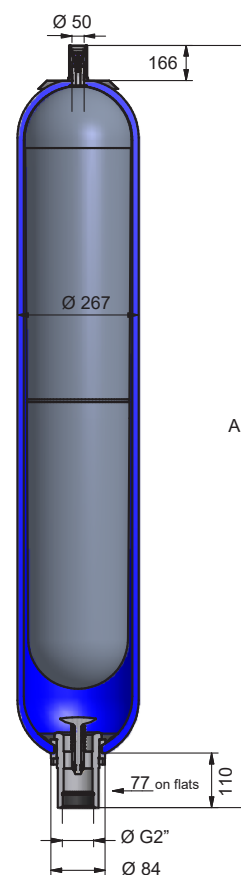

EHV series 690 bar, 12 to 54 Liters / Spare Parts & Accessories

Type Part number	Adaptor / Threaded Part number	Clamps / Model (quantity) Part number	Support Bracket / Model Part number	Lifting Eye on gas side / Model Part number	Complete Repair Kit / Model Part number
EHV 690/90-A25GE-200 1203V-DC-691	Consult Parker	11060-DEE	Consult Parker	Consult Parker	KIT EHV 12-690 Dia 50 Valve E 19048200225
EHV 20-690/90-A25GE-200 2003V-DC-691		11060-DEE			KIT EHV 20-690 Dia 50 Valve E 19048300225
EHV 37-690/90-A25GE-200 3703V-DC-691		11060-DEE			KIT EHV 32-690 Dia 50 Valve E 19048400225
EHV 54-690/90-A25GE-200 5403V-DC-691		11060-DEE			KIT EHV 50-690 Dia 50 Valve E 19048500225

¹Temperature range can change depending on shell and elastomer material. Please see bladder materials and Type (page 35) |

² For other fluids consult Parker

³ For Fluid group 1 consideration : consult Parker | For pre-charge over 300 bar please consult Parker

Above dimensions are in mm and are subject to manufacturing tolerances.

EHV series 330 bar, 10 to 50 Liters - MARINE

Standard version (Carbon Steel shell/NBR mix) compatible with mineral oils ².
 According to PED 2014/68/EU, EN 14359, Fluid Group 2 ³.

Max. working pressure: 330 bar
 Max. flow rate: 900 l/min

Temperature Range: -20°C to 80°C
 Gas Connection: 7/8" 14 UNF

Type	Valve model (see drawing)	/24 : PED & DNV GL	/11 : PED & BV MARINE	/41 : PED & ABS	Effective Gas vol. Liters	Weight kg	Dimensions in mm / A max Height
EHV 10	B	EHV 10-330/24-A25GB-200 11168801125	EHV 10-330/11-A25GB-200 10999501125	EHV 10-330/41-A25GB-200 11165501125	9.2	31	587
EHV 20	B	EHV 20-330/24-A25GB-200 11169001125	EHV 20-330/11-A25GB-200 10999701125	EHV 20-330/41-A25GB-200 11166601125	17.8	49	897
EHV 24.5	B	EHV 24.5-330/24-A25GB-200 11169101125	EHV 24.5-330/11-A25GB-200 10999801125	EHV 24.5-330/41-A25GB-200 11166701125	22.5	56	1032
EHV 32	B	EHV 32-330/24-A25GB-200 11169201125	EHV 32-330/11-A25GB-200 10999901125	EHV 32-330/41-A25GB-200 11166801125	32	81	1420
EHV 50	B	EHV 50-330/24-A25GB-200 11169401125	EHV 50-330/11-A25GB-200 11127901125	EHV 50-330/41-A25GB-200 11167001125	49	110	1936

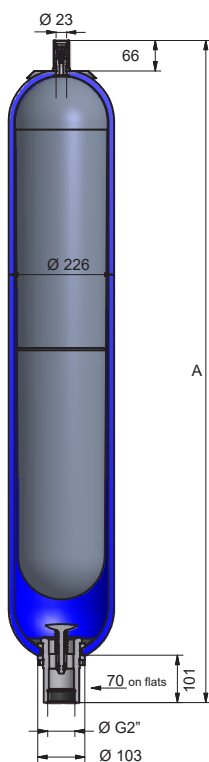

Model of valve stem

B-type
 7/8" 14 UNF

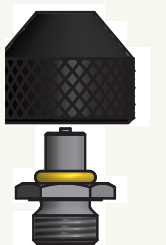

¹Temperature range can change depending on shell and elastomer material. Please see bladder materials and Type (page 35) |

² For other fluids consult Parker

³ For Fluid group 1 consideration : consult Parker |

For pre-charge over 300 bar please consult Parker

Above dimensions are in mm and are subject to manufacturing tolerances.

EHV series 330 bar, 10 to 50 Liters - MARINE / Spare Parts & Accessories

Type	Adaptor* / Threaded Part number	Clamps / Model (quantity) Part number	Support Bracket / Model Part number	Mounting Frame / Model Part number	Lifting Eye on gas side / Model Part number	Complete Repair Kit / Model Part number
EHV 10	G 1" cyl 04557000223	D226 2 20251503648	CE159A 20109003620	EF2 20217600125	10912700200	KIT EHV 10-330 DIA22 VALVE B 19035800225
EHV 20	G 1" cyl 04557000223	D226 2 20251503648	CE159A 20109003620	EF2 20217600125	10912700200	KIT EHV 20-330 DIA22 VALVE B 19036000225
EHV 24.5	G 1" cyl 04557000223	D226 2 20251503648	CE159A 20109003620	EF2 20217600125	10912700200	KIT EHV 24.5-330 DIA22 VALVE B 19036300225
EHV 32	G 1" cyl 04557000223	D226 2 20251503648	CE159A 20109003620	EF3 20217700125	10912700200	KIT EHV 32-330 DIA22 VALVE B 19036100225
EHV 50	G 1" cyl 04557000223	D226 2 20251503648	CE159A 20109003620	EF3 20217700125	10912700200	KIT EHV 50-330 DIA22 VALVE B 19054200225

* For more adaptor options see page 32



EHV series 350 bar, 0.5 to 10 Liters - MARINE

 Standard version (Carbon Steel shell/NBR mix) compatible with mineral oils ².

 Max. working pressure: 350 bar
 Max. flow rate: 240 - 450 l/min

 Temperature Range: -20°C to 80°C
 Gas Connection: 7/8" 14 UNF³

Type	/24 : PED&DNV GL /43 : PED Article 4.3& DNV GL	/11 : PED&BV MARINE /13 : PED Article 4.3& BV MARINE	/41 : PED&ABS /23 : PED Article 4.3&ABS	Valve model see drawing	Effective Gas vol. Liters	Max Flow Rate l/min	Weight (kg)
EHV 0.5*	EHV 0,5-350/43-A25BD-200 11151101125		EHV 0,5-350/23-A25BD-200 11151001125	D	0.6	240	3
EHV 1*	EHV 1-350/43-A25BB-200 11168101125	EHV 1-350/13-A25BB-200 11149501125	EHV 1-350/23-A25BB-200 11165801125	B	1	240	6
EHV 1.6	EHV 1,6-350/24-A25BB-200 11168201125	EHV 1,6-350/11-A25BB-200 11163301125	EHV 1,6-350/41-A25BB-200 11165901125	B	1.6	240	8
EHV 2.5	EHV 2,5-350/24-A25DB-200 11168301125	EHV 2,5-350/11-A25DB-200 11163401125	EHV 2,5-350/41-A25DB-200 11166001125	B	2.4	450	11
EHV 4	EHV 4-350/24-A25DB-200 11168501125	EHV 4-350/11-A25DB-200 10998101125	EHV 4-350/41-A25DB-200 11166201125	B	3.7	450	15
EHV 5	EHV 5-350/24-A25DB-200 11168401125	EHV 5-350/11-A25DB-200 11163501125	EHV 5-350/41-A25DB-200 11166101125	B	5	450	17
EHV 6	EHV 6-350/24-A25DB-200 11168601125	EHV 6-350/11-A25DB-200 11163601125	EHV 6-350/41-A25DB-200 11166301125	B	6	450	20
EHV 10	EHV 10-350/24-A25DB-200 11168701125	EHV 10-350/11-A25DB-200 11163701125	EHV 10-350/41-A25DB-200 11166401125	B	10	450	31

¹Temperature range can change depending on shell and elastomer material. Please see bladder materials and Type (page 35) |

² For other fluids consult Parker

³ 5/8" 18 UNF Gas Connection for EHV 0,5

* According to Article 4.3 PED 2014/68/EU

Above dimensions are in mm and are subject to manufacturing tolerances.



EHV series 350 bar, 0.5 to 10 Liters - MARINE

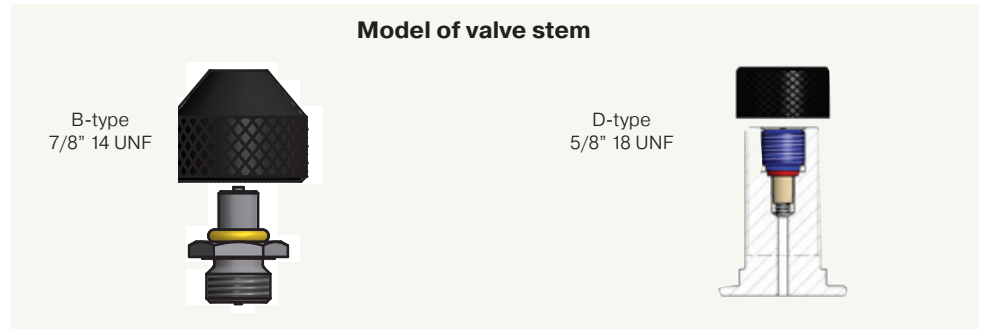
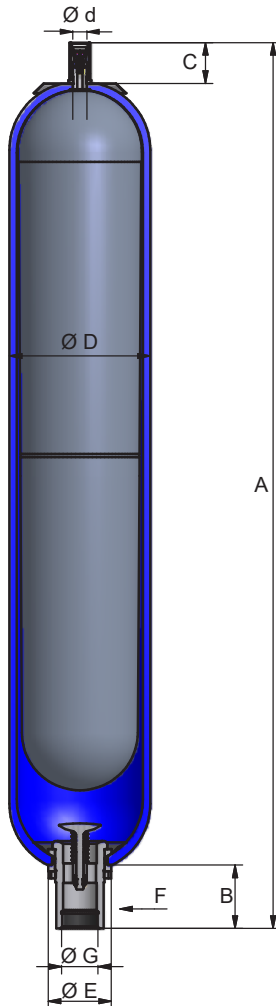

Type	Dimensions in mm							
	A max Height	B	C	øD	ød	øE	F on flats	G connection
EHV 0.5	260	54	27	91	16	50	32	G 3/4"
EHV 1	330	54	66	116	22.5	50	32	G 3/4"
EHV 1.6	442	54	66	116	22.5	50	32	G 3/4"
EHV 2.5	549	66	66	116	22.5	68	50	G 1 1/4"
EHV 4	434	65	66	170	22.5	68	50	G 1 1/4"
EHV 5	898	66	66	116	22.5	68	50	G 1 1/4"
EHV 6	560	65	66	170	22.5	68	50	G 1 1/4"
EHV 10	825	65	66	170	22.5	68	50	G 1 1/4"

Super Complete Charging Set

SC-VGU

The SC-VGU charging kit is an indispensable device for adjusting, controlling and pre-charging accumulators.

Suitable for Parker and non-Parker accumulators and all accumulator technologies (bladder, piston and diaphragm) the SC-VGU Charging Kit is an essential tool for any accumulator maintenance company or service centre.



BENEFITS

- VERSATILE**
 - Suitable for most types of gas valve and all accumulator technologies bladder/piston/diaphragm
 - Suitable for Parker and non-Parker accumulators
- CONVENIENT**
 - Comes in a portable case with strong hinge and fasteners
- RELIABLE**
 - 4 pressure gauges ranging from 0-6 bar to 0-400 bar, enabling a more accurate pre-charge reading for low and high pressure requirements.

PART NUMBERS

Part Number	Description	Country
20270749929	SC-VGU.TM.9.TS2.9	France
20270749939	SC-VGU.TM.9.TS3.9	Germany
20270749989	SC-VGU.TM.9.TS8.9	Italy
20270749999	SC-VGU.TM.9.TS9.9	Netherlands

SUPER COMPLETE CHARGING SET INCLUDES:

9 Different Adaptors

7/8"UNF (short), 7/8"UNF (long), 5/8"UNF, 0.302"(8V1), G 1/4", M28x1.5, M16x200, M16x150, 3/4"BSP HEX

4 Pressure Gauges

0 to 6 bar / 0 to 25 bar / 0 to 250 bar / 0 to 400 bar

1 Extender Hose

For safe operation in tricky spaces

1 Gas Flow Limiter

To control the initial pre-charge speed.

Robust Case

[VIEW DETAILS ON PARKER.COM](http://www.parker.com)

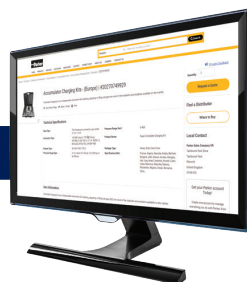

EHV series 350 bar, 0.5 to 10 Liters - MARINE / Spare Parts & Accessories

Type	Adaptor* Threaded Part number	Clamps Model (quantity) Part number	Support Bra- cket Model Part number	Mounting Frame Model Part number	Lifting Eye on gas side Model Part number	Complete Repair Kit Model Part number
EHV 0,5	G 3/8" cyl 04556400223	E95 1 20250803648				KIT EHV 0.5-350 D16 VALVE D 19001100225
EHV 1	G 3/8" cyl 04556400223	E114 1 20251003648	CE 89 20151903620			KIT EHV 1-350 DIA22 VALVE B 19036400225
EHV 1.6	G 3/8" cyl 04556400223	E114 1 20251003648	CE 89 20151903620			KIT EHV 1.6-350 DIA22 VALVE B 19061000225
EHV 2.5	G 3/4" cyl 04555200223	E114 2 20251003648	CE 89 20151903620		19036500225	KIT EHV 2.5-350 DIA22 VALVE B 19036500225
EHV 4	G 3/4" cyl 04555200223	E168 1 20251303648	CE108 20118703620	EF1 20217500125	10912700200	KIT EHV 4-350 DIA22 VALVE B 19036600225
EHV 5	G 3/4" cyl 04555200223	E114 2 20251003648	CE 89 20151903620		10912700200	KIT EHV 5-350 DIA22 VALVE B 19036700225
EHV 6	G 3/4" cyl 04555200223	E168 2 20251303648	CE108 20118703620	EF1 20217500125	10912700200	KIT EHV 6-350 DIA22 VALVE B 19036800225
EHV 10	G 3/4" cyl 04555200223	E168 2 20251303648	CE108 20118703620	EF1 20217500125	10912700200	KIT EHV 10-350 DIA22 VALVE B 19036900225

* for more adaptors option see page 32

EHVF series 330 bar, 10 to 50 Liters - FLANGED FLUID PORT

Standard version (Carbon Steel shell/NBR mix) compatible with mineral oils ².

Max. working pressure: 330 bar
 Max. flow rate: 900 l/min
 Temperature Range: -20°C to 80°C

Gas Connection: 7/8" 18 UNF
 Oil Connection Flange: 1"-1/2 SAE 6000

Type	Valve model see drawing	Effective Gas vol. Liters	Weight kg	Dimensions in mm A (max Height)
EHVF 10-330/90-A25RC-200	C	9.2	31	627
EHVF 12-330/90-A25RC-200	C	11	36	727
EHVF 20-330/90-A25RC-200	C	17.8	49	937
EHVF 24,5-330/90-A25RC-200	C	22.5	56	1072
EHVF 32-330/90-A25RC-200	C	32	81	1460
EHVF 42-330/90-A25RC-200	C	42	87	1602
EHVF 50-330/90-A25RC-200	C	48.5	110	1976
EHVF 57-330/90-A25RC-200	C	51	116	2072

* All dimensions in mm and are subject to manufacturing tolerances

¹ Temperature range can change depending on shell and elastomer material.

Please see bladder materials and Type (page 35)

² For other fluids: consult Parker | ³ For Fluid group 1 consideration: consult Parker

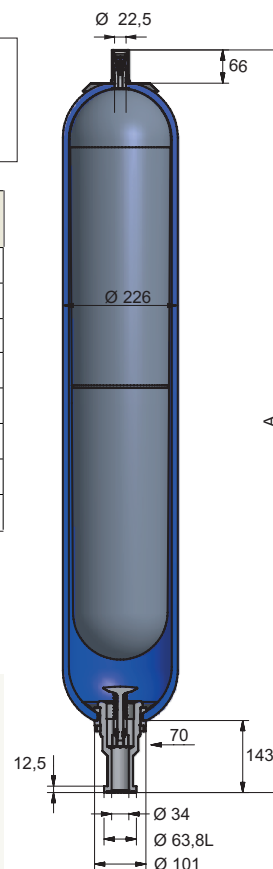

Model of valve stem

C-type
 7/8" 14 UNF

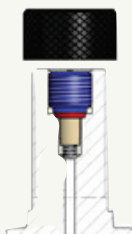

EHV series 330 bar, 10 to 50 Liters - FLANGED FLUID PORT / Spare Parts & Accessories

Type	Kit Flange Type Part number	Clamps Model (quantity) Part number	Support Bracket Model Part number	Mounting Frame Model Part number	Lifting Eye on gas side Model Part number	Complete Repair Kit Model Part number
EHVF 10-330/90-A25RC-200 10844901125	BR 400-38 35132400123	D226 2 20251503648	CE 159A 20109003620	EF2 20217600125	10912700200	KIT REC. EHVF 10-250/330 DIA22 VALVE C 19034600225
EHVF 12-330/90-A25RC-200 10867301125	BR 400-38 35132400123	D226 2 20251503648	CE 159A 20109003620	EF2 20217600125	10912700200	KIT REC. EHVF 12-250/330 DIA22 VALVE C 19034700225
EHVF 20-330/90-A25RC-200 10845001125	BR 400-38 35132400123	D226 2 20251503648	CE 159A 20109003620	EF2 20217600125	10912700200	KIT REC. EHVF 20-250/330 DIA22 VALVE C 19034800225
EHVF 24,5-330/90-A25RC-200 10845101125	BR 400-38 35132400123	D226 2 20251503648	CE 159A 20109003620	EF2 20217600125	10912700200	KIT REC. EHVF 24,5-250/330 DIA22 VALVE C 19035100225
EHVF 32-330/90-A25RC-200 10845201125	BR 400-38 35132400123	D226 2 20251503648	CE 159A 20109003620	EF3 20217700125	10912700200	KIT REC. EHVF 32-250/330 DIA22 VALVE C 19034900225
EHVF 42-330/90-A25RC-200 11132501125	BR 400-38 35132400123	D226 2 20251503648	CE 159A 20109003620	EF3 20217700125	10912700200	KIT REC. EHVF 42-250/330 DIA22 VALVE C 19062200225
EHVF 50-330/90-A25RC-200 11077001125	BR 400-38 35132400123	D226 2 20251503648	CE 159A 20109003620	EF3 20217700125	10912700200	KIT REC. EHVF 50-250/330 DIA22 VALVE C 19054400225
EHVF 57-330/90-A25RC-200 11132601125	BR 400-38 35132400123	D226 2 20251503648	CE 159A 20109003620	EF3 20217700125	10912700200	KIT REC. EHVF 57-250/330 DIA22 VALVE C 19062300225

EHVF series 350 bar, 2.5 to 10 Liters - FLANGED FLUID PORT

Standard version (Carbon Steel shell/NBR mix) compatible with mineral oils ².
 According to PED 2014/68/EU, EN 14359, Fluid Group 2 ³.

Max. working pressure: 350 bar
 Max. flow rate: 450 l/min
 Temperature Range: -20°C to 80°C

Gas Connection: 7/8" 14 UNF
 Oil Connection Flange: 1" SAE 6000

Type	Valve model (see drawing)	Effective Gas vol. Liters	Weight kg	Dimensions in mm		
				A max Height	B	øD
EHVF 2.5-350/90-A25SC-200	C	2.4	11	595	111	116
EHVF 4-350/90-A25SC-200	C	3.7	15	480	110	170
EHVF 5-350/90-A25SC-200	C	5.0	17	944	111	116
EHVF 6-350/90-A25SC-200	C	6.0	20	606	110	170
EHVF 10-350/90-A25SC-200	C	10	31	871	110	170

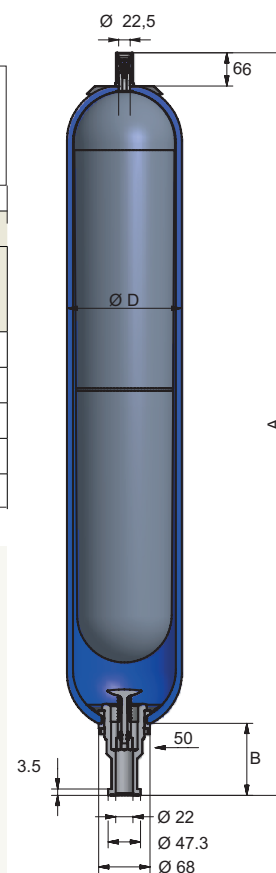

¹Temperature range can change depending on shell and elastomer material.

Please see bladder materials and Type (page 35) |

² For other fluids consult Parker

All dimensions in mm and are subject to manufacturing tolerances

Model of valve stem

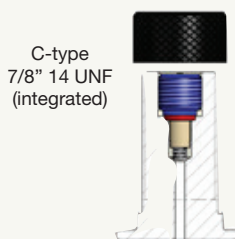

EHVF series 350 bar, 2.5 to 10 Liters - FLANGED FLUID PORT / Spare Parts & Accessories

Type Part number	Flange Type Part number	Clamps Model (quantity) Part number	Support Bracket Model Part number	Mounting Frame Model Part number	Lifting Eye on gas side Model Part number	Complete Repair Kit Model Part number
EHVF 2.5-350/90-A25SC 10861501125	BR 400-25 35132600123	E114 2 20251003648	CE89 20151903620	-	10912700200	KIT EHVF 2.5-350 DIA22 VALVE C 19035300225
EHVF 4-350/90-A25SC 10857601125	BR 400-25 35132600123	E168 1 20251303648	CE108 20118703620	EF1 20217500125	10912700200	KIT EHVF 4-350 DIA22 VALVE C 19035400225
EHVF 5-350/90-A25SC 10861601125	BR 400-25 35132600123	E114 2 20251003648	CE89 20151903620	-	10912700200	KIT EHVF 5-350 DIA22 VALVE C 19035500225
EHVF 6-350/90-A25SC 10857701125	BR 400-25 35132600123	E168 1 20251303648	CE108 20118703620	EF1 20217500125	10912700200	KIT EHVF 6-350 DIA22 VALVE C 19035600225
EHVF 10-350/90-A25SC 10859901125	BR 400-25 35132600123	E168 2 20251303648	CE108 20118703620	EF1 20217500125	10912700200	KIT EHVF 10-350 DIA22 VALVE C 19035700225



SensoNODE Kit for Accumulators

A regular control of the nitrogen pressure allows a durable and efficient operation of the accumulator. The new SensoNode sensor transmits nitrogen pressure / temperature information via a Bluetooth connection to a mobile device (tablet or smartphone) using Scout Mobile Parker application. The purpose of this equipment is to simplify the maintenance of the accumulators by allowing a frequent control of the nitrogen pressure while avoiding dangerous situations for the operator.

PRODUCT FEATURES

Accuracy: 1,5% of the total measuring scale
 Temp range: -40°C to +85°C
 Measurement cycles: > 1 million
 Burst pressure: 3 x working pressure

SAFE

- ⇒ Easy Maintenance
- ⇒ Greater safety for operators

ECONOMIC

- ⇒ Reduced maintenance time
- ⇒ Free Application
- ⇒ Sensor maintenance free

FLEXIBLE

- ⇒ Easy installation on bladder accumulator
- ⇒ Could equip existing or new units

RELIABLE

- ⇒ Battery life time >1 year
- ⇒ More efficient accumulator



Easily follow up on your product's performance via App.



Available for Android and IOS
 VOICE OF THE MACHINE

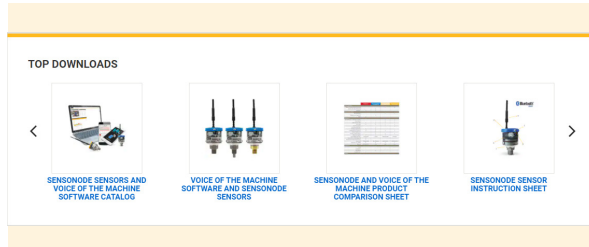

INCLUDES

- SensoNODE
- Gas Valve and Accumulator Stem Valve Adaptor

Part Number	Description	Pressur Range
11354000223	SENSONODE CHARGING SET 0-400 B	0-400 bar
11353900223	SENSONODE CHARGING SET 0-250 B	0-250 bar

Dimensions

Max Height: 175 mm
 Ø: 45 mm + Valve 28 mm
 Weight: 530 g



Visit our website for more useful tools and trainings about condition monitoring resources. [LINK](#)

Do you have any questions regarding our products?

Chat with us on parker.com

Our experts are looking forward to supporting your enquiry.



EHV series 330 bar, 10 to 57 Liters - HIGH FLOW FLUID PORT

Standard version (Carbon Steel shell/NBR mix) compatible with mineral oils ².

Max. working pressure: 330 bar
 Max. flow rate: 1200 l/min

Temperature Range: -20°C to 80°C¹
 Gas Connection: 7/8" 18 UNF

Type	Valve model (see drawing)	Effective Gas vol. Liters	Weight kg	Dimensions A (max Height)
EHV 10-330/90-A25HC-200	C	9,2	31	587
EHV 12-330/90-A25HC-200	C	11	36	687
EHV 20-330/90-A25HC-200	C	17,8	49	897
EHV 24.5-330/90-A25HC-200	C	22,5	56	1032
EHV 32-330/90-A25HC-200	C	32	81	1420
EHV 50-330/90-A25HC-200	C	48,5	110	1936

¹Temperature range can change depending on shell and elastomer material. Please see bladder materials and Type (page 35) |

² For other fluids consult Parker

All dimensions in mm and are subject to manufacturing tolerances

Model of valve stem

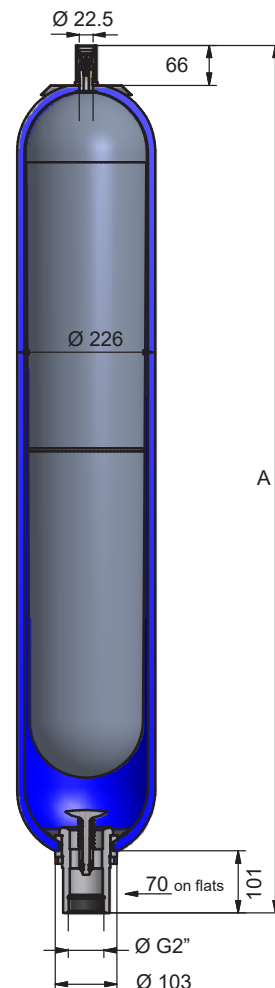
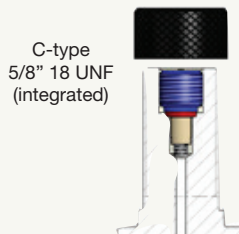

EHVF series 330 bar, 10 to 57 Liters - HIGH FLOW FLUID PORT / Spare Parts & Accessories

Type Part number	Adaptor* Threaded Part number	Clamps Model (quantity) Part number	Support Bracket Model Part number	Mounting Frame Model Part number	Lifting Eye on gas side Model Part number	Complete Repair Kit Model Part number
EHV 10-330/90-A25HC-200 10874801125	G 1" cyl 04557000223	D226 2 20251503648	CE 159A 20109003620	EF2 20217600125	10912700200	KIT EHV 10-330 DIA22 VALVE C 19028900225
EHV 12-330/90-A25HC-200 10874901125	G 1" cyl 04557000223	D226 2 20251503648	CE 159A 20109003620	EF2 20217600125	10912700200	KIT EHV 12-330 DIA22 VALVE C 19032100225
EHV 20-330/90-A25HC-200 10846301125	G 1" cyl 04557000223	D226 2 20251503648	CE 159A 20109003620	EF2 20217600125	10912700200	KIT EHV 20-330 DIA22 VALVE C 19029000225
EHV 24.5-330/90-A25HC-200 10875001125	G 1" cyl 04557000223	D226 2 20251503648	CE 159A 20109003620	EF2 20217600125	10912700200	KIT EHV 24,5-330 DIA22 VALVE C 19029400225
EHV 32-330/90-A25HC-200 10846501125	G 1" cyl 04557000223	D226 2 20251503648	CE 159A 20109003620	EF3 20217700125	10912700200	KIT EHV32-330 DIA22 VALVE C 19029100225
EHV 50-330/90-A25HC-200 11091501125	G 1" cyl 04557000223	D226 2 20251503648	CE 159A 20109003620	EF3 20217700125	10912700200	KIT EHV 50-330 DIA22 VALVE C 19054100225

* for more adaptors option see page 32

EHV series 350 bar, 2.5 to 10 Liters - HIGH FLOW FLUID PORT

Standard version (Carbon Steel shell/NBR mix) compatible with mineral oils ².

Max. working pressure: 350 bar
 Max. flow rate: 570 l/min

Temperature Range: -20°C to 80°C
 Gas Connection: 7/8" 18 UNF

Type	Valve model (see drawing)	Effective Gas vol. Liters	Weight kg	Dimensions in mm		
				A max Height	B	øD
EHV 2.5-350/90-A25EC-200	C	2,4	11	549	66	116
EHV 4-350/90-A25EC-200	C	3,7	15	434	65	170
EHV 5-350/90-A25EC-200	C	5	17	898	66	116
EHV 6-350/90-A25EC-200	C	6	20	560	65	170
EHV 10-350/90-A25EC-200	C	10	31	825	65	170

¹Temperature range can change depending on shell and elastomer material. Please see bladder materials and Type (page 35) |

² For other fluids consult Parker

All dimensions in mm and are subject to manufacturing tolerances

Model of valve stem

C-type
 5/8" 18 UNF
 (integrated)

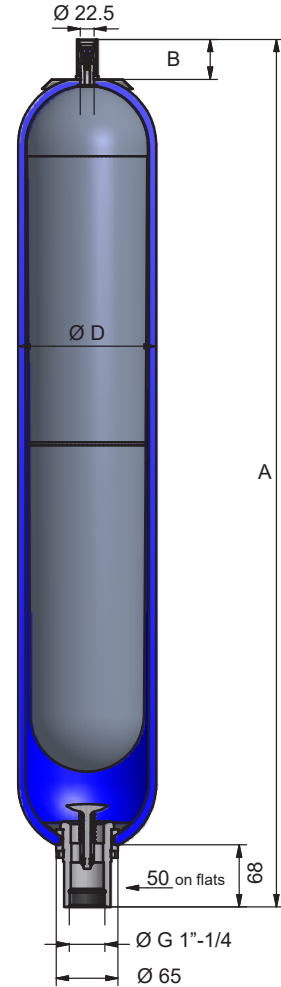
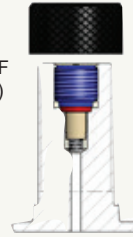

**EHVF series 350 bar, 2.5 to 10 Liters - HIGH FLOW FLUID PORT /
 Spare Parts & Accessories**

Type Part number	Adaptor* Threaded Part number	Clamps Model (quantity) Part number	Support Bracket Model Part number	Mounting Frame Model Part number	Lifting Eye Model Part number	Complete Repair Kit Model Part number
EHV 2.5-350/90-A25EC-200 10846101125	G 3/4" cyl 04555200223	E114 2 20251003648	CE 89 20151903620	-	-	KIT EHV 2.5-350 D22 VALVE C 19029800225
EHV 4-350/90-A25EC-200 10846701125	G 3/4" cyl 04555200223	E168 2 20251303648	CE108 20118703620	EF1 20217500125	-	KIT EHV 4-350 D22 VALVE C 19029900225
EHV 5-350/90-A25EC-200 10874601125	G 3/4" cyl 04555200223	E114 2 20251003648	CE 89 20151903620	-	-	KIT EHV 5-350 D22 VALVE C 19030000225
EHV 6-350/90-A25EC-200 10874701125	G 3/4" cyl 04555200223	E168 2 20251303648	CE108 20118703620	EF1 20217500125	-	KIT EHV 6-350 D22 VALVE C 19030100225
EHV 1 0-350/90-A25EC-200 10845901125	G 3/4" cyl 04555200223	E168 2 20251303648	CE108 20118703620	EF1 20217500125	10912700200	KIT EHV 10-350 D22 VALVE C 19030200225

* for more adaptors option see page 32

EHV Adapters, Carbon Steel

Accumulator model	Connection ØF BSPP	Connection ØI BSPP	P/N	Shape	J/Flats	K	O-Ring / Back-up ring
EHV 0,2 Liter 350 bar	G 1/2"	G 1/4"	04556500223	A	27	8	O-ring 18x2
		Blind	04501800223	A	27	8	O-ring 18x2
EHV 0,5 & 1 & 1,6 Liters 350 bar	G 3/4"	G 3/8"	04556400223	A	32	8	O-ring 21,3x2,4
			04556100223	B	32	8	O-ring 16,9x2,7
		Blind	04502000223	A	32	8	O-ring 21,3x2,4
			04558200223	B	32	8	O-ring 16,9x2,7
EHV 1 to 5 Liters 690 bar	G 1"	G 1/2"	04579500223	B	41	10	O-ring 21,3x3,6 / BUR 22x28x0,69*2
		Blind	04579600223	B	41	10	O-ring 21,3x3,6 / BUR 22x28x0,69*2
EHV 2,5 to 10 Liters 350 bar	G 1"1/4	G 1/2"	04555100233	A	50	10	O-ring 36,2x3
			04555800233	B	50	10	O-ring 30x3
		G 3/4"	04555200223	A	50	10	O-ring 36,2x3
			04555900223	B	50	10	O-ring 30x3
		G 1"	04583100223	A	50	40	O-ring 36,2x3
			Blind	04502200223	A	50	10
04558300233	B	50	10	O-ring 30x3			
EHV 10 to 57 Liters 330 bar	G 2"	G 1/2"	04556800223	A	65	13	O-ring 54x3
			04557700223	B	65	13	O-ring 48x3
		G 3/4"	04556900223	A	65	13	O-ring 54x3
			04557800223	B	65	13	O-ring 48x3
		G 1"	04557000223	A	65	13	O-ring 54x3
			04557900233	B	65	13	O-ring 48x3
		G 1"1/4	04557100223	A	65	13	O-ring 54x3
			04558000223	B	65	13	O-ring 48x3
Blind	04502400223	A	65	13	O-ring 54x3		
	04558400223	B	65	13	O-ring 48x3		
EHV 12 to 54 Liters 690 bar	G 2"	G 1"	04579002523	B	65	15	O-ring 43,82x5,33 / BUR 45x54x0,85*2
		Blind	04579202523	B	65	15	O-ring 43,82x5,33 / BUR 45x54x0,85*2

Shape A - Seal in angle

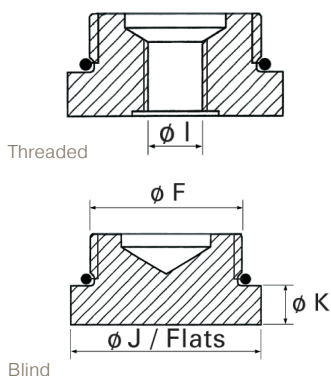

Shape B - Seal in fluid port

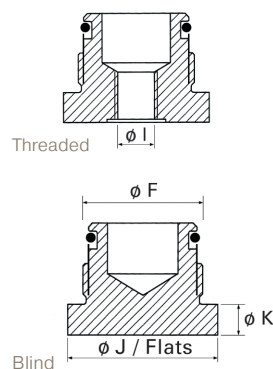

EHV Flanges, Carbon Steel

Accumulator model	Type	Part Number	A	B	C	D	F	øG	ØH	L	M
EHVF 2,5 to 10 Liters	FLANGE KIT BR 400-25	35132600123	81	70	24	27,8	57,2	32,92	3,53	45	M12
EHVF 10 to 57 Liters	FLANGE KIT BR 400-38	35132400123	113	95	30	36,5	79,3	47,22	3,53	55	M16

According ISO 6162-2

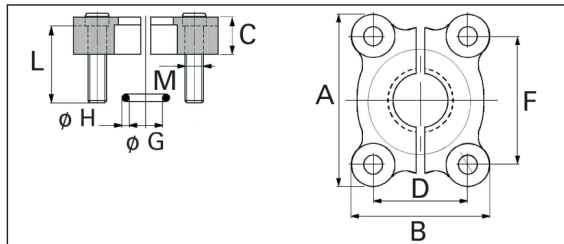

Anti-Corrosion Materials

Protections available from Parker

Example : from EHV 4-350/90 PART NUMBER 1084540XX25

Construction code		11 (standard version)	20	84	85
Accumulator shell	Coating	Primar Coating RAL 5005 External	EPOXY 80 microns Internal	RILSAN® 200-300 microns Internal/External	
	Material	Carbon Steel	Carbon Steel	Carbon Steel	
Valve Stem, Fluid port, and Protection Cap	Material	Zinc plated Carbon Steel	Stainless Steel	Stainless Steel	Zinc plated Carbon Steel
Volume					
0,2		x	x	x	x
0,5		x	x	x	x
1		x	x	x	x
1,6		x	x	x	x
2,5		x	x	x	x
4		x	x	x	x
5		x	x	x	x
6		x	x	x	x
10 (ø 170)		x	x	x	x
10 (ø 226)		x	x	x	x
12		x	x	x	x
20		x	x	x	x
24,5		x	x	x	x
32		x	x	x	x
42		x	x	x	x
50		x	x	x	x
57		x	x	x	x

Depending on your application, fluid and the environment in which you install your systems/equipment, Parker can offer a variety of internal and external shell coatings for your bladder accumulator. Please contact our technical support or your local accumulator expert at Parker if you are uncertain what you may require or for more details on the various coatings.

Bladder Materials and Types

Bladder mixes available from Parker Olaer.

Example : from EHV 4-350/90 PART NUMBER 108454011XX

	Standard Bladder	Other mixes										
Mix Code	Mix 25	Mix 02	Mix 10	Mix 20	Mix 30	Mix 35	Mix 37	Mix 40	Mix 47	Mix 80	E2	XL
Mix Name	Standard NBR (Nitrile)	Hydrin C	Low Temp Nitrile	Heavy Duty Nitrile	Low Nitrile Permeability	High Temp Nitrile	Extreme Low Temp Nitrile	Butyl	EPDM	Viton	High performance Nitrile	Very low permeation nitrile
Max Admissible Temp °C	100	115	80	100	115	130	110	120	120	140	100	100
Min Admissible Temp °C	-20	-32	-30	-6	-5	0	-59	-15	-40	-20	-15	-20**
Volume/ Typical Fluid*	Mineral Oil	Mineral Oil	Mineral Oil	Mineral Oil	Mineral Oil + Special fuels (not unleaded gasoline)	Mineral Oil	Mineral Oil	Water based fluids	Phosphate esters	Aggressive fluids	Mineral Oil	Mineral Oil
0,2	Standard	x	x		x	x	x	x	x	x		
0,5		x	x	x	x	x	x	x	x	x		
1		x	x	x	x	x	x	x	x	x		
1,6		x	x	x	x	x	x	x	x	x		
2,5		x	x	x	x	x	x	x	x	x		x
4		x	x	x	x	x	x	x	x	x		
5		x	x	x	x	x	x	x	x	x		
6		x	x	x	x	x	x	x	x	x		
10 (ø 170)		x	x	x	x	x	x	x	x	x		
10 (ø 226)		x	x	x	x	x	x	x	x	x	x	x
12		x	x	x	x	x	x	x	x	x	x	x
20		x	x	x	x	x	x	x	x	x	x	x
24,5		x	x	x	x	x	x	x	x	x	x	x
32		x	x	x	x	x	x	x	x	x	x	x
42		x	x	x	x	x	x	x	x	x		
50		x	x	x	x	x	x	x	x	x		x
57	x	x	x	x	x	x	x	x	x			

*For any other application please consult Parker.

** under slow cycling conditions



configuratorPLUS live now!

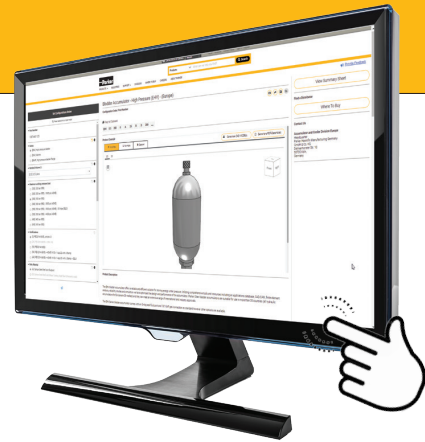
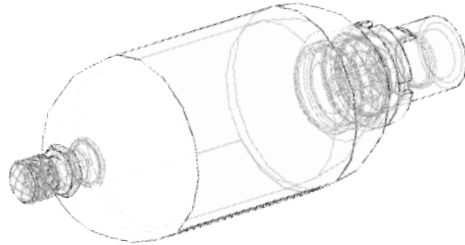

eConfigurator+ Features & Benefits:

- Improved Design & Layout – based on extensive user research and customer testing of UI
- Dynamic Filter Navigation – for an intuitive workflow and a fast part selection
- Built-in Intelligence – guides users to help achieve their desired configuration
- Embedded CAD Viewer – with 3D/2D preview & 200+ file formats to download
- Search by Model Code – directly input a model code to load that configuration
- Model Code Info – provides a detailed breakdown of selected options in a part
- Additional Details/Specifications – providing more data, to aid part selection
- Improved Collaboration – save & load your configurations, or share via email
- Streamlined Quoting – request a price & delivery quote directly from the tool
- Tool Tips – provide the user with additional related information, hints or tips
- Supports All Current Browsers + Mobile – providing a better user experience

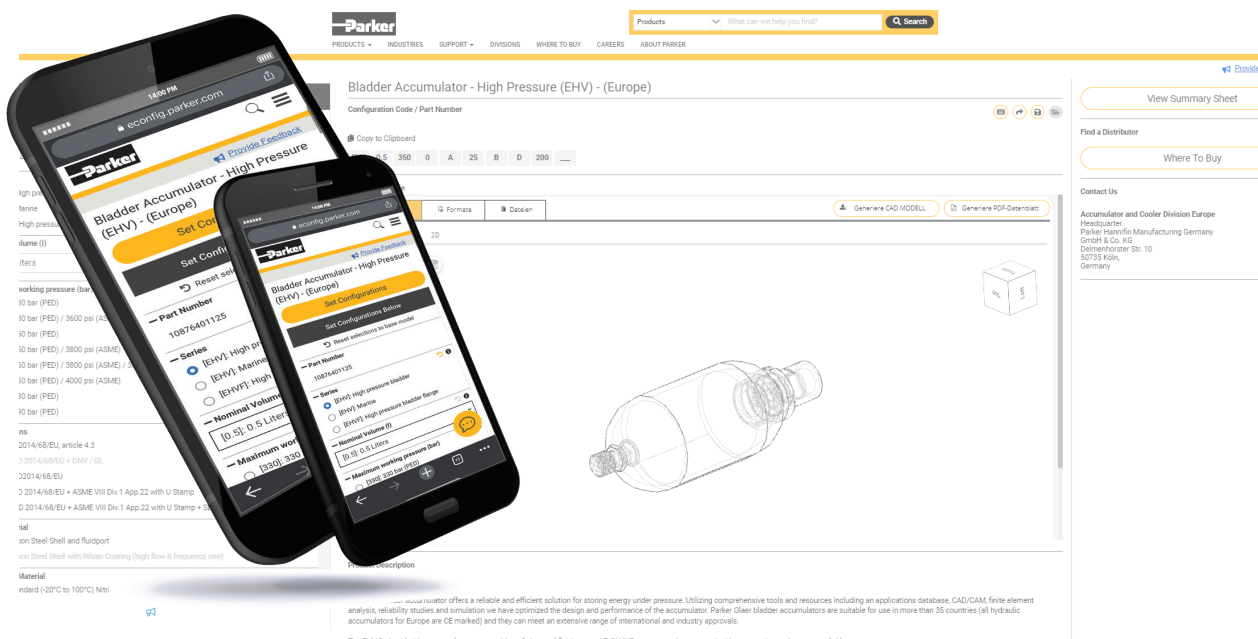

How to order Bladder Accumulators, EHV series: 330 bar - 690 bar

EHV	20	330	90	A	25	G	C	2	00	/	100
01	02	03	04	05	06	07	08	09	10		11

01	Series	EHV = High pressure bladder EHVF = High pressure bladder flange ETHV = High pressure transfer bladder									
02	Gas Volume (L) examples	0.2 = 0.2 L 20 = 20 L 24.5 = 24.5 L									
03	Max. Working Pressure	330 = 330 bar 350 = 350 bar 690 = 690 bar 120 = 120 bar (stainless steel range)									
04	Approval Type if the product is not CE, use highest MWP according to re- gulation relevant to the product. See: approvals	00 = PED2014/68/EU, art. 4.3 11 = PED2014/68/EU + BV Marine 13 = PED2014/68/EU, art. 4.3 + BV Marine 23 = PED2014/68/EU, art. 4.3 + ABS 24 = PED2014/68/EU + DNVGL 41 = PED2014/68/EU + ABS 43 = PED2014/68/EU, art. 4.3 + DNVGL 48 = ASME VIII div 1 app22 71 = CUTR 032/2013 83 = PED2014/68/EU + AS1210 86 = PED2014/68/EU + ASME VIII div 1 app 22 + SELO 88 = PED2014/68/EU + SELO 90 = PED2014/68/EU 91 = ASME VIII div 1 app 22 + AS1210 94 = PED2014/68/EU + ASME VIII div 1 app 2 AA = PED2014/68/EU + NR13 AE = ASME VIII div 1 + NR13 AU = ASME VIII div 1 + CUTR B32/2013									
05	Material (Shell & Fluid Port)	A = All parts in carbon steel with epoxy paint for shell only (-40°C to +80°C) B = Carbon steel shell + internal protection epoxy 80 µm + stainless steel fluid port and valve D = Carbon steel shell + int./ext. protection blue rilsan 200 - 300 µm + carbon steel fluid port and valve E = Carbon steel shell + stainless steel fluid port and valve I = All parts in stainless steel (-40°C to +80°C) R = Carbon steel shell + int./ext. protection blue rilsan 200 - 300 µm + stainless steel fluid port and valve Z = Special									
06	Bladder Rubber Mix	02 = Hydrin C (-32°C to +115°C) 10 = Nitrile low temperature (-30°C to +80°C) 20 = Nitrile heavy duty (-6°C to +100°C) 25 = Nitrile standard (-20°C to +100°C) 30 = Nitrile low permeability (-5°C to +115°C) 35 = Nitrile high temperature (0°C to +130°C) 37 = Nitrile extreme low temp (-59°C to +110°C) 40 = Butyl (-15°C to +120°C) 47 = EPDM (-40°C to +140°C) 80 = Viton (-20°C to +140°C) E2 = Nitrile (-15°C to +100°C) XL = Nitrile very low permeation (-10°C to +100°C)									
07	Fluid Port Configuration	A = Gas cyl ½" (120 L / min) B = Gas cyl ¾" (240 L / min) C = Gas cyl 1" (360 L / min) D = Gas cyl 1¼" (450 L / min) E = Gas cyl 1½" DA (570 L / min) G = Gas cyl 2" (900 L / min) H = Gas cyl 2" DA (1200 L / min) J = Gas cyl. 2½" GD (1800 L / min) M = Metric M40 x 1.5 N = Metric M50 x 1.5 R = EHV 10 - 57 L (900 L / min) Flange 1½" SAE 6000 S = EHV 2.5 - 10 L (450 L/min) Flange 1" SAE 6000 Z = Special									
08	Gas Valve Configuration	0 = No gas valve A = Gas valve type 5/8" - 18 UNF B = Gas valve type 7/8" - 14 UNF C = Gas valve type 7/8" - 14 UNF integrated D = Gas valve type 5/8" - 18 UNF integrated E = Gas valve type 7/8" - 14 UNF high pressure F = Gas valve type 5/8" - 18 UNF + burst disc G = Gas valve type 7/8" - 14 UNF + burst disc H = Gas valve type 7/8" - 14 UNF integr. + burst disc I = Gas valve type 5/8" - 18 UNF integr. + burst disc J = Gas valve type 7/8" - 14 UNF high pr. + burst disc									
09	Fluid Type	0 = Not applicable 1 = Fluid type 1 - CE fluid group 1 2 = Fluid type 2 - CE fluid group 2									
10	Special	00 = None EX = ATEX EZ = ATEX + other special configuration EU = All components sourced in EU SP = Special Painting D1 = Standard Documentation + leak test report D2 = Standard Documentation + design calculation note ZZ = Special configuration or several options ASME certified accumulator according to ASME VIII Div. 1: 30 MWP = 207 bar (3000 PSI) 36 MWP = 248 bar (3600 PSI) 38 MWP = 262 bar (3800 PSI) 40 MWP = 276 bar (4000 PSI) 50 MWP = 345 bar (5000 PSI)									
11	Pre-Charge at 20 °C (bar)	100 = 100 bar (example) Blank : nitrogen storage pre-charge pressure (from 3 to 5 bar).									



European Headquarters
La Tuilière 6, 1163 Etoy,
Switzerland
Tel: +41 21 821 85 00