

Pneumatic Cylinders

Ø32 to Ø125 mm P1F Series
According to ISO 15552

Catalogue PDE3570TCEN



ENGINEERING YOUR SUCCESS.

PDE3570TCEN
Pneumatic Cylinders ISO 15552



Important

Before attempting any external or internal work on the cylinder or any connected components, make sure the cylinder is vented and disconnect the air supply in order to ensure isolation of the air supply.



Note

All technical data in this catalogue are typical data only.
Air quality is essential for maximum cylinder service life (see ISO 8573).



WARNING

FAILURE OR IMPROPER SELECTION OR IMPROPER USE OF THE PRODUCTS AND/OR SYSTEMS DESCRIBED HEREIN OR RELATED ITEMS CAN CAUSE DEATH, PERSONAL INJURY AND PROPERTY DAMAGE.

This document and other information from Parker Hannifin Corporation, its subsidiaries and authorized distributors provide product and/or system options for further investigation by users having technical expertise. It is important that you analyze all aspects of your application and review the information concerning the product or system in the current product catalog. Due to the variety of operating conditions and applications for these products or systems, the user, through its own analysis and testing, is solely responsible for making the final selection of the products and systems and assuring that all performance, safety and warning requirements of the application are met. The products described herein, including without limitation, product features, specifications, designs, availability and pricing, are subject to change by Parker Hannifin Corporation and its subsidiaries at any time without notice.

SALE CONDITIONS

The items described in this document are available for sale by Parker Hannifin Corporation, its subsidiaries or its authorized distributors. Any sale contract entered into by Parker will be governed by the provisions stated in Parker's standard terms and conditions of sale (copy available upon request).



Contents

Bores 32 to 125 mm

Product Overview	4-5
Technical Data	6-7
Piston Rod Load Diagrams	8
Cushioning Characteristics	9
Rod Locks	10-11
Dimensions	12-15
Order Code Key	16
Mountings Overview and Order Code Key	17
Seal Kits	18

Twin-Rods Bores 32 to 100 mm

Product Overview	4
Technical Data	20-21
Piston Rod Load Diagrams	22-23
Dimensions	24-25
Order Code Key	26
Mountings Overview and Order Code Key	27
Seal Kits	28

Mountings

Cylinder Mountings	30-36
Piston Rod Mountings	36
Valve Plate	37

Sensors

Product Overview	38
Technical Data	39
Dimensions	40
Connection and Diagrams	41
Ordering Data	42
Sensor Brackets for Tie-Rod Cylinders	43
Connectors and Cables	43
CPS Continuous Position Sensors	44
Pneumatic Sensors for Tie-Rod Cylinders	45

Air Quality

Specifying Air Quality	46
------------------------------	----

PDE3570TCEN Pneumatic Cylinders ISO 15552

Standard Cylinders ISO 15552

Global product range

The P1F Series meets the specifications of the ISO 15552 standard. This means full interchangeability to any cylinder anywhere around the globe.

The P1F will be available throughout the extensive worldwide Parker Hannifin organisation – for the benefit to you and your customers.



Features

- Smooth profile or Tie-Rods design.
- Bore sizes 32 - 125 mm.
- Stroke up to 2500 mm.
- Corrosion resistant design.
- Stainless steel piston rod.
- Polyurethane seal technology.
- Stainless steel cushioning screws on same side.
- New adjustable pneumatic and mechanical cushioning system reduces noise.
- Full range of mountings.
- Full range of drop-in' sensors.

Design Variants

Smooth profile - P1F-S, P1F-K

The P1F in bore sizes Ø32 to Ø125 mm is a smooth profile designed cylinder with a magnetic piston used for standard temperature range from -20°C to +80°C. Utilising internal composite technology to save weight and reduce impact kinetic energy, while assuring the high performance and functionality expected for an ISO cylinder. Aluminium end covers, stainless steel piston rod guided with a PTFE coated steel bearing, pneumatic cushioning and polyurethane (PUR) seals as standard, this is our smooth profile industrial ISO cylinder.



Smooth profile - P1F-A

Similar to the smooth profile version but in an ATEX variant and a restricted temperature range from -20°C to +60°C. Average speed up to 0.5 m/s and max. frequency 1Hz.

II 2GD Ex h IIC T4 Gb
II 2GD Ex h IIIC T 120°C Db -20°C ≤ Ta ≤ +60°C

Twin Rods smooth profile - P1F-R, P1F-Q

Similar to the smooth profile version but with Twin Rods for non-rotating applications like handling and packaging.



Tie-Rods round profile - P1F-T, P1F-N

Similar to the smooth profile version but in a Tie-Rods design for heavy duty applications. Round tube is made in anodised aluminium; Tie-Rods in stainless steel as a standard.

Bore sizes Ø32 to Ø125 mm.

Large bore sizes Ø160 to Ø320 mm, see catalogue PDE2667TCEN.



PDE3570TCEN Pneumatic Cylinders ISO 15552

Smooth profile with rod locks - P1F-L, P1F-H

With an air/spring rod lock allowing the piston rod to be braked or locked in any position. Incorporating a powerful piston rod locking device, which clamps the piston rod and locks it in position in static, H version or in dynamic, L version. In the absence of an air signal pressure, full holding force is applied to the piston rod. Fully integrated in the front end cap for the L version, added as an accessories for the H version.

Air Reservoirs - P1F-P

The air reservoirs are produced by a cylinder tube and two standard rear end plates and used, e.g. together with throttle valves to achieve a timer function in a pneumatic system. The delay of time will be varied by changing the throttle valve and by the size of the air reservoir. With a well functioning throttle valve and a suitable air reservoir it would be possible to achieve an accuracy of $\pm 5\%$. The reservoir is also used to equal pressure variants into system and to handling short extreme air consumptions without functional disorders. The air reservoirs could also be used together with check valves in order to retain a pressure which is essential for safety reasons.



Options

High temperature

All seals in the high temperature version of P1F are developed and validated for continuous operation up to $+150^{\circ}\text{C}$. The combination of the seal geometry and the FKM (fluoro elastomers) material ensures reliable and long service life. High temperature cylinders have no magnetic piston and cannot be fitted with sensors (the magnetic field strength in high temperatures is too low to ensure correct reliable sensor function).

Chemical resistance scraper

For use in applications where chemicals may affect the scraper in the front end cover, an option with a scraper in FKM (fluoro elastomers) for better chemical resistance must be used. This sealing option is combined with both end covers having a specific anodisation to a better corrosion resistance and with stainless steel screws and piston rod nut.

Metallic scraper

In environments where the piston rod may be coated with resin, ice, cement, sugar crystals, dough, etc., primarily in timber handling, refrigerated/chilled transport, cement industry, chemicals and food and drinks a metal scraper in combination with a hard-chromium plated piston rod is the right solution. Available for low temperature range applications from -30°C to $+80^{\circ}\text{C}$.

Low temperature

All seals in the low temperature version of P1F are developed and validated for continuous operation down to -40°C . Ultrathane polyurethane TPU-PUR seal technology and specifically formulated grease support performance and reliability for low temperature applications. As standard supplied with a magnetic ring in the piston for proximity sensing.

Dry running scraper

In many applications, primarily in the foodstuffs industry, the cylinders are cleaned frequently. This means that the film of grease on the piston rod is washed off, which puts special demands on the material with an FDA conformity and on the design of the piston wiper / rod itself. This sealing option is combined with both end covers having a specific anodisation to a better corrosion resistance and with the stainless steel screws and piston rod nut. Suitable for non food area EN 1672-2.

Stainless steel screws and anodised end caps

Piston rod nut and end covers fixing screws are made in stainless steel, piston rod bushing in a high polymer and end covers are anodised for a better corrosion resistance and use for applications where humidity is constant and when cylinders are frequently cleaned by chemical agents. Only available for chemical resistance and dry running scraper options.

PDE3570TCEN Pneumatic Cylinders ISO 15552

Technical Data

Cylinder forces

Bore/piston rod [mm]	Stroke	Surface area [cm ²]	Max theoretical force in N in relation to applied pressure in bar									
			1	2	3	4	5	6	7	8	9	10
32/12	+	8.0	80	161	241	322	402	483	563	643	724	804
	-	6.9	69	138	207	276	346	415	484	553	622	691
40/16	+	12.6	126	251	377	503	628	754	880	1005	1131	1257
	-	10.6	106	211	317	422	528	633	739	844	950	1056
50/20	+	19.6	196	393	589	785	982	1178	1374	1571	1767	1964
	-	16.5	165	330	495	660	825	990	1155	1319	1484	1649
63/20	+	31.2	312	623	935	1247	1559	1870	2182	2494	2806	3117
	-	28.0	280	561	841	1121	1402	1682	1962	2242	2523	2803
80/25	+	50.3	503	1005	1508	2011	2513	3016	3519	4021	4524	5027
	-	45.4	454	907	1361	1814	2268	2721	3175	3629	4082	4536
100/25	+	78.5	785	1571	2356	3142	3927	4712	5498	6283	7069	7854
	-	73.6	736	1473	2209	2945	3682	4418	5154	5891	6627	7363
125/32	+	122.7	1227	2454	3682	4909	6136	7363	8590	9818	11045	12272
	-	114.7	1147	2294	3440	4587	5734	6881	8027	9174	10321	11468

+ = outward stroke
- = return stroke

Cylinder air consumption

Bore/piston rod [mm]	Stroke	Surface area [cm ²]	Air consumption in l [NI] / 10 mm in relation to applied pressure in bar									
			1	2	3	4	5	6	7	8	9	10
32/12 (G1/8)	+	8.0	0.016	0.024	0.032	0.040	0.048	0.056	0.064	0.072	0.079	0.087
	-	6.9	0.014	0.021	0.027	0.034	0.041	0.048	0.055	0.061	0.068	0.075
40/16 (G1/4)	+	12.6	0.025	0.037	0.050	0.062	0.075	0.087	0.099	0.112	0.124	0.137
	-	10.6	0.021	0.031	0.042	0.052	0.063	0.073	0.083	0.094	0.104	0.115
50/20 (G1/4)	+	19.6	0.039	0.058	0.078	0.097	0.117	0.136	0.155	0.175	0.194	0.213
	-	16.5	0.033	0.049	0.065	0.082	0.098	0.114	0.130	0.147	0.163	0.179
63/20 (G3/8)	+	31.2	0.062	0.093	0.123	0.154	0.185	0.216	0.247	0.277	0.308	0.339
	-	28.0	0.056	0.083	0.111	0.139	0.166	0.194	0.222	0.249	0.277	0.305
80/25 (G3/8)	+	50.3	0.100	0.150	0.199	0.249	0.298	0.348	0.398	0.447	0.497	0.546
	-	45.4	0.090	0.135	0.180	0.224	0.269	0.314	0.359	0.404	0.448	0.493
100/25 (G1/2)	+	78.5	0.156	0.234	0.311	0.389	0.466	0.544	0.621	0.699	0.776	0.854
	-	73.6	0.146	0.219	0.292	0.364	0.437	0.510	0.582	0.655	0.728	0.800
125/32 (G1/2)	+	122.7	0.244	0.365	0.486	0.607	0.728	0.850	0.971	1.092	1.213	1.334
	-	114.7	0.228	0.341	0.454	0.567	0.681	0.794	0.907	1.020	1.134	1.247

+ = outward stroke
- = return stroke

Weight

Cyl.-bore [mm]	P1F-S/A/L/H		P1F-T		Moving parts		Adder for rod lock	
	Base 0 mm [kg]	per 100 mm [kg]	Base 0 mm [kg]	per 100 mm [kg]	Base 0 mm [kg]	per 100 mm [kg]	P1F-H [kg]	P1F-L [kg]
Ø32	0.54	0.23	0.49	0.27	0.10	0.09	0.6	0.27
Ø40	0.74	0.32	0.73	0.31	0.19	0.16	0.8	0.38
Ø50	1.22	0.47	1.19	0.52	0.34	0.25	1.0	0.59
Ø63	1.69	0.49	1.68	0.54	0.40	0.24	1.2	1.15
Ø80	2.50	0.73	2.48	0.84	0.73	0.39	1.4	2.14
Ø100	3.65	0.80	3.66	0.88	1.02	0.38	1.6	3.70
Ø125	6.41	1.37	6.30	1.32	2.01	0.63	1.8	5.76



PDE3570TCEN Pneumatic Cylinders ISO 15552

Technical Data

Product type	Standard cylinder according to ISO 15552
Bore size	32 - 125 mm
Stroke length	5 - 2500 mm
Versions	Double acting
Cushioning	Adjustable air cushioning
Position sensing	Proximity sensor
Installation	ISO cylinder and piston rod mountings



Operating and environmental data

Operating medium	For best possible service life and trouble-free operation dry filtered compressed air to ISO 8573-1:2010 quality 3.4.3 should be used. This specifies a dew point of + 3°C for indoor operation (a lower dew point should be selected for minus temperature operation and we recommend the use of an inline dryer) and is in line with the air quality from most standard compressors with a standard filter.		
Operating pressure	1 to 10 bar		
Ambient temperature	Standard temperature (option M):	-20°C to +80°C	Metal scraper (option Q): -30°C to +80°C
	High temperature (option F):	-10°C to +150°C	FKM wiper rod seal (option V): -10°C to +80°C
	Low temperature (option L):	-40°C to +80°C	POLON wiper rod seal (option D): -20°C to +80°C
Pre-lubricated	Further lubrication is normally not necessary. If additional lubrication is introduced it must be continued. Hydraulic oil type HLP (DIN 51524, ISO 11158). Viscosity by 40°C: 32 mm ² /s (cst). Example: Shell Tellus 32 or equal.		
Corrosion resistance	Material and surface treatment selected for typical industrial applications with resistance to corrosion and chemicals.		

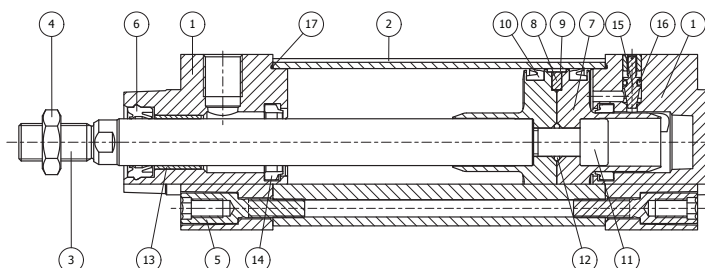

Material specification

Pos	Part	Specification	
1	End covers	Aluminium / Optional black anodised (options V & D only)	
2	Cylinder barrel	Anodised aluminium (profile or round tube)	
3	Piston rod	Standard	Austenitic stainless steel, DIN X8 CrNiS 18-9
		Optional	Chromium plated steel DIN C45E
		Optional	Chromium plated stainless steel 1.4460 = X3CrNiMoN27-5-2, Acid proof
4	Piston rod nut	Zinc plated steel / Stainless steel (option V & D only)	
5	End cover screws	Zinc plated steel / Stainless steel (option V & D only)	
6	Piston rod seal	Standard	Polyurethane (PUR)
		Optional	Fluoro elastomer (FKM) / Ultrathanpolyurethane (TPU-PUR) / Metallic scraper (Brass) nitrile (NBR) / Polon / UHMW-PE
7	Piston	Standard	Poloxymethylene (POM)
		Optional	Aluminium
8	Magnet	Plastic coated magnetic material	
9	Piston bearing	Standard	Poloxymethylene (POM)
		Optional	Polytetrafluoroethylene (PTFE), for aluminium piston
10	Piston seals	Standard	Polyurethane (PUR)
		Optional	Fluoro elastomer (FKM) / Ultrathanpolyurethane (TPU-PUR)
11	Piston bolt	Zinc plated steel	
12	O-ring piston bolt	Standard	Nitrile rubber (NBR)
		Optional	Fluoro elastomer (FKM)
13	Piston rod bearing	Multilayer Steel / PTFE / Optional high polymer (option V & D only)	
14	Cushioning seals	Standard	Polyurethane (PUR)
		Optional	Fluoro elastomer (FKM) / Ultrathanpolyurethane (TPU-PUR)
15	Cushioning screw	Stainless steel DIN X8 CrNiS 18-9	
16	O-ring cushioning screw	Standard	Nitrile rubber (NBR)
		Optional	Fluoro elastomer (FKM)
17	O-ring end cover	Standard	Nitrile rubber (NBR)
		Optional	Fluoro elastomer (FKM)
	Tie-Rods	Austenitic stainless steel, DIN X8 CrNiS 18-9	
	Tie-Rods nut	Zinc plated steel	



PDE3570TCEN
Pneumatic Cylinders ISO 15552

Piston rod load diagram

The piston rod diameter has to be determined to prevent the rod from buckling. Always take the maximum piston thrust force achievable at the specified operating pressure with the cylinder in question.

Loads resulting from longer strokes (as indicated in the diagram) on request. In case of special mounting conditions and transverse forces please consult. Recommended security factor against buckling: 3,5 to 5.

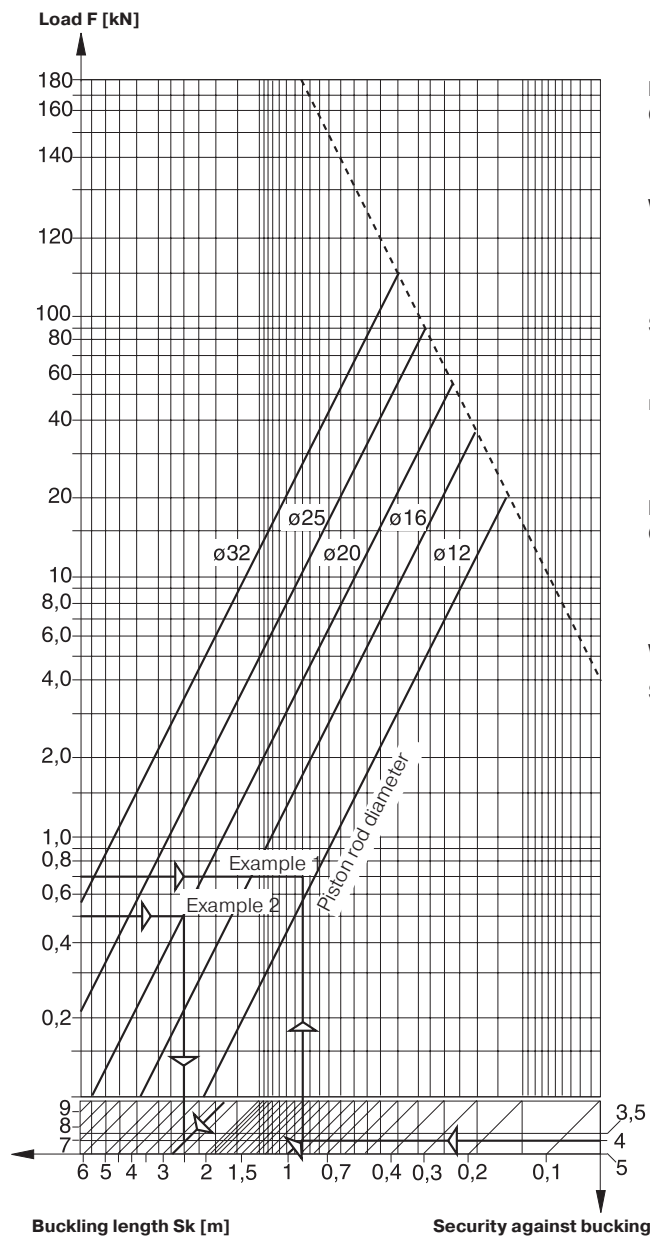

Example 1:

Given Piston thrust: 0.7 kN
 Stroke length: 1000 mm
 Operating pressure: approx. 6 bar

Wanted Piston rod diameter with 4-fold security against buckling;
 Check the piston thrust of the cylinder diameter resulting from the piston rod diameter.

Solution see example 1 in piston rod load diagram.
 The piston rod diameter lies between 12 and 16 mm - a cylinder with a piston rod of 16 mm diameter therefore has to be chosen.

Example 2:

Given Cylinder: Ø 50 mm
 Piston rod: Ø 20 mm
 Stroke length: 1000 mm
 Piston thrust: 0.5 kN at 6 bar

Wanted max. stroke with 4-fold security against buckling

Solution see example 2 in piston rod load diagram.
 SK = 2900 mm
 max. stroke = 1450 mm

Buckling Possibilities of Piston Rods



PDE3570TCEN
Pneumatic Cylinders ISO 15552

Cushioning Characteristics

Air cushion is used to absorb kinetic energy due to load and speed at both end of stroke. This typically consists of a threaded needle screw that adjusts into an orifice in the cylinder end plate. By adjusting the screw further into the orifice you lessen the amount of air that can escape in a given time. Slowing the exhaust of air creates back pressure which slows the piston as it enters into the end cushioning seal.

Cushioning Diagram

Work out your expected moving mass and read off the maximum permissible speed at start of cushioning. Alternatively, take your desired speed and expected mass and find the cylinder size required. Please note that piston speed at start of cushioning is typically approx. 50 % higher than the average speed, and that it is this higher speed which determines the choice of cylinder.

The mass is the sum of internal and external friction, plus any gravitational forces.

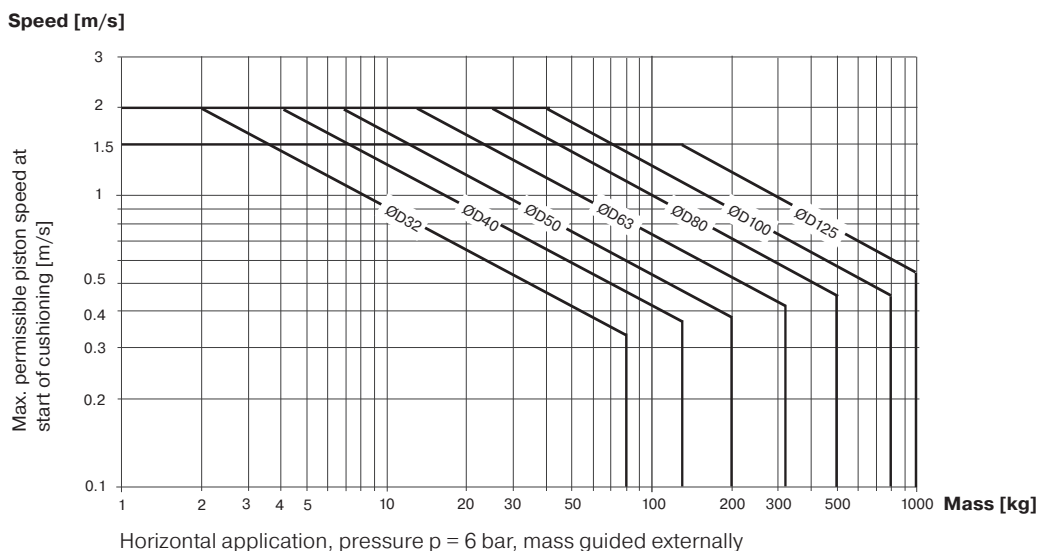

Cushioning Diagram for Cylinders with rod locks

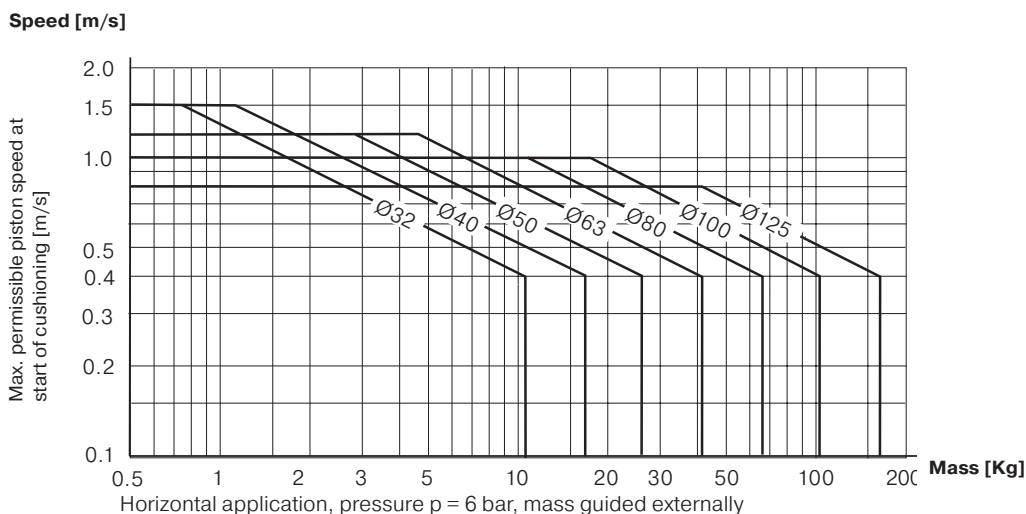

PDE3570TCEN Pneumatic Cylinders ISO 15552

Rod Locks

Function on pressure loss The piston rod lock can be used in all material handling systems where controlled fastening or positioning is required. Additional measures are required for use in safety-related applications (refer to EC Machinery Directive).

The piston rod cylinder with brakes is suitable for use in safety-related sections of control systems. The piston rod lock is also suitable for use as a pressure-loss brake for cylinders with suspended loads. Piston rod can be held in position for long periods even with alternating loads, fluctuating operating pressure or leaks in the system. The signal air to the lock unit can be connected directly to the air system or to the supply air for the valve controlling the cylinder. For controlled on/off operation of the rod lock unit, a separate valve, with large exhaust flow capacity, must be used.

Clean and compact design The front end piece and rod lock unit for the P1F-L variant form an integrated block,

keeping the length of the cylinder as short as possible. The design is easy to clean, sealed and waterproof. The exhaust air from the lock unit can be removed by replacing the filter unit with a fitting and hose. This is an advantage in terms of cleaning or when environmental factors are important.

Use as a break The graph on page 9 shows the maximum values for speed and braking mass if the cylinder is used as a brake. The cylinder should not be exposed to additional compressive forces as this significantly reduces the external mass that can be braked.

The cylinder does not act as a motor during braking. Heat is generated if the brake is used frequently, and this must be taken into account too. The static locking force corresponds to 7 bar pressure. Under certain circumstances, the rod lock can also be used as a brake for positioning or similar applications. The maximum values set out in the cushioning graph must not be exceeded.

Static lock forces

Cylinder bore [mm]	[N] P1F-L	[N] P1F-H
Ø32	598	600
Ø40	906	1000
Ø50	1660	1500
Ø63	2487	2200
Ø80	4163	3000
Ø100	6322	5000
Ø125	8550	7500

Technical data

Working pressure:	Max 10 bar	Max 10 bar
Working media:	Dry filtered compressed air	Dry filtered compressed air
Working temperature:	-20 to +80°C	-20 to +80°C
Release pressure ¹⁾ :	Min 4 bar +/- 10%	> 4 bar

¹⁾ Signal pressure to inlet port of lock unit

Material specification, piston rod locking

	P1F-L	P1F-H
Housing	Anodised aluminium	Anodised aluminium
Carriage	-	Anodised aluminium
Lock collars	Hardened steel	Brass
Springs	Stainless steel	Stainless steel
Rod seal Ø 32-40 mm	UHMWPE plastic	-
Rod seal Ø 50-125 mm	Polyurethane PUR	-
O Rings	Nitrile rubber NBR	-
Scraper ring	Polyurethane PUR	Polyurethane PUR
Air filter	Brass / Sintered bronze	-

Note!

If a rod guidance module is to be fitted to the brake and the cylinder, as the piston rod extension (WH dimension) for P1F-L is not in accordance with the ISO standard, the piston rod must be extended to provide the same WH dimension as for the cylinder itself. Cylinder piston rod material must be made in chromium plated steel.

PDE3570TCEN Pneumatic Cylinders ISO 15552

Separate Rod Locking Device

The cylinder needs to have an extended piston rod.
Cylinder piston rod material must be made in chromium plated steel.

Cyl.-bore [mm]	Rod [mm]	Rod extension [mm]	Weight [kg]	Order Code
Ø32	12	48	0.60	KC8227
Ø40	16	55	0.80	KC8228
Ø50	20	70	1.00	KC8229
Ø63	20	70	1.20	KC8230
Ø80	25	90	1.40	KC8231
Ø100	25	92	1.60	KC8232
Ø125	32	122	1.80	KC8233



Functioning:

The holding force relates to a static load. If this load is exceeded, slippage can occur. Any dynamic forces occurring in operation must not exceed the static holding force. In clamped operating mode, if the load is fluctuating, the clamping unit is not free from play. The cylinder is not suitable for positioning tasks.

Important:

- The locking unit can only be mounted on the cylinder if it is held in its unlocked position either by air pressure or by a suitable screw.
- When the cylinder piston rod is locked it must not be rotated or subjected to external force.

Actuation:

The clamping unit must only be released when both cylinder chambers are pressurised, otherwise there is danger of an accident from the irregular movement of the piston rod. Shutting off the compressed air supply at both ends with a 5/3 ways valve provides adequate safety only for a short time.

Pneumatic circuit:

The design of safe pneumatic circuits begins with a careful risk assessment. The process involves designers of all systems within a machine and/or process from mechanical to electrical. The first step is to look at the project and identify any potential hazards and risks for injury. The next step is to do a risk estimate and evaluation of each hazard. The designers can then develop the appropriate preventive measures to minimize the risk to acceptable levels. The standard developed within ISO 13849 outlines the process by which machine builders can develop their own standard for meeting the guidelines with the goal of making machines as safe as possible. The standard addresses the control of a machine and not the actual moving components (i.e. cylinders, actuators). Pneumatic circuits are usually only one part of a machine that could pose potential hazards.

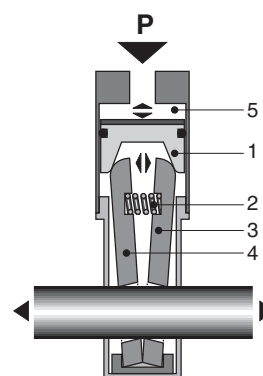

Function:

If the pressure drops the piston rod is locked by two tilting plates. When the piston (1) is put under pressure it is pushed downwards, pressing the two tilting plates (3) and (4) together. The piston rod is then free to move. If the pressure drops in piston chamber (5), a spring pushes the two plates (3) and (4) apart, so that the wedge effect pushes the piston (1) upwards and the tilting plates lock the piston rod.

PDE3570TCEN
Pneumatic Cylinders ISO 15552

Dimensions
Smooth profile design

P1F-S / P1F-A

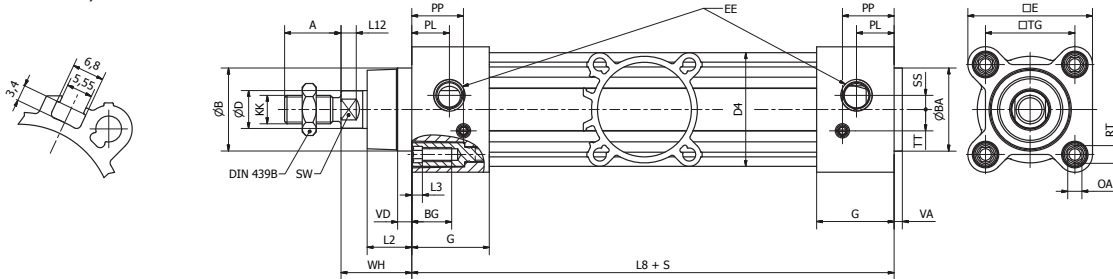

P1F-K

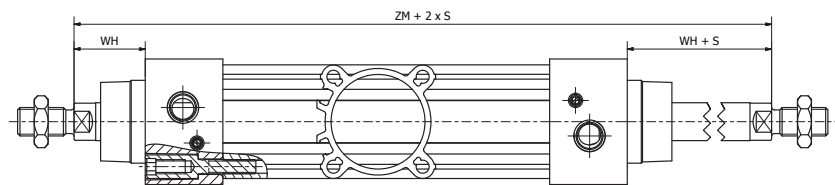

Tie-Rods with round profile design

P1F-T

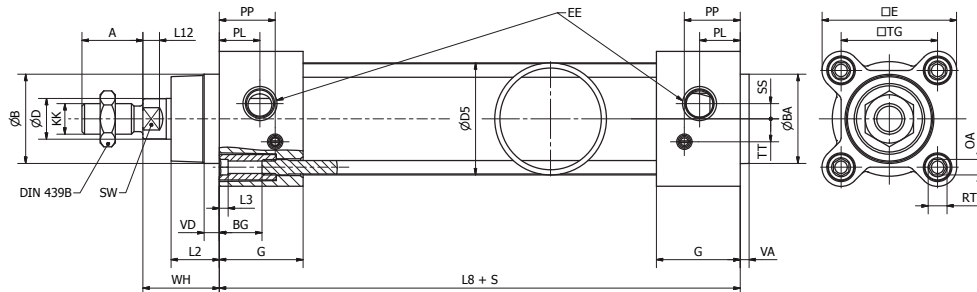

P1F-N

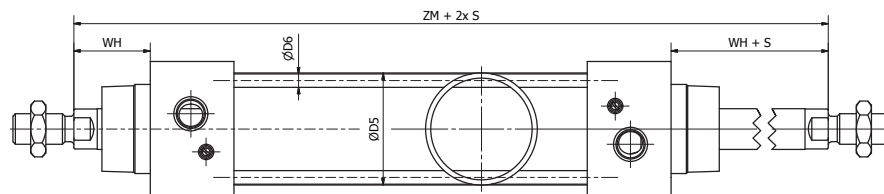

Female piston rod option

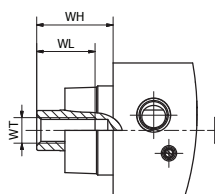

PDE3570TCEN Pneumatic Cylinders ISO 15552

Dimensions

Dimensions [mm]

Cyl.-bore [mm]	A	ØB d11	ØBA d11	BG	ØD	D4	ØD5	ØD6	E	EE	G	KK	L2	L3	L8
Ø32	22	30	30	17	12	42.5	35	5.3	47	G1/8	28.4	M10x1.25	16.8	4.5	94
Ø40	24	35	35	17	16	48	43	5.3	53	G1/4	33	M12x1.25	19	4.5	105
Ø50	32	40	40	18	20	59.5	54	7.1	64.5	G1/4	33.4	M16x1.5	27.6	4.5	106
Ø63	32	45	45	18	20	69.5	67	7.1	75	G3/8	39.4	M16x1.5	24.3	4.5	121
Ø80	40	45	45	19.5	25	86	85	8.9	94	G3/8	39.4	M20x1.5	30.1	5.5	128
Ø100	40	55	55	19.5	25	103	105	8.9	111	G1/2	44.3	M20x1.5	34	5.5	138
Ø125	54	60	60	20	32	130	130	10.8	136	G1/2	50.8	M27x2	45	0	160

Cyl.-bore [mm]	L12	OA	PL	PP	RT	SS	SW	TG	TT	VA	VD	WH	WL	WT	ZM
Ø32	6	6	14	20	M6	5	10	32.5	6.5	3.6	6	26	21	M8x1	146
Ø40	6.5	6	16	22	M6	6	13	38	9	3.5	6	30	23	M10x1.25	165
Ø50	8	8	15.5	21.5	M8	6	17	46.5	9	3.6	6	37	31	M14x1.5	180
Ø63	8	8	18	28	M8	10	17	56.5	11	3.5	6	37	31	M14x1.5	195
Ø80	10	10	20	30	M10	11.5	22	72	14	3.5	6	46	39	M18x1.5	220
Ø100	10	10	18	33	M10	11.5	22	89	14	3.5	6	51	39	M18x1.5	240
Ø125	13	8	20	40	M12	0	27	110	22	5.5	9	65	53	M24x2	290

Tolerances [mm]

Cyl.-bore [mm]	A	L8	TG	ZM	stroke tolerance		
					s ≤ 350 mm	350 mm < s ≤ 600 mm	s > 600 mm
Ø32	0 / - 0.5	± 0.3	± 0.4	-0.4 / + 2.2	+ 1.7	+ 1.9	+ 2.3
Ø40	0 / - 0.5	± 0.3	± 0.4	-0.4 / + 2.2	+ 1.7	+ 1.9	+ 2.3
Ø50	0 / - 0.5	± 0.4	± 0.4	-0.4 / + 2.2	+ 1.8	+ 2	+ 2.4
Ø63	0 / - 0.5	- 0.5 / + 0.3	± 0.4	-0.4 / + 2.2	+ 1.9	+ 2.1	+ 2.5
Ø80	0 / - 0.5	± 0.4	± 0.4	-0.4 / + 2.2	+ 1.9	+ 2.1	+ 2.5
Ø100	0 / - 0.5	± 0.5	± 0.4	-0 / + 2.5	+ 2.0	+ 2.2	+ 2.6
Ø125	0 / - 1.0	± 0.5	± 0.4	-0 / + 2.6	+ 2.1	+ 2.3	+ 2.7

PDE3570TCEN
Pneumatic Cylinders ISO 15552

Dimensions

Dynamic rod lock with smooth profile design

P1F-L

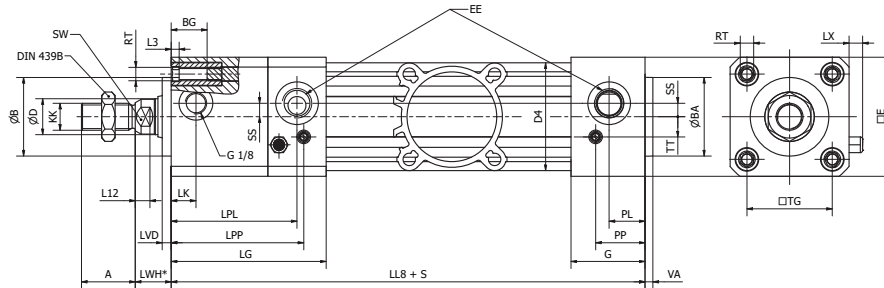

* Not ISO

Static rod lock with smooth profile design

P1F-H

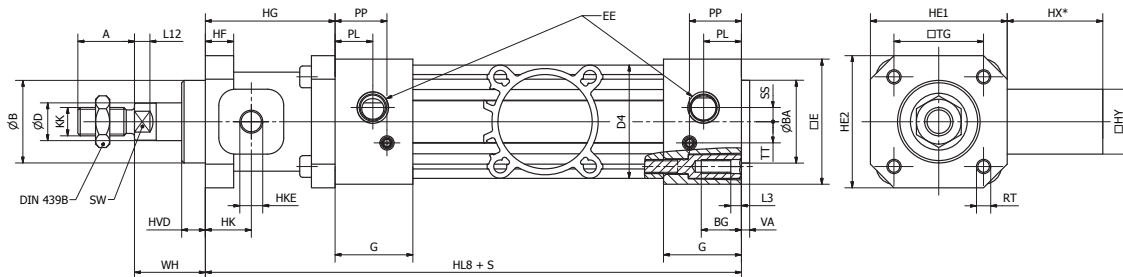

* Not ISO

Air reservoir with smooth profile design

P1F-P

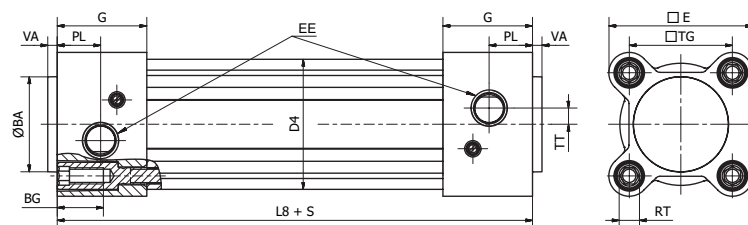

Important

Pressure Equipment Directive. According (PED) to the directive 2014/68/EU, for uncertified pressure vessels:

Max Working pressure x Volume maximized to 50 Bar x litre, i.e. max 10 bar and 5 litre volume.

In accordance we therefore maximised the volume to max 5 litre cylinder.

PDE3570TCEN Pneumatic Cylinders ISO 15552

Dimensions

Dimensions [mm]

Cyl.-bore [mm]	A	ØB e11	ØBA d11	BG Front Rear	ØD	D4	ØD5	ØD6	E	EE	G	KK	L2	L3	L8
Ø32	22	30	30	16 17	12	42.5	35	5.3	47	G1/8	28.4	M10x1.25	16.8	4.5	94
Ø40	24	35	35	16 17	16	48	43	5.3	53	G1/4	33	M12x1.25	19	4.5	105
Ø50	32	40	40	16 18	20	59.5	54	7.1	64.5	G1/4	33.4	M16x1.5	27.6	4.5	106
Ø63	32	45	45	16 18	20	69.5	67	7.1	75	G3/8	39.4	M16x1.5	24.3	4.5	121
Ø80	40	45	45	17 20	25	86	85	8.9	94	G3/8	39.4	M20x1.5	30.1	5.5	128
Ø100	40	55	55	17 20	25	103	105	8.9	111	G1/2	44.3	M20x1.5	34	5.5	138
Ø125	54	60	60	20 20	32	130	130	10.8	136	G1/2	50.8	M27x2	45	0	160

Cyl.-bore [mm]	L12	OA	PL	PP	RT	SS	SW	TG	TT	VA	VD	WH	WL	WT	ZM
Ø32	6	6	14	20	M6	5	10	32.5	6.5	3.6	6	26	21	M8x1	146
Ø40	6.5	6	16	22	M6	6	13	38	9	3.5	6	30	23	M10x1.25	165
Ø50	8	8	15.5	21.5	M8	6	17	46.5	9	3.6	6	37	31	M14x1.5	180
Ø63	8	8	18	28	M8	10	17	56.5	11	3.5	6	37	31	M14x1.5	195
Ø80	10	10	20	30	M10	11.5	22	72	14	3.5	6	46	39	M18x1.5	220
Ø100	10	10	18	33	M10	11.5	22	89	14	3.5	6	51	39	M18x1.5	240
Ø125	13	8	20	40	M12	0	27	110	22	5.5	9	65	53	M24x2	290

Cyl.-bore [mm]	LG	LK	LL8	LPL	LPP	LVD	LWH	LX
Ø32	66.4	10	132	52	58	4	15	6
Ø40	69	11	141	56	59	4	16	6
Ø50	73.3	9	146	57	65	4	17	7
Ø63	87.6	28	169	71	80	4	17	7
Ø80	102.4	27	191	85	95	4	20	7
Ø100	125.3	54	219	103	116	4	20	7
Ø125	132.8	59	242	111	124	6	27	7

Cyl.-bore [mm]	HE1	HE2	HF	HG	HK	HKE	HL8	HVD	HX	HY
Ø32	50	48	12	48	16	G1/8	142	10	40	25
Ø40	58	56	12	55	19.5	G1/8	160	10	40.5*	27.5
Ø50	70	68	16	70	21	G1/8	176	12	48.5*	32.5
Ø63	85	82	15	70	21	G1/8	191	12	49*	41
Ø80	105	100	16	90	28	G1/8	218	20	65.5*	49
Ø100	130	120	18	92	27	G1/8	230	23	59.5*	53
Ø125	150	140	27	122	37	G1/8	282	32	69.5*	65

Tolerances [mm]

Cyl.-bore [mm]	A	L8	TG	ZM	stroke tolerance			P1F-P		
					350 mm < s			Cyl.-bore [mm]	Air volume base 0 mm [cm³]	Air volume per stroke of [cm³/100 mm]
					s ≤ 350 mm	≤ 600 mm	s > 600 mm			
Ø32	0/-0.5	± 0.3	±0.4	-0.4/+2.2	+ 1.7	+ 1.9	+ 2.3	Ø32	40	80
Ø40	0/-0.5	± 0.3	±0.4	-0.4/+2.2	+ 1.7	+ 1.9	+ 2.3	Ø40	68	126
Ø50	0/-0.5	-0.3/+0.5	±0.4	-0.4/+2.2	+ 1.8	+ 2	+ 2.4	Ø50	91	196
Ø63	0/-0.5	-0.6/+0.2	±0.4	-0.4/+2.2	+ 1.9	+ 2.1	+ 2.5	Ø63	137	312
Ø80	0/-0.5	± 0.4	±0.4	-0.4/+2.2	+ 1.9	+ 2.1	+ 2.5	Ø80	289	503
Ø100	0/-0.5	± 0.5	±0.4	-0/+2.5	+ 2.0	+ 2.2	+ 2.6	Ø100	417	785
Ø125	0/-1.0	± 0.5	±0.4	-0/+2.6	+ 2.1	+ 2.3	+ 2.7	Ø125	809	1227



PDE3570TCEN

Pneumatic Cylinders ISO 15552

Order code

Order Instructions	P 1 F - S 0 3 2 M S - 0 1 6 0 - 0 0 0 0
---------------------------	--

Profile/cylinder design	
S	Smooth
A ¹⁾	ATEX smooth
K	Smooth with through rod
L ²⁾⁴⁾	Smooth with dynamic rod lock
H ²⁾⁴⁾	Smooth with static rod lock
T	Tie-Rods
N	Tie-Rods with through rod
P ²⁾	Air reservoir

Cylinder bore size	
032	32 mm
040	40 mm
050	50 mm
063	63 mm
080	80 mm
100	100 mm
125	125 mm

Temperature range	
M ¹⁾	Standard Temperature -20° to +80°C
F ³⁾	High Temperature -10° to +150°C
L ³⁾	Low Temperature -40°C to +80°C
Q ⁴⁾	Metallic scraper -30°C to +80°C
V ⁵⁾	FKM rod seal -10°C to +80°C
D ⁵⁾	Polon rod seal -20°C to +80°C

Rod extension or trunnion mounting	
0000	without
P . . .	Piston rod extension in mm
G000	Trunnion mount +90° vs. air ports
7000	Trunnion mount +0° vs. air ports
H . . .	piston rod extension in mm with trunnion +90°
S . . .	piston rod extension in mm with trunnion +0°

Cylinder stroke	
....	Stroke length in mm

Piston style	
-	Standard with magnet
F	Standard w/o magnet
X *	Aluminium with magnet
A	Aluminium w/o magnet

Air reservoir	
-	without piston

Piston Rod material male thread	
S ¹⁾	Stainless steel
C	Chrome plated carbon steel
R	Chrome plated stainless steel

Piston Rod material female thread	
E ¹⁾	Stainless steel
F	Chrome plated carbon steel
G	Chrome plated stainless steel

Air reservoir	
A	without piston rod

¹⁾ ATEX version is specified for standard temperature range -20°C to +60°C
²⁾ in standard temperature range -20°C to +80°C
³⁾ High and low temp option only with aluminium piston
⁴⁾ Only in combination with chrome plated piston rod material
⁵⁾ With anodised end covers, high polymer piston rod bushing and stainless steel end covers screws and nut. Only for S and K cylinder design

* Note that for high temperature applications the magnetic field strength can be too low to ensure a reliable sensor function and therefore we cannot guarantee position detection.

Standard strokes for all P1F cylinders compliant to ISO 4393

(with the exception of stroke 40 mm)
 Non standard strokes up to 2500 mm

Order code order	Cylinder bore (mm)	● = Standard stroke (mm)	■ = Non standard stroke to special
		0025 0040 0050 0080 0100 0125 0160 0200 0250 0320 0400 0500 0600 0700 0800 2500	
P1F-S032MS - 32	32	●	■
P1F-S040MS - 40	40	●	■
P1F-S050MS - 50	50	●	■
P1F-S063MS - 63	63	●	■
P1F-S080MS - 80	80	●	■
P1F-S100MS - 100	100	●	■
P1F-S125MS - 125	125	●	■



PDE3570TCEN Pneumatic Cylinders ISO 15552

Mountings

	Flange MF1 / MF2 ^①	Foot brackets MS1 ^②	Pivot bracket with rigid bearing AB7 ^③	Swivel eye bracket MP6 ^④	Clevis bracket MP2 ^⑤
Ø32	P1C-4KMB	P1C-4KMF	P1C-4KMDB	P1C-4KMSB	P1C-4KMTB
Ø40	P1C-4LMB	P1C-4LMF	P1C-4LMDB	P1C-4LMSB	P1C-4LMTB
Ø50	P1C-4MMB	P1C-4MMF	P1C-4MMDB	P1C-4MMSB	P1C-4MMTB
Ø63	P1C-4NMB	P1C-4NMF	P1C-4NMDB	P1C-4NMSB	P1C-4NMTB
Ø80	P1C-4PMB	P1C-4PMF	P1C-4PMDB	P1C-4PMSB	P1C-4PMTB
Ø100	P1C-4QMB	P1C-4QMF	P1C-4QMDB	P1C-4QMSB	P1C-4QMTB
Ø125	P1C-4RMB	P1C-4RMF	P1C-4RMDB	P1C-4RMSB	P1C-4RMTB

	Clevis bracket MP4 ^⑥	Clevis bracket AB6 ^⑦	Pivot bracket with swivel bearing CS7 ^⑧	3 and 4 position flange JP1 ^⑨	Pivot brackets AT4 ^⑩
Ø32	P1C-4KMEB	P1C-4KMCEB	P1C-4KMAF	P1E-6KB0	9301054261
Ø40	P1C-4LMEB	P1C-4LMCEB	P1C-4LMAF	P1E-6LB0	9301054262
Ø50	P1C-4MMEB	P1C-4MMEB	P1C-4MMAF	P1E-6MB0	9301054262
Ø63	P1C-4NMEB	P1C-4NMEB	P1C-4NMAF	P1E-6NB0	9301054264
Ø80	P1C-4PMEB	P1C-4PMEB	P1C-4PMAF	P1E-6PB0	9301054264
Ø100	P1C-4QMEB	P1C-4QMEB	P1C-4QMAF	P1E-6QB0	9301054266
Ø125	P1C-4RMEB	P1C-4RMEB	P1C-4RMAF		9301054266

	Flange trunnion MT5/MT6 ^⑪	Intermediate trunnion MT4 ^⑫
Ø32	P1D-4KMYF	refer to page 34
Ø40	P1D-4LMYF	refer to page 34
Ø50	P1D-4MMYF	refer to page 34
Ø63	P1D-4NMYF	refer to page 34
Ø80	P1D-4PMYF	refer to page 34
Ø100	P1D-4QMYF	refer to page 34
Ø125		refer to page 34

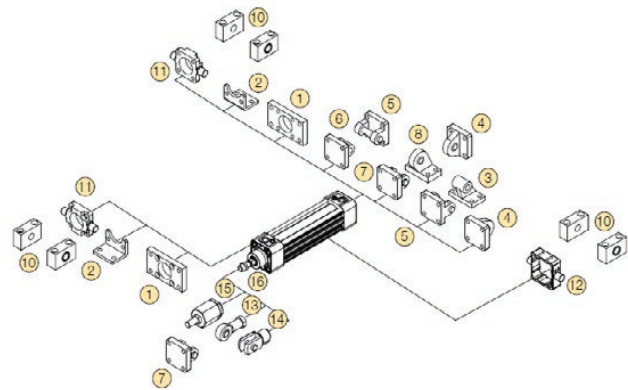

	Nut MR9 (pack of 10) ^⑬ Zinc plated steel	Stainless steel	Swivel rod eye AP6 ^⑭	Clevis AP2 ^⑮	Flexo coupling PM5 ^⑯
Ø32	P14-4KRPZ	P14-4KRPS	P1C-4KRS	P1C-4KRC	P1C-4KRF
Ø40	P14-4LRPZ	P14-4LRPS	P1C-4LRS	P1C-4LRC	P1C-4LRF
Ø50	P14-4MRPZ	P14-4MRPS	P1C-4MRS	P1C-4MRC	P1C-4MRF
Ø63	P14-4MRPZ	P14-4MRPS	P1C-4MRS	P1C-4MRC	P1C-4MRF
Ø80	P14-4PRPZ	P14-4PRPS	P1C-4PRS	P1C-4PRC	P1C-4PRF
Ø100	P14-4PRPZ	P14-4PRPS	P1C-4PRS	P1C-4PRC	P1C-4PRF
Ø125	P14-4RRPZ	P14-4RRPS	P1C-4RRS	P1C-4RRC	P1C-4RRF

PDE3570TCEN Pneumatic Cylinders ISO 15552

Seal Kits

Complete seal kits consisting of:

- 2 piston seals.
- 2 cushioning seals.
- 1 wiper / piston rod seal.
- 2 O-Rings.
- 1 grease (30g)

Greases

	Standard and low temperature	30 g	9127394541
	High temperature	30 g	9127394521

Cyl.-bore [mm]	Standard temperature ¹⁾	High temperature ¹⁾	Low temperature ¹⁾	Metallic scraper ^{1) 2)}	FKM Wiper seal ¹⁾	With dyn. rod lock ¹⁾	With static rod lock ¹⁾	Polon/UHMW-PE
Ø32	P1F-6032RN	P1F-6032RF	P1F-6032RL	P1F-6032RQ	P1F-6032RV	P1F-6032RNL	P1F-6032RNH	P1F-6032RD
Ø40	P1F-6040RN	P1F-6040RF	P1F-6040RL	P1F-6040RQ	P1F-6040RV	P1F-6040RNL	P1F-6040RNH	P1F-6040RD
Ø50	P1F-6050RN	P1F-6050RF	P1F-6050RL	P1F-6050RQ	P1F-6050RV	P1F-6050RNL	P1F-6050RNH	P1F-6050RD
Ø63	P1F-6063RN	P1F-6063RF	P1F-6063RL	P1F-6063RQ	P1F-6063RV	P1F-6063RNL	P1F-6063RNH	P1F-6050RD
Ø80	P1F-6080RN	P1F-6080RF	P1F-6080RL	P1F-6080RQ	P1F-6080RV	P1F-6080RNL	P1F-6080RNH	P1F-6080RD
Ø100	P1F-6100RN	P1F-6100RF	P1F-6100RL	P1F-6100RQ	P1F-6100RV	P1F-6100RNL	P1F-6100RNH	P1F-6100RD
Ø125	P1F-6125RN	P1F-6125RF	P1F-6125RL	P1F-6125RQ	P1F-6125RV	P1F-6125RNL	P1F-6125RNH	P1F-6125RD

¹⁾ for through piston rod, add K at the end, ie P1F-6032RNK

²⁾ -30 to +80°C

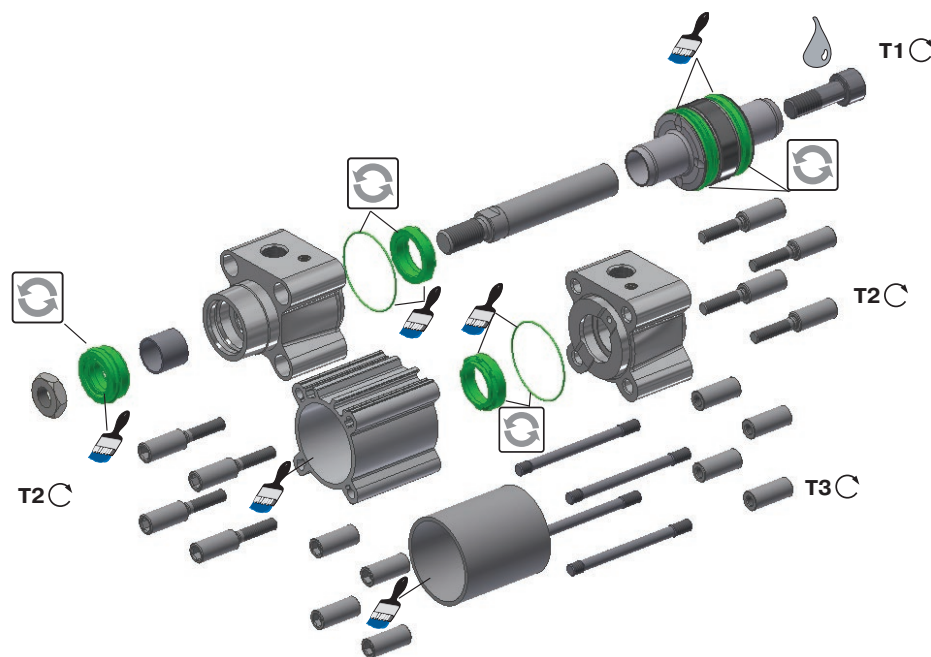

Cyl.-bore [mm]	AF [mm]	Plastic piston T1 [Nm]	Alu Piston T1 [Nm]	AF [mm]	T2 [Nm]	AF [mm]	T3 [Nm]
Ø32	6	4.5	15	6	11	6	4.5
Ø40	8	11	30	8	11	6	4.5
Ø50	10	20	40	10	18	8	9.5
Ø63	10	20	40	10	18	8	9.5
Ø80	14	40	120	14	29	6	19
Ø100	14	120	120	14	29	6	19
Ø125	14	120	120	14	70	8	40



= Included in seal kit



= Socket head across flats



= Tightening torque



Lubricate with grease



Locking fluid
Loctite 270 or Loctite 2701 locking fluid must be used

PDE3570TCEN Pneumatic Cylinders ISO 15552

Technical Data

Cylinder forces

Bore/piston rod [mm]	Stroke	Surface area [cm ²]	Max theoretical force in N (under different pressure bar)									
			1	2	3	4	5	6	7	8	9	10
32/2x8	+	8.0	80	161	241	322	402	483	563	643	724	804
	-	7.0	70	141	211	281	352	422	493	563	633	704
40/2x10	+	12.6	126	251	377	503	628	754	880	1005	1131	1257
	-	11.0	110	220	330	440	550	660	770	880	990	1100
50/2x12	+	19.6	196	393	589	785	982	1178	1374	1571	1767	1964
	-	17.4	174	347	521	695	869	1042	1216	1390	1564	1737
63/2x16	+	31.2	312	623	935	1247	1559	1870	2182	2494	2806	3117
	-	27.2	272	543	815	1086	1358	1629	1901	2172	2444	2715
80/2x20	+	50.3	503	1005	1508	2011	2513	3016	3519	4021	4524	5027
	-	44.0	440	880	1319	1759	2199	2639	3079	3519	3958	4398
100/2x20	+	78.5	785	1571	2356	3142	3927	4712	5498	6283	7069	7854
	-	72.3	723	1445	2168	2890	3613	4335	5058	5781	6503	7226

+ = outward stroke
- = return stroke

Cylinder air consumption

Bore/piston rod [mm]	Stroke	Surface area [cm ²]	Air consumption in l [NI] / 10 mm in relation to applied pressure in bar									
			1	2	3	4	5	6	7	8	9	10
32/2x8	+	8.0	0.016	0.024	0.032	0.040	0.048	0.056	0.064	0.072	0.079	0.087
	-	7.0	0.014	0.021	0.028	0.035	0.042	0.049	0.056	0.063	0.070	0.077
40/2x10	+	12.6	0.025	0.037	0.050	0.062	0.075	0.087	0.099	0.112	0.124	0.137
	-	11.0	0.022	0.033	0.044	0.054	0.065	0.076	0.087	0.098	0.109	0.120
50/2x12	+	19.6	0.039	0.058	0.078	0.097	0.117	0.136	0.155	0.175	0.194	0.213
	-	17.4	0.035	0.052	0.069	0.086	0.103	0.120	0.137	0.155	0.172	0.189
63/2x16	+	31.2	0.062	0.093	0.123	0.154	0.185	0.216	0.247	0.277	0.308	0.339
	-	27.2	0.054	0.081	0.108	0.134	0.161	0.188	0.215	0.242	0.268	0.295
80/2x20	+	50.3	0.100	0.150	0.199	0.249	0.298	0.348	0.398	0.447	0.497	0.546
	-	44.0	0.087	0.131	0.174	0.218	0.261	0.304	0.348	0.391	0.435	0.478
100/2x20	+	78.5	0.156	0.234	0.311	0.389	0.466	0.544	0.621	0.699	0.776	0.854
	-	72.3	0.144	0.215	0.286	0.358	0.429	0.500	0.572	0.643	0.714	0.786

+ = outward stroke
- = return stroke

Weight

Cyl.-bore [mm]	P1F-R		P1F-Q		Moving parts	
	Base 0 mm [kg]	per 100 mm [kg]	Base 0 mm [kg]	per 100 mm [kg]	Base 0 mm [kg]	per 100 mm [kg]
Ø32	0.8	0.25	1.0	0.3	0.08	0.08
Ø40	1.0	0.35	1.4	0.4	0.17	0.15
Ø50	1.7	0.50	2.3	0.6	0.32	0.24
Ø63	2.6	0.60	3.2	0.9	0.38	0.23
Ø80	4.2	0.90	5.6	1.4	0.71	0.38
Ø100	6.2	1.00	7.4	1.5	1.00	0.37



PDE3570TCEN Pneumatic Cylinders ISO 15552

Technical Data

Product type	Cylinder with Twin Rods (not ISO)
Bore size	32 - 100 mm
Stroke length	5 - 2000 mm
Versions	Double acting
Cushioning	Adjustable air cushioning
Position sensing	Proximity sensor
Installation	ISO mountings



Operating and environmental data

Operating medium	For best possible service life and trouble-free operation dry filtered compressed air to ISO 8573-1:2010 quality 3.4.3 should be used. This specifies a dew point of + 3°C for indoor operation (a lower dew point should be selected for minus temperature operation and we recommend the use of an inline dryer) and is in line with the air quality from most standard compressors with a standard filter.
Operating pressure	1 to 10 bar
Ambient temperature	Standard temperature (option M): -20°C to +80°C High temperature (option F): -10°C to +150°C
Pre-lubricated	Further lubrication is normally not necessary. If additional lubrication is introduced it must be continued. Hydraulic oil type HLP (DIN 51524, ISO 11158). Viscosity by 40°C: 32 mm ² /s (cst). Example: Shell Tellus 32 or equal.
Corrosion resistance	Material and surface treatment selected for typical industrial applications with resistance to corrosion and chemicals.

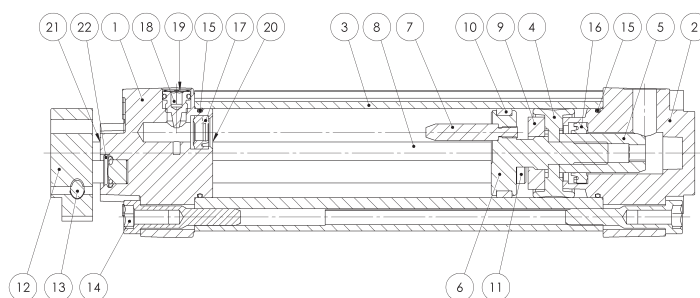

Material specification

Pos	Part	Specification
1, 2	End cover	Aluminium
3	Cylinder barrel	Anodised aluminium profile
4	Piston	Standard: Nitrile rubber (NBR) Optional: Floro elastomer (FKM) (Available only for 40mm bore)
5	Sleeve	Brass
6	Support	Aluminium
7	Sleeve	Brass
8	Piston rod	Austenitic stainless steel, DIN X8 CrNiS 18-9
9	Magnet	Plastic coated magnetic material
10	Piston bearing	Polytetrafluoroethylene (PTFE)
11	Screw	Zinc plated steel
12	Front plate	Steel
13	Screw	Zinc plated steel
14	End covers screws	Zinc plated steel
15	O-ring end cover	Standard: Nitrile rubber (NBR) Optional: Floro elastomer (FKM) (Available only for 40mm bore)
16, 17	Cushioning seal	Standard: Nitrile rubber (NBR) Optional: Floro elastomer (FKM) (Available only for 40mm bore)
18	Cushioning screw	Brass
19	Cushioning retainer	Steel
	O-ring cushioning screws	Standard: Nitrile rubber (NBR) Optional: Floro elastomer (FKM) (Available only for 40mm bore)
20	Piston rods bearing	Multilayer Steel
21	Retainer	Spring Steel
22	Piston rod seal	Standard: Nitrile rubber (NBR) Optional: Floro elastomer (FKM) (Available only for 40mm bore)

PDE3570TCEN
Pneumatic Cylinders ISO 15552

Installation Instructions for Twin Rods Cylinders

For maximum reliability and service life, Charge latérale dus should be applied as shown.

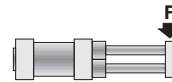

Transverse Load - Ø32 - 100 mm

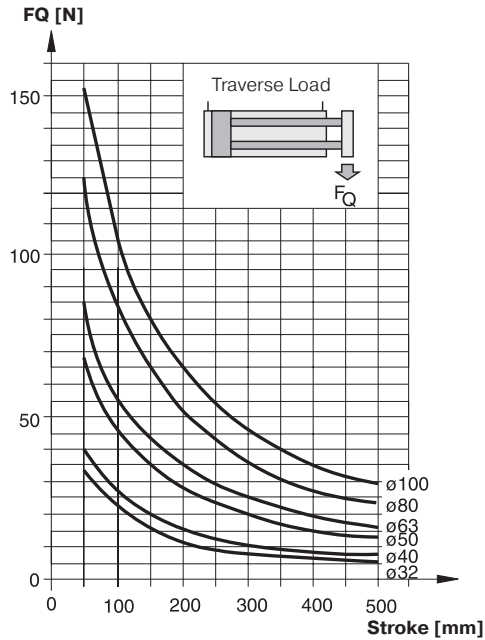

Torgue moment load - Ø32 - 100 mm

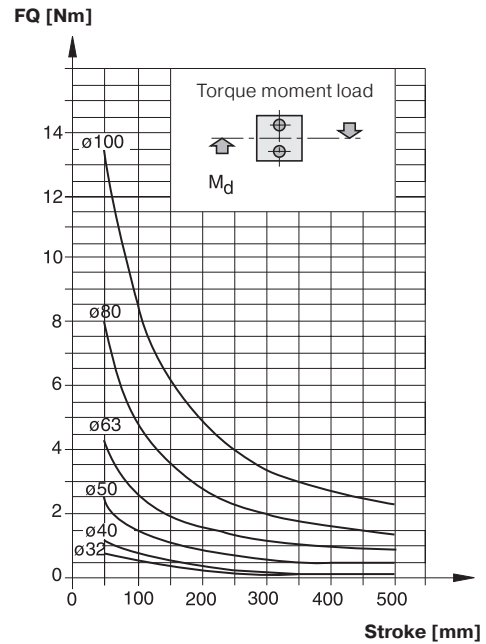

Transverse and Torque Moment Load - Ø32 mm

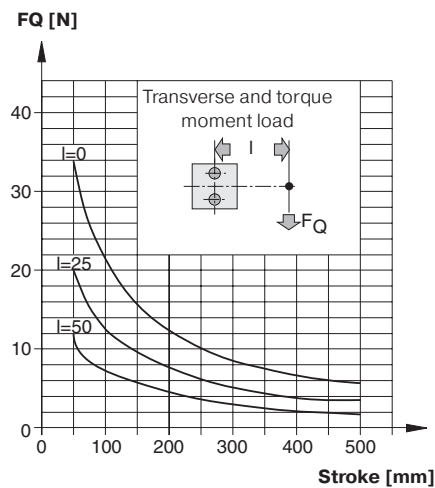

Transverse and Torque Moment Load - Ø40 mm

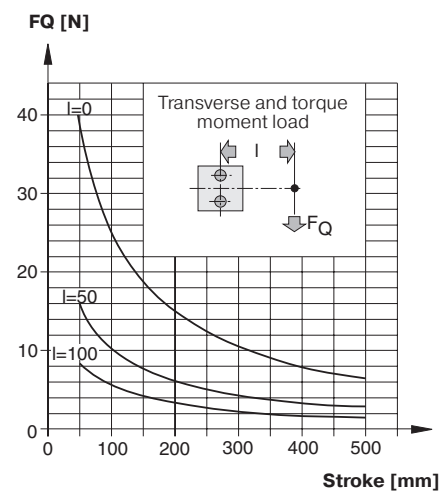

PDE3570TCEN
Pneumatic Cylinders ISO 15552

Transverse and Torque Moment Load - Ø 50 mm

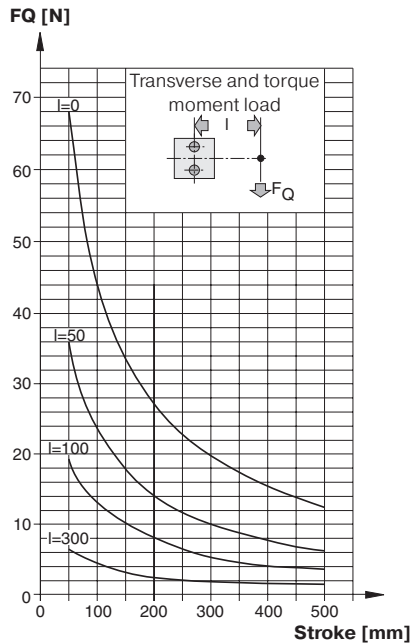

Transverse and Torque Moment Load - Ø 63 mm

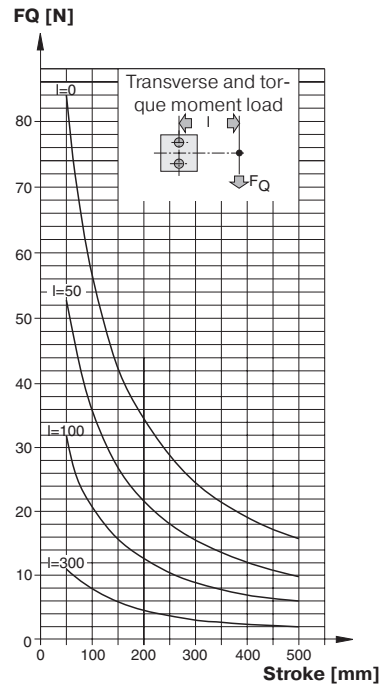

Transverse and Torque Moment Load - Ø 80 mm

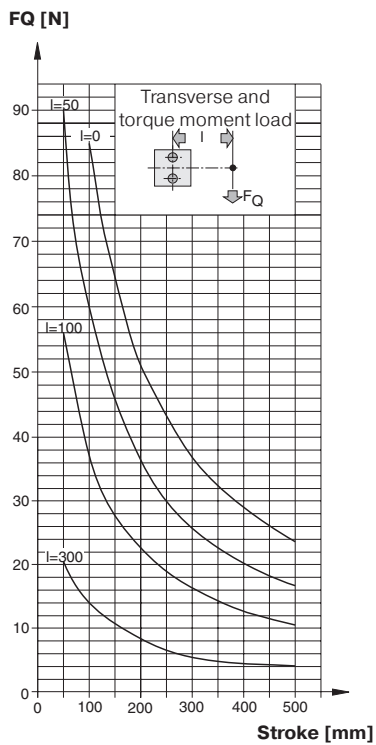

Transverse and Torque Moment Load - Ø 100 mm

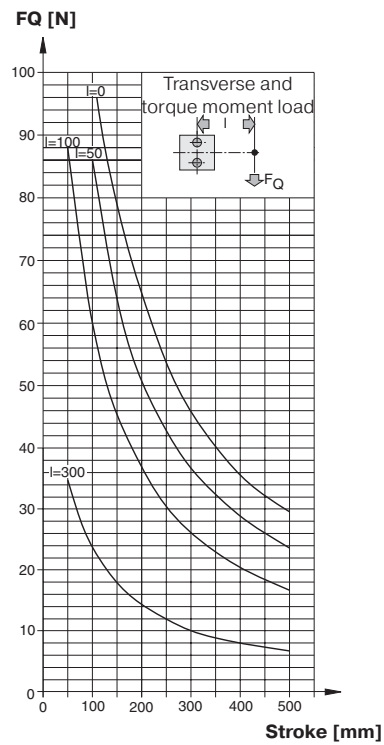

PDE3570TCEN
Pneumatic Cylinders ISO 15552

Dimensions

Twin-Rods smooth profile design

P1F-R

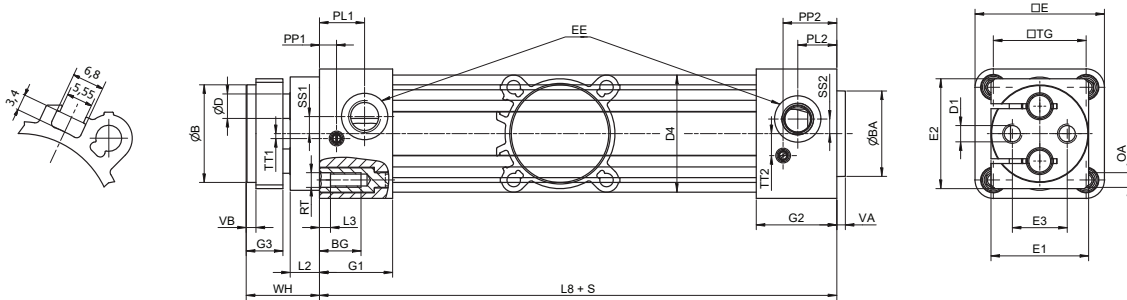

Through Twin-Rods smooth profile design

P1F-Q

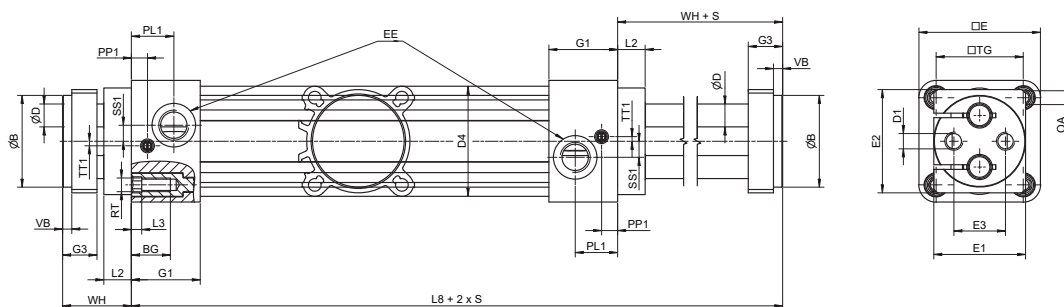

PDE3570TCEN Pneumatic Cylinders ISO 15552

Dimensions

Dimensions [mm]

Cyl.- bore [mm]	E3	ØB h9	ØBA* -0,1	BG	ØD	D1	D4	E1	E2	EE*	G1	G2	G3	VA*	VB
Ø32	19	32	30	16	8	M6	32	32	40	G1/8	26	28.4	15	3.6	4
Ø40	22.5	40	35	16	10	M8	40	40	45	G1/4	30	33	15	3.5	4
Ø50	30	50	40	16	12	M8	50	50	55	G1/4	34	33.4	18	3.6	4
Ø63	38	63	45	16	16	M10	63	63	70	G3/8	34	39.4	22	3.5	4
Ø80	50	80	45	16	20	M12	80	80	95	G3/8	39	39.4	22	3.5	4
Ø100	70	100	55	16	20	M12	100	100	115	G1/2	40	44.3	22	3.5	4

*Dimensions in accordance with ISO

Cyl.- bore [mm]	L3	L8	OA	PL1	PP1	PL2	PP2	RT	SS1	TT1	SS2	TT2	TG*	E*	L2	WH
Ø32	4.5	102	6	17	8	14	20	M6	6	2	5	6.5	32.5	47	8	26
Ø40	4.5	112	6	18.5	7	16	22	M6	7	2	6	9	38	53	12	30
Ø50	4.5	117	8	22.5	27	15.5	21.5	M8	9.5	4	6	9	46.5	65	13	34
Ø63	4.5	125	8	17.5	28	18	28	M8	10	6	10	11	56.5	75	11	36
Ø80	5.5	136	10	20.5	30	20	30	M10	9	14	11.5	11	72	95	13	38
Ø100	5.5	143	10	19	33	18	33	M10	13	14	11.5	14	89	115	13	38

*Dimensions in accordance with ISO

Tolerances [mm]

Cyl.-bore [mm]	WH	L8	TG	stroke tolerance		
				s ≤ 350 mm	350 mm < s ≤ 600 mm	s > 600 mm
Ø32	0 / - 0.5	± 0.3	± 0.4	+ 1.7	+ 1.9	+ 2.3
Ø40	0 / - 0.5	± 0.3	± 0.4	+ 1.7	+ 1.9	+ 2.3
Ø50	0 / - 0.5	± 0.4	± 0.4	+ 1.8	+ 2	+ 2.4
Ø63	0 / - 0.5	- 0.5 / + 0.3	± 0.4	+ 1.9	+ 2.1	+ 2.5
Ø80	0 / - 0.5	± 0.4	± 0.4	+ 1.9	+ 2.1	+ 2.5
Ø100	0 / - 0.5	± 0.5	± 0.4	+ 2.0	+ 2.2	+ 2.6

PDE3570TCEN Pneumatic Cylinders

Order code

Order Instructions	P	1	F	-	R	0	3	2	M	S	X	0	1	6	0	-	0	0	0	0
---------------------------	---	---	---	---	---	---	---	---	---	---	---	---	---	---	---	---	---	---	---	---

Profile/cylinder design	
R	Smooth Twin-Rods
Q	Smooth Through Twin-Rods

Cylinder bore size	
032	32 mm
040	40 mm
050	50 mm
063	63 mm
080	80 mm
100	100 mm

Temperature range	
M	Standard Temperature -20° to +80°C
F	High Temperature -10°C to +150°C (Available only for 40mm bore)

Rod extension or trunnion mounting	
0000	without
P . . .	Piston rod extension in mm
G000	Trunnion mount +90° vs. air ports
7000	Trunnion mount +0° vs. air ports
H . . .	piston rod extension in mm with trunnion +90°
8 . . .	piston rod extension in mm with trunnion +0°

Cylinder stroke	
....	Stroke length in mm

Piston style	
X *	Aluminium with magnet
A	Aluminium w/o magnet

*not for high temperature range

Piston Rod material	
S	Stainless steel

PDE3570TCEN Pneumatic Cylinders

Mountings

Flange MF1/MF2 *^①



Foot brackets MS1**^②



Pivot bracket with rigid bearing AB7^③



Swivel eye bracket MP6^④



Clevis bracket MP2^⑤



Ø32	P1C-4KMB	P1F-4KMHF	P1C-4KMDB	P1C-4KMSB	P1C-4KMTB
Ø40	P1C-4LMB	P1F-4LMHF	P1C-4LMDB	P1C-4LMSB	P1C-4LMTB
Ø50	P1C-4MMB	P1F-4MMHF	P1C-4MMDB	P1C-4MMSB	P1C-4MMTB
Ø63	P1C-4NMB	P1F-4NMHF	P1C-4NMDB	P1C-4NMSB	P1C-4NMTB
Ø80	P1C-4PMB	P1F-4PMHF	P1C-4PMDB	P1C-4PMSB	P1C-4PMTB
Ø100	P1C-4QMB	P1F-4QMHF	P1C-4QMDB	P1C-4QMSB	P1C-4QMTB

Clevis bracket MP4^⑥



Clevis bracket AB6^⑦



Pivot bracket with swivel bearing CS7^⑧



3 and 4 position flange JP1^⑨



Pivot brackets AT4^⑩



Ø32	P1C-4KMEB	P1C-4KMCB	P1C-4KMAF	P1E-6KB0	9301054261
Ø40	P1C-4LMEB	P1C-4LMCB	P1C-4LMAF	P1E-6LB0	9301054262
Ø50	P1C-4MMEB	P1C-4MMCB	P1C-4MMAF	P1E-6MB0	9301054262
Ø63	P1C-4NMEB	P1C-4NMCB	P1C-4NMAF	P1E-6NB0	9301054264
Ø80	P1C-4PMEB	P1C-4PMCB	P1C-4PMAF	P1E-6PB0	9301054264
Ø100	P1C-4QMEB	P1C-4QMCB	P1C-4QMAF	P1E-6QB0	9301054266

Flange trunnion MT5/MT6 *^⑪



Intermediate trunnion MT4^⑫



Ø32	P1D-4KMYF	refer to page 34
Ø40	P1D-4LMYF	refer to page 34
Ø50	P1D-4MMYF	refer to page 34
Ø63	P1D-4NMYF	refer to page 34
Ø80	P1D-4PMYF	refer to page 34
Ø100	P1D-4QMYF	refer to page 34

* only on rear end cap, ** specific to Twin Rods cylinders

PDE3570TCEN Pneumatic Cylinders

Seal Kits

Complete seal kits consisting of:

- 1 piston seal.
- 2 cushioning seals.
- 2 wiper / piston rod seals.
- 2 O-Rings.
- 1 piston bearing ring.
- 1 grease (4g).

Cyl.-bore [mm]	Standard temperature ¹⁾	High temperature ¹⁾
Ø32	P1FA6032RNR	Not Available
Ø40	P1FA6040RNR	P1F-6040RFR
Ø50	P1F-6050RNR	Not Available
Ø63	P1F-6063RNR	Not Available
Ø80	P1F-6080RNR	Not Available
Ø100	P1F-6100RNR	Not Available

¹⁾ for through piston Twin Rods, add K at the end, ie P1F-6032RNRK

Grease

	Standard temperature
	High temperature
	4 g
	KL8220

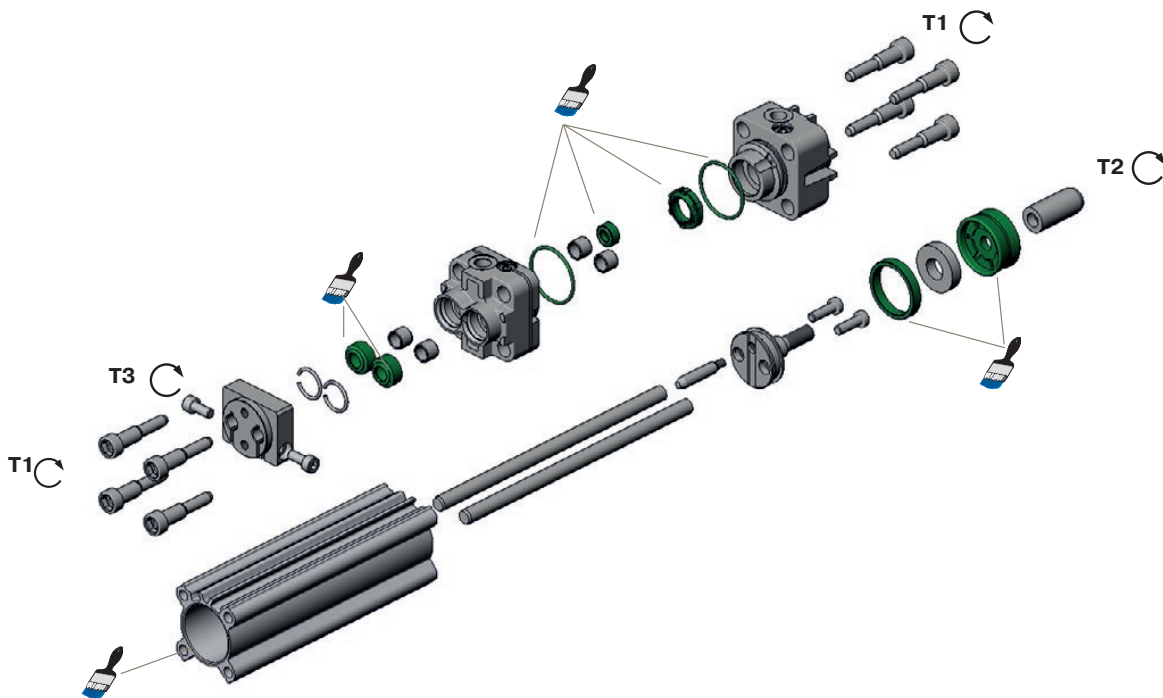

Cyl.-bore	Piston T1	AF	T2	AF	T3	AF
[mm]	[Nm]	[mm]	[Nm]	[mm]	[Nm]	[mm]
Ø32	10 - 12	8	5-6	5	5.5 ± 0.8	4
Ø40	10 - 12	8	12-14	6	5.5 ± 0.8	4
Ø50	16 - 20	10	16-18	10	10 ± 1.5	5
Ø63	16 - 20	10	16-18	10	20 ± 3	6
Ø80	26 - 32	12	20-23	12	20 ± 3	6
Ø100	26 - 32	12	20-23	12	20 ± 3	6



= Included in seal kit



Lubricate with grease



= Socket head
across flats



Locking fluid
Loctite 638 locking
fluid must be used



= Tightening torque

PDE3570TCEN Pneumatic Cylinders ISO 15552

Flange - MF1 / MF2**



Intended for fixed mounting of cylinder.
Flange can be fitted to front or rear end cover of cylinder.

Materials:

Flange: Surface-treated steel
Mounting screws acc. to DIN 6912:
Zinc-plated steel 8.8
Supplied complete with mounting screws for attachment to the cylinder.

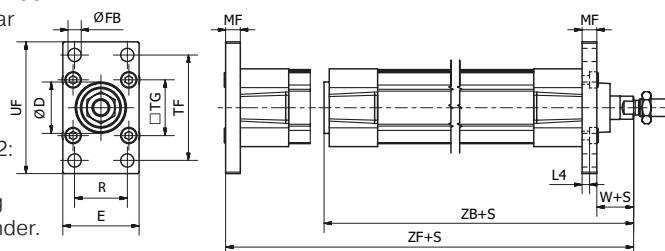

According to ISO 15552

Cyl. -bore	D _(H11)	E	ØFB _(H13)	L4	MF	R	TF	TG	UF	W*	ZB*	ZF*	Weight	Order code
[mm]	[mm]	[mm]	[mm]	[mm]	[mm]	[mm]	[mm]	[mm]	[mm]	[mm]	[mm]	[mm]	[kg]	
Ø32	30	45	7	5.0	10	32	64	32.5	80	16	123.5	130	0.21	P1C-4KMB
Ø40	35	52	9	5.0	10	36	72	38.0	90	20	138.5	145	0.27	P1C-4LMB
Ø50	40	65	9	6.5	12	45	90	46.5	110	25	146.5	155	0.53	P1C-4MMB
Ø63	45	75	9	6.5	12	50	100	56.5	120	25	161.5	170	0.66	P1C-4NMB
Ø80	45	95	12	9.0	16	63	126	72.0	150	30	177.5	190	1.45	P1C-4PMB
Ø100	55	115	14	9.0	16	75	150	89.0	170	35	192.5	205	1.60	P1C-4QMB
Ø125	60	140	16	10.5	20	90	180	110.0	205	45	230.5	245	3.34	P1C-4RMB

*Does not apply to cylinders with piston rod extension, lock units and Twin Rods, see page 38.

** only on rear end cap Twin Rods cylinders.

Foot Bracket - MS1



Intended for fixed mounting of cylinder.
Foot bracket can be fitted to front or rear end cover of the cylinder.

Materials:

Flange: Surface-treated steel
Mounting screws acc. to DIN 6912:
Zinc-plated steel 8.8:

Supplied complete with mounting screws for attachment to the cylinder.

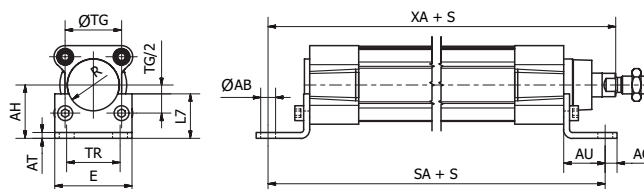

According to ISO 15552

Cyl. -bore	ØAB _(H14)	AH _(JS15)	AO	AT	AU	E	L7	R	SA*	TG _(JS14)	TR	XA*	Weight **	Order code
[mm]	[mm]	[mm]	[mm]	[mm]	[mm]	[mm]	[mm]	[mm]	[mm]	[mm]	[mm]	[mm]	[kg]	
Ø32	7	32	11/8	4	24	45/47	30/27	15	142	32.5	32	144	0.077	P1C-4KMF P1F-4KMHF
Ø40	10	36	8/10	4	28	52/53	30	17.5	161	38.0	36	163	0.084	P1C-4LMF P1F-4LMHF
Ø50	10	45	15/10	5	32	65	36/38	20	170	46.5	45	175/172	0.181	P1C-4MMF P1F-4MMHF
Ø63	10	50	13/10	5	32	75	35/40	22.5	185	56.5	50	190/189	0.204	P1C-4NMF P1F-4NMHF
Ø80	12	63	14/10	6	41	95	47/51	22.5	210	72.0	63	215/207	0.400	P1C-4PMF P1F-4PMHF
Ø100	14.5	71	16/15	6	41	115	53/51	27.5	220	89.0	75	230/217	0.539	P1C-4QMF P1F-4QMHF
Ø125	16.5	90	25	8	45	140	70	30	250	110.0	90	270	1.103	P1C-4RMF -

*Does not apply to cylinders with piston rod extension, lock units and Twin Rods, see page 38.

** per bracket

PDE3570TCEN Pneumatic Cylinders ISO 15552

Pivot Bracket with Rigid Bearing - AB7



Intended for flexible mounting of cylinder. The pivot bracket can be combined with clevis bracket MP2.

Materials:

Pivot bracket: Aluminium (no surface treatment)
Bush: Steel and PTFE

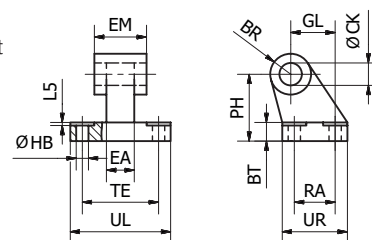

According to ISO 15552

Cyl.-bore	CK	HB	L5	TE	UL	GL	RA	EA	EM	UR	PH	BT	BR	Weight	Order code
[mm]	[mm]	[mm]	[mm]	[mm]	[mm]	[mm]	[mm]	[mm]	[mm]	[mm]	[mm]	[mm]	[mm]	[kg]	
Ø32	10	6.6	1.6	38	51	21	18	10	26	31	32	8	10.0	0.05	P1C-4KMDB
Ø40	12	6.6	1.6	41	54	24	22	15	28	35	36	10	11.0	0.09	P1C-4LMDB
Ø50	12	9.0	1.6	50	65	33	30	16	32	45	45	12	13.0	0.16	P1C-4MMDB
Ø63	16	9.0	1.6	52	67	37	35	16	40	50	50	14	15.0	0.20	P1C-4NMDB
Ø80	16	11.0	2.5	66	86	47	40	20	50	60	63	14	15.0	0.32	P1C-4PMDB
Ø100	20	11.0	2.5	76	96	55	50	20	60	70	71	17	19.0	0.53	P1C-4QMDB
Ø125	25	14.0	3.2	94	124	70	60	30	70	90	90	20	22.5	1.01	P1C-4RMDB

Pivot Bracket with Swivel Bearing - CS7



Intended for use together with clevis bracket AB6.

Materials:

Pivot bracket: Steel
(Surface-treated steel)
Swivel bearing acc. to DIN 648K:
Hardened steel

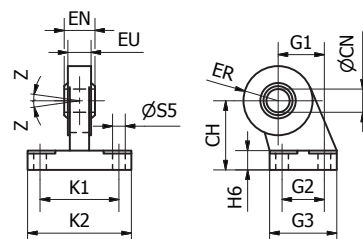

According to ISO 15552

Cyl.-bore	CN	S5	K1	K2	EU	G1	G2	EN	G3	CH	H6	ER	Z	Weight	Order code
[mm]	[mm]	[mm]	[mm]	[mm]	[mm]	[mm]	[mm]	[mm]	[mm]	[mm]	[mm]	[mm]		[kg]	
Ø32	10	6.6	38	51	10.5	21	18	14	31	32	10	15	4°	0.18	P1C-4KMAF
Ø40	12	6.6	41	54	12.0	24	22	16	35	36	10	18	4°	0.27	P1C-4LMAF
Ø50	16	9.0	50	65	15.0	33	30	21	45	45	12	20	4°	0.46	P1C-4MMAF
Ø63	16	9.0	52	67	15.0	37	35	21	50	50	12	23	4°	0.55	P1C-4NMAF
Ø80	20	11.0	66	86	18.0	47	40	25	60	63	14	27	4°	0.97	P1C-4PMAF
Ø100	20	11.0	76	96	18.0	55	50	25	70	71	15	30	4°	1.33	P1C-4QMAF
Ø125	30	13.5	94	124	25.0	70	60	37	90	90	20	40	4°	3.00	P1C-4RMAF



PDE3570TCEN Pneumatic Cylinders ISO 15552

Clevis Bracket - MP2



Intended for flexible mounting of cylinder.
Can be combined with clevis bracket MP4 and pivot bracket with rigid bearing AB7.

Materials:

Clevis bracket: Aluminium (no surface treatment)
Pin: Surface hardened steel
Locking pin: Spring steel
Circlips according to DIN 471: Spring steel
Mounting screws acc. to DIN 912: Zinc-plated steel 8.8

Supplied complete with mounting screws for attachment to the cylinder.

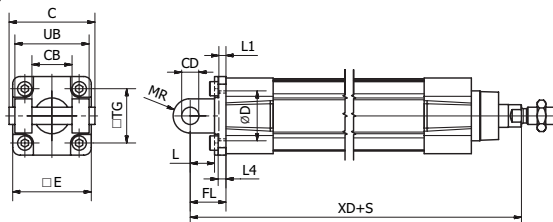

According to ISO 15552

Cyl.-bore	C	E	UB	CB	TG	FL	L1	L	L4	D	CD	MR	XD*	Weight	Order code
[mm]	[mm]	[mm]	[mm]	[mm]	[mm]	[mm]	[mm]	[mm]	[mm]	[mm]	[mm]	[mm]	[mm]	[kg]	
Ø32	53	45	45	26	32.5	22	5	13	5.5	30	10	10	142	0.08	P1C-4KMTB
Ø40	60	52	52	28	38	25	5	16	5.5	35	12	12	160	0.10	P1C-4LMTB
Ø50	68	65	60	32	46.5	27	5	16	6.5	40	12	12	170	0.18	P1C-4MMTB
Ø63	78	75	70	40	56.5	32	5	21	6.5	45	16	16	190	0.24	P1C-4NMTB
Ø80	98	95	90	50	72	36	5	22	10	45	16	16	210	0.49	P1C-4PMTB
Ø100	118	115	110	60	89	41	5	27	10	55	20	20	230	0.73	P1C-4QMTB
Ø125	139	140	130	70	110	50	7	30	10	60	25	25	275	1.37	P1C-4RMTB

*Does not apply to cylinders with piston rod extension, lock units and Twin Rods, see page 38.

Clevis Bracket - MP4



Intended for flexible mounting of cylinder. Clevis bracket MP4 can be combined with clevis bracket MP2.

Materials:

Clevis bracket: Aluminium (no surface treatment)
Bush: Steel and PTFE
Mounting screws acc. to DIN 912: Zinc-plated steel 8.8

Supplied complete with mounting screws for attachment to the cylinder.

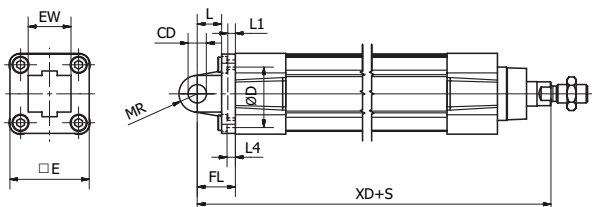

According to ISO 15552

Cyl.-bore	CD	D	E	EW	FL	L	L1	L4	MR	TG	XD*	Weight	Order code
[mm]	[mm]	[mm]	[mm]	[mm]	[mm]	[mm]	[mm]	[mm]	[mm]	[mm]	[mm]	[kg]	
Ø32	10	30	47	26	22	12	6.5	6	10.5	32.5	142	0.08	P1C-4KMEB
Ø40	12	35	52	28	25	16	5	5.5	12	38	160	0.11	P1C-4LMEB
Ø50	12	40	65	32	27	16	5	6.5	12	46.5	170	0.18	P1C-4MMEB
Ø63	16	45	78	40	32	21	5	6.5	16	56.5	190	0.28	P1C-4NMEB
Ø80	16	45	95	50	36	22	5	10	16	72	210	0.52	P1C-4PMEB
Ø100	20	55	115	60	41	27	5	10	20	89	230	0.79	P1C-4QMEB
Ø125	25	60	140	70	50	30	7	10	25	110	275	1.46	P1C-4RMEB

*Does not apply to cylinders with piston rod extension, lock units and Twin Rods, see page 38.

PDE3570TCEN Pneumatic Cylinders ISO 15552

Clevis Bracket - AB6



Intended for flexible mounting of cylinder. Clevis bracket AB6 can be combined with pivot brackets MP6 and CS7 or swivel rod eye AP6.

Materials:

Clevis bracket: Aluminium (no surface treatment)
Pin: Surface hardened steel
Locking pin: Spring steel
Circlips according to DIN 471: Spring steel
Mounting screws acc. to DIN 912: Zinc-plated steel 8.8
Supplied complete with mounting screws for attachment to the cylinder.

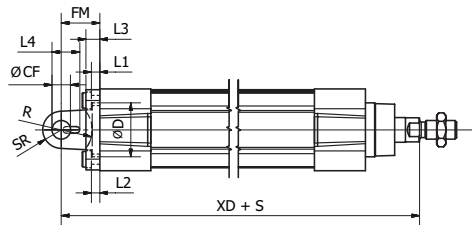
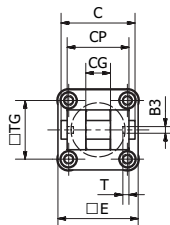

According to ISO 15552

Cyl-bore [mm]	B3 [mm]	C [mm]	CF [mm]	CG [mm]	CP [mm]	D [mm]	E [mm]	FM [mm]	I2 [mm]	T [mm]	R [mm]	L1 [mm]	L4 [mm]	L3 [mm]	SR [mm]	TG [mm]	XD* [mm]	Weight [kg]	Order code
Ø32	3.3	41	10	14	34	30	45	22	5.5	3	17	5	16.5	9	10	32.5	142	0.04	P1C-4KMCB
Ø40	4.3	48	12	16	40	35	52	25	5.5	4	20	5	18	9	12	38	160	0.07	P1C-4LMCB
Ø50	4.3	54	16	21	45	40	65	27	6.5	4	22	5	22	11	14	46.5	170	0.11	P1C-4MMCB
Ø63	4.3	60	16	21	51	45	75	32	6.5	4	25	5	22	11	18	56.5	190	0.19	P1C-4NMCB
Ø80	4.3	75	20	25	65	45	95	36	10.0	4	30	5	26	14	20	72	210	0.38	P1C-4PMCB
Ø100	6.3	85	20	25	75	55	115	41	10.0	4	32	5	26	14	22	89	230	0.61	P1C-4QMCB
Ø125	6.3	110	30	37	97	60	140	50	10.0	6	42	7	39	20	25	110	275	1.10	P1C-4RMCB

*Does not apply to cylinders with piston rod extension, lock units and Twin Rods, see page 38.

Swivel Eye Bracket - MP6



Intended for use together with clevis bracket AB6.

Materials:

Bracket: Aluminium (no surface treatment)
Swivel bearing acc. to DIN 648K
Hardened steel
Supplied complete with mounting screws for attachment to cylinder.

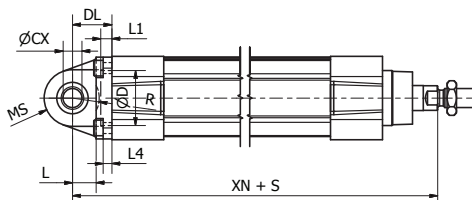
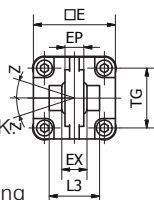

According to ISO 15552

Cyl.-bore [mm]	CX [mm]	D [mm]	DL [mm]	E [mm]	EP [mm]	EX [mm]	L [mm]	L1 [mm]	L3 [mm]	L4 [mm]	MS [mm]	R [mm]	TG [mm]	XN* [mm]	Z	Weight [kg]	Order code
Ø32	10	30	22	45	10.5	14	12	7	-	5.5	16	-	32.5	142	4°	0.09	P1C-4KMSB
Ø40	12	35	25	52	12	16	15	7	-	5.5	18	-	38	160	4°	0.13	P1C-4LMSB
Ø50	16	40	27	65	15	21	15	7	51	6.5	21	19	46.5	170	4°	0.24	P1C-4MMSB
Ø63	16	45	32	75	15	21	20	7	-	6.5	23	-	56.5	190	4°	0.29	P1C-4NMSB
Ø80	20	45	36	95	18	25	20	9	74	10	28	24	72	210	4°	0.59	P1C-4PMSB
Ø100	20	55	41	115	18	25	25	9	140	10	30	32	89	230	4°	0.78	P1C-4QMSB
Ø125	30	60	50	140	25	37	30	9	-	10	40	-	110	275	4°	1.38	P1C-4RMSB

*Does not apply to cylinders with piston rod extension, lock units and Twin Rods, see page 38.

PDE3570TCEN Pneumatic Cylinders ISO 15552

Intermediate Trunnion - MT4

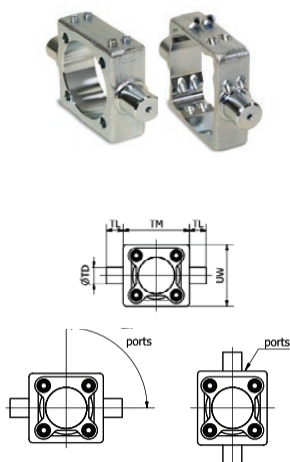

Available for P1F Profile and Tie-Rods versions the MT4 centre trunnion when combined with AT4 pivot brackets is intended for articulated mounting of the cylinder. The trunnion is free so that it can be fixed afterward when the cylinder is at the right place on the machine.

Material: Zinc plated steel

Refer to the model code page 16 for ordering cylinder with trunnion.

Important note: the rear end cylinder cover needs to be removed for adding the trunnion when ordered as a single kit.

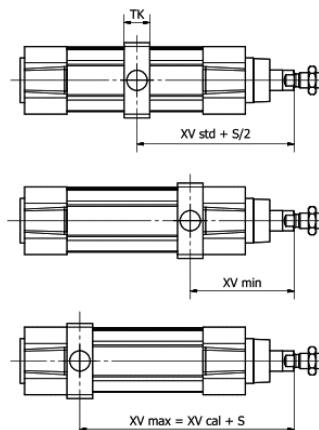

According to ISO 15552					P1F-S/K				P1F-T/N				P1F-L	P1F-H	T1	Order Code	
Cyl. bore	TL _{h14}	TM _{h14}	ØTD _{e9}	XV [*] _{std}	TK	UW	XV [*] _{min}	XV [*] _{cal}	TK	UW	XV [*] _{min}	XV [*] _{cal}	Adder to XV		max.	Smooth Profile	Tie-Rods
[mm]	[mm]	[mm]	[mm]	[mm]	[mm]	[mm]	[mm]	[mm]	[mm]	[mm]	[mm]	[mm]	[mm]	[mm]			
Ø32	12	50	12	73	18	52	65	81	15	46	63	83	32	48	1,5	P1F-4KMY	P1F-4KMYT
Ø40	16	63	16	83	20	60	74	91	20	59	74	91	30	55	3	P1F-4LMY	P1F-4LMYT
Ø50	16	75	16	90	20	71	82	98	20	69	82	98	29	70		P1F-4MMY	P1F-4MMYT
Ø63	20	90	20	98	26	84	91	104	25	84	90	105	39	70		P1F-4NMY	P1F-4NMYT
Ø80	20	110	20	110	26	105	100	120	25	102	99	121	45	90	8	P1F-4PMY	P1F-4PMYT
Ø100	25	132	25	120	32	129	113	127	30	125	112	128	57	92		P1F-4QMY	P1F-4QMYT
Ø125	25	160	25	145	33	154	134	156	33	155	134	156	56	122	P1F-4RMY	P1F-4RMYT	

* Does not apply to cylinders with piston rod extension, lock units and Twin Rods.
Add to XV_{std}, XV_{min}, XV_{cal} the „adder to XV“.

Twin Rods Cylinders

According to ISO 15552					P1F-R/Q				Order Code
Cyl. bore	TL _{h14}	TM _{h14}	ØTD _{e9}	XV [*] _{std}	TK	UW	XV [*] _{min}	XV [*] _{cal}	Smooth Profile
[mm]	[mm]	[mm]	[mm]	[mm]	[mm]	[mm]	[mm]	[mm]	
Ø32	12	50	12	73	18	52	62	81	P1F-4KMY
Ø40	16	63	16	83	20	60	71	97	P1F-4LMY
Ø50	16	75	16	87	20	71	79	100	P1F-4MMY
Ø63	20	90	20	97	26	84	84	113	P1F-4NMY
Ø80	20	110	20	102	26	105	91	118	P1F-4PMY
Ø100	25	132	25	107	32	129	95	124	P1F-4QMY

* Does not apply to cylinders with piston rod extension.

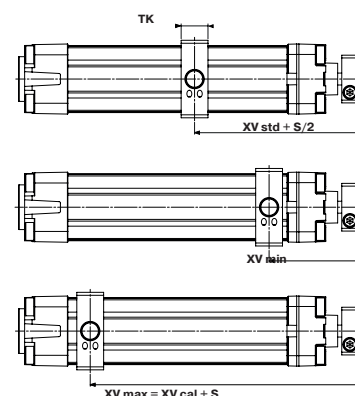

PDE3570TCEN Pneumatic Cylinders ISO 15552

Flange Trunnion - MT5 / MT6**



Intended for articulated mounting of cylinder. This trunnion can be flange mounted on the front or rear end cover of the cylinder.

Materials:

Trunnion: Zinc-plated steel
Screws: Zinc-plated steel 8.8
Delivered complete with mounting screws for attachment to the cylinder.

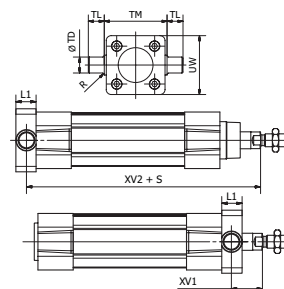

According to ISO 15552

Cyl.-bore	L1	R	TD _(e9)	TL _(h14)	TM _(h14)	UW	XV1*	XV2*	Weight	Order code
[mm]	[mm]	[mm]	[mm]	[mm]	[mm]	[mm]	[mm]	[mm]	[kg]	
Ø32	14	1.0	12	12	50	46	19.5	127.0	0.14	P1D-4KMYF
Ø40	19	1.6	16	16	63	59	21.0	144.5	0.39	P1D-4LMYF
Ø50	19	1.6	16	16	75	69	28.0	152.5	0.51	P1D-4MMYF
Ø63	24	1.6	20	20	90	84	25.5	170.0	1.04	P1D-4NMYF
Ø80	24	1.6	20	20	110	102	34.5	186.0	1.57	P1D-4PMYF
Ø100	29	2.0	25	25	132	125	37.0	203.5	3.00	P1D-4QMYF

*Does not apply to cylinders with piston rod extension, lock units and Twin Rods.

To fit a flange mounted trunnion at the front end cover of a cylinder with lock unit, the piston rod must be extended by L1 length. This is in order to provide the same WH dimensions as for the P1F base cylinder.

**only on rear end cap for Twin Rods cylinders.

Pivot Brackets for MT Trunnion - AT4



Intended for use together with trunnion MT4.

Materials:

Pivot bracket: Surface-treated aluminium
Bush: Bronze
Supplied in pairs

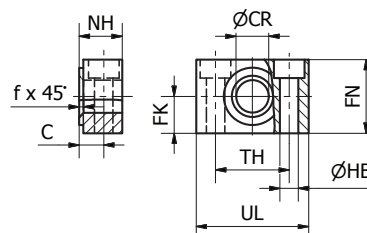

According to ISO 15552

Cyl.-bore	UL	NH	TH	C	CR	HB	FN	FK	fx45°	Weight	Order code
[mm]	[mm]	[mm]	[mm]	[mm]	[mm]	[mm]	[mm]	[mm]	[mm]	[kg]	
Ø32	46	18	32	10.5	12	6.6	30	15	1.0	0.08	9301054261
Ø40	55	21	36	12.0	16	9	36	18	1.6	0.14	9301054262
Ø50	55	21	36	12.0	16	9	36	18	1.6	0.14	9301054262
Ø63	65	23	42	13.0	20	11	40	20	1.6	0.21	9301054264
Ø80	65	23	42	13.0	20	11	40	20	1.6	0.21	9301054264
Ø100	75	28.5	50	16.0	25	14	50	25	2.0	0.36	9301054266
Ø125	75	28.5	50	16.0	25	14	50	25	2.0	0.36	9301054266

PDE3570TCEN Pneumatic Cylinders ISO 15552

3 and 4 Position Flange - JP1



Mounting kit for back to back mounted cylinders, 3 and 4 position cylinders.

Materials:
Mounting: Aluminium
(no surface treatment)
Mounting screws: Zinc-plated steel 8.8

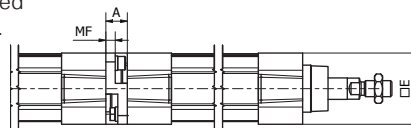

Cyl.-bore	A	ØBA	E	ØFB	MF	Weight	Order code
[mm]	[mm]	[mm]	[mm]	[mm]	[mm]	[kg]	
Ø32	16	30	47	6.5	7	0.04	P1E-6KB0
Ø40	16	35.5	53	6.5	7	0.07	P1E-6LB0
Ø50	20	40.5	64.5	8.5	6	0.08	P1E-6MB0
Ø63	20	45.5	75	8.5	6	0.16	P1E-6NB0
Ø80	25	45.5	94	10.5	8	0.30	P1E-6PB0
Ø100	25	55.5	111	10.5	8	0.54	P1E-6QB0

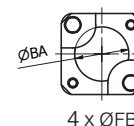

Flexo Coupling - PM5



Flexo coupling for articulated mounting of piston rod. Flexo fitting is intended to take up axial angle errors within a range of $\pm 4^\circ$.

Materials:
Flexo coupling, nut: Zinc-plated steel
Supplied complete with galvanized adjustment nut.

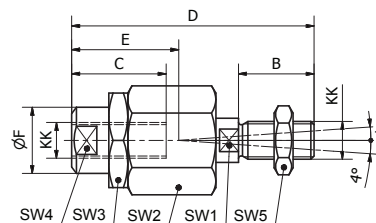

Cyl. bore	KK	B	C	D	E	ØF	SW1	SW2	SW3	SW4	SW5	Weight	Order code
[mm]		[mm]	[mm]	[mm]	[mm]	[mm]	[mm]	[mm]	[mm]	[mm]	[mm]	[kg]	
Ø32	M10x1.25	20	23	70	31	21	12	30	30	19	17	0.23	P1C-4KRF
Ø40	M12x1.25	24	30	77	31	21	12	30	30	19	19	0.23	P1C-4LRF
Ø50	M16x1.5	32	32	108	45	33.5	19	41	41	30	24	0.65	P1C-4MRF
Ø63	M16x1.5	32	32	108	45	33.5	19	41	41	30	24	0.65	P1C-4MRF
Ø80	M20x1.5	40	42	122	56	33.5	19	41	41	30	30	0.71	P1C-4PRF
Ø100	M20x1.5	40	42	122	56	33.5	19	41	41	30	30	0.71	P1C-4PRF
Ø125	M27x2	54	48	147	51	39	24	55	55	32	41	1.60	P1C-4RRF

Piston Rod Nuts - MR9

P1F cylinders are delivered with a zinc plated steel piston rod nut, in stainless steel for options V & D only.

According to DIN 439 B

Cyl.-bore	A	B	C	Weight	Order code	
					Zinc plated steel	Stainless steel
[mm]	[mm]	[mm]	[mm]	[kg]		
Ø32	17	5.0	M10 x 1.25	0.007	P14-4KRPZ	P14-4KRPS
Ø40	19	6.0	M12 x 1.25	0.010	P14-4LRPZ	P14-4LRPS
Ø50	24	8.0	M16 x 1.5	0.021	P14-4MRPZ	P14-4MRPS
Ø63	24	8.0	M16 x 1.5	0.021	P14-4MRPZ	P14-4MRPS
Ø80	30	10.0	M20 x 1.5	0.040	P14-4PRPZ	P14-4PRPS
Ø100	30	10.0	M20 x 1.5	0.040	P14-4PRPZ	P14-4PRPS
Ø125	41	13.5	M27 x 2.0	0.100	P14-4RRPZ	P14-4RRPS

*Weight per item

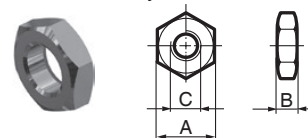

Material: Zinc-plated steel

Material: Stainless steel A2

PDE3570TCEN Pneumatic Cylinders ISO 15552

Swivel Rod Eye - AP6



Swivel rod eye for articulated mounting of the cylinder. Swivel rod eye can be combined with clevis bracket AB6.

Materials:

Swivel rod eye: Zinc-plated steel
Swivel bearing according to DIN 648K: hardened steel

Swivel rod eye: Stainless steel
Swivel bearing according to DIN 648K: Hardened steel

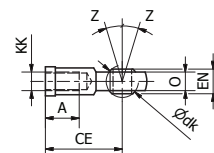
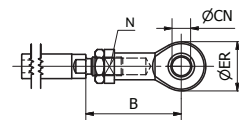

According to DIN ISO 8139

Cyl.-bore	A	B _{min}	B _{max}	CE	CN	EN	ER	KK	LE dk	N	O	Z	Weight	Order Code	
														Galvanised steel	Stainless steel
[mm]	[mm]	[mm]	[mm]	[mm]	[mm]	[mm]	[mm]			[mm]	[mm]				
Ø32	15	48.0	55	43	10	14	29	M10x1.25	19.0	17	10.5	13°	0.07	P1C-4KRS	P1S-4JRT
Ø40	18	56.0	62	50	12	16	33	M12x1.25	22.2	19	12.0	13°	0.11	P1C-4LRS	P1S-4LRT
Ø50	24	72.0	80	64	16	21	43	M16x1.5	28.5	22	15.0	15°	0.21	P1C-4MRS	P1S-4MRT
Ø63	24	72.0	80	64	16	21	43	M16x1.5	28.5	22	15.0	15°	0.21	P1C-4MRS	P1S-4MRT
Ø80	30	87.0	97	77	20	25	51	M20x1.5	34.9	30	18.0	15°	0.38	P1C-4PRS	P1S-4PRT
Ø100	30	87.0	97	77	20	25	51	M20x1.5	34.9	30	18.0	15°	0.38	P1C-4PRS	P1S-4PRT
Ø125	45	123.5	137	110	30	37	70	M27x2	50.8	41	25.0	15°	1.15	P1C-4RRS	P1S-4RRT

Clevis - AP2

Galvanised Steel



Stainless Steel



Clevis for articulated mounting of the cylinder.

Materials:

Clevis, clip: Zinc-plated steel
Pin: Hardened steel

Clevis, clip: Stainless steel
Pin: Stainless steel

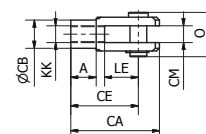
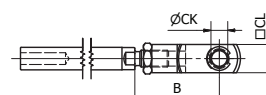

According to DIN ISO 8140

Cyl.-bore	A	B _{min}	B _{max}	CA	CB	CE	CK	CL	CM	KK	LE	O	Weight	Order code	
														Galvanised steel	Stainless steel
[mm]	[mm]	[mm]	[mm]	[mm]	[mm]	[mm]	[mm]	[mm]	[mm]		[mm]	[mm]	[kg]		
Ø32	15	45	52	52	18	40	10	20	10	M10x1.25	20	25	0.09	P1C-4KRC	P1S-4JRD
Ø40	18	54	60	62	20	48	12	24	12	M12x1.25	24	31	0.15	P1C-4LRC	P1S-4LRD
Ø50	24	72	80	83	26	64	16	32	16	M16x1.5	32	40	0.34	P1C-4MRC	P1S-4MRD
Ø63	24	72	80	83	26	64	16	32	16	M16x1.5	32	40	0.34	P1C-4MRC	P1S-4MRD
Ø80	30	90	100	105	34	80	20	40	20	M20x1.5	40	50	0.67	P1C-4PRC	P1S-4PRD
Ø100	30	90	100	105	34	80	20	40	20	M20x1.5	40	50	0.67	P1C-4PRC	P1S-4PRD
Ø125	40	123.5	137	148	48	110	30	55	30	M27x2.0	54	65	1.80	P1C-4RRC	P1S-4RRD

PDE3570TCEN Pneumatic Cylinders ISO 15552

For some versions of P1F cylinders mounting dimensions previously shown and marked * require adjustment. P1F cylinders with rod locks have extended piston rods so some mounting dimensions will differ from those for standard product. For rod lock versions then an additional length shown in the tables below should be added.

Adder to the dimension for P1F-L with rod lock

Cyl.-bore [mm]	MF1/MF2		MS1		MP6	MP2	MP4	AB6	MT5/MT6	
	ZB	ZF	SA	XA	XN	XD	XD	XD	XV1	XV2
Ø32						+27 [mm]				
Ø40						+22 [mm]				
Ø50						+20 [mm]				
Ø63						+28 [mm]				
Ø80						+37 [mm]				
Ø100						+50 [mm]				
Ø125						+44 [mm]				

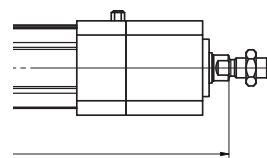

Adder is referring to the piston rod flat

Adder to the dimension for P1F-H with rod lock

Cyl.-bore [mm]	MF1/MF2		MS1		MP6	MP2	MP4	AB6	MT5/MT6	
	ZB	ZF	SA	XA	XN	XD	XD	XD	XV1	XV2
Ø32						+48 [mm]				
Ø40						+55 [mm]				
Ø50						+70 [mm]				
Ø63						+70 [mm]				
Ø80						+90 [mm]				
Ø100						+92 [mm]				
Ø125						+122 [mm]				

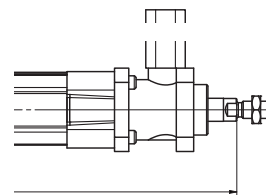

Adder is referring to the piston rod flat

For P1F cylinders with a piston rod extension then an addition length equal to the piston rod extension should be added.

P1F cylinders with twin rods also have some mounting dimensions that differ from those for standard product. For these versions on bores 50 – 100 mm then the length shown in the table below should be subtracted.

Adder to the dimension for P1F-R with twin-rods

Cyl.-bore [mm]	MF1/MF2		MS1		MP6	MP2	MP4	AB6	MT5/ MT6	
	ZB	ZF	SA	XA	XN	XD	XD	XD	XV1	XV2
Ø32						+8 [mm]				
Ø40						+7 [mm]				
Ø50						+8 [mm]				
Ø63						+3 [mm]				
Ø80						0 [mm]				
Ø100						-8 [mm]				

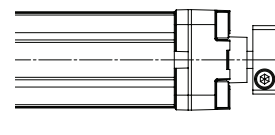

Adder is referring to the front face of the flange

PDE3570TCEN Pneumatic Cylinders ISO 15552

Cylinder Valve Mounting Kit

These aluminium extruded plates with multiple mounting holes facilitate the association of Viking Xtreme P2L X and Viking Lite P2L Z valve series directly onto P1F ISO 15552 smooth profile cylinders. With two versions available for bores Ø32-Ø100mm and Ø125mm they allow the combining of the actuator and its control valve into a compact space saving unit. The large flow capacity of the valve and the short distance between the valve and the cylinder ports mean that the working unit operates quickly (short actuation time and with minimal flow restriction).

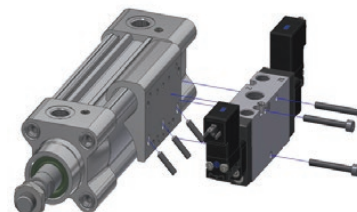

Materials:

The kit includes set screws for fixing the mounting plate onto the cylinder body and socket head screws for fixing the valve onto the mounting plate.

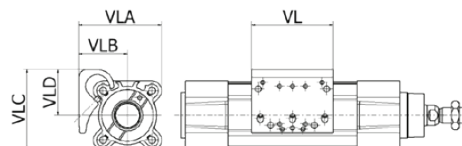

Cyl-bore [mm]	VL [mm]	VLA [mm]	VLB [mm]	VLC [mm]	VLD [mm]	Order Code
Ø32	63	58,2	34,7	55,8	32,3	P1F-4KMNB
Ø40	63	64	37,5	62	35,5	P1F-4KMNB
Ø50	63	73	40,8	71,8	39,6	P1F-4KMNB
Ø63	63	82,5	45	82,1	44,6	P1F-4KMNB
Ø80	63	98,1	51,1	98,3	51,3	P1F-4KMNB
Ø100	63	113,9	58,4	113,8	58,3	P1F-4KMNB
Ø125	63	139,6	71,6	144,1	76,1	P1F-4RMNB

Note: To avoid interference between the valve solenoids and the cylinder port fittings it is advised that the valve mounting plate should be fixed onto either the left or right hand side of the cylinder body.

Technical Data for Intended Valves (Not included within the kit)

	Viking Xtreme P2L X series	Viking Lite P2L Z series
Working pressure	Max 10 bar (cylinder restriction)	
Working media	Dry filtered compressed air	
Working temperature	-15°C to +60°C	-10°C to +50°C
Nominal Flow (according to ISO 6358)	G1/8 Qn = 11 l/s G1/4 Qn = 21.5 l/s G3/8 Qn = 41 l/s G1/2 Qn = 44.3 l/s	G1/8 Qn = 10,1 l/s G1/4 Qn = 24.6 l/s G3/8 Qn = 41,5 l/s

Note: For more details on valve specifications and part numbers, please refer to www.parker.com.

Accessories (Not included within the kit)

Description	Flow Control Silencer (Order Code)	Sintered Plastic Silencer (Order Code)	Elbow Fitting	Tube
G1/8 valve	0672 00 10	0674 00 10	Please consult your local distributor	
G1/4 valve	0672 00 13	0674 00 13		
G3/8 valve	0672 00 17	0674 00 17		
G1/2 valve	0672 00 21	0674 00 21		

PDE3570TCEN Pneumatic Cylinders ISO 15552

P8S Electronic and Reed Sensors

The P8S Series magnetic cylinder sensor enables quick, precise and contactless sensing of the piston's position in cylinders. It is easy to mount, can be used in numerous applications and offers an outstanding price-performance ratio.



Product Overview

As the term magnetic switch suggests, these are operated by magnetic fields; another description widely used is magnetic „SENSOR“. As our eyes sense change of light, our ears sense the change of sound, magnetic sensors / switches sense the change of magnetic flux in pneumatic and hydraulic cylinders. When magnetic sensors sense a magnetic field it will give a switching signal, through a control circuit, allowing sensing or control operation to be achieved.

Because of the characteristics of magnetic sensors they can sense a change of magnetic field relative to the position of the magnet, such as in a pneumatic or hydraulic cylinder, whereby the magnet is attached to a moving piston and thus the position of the moving part (ie Piston) can be detected.

The magnet is mounted on the piston of the cylinder and thus moves with the piston.

The magnetic sensor (switch) is fixed either directly to the cylinder or with an additional mounting bracket. When the piston (magnet) moves to the position under a magnetic sensor, the switch will operate due to the change of the magnetic field and give a switching signal.

Thus the position of the piston can be identified and a resulting signal generated to continue the sequence of a circuit.

Magnetic sensors available can be classified into two different groups, they are sensors with contacts which are called mechanically operated or reed sensors and the other type is sensors without contacts and are called solid state type or electronic.

Parker P8S Series sensors are suitable for use with a large range of Sensors. They can either be inserted directly into the cylinder tube extrusion or mounted using additional

brackets. For direct mounting the sensor is positioned within the cylinder sensor groove, offering mechanical protection, then securely clamped into position by a simple turn of a screw. For other cylinder versions there are a number of optional sensors brackets that clamp to the cylinder and offer other mounting positions. To easy installation there

are several cable lengths available with either M8 connector or flying lead. The electronic sensors are "Solid State", i.e. they have no moving parts. They are provided with short-circuit protection and transient protection as standard. The built-in electronics make the sensors suitable for applications with high on and off switching frequency where long service life is required.

Please note that for low temperature applications sensors are normally specified for full performance down to -30°C only. High temperature cylinders do not have a magnetic piston and therefore cannot be used with sensors.

PDE3570TCEN

Pneumatic Cylinders ISO 15552

Technical Data

Square body design, insert straight in T-slot, screw 1/4 turn

	Electronic PNP NPN	Electric Reed
Cylinder type:	Profile with T-slot	
Cylinder type with adaptor:	Profile with S-slot (dovetail) Tie rods Round cylinders	
Installation:	Quarter turn, fixed by allen key 2.5 mm or flathead screwdriver	
Housing length:	29.5 mm 10 - 30 V DC	29.5 mm 5 - 30 V AC/DC
	24 mm NAMUR	29.5 mm 5 - 120 V AC/DC
	29.5 mm ATEX	32.5 mm 5 - 230 V AC/DC
Output Type:	PNP NPN	Reed
Switching (on/off) switching frequency:	± 1,000 Hz	± 400 Hz
Output Function:	Normally Open (NO) Normally Closed (NC) 3-wire	Normally Open (NO) Normally Closed (NC) 2-wire Normally Open (NO) 3-wire
Enclosure rating:	IP67	
Supply Voltage:	10 to 30 V DC	
	8.2 to 20 V DC (NAMUR 1GD) 10 to 26 V DC (ATEX 3GD)	5 to 30 5 to 120 5 to 230 V AC/DC 2-wire, 3-wire depending on type
Power consumption:	<= 8 mA	
	<= 10 mA (NAMUR, ATEX)	
Voltage drop:	<= 2 V	
	<= 2.2 V (NAMUR, ATEX)	<= 3.5 V 2-wire <= 0.1 V 3-wire
Continuous output current I_a:	<= 100 mA	
	<= 60 mA (NAMUR) <= 50 mA (ATEX)	<= 500 mA (DC) <= 300 mA (AC)
Switching capacity:	-	<= 6 W
Protection class:	III	
		III II 2-wire depending on type III 3-wire
Response sensitivity:	2.6 to 3.3 mT	
	2.8 mT (NAMUR, ATEX)	2.1 to 3.4 mT
Overrun distance:	10 mm	
	9 mm (NAMUR, ATEX)	-
Hysteresis:	<= 0.8 mT	
	<= 0.5 mT (NAMUR, ATEX)	-
Repeatability:	<= 0.1 mT	
Reverse polarity protection:	Yes	
	-	No 2-wire Yes 3-wire
Short circuit protection:	Yes	
Power-up pulse protection:	Yes (NAMUR, ATEX)	
Ambient operating temperature range:	-30 to +80 °C (PUR cable) -30 to +70°C (PVC cable)	
	-25 to +80 °C (NAMUR 1GD) -20 to +50°C (ATEX 3GD)	
Shock and vibration resistance:	30 g 11 ms / 10 ... 55 Hz, 1 mm	
EMC:	According to EN 60947-5-2	
International standard:	CE C UL US RoHs Ex IEC IEC Ex	
Housing material:	Plastic polyamid PA12	
Screw material:	Stainless steel	
Cable material:	PUR (Polyurethane) PVC (Polyvinyl Chloride)	
Conductor cross-section:	0.14 mm ² 0,12 mm ² depending on type	
	0.14 mm ² (NAMUR, ATEX)	
Indication LED colour:	Yellow, no LED reed NC	
Connector:	M8R (knurled nuts) None (Flying lead)	

PDE3570TCEN Pneumatic Cylinders ISO 15552

Dimensions in mm (inch)

PNP, NPN Output 10 to 30 V DC

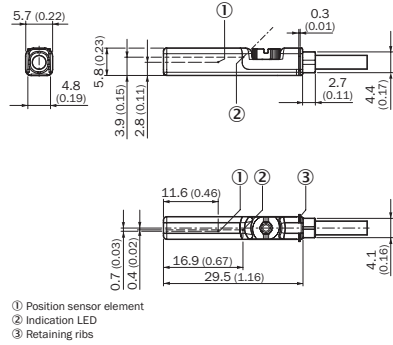

Reed Output 5 to 230 V AC/DC

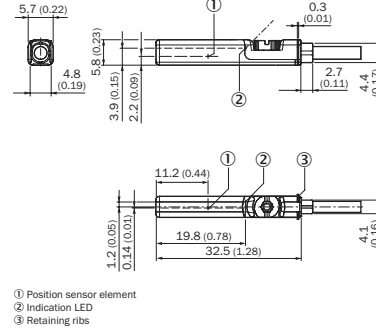

Reed Output 5 to 30 V AC/DC

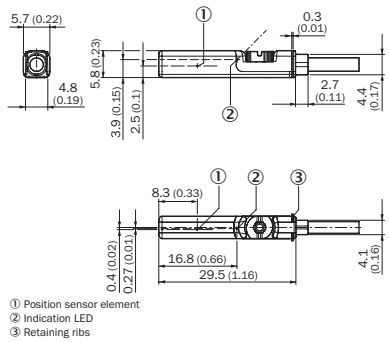

Reed Output 5 to 120 V AC/DC

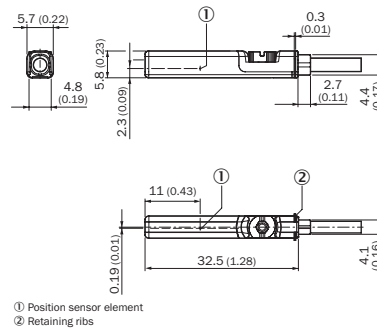

NAMUR 1G, 1D

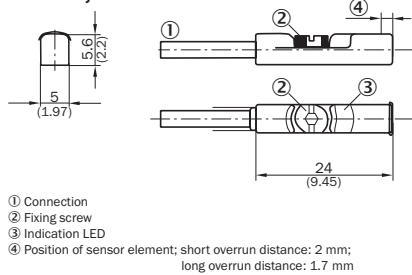

Connector M8R

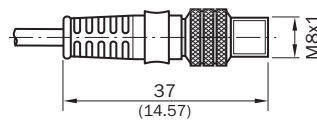

Without Adaptor directly in T-Slot

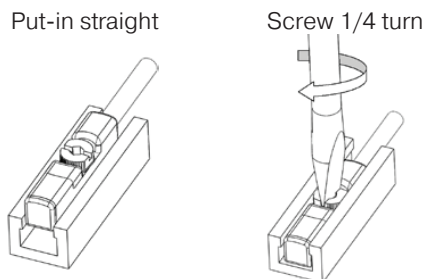

PDE3570TCEN
Pneumatic Cylinders ISO 15552

Connection type and diagram

PNP NO



PNP NC

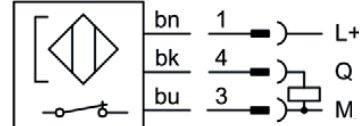

NPN NO

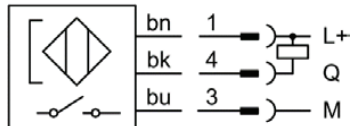

NPN NC

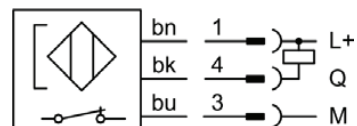

Reed NO 3-wire

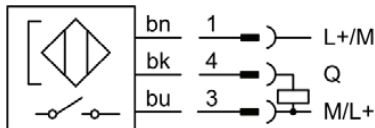

bn: brown
 bk: black
 bu: blue
 Q: load
 M: Mass
 L+: Power

Reed NO 2-wire

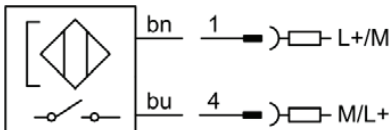

Reed NC 2-wire

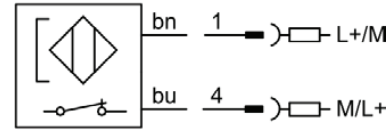

NAMUR NO ATEX 1G, 1D

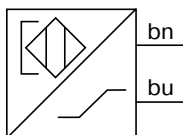

PNP NO ATEX 3G, 3D

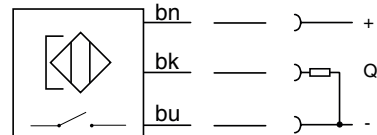

Pin assignment, M8 with knurled nut

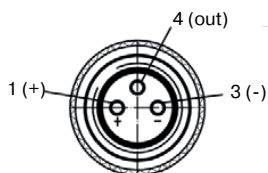

Flying leads

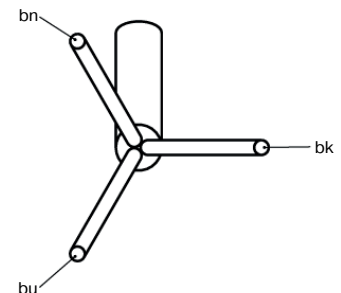

PDE3570TCEN Pneumatic Cylinders ISO 15552

Ordering Data

Square body design, Insert straight in T-slot, screw 1/4 turn

Output, Function, Cable & Supply Voltage	Order Code	Weight [g]	For Product Series
With flying leads, PUR cable IP67			
Electronic PNP-NC, with LED, 3-wire, 3 metre, 10-30 V DC	P8SAGQFAX	35	All Series
Electronic PNP-NC, with LED, 3-wire, 10 metre, 10-30 V DC	P8SAGQFDX	105	All Series
Electronic PNP-NO, with LED, 3-wire, 3 metre, 10-30 V DC	P8SAGPFAX	35	All Series
Electronic PNP-NO, with LED, 3-wire, 10 metre, 10-30 V DC	P8SAGPFDX	105	All Series
Electronic NPN-NC, with LED, 3-wire, 3 metre, 10-30 V DC	P8SAGMFAX	35	All Series
Electronic NPN-NC, with LED, 3-wire, 10 metre, 10-30 V DC	P8SAGMFDX	105	All Series
Electronic NPN-NO, with LED, 3-wire, 3 metre, 10-30 V DC	P8SAGNFAX	35	All Series
Electronic NPN-NO, with LED, 3-wire, 10 metre, 10-30 V DC	P8SAGNFDX	105	All Series
Electric Reed-NO, with LED, 3-wire, 3 metre, 5-30 V AC/DC	P8SAGSFAX	35	All Series
Electric Reed-NO, with LED, 3-wire, 10 metre, 5-30 V AC/DC	P8SAGSFDX	105	All Series
Electric Reed-NO, with LED, 2-wire, 3 metre, 5-30 V AC/DC	P8SAGRFAAX	35	All Series
Electric Reed-NO, with LED, 2-wire, 10 metre, 5-230 V AC/DC	P8SAGRFDX2	105	All Series
Electric Reed-NC, No LED, 2-wire, 10 metre, 5-120 V AC/DC	P8SAGEFRX1	105	All Series
Electric Reed-NC, No LED, 2 wire, 10 metre, 5-30V AC/DC	P8SSAGEFRX	105	All Series
With flying leads, PVC cable IP67			
Electric Reed-NO, with LED, 3-wire, 3 metre, 5-30 V AC/DC	P8SAGSFLX	35	All Series
Electric Reed-NO, with LED, 2-wire, 3 metre, 5-120 V AC/DC	P8SAGRFLX1	35	All Series
Electric Reed-NO, with LED, 2-wire, 3 metre, 5-230 V AC/DC	P8SAGRFLX2	35	All Series
Electronic PNP-NC, with LED, 3-wire, 3 metre, 10-30 V DC	P8SAGQFLX	35	All Series
Electronic PNP-NO, with LED, 3-wire, 3 metre, 10-30 V DC	P8SAGPFLX	35	All Series
Electronic PNP-NO, with LED, 3-wire, 10 metre, 10-30 V DC	P8SAGPFTX	105	All Series
Electric Reed-NO, with LED, 2-wire, 10 metre, 5-120 V AC/DC	P8SAGRFTX1	105	All Series
Electric Reed-NO, with LED, 3-wire, 10 metre, 10-30 V AC/DC	P8SAGSFTX	105	All Series
With M8 knurled screw, PUR cable IP67			
Electronic PNP-NC, with LED, 3-wire, 0,3 metre, 10-30 V DC	P8SAGQCHX	15	All Series
Electronic PNP-NO, with LED, 3-wire, 0,3 metre, 10-30 V DC	P8SAGPCHX	15	All Series
Electronic NPN-NC, with LED, 3-wire, 0,3 metre, 10-30 V DC	P8SAGMCHX	15	All Series
Electronic NPN-NO, with LED, 3-wire, 0,3 metre, 10-30 V DC	P8SAGNCHX	15	All Series
Electric Reed-NO, with LED, 3-wire, 0,3 metre, 5-30 V AC/DC	P8SAGSCHX	15	All Series
Electric Reed-NC, No LED, 2-wire, 0,3 metre, 5-30 V AC/DC	P8SAGECNX	15	All Series
Electric Reed-NO, with LED, 2-wire, 0,3 metre, 5-30 V AC/DC	P8SAGRCHX	15	All Series

For ATEX IP67

Electronic PNP-NO, with LED, 3-wire, 3 metre, 10-26 V DC, PUR	P8SAGPFAXS	35	ATEX Series 3G, 3D
NAMUR-NO, with LED, 2-wire, 5 metre, 8,2-20 V DC, PVC	P8SAGDFMXW *	55	ATEX Series 1G, 1D
NAMUR-NO, with LED, 2-wire, 10 metre, 8,2-20 V DC, PVC	P8SAGDFTXW *	105	ATEX Series 1G, 1D

Note:

-30 to +80 °C (PUR cable) | -30 to +70 °C (PVC cable) | -25 to +80 °C (NAMUR 1GD) | -20 to +50 °C (ATEX 3GD)

All sensors are with an adaptor for S-dovetail Parker type OSP grooves.

* with an aluminium adaptor

PDE3570TCEN Pneumatic Cylinders ISO 15552

Brackets for sensors for Tie-Rods version

P8S-TMA07

(anodised aluminium, zinc plated screws)
Tie-Rods Cylinders Ø 32 to 100 mm

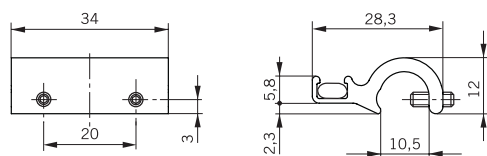

P8S-TMA08

(anodised aluminium, zinc plated screws)
Tie-Rods Cylinders Ø 125 mm

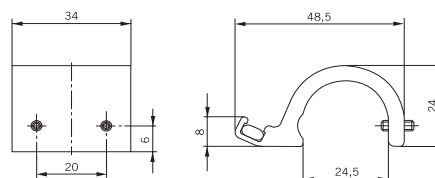

Male connectors for connecting cables

Cable connectors for producing your own connecting cables.
The connectors can be quickly attached to the cable without special tools. Only the outer sheath of the cable is removed.
The connectors are available for M8 screw connector and meet protection class IP65.

Technical Data

Operating voltage:	max. 32 V AC/DC
Operating current per contact:	max. 4 A
Connection cross section:	0.25... 0.5 mm ² (conductor diameter min 0.1 mm)
Protection class:	IP65 and IP67 when plugged and screwed down (EN 60529)
Temperature range:	- 25... + 85°C

Connector	Weight [kg]	Order Code
M8 screw connector		P8CS0803J
M12 screw connector	0.022	P8CS1204J



Cables to extend cable sensor lengths with M8*

Description	Order Code	Weight [g]	For Product Series
Cable flex PVC 3 metre with 8mm snap-in connector / flying leads	9126344341	70	P8S Sensors with M8
Cable flex PVC 10 metre with 8mm snap-in connector / flying leads	9126344342	210	P8S Sensors with M8
Cable PUR 3 metre with 8mm snap-in female connector / flying leads	9126344345	70	P8S Sensors with M8
Cable flex PUR 10 metre with 8mm snap-in connector / flying leads	9126344346	210	P8S Sensors with M8
Cable PVC 2.5 metre with M8 screw connector / flying leads	KC3102	60	P8S Sensors with knurled M8
Cable PVC 5 metre with M8 screw female connector / flying leads	KC3104	120	P8S Sensors with knurled M8

*Note: not applicable for P8S CPS Sensors as no cable available

PDE3570TCEN Pneumatic Cylinders ISO 15552

Continuous Position Sensing

Analogue signal or IO-Link communication for linear cylinders many applications require more than just end of stroke sensing of an actuator, but traditional methods of continuous sensing are expensive and difficult to implement. Parker's CPS series of the P8S sensor family enables quick, easy, precise, and contactless position sensing of a piston. This can be installed on a standard linear actuator and offers an outstanding price to performance ratio.

Product Features:

- Continuous position sensing
- IO-Link communication with M12 connector
- No modification to the actuator
- Analogue version with M8 connector
- 5 sizes with sensing ranges from 32 mm to 256 mm
- IP67 design suitable for any industrial application
- Yellow teach button for easy set-up

Technical specification:

- 1 ms sampling rate
- 0.03% full scale resolution
- 0.06% full scale repeatability
- 0.3 mm Linearity error

How it installs:

The Parker CPS requires the use of a magnetic piston. The product will fit T-slot cylinders without any additional mounting hardware.

1. Pivot the sensor into the slot
2. Teach the CPS unit the desired measuring range
3. Tighten set screws

Dimensions in mm (inch)

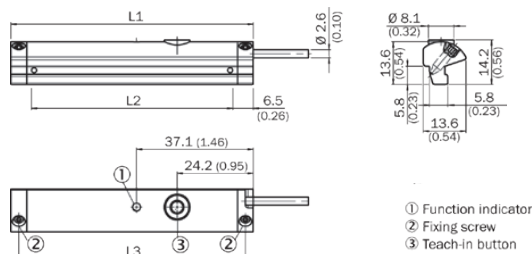

How it connects:

Analogue version has a M8 connector and a voltage output of 0-10V as well as a current output of 4-20mA. IO-Link version has a M12 connector and transmits position via 2 bytes of process input data and also allows for parameter control of measuring range and locking of the teach button.

It can be controlled by Class A or Class B IO-Link Masters.

How it works:

The CPS product detects the position of an actuator via the magnet on the piston. The sensor settings can easily be adjusted during installation using the yellow teach button or during operation over the IO-Link communication. This upgrades the functionality of the pneumatic actuator by making it more intelligent and versatile in support of the Industry 4.0 initiative.

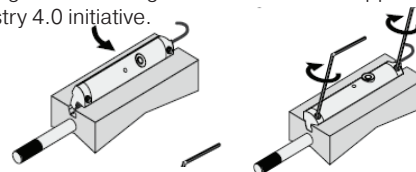

Order Code					
L1	L2 *	L3	Analogue	IO-Link	
45	32	40	P8SAGACHA	P8SAGHMHA	
77	64	72	P8SAGACHB	P8SAGHMHB	
141	128	136	P8SAGACHD	P8SAGHMHD	
205	192	200	P8SAGACHF	P8SAGHMHF	
269	256	264	P8SAGACHH	P8SAGHMHH	

*L2 equal to the measuring range

CPS Sensors

Drop in T-slot, Turn, Screw, it's done

Output	Measuring length	Configuration Option	Order Code	Weight [g]	For product series
Analogue	32 mm	Teach Button	P8SAGACHA	16	With T-slot groove *
	64 mm		P8SAGACHB	26	
	128 mm		P8SAGACHD	46	
	192 mm		P8SAGACHF	66	
	256 mm		P8SAGACHH	86	
IO-Link	32 mm	Teach Button or IO-Link parameter	P8SAGHMHA	20	With T-slot groove *
	64 mm		P8SAGHMHB	30	
	128 mm		P8SAGHMHD	50	
	192 mm		P8SAGHMHF	70	
	256 mm		P8SAGHMHH	90	

* Required magnetic field sensitivity: 3mT / -2 mT (Analogue) / 3mT (IO-Link)

Note: PUR cable with M12 (IO-Link) or M8 (Analogue) male connector knurled nut, 4-pin, 0,3 metre length. Please consult for measuring range 96, 160 & 224 mm.



PDE3570TCEN Pneumatic Cylinders ISO 15552

Pneumatic sensor for Tie-Rods Cylinders

An ideal solution where a direct pneumatic signal is wanted from a cylinder sensor to a pneumatic control system, for example. This could be a machine or device in which only compressed air is available, and an electricity supply to normal cylinder sensors would involve serious problems or considerable expense.

Function:

Non-contacting sensing of a pneumatic cylinder, triggering an output signal (conn. 2) from the integrated 3/2 NC valve, which is activated by a magnetic field or iron core and has a return spring.

If more than one sensor is used with a cylinder there must be a distance of at least 20 mm between sensors to prevent them influencing each other.

To avoid interference, there must be a minimum spacing of 15 mm to steel details.

The outlet (conn. 3) must not be blocked or restricted as this can impair the function of the sensor.

The sensor is fastened to the cylinder using the special sensor fixing.

Technical data:

Working pressure:	min 2 to max 6 bar
Temperature:	- 15 to +60 °C
Air quality:	3.4.3 to ISO 8573-1 (must be oil free)
Function:	3/2 NC valve
Flow:	40 NI per minute
Connection:	for plastic pipe with 2,5-3 mm internal diameter
Activation distance:	for magnet: min 9 mm
Activation distance:	for Fe: approx. 2 mm
Repetition accuracy:	+/- 0.2 mm
Cylinder velocity:	max 1 m/s (depends on magnetic field, interference from steel in environment, signal length requirement from control system....)

Distance between sensors: min 20 mm

Distance from sensor

to steel details: min 15 mm

Fixing: with sensor fixing or with an M4 thread in case

Sensing: non-contacting (also through a wall of non-magnetic material)

Dimensions (mm)

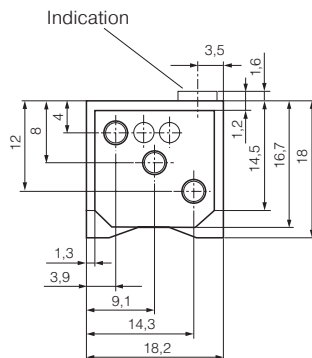

Active surface for sensing iron core

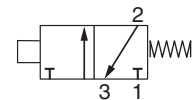
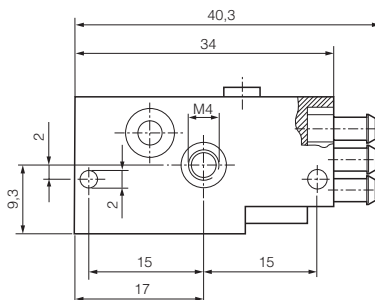
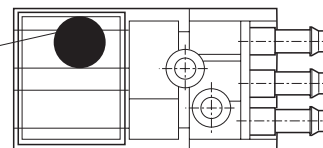

Description code	Weight [kg]	Order
Pneumatic sensor	0.02	P8S-A34X
Cylinder fixing bore Ø32 to Ø125 mm	0.01	P8S-AMA1

Cylinder fixing - Tie-Rods Cylinders Ø 32 to 100 mm

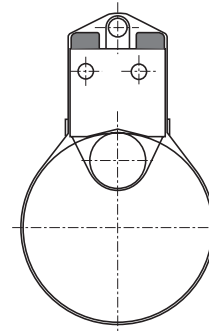

PDE3570TCEN Pneumatic Cylinders ISO 15552

Specifying air quality (purity) in accordance with ISO8573-1:2010, the international standard for compressed air quality

ISO8573-1 is the primary document used from the ISO8573 series as it is this document which specifies the amount of contamination allowed in each cubic metre of compressed air.

ISO8573-1 lists the main contaminants as Solid Particulate, Water and Oil. The purity levels for each contaminant are shown separately in tabular form, however for ease of use, this document combines all three contaminants into one easy to use table.

ISO8573-1:2010 CLASS	Solid Particulate			Mass Concentration mg/m ³	Water		Oil Total Oil (aerosol liquid and vapour) mg/m ³
	Maximum number of particles per m ³				Vapour Pressure Dewpoint	Liquid g/m ³	
	0,1 - 0,5 micron	0,5 - 1 micron	1 - 5 micron				
0	As specified by the equipment user or supplier and more stringent than Class 1						
1	≤ 20 000	≤ 400	≤ 10	-	≤ -70 °C	-	0,01
2	≤ 400 000	≤ 6 000	≤ 100	-	≤ -40 °C	-	0,1
3	-	≤ 90 000	≤ 1 000	-	≤ -20 °C	-	1
4	-	-	≤ 10 000	-	≤ +3 °C	-	5
5	-	-	≤ 100 000	-	≤ +7 °C	-	-
6	-	-	-	≤ 5	≤ +10 °C	-	-
7	-	-	-	5 - 10	-	≤ 0,5	-
8	-	-	-	-	-	0,5 - 5	-
9	-	-	-	-	-	5 - 10	-
X	-	-	-	> 10	-	> 10	> 10

Specifying air purity in accordance with ISO8573-1:2010

When specifying the purity of air required, the standard must always be referenced, followed by the purity class selected for each contaminant (a different purity class can be selected for each contamination if required).

An example of how to write an air quality specification is shown below:

ISO 8573-1:2010 Class 1.2.1

ISO 8573-1:2010 refers to the standard document and its revision, the three digits refer to the purity classifications selected for solid particulate, water and total oil. Selecting an air purity class of 1.2.1 would specify the following air quality when operating at the standard's reference conditions:

Class 1 - Particulate

In each cubic metre of compressed air, the particulate count should not exceed 20,000 particles in the 0.1 - 0.5 micron size range, 400 particles in the 0.5 - 1 micron size range and 10 particles in the 1 - 5 micron size range.

Class 2 - Water

A pressure dewpoint (PDP) of -40°C or better is required and no liquid water is allowed.

Class 1 - Oil

In each cubic metre of compressed air, not more than 0.01mg of oil is allowed. This is a total level for liquid oil, oil aerosol and oil vapour.

ISO8573-1:2010 Class zero

- **Class 0 does not mean zero contamination.**
- **Class 0 requires the user and the equipment manufacturer to agree contamination levels as part of a written specification.**
- **The agreed contamination levels for a Class 0 specification should be within the measurement capabilities of the test equipment and test methods shown in ISO8573 Pt 2 to Pt 9.**
- **The agreed Class 0 specification must be written on all documentation to be in accordance with the standard.**
- **Stating Class 0 without the agreed specification is meaningless and not in accordance with the standard.**
- **A number of compressor manufacturers claim that the delivered air from their oil-free compressors is in compliance with Class 0.**
- **If the compressor was tested in clean room conditions, the contamination detected at the outlet will be minimal. Should the same compressor now be installed in typical urban environment, the level of contamination will be dependent upon what is drawn into the compressor intake, rendering the Class 0 claim invalid.**
- **A compressor delivering air to Class 0 will still require purification equipment in both the compressor room and at the point of use for the Class 0 purity to be maintained at the application.**
- **Air for critical applications such as breathing, medical, food, etc typically only requires air quality to Class 2.2.1 or Class 2.1.1.**
- **Purification of air to meet a Class 0 specification is only cost effective if carried out at the point of use.**

www.parker.com

Your authorized distributor



European Headquarters
La Tuilière 6, 1163 Etoy,
Switzerland
Tel: +41 21 821 85 00