

H Series ISO Valve and Network Connectivity

PDE2589TCUK

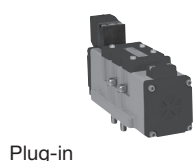

H Series ISO



Plug-in

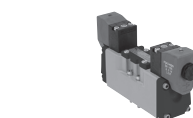

Non plug-in



- Features 3-6
- Plug-in 7-29
 - 15407-2 - Size 02, 01 (HB, HA) 8-9
 - 5599-2 - Size 1, 2 (H1, H2) 10-11
 - Ordering Information 12-23
 - 5599-2 - Size 3 (H3) 24-31
- Non Plug-in 32-53
 - 15407-1 - Size 02, 01 (HB, HA) 32-33
 - 5599-1 - Size 1, 2 (H1, H2) 34-37
 - Ordering Information 38-46
 - 5599-1 - Size 3 (H3) 47-53
- Technical Data / Accessories 54-68
- Dimensional Data 69-80

Network Connectivity



P2H Ethernet Node



PCH Network Portal



P2H IO-Link Node

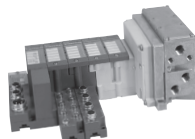

Turck Network Portal

- Features 81-89
- P2H Network Node 91-109
 - P2H IO-Link Node 24 DO 91-95
 - P2H Ethernet Node 32 DO 97-109
- PCH Network Portal 111-126
- Turck Network Portal 127-147
- Accessories / Cables 148-150

- Safety Guide & Offer of Sale 152-156

WARNING

FAILURE OR IMPROPER SELECTION OR IMPROPER USE OF THE PRODUCTS AND/OR SYSTEMS DESCRIBED HEREIN OR RELATED ITEMS CAN CAUSE DEATH, PERSONAL INJURY AND PROPERTY DAMAGE.

This document and other information from Parker Hannifin Corporation, its subsidiaries and authorized distributors provide product and/or system options for further investigation by users having technical expertise. It is important that you analyze all aspects of your application including consequences of any failure, and review the information concerning the product or system in the current product catalog. Due to the variety of operating conditions and applications for these products or systems, the user, through its own analysis and testing, is solely responsible for making the final selection of the products and systems and assuring that all performance, safety and warning requirements of the application are met.

The products described herein, including without limitation, product features, specifications, designs, availability and pricing, are subject to change by Parker Hannifin Corporation and its subsidiaries at any time without notice.

Offer of Sale

The items described in this document are hereby offered for sale by Parker Hannifin Corporation, its subsidiaries or its authorized distributors. This offer and its acceptance are governed by the provisions stated on the separate page of this document entitled "Offer of Sale". © Copyright 2019 Parker Hannifin Corporation. All Rights Reserved

H Series ISO

The H Series ISO valve conforms to international standards 15407 and 5599, providing maximum flexibility for end users. As Parker's premier manifold mount product offering, H Series ISO offers machine builders a complete offering with a wide variety of accessories and options in a valve family with flow ranges from Qn 540 NI/mn up to 5900 NI/mn.

HB/HA/H1/H2 can be mounted on the same manifold. Individual wiring is available with DIN or central connectors, and collective solutions offer installation time savings with either multi-pin connectors or network solutions.

Ports, Flow

- H Universal Manifold
 - HB: 1/8 inch, Qn 540 NI/mn
 - HA: 1/4 inch, Qn 1080 NI/mn
 - H1: 3/8 inch, Qn 1480 NI/mn
 - H2: 1/2 inch, Qn 2950 NI/mn
- H Classic Manifold (not compatible with H Universal)
 - H3: 3/4 inch, Qn 5900 NI/mn
- BSPP and NPT "G" standard

Solenoids

- HB & HA: 24 VDC, 1.0 Watt, and 120 VAC, 1.0 VA
- H1, H2, & H3: 24 VDC, 3.2 Watt, 120 VAC, 4.5 VA, 24 VDC, 1.3 Watt

Certification / approval

- IP65 rated
- cCSAus approved voltages:
 - 15407-2 & 5599-2 24VDC manifolds only
 - 15407-2 & 5599-2 single subbase, all voltages
 - 15407-1 & 5599-1 manifold and single subbase, all voltages
- BSPP manifold and subbase ports meet ISO 1179 specifications

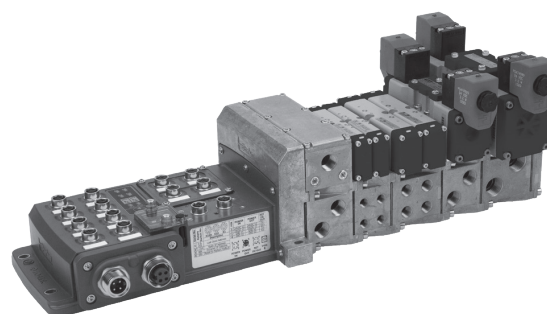

Operating information

Operating pressure:	Vacuum to 10 bar
Pilot pressure:	See chart
Temperature range:	-15°C to 49°C

Material specifications

Body	Aluminum
End caps	PBT
End plates	Aluminum
Fasteners	Zinc plated steel
Manifolds	Aluminum
Seals	Nitrile
Spool	Aluminum

Operating Pressure

Maximum: 10 bar

Minimum: see below chart



Operator / function	Internal pilot	bar HB	bar HA	bar H1	bar H2	bar H3
1	5/2 Single Solenoid	2.0	1.7	1.7	1.7	2.4
2	5/2 Double Solenoid					
3	5/2 Single Remote Pilot **	Vacuum	Vacuum	Vacuum	Vacuum	Vacuum
4	5/2 Double Remote Pilot**	Vacuum	Vacuum	Vacuum	Vacuum	Vacuum
5, 6, 7	5/3 Double Solenoid - APB, CE & PC	2.4	2.4	2.4	3.4	3.4
8, 9, 0	5/3 Double Remote Pilot - APB, CE & PC	Vacuum	Vacuum	Vacuum	Vacuum	Vacuum
E	5/2 Single Solenoid - Air & Spring Return					
F	5/2 Single Remote Pilot - Air & Spring Return	2.0	2.0	2.4	3.1	3.1
N, P, Q	Dual 3/2 Solenoid - NC/NC, NO/NO, NC/NO	2.0	N/A	N/A	N/A	N/A
	External pilot*	*	*	*	*	*
All	H Series	Vacuum	Vacuum	Vacuum	Vacuum	Vacuum

* External Pilot Pressure / Remote Pilot Supply - Must meet or exceed minimum pilot pressure for internal pilot option. Not available on Operator / Function N, P, or Q.

** Must be equal to or greater than operating pressure.



Right Sizing

-  ISO 15407-1 (Non Plug-in)
 ISO 15407-2 (Plug-in)
-  ISO 5599-1 (Non Plug-in)
 ISO 5599-2 (Plug-in)

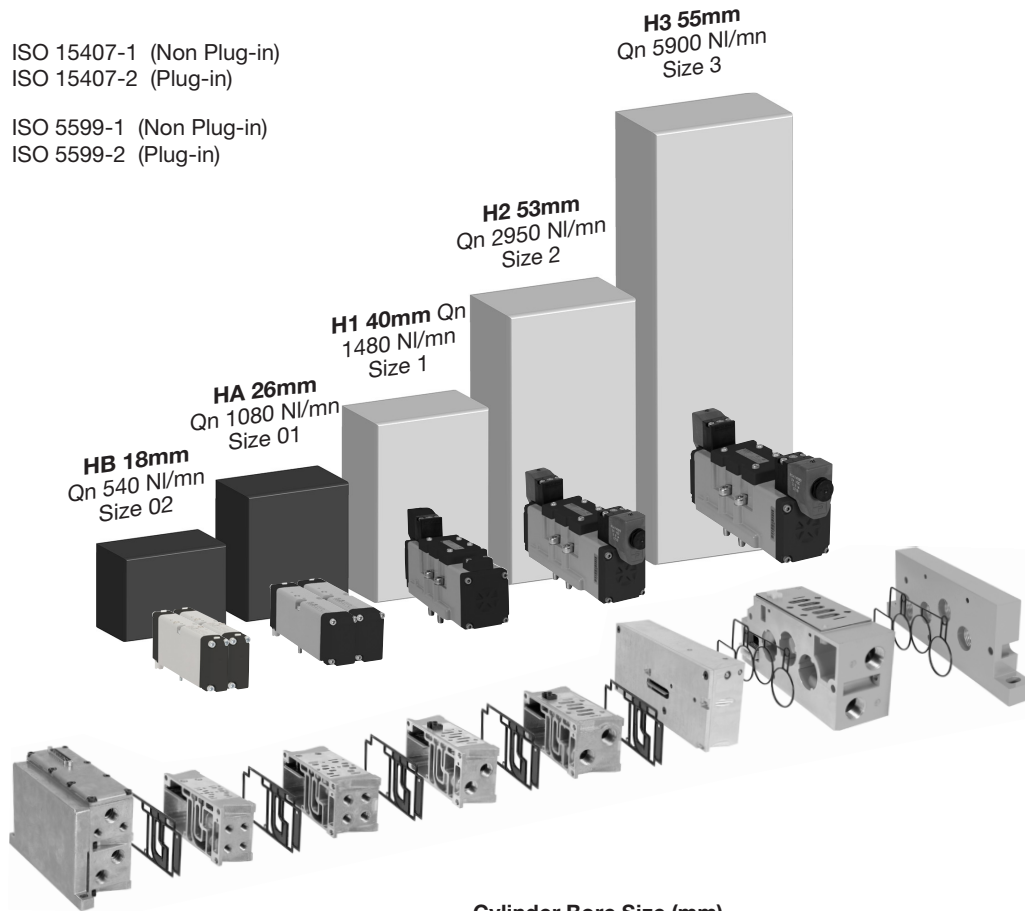

Cylinder Bore Size (mm)

	32 mm	40 mm	50 mm	63 mm	80 mm	100 mm	125 mm	150 mm
50	29	39	59	98	167	255	402	579
100	49	79	128	206	344	520	805	1168
150	79	118	196	304	510	775	1217	1747
200	98	157	255	402	677	1031	1610	2326
250	128	196	324	510	854	1296	2022	2915
300	157	245	393	609	1031	1551	2424	3494
350	177	285	451	707	1197	1816	2827	4073
400	206	324	520	805	1364	2071	3239	4662
450	236	363	579	913	1541	2326	3641	5241
500	255	402	648	1011	1708	2591	4044	5830
	HB		HA		H1	H2	H3	



Connectivity

EtherNet/IP[®] DeviceNet[®]



EtherCAT[®]

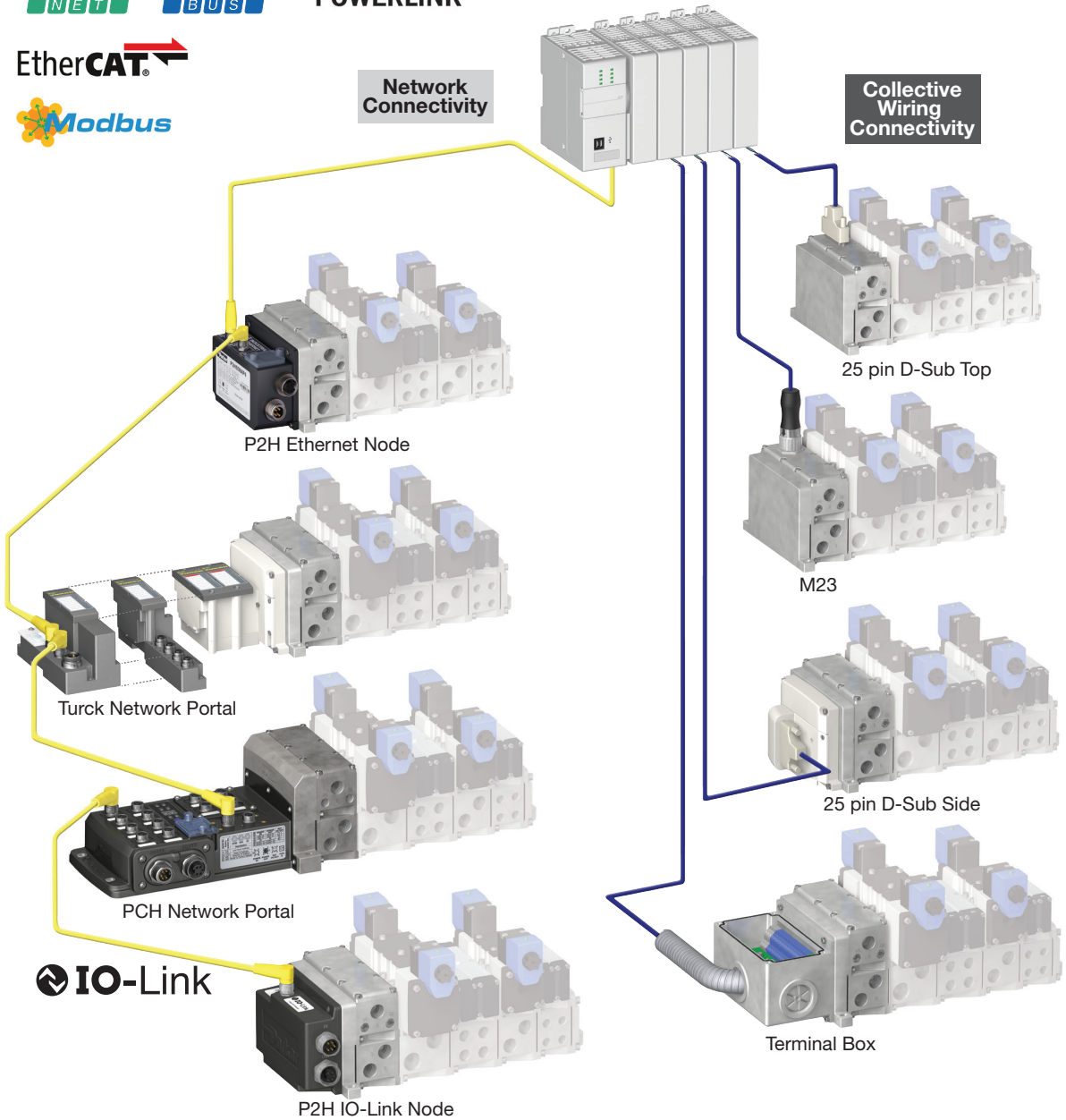

Industrial Ethernet protocol offerings differ by product line

Two easy ways to order H Universal

1 Online Configuration

Navigate to the landing page
www.parker.com/pde/HSeriesISO
 Customize your manifold assembly
 Create and save a unique assembled part number
 Generate a CAD model

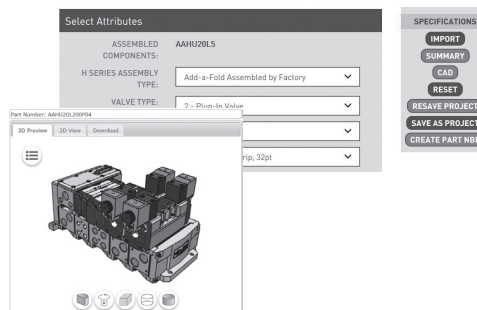

OR

2 Order Components

- A Select Endplate Kit**
Includes Left and Right Hand Endplate

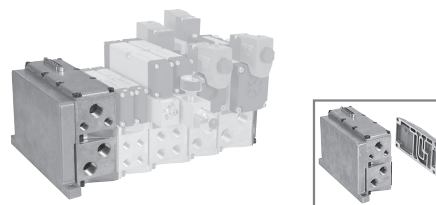

- B Select Valve Stations**
Valves (size HB, HA, H1 or H2)
Blanking Plate

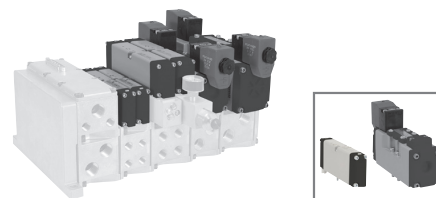



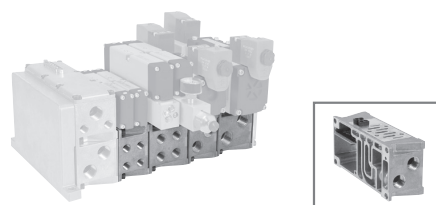



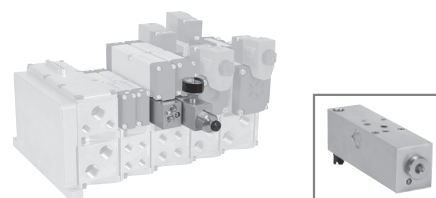



- C Select Valve Manifold Segments**
Manifold (size HB, HA, H1 or H2)
Air Supply Module

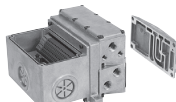

- D Select Sandwich Accessories**
Sandwich Regulators
Sandwich Flow Control
Pilot Exhaust



End Plate Kits - Universal for use with HB, HA, H1 H2

	Electrical option	BSPB port
	25-pin, D-Sub Side, 24 address	PSHU20L101P
	25-pin, D-Sub Top, 24 address	PSHU20L201P
	19-pin, round, Brad Harrison, 16 address	PSHU20L301P
	12-pin, M23, 8 address	PSHU20L401P
	19-pin, M23, 16 address	PSHU20M201P
	Terminal box, 32 address	PSHU20L501P
 Class A  Class B	P2H IO Link Class B, standard version, 24 address	PSHU20N201P
	P2H IO Link Class B, safe version, 24 address	PSHU20S201P
	P2H IO Link Class A, 4-pin safe version, 24 address	PSHU20S401P
	P2H IO Link Class A, 5-pin safe version, 24 address	PSHU20S501P
	P2H Ethernet Node, 32 addresses, EtherNet/IP™	PSHU20P201PE000A-P5
	P2H Ethernet Node, 32 addresses, EtherCAT	PSHU20P201PT000A-P5
	P2H Ethernet Node, 32 addresses, Profinet	PSHU20P201PN000A-P5
	PCH Network Portal, 32 addresses with 2 Module Variants, Profinet	PSHU20P301PNAAN0-P5
	PCH Network Portal, 32 addresses, with 3 Module Variants, EtherNet/IP™	PSHU20P301PEAAB0-P5
	Turck Network with valve driver module, 16 address	PSHU20T101P
	Turck Network with valve driver module, 32 address	PSHU20T201P

Most Popular



Valve - 15407-2, Plug-in, Size 18mm (HB)

Symbol	Type	Qn (NI/mn)	Operator	Voltage	Pilot	Non-locking
	5/2 Elec. spring return	540	Single solenoid	24 VDC	External*	HBVXLG0G9A
	5/2 Elec. air return	540	Single solenoid	24 VDC	External*	HB1VXLG0G9A
	5/2 dual Elec.	540	Double solenoid	24 VDC	External*	HB2VXLG0G9A
	5/3 dual Elec., all ports blocked	0490	Double solenoid	24 VDC	External*	HB5VXLG0G9A
	5/3 dual Elec., center exhaust	490	Double solenoid	24 VDC	External*	HB6VXLG0G9A
	5/3 dual Elec., pressure center	490	Double solenoid	24 VDC	External*	HB7VXLG0G9A
	Dual 3/2 Elec. NC/NC	440	Double solenoid	24 VDC	Internal	HBNVXBG0G9A
	Dual 3/2 Elec. NO/NO	440	Double solenoid	24 VDC	Internal	HBPVXBG0G9A

* Internal/External defined from the H Universal Supply module (see page 55)

Manifold Base - 2-Station, 15407-2, Plug-in, Size 18mm (HB)

End ported bases	Enclosure	Solenoid addresses	1/8" BSPP
	Circuit board	Single solenoid - 2 address	PSHU1152J1P
	Circuit board	Double solenoid - 4 addresses	PSHU1152M1P

Accessories - 15407-2, Plug-in, Size 18mm (HB)

Accessories	Description	Part number	
	Gauge adapter kit Includes 1/8" coupling, long nipple, and gauge	PS5651160P	
	Blanking plate kit	PS5634P	
	Sandwich flow control for individual valve	PS5635P	
	1/8" NPT	PS561600P	
	1/8" BSPP	PS561601P	
	Common pressure	Independent pressure	
	0,1 > 4,1 bar w/ gauge	PS5638155P	PS5638255P
	0,35 > 8,6 bar w/ gauge	PS5638166P	PS5638266P

Most Popular



Valve - 15407-2, Plug-in, Size 26mm (HA)

Symbol	Type	Qn (NI/mn)	Operator	Voltage	Pilot	Non-locking
	5/2 Elec. spring return	1080	Single solenoid	24 VDC	External*	HAEVXLG0G9A
	5/2 Elec. air return	1080	Single solenoid	24 VDC	External*	HA1VXLG0G9A
	5/2 dual Elec.	1080	Double solenoid	24 VDC	External*	HA2VXLG0G9A
	5/3 dual Elec., all ports blocked	980	Double solenoid	24 VDC	External*	HA5VXLG0G9A
	5/3 dual Elec., center exhaust	980	Double solenoid	24 VDC	External*	HA6VXLG0G9A
	5/3 dual Elec., pressure center	980	Double solenoid	24 VDC	External*	HA7VXLG0G9A

* Internal/External defined from the H Universal Supply module (see page 55)





Single Subbase - 15407-2, Plug-in, Size 26 mm (HA)

Enclosure	Solenoid addresses	1/4" BSPP
 Terminal strip in the base	Double solenoid - 2 addresses	PS55114CP

Manifold Base - 2-Station, 15407-2, Plug-in, Size 26 mm (HA)

End ported bases	Enclosure	Solenoid addresses	1/4" BSPP
	Circuit board	Single solenoid - 2 address	PSHU1154J1P
	Circuit board	Double solenoid - 4 addresses	PSHU1154M1P

Accessories - 15407-2, Plug-in, Size 26mm (HA)

Accessories	Description	Part number		
	Blanking plate kit	PS5534P		
	Sandwich flow control for individual valve	PS5535P		
	Pilot pressure control, without sensor, 1/8" BSPP	PS55XA0P		
	1/4" NPT	PS552600P		
	1/4" BSPP	PS552601P		
	Sandwich regulator	Common pressure	Independent pressure	
		2-60 PSIG w/ gauge	PS5538155P	PS5538255P
		5-125 PSIG w/ gauge	PS5538166P	PS5538266P

Most Popular



Valve - 5599-2, Plug-in, Size 1 (H1)

Symbol	Type	Qn (NI/mn)	Operator	Voltage	Pilot	Non-locking
	5/2 Elec. spring return	1480	Single solenoid	24 VDC	External*	H1EVXXG0B9D
	5/2 Elec. air return	1480	Single solenoid	24 VDC	External*	H11VXXG0B9D
	5/2 dual Elec.	1480	Double solenoid	24 VDC	External*	H12VXXG0B9D
	4-way, 3-position, all ports blocked	1180	Double solenoid	24 VDC	External*	H15VXXG0B9D
	5/3 dual Elec., center exhaust	1180	Double solenoid	24 VDC	External*	H16VXXG0B9D
	5/3 dual Elec., pressure center	1180	Double solenoid	24 VDC	External*	H17VXXG0B9D

* Internal/External defined from the H Universal Supply module (see page 55)

Single Subbase - 5599-2, Plug-in, Size 1 (H1)

Side ported	Enclosure / Lead length	Solenoid addresses	3/8" BSPP
	Terminal strip in base	Double solenoid - 2 addresses	PS401116CDP

Manifold Base - 5599-2, Plug-in, Size 1 (H1)

End Ported	Enclosure	Solenoid addresses	3/8" BSPP
	Circuit board	Single solenoid - 1 address	PSHU1156J1P
	Circuit board	Double solenoid - 2 addresses	PSHU1156M1P

Accessories - 5599-2, Size 1 (H1)







Accessory	Description	Part number
	Common pressure	0,35 > 8,6 bar w/ gauge PS4038166CP
	Independent pressure	0,35 > 8,6 bar w/ gauge PS4038266CP
	Blanking plate kit	PS4034CP
	Sandwich flow control	PS4035CP

A Sandwich Flow Control and Common Port Sandwich Regulator may be used together on a manifold or subbase. The Sandwich Flow Control MUST be located between the manifold/subbase and the Common Port Sandwich Regulator.

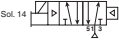
Most Popular

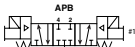

Valve - 5599-2, Plug-in, Size 2 (H2)

Symbol	Type	Qn (Nl/mn)	Operator	Voltage	Pilot	Non-locking
	5/2 Elec. spring return	2750	Single solenoid	24 VDC	External*	H2EVXXG0B9D
						
	5/2 Elec. air return	2750	Single solenoid	24 VDC	External*	H21VXXG0B9D
	5/2 dual Elec.	2750	Double solenoid	24 VDC	External*	H22VXXG0B9D
	5/3 dual Elec., all ports blocked	2450	Double solenoid	24 VDC	External*	H25VXXG0B9D
						
	5/3 dual Elec., center exhaust	2450	Double solenoid	24 VDC	External*	H26VXXG0B9D
	5/3 dual Elec., pressure center	2450	Double solenoid	24 VDC	External*	H27VXXG0B9D

* Internal/External defined from the H Universal Supply module (see page 55)



Single Subbase - 5599-2, Plug-in, Size 2 (H2)

Side ported base	Enclosure / Lead length	Solenoid addresses	1/2" BSPP
	Terminal strip in base	Double solenoid - 2 address	PS411118CCP

Manifold Base - 5599-2, Plug-in, Size 2 (H2)

End Ported	Enclosure	Solenoid addresses	1/2" BSPP
	Circuit board	Single solenoid - 1 address	PSHU1158J1P
	Circuit board	Double solenoid - 2 addresses	PSHU1158M1P

Accessories - 5599-2, Size 2 (H2)

Accessory	Description	Part number
	Common pressure	0,35 > 8,6 bar w/ gauge PS4138166CP
	Independent pressure	0,35 > 8,6 bar w/ gauge PS4138266CP
	Blanking plate kit	PS4134CP
	Sandwich flow control	PS4135CP

A Sandwich Flow Control and Common Port Sandwich Regulator may be used together on a manifold or subbase. The Sandwich Flow Control MUST be located between the manifold/subbase and the Common Port Sandwich Regulator.

Most Popular



End Plate Kit - Universal Plug-in

PSHU20 L1 0 0 P

Valve Type	
Plug-in (internal pilot)	PSHU20
Plug-in (external pilot)	PSHU2X

Thread Type	
0	NPT
1*	BSPP "G"

* BSPP conforms to ISO 1179-1 w 228-1 threads

Left Hand End Plate Type * †	
25-Pin, D-Sub (side)	L1
25-Pin, D-Sub (top)	L2
19-Pin, Round, Brad Harrison	L3
12-Pin, M23	L4
32-Point Terminal Strip	L5
19-Pin, M23	M2
P2H IO Link Class B, 24 Address, Standard Version	N2
P2H IO Link Class B, 24 Address, Safe Version	S2
P2H IO Link Class A, 24 Address, 4-Pin, Safe Version	S4
P2H IO Link Class A, 24 Address, 5-Pin, Safe Version	S5
Turck Network with valve driver module - 16 outputs ‡	T1
Turck Network with valve driver module - 32 outputs ‡	T2
-----For P2H Ethernet Node and PCH Network Portal, see next pages -----	

Right Hand End Plate Type / Port	
0	Low profile (no ports)
1	1/2 Exhaust and inlet port
2	3/4 Exhaust and inlet port
3*	H3 Transition plate, 1" exhaust and inlet, (electrical pass through)
4*	H3 Transition plate, 1" exhaust and inlet, (expansion to 25th address)

* 1, 3 & 5 manifold galery blocked at transition plate. 12 & 14 pass through.

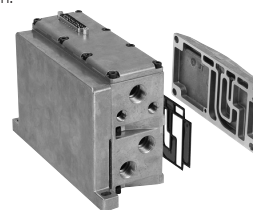

25-pin D-Sub (top) with low profile end plate shown Qn 3900 NI/mn

* 120VAC is not CSA certified.

‡ Turck Network, H Series Network, and P2M Network Node communication modules must be ordered separately. See Network Connectivity section for more information.

† PSHU11P gaskets included in each end plate kit.

◇ Only suitable for P2M Industrial Ethernet Protocols

Right Hand End Plate

	Description	BSPP port
<p>Low Profile High Flow</p>	Right hand end plate only, low profile, 3900 NI/mn	PSHU4000P
	Right hand end plate only, high flow 1/2" ports, 5960 NI/mn	PSHU4101P
	Right hand end plate only, high flow 3/4" ports, 8200 NI/mn	PSHU4201P

H3 Transition Kit

	H3 transition, H3 right hand end plate, 1" ports, electrical pass through (includes gaskets & bolts)	PSHU7101P
	H3 transition, H3 right hand end plate, 1" ports, expansion to 25th address (includes gaskets & bolts)	PSHU7201P

Installation Bracket

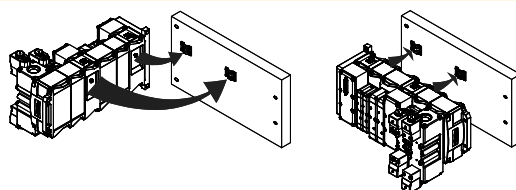

Bracket	Part number
Bracket and Bolt (Quantity 2)	PSHU60P

Most Popular



End Plate Kit – Universal Plug-in

The P2H EtherNet Node is ordered as an endplate kit. This includes the P2H EtherNet Node, left hand air supply module, and right hand end plate. 32 pilot solenoid addresses with two choices of power source configurations.

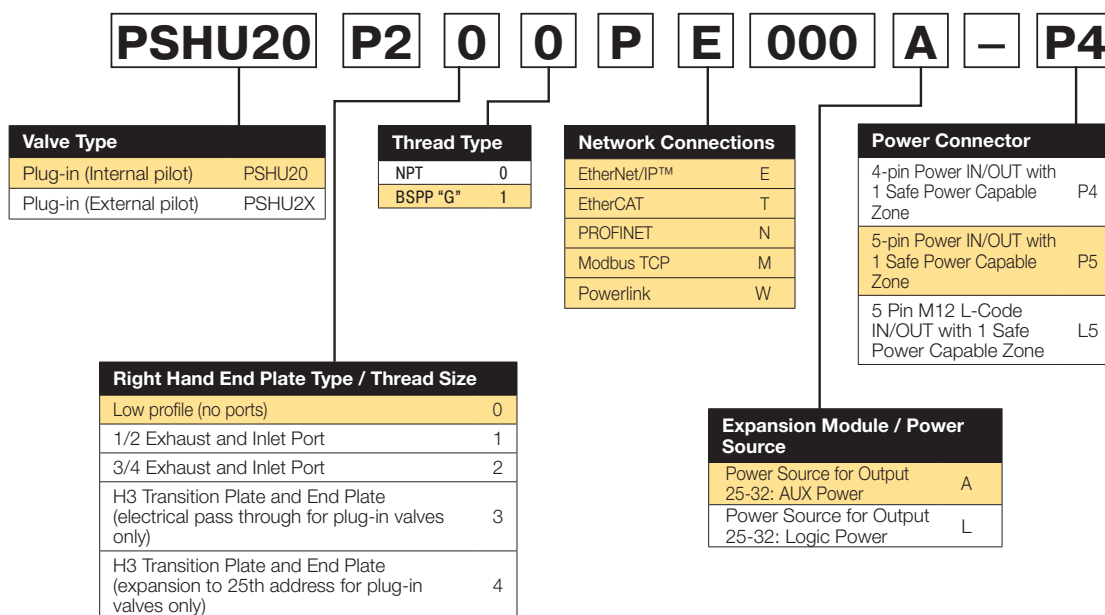

Power Source Selection

The P2H Node 32DO has two available power sources for addresses 24 to 31. Addresses 24 to 31 can draw their power from Auxiliary Power Pins (Power Source Option A) or Logic Power Pins (Power Source Option L). Must use Auxiliary Inlet Module with electrical expansion to access addresses 24 to 31. Address 0 to 23 is always auxiliary power source.



Addresses 0 to 23 draw power from Auxiliary Power Pins

Addresses 24 to 31 draw power from either Auxiliary (Option A) or Logic Pins (Option L)

Most popular

End Plate Kit – Universal Plug-in

The PCH Network Portal is ordered as an endplate kit. This includes the PCH Network Portal, left hand air supply module, and right hand end plate.



PSHU20 P3 0 0 P E AAA 0 - P4

Valve Type	
Plug-in (Internal pilot)	PSHU20
Plug-in (External pilot)	PSHU2X

Thread Type	
NPT	0
BSPP "G"	1

Network Connections	
EtherNet/IP	E
EtherCAT	T
PROFINET	N
PROFINET AIDA	A
Modbus TCP	M

Power Connector *	
4-pin Power IN/OUT with 1 Safe Power Capable Zone	P4
5-pin Power IN/OUT with 1 Safe Power Capable Zone	P5
4-pin Power IN/IN with 2 Safe Power Zones	S4
5-pin Power IN/IN with 2 Safe Power Zones	S5
AIDA Power IN/OUT with 1 Safe Power Capable Zone	J1*

* Only available with Profinet AIDA

Right Hand End Plate Type / Thread Size	
Low profile (no ports)	0
1/2 Exhaust and Inlet Port	1
3/4 Exhaust and Inlet Port	2
H3 Transition Plate and End Plate (electrical pass through for plug-in valves only)	3
H3 Transition Plate and End Plate (expansion to 25th address for plug-in valves only)	4

Module Combinations		
Module Position 1	Module Position 2	Module Position 3
A	A	A
A	A	B
A	A	C
A	A	N
A	B	B
A	B	C
A	B	N
A	C	C
A	C	N
B	B	B
B	B	C
B	B	N
B	C	C
B	C	N
C	C	C
C	C	N

For any module configurations not listed, consult factory.

Valve - 15407-2 Plug-in, Size 18mm (HB) & 26mm (HA)

HB 1 VX B G 0 G9 A 8P

Basic Series 15407-2

ISO 15407-2 18mm	HB
ISO 15407-2 26mm	HA

15407-2 Operator / Function

Single Solenoid, 2-Position - Air Return	1
Double Solenoid, 2-Position	2
Double Solenoid, 3-Position - APB	5
Double Solenoid, 3-Position - CE	6
Double Solenoid, 3-Position - PC	7
Single Solenoid, 2-Position - Air Return, Spring Assist	E
Double Solenoid, Dual 3/2, NC/NC	N*
Double Solenoid, Dual 3/2, NO/NO	P*
Double Solenoid, Dual 3/2, 14 End NC - 12 end NO	Q*

* Available on HB Only, must use Internal Pilot Source Option "B".

Mounting

15407-2 Valve Less Base	VX
-------------------------	----

15407-2 Pilot Source / Pilot Exhaust

B	Internal Pilot, Port #1 / Vented
L*	External Pilot, Port #14 / Vented

*Must be specified when using Sandwich Regulators.

Options

Blank	No Options
8P	M8, PNP, Spool Sensing
8N	M8, NPN, Spool Sensing
2P	M12, PNP, Spool Sensing

* Available on HA series with operator functions 1, 2, E only

15407-2 Engineering Level

A	Current
---	---------

15407-2 Voltage & Frequency

	AC		DC	Light & Surge Suppression
	60Hz	50Hz		
G9			24	LED & Suppression
23	120	115		LED & Suppression

15407-2 Enclosure / Lead Length

0	Valve Less Base
---	-----------------

15407-2 Overrides / Lights

G	Non-Locking, Flush, Push - W/ Light
H	Locking, Flush, Push / Turn - W/ Light

Part Number Cable Type

RKC 4.4T-2	M12, 4 Pin Female, PVC, 2m
PKG 3M-4/S90	M8, 3 Pin Female, PUR, 4M, flying lead



HB 18mm Valve shown

Valve - 5599-2 Plug-in, Size H1 & H2

H1 E VX B G 0 B9 D

Basic series 5599-2

ISO 5599-2 Size 1	H1
ISO 5599-2 Size 2	H2

5599-2 Operator / Function

5/2 Elec. air return	1
5/2 dual Elec.	2
5/3 dual Elec., all ports blocked	5
5/3 dual Elec., center exhaust	6
5/3 dual Elec., pressure center	7
5/2 Elec. spring return	E

5599-2 Mounting

5599-2 Valve less base	VX
------------------------	----

5599-2 Pilot source / Pilot exhaust

Internal pilot, port #1 / vented	B
External pilot, port #12 or #14 / vented	X**

* Internal/External defined from the H Universal Supply module (see page 55)

** Must be specified when using Sandwich Regulators.

5599-2 Engineering Level

D	Current
---	---------

5599-2 Voltage & Frequency

	AC		DC	Light & surge suppression
	60Hz	50Hz		
42	24			
45			12	
B9			24	LED & suppression, 3.2 watt
F9			24	LED & suppression, 1.3 watt
23	120	115		LED & suppression
57*	240			

* Single subbase only. Not available for 5599-2 manifold mount.

5599-2 Enclosure / Lead length

0	None, valve less base
---	-----------------------

5599-2 Overrides / Lights

	Voltage code	
B	42, 45, 57	Non-locking, flush, push - w/o light
C	42, 45, 57	Locking, flush, push / turn - w/o light
G	B9, F9, 23	Non-locking, flush, push - w/ light
H	B9, 23	Locking, flush, push / turn - w/ light



H1 Valve shown

Manifold Kit - Universal Plug-in

PSHU1153 **J** **1** **P**

Mounting Style / Port Size	
HB manifold with 1/8 NPT end ports	PSHU1151
HB manifold with 1/8 BSPP end ports	PSHU1152*
HA manifold with 1/4 NPT end ports	PSHU1153
HA manifold with 1/4 BSPP end ports	PSHU1154*
H1 manifold with 3/8 NPT end ports	PSHU1155
H1 manifold with 3/8 BSPP end ports	PSHU1156*
H2 manifold with 1/2 NPT end ports	PSHU1157
H2 manifold with 1/2 BSPP end ports	PSHU1158*

* BSPP conforms to ISO 1179-1 w 228-1 threads.

Gasket Options	
1	1,3,5 ports open and pilots open
2	1,3,5 ports closed and pilots open
3	1 closed, 3,5 ports open and pilots open
4	1 port open, 3,5 ports closed and pilots open
5	1,3,5 ports open and pilots closed
6	1,3,5 ports closed and pilots closed
7	1 closed, 3,5 ports open and pilots closed
8	1 port open, 3,5 ports closed and pilots closed

Circuit Board Address Configuration	
J	Interconnect, Single Address
M	Interconnect, Double Address



HA manifold shown

Intermediate Air Supply - Universal Plug-in

PSHU115A **T** **1** **P**

Mounting Style / Port Size	
Intermediate air supply, NPT / internal pilot	PSHU115A
Intermediate air supply, BSPP / internal pilot	PSHU115B*
Intermediate air supply, NPT / external pilot	PSHU115C
Intermediate air supply, BSPP / external pilot	PSHU115D*

* BSPP conforms to ISO 1179-1 w 228-1 threads.

Gasket Options	
1	1,3,5 ports open and pilots open
2	1,3,5 ports closed and pilots open
3	1 closed, 3,5 ports open and pilots open
4	1 port open, 3,5 ports closed and pilots open
5	1,3,5 ports open and pilots closed
6	1,3,5 ports closed and pilots closed
7	1 closed, 3,5 ports open and pilots closed
8	1 port open, 3,5 ports closed and pilots closed

Circuit Board Address Configuration	
T	With electrical pass through
E	With electrical expansion to 25th address



Intermediate air supply module shown

Pneumatic Zoning

Multiple pressure zones can be created by selecting alternative gaskets between individual manifold segments or an intermediate air supply module. These zones can be designed to meet different application and safety requirements on the machine. Inserting the PXM Pilot Exhaust Module into a one of these zones allows control of pilot pressure for the entire zone.

Gasket Kit - Universal Manifold to Manifold

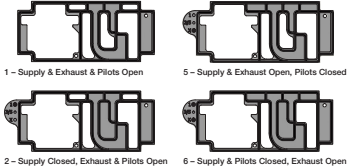
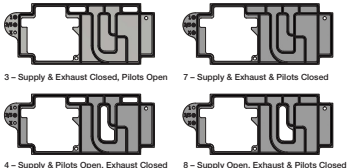
Description		Part number
 <p>1 - Supply & Exhaust & Pilots Open 2 - Supply Closed, Exhaust & Pilots Open 3 - Supply & Exhaust Closed, Pilots Open 4 - Supply & Pilots Open, Exhaust Closed</p>	Pilots opened	PSHU11P
		PSHU12P
		PSHU13P
		PSHU14P
 <p>5 - Supply & Exhaust Open, Pilots Closed 6 - Supply & Pilots Closed, Exhaust Open 7 - Supply & Exhaust & Pilots Closed 8 - Supply Open, Exhaust & Pilots Closed</p>	Pilots blocked	PSHU15P
		PSHU16P
		PSHU17P
		PSHU18P

Pilot Exhaust Module / HA Spool Sensing

PXM Pilot Exhaust Module enables an H Series HA Single Solenoid valve to control the pilot pressure to other externally piloted H Series ISO valves in the same manifold zone. The HA valve in conjunction with the PXM will remove pilot pressure to all externally piloted valves in the manifold zone when solenoid 14 is de-energized (off). Control of all externally piloted valves in the zone is disabled for both solenoid actuation and manual override until solenoid 14 of the HA valve on the PXM is energized again (on).

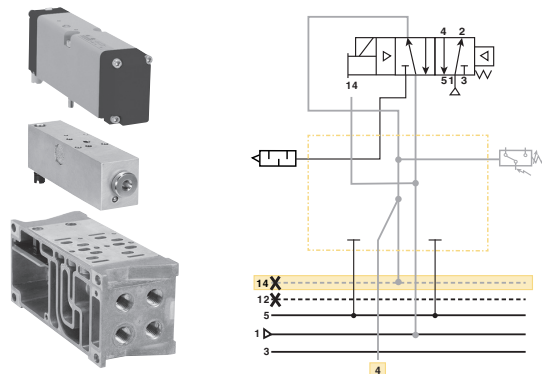

Alternatively, the HA Single Solenoid spool sensing valve can be used in place of the standard HA Valve. The spool sensing option mounts on top of the PXM and provides the added benefit of solid-state sensing of spool position to the PLC via an M8 or M12 connection. The spool sensing can be used without the PXM module for sensing only.

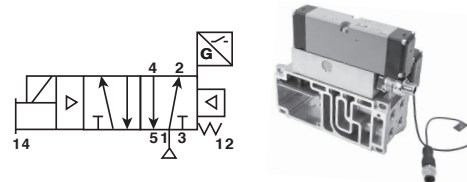

Gaskets blocking pilot pressure are required at the start of the zone the PXM is controlling. Special zoning gaskets (shown below) are available to meet any application requirement. In the example below, main pressure and exhaust pass through to the second zone, but pilot pressure is blocked. This results in the PXM providing pilot pressure for the zone after this gasket.

Part Number	Sensor Type
PS55XA0P	No sensing
PS55XM0P	Mechanical pressure switch
PS55XE0P	Solid state pressure switch

Part Number	Cable Type
RKC4.4T-2	M12 cable, PVC, 2m

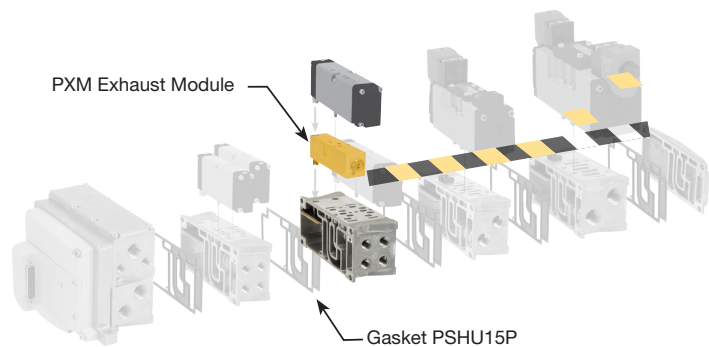

Sandwich Regulator - 15407-2, Plug-in,

PS5638 1 6 6 P

Basic Series	
HB 15407-2, 18 mm, Plug-in	PS5638
HA 15407-2, 26 mm, Plug-in	PS5538

Regulator Function	
Common Pressure Regulator	1
Independent Pressure Regulator	2

#2 Port Regulator / Gauge*	
5	0,1 > 4,1 bar w/Gauge
6	0,35 > 8,6 bar w/Gauge

* For Common Pressure Regulator Option, Regulator Gauge callout must be the same number for both Port #4 and Port #2. (Example: 166)

#4 Port Regulator / Gauge*	
5	0,1 > 4,1 bar w/Gauge
6	0,35 > 8,6 bar w/Gauge

* For Common Pressure Regulator Option, Regulator Gauge callout must be the same number for both Port #4 and Port #2. (Example: 166)

Ordering Components
Sandwich Regulator Kit configured for Internal Pilot as standard.

- Order valve as External Pilot.



HB - 18mm
(Independent Dual Port Regulator shown)



HA - 26mm
(Common Port Regulator shown)

How to Configure Sandwich Regulator / Valve Combinations

Internal Pilot Configuration of Sandwich Regulator HA, HB
Pressure in Base Port 1 feeds regulator configured for Internal Pilot which feeds valve configured for External Pilot.

Accessories	Description	Part number
Gauge adapter kit	Includes 1/8" coupling, long nipple, and gauge	PS5651160P

Sandwich Regulator Qn (NI/mn) Flow Chart*

	Common Pressure Code 166				Dual Pressure Code 266			
	1-2	1-4	2-3	4-5	1-2	1-4	2-3	4-5*
HB	196	196	402	334	226	186	275	265
HA	402	422	854	874	412	442	667	648

* Regulator Port exhaust through Base Port 3.
Note: All Qn's calculated with regulator adjusted full open.

Sandwich Regulator - 5599-2, Plug-in,

PS4038 1 6 6 C P

Basic Series	
H1 5599-2, Plug-in	PS4038
H2 5599-2, Plug-in	PS4138

Regulator Function	
Common Pressure Regulator	1
Independent Pressure Regulator	2

#2 Port Regulator / Gauge*	
0**	Line By-Pass Plate
4	0,05 > 2,0 bar w/Gauge
5	0,1 > 4,1 bar w/Gauge
6	0,35 > 8,6 bar w/Gauge
D	Remote Pilot ISO 2 & 3 only

* For Common Pressure Regulator Option, Regulator Gauge callout must be the same number for both Port #4 and Port #2. (Example: 166)
 ** Pressure Line By-Pass Option can only be used with Independent Pressure Regulators.

#4 Port Regulator / Gauge*	
0**	Line By-Pass Plate
4	0,05 > 2,0 bar w/Gauge
5	0,1 > 4,1 bar w/Gauge
6	0,35 > 8,6 bar w/Gauge
D	Remote Pilot ISO 2 & 3 only

* For Common Pressure Regulator Option, Regulator Gauge callout must be the same number for both Port #4 and Port #2. (Example: 166)
 ** Pressure Line By-Pass Option can only be used with Independent Pressure Regulators.

Ordering Components

- Sandwich Regulator Kit configured for Internal Pilot as standard.
- Order valve as External Pilot.

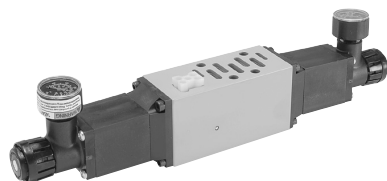

H1 - Size 1
 (Independent Dual Port Regulator shown)

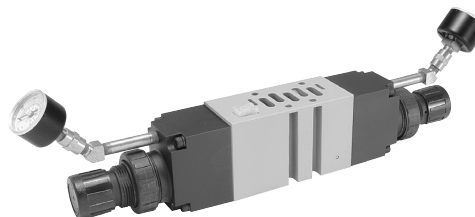

H2 - Size 2
 (Independent Dual Port Regulator shown)

How to Configure Sandwich Regulator / Valve Combinations

Internal Pilot Configuration of Sandwich Regulator H1, H2

Pressure in Base Port 1 feeds regulator configured for Internal Pilot which feeds valve configured for External Pilot.

External Pilot Configuration of Sandwich Regulator H1, H2

An External Pilot pressure in Port 12 or 14 of the base feeds thru the Sandwich Regulator 12 or 14 galley directly to the 12/14 pilot of the valve. This configuration takes an External Pilot from the 12 port of the base and passes it thru the regulator to feed the 12 galley of the valve.

Sandwich Regulator Qn (NI/mn) Flow Chart*

	Common Pressure Code 166				Single Pressure 2 Code 206				Single Pressure 4 Code 260				Dual Pressure Code 266			
	1-2	1-4	2-3	4-5	1-2	1-4	2-3	4-5*	1-2	1-4	2-3	4-5*	1-2	1-4	2-3	4-5*
H1	609	599	1256	1158	716	942	942	913	334	687	923	962	510	471	844	864
H2	1443	1570	2365	2287	1678	1865	1492	1718	1708	1639	1698	1757	1580	1690	1472	1639

* Regulator Port exhaust through Base Port 3.

Note: All Qn's (NI/mn) calculated with regulator adjusted full open.



Online Configuration

Navigate to the landing page

www.parker.com/pde/HSeriesISO

Customize your manifold assembly

Create and save a unique assembled part number

Generate a CAD model

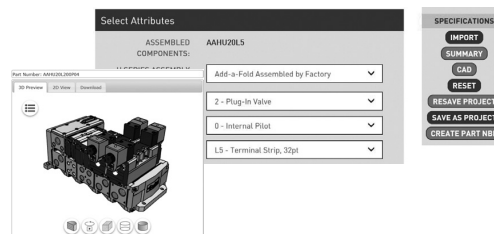

Add-A-Fold - Universal Plug-in

AA HU20 L1 0 0 P 04

Valve Type	
Plug-in (internal)	AAHU20
Plug-in (external)	AAHU2X

Number of Segments	
01	
↓	
32	

Left Hand End Plate Type * †	
25-Pin, D-Sub (side)	L1
25-Pin, D-Sub (top)	L2
19-Pin, Round, Brad Harrison	L3
12-Pin, M23	L4
32-Point Terminal Strip	L5
19-Pin, M23	M2
P2H IO Link Class B, 24 Address, Standard Version	N2
P2H IO Link Class B, 24 Address, Safe Version	S2
P2H IO Link Class A, 24 Address, 4-Pin, Safe Version	S4
P2H IO Link Class A, 24 Address, 5-Pin, Safe Version	S5
Turck Network with valve driver module - 16 outputs ‡	T1
Turck Network with valve driver module - 32 outputs ‡	T2
-----For P2H Ethernet Node and PCH Network Portal, see next pages -----	

Thread Type	
0	NPT
1*	BSPP "G"

* BSPP Conforms to ISO 1179-1 w 228-1 Threads

Right Hand End Plate Type / Port	
0	Low profile (no ports)
1	1/2 Exhaust and inlet port
2	3/4 Exhaust and inlet port
3*	H3 Transition plate, 1" exhaust and inlet, (electrical pass through)
4*	H3 Transition plate, 1" exhaust and inlet, (expansion to 25th address)

* 1, 3 & 5 manifold galley blocked at transition plate. 12 & 14 pass through.

- * 120VAC is not CSA certified.
- ‡ Turck Network, H Series Network, and P2M Network Node communication modules must be ordered separately. See Network Connectivity section for more information.
- † PSHU11P gaskets included in each end plate kit.
- ◇ Only suitable for P2M Industrial Ethernet Protocols

Example

Application requires a 5 segment manifold.

Item	Part No.	Location	
01	AAHUL200P05		
02	HB2VXBG0G9A	Segment 1	Valve station 1
03	HB2VXBG0G9A		Valve station 2
04	PSHU1151M1P		Manifold base
05	HA1VXBG0G9A	Segment 2	Valve station 3
06	HA2VXBG0G9A		Valve station 4
07	PSHU1153M1P		Manifold base
08	HA1VXBG0G9A	Segment 3	Valve station 5
09	HA2VXBG0G9A		Valve station 6
10	PSHU1153M1P		Manifold base
11	H12VXBG0B9A	Segment 4	Valve station 7
12	PSHU1155M1P		Manifold base
13	H22VXBG0B9A	Segment 5	Valve station 8
14	PSHU1157M1P		Manifold base

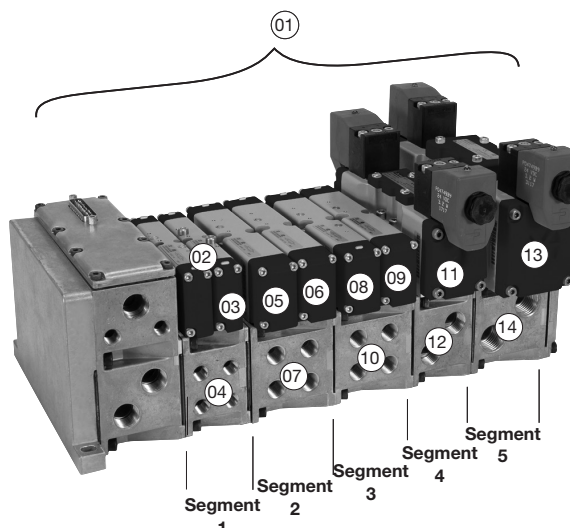

Example:
5 segment manifold with (2) HB, (4) HA, (1) H1, and (1) H2 valve on manifold bases with 25-pin, D-Sub end plate.



Add-A-Fold – Universal Plug-in – P2H Ethernet Node

The P2H Industrial EtherNet node is a control unit capable of controlling up to 32 digital outputs (pilot solenoids), through the most popular Industrial Ethernet protocols. The P2H Ethernet Node is a low-cost network connection with easy integration and simple to use diagnostics all housed in a robust IP65 weld-resistant housing.

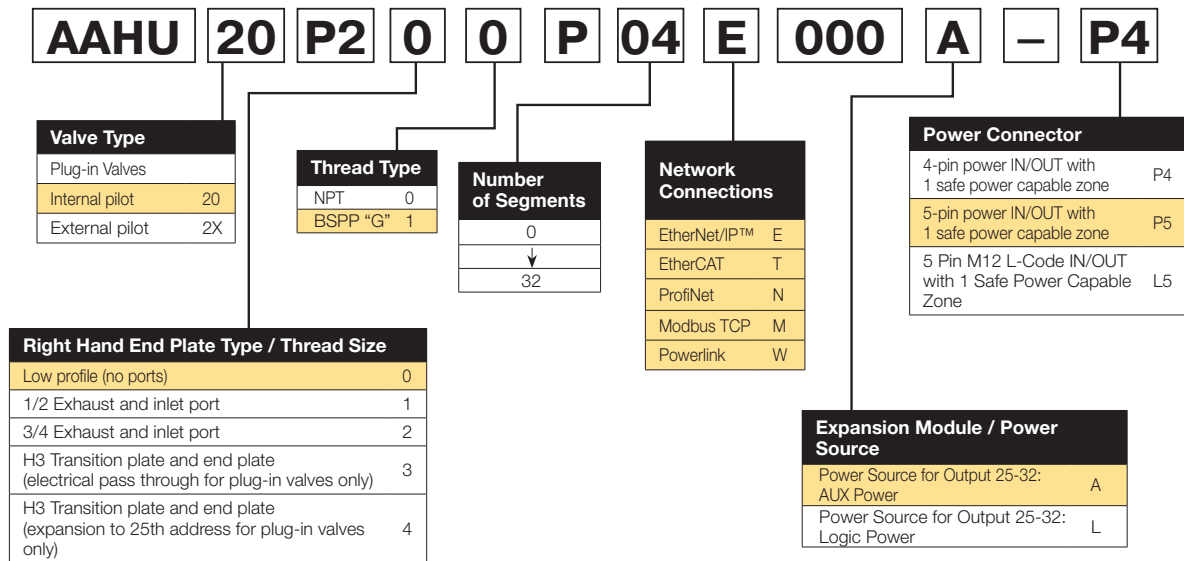

Example

Application required a 4 segment manifold

Item	Part No.	Location
01	AAHU20P200P04E000A-P4	
02	HB2VXBG0G9A	Valve Station 1
03	HB2VXBG0G9A	Segment 1 Valve Station 2
04	PSHU1151M1P	Manifold Base
05	HA1VXBG0G9A	Valve Station 3
06	HA2VXBG0G9A	Segment 2 Valve Station 4
07	PSHU1153M1P	Manifold Base
08	H12VXBG0B9A	Valve Station 5
09	PSHU1155M1P	Segment 3 Manifold Base
10	H2222VXBG0B9A	Valve Station 6
11	PSHU1157M1P	Segment 4 Manifold Base

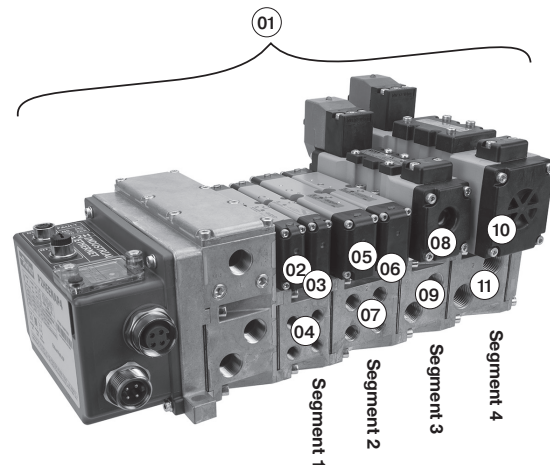

Example:
 5 segment manifold with (2) HB, (2) HA, (1) H1, and (1) H2 valve on manifold bases with P2H Ethernet Node end plate.

Add-A-Fold – Universal Plug-in – PCH Network Portal

The PCH Network Portal redefines and revolutionizes machine I/O (Inputs and Outputs). The PCH Portal was engineered for the open protocol IO-Link A and IO-Link B devices as well as configurable inputs/ outputs with true PNP/NPN circuitry switching on each port for easy machine design changes. The integrated configurability gives the user flexibility in designing I/O architecture. The PCH Network Portal is designed for general pneumatic control of industrial machinery on an Ethernet network for all types of automated industrial equipment.



AAHU 20 P3 0 0 P 04 E AAA 0 - P4

Valve Type	
Plug-in Valves	
Internal pilot	20
External pilot	2X

Thread Type	
NPT	0
BSPP "G"	1

Number of Segments	
0	
↓	
32	

Network Connections	
EtherNet/IP	E
EtherCAT	T
ProfiNet	N
Profinet AIDA	A
Modbus TCP	M

Module Combinations		
Module Position	Module Position	Module Position
1	2	3
A	A	A
A	A	B
A	A	C
A	A	N
A	B	B
A	B	C
A	B	N
A	C	C
A	C	N
B	B	B
B	B	C
B	B	N
B	C	C
B	C	N
C	C	C
C	C	N

Power Connector *	
4-pin power IN/OUT with 1 safe power capable zone	P4
5-pin power IN/OUT with 1 safe power capable zone	P5
4-pin power IN/IN with 2 safe power zones	S4
5-pin power IN/IN with 2 safe power zones	S5
Aida power IN/OUT with 1 safe power capable zone	J1*

* Only available with Profinet AIDA

Right Hand End Plate Type / Thread Size	
Low profile (no ports)	0
1/2 Exhaust and inlet port	1
3/4 Exhaust and inlet port	2
H3 Transition plate and end plate (electrical pass through for plug-in valves only)	3
H3 Transition plate and end plate (expansion to 25th address for plug-in valves only)	4

For any module configurations not listed, consult factory.

Example

Application required a 4 segment manifold

Item	Part No.	Location
01	AAHU20P300P04EAAA0-P4	
02	HB2VXBG0G9A	Valve Station 1
03	HB2VXBG0G9A	Segment 1 Valve Station 2
04	PSHU1151M1P	Manifold Base
05	HA1VXBG0G9A	Valve Station 3
06	HA2VXBG0G9A	Segment 2 Valve Station 4
07	PSHU1153M1P	Manifold Base
08	H12VXBG0B9A	Valve Station 5
09	PSHU1155M1P	Segment 3 Manifold Base
10	H2222VXBG0B9A	Valve Station 6
11	PSHU1157M1P	Segment 4 Manifold Base

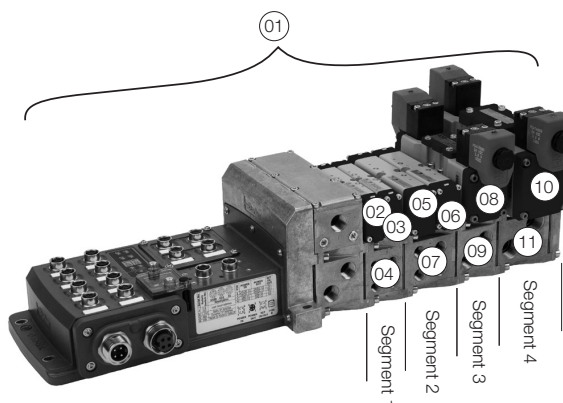

Example:
5 segment manifold with (2) HB, (2) HA, (1) H1, and (1) H2 valve on manifold bases with PCH Network Portal end plate.



Subbase Kit - Plug-in

PS55

Series	
HA Subbase	PS55
H1 Subbase	PS40
H2 Subbase	PS41

1113

Mounting Style / Port Size	
HA Series	
1/4 NPT side ports	1113
1/4 BSPP side ports	1114*
1/4 NPT bottom / side ports	1123
1/4 BSPP bottom / side ports	1124*
H1 Series	
3/8 NPT side ports	1115
3/8 BSPP side ports	1116*
H2 Series	
1/2 NPT side ports	1117
1/2 BSPP side ports	1118*

* BSPP conforms to ISO 1179-1 w 228-1 threads.

C

Engineering Level	
Blank	HA Series
D	H1 Series
C	H2 Series

Wiring Options	
Blank	None
C†	Chrysler
F‡	SAE / Ford
G‡	General Motors











‡ Not available on HA series.

Enclosures / Lead Length	
Individually Wired Base*	
7 †‡	3-Pin mini connector in base
8 †‡	4-Pin M12 micro connector in base
9 †‡	5-Pin mini connector in base
A ‡	150 mm Leads
C	Terminal block

* Use plate with no connection.
† Must specify valve auto wiring option "C", "F", or "G".
‡ Not available on HA series.

P

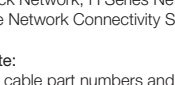
End Plate Kit - Plug-in, 5599-2, Size 3 (H3) * Not compatible with H Universal

Electrical option	BSPP port
 No connector - use with individually wired base	PS4231011DP
 25-pin, D-sub	PS4220L21DP
 19-pin, round, Brad Harrison	PS4220L31DP
 12-pin, M23	PS4220L41DP
 19-pin, M23	PS4220M21DP
 Turck Network with valve driver module - 16 address	PS4220T11DP
 Turck Network with valve driver module - 24 address	PS4220T21DP
 P2H IO Link Class B, standard version, 24 address	PS4220N21DP
 P2H IO Link Class B, safe version, 24 address	PS4220S21DP
 P2H IO Link Class A, 4-pin safe version, 24 address	PS4220S41DP
 P2H IO Link Class A, 5-pin safe version, 24 address	PS4220S51DP

Turck Network, H Series Network, and P2M Network Node communication modules must be ordered separately. See Network Connectivity Section for more information.

Note:

For cable part numbers and pin out information see Network Connectivity Accessories.

Valve - 5599-2, Plug-in, Size 3 (H3)

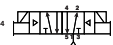
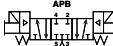
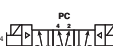

Symbol	Type	On (NI/mn)	Operator	Voltage	Pilot	Non-locking
	5/2 Elec. spring return	5900	Single solenoid	24 VDC	External*	H3EVXXG0B9D
	5/2 Elec. air return	5900	Single solenoid	24 VDC	External*	H31VXXG0B9D
	5/2 dual Elec.	5900	Double solenoid	24 VDC	External*	H32VXXG0B9D
	5/3 dual Elec., all ports blocked	4900	Double solenoid	24 VDC	External*	H35VXXG0B9D
	5/3 dual Elec., center exhaust	4900	Double solenoid	24 VDC	External*	H36VXXG0B9D
	5/3 dual Elec., pressure center	4900	Double solenoid	24 VDC	External*	H37VXXG0B9D

* Internal/External defined from the H Universal Supply module (see page 55)

Subbase - Single 5599-2, Plug-in, Size 3 (H3)

Side ported base	Enclosure / Lead length	Solenoid addresses	3/4" BSPP
	Terminal strip in base	Double solenoid - 2 address	PS421110CCP
	150 mm flying leads	Double solenoid - 2 addresses	PS421110ACP





Manifold Base - 5599-2, Plug-in, Size 3 (H3) * Not compatible with H Universal

Bottom / End Ported Bases	Enclosure / Lead Length	Solenoid Addresses	3/4" BSPP
	Circuit board	Double solenoid - 2 addresses	PS421160MCP
	Terminal strip in base	Double solenoid - 2 address	PS421160CCP
	6" flying leads	Double solenoid - 2 addresses	PS421160ACP
End Ported	Enclosure / Lead length	Solenoid addresses	3/4" BSPP
	Circuit board	Double solenoid - 2 addresses	PS421150MCP
	Terminal strip in base	Double solenoid - 2 address	PS421150CCP
	150 mm flying leads	Double solenoid - 2 addresses	PS421150ACP

Most Popular



Accessories - 5599-2, Size 3 (H3)

Accessory	Description	Part number
 <p>Sandwich regulator</p>	Common pressure 0,35 > 8,6 bar w/ gauge	PS4238166CP
	Independent pressure 0,35 > 8,6 bar w/ gauge	PS4238266CP
 <p>Blanking plate kit</p>		PS4234CP
 <p>Sandwich flow control</p> <p>A Sandwich Flow Control and Common Port Sandwich Regulator may be used together on a manifold or subbase. The Sandwich Flow Control MUST be located between the manifold/subbase and the Common Port Sandwich Regulator.</p>		PS4235CP
 <p>Manifold to manifold gasket kits</p>		PS4213P
 <p>Manifold isolation kit</p>	Main galley (1, 3, 5)	PS4232CP
	Pilot galley	PS4033CP

End Plate Kit - Plug-in, 5599-2, Size 3 (H3) * Not compatible with H Universal

PS42

20L2

0

D

P

Basic Series

ISO 5599, Size 3 PS42

Engineering Level

D Current

Options †	
25-Pin, D-Sub	20L2*
19-Pin, Round, Brad Harrison	20L3
12-Pin, M23	20L4
19-Pin, M23	20M2
P2H IO Link Class B, 24 Address, Standard Version	20N2
P2H IO Link Class B, 24 Address, Safe Version	20S2
P2H IO Link Class A, 24 Address, 4-Pin, Safe Version	20S4
P2H IO Link Class A, 24 Address, 5-Pin, Safe Version	20S5
Turck Network with Valve Driver Module - 16 Outputs	20T1
Turck Network with Valve Driver Module - 24 Outputs	20T2

Thread Type	
0	NPT
1*	BSPP "G"

* BSPP Conforms to ISO 1179-1 w 228-1 Threads

* 120VAC is Not CSA Rated.
 † Manifold bases must have a circuit board.
 Turck Network, H Series Network, and P2M Network Node communication modules must be ordered separately.
 See Network Connectivity Section for more information.

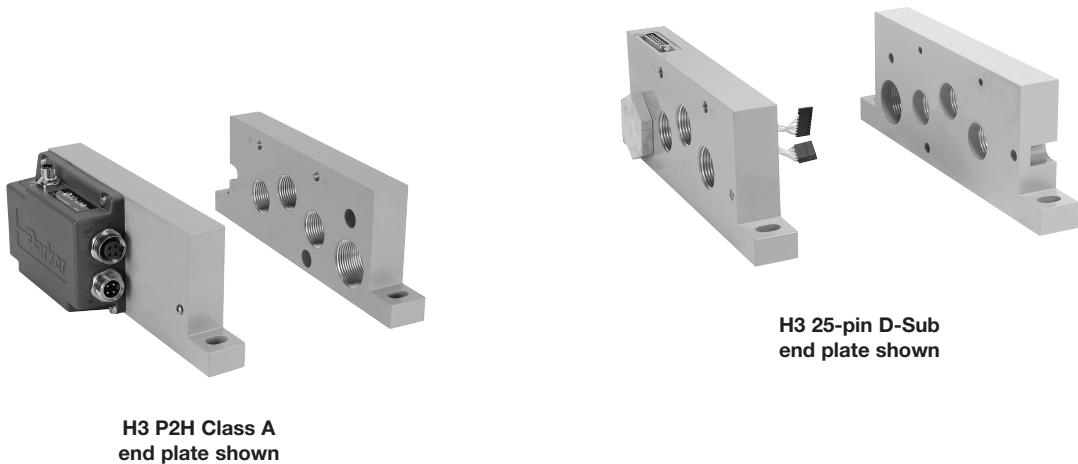

Valve - Plug-in, 5599-2, Size 3

H3 E VX B G 0 B9 D

Basic Series 5599-2	
ISO 5599-2 Size 3	H3

5599-2 Engineering Level	
D	Current

5599-2 Operator / Function	
5/2 Elec. air return	1
5/2 dual Elec.	2
5/3 dual Elec., all ports blocked	5
5/3 dual Elec., center exhaust	6
5/3 dual Elec., pressure center	7
5/2 Elec. spring return	E

5599-2 Voltage & Frequency				
	AC		DC	Light & surge suppression
	60Hz	50Hz		
42	24			
45			12	
B9			24	LED & suppression, 3.2 watt
F9			24	LED & suppression, 1.3 watt
23	120	115		LED & suppression
57	240			

5599-2 Mounting	
5599-2 Valve less base	VX

5599-2 Enclosure / Lead length	
0	None, valve less base

5599-2 Pilot source / Pilot exhaust	
Internal pilot, port #1 / vented	B
External pilot, port #12 or #14 / vented	X*

* Must be specified when using Sandwich Regulators.

5599-2 Overrides / Lights		
	Voltage code	
B	42, 45, 57	Non-locking, flush, push - w/o light
C	42, 45, 57	Locking, flush, push / turn - w/o light
G	B9, F9, 23	Non-locking, flush, push - w/ light
H	B9, 23	Locking, flush, push / turn - w/ light



H3 Valve shown

Manifold / Subbase Kit - Plug-in, 5599-2, Size 3

PS421159 **M** **C** **P**

Mounting Base Style / Port Size	
Subbase: 3/4 NPT side port	PS421119
Subbase: 3/4 BSPP side port	PS421110*
Manifold: 3/4 NPT end port	PS421159
Manifold: 3/4 BSPP end port	PS421150*
Manifold: 3/4 NPT bottom / end port	PS421169
Manifold: 3/4 BSPP bottom / end port	PS421160*

* BSPP conforms to ISO 1179-1 w 228-1 threads.

Engineering Level	
C	H3

Wiring Options	
Blank	None
C	Chrysler
F	SAE / Ford
G	General Motors

Enclosures / Lead Length	
Individually Wired Base**	
7†	3-pin mini connector in base
8†	4-pin M12 micro connector in base
9†	5-pin mini connector in base
A	150 mm Leads
C	Terminal block
Collective Wired Base	
M*	Circuit board, double address

Note:

When using the enclosure / lead length "M" option:

12VDC - Maximum number of coils energized simultaneously is 13

24VDC - Maximum number of coils energized simultaneously is 21, B9 coil
Maximum number of coils energized simultaneously is 24, F9 coil

120VAC - Coils limited by the number of pins available in the connector
(25-pin D-Sub = 24 coils, 19-pin Brad Harrison = 16, 12-pin M23 = 8)

240VAC - Must use "A" or "C" option, lead wires or terminal blocks

* Not available with subbase kits.

** Use plate with no connection.

† Must specify valve auto wiring option "C", "F", or "G".

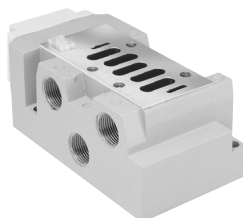

Subbase Kit

Automotive Connectors

Mounted in 1/2" Conduit Port

- 3-Pin - Wired for Single Solenoid
- 4-Pin / 5-Pin - Wired for Double Solenoid



Manifold Kit

Automotive Connectors

Mounted in Individual Manifold Conduit Cover

- 3-Pin - Wired for Single Solenoid
- 4-Pin / 5-Pin - Wired for Double Solenoid

Sandwich Regulator - Plug-in, 5599-2

PS4038 **1** **6** **6** **C** **P**

Basic Series

H3 5599-2, Plug-in PS4238

Regulator Function

Common Pressure Regulator	1
Independent Pressure Regulator	2

#2 Port Regulator / Gauge*

0**	Line By-Pass Plate
4	0,05 > 2,0 bar w/Gauge
5	0,1 > 4,1 bar w/Gauge
6	0,35 > 8,6 bar w/Gauge
D	Remote Pilot ISO 2 & 3 only

* For Common Pressure Regulator Option, Regulator Gauge callout must be the same number for both Port #4 and Port #2. (Example: 166)

** Pressure Line By-Pass Option can only be used with Independent Pressure Regulators.

#4 Port Regulator / Gauge*

0**	Line By-Pass Plate
4	0,05 > 2,0 bar w/Gauge
5	0,1 > 4,1 bar w/Gauge
6	0,35 > 8,6 bar w/Gauge
D	Remote Pilot ISO 2 & 3 only

* For Common Pressure Regulator Option, Regulator Gauge callout must be the same number for both Port #4 and Port #2. (Example: 166)

** Pressure Line By-Pass Option can only be used with Independent Pressure Regulators.

- Ordering Components**
- Sandwich Regulator Kit configured for Internal Pilot as standard.
 - Order valve as External Pilot.

How to Configure Sandwich Regulator / Valve Combinations

- Internal Pilot Configuration of Sandwich Regulator H3**
Pressure in Base Port 1 feeds regulator configured for Internal Pilot which feeds valve configured for External Pilot.
- External Pilot Configuration of Sandwich Regulator H3**
An External Pilot pressure in Port 12 or 14 of the base feeds thru the Sandwich Regulator 12 or 14 galley directly to the 12/14 pilot of the valve. This configuration takes an External Pilot from the 12 port of the base and passes it thru the regulator to feed the 12 galley of the valve.

Sandwich Regulator Qn (NI/mn) Flow Chart*

	Common Pressure Code 166				Single Pressure 2 Code 206				Single Pressure 4 Code 260				Dual Pressure Code 266			
	1-2	1-4	2-3	4-5	1-2	1-4	2-3	4-5*	1-2	1-4	2-3	4-5*	1-2	1-4	2-3	4-5*
H3	2326	2346	4220	4387	2326	2758	2699	2954	2601	2542	2630	2689	2385	2365	3102	2984

* Regulator Port exhaust through Base Port 3.
Note: All Qn's calculated with regulator adjusted full open.



Add-A-Fold Assembly - Plug-in, 5599-2, Size 3 * Not compatible with H Universal

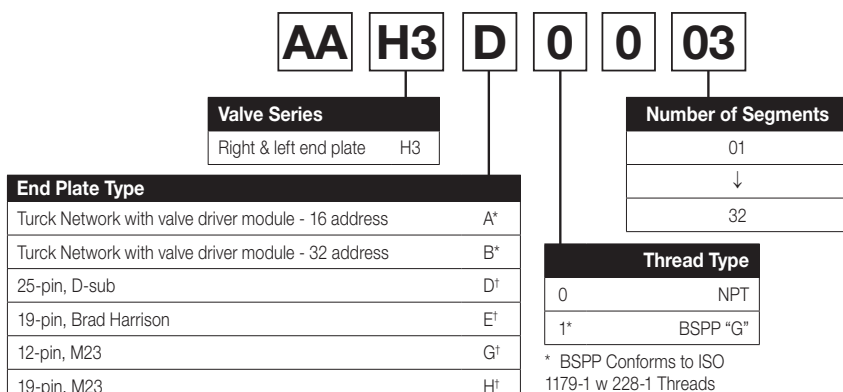

How To Order Plug-in Add-A-Fold Assemblies

1. List Add-A-Fold Assembly call out. This automatically includes the end plate kit assembly.
2. List complete valve, regulator, flow control and manifold base kit. List left to right, LOOKING AT THE CYLINDER PORTS on the #12 end of the manifold. The left most segment is segment 1. (If a blanking plate is needed, list the blanking plate part number and the individual manifold part numbers for the required segment.)

Example

Application requires a 3 segment manifold and regulator on segment 3.





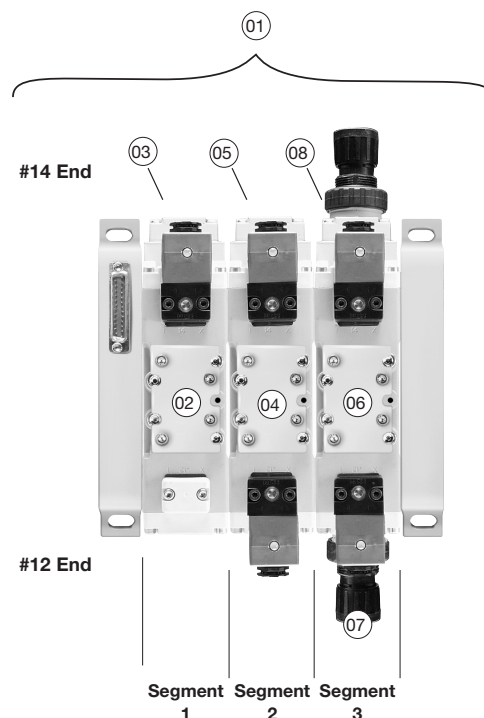

Item	Part No.	Location	
01	AAH3D003		
02	H31VXBG0B9D	Segment 1	Valve station 1
03	PS421159MCP		Manifold base
04	H32VXBG0B9D	Segment 2	Valve station 2
05	PS421159MCP		Manifold base
06	H32VXXG0B9D	Segment 3	Valve station 3
07	PS4238166CP		Sandwich regulator
08	PS421159MCP		Manifold base

NOTE: Construct manifold assemblies from left to right while looking at the cylinder ports.
 Valves must be ordered as External Pilot when using Sandwich Regulator.





Example:
 3 segment manifold with (3) H3 valves on manifold bases and regulator at segment 3.

Valve -15407-1, Non Plug-in, Size 18mm (HB)





Symbol	Type	Qn (NI/mn)	Operator	Voltage	Pilot	Non-locking	
	5/2 Elec. spring return	540	Single solenoid	24 VDC	Internal	HB5WXBG2G9000FA	
					External*	HB5WXLG2G9000FA	
	5/2 Elec. air return	540	Single solenoid	24 VDC	Internal	HB1WXBG2G9000FA	
					External*	HB1WXLG2G9000FA	
	5/2 dual Elec.	540	Double solenoid	24 VDC	Internal	HB2WXBG2G9000FA	
					External*	HB2WXLG2G9000FA	
	5/3 dual Elec., all ports blocked	490	Double solenoid	24 VDC	Internal	HB5WXBG2G9000FA	
					External*	HB5WXLG2G9000FA	
	5/3 dual Elec., center exhaust	490	Double solenoid	24 VDC	Internal	HB6WXBG2G9000FA	
					External*	HB6WXLG2G9000FA	
	5/3 dual Elec., pressure center	490	Double solenoid	24 VDC	Internal	HB7WXBG2G9000FA	
					External*	HB7WXLG2G9000FA	
	Dual 3/2 Elec. NC/NC	440	Double solenoid	24 VDC	Internal	HBNWXBG2G9000FA	
					Dual 3/2 Elec. NO/NO	Internal	HBPWXBG2G9000FA
						Internal	HBQWXBG2G9000FA

* Used with H Universal Manifold, "Internal / External" defined from the H Universal Supply module (see page 55)

Base / End Plate - 15407-1, Non Plug-in, Size 18 mm (HB)

	Description	BSP
	Universal manifold base 2 station, end ported	PSHU115201P
	Universal end plate Non-collective wiring	PSHU31L001P

Accessories - 15407-1, Non-Plug-in, Size 18 mm (HB)

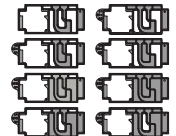

Accessories	Description	Part number	
	Gauge adapter kit Includes 1/8" coupling and long nipple	PS5651160P	
	Blanking plate kit	PS5634P	
	Sandwich flow control	PS5642P	
	1/8" BSPP	PS562601P	
	1/8" NPT	PS562600P	
	Common pressure	Independent pressure	
	0,1 > 4,1 bar w/ gauge	PS5637155P	PS5637255P
	0,35 > 8,6 bar w/ gauge	PS5637166P	PS5637266P
	Manifold to manifold gasket kits	Pilot open	Pilot blocked
	#1, 3, 5 ports open	PSHU11P	PSHU15P
	Blocked #1 port	PSHU12P	PSHU16P
	Blocked #1, 3, 5, ports	PSHU13P	PSHU17P
	Blocked #3, 5 ports	PSHU14P	PSHU18P

* Included with each Universal Manifolds and Supply modules

Most Popular



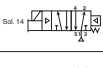
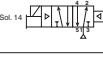
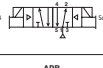
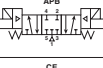
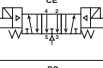

Valve - 15407-1, Non Plug-in, Size 26 mm (HA)





Symbol	Type	Qn (NI/mn)	Operator	Voltage	Pilot	Non-locking
	5/2 Elec. spring return	1080	Single solenoid	24 VDC	Internal	HAEWXBG2G9000FA
					External*	HAEWXLG2G9000FA
	5/2 Elec. air return	1080	Single solenoid	24 VDC	Internal	HA1WXBG2G9000FA
					External*	HA1WXLG2G9000FA
	5/2 dual Elec.	1080	Double solenoid	24 VDC	Internal	HA2WXBG2G9000FA
					External*	HA2WXLG2G9000FA
	5/3 dual Elec., all ports blocked	980	Double solenoid	24 VDC	Internal	HA5WXBG2G9000FA
					External*	HA5WXLG2G9000FA
	5/3 dual Elec., center exhaust	980	Double solenoid	24 VDC	Internal	HA6WXBG2G9000FA
					External*	HA6WXLG2G9000FA
	5/3 dual Elec., pressure center	980	Double solenoid	24 VDC	Internal	HA7WXBG2G9000FA
					External*	HA7WXLG2G9000FA

* Used with H Universal Manifold, "Internal / External" defined from the H Universal Supply module (see page 55)

Base / End Plate - 15407-1, Non Plug-in, Size 26 mm (HA)

	Description	BSPP
 Single subbase	Side ported base, 1/4" port	PS5511140P
 Universal manifold base	2 station, end ported	PSHU115401P
 Universal end plate	Non-collective wiring	PSHU31L001P

Accessories - 15407-1, Non-Plug-in, Size 26 mm (HA)

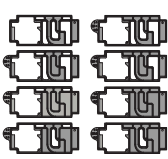



Accessories	Description	Part number	
 Blanking plate kit		PS5534P	
 Sandwich flow control		PS5542P	
Sandwich Flow Control and Common Port Sandwich Regulator may be sandwiched together on a manifold or subbase. The Sandwich Flow Control MUST be located between the manifold/subbase and the Common Port Sandwich Regulator.			
 Pilot exhaust module	Pilot pressure control, without sensor, 1/8" BSPP	PS55XXA0P	
 Sandwich supply module	1/4" NPT	PS552600P	
	1/4" BSPP	PS552601P	
 Sandwich regulator	0,1 > 4,1 bar w/ gauge	Common pressure	PS5537155P
		Independent pressure	PS5537255P
	0,35 > 8,6 bar w/ gauge	Pilot open	PS5537166P
		Pilot blocked	PS5537266P
 Manifold to manifold gasket kits	#1, 3, 5 ports open	PSHU11P	PSHU15P
	Blocked #1 port	PSHU12P	PSHU16P
	Blocked #1, 3, 5, ports	PSHU13P	PSHU17P
	Blocked #3, 5 ports	PSHU14P	PSHU18P

* Included with each Universal Manifolds and Supply modules



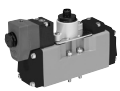

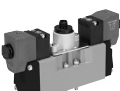
Most Popular

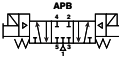
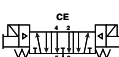
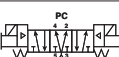

Valve with Central Connector - 5599-1, Non Plug-in, Size 1 (H1)

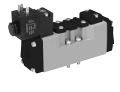
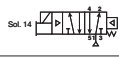
Symbol	Type	Qn (Nl/mn)	Operator	Voltage	Pilot	Non-locking
4-Pin Central M12 Connector, 24 VDC						
		5/2 Elec. spring return	1480	Single solenoid	24 VDC	Internal H1EWXBG2B9000FD External* H1EWXXG2B9000FD
		5/2 Elec. air return	1480	Single solenoid	24 VDC	Internal H11WXBG2B9000FD External* H11WXXG2B9000FD
		5/2 dual Elec.	1480	Double solenoid	24 VDC	Internal H12WXBG2B9000FD External* H12WXXG2B9000FD
		5/3 dual Elec., all ports blocked	1180	Double solenoid	24 VDC	Internal H15WXBG2B9000FD External* H15WXXG2B9000FD
		5/3 dual Elec., center exhaust	1180	Double solenoid	24 VDC	Internal H16WXBG2B9000FD External* H16WXXG2B9000FD
		5/3 dual Elec., pressure center	1180	Double solenoid	24 VDC	Internal H17WXBG2B9000FD External* H17WXXG2B9000FD

Valve with 3-Pin DIN Connector - 5599-1, Non Plug-in, Size 1 (H1)

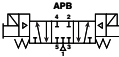
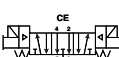
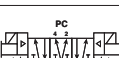

Symbol	Type	Qn (Nl/mn)	Operator	Voltage	Pilot	Non-locking
3-Pin DIN Connector, 24 VDC						
		5/2 Elec. spring return	1480	Single solenoid	24 VDC	Internal H1EWXBBL49D External* H1EWXXBL49D
		5/2 Elec. air return	1480	Single solenoid	24 VDC	Internal H11WXBBL49D External* H11WXXBL49D
		5/2 dual Elec.	1480	Double solenoid	24 VDC	Internal H12WXBBL49D External* H12WXXBL49D
		5/3 dual Elec., all ports blocked	1180	Double solenoid	24 VDC	Internal H15WXBBL49D External* H15WXXBL49D
		5/3 dual Elec., center exhaust	1180	Double solenoid	24 VDC	Internal H16WXBBL49D External* H16WXXBL49D
		5/3 dual Elec., pressure center	1180	Double solenoid	24 VDC	Internal H17WXBBL49D External* H17WXXBL49D

* Used with H Universal Manifold, "Internal / External" defined from the H Universal Supply module (see page 55)



Most Popular



Base / End Plate - 5599-1, Non Plug-in, Size 1 (H1)

		Description	BSPP
	Single subbase	Side ported, 3/8" port	PS4011160DP
	Universal manifold base	End ported	PSHU115601P
	Universal end plate	Non-collective wiring	PSHU31L001P





Accessories - 5599-1, Non Plug-in, Size 1 (H1)

	Accessory	Description	Part number
	Sandwich regulator	Common pressure 0,35 > 8,6 bar w/ gauge	PS4037166CP
		Independent pressure 0,35 > 8,6 bar w/ gauge	PS4037266CP
	Blanking plate kit		PS4034CP
	Sandwich flow control		PS4042CP
	Sandwich Flow Control and Common Port Sandwich Regulator may be sandwiched together on a manifold or subbase. The Sandwich Flow Control MUST be located between the manifold/subbase and the Common Port Sandwich Regulator.		



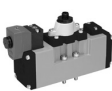

Most Popular

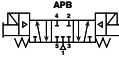
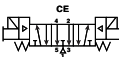
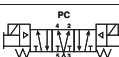

Valve with Central Connector - 5599-1, Non Plug-in, Size 2 (H2)

Symbol	Type	Qn (Nl/mn)	Operator	Voltage	Pilot	Non-locking
4-Pin Central M12 Connector, 24 VDC						
	Sol. 14 	5/2 Elec. spring return	2950	Single solenoid	24 VDC	Internal H2EWXBG2B9000FD External* H2EWXXG2B9000FD
	Sol. 14 	5/2 Elec. air return	2950	Single solenoid	24 VDC	Internal H21WXBG2B9000FD External* H21WXXG2B9000FD
	Sol. 14 	5/2 dual Elec.	2950	Double solenoid	24 VDC	Internal H22WXBG2B9000FD External* H22WXXG2B9000FD
	#14 	5/3 dual Elec., all ports blocked	2750	Double solenoid	24 VDC	Internal H25WXBG2B9000FD External* H25WXXG2B9000FD
	#14 	5/3 dual Elec., center exhaust	2750	Double solenoid	24 VDC	Internal H26WXBG2B9000FD External* H26WXXG2B9000FD
	#14 	5/3 dual Elec., pressure center	2750	Double solenoid	24 VDC	Internal H27WXBG2B9000FD External* H27WXXG2B9000FD

Valve with 3-Pin DIN Connector - 5599-1, Non Plug-in, Size 2 (H2)

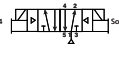
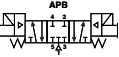
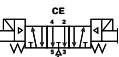
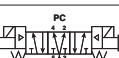

Symbol	Type	Qn (Nl/mn)	Operator	Voltage	Pilot	Non-locking
3-Pin DIN Connector on Coil, 24 VDC						
	Sol. 14 	5/2 Elec. spring return	2950	Single solenoid	24 VDC	Internal H2EWXBBL49D External* H2EWXXBL49D
	Sol. 14 	5/2 Elec. air return	2950	Single solenoid	24 VDC	Internal H21WXBBL49D External* H21WXXBL49D
	Sol. 14 	5/2 dual Elec.	2950	Double solenoid	24 VDC	Internal H22WXBBL49D External* H22WXXBL49D
	#14 	5/3 dual Elec., all ports blocked	2750	Double solenoid	24 VDC	Internal H25WXBBL49D External* H25WXXBL49D
	#14 	5/3 dual Elec., center exhaust	2750	Double solenoid	24 VDC	Internal H26WXBBL49D External* H26WXXBL49D
	#14 	5/3 dual Elec., pressure center	2750	Double solenoid	24 VDC	Internal H27WXBBL49D External* H27WXXBL49D

* Used with H Universal Manifold, "Internal / External" defined from the H Universal Supply module (see page 55)



Most Popular



Base / End Plate - 5599-1, Non Plug-in, Size 2 (H2)

		Description	1/2" BSPP
	Single subbase	Side ported, 1/2" port	PS4111180CP
	Universal manifold base	End ported	PSHU115801P
	Universal end plate	Non-collective wiring	PSHU31L001P

Accessories - 5599-1, Non Plug-in, Size 2 (H2)

Accessory	Description	Part number
	Common pressure	0,35 > 8,6 bar w/ gauge PS4137166CP
	Independent pressure	0,35 > 8,6 bar w/ gauge PS4137266CP
	Blanking plate kit	PS4134CP
	Sandwich flow control	PS4142CP

Sandwich Flow Control and Common Port Sandwich Regulator may be sandwiched together on a manifold or subbase. The Sandwich Flow Control MUST be located between the manifold/subbase and the Common Port Sandwich Regulator.

Most Popular



End Plate Kit - Universal Non Plug-in



Left hand end plate

PSHU31 L0 0 0 P

Valve Type	
Non Plug-in (internal pilot)	PSHU31
Non Plug-in (external pilot)	PSHU3X

Left Hand End Plate Type	
Non Plug-in	L0

Thread Type	
0	NPT
1*	BSPP "G"

* BSPP Conforms to ISO 1179-1 w 228-1 Threads

Right Hand End Plate Type / Port	
0	Low profile (no ports)
1	1/2 Exhaust and inlet port
2	3/4 Exhaust and inlet port
5*	H3 Transition plate, 1" exhaust and inlet

* 1, 3 & 5 manifold galley blocked at transition plate. 12 & 14 pass through.

Right Hand End Plate



Low Profile

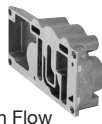

High Flow

Description	BSPP port	NPT port
Right hand end plate only, low profile	PSHU4000P	
Right hand end plate only, high flow 1/2" ports	PSHU4101P	PSHU4100P
Right hand end plate only, high flow 3/4" ports	PSHU4201P	PSHU4200P

H3 Transition Kit



H3 transition, H3 right hand end plate, 1" ports (includes gaskets & bolts)	PSHU7301P	PSHU7300P
---	------------------	------------------

Valve - Non Plug-in, 15407-1, Size 18mm (HB) & 26mm (HA)

HB E WX B G 2 G9 000F A

Basic series 15407-1	
ISO 15407-1 18mm	HB
ISO 15407-1 26mm	HA

15407-1 Operator / Function	
5/2 Elec. air return	1
5/2 dual Elec.	2
5/3 dual Elec., all ports blocked	5
5/3 dual Elec., center exhaust	6
5/3 dual Elec., pressure center	7
5/2 Elec. spring return	E
Dual 3/2 Elec. NC/NC	N†
Dual 3/2 Elec. NO/NO	P†
Dual 3/2 Elec. NC/NO	Q†

† Available on HB Only, must use Internal Pilot Source Option "B".

15407-1 Mounting	
Valve less base	WX

15407-1 Engineering level	
A	Current

15407-1 Central connector wiring options	
000F	SAE / Ford, ISO 20401

15407-1 Voltage & frequency	
G9	24VDC LED & suppression

15407-1 Enclosure / Lead length	
2	4-pin, M12 micro, straight connector

15407-1 Overrides / Lights	
G	Non-locking, flush, push - w/ light
H	Locking, flush, push / turn - w/ light

15407-1 Pilot source / Pilot exhaust	
B	Internal pilot, port #1 / vented
L*	External pilot, port #14 / vented

* Must be specified when using Sandwich Regulators.

Most Popular



Valve - Non Plug-in, 5599-1, Central Connector - Size 1 & 2

H1 E WX B G 2B9 000F D

Basic Series 5599-1	
ISO 5599-1 Size 1	H1
ISO 5599-1 Size 2	H2

5599-1 Operator / Function	
5/2 Elec. air return	1
5/2 dual Elec.	2
5/3 dual Elec., all ports blocked	5
5/3 dual Elec., center exhaust	6
5/3 dual Elec., pressure center	7
5/2 Elec. spring return	E

5599-1 Mounting	
Valve less base	WX

5599-1 Pilot Source / Pilot Exhaust	
Internal pilot, port #1 / vented	B
External pilot, port #12 or #14 / vented	X*

* Must be specified when using Sandwich Regulators.

5599-1 Overrides / Lights	
Non-locking, flush, with light	G
Locking, flush, with light	H

5599-1 Engineering Level	
D	Current

5599-1 Central Connector Wiring Options	
000C	Chrysler
000F*	SAE / Ford, ISO 20401
000G	General Motors

* Complies to ISO 20401 with Enclosure Lead Length "2".

Enclosure / Lead Length / Voltage*				
	AC		DC	
	60Hz	50Hz		
1B9 [†]			24	3-pin, central mini connector, 3.2 watt
1F9 ^{†*}			24	3-pin, central mini connector, 1.3 watt
123 [†]	120	115		3-pin, central mini connector
2B9			24	4-pin, central M12 micro connector, 3.2 watt
2F9 [*]			24	4-pin, central M12 micro connector, 1.3 watt
3B9			24	5-pin, central mini connector, 3.2 watt
3F9 [*]			24	5-pin, central mini connector, 1.3 watt
323	120	115		5-pin, central mini connector
619 [†]			24	2-pin, M12 micro connector on coil

* All coils include LED & suppression
[†] Operator function "1" or "E"
^{*} Only available with wiring option "000F"
^{*} Override "G" only.

Valve - Non Plug-in, 5599-1, CNOMO - Size 1 & 2

H1 E WX B B L53 D

Basic Series 5599-1	
ISO 5599-1 Size 1	H1
ISO 5599-1 Size 2	H2

5599-1 Operator / Function	
5/2 Elec. air return	1
5/2 dual Elec.	2
5/3 dual Elec., all ports blocked	5
5/3 dual Elec., center exhaust	6
5/3 dual Elec., pressure center	7
5/2 Elec. spring return	E

5599-1 Mounting	
Valve less base	WX

5599-1 Pilot Source / Pilot Exhaust	
Internal pilot, port #1 / vented	B
External pilot, port #12 or #14 / vented	X*

* Must be specified when using Sandwich Regulators.

5599-1 Overrides / Lights	
B	Non-locking, flush, push - no light
C	Locking, flush, push / turn - no light

5599-1 Engineering Level	
D	Current

Enclosure / Lead length / Voltage				
	AC		DC	
	60Hz	50Hz		
L42	24			3-pin, 30mm DIN 43650A with CNOMO connector
L45			12	3-pin, 30mm DIN 43650A with CNOMO connector
L49			24	3-pin, 30mm DIN 43650A with CNOMO connector
L53	120	115		3-pin, 30mm DIN 43650A with CNOMO connector
L57	240			3-pin, 30mm DIN 43650A with CNOMO connector
NXX				Valve less coil

Most Popular



Remote Pilot - Size 18mm (HB), Size 26mm (HA), Size 1 (H1) & Size 2 (H2)

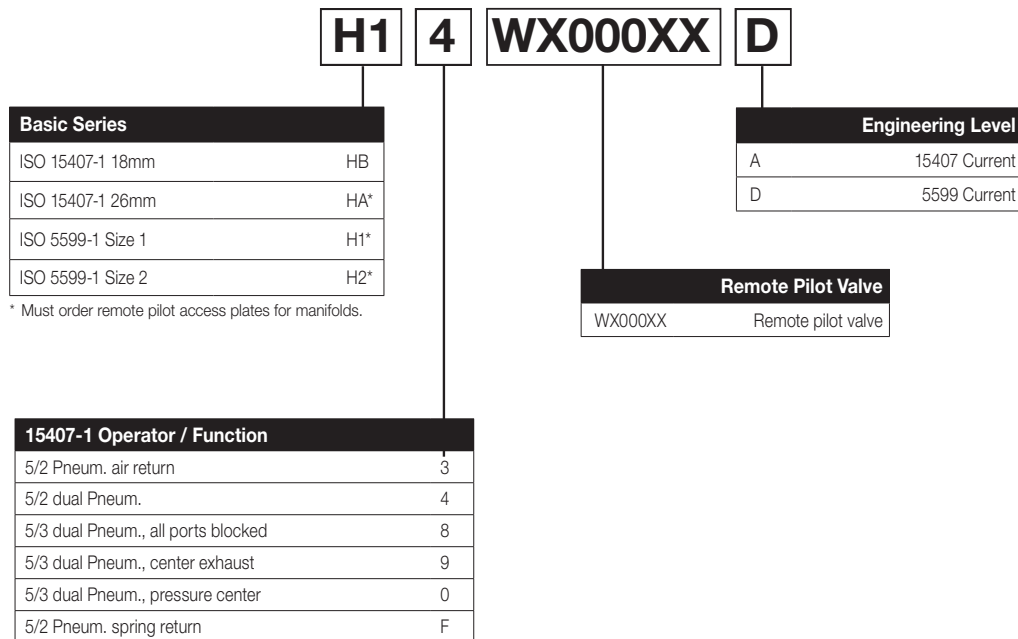

Note: For manifolds, end plates, and accessories, see 15407-1 & 5599-1 Non Plug-in valve section.

Note: HB 18mm Valve Remote Pilot Option only available with PL02 Individual Subbase Kits.

Remote Pilot Access Plate Kit

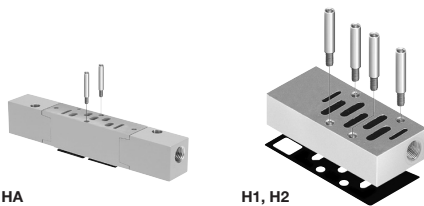

Size	Port size	BSPP "G"	NPT
HA	1/4"	PS551501P	PS551500P
H1	1/8"	PS401501CP	PS401500CP
H2	1/8"	PS411501CP	PS411500CP

Kit includes: Pilot port access plate, gasket and mounting studs.

Manifold Kit - Universal Non Plug-in

PSHU1153 0 1 P

Mounting Style / Port Size	
HB manifold with 1/8 NPT end ports	PSHU1151
HB manifold with 1/8 BSPP end ports	PSHU1152*
HA manifold with 1/4 NPT end ports	PSHU1153
HA manifold with 1/4 BSPP end ports	PSHU1154*
H1 manifold with 3/8 NPT end ports	PSHU1155
H1 manifold with 3/8 BSPP end ports	PSHU1156*
H2 manifold with 1/2 NPT end ports	PSHU1157
H2 manifold with 1/2 BSPP end ports	PSHU1158*

* BSPP conforms to ISO 1179-1 w 228-1 threads.

Gasket Options	
1	1,3,5 ports open and pilots open
2	1,3,5 ports closed and pilots open
3	1 closed, 3,5 ports open and pilots closed
4	1 port open, 3,5 ports closed and pilots open
5	1,3,5 ports open and pilots closed
6	1,3,5 ports closed and pilots closed
7	1 closed, 3,5 ports open and pilots closed
8	1 port open, 3,5 ports closed and pilots open

Circuit Board Address Configuration	
0	No interconnect



HA manifold

Intermediate Air Supply - Universal Non Plug-in

PSHU115A 0 1 P

Mounting Style / Port Size	
Intermediate air supply, NPT / internal pilot	PSHU115A
Intermediate air supply, BSPP / internal pilot	PSHU115B*
Intermediate air supply, NPT / external pilot	PSHU115C
Intermediate air supply, BSPP / external pilot	PSHU115D*

* BSPP Conforms to ISO 1179-1 w 228-1 Threads.

Gasket Options	
1	1,3,5 ports open and pilots open
2	1,3,5 ports closed and pilots open
3	1 closed, 3,5 ports open and pilots closed
4	1 port open, 3,5 ports closed and pilots open
5	1,3,5 ports open and pilots closed
6	1,3,5 ports closed and pilots closed
7	1 closed, 3,5 ports open and pilots closed
8	1 port open, 3,5 ports closed and pilots open

Circuit Board Address Configuration	
0	No electrical



Intermediate air supply

Most Popular



Pneumatic Zoning

Multiple pressure zones can be created by selecting alternative gaskets between individual manifold segments or an intermediate air supply module. These zones can be designed to meet different application and safety requirements on the machine. Inserting the PXM Pilot Exhaust Module into a one of these zones allows control of pilot pressure for the entire zone.

Gasket Kit - Universal Manifold to Manifold

Description		Part number	
<p>1 – Supply & Exhaust & Pilots Open 2 – Supply Closed, Exhaust & Pilots Open 3 – Supply & Exhaust Closed, Pilots Open 4 – Supply & Pilots Open, Exhaust Closed</p>	Pilots opened	PSHU11P PSHU12P PSHU13P PSHU14P	
	<p>5 – Supply & Exhaust Open, Pilots Closed 6 – Supply & Pilots Closed, Exhaust Open 7 – Supply & Exhaust & Pilots Closed 8 – Supply Open, Exhaust & Pilots Closed</p>	Pilots blocked	PSHU15P PSHU16P PSHU17P PSHU18P

Pilot Exhaust Module / HA Spool Sensing

PXM Pilot Exhaust Module enables an H Series HA Single Solenoid valve to control the pilot pressure to other externally piloted H Series ISO valves in the same manifold zone. The HA valve in conjunction with the PXM will remove pilot pressure to all externally piloted valves in the manifold zone when solenoid 14 is de-energized (off). Control of all externally piloted valves in the zone is disabled for both solenoid actuation and manual override until solenoid 14 of the HA valve on the PXM is energized again (on).

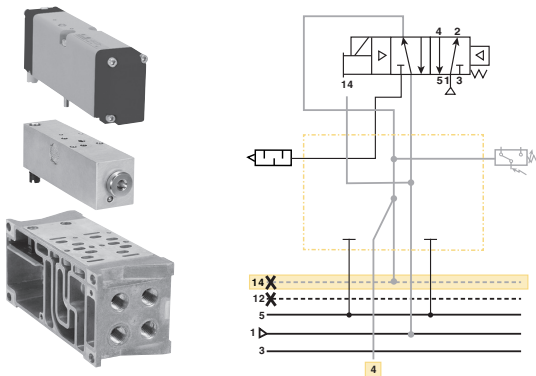

Alternatively, the HA Single Solenoid spool sensing valve can be used in place of the standard HA Valve. The spool sensing option mounts on top of the PXM and provides the added benefit of solid-state sensing of spool position to the PLC via an M8 or M12 connection. The spool sensing can be used without the PXM module for sensing only.

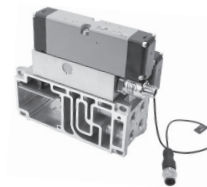
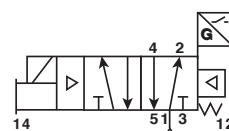

Gaskets blocking pilot pressure are required at the start of the zone the PXM is controlling. Special zoning gaskets (shown below) are available to meet any application requirement. In the example below, main pressure and exhaust pass through to the second zone, but pilot pressure is blocked. This results in the PXM providing pilot pressure for the zone after this gasket.

Part Number	Sensor Type
PS55XA0P	No sensing
PS55XM0P	Mechanical pressure switch
PS55XE0P	Solid state pressure switch

Part Number	Cable Type
RKC4.4T-2	M12 cable, PVC, 2m

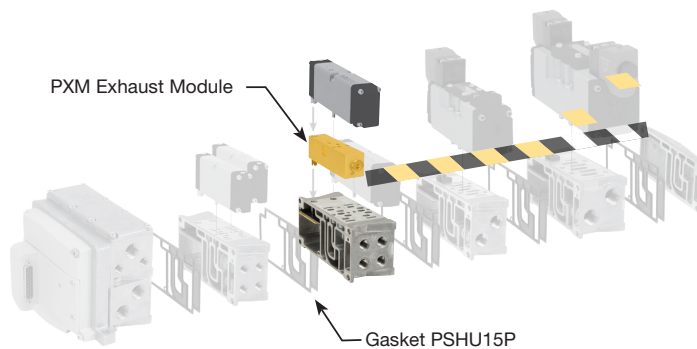

Sandwich Regulator - Non Plug-in, 15407-1

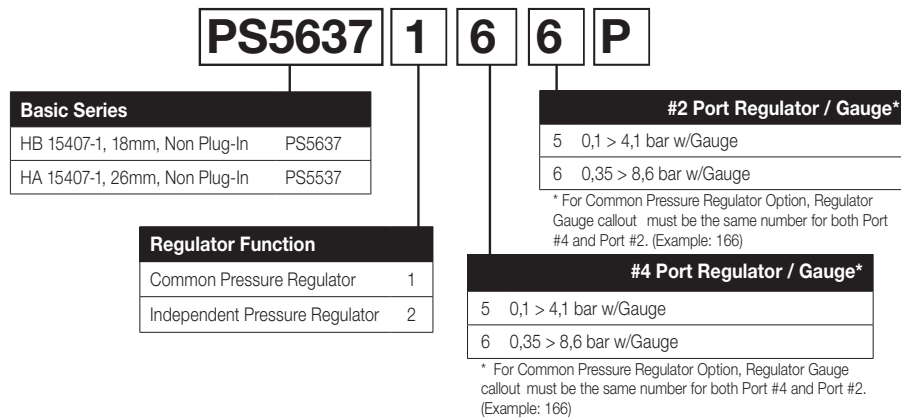

HB - 18mm
 (Independent Dual Port Regulator shown)



HA - 26mm
 (Common Port Regulator shown)

Ordering Components
 Manifold or Subbase Kit required.

- Sandwich Regulator Kit configured for Internal Pilot as standard.
- Order valve as External Pilot.

How to Configure Sandwich Regulator / Valve Combinations

Internal Pilot Configuration of Sandwich Regulator HA, HB
 Pressure in Base Port 1 feeds regulator configured for Internal Pilot which feeds valve configured for External Pilot.

	Accessories	Description	Part number
	Gauge adapter kit	Includes 1/8" coupling, long nipple, and gauge	PS5651160P

Sandwich Regulator Qn (NI/mn) Flow Chart*

	Common Pressure Code 166				Dual Pressure Code 266			
	1-2	1-4	2-3	4-5	1-2	1-4	2-3	4-5*
HB	196	196	402	334	226	186	275	265
HA	402	422	854	874	412	442	667	648

* Regulator Port exhaust through Base Port 3.
 Note: All flows calculated with regulator adjusted full open.



Sandwich Regulator - Non Plug-in, 5599-1

Basic Series	
H1 5599-1, Non Plug-in	PS4037
H2 5599-1, Non Plug-in	PS4137

Regulator Function	
Common Pressure Regulator	1
Independent Pressure Regulator	2

#2 Port Regulator / Gauge*	
0**	Line By-Pass Plate
4	0,05 > 2,0 bar w/Gauge
5	0,1 > 4,1 bar w/Gauge
6	0,35 > 8,6 bar w/Gauge
D	Remote Pilot ISO 2 & 3 only

* For common pressure regulator option, regulator gauge callout must be the same number for both Port #4 and Port #2. (Example: 166)

** Pressure Line by-pass option can only be used with independent pressure regulators.

#4 Port Regulator / Gauge*	
0**	Line By-Pass Plate
4	0,05 > 2,0 bar w/Gauge
5	0,1 > 4,1 bar w/Gauge
6	0,35 > 8,6 bar w/Gauge
D	Remote Pilot ISO 2 & 3 only

* For common pressure regulator option, regulator gauge callout must be the same number for both Port #4 and Port #2. (Example: 166)

** Pressure Line by-pass option can only be used with independent pressure regulators.

Ordering Components

- Sandwich regulator kit configured for internal pilot as standard.
- Order valve as external pilot.



H1 - Size 1
(Independent Dual Port Regulator shown)

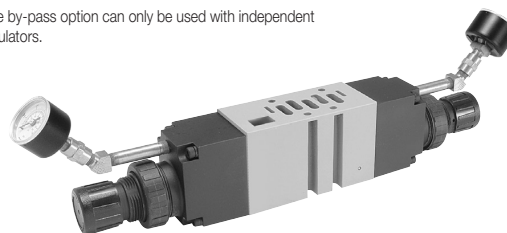

H2 - Size 2
(Independent Dual Port Regulator shown)

How to Configure Sandwich Regulator / Valve Combinations

Internal Pilot Configuration of Sandwich Regulator H1 & H2

Pressure in Base Port 1 feeds regulator configured for Internal Pilot which feeds valve configured for External Pilot.

External Pilot Configuration of Sandwich Regulator H1 & H2

An External Pilot pressure in Port 12 or 14 of the base feeds thru the Sandwich Regulator 12 or 14 galley directly to the 12/14 pilot of the valve. This configuration takes an External Pilot from the 12 port of the base and passes it thru the regulator to feed the 12 galley of the valve.

Sandwich Regulator Qn (NI/mn) Flow Chart*

	Common Pressure Code 166				Single Pressure 2 Code 206				Single Pressure 4 Code 260				Dual Pressure Code 266			
	1-2	1-4	2-3	4-5	1-2	1-4	2-3	4-5*	1-2	1-4	2-3	4-5*	1-2	1-4	2-3	4-5*
H1	609	599	1256	1158	716	942	942	913	334	687	923	962	510	471	844	864
H2	1443	1570	2365	2287	1678	1865	1492	1718	1708	1639	1698	1757	1580	1590	1472	1639

* Regulator Port exhaust through Base Port 3.

Note: All Qn's calculated with regulator adjusted full open.



Online Configuration

Navigate to the landing page

www.parker.com/pde/HSeriesISO

Customize your manifold assembly

Create and save a unique assembled part number

Generate a CAD model

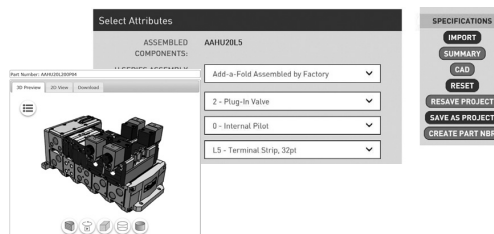

Add-A-Fold - Universal Non Plug-in

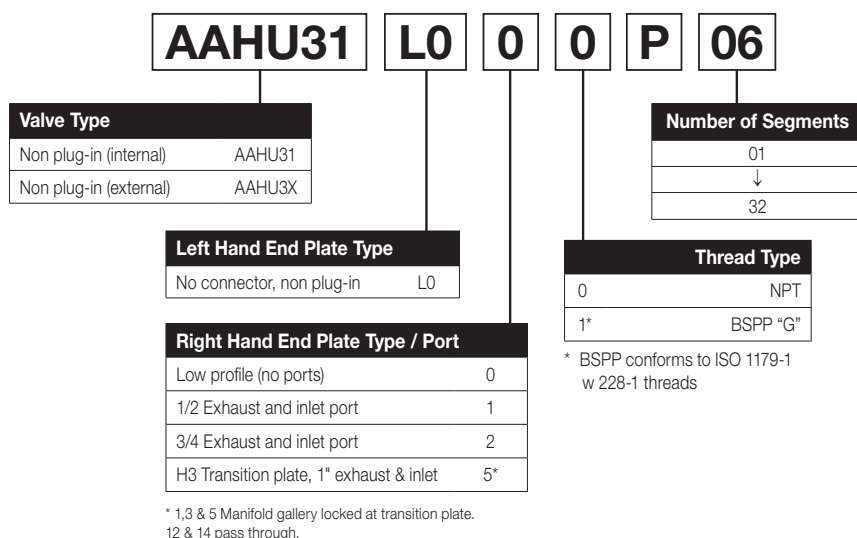

How To Order Plug-in Add-A-Fold Assemblies

- List Add-A-Fold Assembly call out. This automatically includes the end plate kit assembly.
- List complete valve, regulator, flow control and manifold base kit. List left to right, LOOKING AT THE CYLINDER PORTS on the #12 end of the manifold. The left most segment is segment 1. (If a blank station is needed, list the blanking plate part number and the individual manifold part numbers for the required segment.)

Example

Application requires a 4 segment manifold.

Item	Part No.	Location	
01	AAHU31L000P04		
02	HB2WXBG2G9000FA	Segment 1	
03	HB2WXBG2G9000FA		Valve station 2
04	PSHU115101P		Manifold base
05	HA1WXBG2G9000FA	Segment 2	
06	HA2WXBG2G9000FA		Valve station 4
07	PSHU115301P		Manifold base
08	H12WXBG2B9000FD	Segment 3	
09	PSHU115501P		Manifold base
10	H22WXBG2B9000FD	Segment 4	
11	PSHU115701P		Manifold base

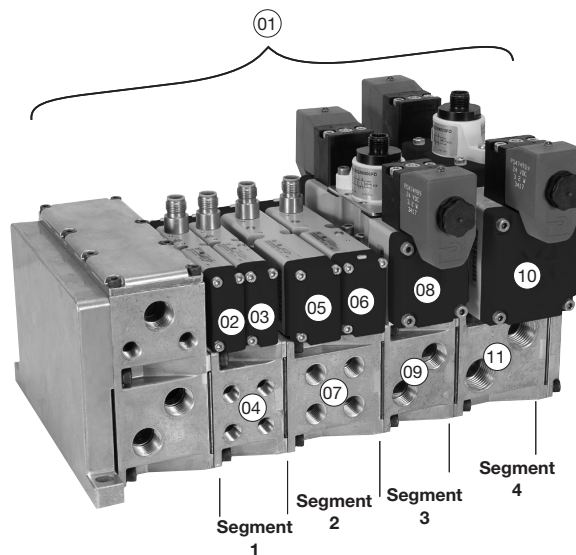

Example:
 4 segment manifold with (2) HB, (2) HA, (1) H1, and (1) H2 valve on manifold bases with low profile, NPT end plate.

Subbase Kit - Non Plug-in



HA non plug-in subbase shown

PS55 **1113** **0** **P**

Series	
HA Subbase	PS55
H1 Subbase	PS40
H2 Subbase	PS41

Engineering Level	
Blank	HA Series
D	H1 Series
C	H2 Series

Mounting Style / Port Size	
HA Series	
1/4 NPT side ports	1113
1/4 BSPP side ports	1114*
1/4 NPT bottom / side ports	1123
1/4 BSPP bottom / side ports	1124*
H1 Series	
3/8 NPT side ports	1115
3/8 BSPP side ports	1116*
H2 Series	
1/2 NPT side ports	1117
1/2 BSPP side ports	1118*

Enclosures / Lead Length	
0	None, No Electrical Plug

* BSPP conforms to ISO 1179-1 w 228-1 threads.

HB Series ISO 15407-1 Size 18 mm (HB) Single Subbase

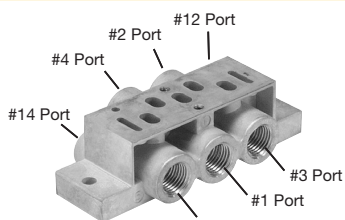

Side ported base
18 mm DX02 / HB

1/8" BSPP	1/8" NPT
PL02-01-70	PL02-01-80

Note: Can be used for external, single, or double remote pilot.

Valve with Central Connectors - 5599-1, Non Plug-in, Size 3 (H3)

Symbol	Type	Qn (Nl/mn)	Operator	Voltage	Pilot	Non-locking
4-Pin Central M12 Connector, 24 VDC						
	5/2 Elec. spring return	5900	Single solenoid	24 VDC	Internal	H3EWXBG2B9000FD
					External*	H3EWXXG2B9000FD
	5/2 Elec. air return	5900	Single solenoid	24 VDC	Internal	H31WXBG2B9000FD
					External*	H31WXXG2B9000FD
	5/2 dual Elec.	5900	Double solenoid	24 VDC	Internal	H32WXBG2B9000FD
					External*	H32WXXG2B9000FD
	5/3 dual Elec., all ports blocked	4900	Double solenoid	24 VDC	Internal	H35WXBG2B9000FD
					External*	H35WXXG2B9000FD
	5/3 dual Elec., center exhaust	4900	Double solenoid	24 VDC	Internal	H36WXBG2B9000FD
					External*	H36WXXG2B9000FD
	5/3 dual Elec., pressure center	4900	Double solenoid	24 VDC	Internal	H37WXBG2B9000FD
					External*	H37WXXG2B9000FD

Valve with 3-Pin DIN Connectors - 5599-1, Non Plug-in, Size 3 (H3)



Symbol	Type	Qn (Nl/mn)	Operator	Voltage	Pilot	Non-locking
3-Pin DIN Connector on Coil, 24 VDC						
	5/2 Elec. spring return	5900	Single solenoid	24 VDC	Internal	H3EWXBBL49D
					External*	H3EWXXBL49D
	5/2 Elec. air return	5900	Single solenoid	24 VDC	Internal	H31WXBBL49D
					External*	H31WXXBL49D
	5/2 dual Elec.	5900	Double solenoid	24 VDC	Internal	H32WXBBL49D
					External*	H32WXXBL49D
	5/3 dual Elec., all ports blocked	4900	Double solenoid	24 VDC	Internal	H35WXBBL49D
					External*	H35WXXBL49D
	5/3 dual Elec., center exhaust	4900	Double solenoid	24 VDC	Internal	H36WXBBL49D
					External*	H36WXXBL49D
	5/3 dual Elec., pressure center	4900	Double solenoid	24 VDC	Internal	H37WXBBL49D
					External*	H37WXXBL49D

* Used with H Universal Manifold, "Internal / External" defined from the H Universal Supply module (see page 55)







Most Popular

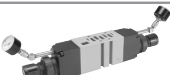

Base / End Plate - 5599-1, Non Plug-in, Size 3 (H3) * Not compatible with H Universal

	Description	BSPP
 Single subbase	Side ported base, 3/4" port	PS4211180CP
 Manifold base	End ported bases	PS4211500CP
	Bottom / end ported bases Note: Manifolds include 2 pipe plugs	PS4211600CP
 End plate	End plate - non-collective wiring	PS4231011DP

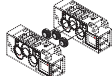
Accessories - 5599-1, Non Plug-in, Size 3 (H3)

Accessory	Description	Part number
 Sandwich regulator	Common pressure 0,35 > 8,6 bar w/ gauge	PS4237166CP
	Independent pressure 0,35 > 8,6 bar w/ gauge	PS4237266CP
 Blanking plate kit		PS4234CP
 Sandwich flow control		PS4242CP
	Sandwich Flow Control and Common Port Sandwich Regulator may be sandwiched together on a manifold or subbase. The Sandwich Flow Control MUST be located between the manifold/subbase and the Common Port Sandwich Regulator.	
 Manifold to manifold gasket kits		PS4213P
 Manifold port isolation kit	Main galley (1, 3, 5)	PS4232CP
 Manifold port isolation kit	Pilot galley (12, 14)	PS4033CP

Most Popular



Valve Central Connector - Non Plug-in, 5599-1, Size 3 (H3)

H3 **E** **WX** **B** **G** **2B9** **000F** **D**

Basic Series 5599-1
ISO 5599-1 Size 3 H3

5599-1 Operator / Function

5/2 Elec. air return	1
5/2 dual Elec.	2
5/3 dual Elec., all ports blocked	5
5/3 dual Elec., center exhaust	6
5/3 dual Elec., pressure center	7
5/2 Elec. spring return	E

5599-1 Mounting
Valve less base WX

5599-1 Pilot Source / Pilot Exhaust

Internal pilot, port #1 / vented	B
External pilot, port #12 or #14 / vented	X*

* Must be specified when using Sandwich Regulators.

5599-1 Overrides / Lights

Non-locking, flush, with light	G
Locking, flush, with light	H

5599-1 Engineering Level
D Current

5599-1 Central Connector Wiring Options

000C	Chrysler
000F*	SAE / Ford, ISO 20401
000G	General Motors

* Complies to ISO 20401 with Enclosure Lead Length *2*.

Enclosure / Lead length / Voltage*

	AC		DC	
	60Hz	50Hz		
1B9 [†]			24	3-pin, central mini connector, 3.2 watt
1F9 [†]			24	3-pin, central mini connector, 1.3 watt
123 [†]	120	115		3-pin, central mini connector
2B9			24	4-pin, central M12 connector, 3.2 watt
2F9 [†]			24	4-pin, central M12 connector, 1.3 watt
3B9			24	5-pin, central mini connector, 3.2 watt
3F9 [†]			24	5-pin, central mini connector, 1.3 watt
323	120	115		5-pin, central mini connector
619 [†]			24	2-pin, M12 connector on coil

* All coils include LED & suppression
[†] Operator function *1* or *E*
[‡] Only available with wiring option *000F*
^{*} Override *G* only.

Valve CNOMO - Non Plug-in, 5599-1 Size 3 (H3)

H3 **E** **WX** **B** **B** **L53** **D**

Basic Series 5599-1
ISO 5599-1 Size 3 H3

5599-1 Operator / Function

5/2 Elec. air return	1
5/2 dual Elec.	2
5/3 dual Elec., all ports blocked	5
5/3 dual Elec., center exhaust	6
5/3 dual Elec., pressure center	7
5/2 Elec. spring return	E

5599-1 Mounting
Valve less base WX

5599-1 Pilot Source / Pilot Exhaust

Internal pilot, port #1 / vented	B
External pilot, port #12 or #14 / vented	X*

* Must be specified when using Sandwich Regulators.

5599-1 Engineering Level
D Current

Enclosure / Lead Length / Voltage

	AC		DC	
	60Hz	50Hz		
L42	24			3-pin, 30mm DIN 43650A with CNOMO connector
L45			12	3-pin, 30mm DIN 43650A with CNOMO connector
L49			24	3-pin, 30mm DIN 43650A with CNOMO connector
L53	120	115		3-pin, 30mm DIN 43650A with CNOMO connector
L57	240			3-pin, 30mm DIN 43650A with CNOMO connector
NXX				Valve less coil

5599-1 Overrides / Lights

B	Non-locking, flush, push - no light
C	Locking, flush, push / turn - no light

Most Popular



Remote Pilot - Size 3 (H3)

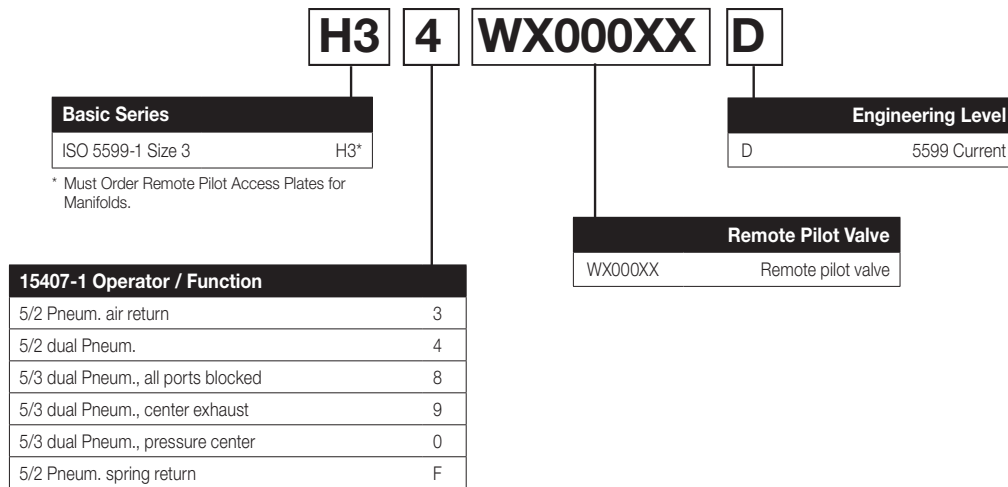

Note: For manifolds, end plates, and accessories, see 5599-1 Non Plug-in valve section.

Remote Pilot Access Plate Kits

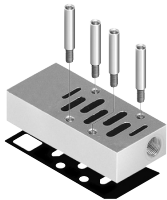

Size	Port size	BSPP "G"	NPT
H3	1/8"	PS421501CP	PS421500CP

Kit includes: Pilot Port Access Plate, Gasket and Mounting Studs.

Manifold / Subbase Kit - Non Plug-in, 5599-1, Size 3 (H3)

PS421159 0 C P

Mounting Base Style / Port Size	
Subbase: 3/4 NPT side ports	PS421119
Subbase: 3/4 BSPP side port	PS421110*
Manifold: 3/4 NPT End port	PS421159
Manifold: 3/4 BSPP end port	PS421150*
Manifold: 3/4 NPT bottom / end port	PS421169
Manifold: 3/4 BSPP bottom / end port	PS421160*

Engineering Level	
C	H3

Enclosures / Lead Length	
0	None, No Electrical Plug - 5599-1

* BSPP conforms to ISO 1179-1 w 228-1 threads.

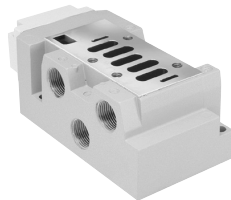

H3 Subbase shown



H3 Manifold shown

End Plate Kit - Non-Plug-in, 5599-1 * Not compatible with H Universal

PS423101 0 D P

Basic Series	
ISO 5599, Size 3	PS423101

Thread Type	
0	NPT
1*	BSPP "G"

* BSPP conforms to ISO 1179-1 w 228-1 threads.

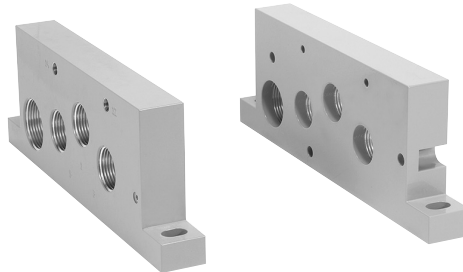

H3 Non-Collective Wiring End Plates shown

Most Popular



Add-A-Fold Assembly - Non Plug-in, 5599-1, Size 3 (H3) * Not compatible with H Universal

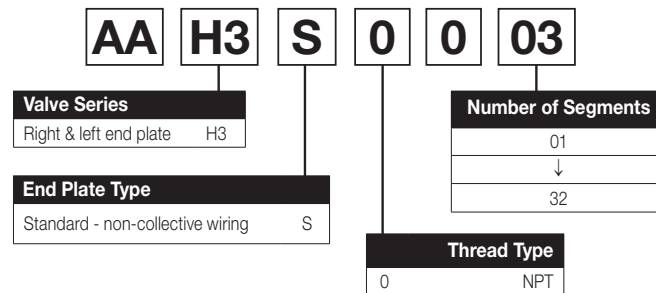

How To Order Non Plug-in Add-A-Fold Assemblies

1. List Add-A-Fold Assembly call out. This automatically includes the end plate kit assembly.
2. List complete valve, regulator, flow control and manifold base kit. List left to right, **LOOKING AT THE CYLINDER PORTS** on the #12 end of the manifold. The left most segment is segment 1. (If a blanking plate is needed, list the blanking plate part number and the individual manifold part numbers for the required segment.)

Example

Application requires a 3 segment manifold and regulator on segment 3.

Item	Part No.	Location	
01	AAH3S003		
02	H31WXBG2B9000FD	Segment 1	Valve station 1
03	PS4211590CP		Manifold base
04	H32WXBG2B9000FD	Segment 2	Valve station 2
05	PS4211590CP		Manifold base
06	H32WXXG2B9000FD	Segment 3	Valve station 3
07	PS4237166CP		Sandwich regulator
08	PS4211590CP	Manifold base	

NOTE: Construct manifold assemblies from left to right while looking at the cylinder ports.
 Valves must be ordered as External Pilot when using Sandwich Regulator.

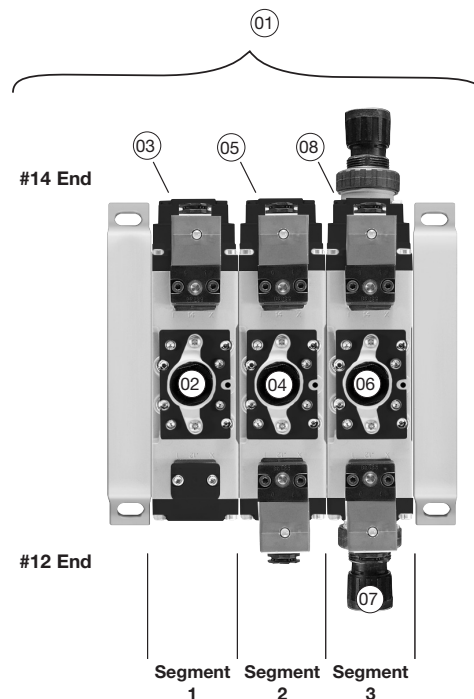

Example:
 3 segment manifold with (3) H3 valves on manifold bases and regulator at segment 3.

Sandwich Regulator - Non Plug-in, 5599-1, Size 3 (H3)

PS4237
1
6
6
C
P

Basic Series	
H3 5599-1, Non Plug-in	PS4237

Regulator Function	
Common Pressure Regulator	1
Independent Pressure Regulator	2

#2 Port Regulator / Gauge*	
0**	Line By-Pass Plate
4	0,05 > 2,0 bar w/Gauge
5	0,1 > 4,1 bar w/Gauge
6	0,35 > 8,6 bar w/Gauge
D	Remote Pilot ISO 2 & 3 only

* For common pressure regulator option, regulator gauge callout must be the same number for both Port #4 and Port #2. (Example: 166)
** Pressure line by-pass option can only be used with independent pressure regulators.

#4 Port Regulator / Gauge*	
0**	Line By-Pass Plate
4	0,05 > 2,0 bar w/Gauge
5	0,1 > 4,1 bar w/Gauge
6	0,35 > 8,6 bar w/Gauge
D	Remote Pilot ISO 2 & 3 only

* For common pressure regulator option, regulator gauge callout must be the same number for both Port #4 and Port #2. (Example: 166)
** Pressure line by-pass option can only be used with independent pressure regulators.

Ordering Components

- Sandwich regulator kit configured for internal pilot as standard.
- Order valve as external pilot.

How to Configure Sandwich Regulator / Valve Combinations

Internal Pilot Configuration of Sandwich Regulator H3
Pressure in Base Port 1 feeds regulator configured for Internal Pilot which feeds valve configured for External Pilot.

External Pilot Configuration of Sandwich Regulator H3
An External Pilot pressure in Port 12 or 14 of the base feeds thru the Sandwich Regulator 12 or 14 galley directly to the 12/14 pilot of the valve. This configuration takes an External Pilot from the 12 port of the base and passes it thru the regulator to feed the 12 galley of the valve.

Sandwich Regulator Qn (NI/mn) Flow Chart*

	Common Pressure Code 166				Single Pressure 2 Code 206				Single Pressure 4 Code 260				Dual Pressure Code 266			
	1-2	1-4	2-3	4-5	1-2	1-4	2-3	4-5*	1-2	1-4	2-3	4-5*	1-2	1-4	2-3	4-5*
H3	2326	2346	4220	4387	2326	2758	2699	2954	2601	2542	2630	2689	2385	2365	3102	2984

* Regulator Port exhaust through Base Port 3.
Note: All Qn's calculated with regulator adjusted full open.



ISO Pneumatic Valve Standard Definitions

15407-1: Non-Plug-in Standards for Size 01 (26mm) & Size 02 (18mm) Wide Valves

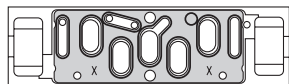

15407-2: Plug-in Standards for Size 01 (26mm) & Size 02 (18mm) Wide Valves

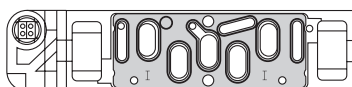

5599-1: Non-Plug-in Standards for Sizes 1, 2, 3

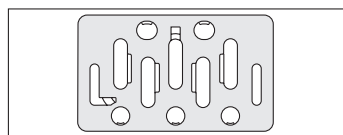

5599-2: Plug-in Standards for Size 1, 2, 3

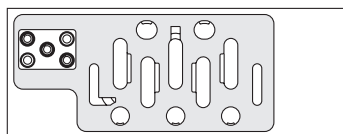

HB / HA Series

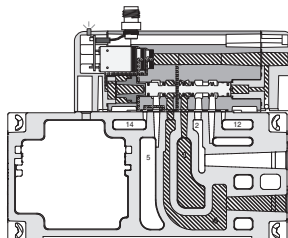

15407-1 18mm Single Solenoid Internal Pilot Manifold Mounted

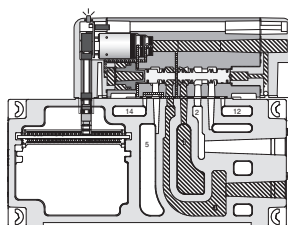

15407-2 18mm Single Solenoid Internal Pilot Manifold Mounted

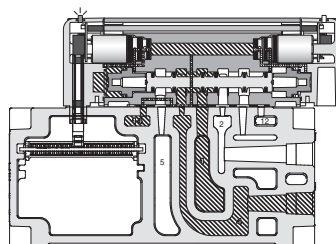

15407-2 26mm Double Solenoid External Pilot Manifold Mounted

Pressure Exhaust

H1, H2, H3 Series

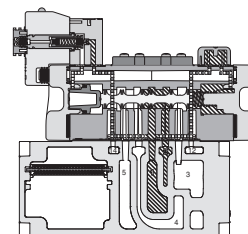

H1 5599-2 Single Solenoid Internal Pilot Manifold Mounted

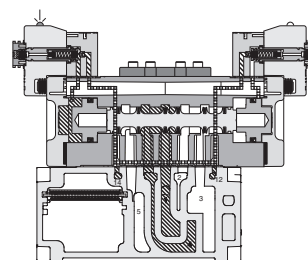

H2 5599-2 Double Solenoid External Pilot Manifold Mounted

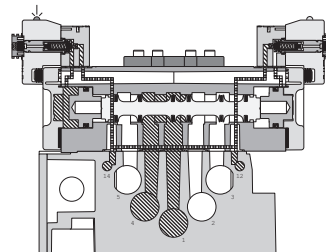

H3 5599-2 Double Solenoid External Pilot Subbase Mounted

Pressure Exhaust

Wear Compensation System

- Maximum Performance
 - Low Friction
 - Fast Response
 - Lower Operating Pressures
 - Less Wear
- Long Cycle Life - Under pressure, radial expansion of the seal occurs to maintain sealing contact with the valve bore.
- Non-Lube Service - No lubrication required for continuous valve shifting.
- Bi-Directional Spool Seals - Common spool used for any pressure, including vacuum.

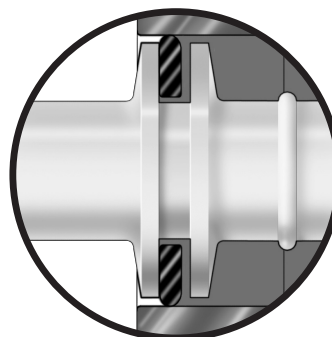

Flow Rating (Qn)

Valve size	Port size	2-Position		3-Position	
		Qn	Qmax	Qn	Qmax
HB	1/8"	Qn = 540 NI/mn Qmax = 920 NI/mn		Qn = 490 NI/mn Qmax = 830 NI/mn	
HA	1/4"	Qn = 1080 NI/mn Qmax = 1835 NI/mn		Qn = 980 NI/mn Qmax = 1670 NI/mn	
H1	3/8"	Qn = 1480 NI/mn Qmax = 2500 NI/mn		Qn = 1180 NI/mn Qmax = 2000 NI/mn	
H2	1/2"	Qn = 2950 NI/mn Qmax = 4140 l/min		Qn = 2750 NI/mn Qmax = 4670 NI/mn	
H3	3/4"	Qn = 5900 NI/mn Qmax = 10000 NI/mn		Qn = 4910 NI/mn Qmax = 8340 NI/mn	

Flow tested According to ISO 6358.

Response Time** (ms)

Valve size	Port size	0 Cu. In. Chamber		## Cu. In. Chamber	
		Fill	Exhaust	Fill	Exhaust
Single Solenoid 2-Position - Air Return / Spring Assist					
HB	1/8"	28	30	141	154
HA	1/4"	24	26	77	124
H1	3/8"	28	39	124	198
H2	1/2"	38	76	149	295
H3	3/4"	56	70	163	235
F9, 1.3 W Coil Only					
Single Solenoid 2-Position - Air Return / Spring Assist					
H1	3/8"	55	84	188	270
H2	1/2"	91	146	245	349
H3	3/4"	126	127	256	328

HB (12), HA (25), H1 (50), H2 (100), H3 (200)

** With 6,9 bar supply, time (ms) required to fill from 0 to 6,2 bar and Exhaust from 6,9 bar to 0,7 bar measured from the instant of energizing or de-energizing 24VDC solenoid.

Tested per ANSI / (NFPA) T3.21.8

Left End Plate Field Conversion

End plate kits and manifold assemblies are ordered as internal or single external pilot however field conversion is possible.

End Plate Configuration - Internal Pilot *

Insert 2 pipe plugs in locations A & B (1/8" NPT or G 1/8) as shown

Blocking off the pilot supply ports will configure the left end plate as internally piloted. Pilot pressure required to operate the H Series valves will be drawn from the supply or #1 port and no additional connections are required. Port locations C & D must be left unplugged for this option to function properly.

End Plate Configuration - Single External Pilot *

Insert 1 pipe plug into location C (1/4" NPT) as shown to configure the left end plate as single externally piloted.

Pilot pressure required to operate the H Series valves must be supplied to the 14 port only at location A which is internally connected to the 12 pilot.

End Plate Configuration - Double External Pilot

Insert 2 pipe plugs in locations C & D (1/4" NPT) as shown to configure the left end plate as double externally piloted.

Pilot pressure required to operate the H Series valves must be supplied separately to both ports 14 and 12 (locations A and B).

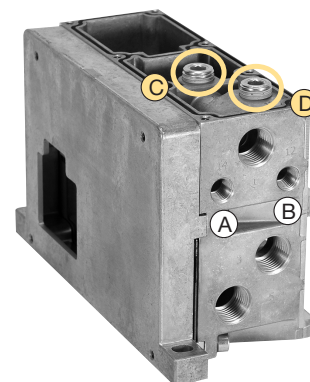
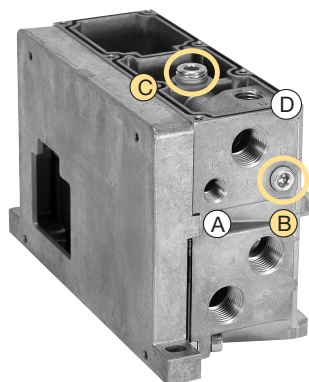
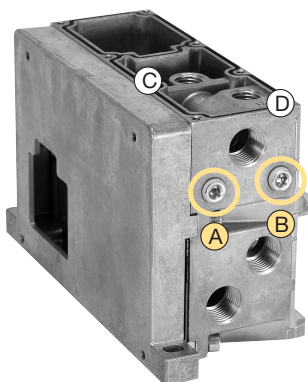

* Standard in catalog

Note: Left end plate shown with cover removed.

Common Port Regulation - Plug-in, HB & HA

Provides adjustable regulated air pressure to the valve's #1 port which gives the same pressure to both the #2 and #4 port of the manifold or subbase. The regulator is always on the 14 end of the valve.

HB Common Port Regulator Shown - Single Solenoid, 14 Energized

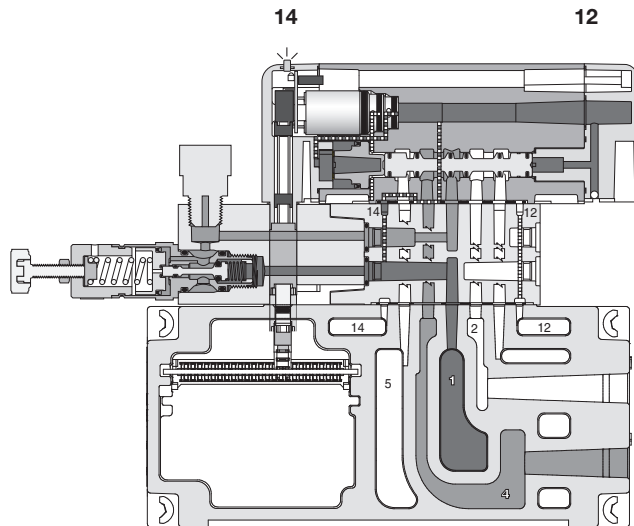
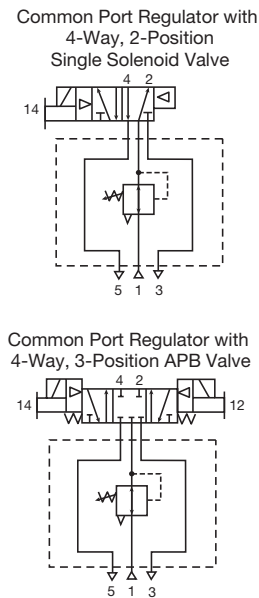

Independent Dual Port Regulation - Plug-in, HB & HA

Dual Port Regulator

Provides regulated pressure to both ports. Pressure regulation can occur out of the #2 or #4 port of the valve.

HB Independent Dual Port Regulator Shown - Double Solenoid, 14 Energized

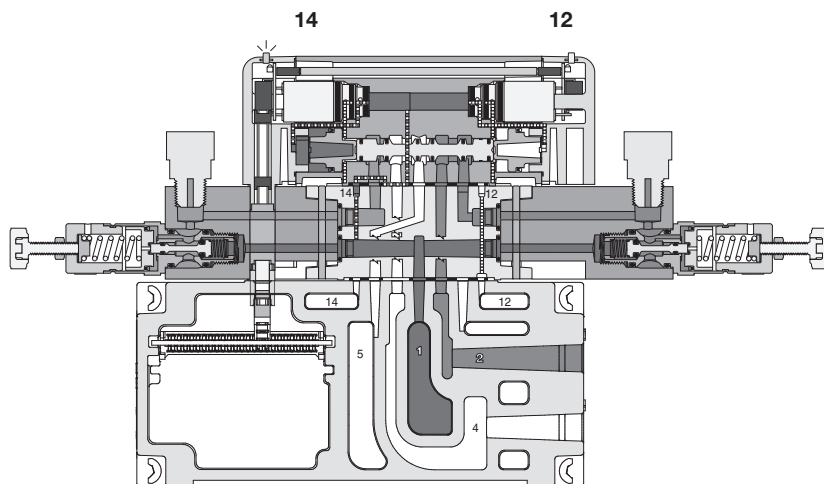
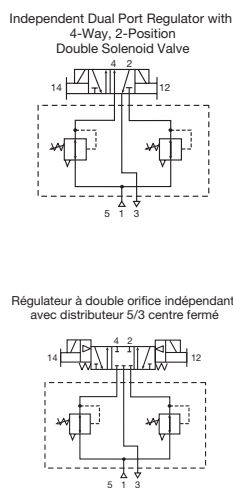

When using an Independent Pressure Sandwich Regulator, the cylinder outlet ports are reversed. The 12 end energizes the #4 port and the 14 end energizes the #2 port. The 3-Position CE and PC functions are also reversed. (See schematics above.)



Common Port Regulation - Non Plug-in, HB & HA

Provides adjustable regulated air pressure to the valve's #1 port which gives the same pressure to both the #2 and #4 port of the manifold or subbase. The regulator is always on the 14 end of the valve.

HB Common Port Regulator Shown - Single Solenoid, 14 Energized

Common Port Regulator with 4-Way, 2-Position Single Solenoid Valve

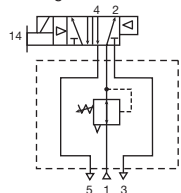

Common Port Regulator with 4-Way, 3-Position APB Valve

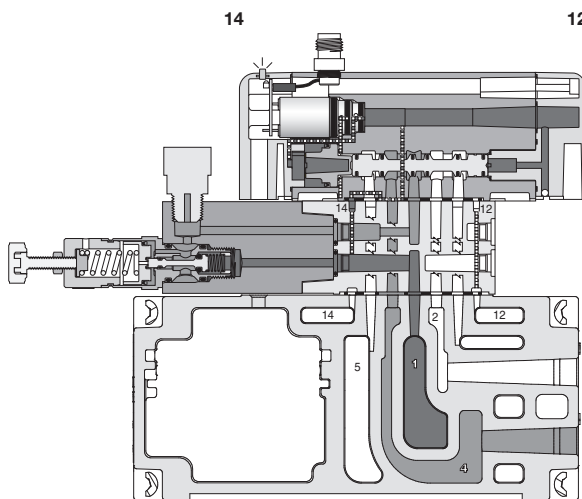
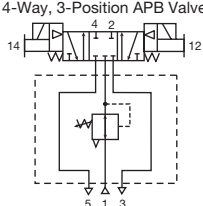

Independent Dual Port Regulation - Non Plug-in, HB & HA

Dual Port Regulator

Provides regulated pressure to both ports. Pressure regulation can occur out of the #2 or #4 port of the valve.

HB Independent Dual Port Regulator Shown - Double Solenoid, 14 Energized

Independent Dual Port Regulator with 4-Way, 2-Position Double Solenoid Valve

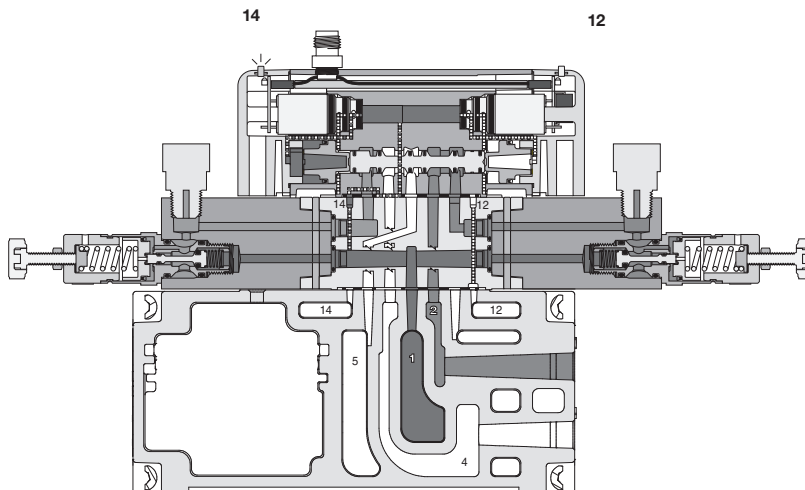
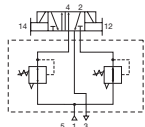

When using an Independent Pressure Sandwich Regulator, the cylinder outlet ports are reversed. The 12 end energizes the #4 port and the 14 end energizes the #2 port. The 3-Position CE and PC functions are also reversed. (See schematics on above.)

Common Port Regulation - Plug-in, H1, H2, H3

Provides adjustable regulated air pressure to the valve's #1 port which gives the same regulated pressure to both the #2 and #4 port of the manifold or subbase. The regulator is always on the 14 end of the valve.

Common Port Regulator with 4-Way, 2-Position Single Solenoid Valve

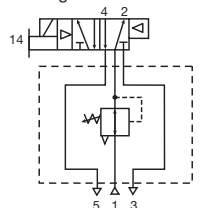

Common Port Regulator with 4-Way, 3-Position APB Valve

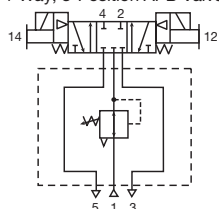

H2 Common Port Regulator Shown - Double Solenoid, 14 Energized, Internal Pilot

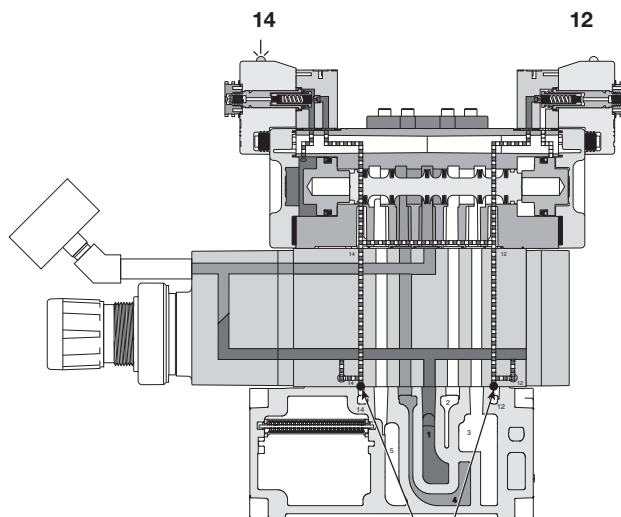

Sandwich Regulator has standard configuration of Internal Pilot with the Pilot Plug in the bottom of the I & E Pilot Holes which prevents line pressure from escaping through the manifold.

Independent Port Regulation - Plug-in, H1, H2, H3

Single Port Regulator

Provides regulated pressure to one of the ports and full line pressure to the other by use of the Line Pressure By-Pass Plate. Pressure regulation can occur out of the #4 port of the valve.

Independent Port Regulator with 4-Way, 3-Position All Ports Blocked Valve

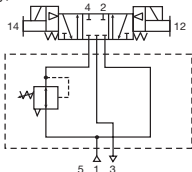

Independent Port Regulator with 4-Way, 3-Position, Inlet to Cylinder Function

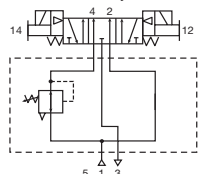

Independent Port Regulator with 4-Way, 3-Position, Cylinder to Exhaust Function

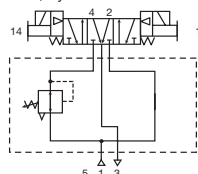

⚠CAUTION: Requires 4-Way, 3-Position, Cylinder to Exhaust Valve

⚠CAUTION: Requires 4-Way, 3-Position, Inlet to Cylinder Valve

H1 Independent Port Regulator Shown - Double Solenoid, De-energized, Internal Pilot

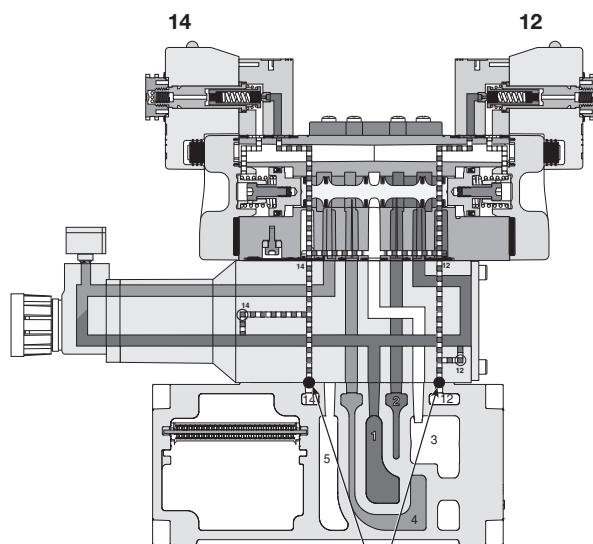

Sandwich Regulator has standard configuration of Internal Pilot with the Pilot Plug in the bottom #12 and #14 Pilot Hole which prevents line pressure from escaping through the manifold.

When using an Independent Pressure Sandwich Regulator, the cylinder outlet ports are reversed. The 12 end energizes the #4 port and the 14 end energizes the #2 port. The 3-Position CE and PC functions are also reversed. (See schematics above.)

Independent Dual Port Regulation - Plug-in, H1, H2, H3

Dual Port Regulator

Provides regulated pressure to both ports. Pressure regulation can occur out of the #2 or #4 port of the valve.

H1 Independent Dual Port Regulator Shown - Double Solenoid, 14 Energized, Internal Pilot

Independent Dual Port Regulator with 4-Way, 2-Position Double Solenoid Valve

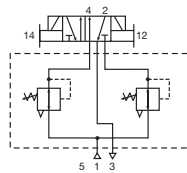

Independent Dual Port Regulator with 4-Way, 3-Position Double Solenoid Valve

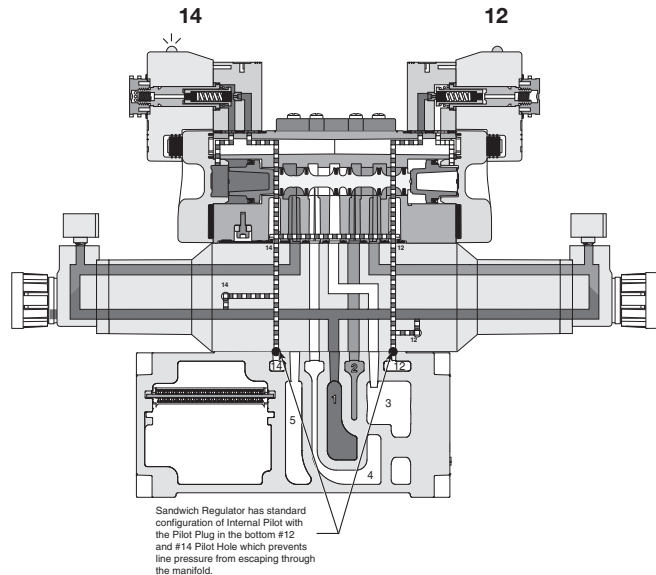
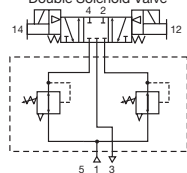

When using an Independent Pressure Sandwich Regulator, the cylinder outlet ports are reversed. The 12 end energizes the #4 port and the 14 end energizes the #2 port. The 3-Position CE and PC functions are also reversed. (See schematics on above.)

Common Port Regulation - Non Plug-in, H1, H2, H3

Provides adjustable regulated air pressure to the valve's #1 port which gives the same regulated pressure to both the #2 and #4 port of the manifold or subbase. The regulator is always on the 14 end of the valve.

Common Port Regulator with 4-Way, 2-Position Single Solenoid Valve

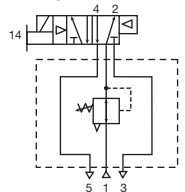

Common Port Regulator with 4-Way, 3-Position APB Valve

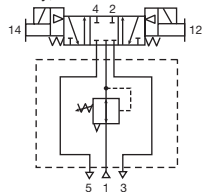

H2 Common Port Regulator Shown - Double Solenoid, 14 Energized, Internal Pilot

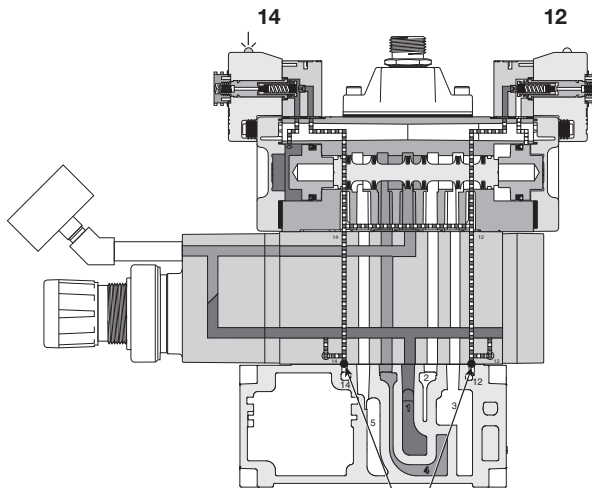

Sandwich Regulator has standard configuration of Internal Pilot with the Pilot Plug in the bottom of the I & E Pilot Holes which prevents line pressure from escaping through the manifold.

Independent Port Regulation - Non Plug-in, H1, H2, H3

Single Port Regulator

Provides regulated pressure to one of the ports and full line pressure to the other by use of the Line Pressure By-Pass Plate. Pressure regulation can occur out of the #4 port of the valve.

Independent Port Regulator with 4-Way, 3-Position All Ports Blocked Valve

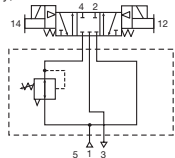

Independent Port Regulator with 4-Way, 3-Position, Inlet to Cylinder Function

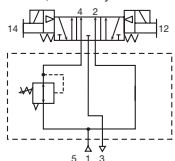

CAUTION: Requires 4-Way, 3-Position, Cylinder to Exhaust Valve

Independent Port Regulator with 4-Way, 3-Position, Cylinder to Exhaust Function

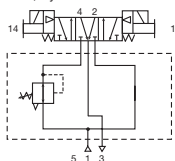

CAUTION: Requires 4-Way, 3-Position, Inlet to Cylinder Valve

H1 Independent Port Regulator Shown - Double Solenoid, De-energized, Internal Pilot

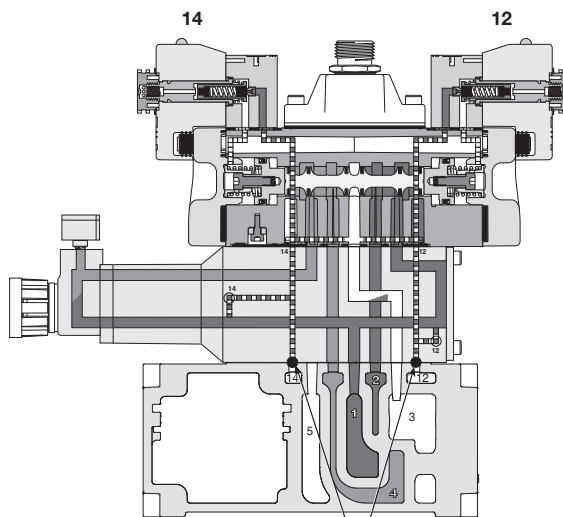

Sandwich Regulator has standard configuration of Internal Pilot with the Pilot Plug in the bottom #12 and #14 Pilot Hole which prevents line pressure from escaping through the manifold.

Independent Dual Port Regulation - Non Plug-in, H1, H2, H3

Dual Port Regulator

Provides regulated pressure to both ports. Pressure regulation can occur out of the #2 or #4 port of the valve.

H1 Independent Dual Port Regulator Shown - Double Solenoid, 14 Energized, Internal Pilot

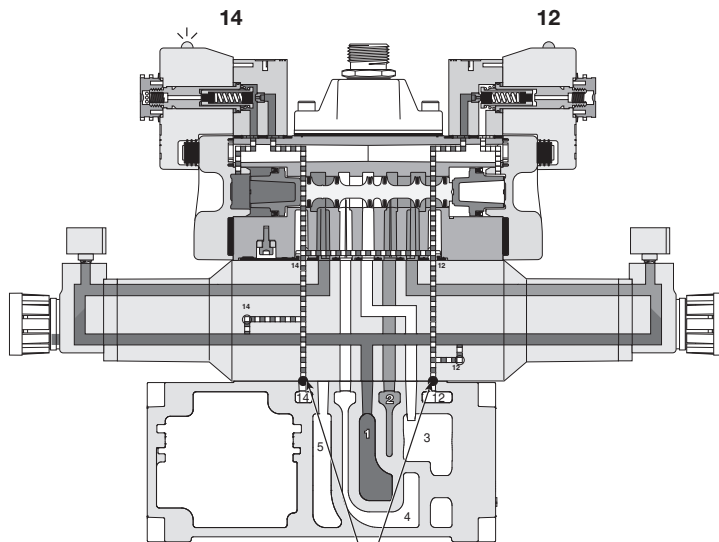
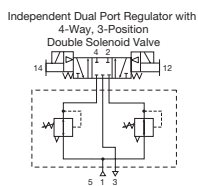
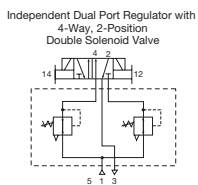

Sandwich Regulator has standard configuration of Internal Pilot with the Pilot Plug in the bottom #12 and #14 Pilot Hole which prevents line pressure from escaping through the manifold.

When using an Independent Pressure Sandwich Regulator, the cylinder outlet ports are reversed. The 12 end energizes the #4 port and the 14 end energizes the #2 port. The 3-Position CE and PC functions are also reversed. (See schematics on above.)

Minimum Operating Voltage

	HB	HA	H1	H2	H3
MOV (24VDC)	20.4	20.4	20.4	20.4	20.4
MOV (120VAC)	102*	102*	102	102	102

* 120VAC coils have a dropout voltage of 10VAC when used with solid state relays. A pull-down resistor may be necessary.

P2H IO-Link

Class B, M12 pin

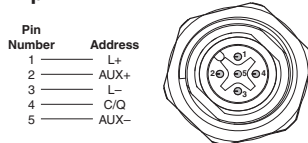

Class A, M12 pin

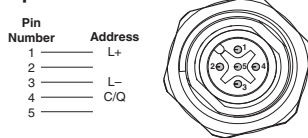

Class A, Power IN / OUT 7/8 pin

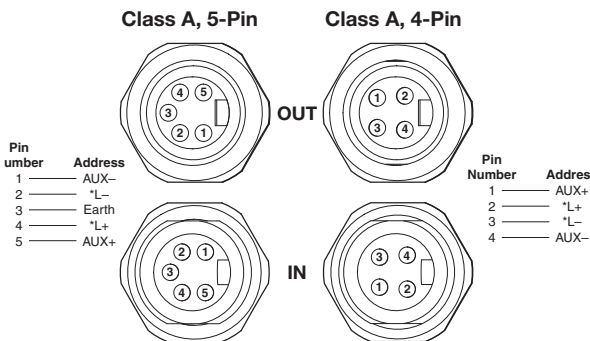

* 7/8" logic power has no connection to internal P2H unit but does carryover to OUT 7/8" connector (for jumper logic power only). Logic power for P2H unit will be supplied from M12 (pin 1 & 3).

19-Pin Connector, Round Brad Harrison

Male, face view

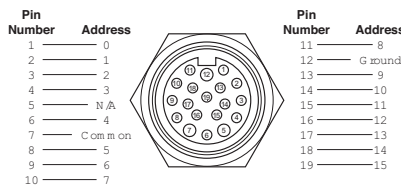

19-Pin Round Cable Specifications

Common Pin "7" is rated for 8 amps. Cable common wire must be greater than total amperage of solenoids on Add-A-Fold assembly.

Example: 8 segment manifold, 16 solenoids, 120VAC - 16 x .039 amps = .63 total amp rating.

NEMA 4 rated with properly assembled NEMA 4 rated cable.

M23, Round Connector

Male 12-pin connector, face view

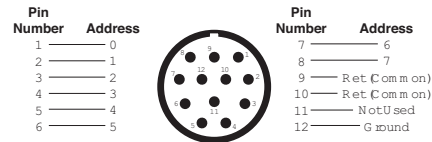

Male 19-pin connector, view into end plate

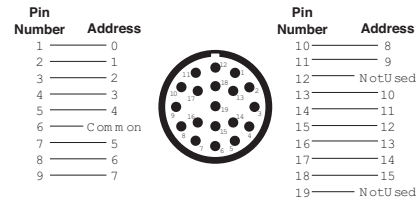

25-Pin, D-Sub Connector

Male, view into end plate connector

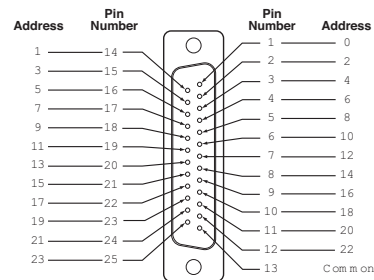

Female, view into cable connector

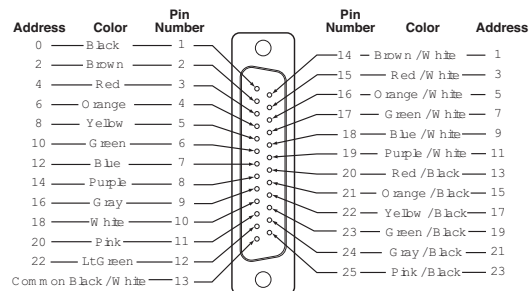

Description	Length	Part number
25-pin, D-sub cable, IP20	3 Meters	P8LMH25M3A
25-pin, D-sub cable, IP20	9 Meters	SCD259D
25-pin, D-sub cable, IP65	3 Meters	SCD253W
25-pin, D-sub cable, IP65	9 Meters	SCD259WE



Subbase Wiring

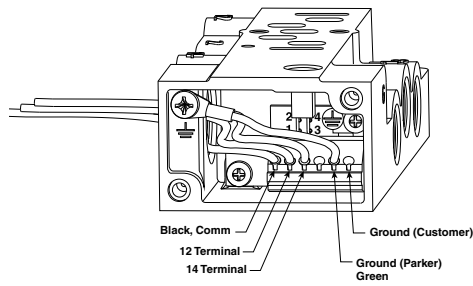

All commons internally connected on terminal strip

Connections	14 Solenoid	12 Solenoid
Valves with Wires	Black Wires	Red Wires
Valves with Terminal Block (Will accept 18 to 24 Gauge Wires)	14 and Com Terminals	12 and Com Terminals

Manifold Wiring - Size 3

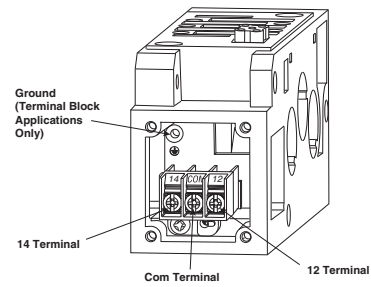

Terminal Box Wiring (H Universal)

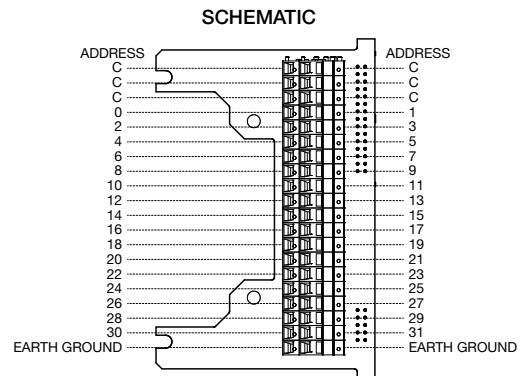
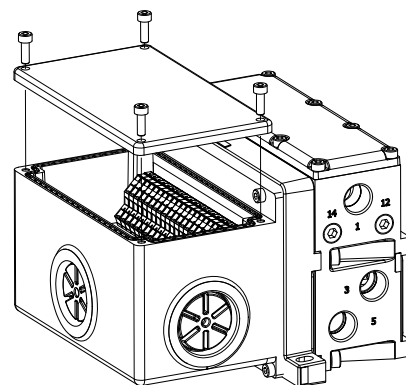
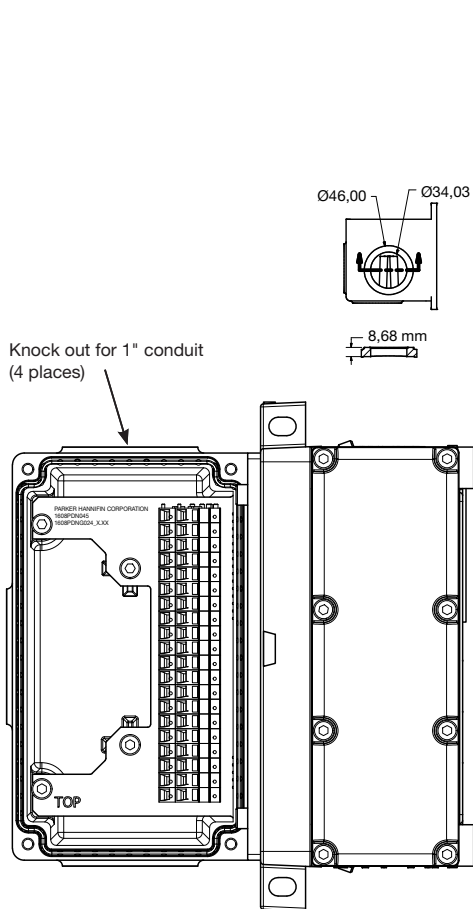

All commons internally connected on terminal strip

Electrical Connectors - Size 1, 2 & 3

5599-1 CNOMO

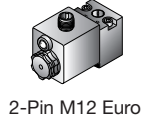
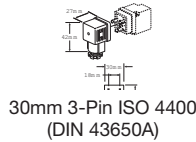

5599-2

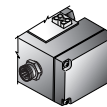

5599-1 AUTO

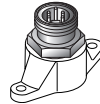
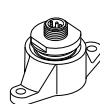

30 mm Square 3-Pin – ISO 4400, DIN 43650A (Use with Enclosure “A”)

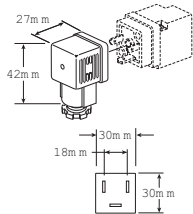

Description	Connector with 6' (2m) cord	Connector
Unlighted	PS2028JCP	PS2028BP
Light – 6-48V, 50/60Hz, 6-48VDC	PS2032J79CP*	PS203279BP
Light – 120V/60Hz	PS2032J83CP*	PS203283BP

* LED with surge suppression.
 Note: Max ø6.5 mm cable size required for connector w/o 6' (2m) cord. IP65 rated when properly installed.
 Engineering data:
 Conductors: 2 poles plus ground; cable range (connector only): 8 to 10mm (0.31 To 0.39 Inch); contact spacing: 18mm

7/8" Mini Power Cables - use with 5-pin mini connector

RKM Female Socket

RSM Male Pins

WKM Female Socket

5-Pin Female Wiring Diagram

4-Pin Female Wiring Diagram

Description	Part number
4-pin female to flying lead cable, 5 meters, TPE	RKM 46-5M/S1587
5-pin female to flying lead cable, 5 meters, TPE	RKM 56-5M/S1587
4-pin male to female cable, TPE	RSM RKM 46-x/S1587
5-pin male to female cable, TPE	RSM RKM 56-x/S1587
4-pin right angle female to flying lead cable, 5 meters, TPE	WKM 46-5M/S1587
5-pin right angle female to flying lead cable, TPE	WKM 56-5M/S1587

Where x = 2, 4, 5, 6, 8, 10 meter standard lengths

M12 A-code Cables - use with 4-pin micro, 2-pin micro

RKC Female Sockets

Female

Male

4-Pin Female Wiring Diagram

Description	Part number
4-pin female to flying lead cable, PVC	RKC 4.4T-1
4-pin male to flying lead cable, PVC	RSC 4.4T-*
4-pin male to female cable, PVC	RKC 4.4T-*/RSC 4.4T
5-pin female to flying lead cable, TPE	RKC 4.5T-*/S1587
5-pin male to flying lead cable, TPE	RSC 4.5T-4/S1587
5-pin male to female cable, TPE	RKC 4.5T-*/RSC 4.5T/S1587

Where * = 1, 2, 3, 4 meter standard lengths



Automotive Connection – Wiring Options

‘C’ Chrysler Connection

5-Pin Male / Single Solenoid
 (Encl. Option 3, Auto Option C)

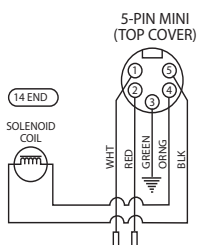

5-Pin Male / Double Solenoid
 (Encl. Option 3, Auto Option C)

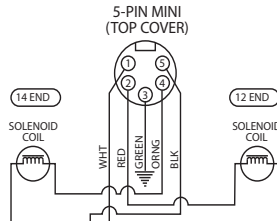

4-Pin Male / Single Solenoid
 (Encl. Option 2, Auto Option C)

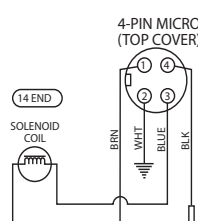

4-Pin Male / Double Solenoid
 (Encl. Option 2, Auto Option C)

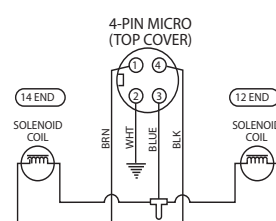

‘F’ SAE / Ford Wiring

5-Pin Male / Single Solenoid
 (Encl. Option 3, Auto Option F)

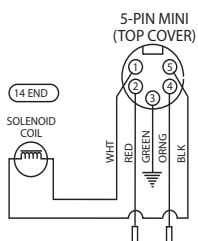

5-Pin Male / Double Solenoid
 (Encl. Option 3, Auto Option F)

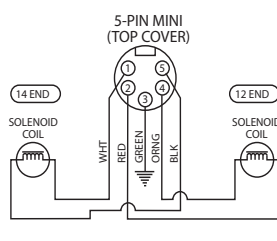

ISO 20401
4-Pin Male / Single Solenoid
 (Encl. Option 2, Auto Option F)

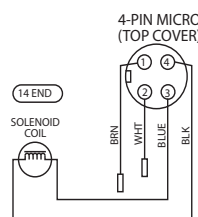

ISO 20401
4-Pin Male / Double Solenoid
 (Encl. Option 2, Auto Option F)

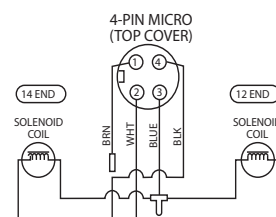

‘G’ GM Wiring

5-Pin Male / Single Solenoid
 (Encl. Option 3, Auto Option G)

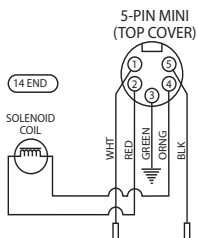

5-Pin Male / Double Solenoid
 (Encl. Option 3, Auto Option G)

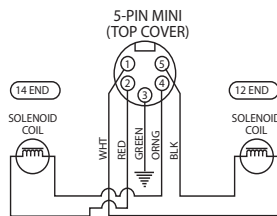

4-Pin Male / Single Solenoid
 (Encl. Option 2, Auto Option G)

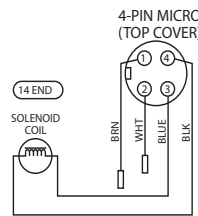

4-Pin Male / Double Solenoid
 (Encl. Option 2, Auto Option G)

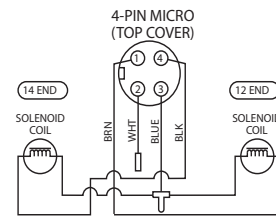

CNOMO Connection - Wiring Options

2-Pin Male / Single Solenoid
 (Encl. Option 6, Auto Option F)

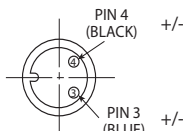

3-Pin Male / Single Solenoid
 (Encl. Option 1, Auto Options C, F & G)

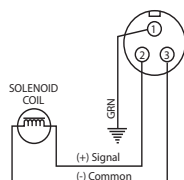

**Maximum Number of Solenoids
(Maximum energized simultaneously)**

	Voltage code	25-pin D-sub	19-pin Brad Harrison	12-Pin M23	19-pin M23	P2M Network Node	P2H Network Node	H Series Network Portal	Turck Network Portal	
									16 Outputs	32 Outputs
HA & HB										
24VDC	G9 (1.0 watt)	24 (24)	16 (16)	8 (8)	16 (16)	24 (24)	24 (24)	32 (32)	16 (16)	32 (32)
120VAC*	23 (1.0 VA)	24 (24)	16 (16)	8 (8)	16 (16)	N/A	N/A	N/A	N/A	N/A
H1, H2										
12VDC	45 (2.4 watt)	24 (13)	16 (13)	8 (8)	16 (13)	N/A	N/A	N/A	N/A	N/A
24VAC*	42 (4.0 VA)	24 (24)	16 (16)	8 (8)	16 (16)	N/A	N/A	N/A	N/A	N/A
24VDC	B9 (3.2 watt)	24 (24)	16 (16)	8 (8)	16 (16)	24 (24) ^{†§}	24 (24) [†]	32 (32)	16 (16)	32 (32)
24VDC	F9 (1.3 watt)	24 (24)	16 (16)	8 (8)	16 (16)	24 (24)	24 (24) [†]	32 (32)	16 (16)	32 (32)
120VAC*	23 (4.5 VA)	24 (24)	16 (16)	8 (8)	16 (16)	N/A	N/A	N/A	N/A	N/A
H3 Only										
12VDC	45 (2.4 watt)	24 (13)	16 (13)	8 (8)	16 (13)	N/A	N/A	N/A	N/A	N/A
24VAC*	42 (4.0 VA)	24 (24)	16 (16)	8 (8)	16 (16)	N/A	N/A	N/A	N/A	N/A
24VDC	B9 (3.2 watt)	24 (20)	16 (16)	8 (8)	16 (16)	24 (24) ^{†§}	24 (24) [†]	24 (21)	16 (16)	24 (21)
24VDC	F9 (1.3 watt)	24 (24)	16 (16)	8 (8)	16 (16)	24 (24)	24 (24) [†]	24 (24)	16 (16)	24 (24)
120VAC*	23 (4.5 VA)	24 (24)	16 (16)	8 (8)	16 (16)	N/A	N/A	N/A	N/A	N/A

* Not CSA certified for 25-pin, D-sub option.

† Use Type A IO-Link module for 24 outputs simultaneously.

§ P2M Industrial Ethernet limited to 2A, use F9 coil for more than simultaneous solenoids.

I/O Addressing Examples

HB, HA, H1, H2 - Five Segment Manifold Example

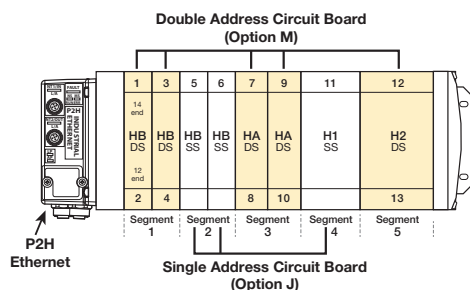

H3 Example - Six Segment Manifold Example

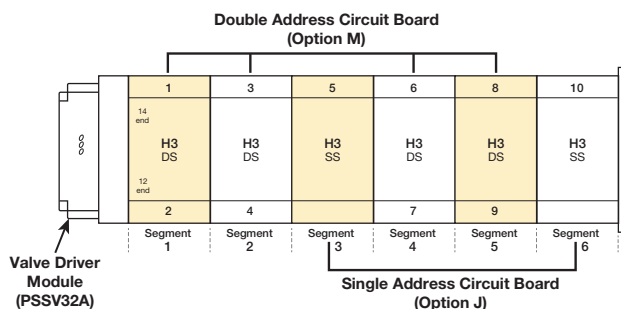

HB, HA, H1, H2 - Nine Segment Manifold with Intermediate Supply Example

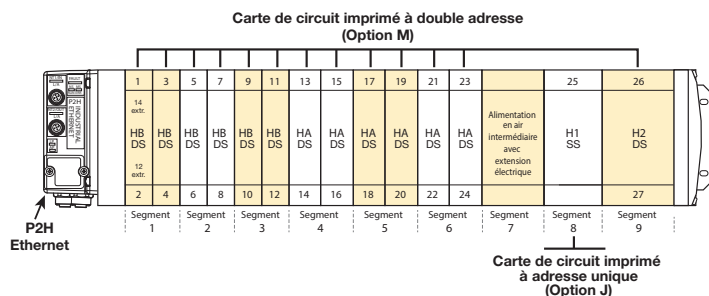

Notes: SS = Single Solenoid Valve
DS = Double Solenoid Valve
First output address is the #14 end of the valve closest to the valve driver module.

Intermediate Module with Electrical Expansion to 25th address required for manifolds with greater than 24 solenoid addresses.

5599-2 & 5599-1 AUTO Solenoid Kits

Valve size	Voltage code	Coil kit number
H1, H2 & H3	42 (24VAC)	PS404142P
	45 (12VDC)	PS404145P
	B9 (24VDC), 3.2 watt	PS4041B9P
	F9 (24VDC), 1.3 watt	PS4041F9P
	23 (120VAC)	PS404123P
	57 (240VAC)	PS404157P

Quantity 1

Pilot Operator - CNOMO

Valve size	Locking	Kit number
H1, H2 & H3	Locking	PS4052CP
	Non-locking	PS4053CP
	Non-locking †	PS4054CP

† F9 (1.3 watt) coil option only.

Manifold Hardware Kits – PS Series

Valve size	Kit number
HB, HA, H1, H2 *	PSHU10P
H3 **	PS4212P

* Quantity 20

** Quantity 12

Valve Bolt Kits

Valve size	Kit number
HB	PS5687P
HA	PS5587P
H1	PS4087DP
H2	PS4187DP
H3	PS4287DP

Quantity 12

Valve to Base Gasket Kits

Valve size	Standard	Remote pilot	Dual pressure #3	Dual pressure #5
HB	PS5605P*	—	—	—
HA	PS5505P*	—	—	—
H1	PS4005DP	PS4006DP	PS40D3DP	—
H2	PS4105DP	PS4106DP	PS41D3DP	PS41D5DP
H3	PS4205DP	PS4206DP	PS42D3DP	PS42D5DP

Quantity 1

* Quantity 10

5599-1 CNOMO Solenoid Kits

Voltage code	3-pin, 30mm 'L' coil kit	2-pin, M12 Euro '6' coil kit
19	—	PS2828619P
42	P2FCA442	—
45	P2FCA445	—
49	P2FCA449	—
53	P2FCA453	—
57	P2FCA457	—

Quantity 1

Body Service Kits



Valve size	2-position		3-position	
	APB	CE	PC	
HB	PS5601P	PS5602P	PS5603P	PS5604P
HA	PS5501P	PS5502P	PS5503P	PS5504P
H1	PS4001CP	PS4002CP	PS4003CP	PS4004CP
H2	PS4101CP	PS4102CP	PS4103CP	PS4104CP
H3	PS4201CP	PS4202CP	PS4203CP	PS4204CP

HB / HA Kit Includes: Spool assembly with seals.

H1, H2, H3 Kit Includes: Spool assembly with seals, all piston seals, return spring, pilot selector gasket, coil to end cap gasket.

Quantity 1

Pilot Select Gasket Kits

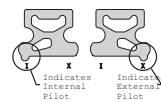
Valve size	Part number
 HB shown	PS5605P
 HA	PS5505P
 H1, H2 & H3	PS4007P

Quantity 10

Regulator Kits

Valve size	Part number
H1	PS4039P
H2, H3	PS4139P

Regulator & Flow Control Mounting Studs

Valve type	Type	Part number
HB	Flow Control & Regulator	PS5636P
HA	Flow Control & Regulator	PS5536P
H1	Flow Control	PS4036P
	Regulator	PS4040P
H2	Flow Control	PS4136P
	Regulator	PS4140P
H3	Flow Control	PS4236P
	Regulator	PS4240P

Quantity 12

Regulator Gauge Kits – Size H1, H2 & H3

Gauge type	Part number
1" Face Air - Standard	
0 to 4,1 bar	PS4051060BP
0 to 11 bar	PS4051160BP
1-1/2" Face Air - Large*	
0 to 4,1 bar	PS4053060BP
0 to 11 bar	PS4053160BP
1-1/2" Face Liquid*	
0 to 11 bar	PS4052160BP

* Includes brass pipe fitting extensions

Quantity 1

Pilot By-Pass Plate

Valve size	Part number
H1, H2, H3	PS4051CP

Quantity 10

Installation Bracket

Bracket	Part number
Bracket and Bolt (Quantity 2)	PSHU60P

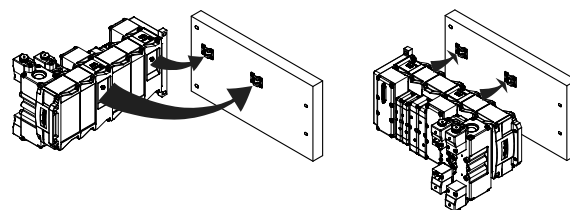

H Series ISO 15407-2, Plug-in, Size 18 mm (HB)

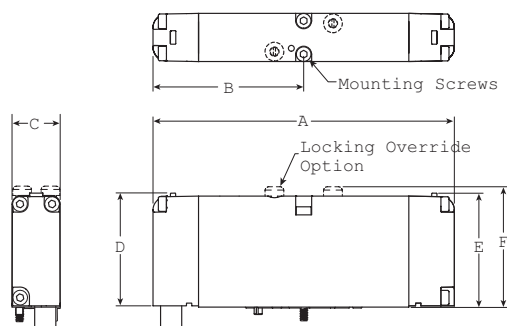

18 mm Dimensions [mm]

A	B	C	D
113	56	18	50
E	F		
43	45		

H Series ISO 15407-2, Plug-in, Size 26 mm (HA)

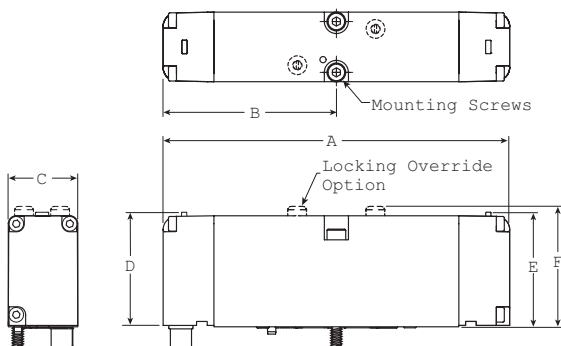

26 mm Dimensions [mm]

A	B	C	D
130	65	26	50
E	F		
43	45		

H Series ISO 15407-1, Non Plug-in, Size 18 mm (HB)

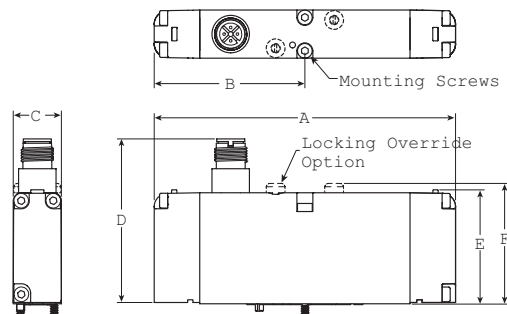

18 mm Dimensions [mm]

A	B	C	D
113	56	18	61
E	F		
43	45		

H Series ISO 15407-1, Non Plug-in, Size 26 mm (HA)

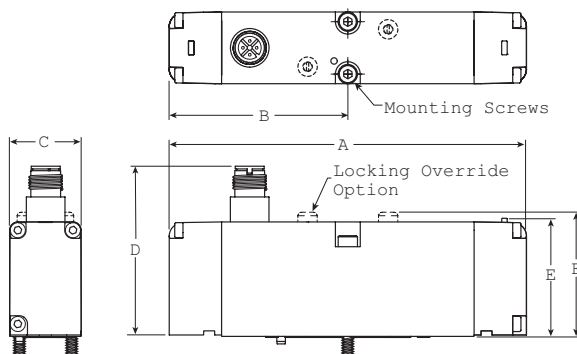

26 mm Dimensions [mm]

A	B	C	D
130	65	26	61
E	F		
43	45		

H Series ISO 5599-2

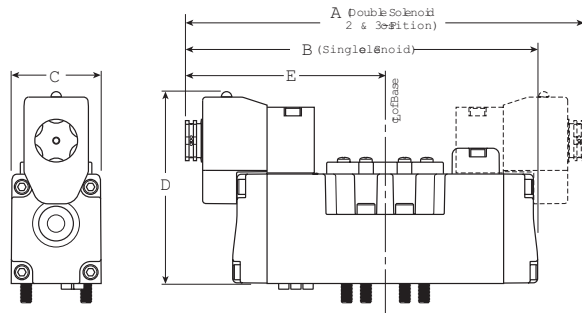

H1 Valves Shown

H1 Dimensions [mm]

A	A ₁	B	C
186	142	164	42
D	D ₁	D ₂	D ₃
90	109	109	63.5
D ₄	E	E ₁	
63	93	71	

H Series ISO 5599-1 Auto

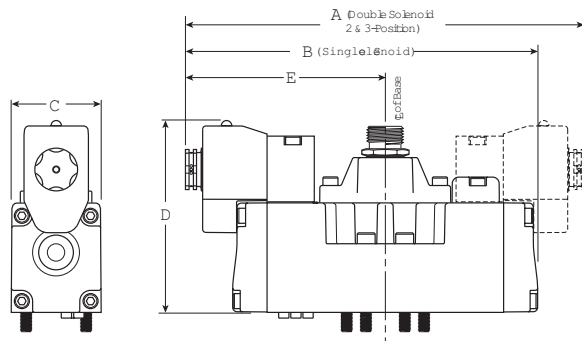

H2 Dimensions [mm]

A	A ₁	B	C
212	168	190	55
D	D ₁	D ₂	D ₃
103	122	116	76
E	E ₁		
106	84		

H Series ISO 5599-1 CNOMO

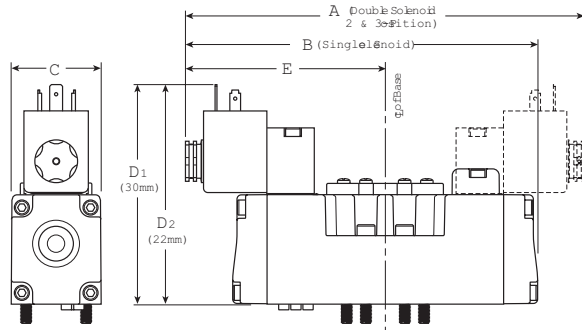

H3 Dimensions [mm]

A	A ₁	B	C
246	177	220	55
D	D ₁	D ₂	D ₃
103	122	116	76
E	E ₁		
121	89		

H Series ISO 5599-2 / 5599-1 Remote Pilot

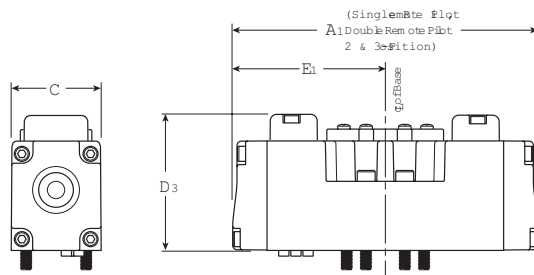

HB Series ISO 15407-1, Size 18 mm (HB) Single Subbase

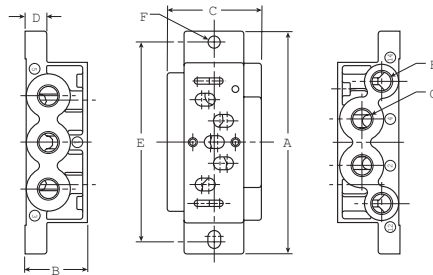

HB Dimensions (PL02) [mm]

A	B	C	D
80	22	27	8
E	F	G	H
70	Ø 5,5	1/8	M5

H Series ISO 15407-2 & 15407-1 Size 26 mm (HA), Plug-in Subbases

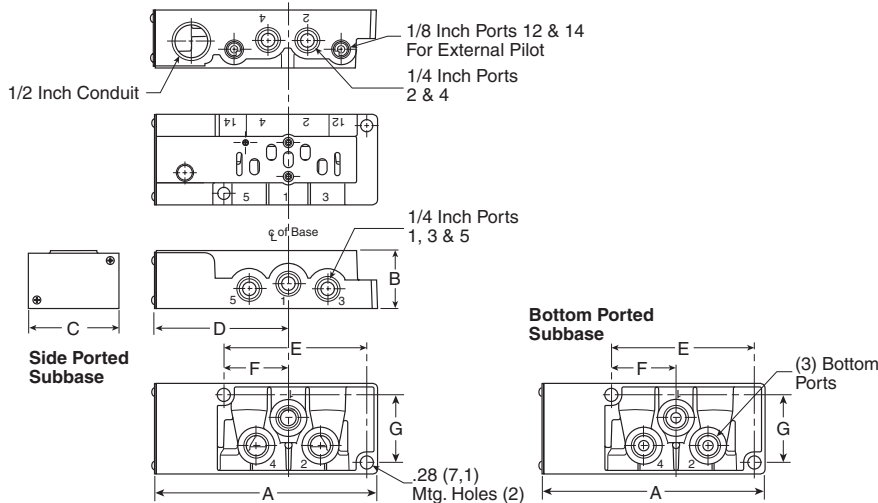

HA Dimensions [mm]

A	B	C	D
124	32,5	50,8	74
E	F	G	
36,2	80,2	37,9	

H Series ISO 5599-1 Size H1, PS4011 Subbase

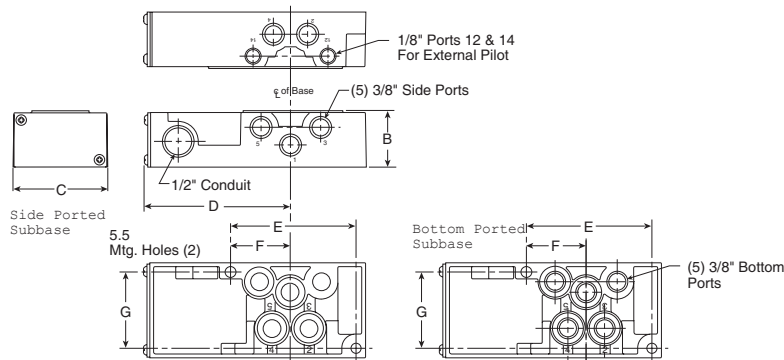

PS4011 Subbase Dimensions [mm]

A	B	C	D
148	38	64	98
E	F	G	
84	40	51	

H Series ISO 5599-1 Size H2, PS4111 Subbase

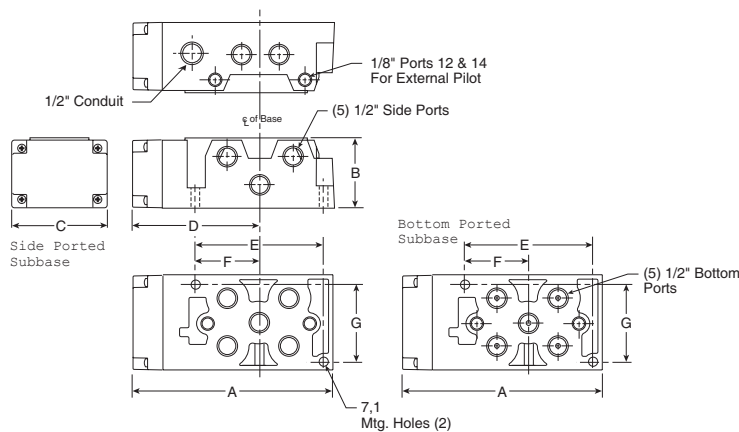

PS4111 Subbase Dimensions [mm]

A	B	C	D
170	59	80	108
E	F	G	
107	52	65	

H Series ISO 5599-1 Size H3, PS4211 Subbase

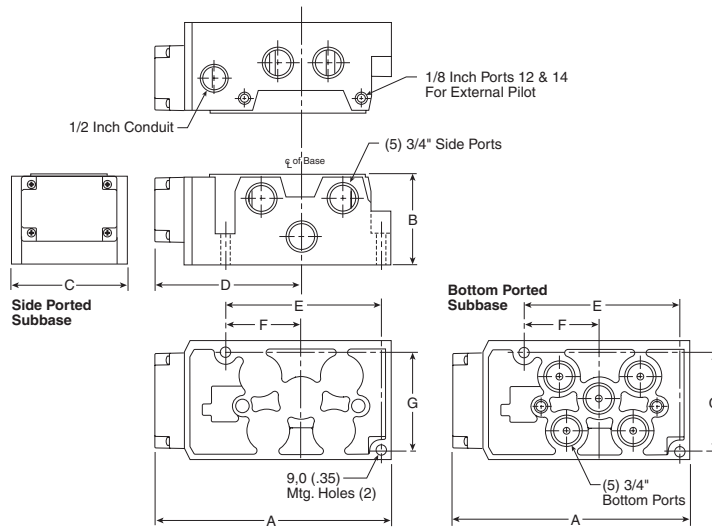

PS4211 Subbase Dimensions [mm]

A	B	C	D
201	75	99	125
E	F	G	
131	64	82	

H Series ISO 5599 Size H3, PS4211 Manifold

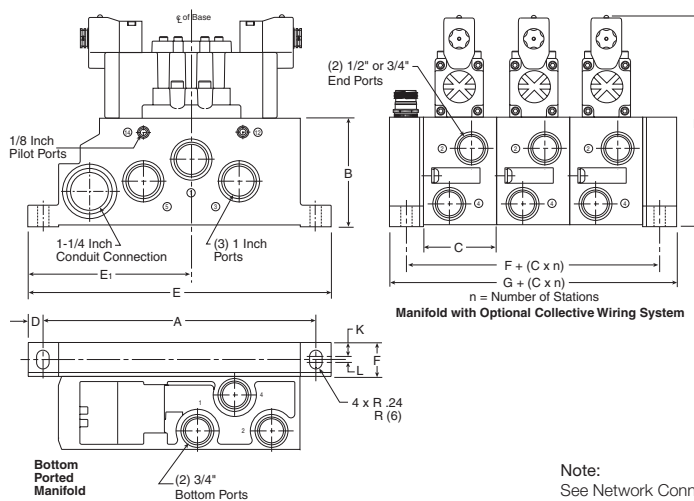

PS4211 Manifold Dimensions [mm]

A	B	C	D	E
265	105	71	15	295
E1	F	G	H	
159	33	63	208	
K	L			
13,5	6			

Note:
 See Network Connectivity Section for the dimensions of manifolds utilizing the H Series Network, Turck Network, or P2M Network Node end plate type.

H Series ISO Universal Manifold

Network Connectivity dimensions (P2H, Turck, H Net, and P2M) are located at the end of the Network Connectivity Section.

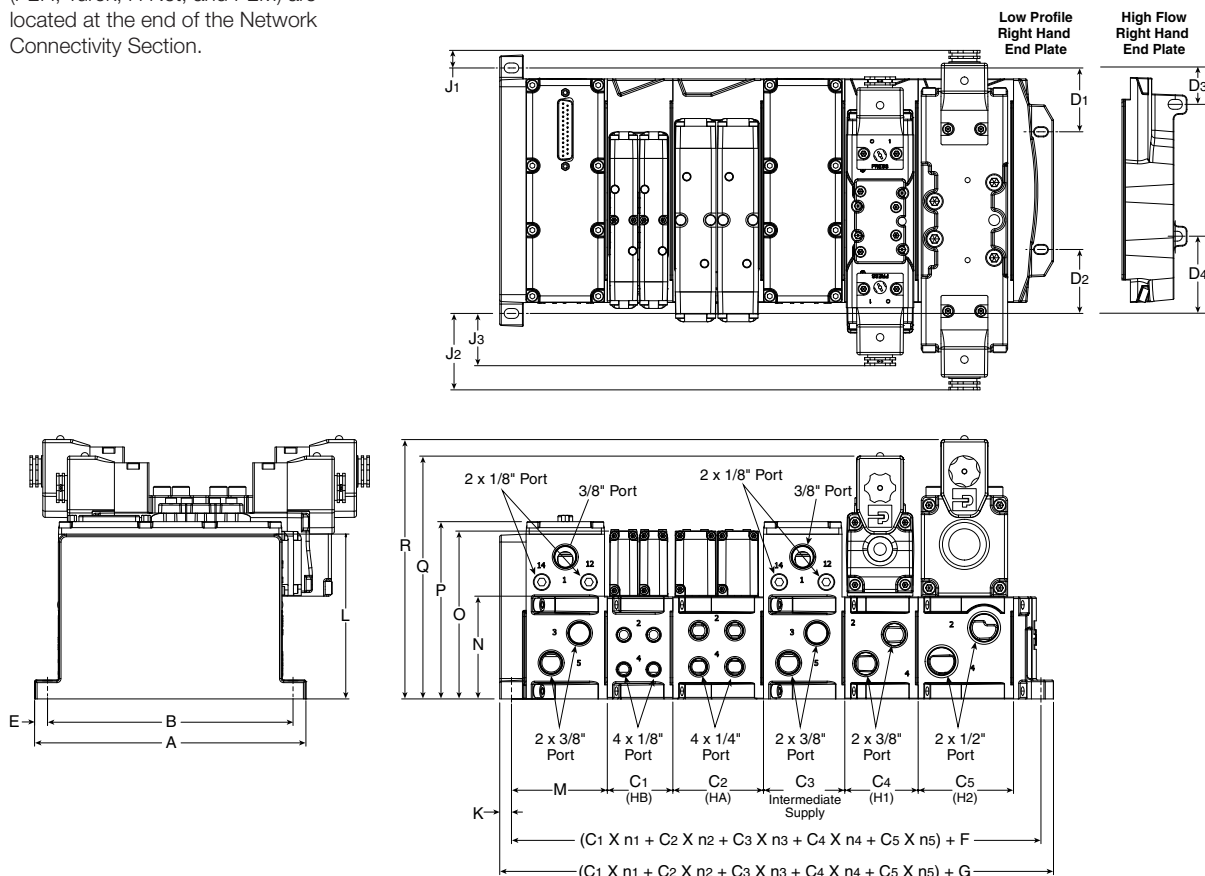

Dimensions [mm]

A	B	C1	C2	C3	C4
172.95	156.5	41.79	57.79	51.79	46.79
C5	D1	D2	D3	D4	E
60.79	40.71	40.71	24.3	48.8	8.00
F	G	J1	J2	J3	K
78.58	111.58	11.2	48.7	33.3	7.5
L	M	N	O	P	Q
105.08	61.08	48.7	107	113	154.77
R					
165.32					

H Series ISO Universal Manifold with H3 Transition

Network Connectivity dimensions (P2H, Turck, H Net, and P2M) are located at the end of the Network Connectivity Section.

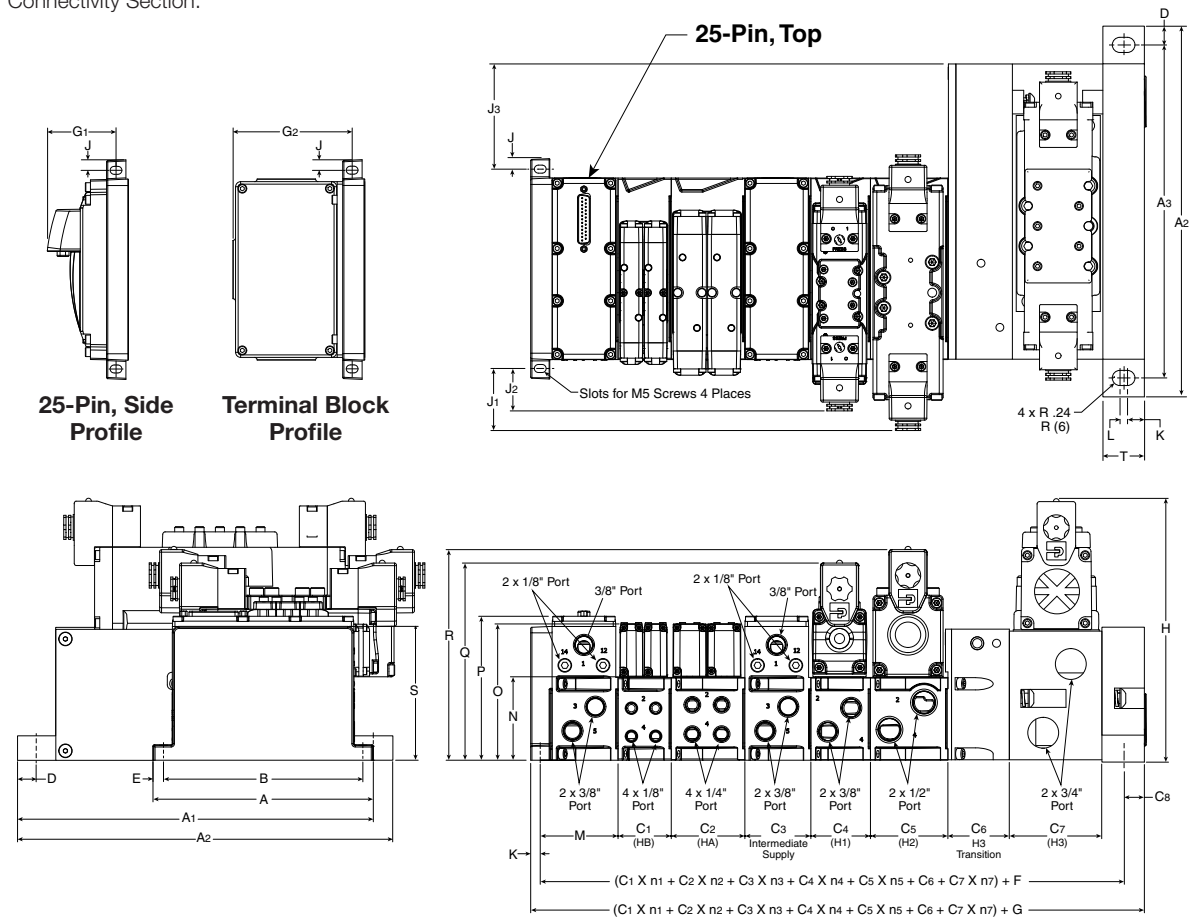

A	A1	A2	A3	B	C1	C2	C3	C4	C5	C6	C7
172.95	313.43	365.3	265	156.5	41.79	57.79	51.79	46.79	60.79	51.0	71.0
C8	D	E	F	G	G1	G2	H	J	J1	J2	J3
16.5	15.0	8.0	77.58	101.6	54.0	93.8	208	8.3	48.7	33.3	88.25
K	L	M	N	O	P	Q	R	S	T		
7.5	6.0	61.08	48.7	107	113	154.77	165.32	105.08	33.0		

25-Pin Side with H Series ISO Valves

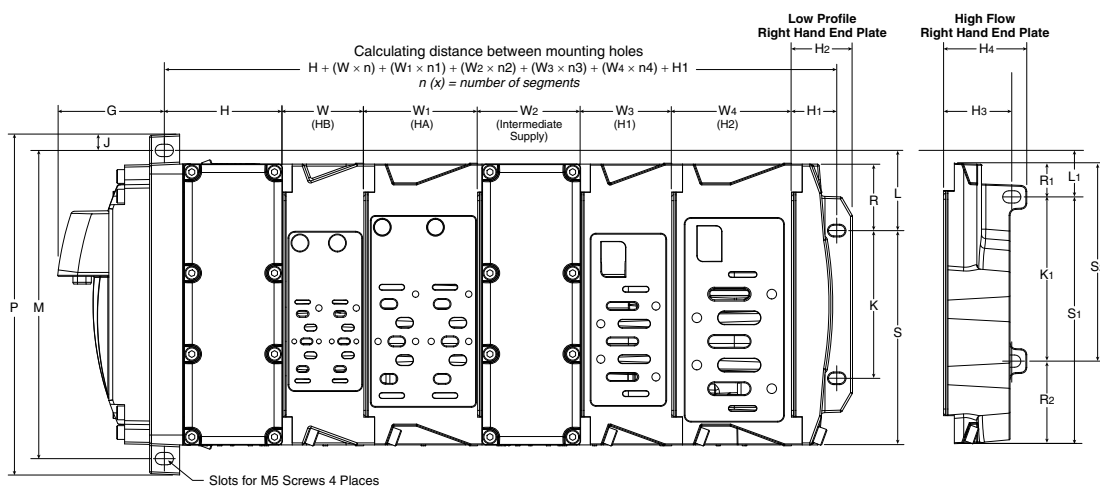

Hi-Flow Right Hand End Plate

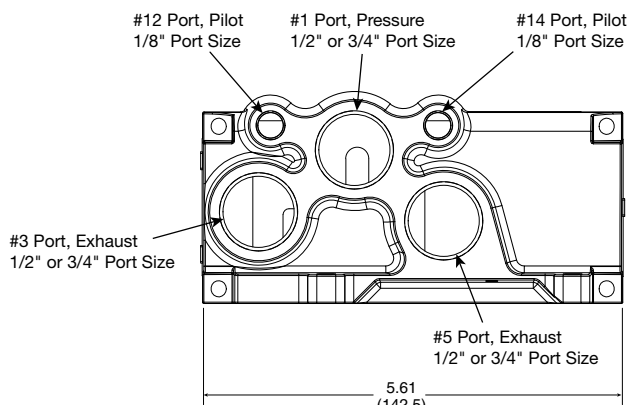

Hi-Flow Right Hand End Plate

PSHU41 1/2" port size

PSHU42 3/4" port size

Terminal Block with H Series ISO Valves

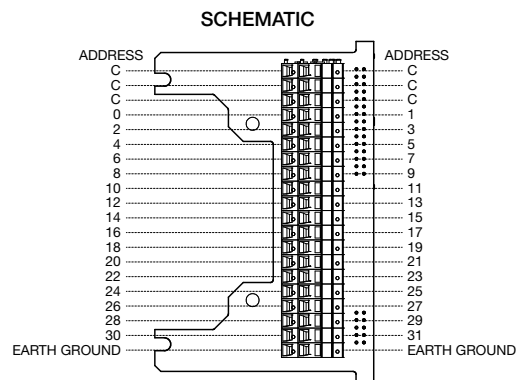
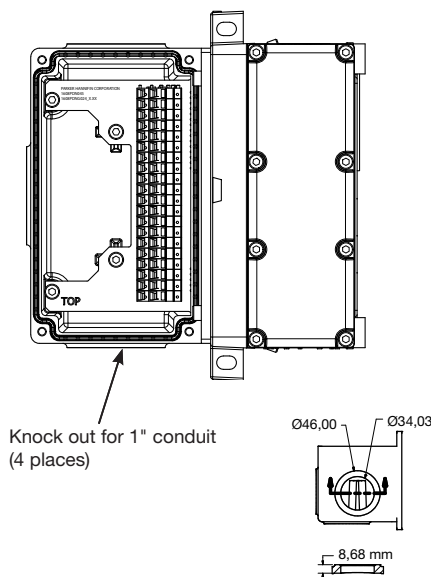
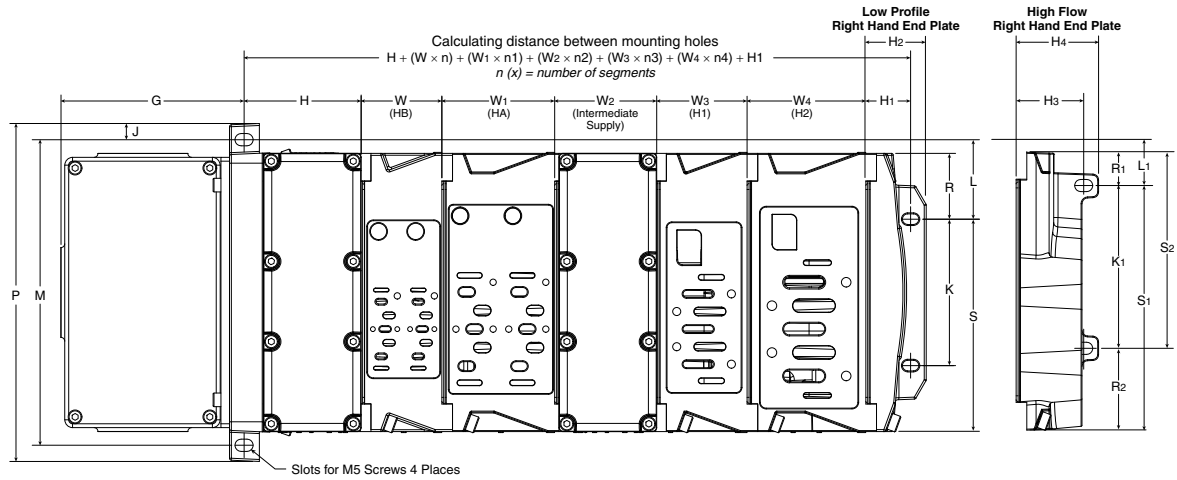

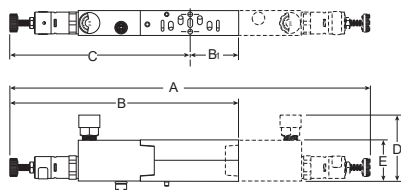
H Series ISO 15407, HB / HA Sandwich Regulator

HB / HA Series Sandwich Regulator, Dimensions [mm]

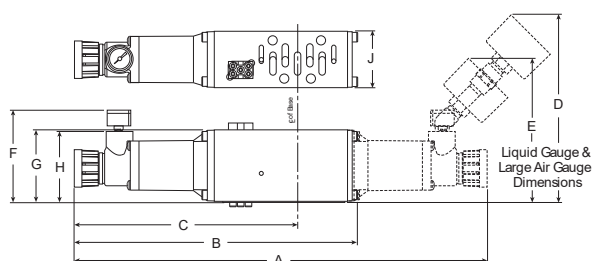
HB (PS5637)	A	B	B ₁	C	D	E
	261	156	26	130	66	30
HA (PS5537)	A	B	B ₁	C	D	E
	254	163	36	127	69	30

H Series ISO 5599, Size H1 Sandwich Regulator

H1 Series Sandwich Regulator, Dimensions [mm]

H1 (PS4037)	A	B	C	D	E	F
	301	207	163	138	108	72
(PS4038)	G	H	J			
	53	52	41			

H Series ISO 5599, Size H2 & H3 Sandwich Regulator

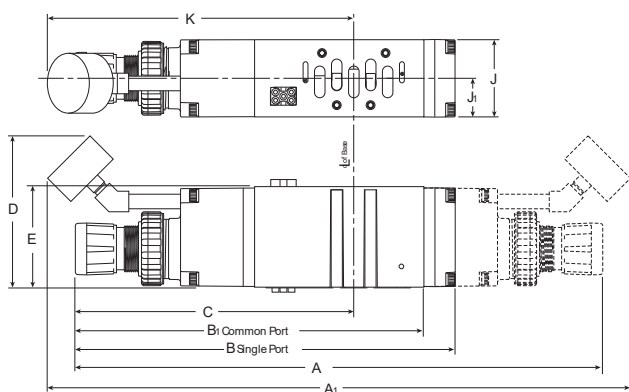
H2 Sandwich Regulator shown

H2 & H3 Series Sandwich Regulator, Dimensions [mm]

H2 (PS4137)	A	A ₁	B	B ₁	C	D
	372	411	268	250	196	107
(PS4138)	E	J	J ₁	K		
	71	55	27	216		
H3 (PS4237)	A	A ₁	B	B ₁	C	D
	398	436	293	271	213	107
(PS4238)	E	J	J ₁	K		
	75	64	32	231		

H Series ISO 15407, Size 18 mm (HB) & 26 mm (HA), Flow Control

HA Flow Control

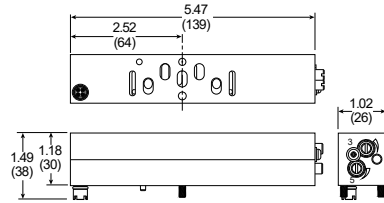

HB Flow Control

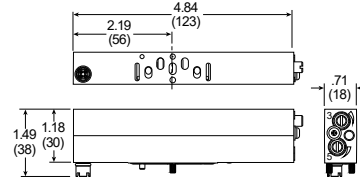

H Series ISO 5599, Size H1, H2 & H3, Flow Control

H1 Flow Control

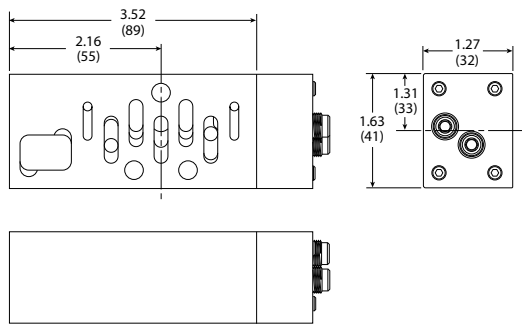

H2 Flow Control

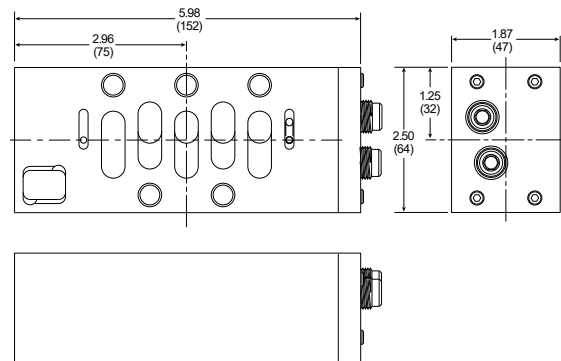

H3 Flow Control

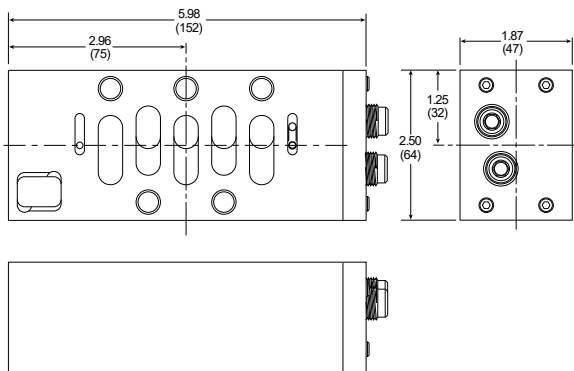

Network Connectivity

Offering

Valve series	P2M	P2H IO-Link	P2H Ethernet	PCH	Turck BL67
Moduflex	X				
H Series Micro	X				X
H Series ISO		X	X	X	X

Protocol	P2M	P2H IO-Link	P2H Ethernet	PCH	Turck BL67
IO-Link	X	X			
DeviceNet					X
EtherNet/IP	X		X	X	X
PROFIBUS-DP					X
PROFINET	X		X	X	X
Modbus/TCP	X		X	X	X
EtherCAT	X		X	X	
PowerLink	X		X		
CANopen					X

Options	P2M	P2H IO-Link	P2H Ethernet	PCH	Turck BL67
Digital inputs / outputs				X	X
Analog inputs / outputs					X
Class A IO-Link master module				X	X
Class B IO-Link master module				X	
24 Solenoid control	X*	X			X
32 Solenoid control			X	X	X
Short circuit protection on inputs				X	X
Current sensing outputs				X	X
Bus expansion					
DeviceNet subnet					X
Programmable comm modules					X
Power over DeviceNet / CANopen					X
Rockwell preferred connectivity					
CANopen expansion					X

* Only the first 19 solenoid outputs when used with Moduflex Valve Series

P2M Network Nodes (shown on H Micro & Moduflex)

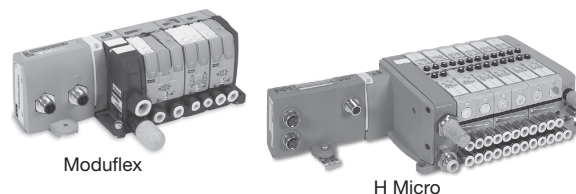

P2H Network Node: IO-Link (shown on H Series ISO)

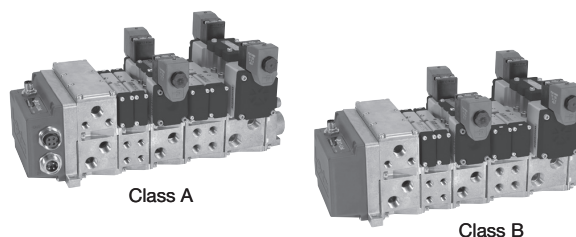

P2H Network Node: Industrial Ethernet (shown on H Series ISO)

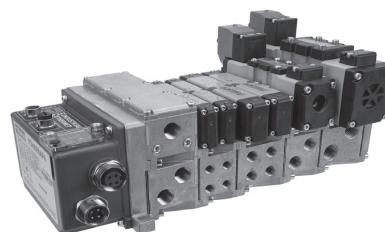

PCH Network Portal (shown on H Series ISO)

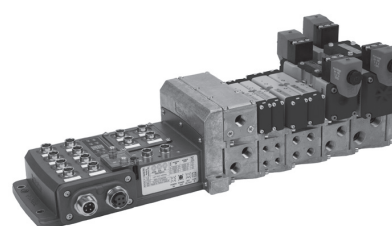

Turck Network Portal (shown on H Series ISO)

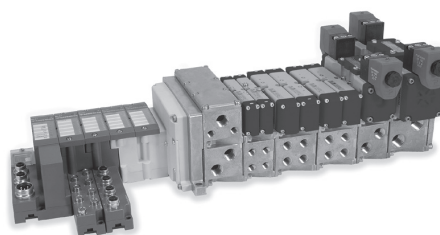

Industrial Ethernet

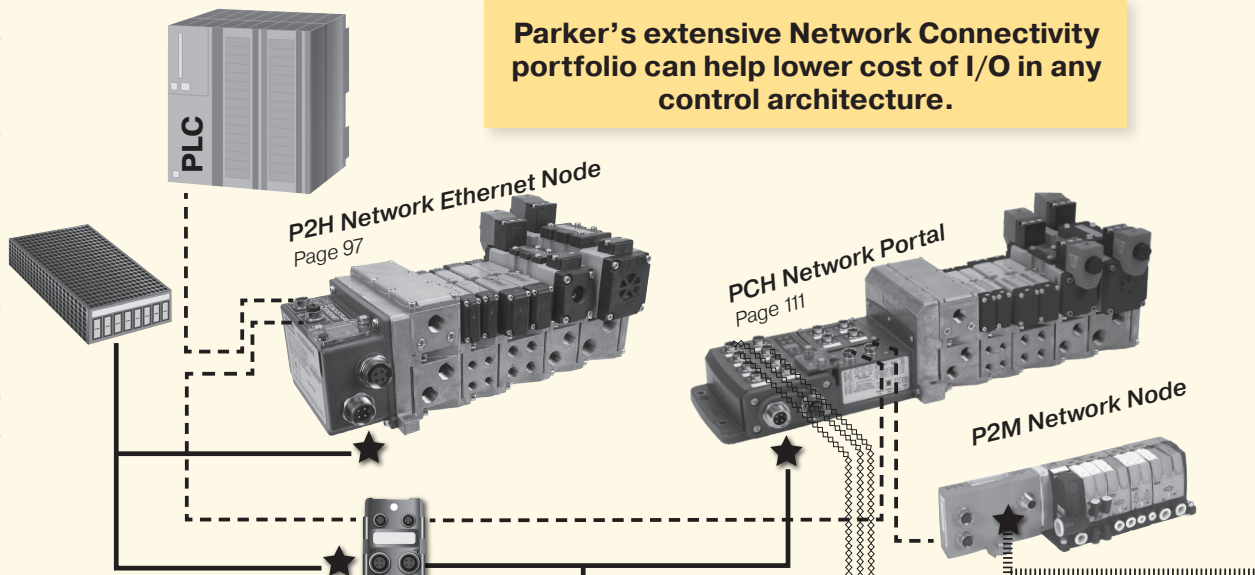

Parker's extensive Network Connectivity portfolio can help lower cost of I/O in any control architecture.

IO-Link

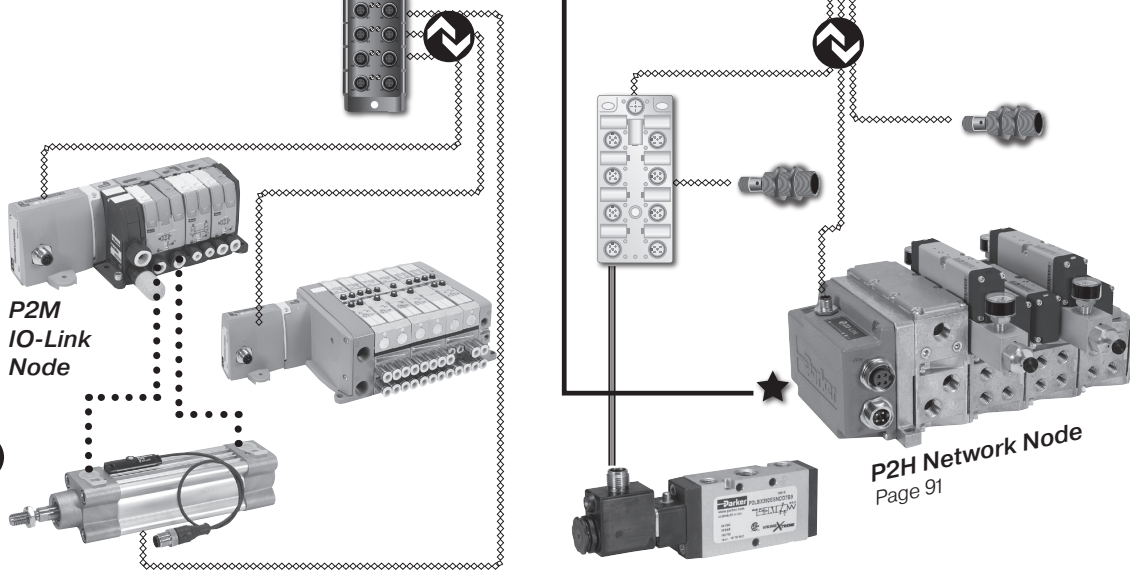

Network to Remote IO-Link Master
Reduce cabinet size by using a de-centralized "on-machine" IO-Link Master

- * Control all local I/O with IO-Link Masters
 - Discrete I/O
 - "Smart" I/O
- P2M IO-Link Class B & CPS pictured see www.parker.com/pde/CPS and www.parker.com/pde/P2M_IOL

Node Expansion Using IO-Link
Reduce node count by adding an IO-Link Master module onto Turck Network manifold

- * 20m max length for I/O-Link cables
- * Control all "smart I/O" on 1 node
- * Reduce cost of secondary valve manifold
 - P2H IO-Link Class A pictured see www.parker.com/pde/P2H_IOL

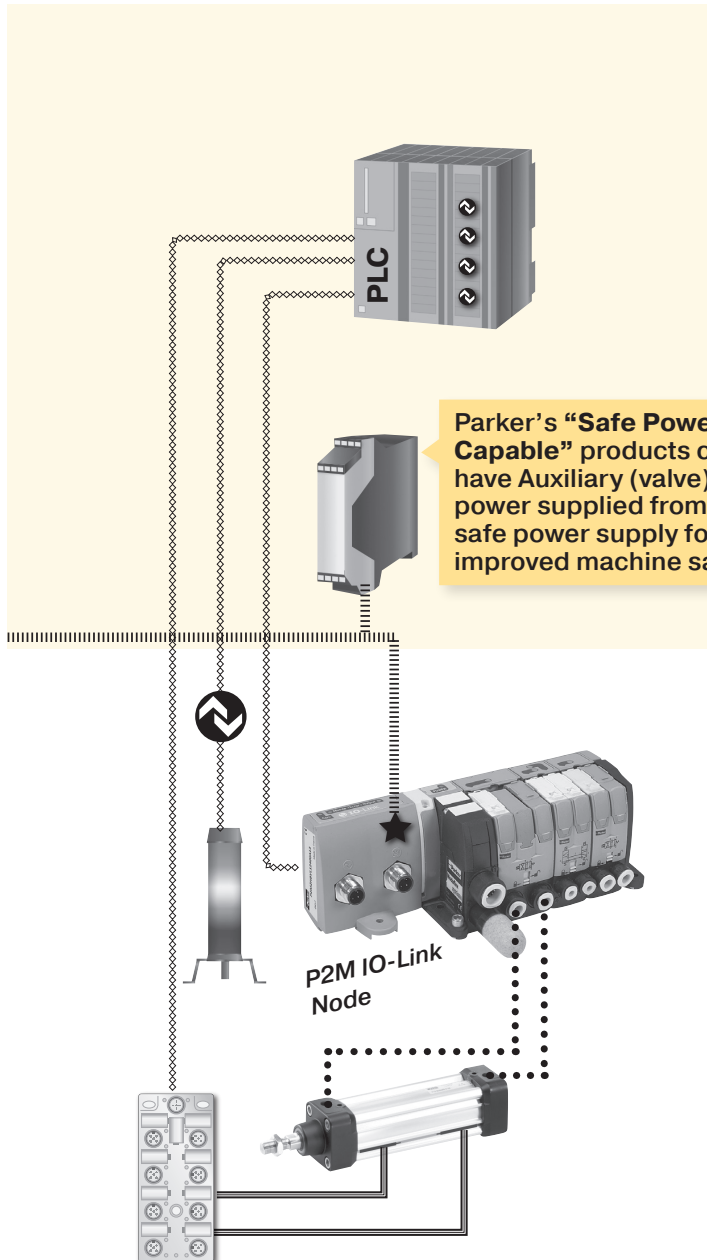

Parker's "Safe Power Capable" products can have Auxiliary (valve) power supplied from a safe power supply for improved machine safety.

- Industrial Network
- ⋯ IO-Link
- === Discrete Wired Input / Output
- ★ 24 VDC Power
- |||||★ 24 VDC SAFE Power
- Pneumatic

IO-Link is another step towards the smarter plant by lowering the cost for gathering component level prognostics and diagnostics.

- Out of Tolerance Warnings
 - * Voltage
 - * Temperature
- Error Descriptors
 - * Solenoid short circuit
 - * IO-Link communication error cycle count for each valve

Non-Network I/O Control Using IO-Link
 Use PLC with integrated IO-Link Master for machines with smaller I/O counts

- * 20m max length for I/O-Link cables
- * Control all local I/O with IO-Link
 - Discrete I/O
 - "Smart" I/O
 - P2M IO-Link Class A pictured

- THIS IS EASIER** → Faster installation than discrete wiring
Standard IP67 M12 cable
- THIS IS SAVINGS** → Fewer network nodes
Easy expandability
- THIS IS VALUE** → Easy access diagnostics
Prognostics to prevent downtime



System Overview - Discrete Wiring

- Up to 24 solenoids per manifold
- Discretely wired solenoids - optimized for PLCs with onboard inputs and outputs
- 25-Pin D-Sub, 19-Pin Brad Harrison or M23, or 12-Pin M23 connectors available

Centralized Application

Valves Inside Control Cabinet

- Valves located near machine control
- Applications with caustic wash down, hazardous areas, or extreme temperatures

Disadvantages

- Difficult to troubleshoot
- Difficult to maintain
- Expensive bulkhead fittings
- Long wiring time in cabinet

De-centralized Application

Valves Outside Control Cabinet

- Valves located near application - ready for machine mounting
- IP65 rating suitable for dusty and wet environments

Disadvantages

- Difficult to troubleshoot
- Difficult to maintain
- Long wiring time in cabinet
- Long wiring time in junction box

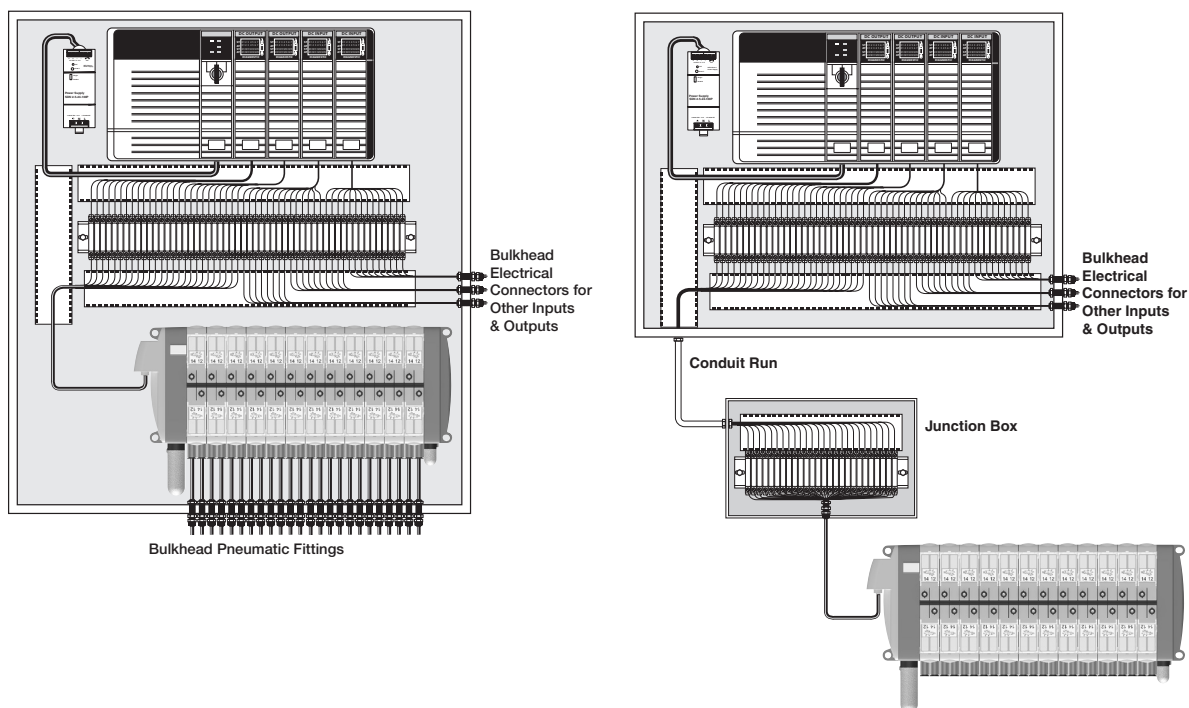

System Overview - P2M Network Node

- Up to 24 solenoids per manifold
- Optimized for PLCs with network capability
- Routinely used on medium sized machines
- Connectivity to Moduflex, H Series Micro and H Series ISO valves with Universal manifold

Centralized Application

Valves Inside Control Cabinet

- Valves located near machine control
- Applications with caustic wash down, hazardous areas, or extreme temperatures
- Additional inputs and outputs are not directly attached to valve manifold

Advantages

- Highest degree of environmental protection
- One location for all control devices
- Small size requires minimal cabinet space
- Eliminates terminal strips and wire ways for valves
- Greatly reduces wiring time
- Eliminates junction boxes for valves
- Eliminates conduit runs for valves

De-centralized Application

H Series Micro Outside Control Cabinet

- Valves located near application - ready for machine mounting
- IP65 rating suitable for dusty and wet environments
- Additional inputs and outputs are not directly attached to valve manifold

Advantages

- Smallest control cabinet
- Reduces tubing length and improves pneumatic response time
- Eliminates pneumatic bulk fittings on control cabinet
- Many network nodes can be attached to the network with little incremental cost – valve manifolds, inputs, outputs and other devices
- Eliminates terminal strips and wire ways for valves
- Greatly reduces wiring time
- Eliminates junction boxes for valves
- Eliminates conduit runs for valves

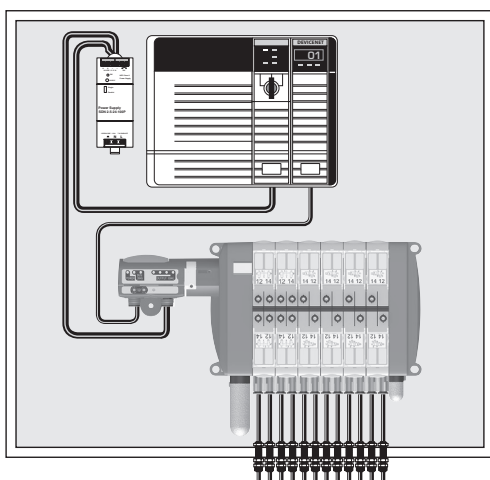

Bulkhead Pneumatic Fittings

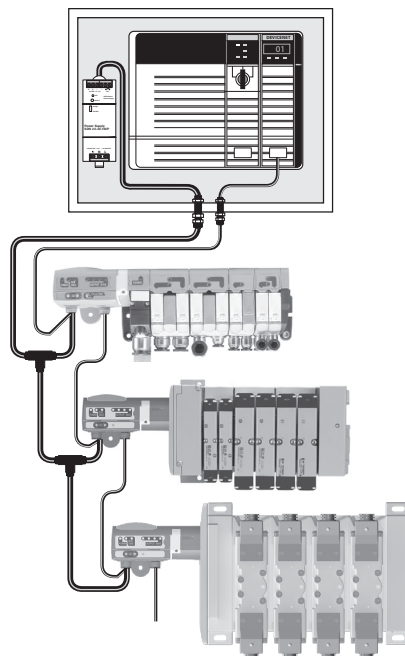

System Overview - Turck Network Portal

General Product Features

- Turck Network Portal with up to 256 inputs / outputs and 32 solenoids per manifold
- Digital inputs / outputs, analog inputs / outputs, serial interface, counter modules, and RFID modules available
- Connectivity to H Series Micro and H Series ISO valve series

Advantages

- Handle all I/O from one node; eliminate PLC input / output cards
- Optimized for PLC's with network capability
- Eliminates junction boxes, terminal strips, and conduit runs for all inputs and outputs, greatly reducing wiring time

Centralized Application

Valves Inside Control Cabinet

- Valves located near machine control
- Applications with caustic wash down, hazardous areas, or extreme temperatures

Advantages

- Highest degree of environmental protection
- One location for all control devices
- Small size requires minimal cabinet space

De-centralized Application

Valves Outside Control Cabinet

- Valves located near application - ready for machine mounting
- IP65 rating suitable for dusty and wet environments

Advantages

- Smallest control cabinet
- Reduces tubing length and improves response time
- Eliminates pneumatic bulk fittings on control cabinet

EtherNet/IP™



Modbus/TCP™

DeviceNet™



CANopen

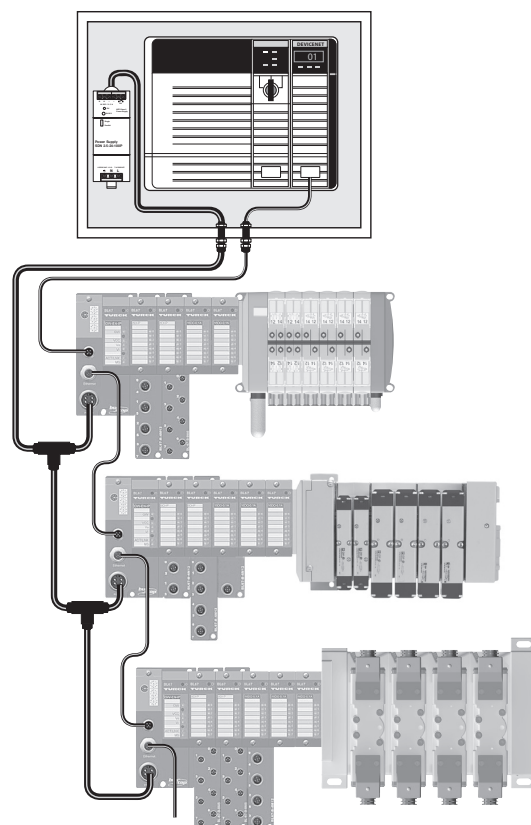
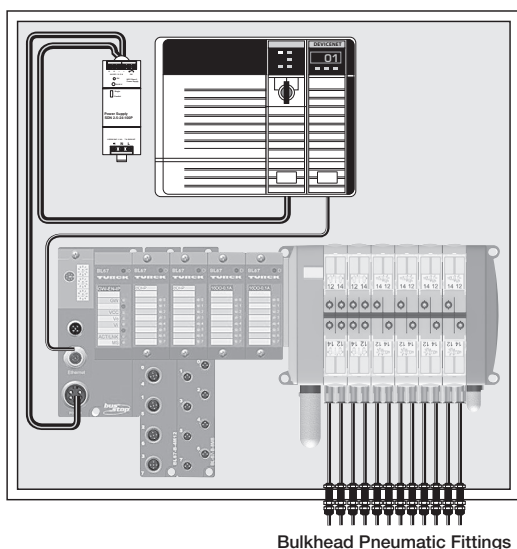

System Overview - Turck Network Portal with CANopen Expansion

General Product Features

- Turck Network Portal with up to 256 inputs / outputs and 32 solenoids per manifold
- Digital inputs / outputs, analog inputs / outputs, serial interface, counter modules, and RFID modules available
- Connectivity to H Series Micro and H Series ISO valves

CANopen Expansion Features

- Using a CANopen interface module, a CANopen subnet is created within the Turck Network Portal, controlling an additional 64 inputs, outputs, or solenoids
- The CANopen subnet is independent of the main network, and is not visible to the master PLC
- Additional P2M CANopen modules can be attached to the CANopen subnet to provide a connection for 16 solenoids each
- Other 3rd party CANopen devices can also be used on this network, within the 64 bit CANopen expansion limit

System Advantages

- Handle all I/O from one node; eliminate PLC input / output cards
- Optimized for PLC's with network capability
- Several CANopen nodes can be attached to the network – valve manifolds, inputs, outputs or other devices
- CANopen expansion allows additional devices to be attached to the system without a CANopen scanner card
- Eliminates junction boxes, terminal strips, and conduit runs for all inputs and outputs, greatly reducing wiring time

Centralized Application

Valves Inside Control Cabinet

- Valves located near machine control
- Applications with caustic wash down, hazardous areas, or extreme temperatures

Advantages

- Highest degree of environmental protection
- One location for all control devices
- Small size requires minimal cabinet space

De-centralized Application

Valves Outside Control Cabinet

- Valves located near application - ready for machine mounting
- IP65 rating suitable for dusty and wet environments

Advantages

- Smallest control cabinet
- Reduces tubing length and improves response time
- Eliminates pneumatic bulk fittings on control cabinet

EtherNet/IP™



Modbus/TCP™

DeviceNet



CANopen

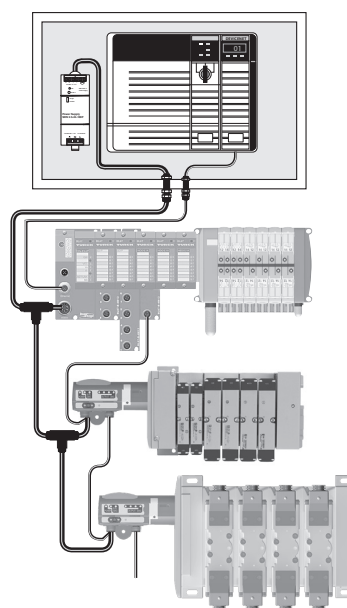
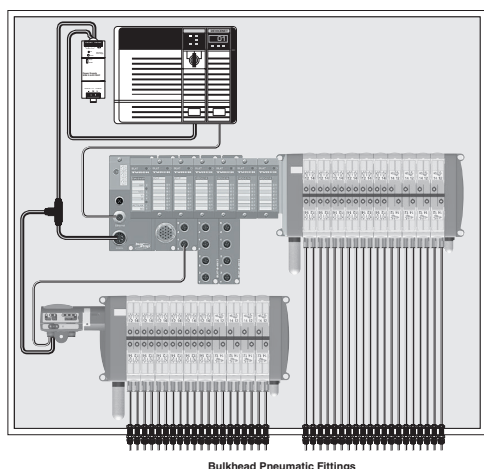

System Overview - Turck Network Portal with BL Remote DeviceNet Subnet

General Product Features

- Turck Network Portal with up to 256 inputs / outputs and 32 solenoids per manifold
- Digital inputs / outputs, analog inputs / outputs, serial interface, counter modules, and RFID modules available
- Connectivity to H Series Micro and H Series ISO valves

BL Remote DeviceNet Subnet Features

- With BL remote DeviceNet subnet functionality, each communication module has its own DeviceNet master which provides a connection for 63 DeviceNet nodes with additional inputs, outputs, and solenoid control
- BL remote DeviceNet subnet is independent of the main network, and is not visible to the master PLC
- P2M DeviceNet modules can be attached to the subnet to provide a connection for 16 solenoids each
- Turck DeviceNet modules can be attached to the subnet to provide a connection for 16 or 32 solenoids each and inputs and outputs up to the 256 input and output limitation

System Advantages

- Handle all I/O from one node; eliminate PLC input / output cards
- Optimized for PLC's with network capability
- Many DeviceNet nodes can be attached to the network – valve manifolds, inputs, outputs or other devices
- Eliminates junction boxes, terminal strips, and conduit runs for all inputs and outputs, greatly reducing wiring time

Centralized Application

Valves Inside Control Cabinet

- Valves located near machine control
- Applications with caustic wash down, hazardous areas or extreme temperatures

Advantages

- Highest degree of environmental protection
- One location for all control devices
- Small size requires minimal cabinet space

De-centralized Application

Valves Outside Control Cabinet

- Valves located near application - ready for machine mounting
- IP65 rating suitable for dusty and wet environments

Advantages

- Smallest control cabinet
- Reduces tubing length and improves response time
- Eliminates pneumatic bulk fittings on control cabinet

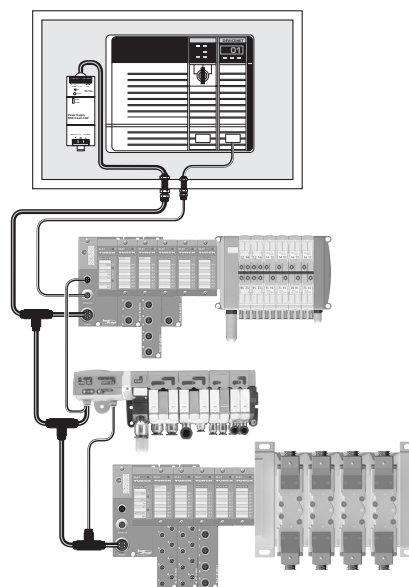
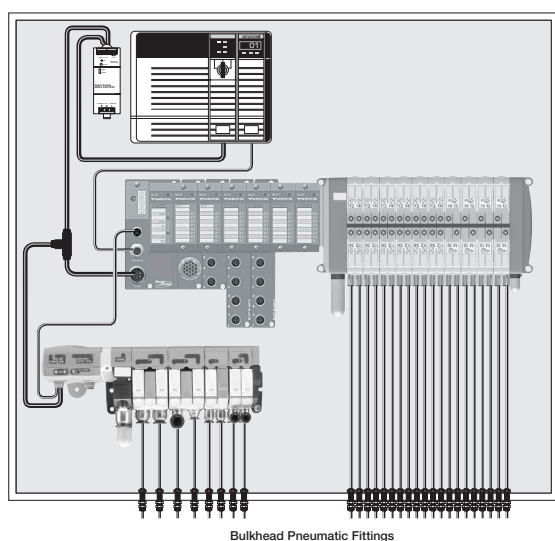

System Overview - Turck Network Portal with Stand Alone Control

General Product Features

- Turck Network Portal with up to 256 inputs / outputs and 32 solenoids per manifold
- Digital inputs / outputs, analog inputs / outputs, serial interface, counter modules, and RFID modules available
- Connectivity to H Series Micro and H Series ISO valves

Stand Alone Control Features

- Communication modules equipped with standalone control – programmed according to IEC61131-3 with CoDeSys
- 512KB program memory with 32 bit RISC processor
- Run 1000 instructions in less than 1 ms
- Optimized for PLC's with network capability or standalone controllers that need to interface with other devices

System Advantages

- Handle all I/O and control with one system; eliminate the PLC when used as the main controller for smaller machines
- Reduces programming and bandwidth requirements on large machines with a master PLC controller by handling local I/O and interfacing with the PLC over the network
- Eliminates junction boxes, terminal strips, and conduit runs for all inputs and outputs, greatly reducing wiring time

Centralized Application Valves

Inside Control Cabinet

- Valves attached to the machine control
- Applications with caustic wash down, hazardous areas, or extreme temperatures

Advantages

- Highest degree of environmental protection
- One location for all control devices

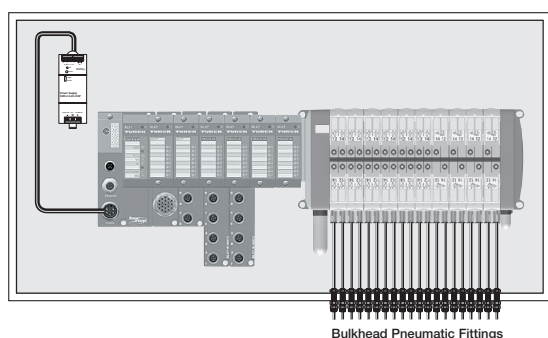

De-centralized Application

Valves Outside Control Cabinet

- Valves and machine control located near application - ready for machine mounting
- IP65 rating suitable for dusty and wet environments

Advantages

- No control cabinet needed when used as the main controller
- Reduces tubing length and improves response time
- Eliminates pneumatic bulk fittings on control cabinet

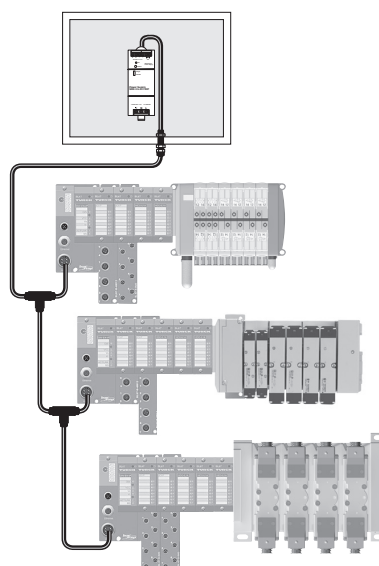

P2H IO-Link Node 24DO

The P2H Network Node is available with IO-Link connectivity for the industries first connection of ISO valves (5599 & 15407) to the low cost IO-Link network.

Features

- Compact, robust product design
- Weld splatter resistant housing material
- Simple connection to IO-Link Class A or Class B masters
- Industries first power in & out capability for Class A version
- Industries first 7/8" power connectors on Class A version
- IO-Link connection to new H Series ISO Universal Manifold, capable of mixing valve sizes from Qn 490 NI/mn to 2950 NI/mn
- Safe Power Capable for supplying valve power from a safety device (ie. safe relay)
- Diagnostics made SIMPLE! Useful diagnostic flags in process (cyclic) data for easy access and use for preventative maintenance
- Certified to IP65 ingress protection
- CE certification

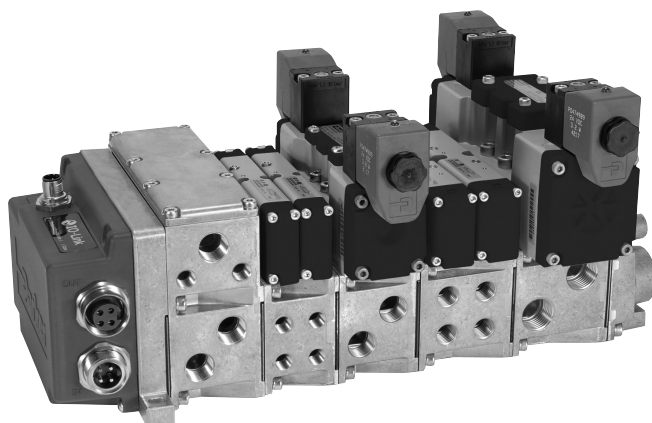

Class A Node

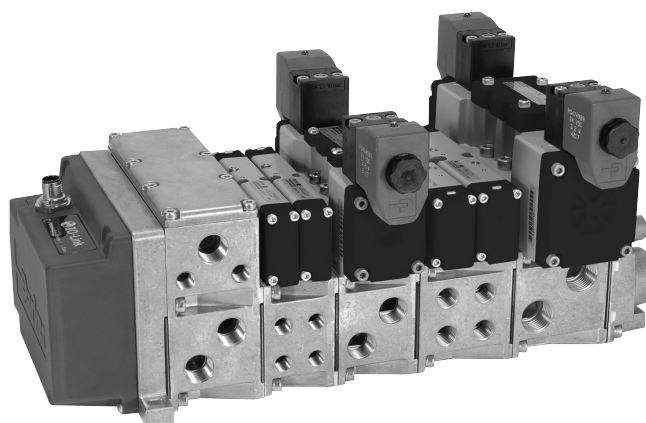

Class B Node

Overview - P2H IO-Link Node 24DO

Designed to integrate directly with all H Series ISO valve sizes, the P2H IO-Link Network Node provides a compact, robust and cost efficient solution for IO-Link capability. The P2H IO-Link network node is offered as an end plate kit on the H Series valve for five sizes (HB, HA, H1, H2 and H3). The P2H node is suitable for use on a valve manifold with up to 24 solenoid outputs.

Connection Types and Power:

Class A Node

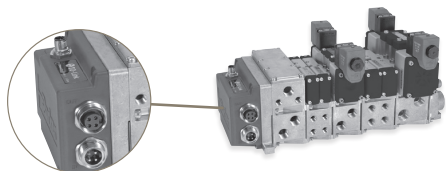

The Class A node has (1) 3 pin M12 connector for communication and logic power from any class A IO-Link master, and (2) 7/8" connectors for auxiliary valve power IN and OUT.

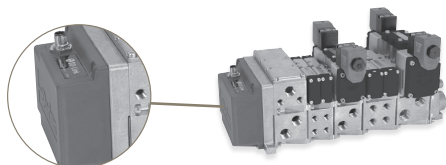

Class B Node



The Class B node has (1) 5 pin M12 connector to connect IO-Link for communication to a Class B IO-Link master, logic power and auxiliary power for the valve solenoids (up to the limit of the Class B node output*).

*It is recommended to use the Class A node with auxiliary power if the Class B master cannot provide enough power.

Left and Right Hand End Plate

	IO-Link class / type	Current	HB, HA, H1, H2 Valves		H3 Valves	
			NPT port	BSP port	NPT port	BSP port
 Class B	P2H IO-Link Class B, standard version, 24 address	3.2A max	PSHU20N200P	PSHU20N201P	PS4220N20DP	PS4220N21DP
	P2H IO-Link Class B, Safe Power Capable, 24 address	2.0A max	PSHU20S200P	PSHU20S201P	PS4220S20DP	PS4220S21DP
 Class A	P2H IO-Link Class A, 4-pin Safe Power Capable, 24 address	3.2A max	PSHU20S400P	PSHU20S401P	PS4220S40DP	PS4220S41DP
	P2H IO-Link Class A, 5-pin Safe Power Capable, 24 address	3.2A max	PSHU20S500P	PSHU20S501P	PS4220S50DP	PS4220S51DP

www.parker.com/pde/P2H_IOL

Description	Standard version	- Safe power capable versions
IO-Link power supply	According to IO-Link standard V1.1.2	
Speed communication	Com 2 – 38 kBd	
Auxiliary power supply	voltage	20,4 VDC to 26,4 VDC
	OSSD compatibility	No Yes
Short circuit protection	Yes	
Operating temperature	0°C to +55°C	
Shock	According to IEC 60068-2-27:2008	
Vibration	According to IEC 60068-2-6:2007	
EMC	According to EN 55011 & EN 61000-4-2 to -4-6	
Ingress protection	Certified to IP65	



P2H IO-Link Node 24DO – Connections and LED Diagnostics

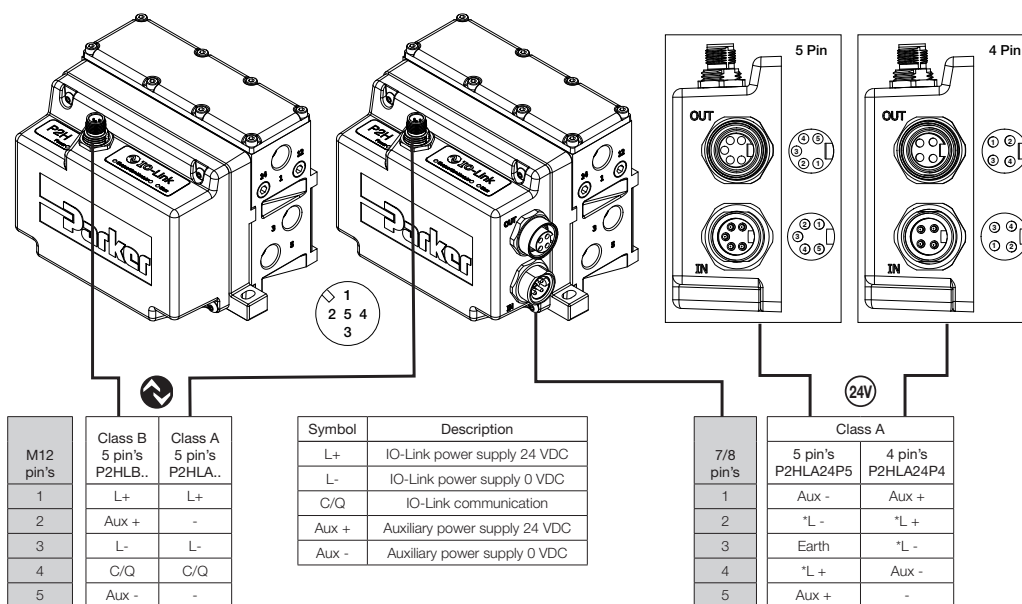

Note:
* 7/8" logic power has no connection to internal P2H unit but does carryover to OUT 7/8" connector (for jumper logic power only). Logic power for P2H unit will be supplied from M12 (pin 1 & 3)

Local diagnostic through LED:

The P2H IO-Link Node offers a local diagnostic through 4 LED's status with interpretation described in the table below:

Power Green LED			Output<Err> Red LED			<Err>Module Red LED			Com Green LED		
LED Status	Description	Solving	LED Status	Description	Solving	LED Status	Description	Solving	LED Status	Description	Solving
OFF	Auxiliary power failure < 18V or > 28,5V	Check auxiliary power supply	OFF	Standard mode (No error active)	N/A	OFF	Standard mode (No error active)	N/A	OFF	IO-Link L+ / L- line not powered	Check IO-Link power supply from IO-Link Master (pin's 1 & 3)
ON	Standard mode (auxiliary power within normal range 20,4V* to 26,4V*)	N/A	ON	Any outputs driver error (auxiliary power error, overload, short circuit, over temperature, ...)	If auxiliary power OK (see Power LED status), check error messages and related troubleshooting	ON	24 VDC auxiliary power missing or any active malfunction	Check Auxiliary power supply. If auxiliary power supply OK, module must be replaced	ON	IO-Link L+ / L- line powered IO-Link master port set as SIO mode	Set IO-Link master channel in IO-Link mode
Blinking	Auxiliary power out of range (warning level*)	Check auxiliary power supply, check/reset adjusted values							Blinking	IO-Link communication active	N/A

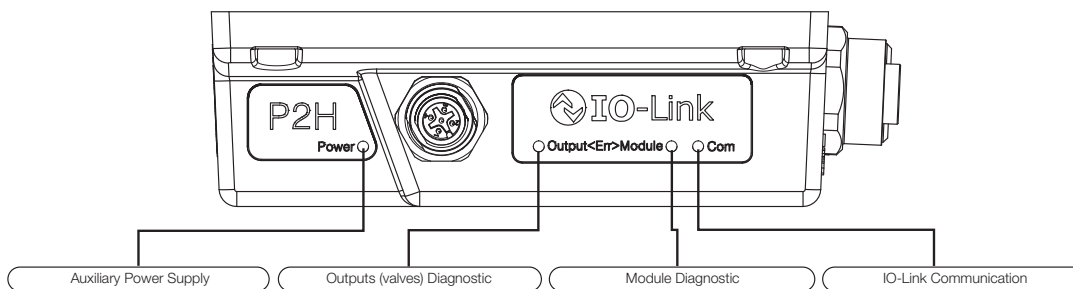

P2H IO-Link Node 24DO – Connections and LED Diagnostics

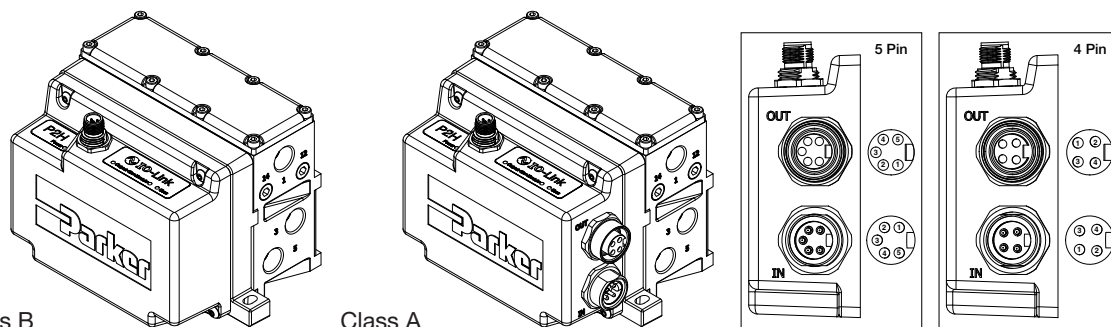

Class B

Class A



P2H IO-Link 24DO Node connection to SAFE Power PP / PM mode for valve control

The P2H IO-Link 24DO node can be powered from a SAFE 24 VDC auxiliary source in PP or PM mode as grounds are isolated. Auxiliary power for solenoids can be wired allowing the functionality to turn outputs OFF while communications remain active.

Class A – 5 Pin

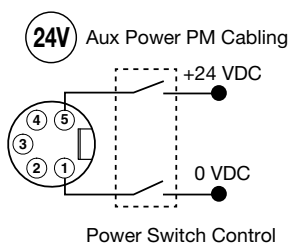
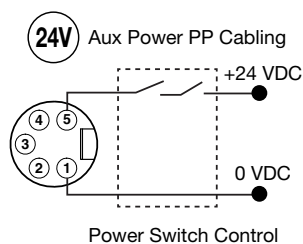

Pin Number	Address
1	AUX-
2	*L-
3	Earth
4	*L+
5	AUX+

Class A – 4 Pin

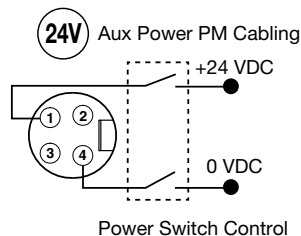
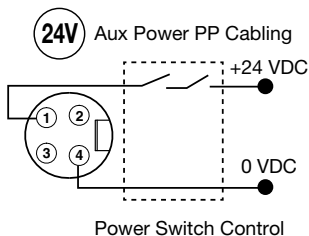

Pin Number	Address
1	AUX+
2	*L+
3	*L-
4	AUX-

Class B

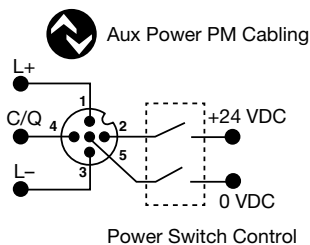
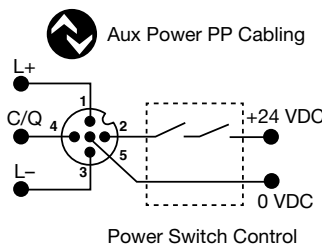

Pin Number	Address
1	L+
2	AUX+
3	L-
4	C/Q
5	AUX-

* 7/8" logic power has no connection to internal P2H unit but does carryover to OUT 7/8" connector (for jumper logic power only). Logic power for P2H unit will be supplied from M12 (pin 1 & 3).

P2H IO-Link Node 24DO – Input / Output Data Mapping

Input Data

One byte of diagnostic input data is transferred from Moduflex to the IO-Link Master.

Process Input Data

7	6	5	4	3	2	1	0
Output driver SPI error	Output driver channel error	Polyfuse tripped	Temperature warning	SPI error	Aux voltage error	Aux voltage warning	Acknowledge required

Diag bit	Error Message	Detail
Diag 0	Fail-safe status	Acknowledgment required
Diag 1	Auxiliary voltage warning	Auxiliary voltage out of range, check auxiliary power line
Diag 2	Auxiliary voltage failure	Auxiliary voltage out of order, check auxiliary power source
Diag 3	Module failure	Switch OFF / ON auxiliary power, if error message persists, replace the module
Diag 4	Module over-temperature	Switch OFF / ON auxiliary power, if error message persists, replace the module
Diag 5	Module over-load	Check overall pilot solenoid valves, if error message persists, replace the module
Diag 6	Pilot solenoid(s) short circuit	Check faulty pilot solenoid valve(s), replace if necessary
Diag 7	Outputs stage not available	Auxiliary power is OFF

Output Data

Three bytes of process data are received by Moduflex from the IO-Link Master for control of solenoids.

Process Output Data (Byte 0)

7	6	5	4	3	2	1	0
EV8	EV7	EV6	EV5	EV4	EV3	EV2	EV1

Process Output Data (Byte 1)

7	6	5	4	3	2	1	0
EV16	EV15	EV14	EV13	EV12	EV11	EV10	EV9

Process Output Data (Byte 2)

7	6	5	4	3	2	1	0
EV24	EV23	EV22	EV21	EV20	EV19	EV18	EV17

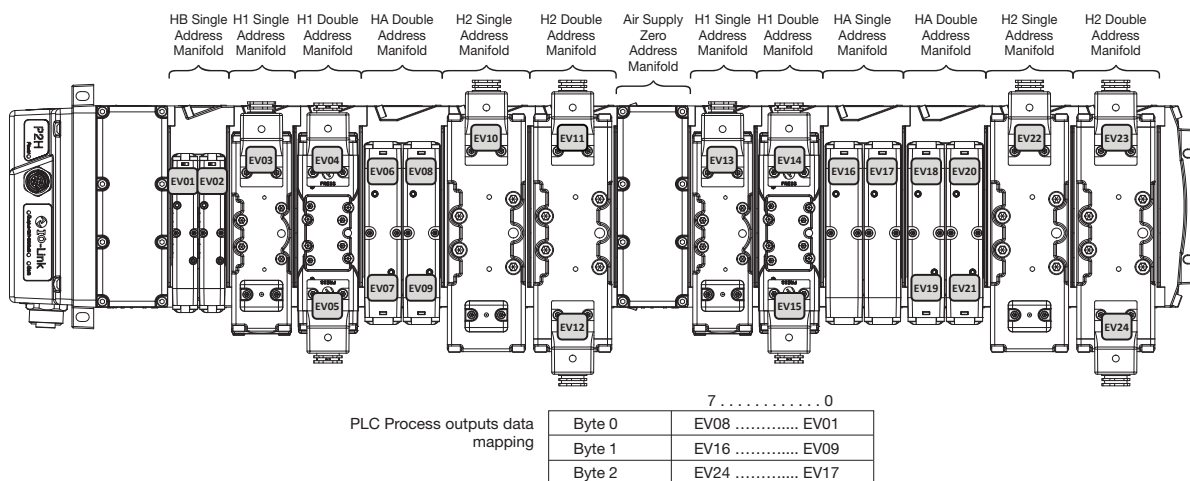

Configuration IODD File

IODD file can be downloaded from IODD Finder or the P2H IO-Link web site:

- <https://ioddfinder.io-link.com>
- www.parker.com/pde/P2H_IOL

P2H Ethernet Node 32 DO

The P2H Ethernet Node has been designed to be connected to a many popular Ethernet Networks. It can be used with Parker's H-Universal ISO 15407-2 (size Q2 & O1) and 5599-2 (sizes 1, 2 & 3) valve series. It can control up to 32 pilot solenoid addresses with different power configuration options available and provides local visual and remote diagnostics through the Network. Designed for industrial environments, the P2H Ethernet Node is constructed of PBT material, which is glass-filled and offers weld splatter resistance, UV stability and has significant flame-retardant properties making it suitable for the durability required in industrial applications with high heat and welding applications.

Features

Industrial Ethernet Protocols:

- Profinet
- EtherNet/IP
- EtherCAT
- Modbus TCP
- Powerlink

Power Options:

- Power IN/OUT Connection
- 7/8 4 pin
- 7/8 5 pin
- L- Code M12 5 pin
- Safe Power Capable
- OSSD Compatible

Environment:

- IP65
- Weld Spatter Resistant
- Weld Noise Immune

Diagnostics:

- PLC
- Web Interface
- Network Specific LED's

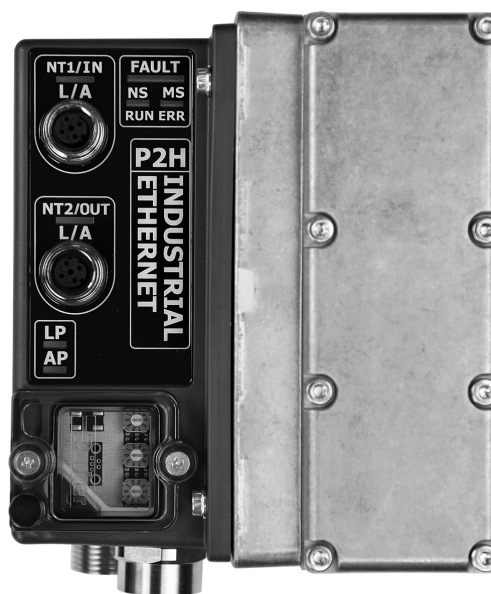
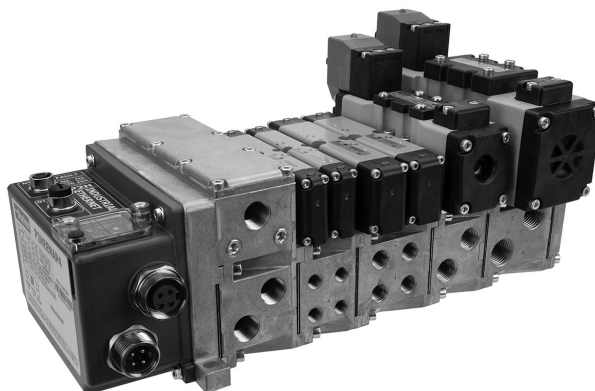

P2H Ethernet Node 32 DO - Overview

Designed to integrate directly with all H Series ISO valve sizes, the P2H Ethernet Network Node provides a compact, robust and cost-efficient solution for industrial ethernet connectivity to a PLC or other controls device that supports industrial ethernet protocols. The P2H Ethernet Network Node is offered as an end plate kit on the H Series valve for five sizes (HB, HA, H1, H2 and H3). The P2H Ethernet Network Node is suitable for use on a valve manifold with up to 32 solenoid outputs. P2H Ethernet Node connects to a network with two standard M12 D-coded connections. These two connections function as a switch to enable the network to be connected to another network device.

Power connectors are available in three styles:

- 7/8 4-pin
- 7/8 5-pin
- M12 L-Code 5-pin

The power connectors are arranged in an IN/OUT design, and this allows the flexibility to connect power to another down stream device, instead of running two separate cables from a power supply. Each power connector can supply up to 12 A of current on both Logic and Auxiliary power pins. All power connections support (OSSD) test pulsing if the P2H Ethernet Node is connected to a safety rated output device that uses test pulses to detect faults in a safety system.

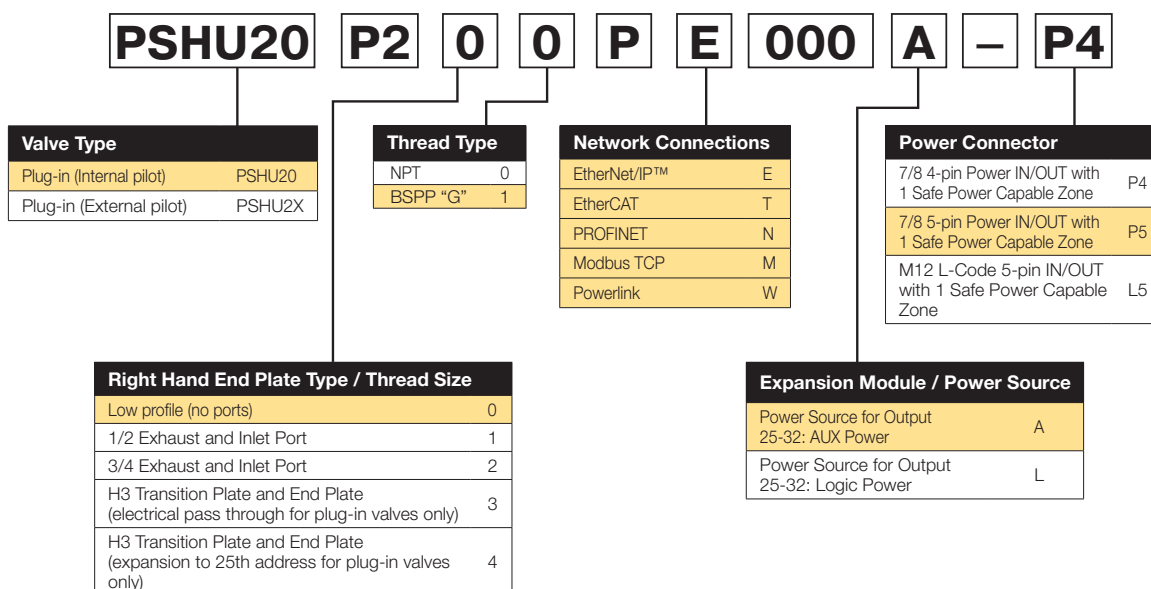
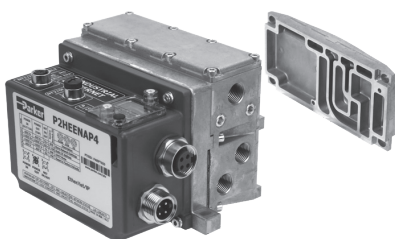

P2H Ethernet Node 32 DO - Expansion Module

Note: An optional intermediate air supply module must be installed to the manifold for expansion from 25 – 32 solenoids, 24 to 31 addresses.

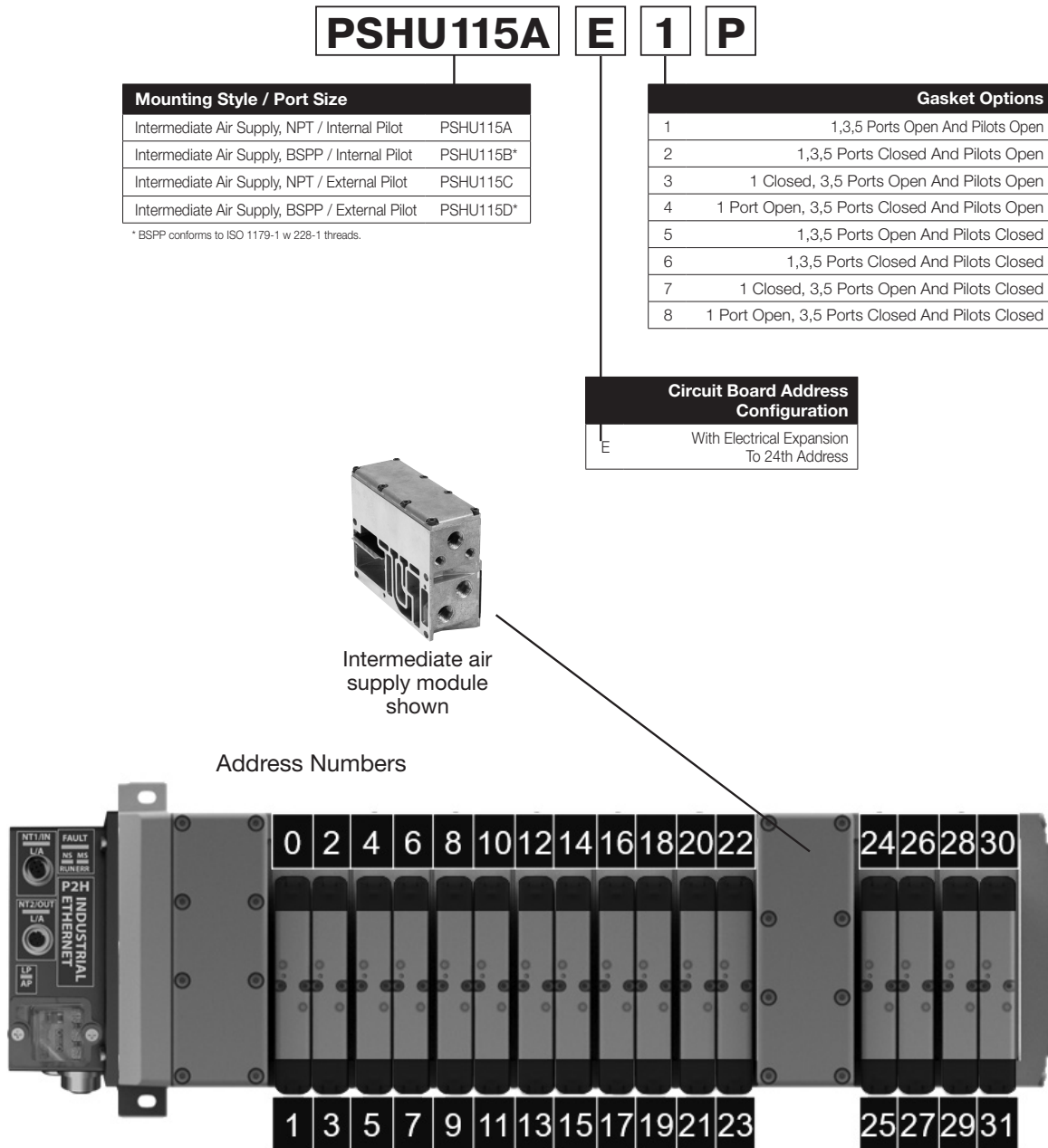

P2H Ethernet Node 32 DO - Network Interface

The P2H Node 32DO allows connection to an industrial Ethernet Network via two M-12 D-Coded connectors (NT1 and NT2). An embedded switch allows for daisy-chaining ethernet communications. The connectors pin assignments are as follows:

M12, D-coded, Female	Pin No.	Function
	1	Tx+
	2	Rx+
	3	Tx-
	4	Rx-

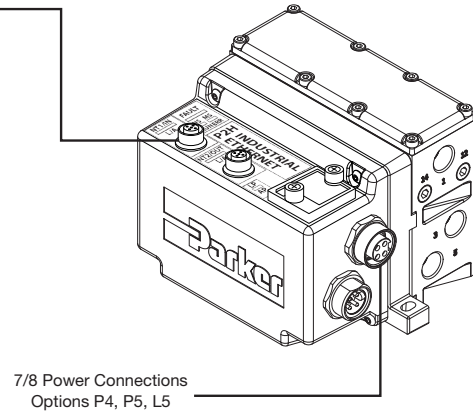

Industrial Ethernet Options



Network Connections	
EtherNet/IP™	E
EtherCAT	T
PROFINET	N
Modbus TCP	M
Powerlink	W

P2H Ethernet Node 32 DO - Power Options

- The P2H Ethernet Network Node has 3 available power connectors
- There are two power schemes that can be achieved detailed below
- H ISO Universal manifold valves draw power from the AUX power pins of the power connector

Consumption @ 24 VDC

AUX power max consumption	12A
Logic power max consumption	12A

Left over power that is not used by the P2H Ethernet Node can be passed on to other devices in the system through the power OUT connector



Power Connector *	
7/8 4-pin power in/out with 1 safe power capable zone	P4
7/8 5-pin power in/out with 1 safe power capable zone	P5
M12 L-Code 5-Pin in/out with 1 Safe Power Capable zone	L5

Power Connection Layout

The following three types of power connectors are available based on the end user's requirement. Current considerations should be used in the power connection selection process. Each power connection type can support a maximum of 12 A of current on each channel (VAUX and VLOG). When daisy chaining power is used, care must be taken in knowing the downstream current draw in order not to overload the maximum current rating of the pins.

	P4 - 7/8", 4-pin	P5 - 7/8", 5-pin	L5 - L-Coded, M12																																																			
TOP CONNECTOR	Power OUT	Power OUT	Power OUT																																																			
	<table border="1"> <thead> <tr> <th>Pin</th> <th>Function</th> <th>Description</th> </tr> </thead> <tbody> <tr> <td>1</td> <td>+ 24 V</td> <td>V2 (VAUX)</td> </tr> <tr> <td>2</td> <td>+ 24 V</td> <td>V1 (VLOG)</td> </tr> <tr> <td>3</td> <td>0 V</td> <td>GND V1 (VLOG)</td> </tr> <tr> <td>4</td> <td>0 V</td> <td>GND V2 (VAUX)</td> </tr> </tbody> </table>	Pin	Function	Description	1	+ 24 V	V2 (VAUX)	2	+ 24 V	V1 (VLOG)	3	0 V	GND V1 (VLOG)	4	0 V	GND V2 (VAUX)	<table border="1"> <thead> <tr> <th>Pin</th> <th>Function</th> <th>Description</th> </tr> </thead> <tbody> <tr> <td>1</td> <td>0 V</td> <td>GND V2 (VAUX)</td> </tr> <tr> <td>2</td> <td>0 V</td> <td>GND V1 (VLOG)</td> </tr> <tr> <td>3</td> <td>PE</td> <td>Protective Earth</td> </tr> <tr> <td>4</td> <td>+ 24 V</td> <td>V1 (VLOG)</td> </tr> <tr> <td>5</td> <td>+ 24 V</td> <td>V2 (VAUX)</td> </tr> </tbody> </table>	Pin	Function	Description	1	0 V	GND V2 (VAUX)	2	0 V	GND V1 (VLOG)	3	PE	Protective Earth	4	+ 24 V	V1 (VLOG)	5	+ 24 V	V2 (VAUX)	<table border="1"> <thead> <tr> <th>Pin</th> <th>Function</th> <th>Description</th> </tr> </thead> <tbody> <tr> <td>1</td> <td>+ 24 V</td> <td>V1 (VLOG)</td> </tr> <tr> <td>2</td> <td>0 V</td> <td>GND V2 (VAUX)</td> </tr> <tr> <td>3</td> <td>0 V</td> <td>GND V1 (VLOG)</td> </tr> <tr> <td>4</td> <td>+ 24 V</td> <td>V2 (VAUX)</td> </tr> <tr> <td>5</td> <td>PE</td> <td>Protective Earth</td> </tr> </tbody> </table>	Pin	Function	Description	1	+ 24 V	V1 (VLOG)	2	0 V	GND V2 (VAUX)	3	0 V	GND V1 (VLOG)	4	+ 24 V	V2 (VAUX)	5	PE	Protective Earth
	Pin	Function	Description																																																			
1	+ 24 V	V2 (VAUX)																																																				
2	+ 24 V	V1 (VLOG)																																																				
3	0 V	GND V1 (VLOG)																																																				
4	0 V	GND V2 (VAUX)																																																				
Pin	Function	Description																																																				
1	0 V	GND V2 (VAUX)																																																				
2	0 V	GND V1 (VLOG)																																																				
3	PE	Protective Earth																																																				
4	+ 24 V	V1 (VLOG)																																																				
5	+ 24 V	V2 (VAUX)																																																				
Pin	Function	Description																																																				
1	+ 24 V	V1 (VLOG)																																																				
2	0 V	GND V2 (VAUX)																																																				
3	0 V	GND V1 (VLOG)																																																				
4	+ 24 V	V2 (VAUX)																																																				
5	PE	Protective Earth																																																				
BOTTOM CONNECTOR	Power IN	Power IN	Power IN																																																			
	<table border="1"> <thead> <tr> <th>Pin</th> <th>Function</th> <th>Description</th> </tr> </thead> <tbody> <tr> <td>1</td> <td>+ 24 V</td> <td>V2 (VAUX)</td> </tr> <tr> <td>2</td> <td>+ 24 V</td> <td>V1 (VLOG)</td> </tr> <tr> <td>3</td> <td>0 V</td> <td>GND V1 (VLOG)</td> </tr> <tr> <td>4</td> <td>0 V</td> <td>GND V2 (VAUX)</td> </tr> </tbody> </table>	Pin	Function	Description	1	+ 24 V	V2 (VAUX)	2	+ 24 V	V1 (VLOG)	3	0 V	GND V1 (VLOG)	4	0 V	GND V2 (VAUX)	<table border="1"> <thead> <tr> <th>Pin</th> <th>Function</th> <th>Description</th> </tr> </thead> <tbody> <tr> <td>1</td> <td>0 V</td> <td>GND V2 (VAUX)</td> </tr> <tr> <td>2</td> <td>0 V</td> <td>GND V1 (VLOG)</td> </tr> <tr> <td>3</td> <td>PE</td> <td>Protective Earth</td> </tr> <tr> <td>4</td> <td>+ 24 V</td> <td>V1 (VLOG)</td> </tr> <tr> <td>5</td> <td>+ 24 V</td> <td>V2 (VAUX)</td> </tr> </tbody> </table>	Pin	Function	Description	1	0 V	GND V2 (VAUX)	2	0 V	GND V1 (VLOG)	3	PE	Protective Earth	4	+ 24 V	V1 (VLOG)	5	+ 24 V	V2 (VAUX)	<table border="1"> <thead> <tr> <th>Pin</th> <th>Function</th> <th>Description</th> </tr> </thead> <tbody> <tr> <td>1</td> <td>+ 24 V</td> <td>V1 (VLOG)</td> </tr> <tr> <td>2</td> <td>0 V</td> <td>GND V2 (VAUX)</td> </tr> <tr> <td>3</td> <td>0 V</td> <td>GND V1 (VLOG)</td> </tr> <tr> <td>4</td> <td>+ 24 V</td> <td>V2 (VAUX)</td> </tr> <tr> <td>5</td> <td>PE</td> <td>Protective Earth</td> </tr> </tbody> </table>	Pin	Function	Description	1	+ 24 V	V1 (VLOG)	2	0 V	GND V2 (VAUX)	3	0 V	GND V1 (VLOG)	4	+ 24 V	V2 (VAUX)	5	PE	Protective Earth
	Pin	Function	Description																																																			
1	+ 24 V	V2 (VAUX)																																																				
2	+ 24 V	V1 (VLOG)																																																				
3	0 V	GND V1 (VLOG)																																																				
4	0 V	GND V2 (VAUX)																																																				
Pin	Function	Description																																																				
1	0 V	GND V2 (VAUX)																																																				
2	0 V	GND V1 (VLOG)																																																				
3	PE	Protective Earth																																																				
4	+ 24 V	V1 (VLOG)																																																				
5	+ 24 V	V2 (VAUX)																																																				
Pin	Function	Description																																																				
1	+ 24 V	V1 (VLOG)																																																				
2	0 V	GND V2 (VAUX)																																																				
3	0 V	GND V1 (VLOG)																																																				
4	+ 24 V	V2 (VAUX)																																																				
5	PE	Protective Earth																																																				

*PE – Protective Earth

P2H Ethernet Node 32 DO - Power Scheme 1 Option "A"

- All 32 addresses are controlled in the same power zone
- Safety zoning is possible for valve solenoids and, with the H ISO Universal valves, pneumatic pressure
- Power zone is safe power capable

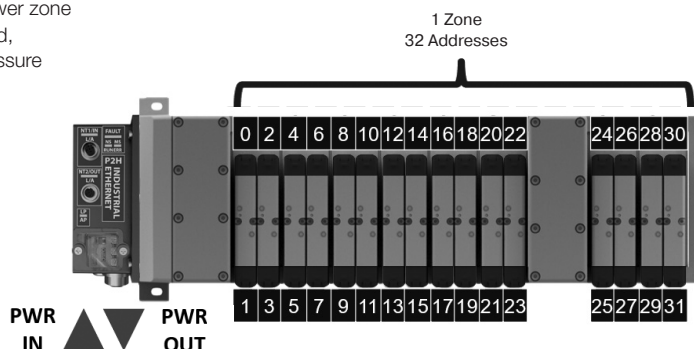

Power Scheme 2 Option "L"

- The 1st 24 addresses are supplied by auxiliary voltage power. The last 8 addresses are supplied by the logic voltage power.
- Each zone has an isolated safe ground pin so each can be powered by a SAFE 24 VDC auxiliary source in PP or PM mode. NOTE: You can treat each zone as a separate power zone/safe zone. Be aware that the last 8 addresses will be supplied by logic power. If power is shut down to this zone the P2H Ethernet module loses power and communication. This may cause extra time to reconnect to the network when power is restored.

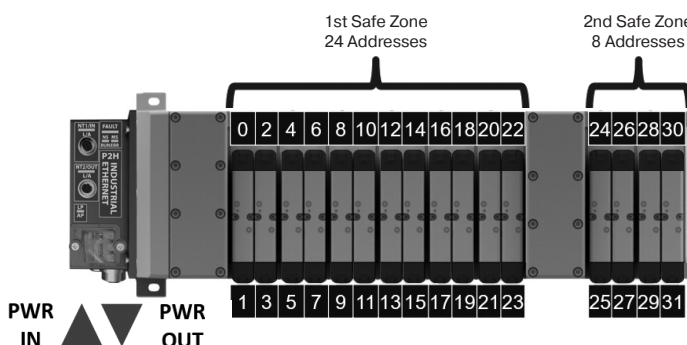

Industrial Ethernet Options



Expansion Module / Power Source	
Power Source for Output 25-32: AUX Power	A
Power Source for Output 25-32: Logic Power	L

P2H Ethernet Node 32 DO - Safe Power Connectivity



P2H Ethernet Node connection to SAFE Power PP / PM mode for valve control

The P2H Ethernet Node 32DO Auxiliary Power for valves can be supplied from an OSSD (Output Signal Switching Device) 24 VDC safe output power source in PP (plus plus) or PM (plus minus) configurations. The connection diagram below represents power option "A". For power option "L" valve driver number 4 power would be supplied from the logic pins of the connection selected (please reference the power pinout diagram).

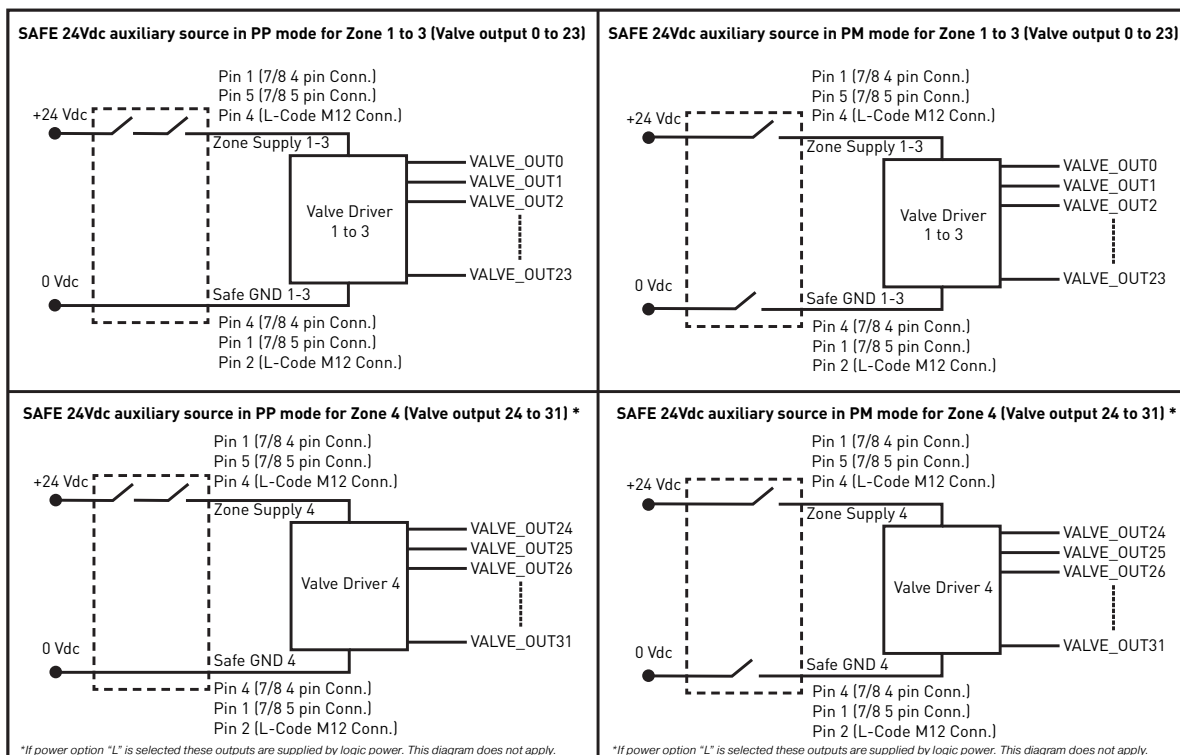

Note: Please check max. power available from the source. Refer to the ["Auxiliary power consumption calculation" section](#).

* 7/8" logic power has no connection to internal P2H unit but does carryover to OUT 7/8" connector (for jumper logic power only).

Logic power for P2H unit will be supplied from M12 (pin 1 & 3).

P2H Ethernet Node 32 DO - Auxiliary Power Consumption Calculation

The P2H Node 32DO auxiliary power consumption calculation depends on the combination of the valves selected and the number of coils used. The table below can be used for power consumption calculation by valve type and the number of each type used. Take note that there are two types of coils for sizes 1,2,3. An energy efficient coil and standard coil.

Valve Range	Number of Pilots Simultaneously powered	Power	Total
H ISO - 15407-2 - Sizes 02 & 01	_____	x 40 mA	= _____ mA
H ISO - 5599-2 - Sizes 1, 2 & 3 (Energy Efficiency Coils) *	_____	x 54 mA	= _____ mA
H ISO - 5599-2 - Sizes 1, 2 & 3 (Standard Coils) **	_____	x 133 mA	= _____ mA
		Total :	_____ mA

* F9 Valve Voltage Code

** B9 Valve Voltage Code

Power Supply Diagnostics

Power Supply Diagnostics through LED

The P2H Node 32DO monitors the logic and auxiliary power supply voltages and manages two levels of diagnostics: warning and error range. Status is indicated via LEDs located on the device. The range limits can be modified through parameter data.

To restore default value (factory setting), refer to "Factory Reset Section" in the manual.

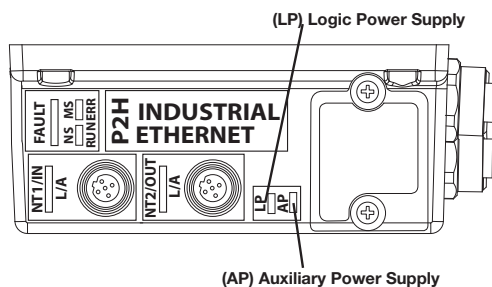

LED function details:

- "Logic power" or "Aux power" error is active from 9.6 to 19.4 VDC or above 28.5 VDC
- When "Logic power error" or "Aux power error" is active, LED is solid red

LP and AP (Green / Yellow) LEDs		
LED Status	Description	Troubleshooting
OFF	Logic and/or Aux lines not powered	Check power supply (see Power Supply section for pin assignments)
ON (Green)	Voltage in normal range	N/A
ON (Red)	Voltage in error range (too low or too high)	Check power supply (see Power Supply section for pin assignments)
Blinking (Red)	Voltage in warning range (out of normal range, not in error range)	Check power supply (see Power Supply section for pin assignments)
Blinking (Yellow)	Invalid rotary switch setting	Check rotary switch setting
Blinking (Red / Yellow)	Firmware version error or Completed "Reset to Factory" procedure	If switches setting different from "999" and no "Reset to Factory" performed via webpage, then contact technical support

Power Supply Diagnostics through Network and Process Data Mapping

Diagnostics are available in Process Input data (byte 0) to indicate whether Logic and Auxiliary voltages are within range. There is a warning range (normal operation with fault indication) and an error range (module enters Failsafe state).

The default warning range is set as 20.4 VDC < power supply < 26.4 VDC. These limits can be modified via acyclic data, objects #11 and #12. The error range is set as 19.4 VDC < power supply < 28.5 VDC. These limits cannot be modified.

The voltage measured by the module, both Logic and Auxiliary, can be accessed via acyclic data, in Object #4. The displayed value is in mV.

P2H Ethernet Node 32 DO - Process Data mapping - Inputs

The following tables describes the input mapping for P2H Ethernet Node. The byte mapping order varies by protocol please reference the manual for specific byte order arrangement.

Channel Error – Input Mapping

Byte #	Input Bits								Description
	7	6	5	4	3	2	1	0	
1	EV07	EV06	EV05	EV04	EV03	EV02	EV01	EV00	Valve Error Data
2	EV15	EV14	EV13	EV12	EV11	EV10	EV9	EV08	
3	EV23	EV22	EV21	EV20	EV19	EV18	EV17	EV16	EVxx = Output on Valve range is 0 to 31
4	EV31	EV30	EV29	EV28	EV27	EV26	EV25	EV24	

Module Info Flags - Input Mapping

Byte #	Output Bits	Module Info Flags	
		Error Name	Error Description
1	0	Heartbeat not toggling AUX 1	Heartbeat is currently not toggling
	1	Heartbeat not toggling AUX 2	
	2	SPI COM Error AUX 1	Error in SPI Communication between AUX and Logic. Outputs are switched off
	3	SPI COM Error AUX 2	
	4	SPI COM Lost AUX 1	
	5	SPI COM Lost AUX 2	Communication not possible. Outputs are switched off
	6	Output Interconnect Error	
7	SPI NP40 Error	Error in communication between Logic and Comm	
2	0	NP40 Version Error	Comm Module Version error. Outputs are switched off
	1-7	Reserved	These bits will be always set as 0

Module Error Input – Input Mapping

Byte #	Output Bits	Module Error Input	
		Error Name	Error Description
1	0	AUX Voltage Warning	Set if Auxiliary Voltage in warning range. Module keeps normal operation
	1	AUX Voltage Error	Auxiliary Voltage in Error range. Outputs are switched OFF
	2	Logic Voltage Warning	Set if Logic voltage is out of range for warning.
	3	Logic Voltage Error	Set if Logic voltage is out of range for error. Outputs are switched OFF
	4	Temperature Warning	Set if a temperature increase above warning levels is detected by the output drivers
	5	Output Driver Channel Error	Set if a major fault is detected at the output stage – solenoid short circuit. Outputs are switched OFF
	6	Module Error	Set if an internal communication error is active
7	Auxiliary Power Not Available	Auxiliary Power is off	
2	0 - 7	Reserved	These bits will be always set as 0

P2H Ethernet Node 32 DO - Process Data mapping - Outputs

The following tables describes the input mapping for P2H Ethernet Node. The byte mapping order varies by protocol please reference the manual for specific byte order arrangement.

System Command – Output Mapping

System Command Module									
Byte #	Output Bits								Description
	7	6	5	4	3	2	1	0	
1	System Command Value								One Byte that accepts the system command value see table below for values

Command Value	Command Name	Description
0X02	Store Switching Cycle Counters	When this command is executed, the current values of the switching cycle counters are stored into EEPROM. This command is intended to be used before powering off the device.
0X03	Store Diagnostic Log	When this command is executed, the diagnostic log is stored to the EEPROM.
0X04	Delete Diagnostic Log	Removes all diagnostic log entries in EEPROM (required by webpage).

Solenoids – Output Mapping

Solenoid Module									
Byte #	Output Bits								Description
	7	6	5	4	3	2	1	0	
1	EV07	EV06	EV05	EV04	EV03	EV02	EV01	EV00	Valve Output Data EVxx -> Output on Valve range is 0 to 31
2	EV15	EV14	EV13	EV12	EV11	EV10	EV09	EV08	
3	EV23	EV22	EV21	EV20	EV19	EV18	EV17	EV16	
4	EV31	EV30	EV29	EV28	EV27	EV26	EV25	EV24	

P2H Ethernet Node 32 DO - Solenoid Addressing

- The P2H Ethernet Network Node can support up to 32 addresses as shown
- Addresses 24-31 can be accessed using an Intermediate Air Supply with Electric Expansion
- Each address is one solenoid

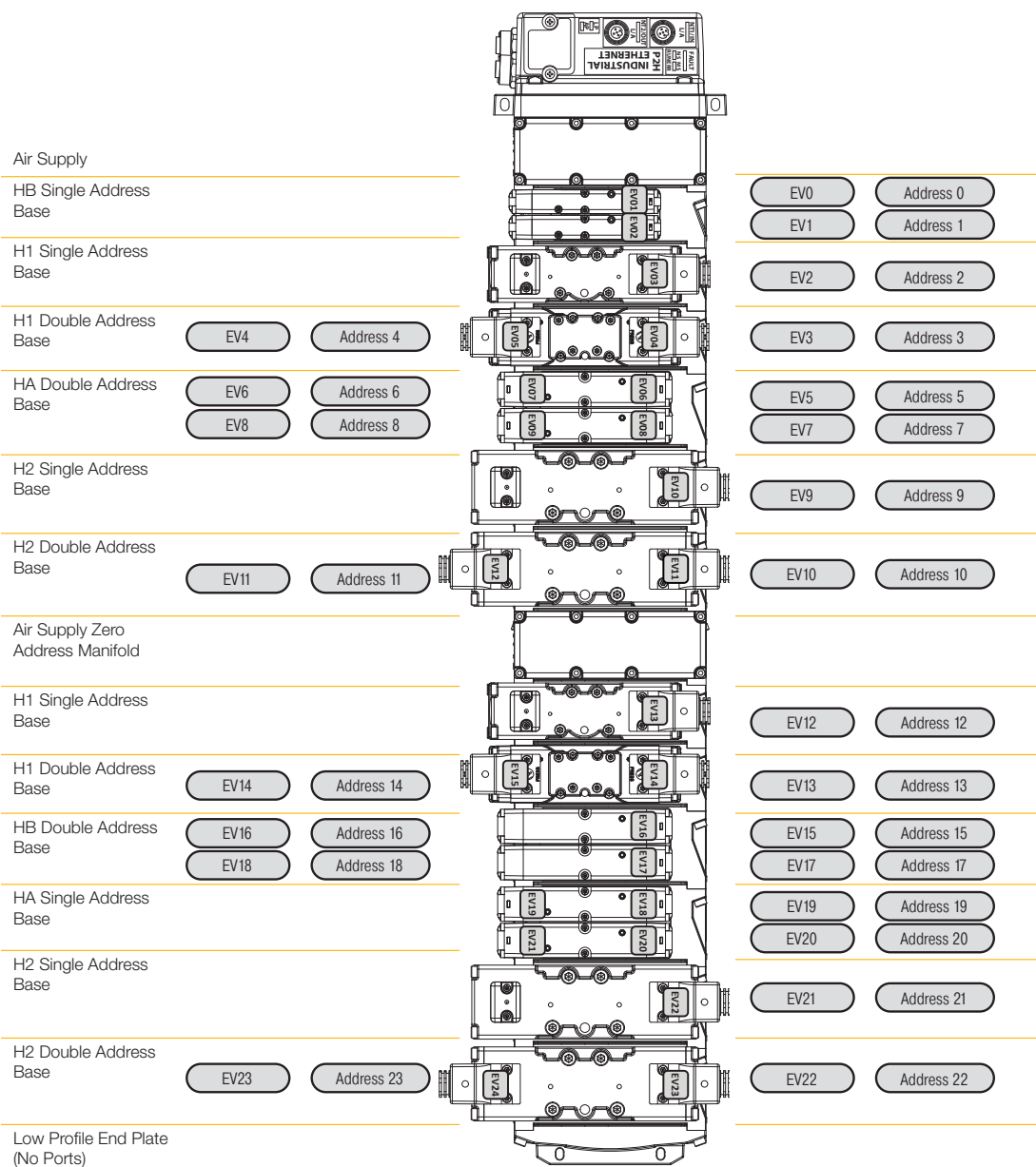

P2H Ethernet Node 32 DO - Technical Data

Mechanical Data

Housing Material	Housing /Enclosure: PBT with 33% GF and UL94-V0 Base Cover (plate): Aluminium 380
Enclosure rating	IP 65 (only when plugged-in and threaded-in)
Power Connectors	7/8" 4 pin or 7/8" 5 pin or L-Coded M12 5-pin male and female pin connector
Dimensions (L x B x H in mm)	226.6mm x 130.7mm x 55mm
Mounting type	Screw Mount
Ground strap attachment	M5
Weight	Approx. 1.3 kg

Operating Conditions

Operating Temperature	0°C to 50°C
Storage Temperature	-25°C to 70°C
CE as per	IEC 61000-6-2 (Industrial Immunity)
	IEC 61000-6-4 (Industrial Emission)
Shock/Vibrations	IEC 60068-2-27:2008
	IEC 60068-2-6:2007
Electrostatic Discharge	IEC 61000-4-2
Electrical Fast Transient/ Burst	IEC 61000-4-4
Surge Immunity	IEC 61000-4-5

Electrical Data

Supply Voltage	24VDC (-15% to +20%)
Logic current at 24 V (V1)	Max Current 8A – Actual usage depends on configuration
Auxiliary current at 24 V (V2)	Max Current 12A – Actual usage depends on configuration

Valve Configuration

Compatible Valves	H Universal ISO Valves
-------------------	------------------------

P2H Ethernet Node 32 DO - H Series ISO Valves

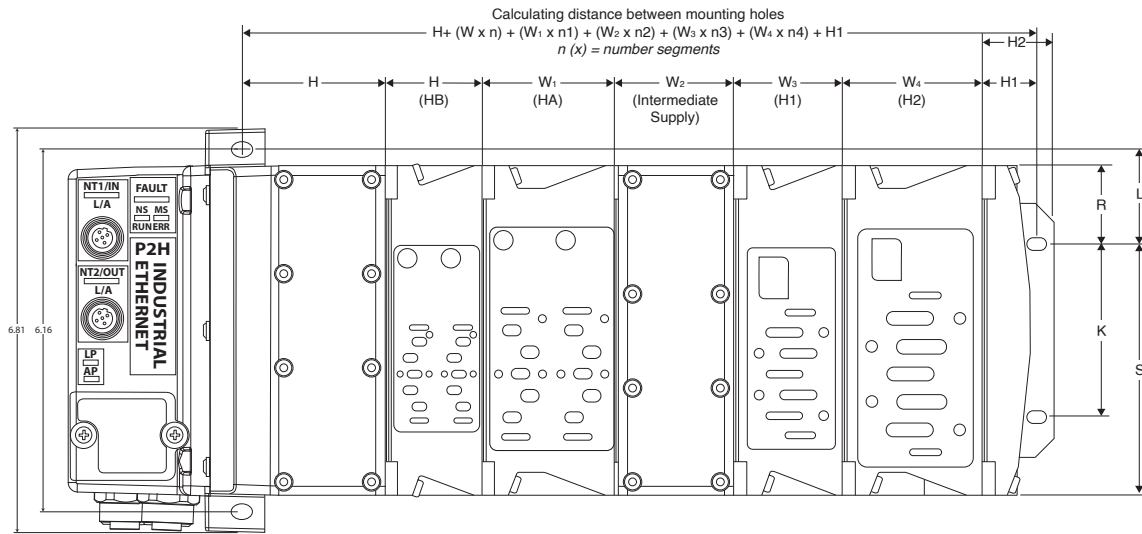

n (x) = number of segments

A	B	C	D	E	F	G	H	H1	H2	J	K	L
4.42 (112.3)	2.64 (67.1)	2.46 (62.5)	1.17 (29.7)	.55 (14)	9.32 (236.7)	1.51 (38.4)	2.36 (59.9)	.9 (22.9)	1.22 (31)	1.55 (39.4)	2.95 (74.9)	1.6 (40.6)
M	O	P	Q	R	S	T	W	W1	W2	W3	W4	
8.91 (226.3)	5.61 (142.5)	6.86 (174.2)	6.18 (157)	1.33 (33.8)	4.28 (108.7)	7.14 (181.4)	1.63 (41.4)	2.28 (57.9)	2.03 (51.6)	1.82 (46.2)	2.39 (60.7)	

Inches (mm)

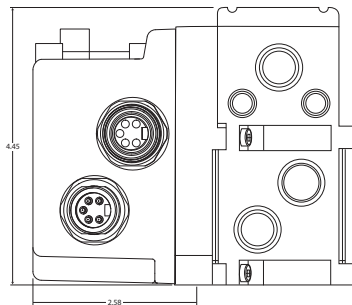

PCH Network Portal

Features

- Industrial Ethernet Communication
- Truly Configurable I/O
- Feature Rich Webserver
- Built-In Technician
- 3 Available Module Variants, 4 ports each
- Bluetooth Connectivity
- Flexible power connectors allowing daisy chain
- Certified to IP65 ingress protection
- Weld splatter resistant housing material
- Welding Noise Immune
- Safe Power Capable
- Built-in configurable IO-Link Master Ports

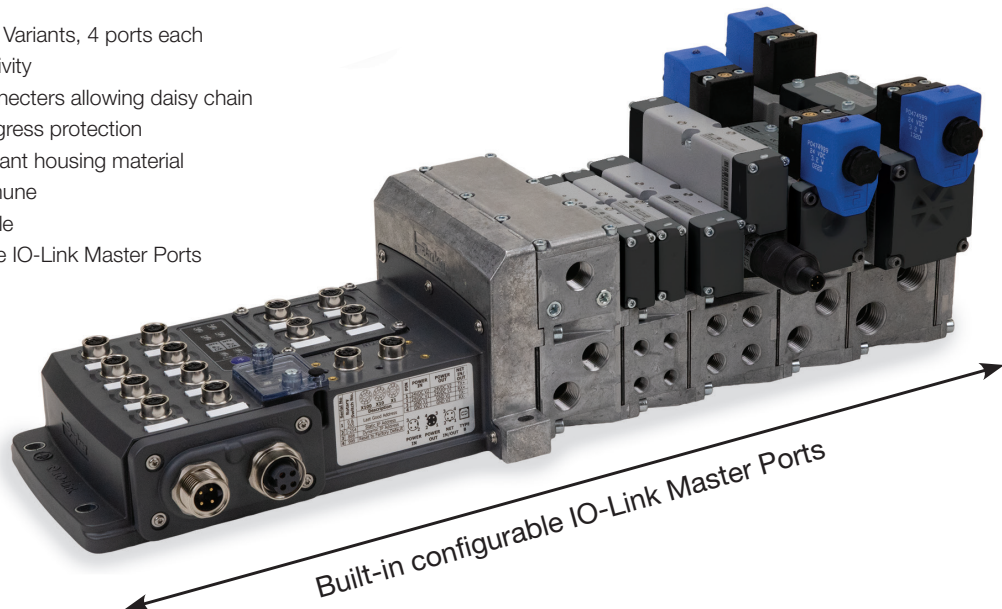

The PCH Network Portal redefines and revolutionizes decentralized machine I/O's architecture. The PCH Network Portal was engineered to support industrial ethernet protocols and the open protocol IO-Link with configurable inputs/outputs with true PNP/NPN circuitry switching on each port for easy machine design changes. This integrated configurability gives the user flexibility in designing custom I/O architecture on the fly.

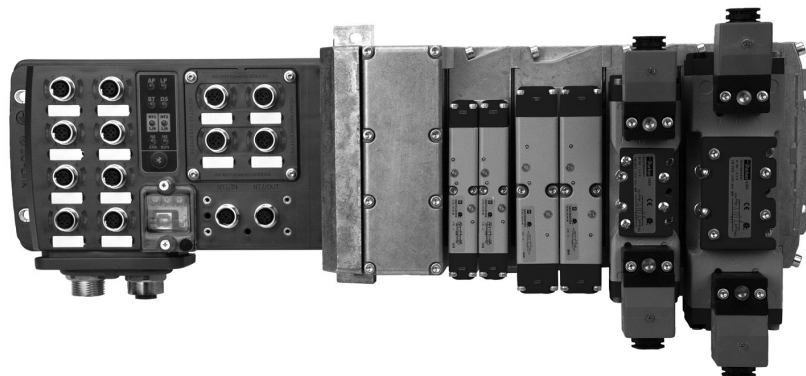

EtherNet/IP™

PROFINET
INDUSTRIAL ETHERNET

EtherCAT®

Modbus
TCP/IP

The PCH Network Portal can be assembled to Parker's H ISO Universal Manifold Platform, giving you access to a wide variety of low ranges all on one manifold.

Intuitive Interfaces

Modern factories recognize that plant floor architecture is an important structural part of machine design that can make a real difference in managing costs for future changes, integrations and expansions. The PCH Network Portal design team lived in this environment, therefore intuitive interfaces and complete modularity was the heart of PCH Network Portal design concepts.

As with all Cyber Physical Systems (CPS), intuitive interfaces are the backbone of simplicity in application. The PCH Network Portal offers several means of intuitive and embedded interfaces to shorten commission time.

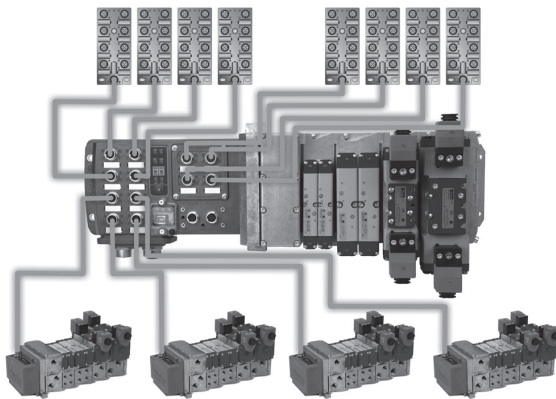
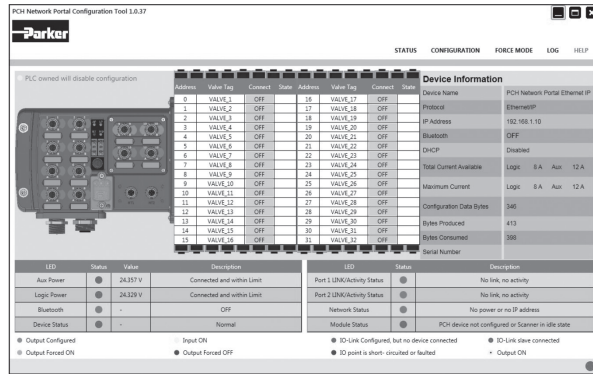

Value Redefined

The PCH Network Portal minimizes machine costs by redefining the traditional process of connectivity within a single footprint that provides multiple configurations. The flexibility of configurable I/O combined with built-in IO-Link master ports revolutionizes machine design and can save thousands of dollars at the design phase which typically accounts for 30-40% of overall costs. Changes can be made to the system with easy software reconfiguration of ports eliminating the need for additional hardware or time consuming programming.



Can't access the PLC? No Problem!

With meticulously designed embedded configuration tools, the PCH Network Portal can serve as your virtual technician to make problems easy to troubleshoot. A laptop, tablet or phone can access usable prognostic/diagnostic data and time stamped event logs to make accessing data and commissioning your machine simple. Once you've finished your configuration, the device's configuration profile can be downloaded and easily uploaded to other PCH Network Portals on your machine.

Configure via:

- Bluetooth App via phone or tablet
- Bluetooth connection via PC
- Integrated Webpage via ethernet connection
- Stand-a-lone "PCH Portal Configuration Tool" software via USB-B

Safety Foot Note:

Bluetooth application cannot turn on outputs if a PLC where present and in control. The application cannot override the PLC at any time.

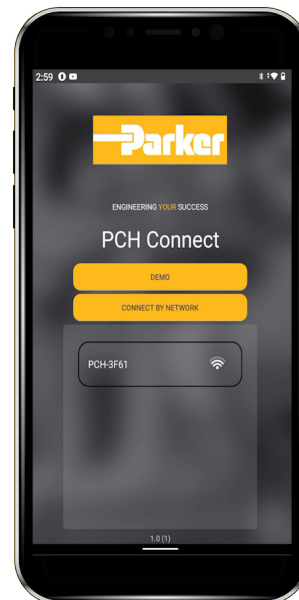

Truly Configurable I/O

Configurable I/O means last minute design changes are now simple. Each PCH Network Portal is offered with three selectable modules that make up twelve configurable ports. All modules can be configured IO-Link A, IO-Link B or dual configurable I/O ports with true PNP/NPN circuitry switching on each port providing easy point and click changes on individual pins to customize a setup. Last minute design changes to the machine require minimal effort and no additional software or hardware. The ability to customize the machine design is no longer limited by the product.

Port Config

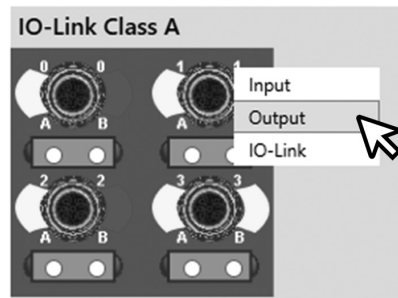

Tools Designed for Productivity

When a line stops and needs a reset you are often left wondering why. The root cause can seem a mystery and often stems back to over voltage or other power issues caused by the plant floor. Working with the PCH Network Portal is like having your own built-in technician. Rolling 40 errors, warnings and events are time and date stamped allowing you to spend time on what matters - running the facility. Let PCH Network Portal give you the detail so time can be better utilized elsewhere.

Built-In Technician

When using the 'PCH Portal Configuration Tool' your built-in technician comes to life with easy to follow screens for readouts, adjustments, and settings. Configuring the PCH Network Portal to the network is easy. Fast and storable configurations combined with embedded smart diagnostic and prognostic tools like built-in debounce times and up/down counters translate to quick change-over and short downtime. Further problems are easy to spot with the rolling 40 error, warnings, and events log which are time stamped. No more guessing at what went wrong in plant. Commissioning and troubleshooting a tool can even be done remotely from outside the work cell via the device's secure and lockable Bluetooth connectivity.

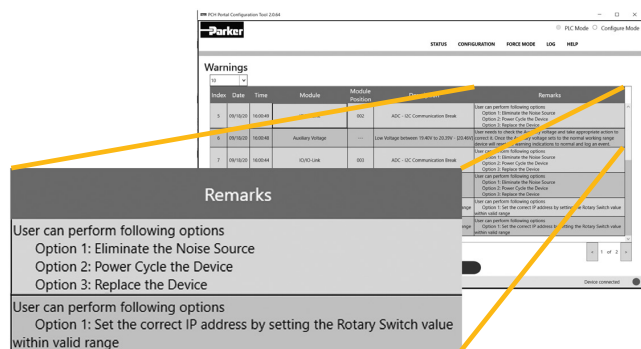

Value Redefined

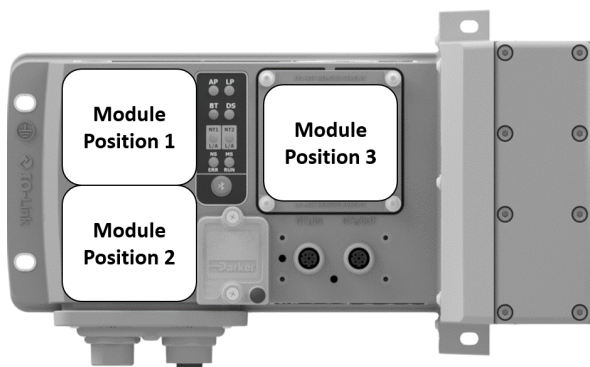

What are Module Positions?

- The PCH Network Portal is split into 3 Module Positions
- Each Module Position can accept different Module Variants to meet the application needs
- Populating a Module Position with an I/O Module Variant gives the PCH Network Portal 4 configurable M12 ports

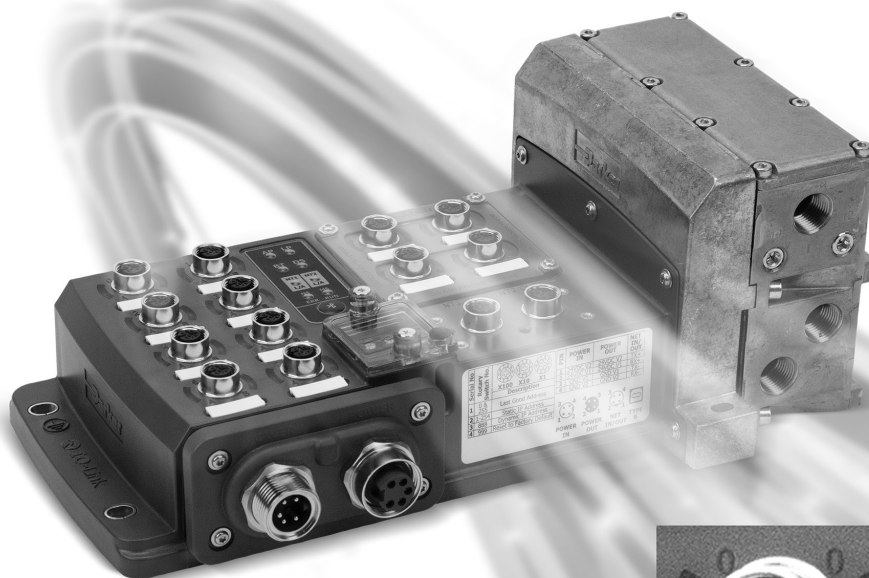

What is a Module Variant?

- 3 Module Variant are proposed offering each different capabilities (see details of Modules Variant A, B or C in next pages)
- A Module Variant offers 4 configurable M12 ports
- Depending on the Module Variant A, B or C selected, each M12 port can be individually configured differently between a variety of different behaviors

For Example

- With the Module Position 1 populated with Module Variant A, each M12 port can be individually configured as either IO-Link Class A Master or 2 Digital Inputs or 2 Digital Outputs
- A summary of the Module Variant offerings is on page 118

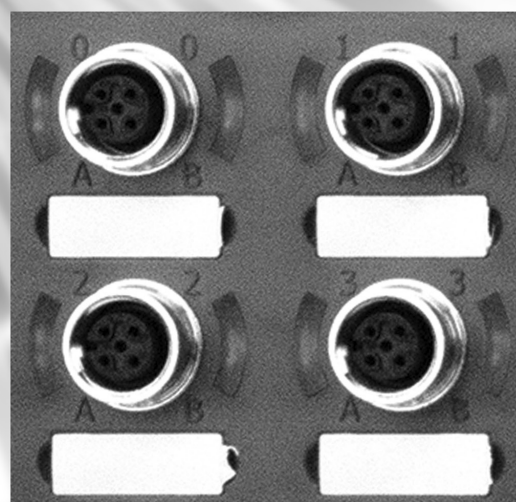

PCH Network Portal

Module Variants

Module
A

What is a Module Variant?

- The PCH Network Portal has 3 available Module Positions. Each module position can be populated with three different Module Variants
- Each Module Position can accept all module variants

Port Behavior

- Each port is capable of the following behavior listed below
- Through software, the user can click and change how the port behaves on the fly
- The A Module Variant gives the user access to IO-Link Class A Master ports



Possible Port Behavior

IO-Link, Class A Master or
 2 x Digital Inputs or
 2 x Digital Outputs*

IO-Link, Class A Master or
 2 x Digital Inputs or
 2 x Digital Outputs*

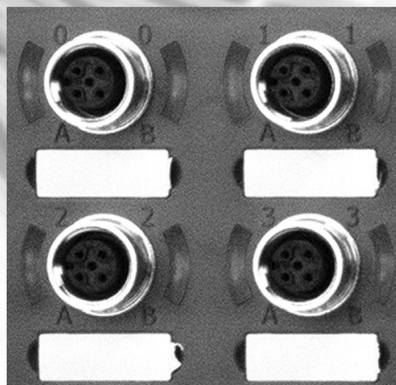

IO-Link, Class A Master or
 2 x Digital Inputs or
 2 x Digital Outputs*

IO-Link, Class A Master or
 2 x Digital Inputs or
 2 x Digital Outputs*

*Digital Output draws current from logic power

Port Behavior

- Each port's behavior can differ from one another
- For example, the user can select the behavior listed below through software (shown below)

IO-Link, Class A Master or
2 x Digital Inputs
 2 x Digital Outputs

IO-Link, Class A Master or
 2 x Digital Inputs or
2 x Digital Outputs

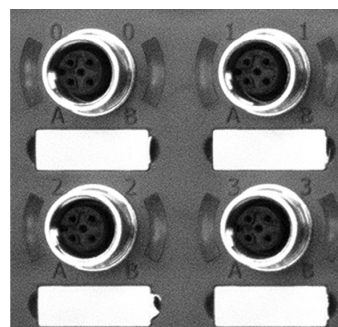

IO-Link, Class A Master
 2 x Digital Inputs or
 2 x Digital Outputs

IO-Link, Class A Master or
 2 x Digital Inputs or
2 x Digital Outputs

PCH Network Portal

Module Variants

Module
B

What is a Module Variant?

- The PCH Network Portal has 3 available Module Positions. Each module position can be populated with three different Module Variants
- Each Module Position can accept all module variants

Port Behavior

- Each port is capable of the following behavior listed below
- Through software, the user can click and change how the port behaves on the fly
- The B Module Variant gives the user access to IO-Link Class B Master ports



Possible Port Behavior

IO-Link, Class B Master or
 1 x Digital Input or
 1 x Digital Output*

IO-Link, Class B Master or
 1 x Digital Input or
 1 x Digital Output*

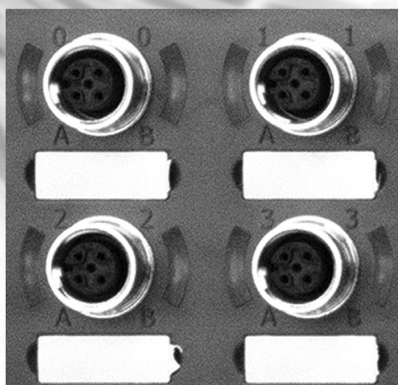

IO-Link, Class B Master or
 1 x Digital Input or
 1 x Digital Output*

IO-Link, Class B Master or
 1 x Digital Input or
 1 x Digital Output*

*Digital Output draws current from logic power

Port Behavior

- Each port's behavior can differ from one another
- For example, the user can select the behavior listed below through software (shown below)

IO-Link, Class B Master or
1 x Digital Input
 1 x Digital Output

IO-Link, Class B Master or
 1 x Digital Input or
1 x Digital Output

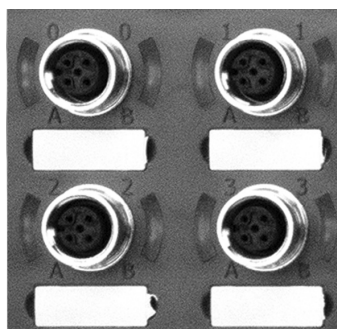

IO-Link, Class B Master
 1 x Digital Input or
 1 x Digital Output

IO-Link, Class B Master or
 1 x Digital Input or
1 x Digital Output

PCH Network Portal

Module Variants



What is a Module Variant?

- The PCH Network Portal has 3 available Module Positions. Each module position can be populated with three different Module Variants
- Each Module Position can accept all module variants

Port Behavior

- Each port is capable of the following behavior listed below
- Through software, the user can click and change how the port behaves on the fly
- The C Module Variant gives the user access to IO-Link Class B Master ports and fixed high current outputs



Possible Port Behavior

2 x Digital Outputs, 500 mA each, Fixed ¥

IO-Link, Class B Master or
 1 x Digital Input or
 1 x Digital Output*

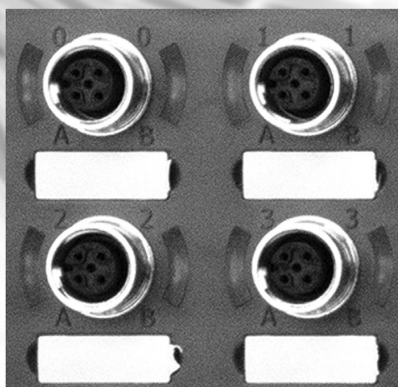

2 x Digital Outputs, 500 mA each, Fixed ¥

IO-Link, Class B Master or
 1 x Digital Input or
 1 x Digital Output*

¥ Digital Outputs draw current from auxiliary power
 * Digital Output draws current from logic power

Port Behavior

- Each port's behavior can differ from one another
- For example, the user can select the behavior listed below through software (shown below)

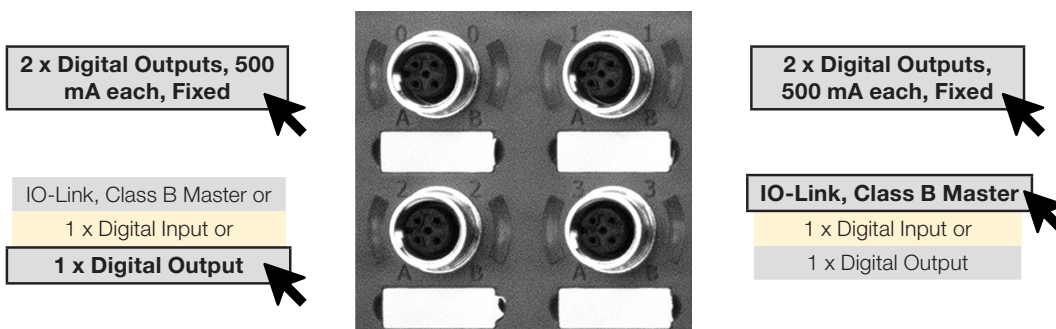

I/O Module Combinations

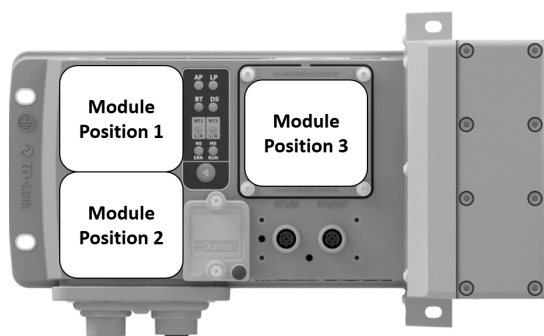

- The PCH Network Portal gives true port flexibility
- The PCH Network Portal can be ordered with 3 available module variants
- Each module variant has 4, M12 Ports
- Each module variants can be chosen in any module position
- Each port is individually software configurable
- A blanking plate is available for Module Position 3
- **Important:** Once Module Variants are selected on the PCH Network Portal, they cannot be changed in the field

Before it comes through your door
Select which Module Variant you want in each
Module Position



After it comes through your door
Truly Configurable I/O - Select port behavior
from listed options

Module Variants

Module
A



- IO-Link, Class A Master **OR**
- 2 Inputs, PNP/NPN **OR**
- 2 Outputs, 250 mA ea



- IO-Link, Class A Master **OR**
- 2 Inputs, PNP/NPN **OR**
- 2 Outputs, 250 mA ea



- IO-Link, Class A Master **OR**
- 2 Inputs, PNP/NPN **OR**
- 2 Outputs, 250 mA ea



- IO-Link, Class A Master **OR**
- 2 Inputs, PNP/NPN **OR**
- 2 Outputs, 250 mA ea

Module
B



- IO-Link, Class B Master **OR**
- 1 Input, PNP/NPN **OR**
- 1 Output, 250 mA ea



- IO-Link, Class B Master **OR**
- 1 Input, PNP/NPN **OR**
- 1 Output, 250 mA ea



- IO-Link, Class B Master **OR**
- 1 Input, PNP/NPN **OR**
- 1 Output, 250 mA ea



- IO-Link, Class B Master **OR**
- 1 Input, PNP/NPN **OR**
- 1 Output, 250 mA ea

Module
C



- 2 Outputs, 500 mA ea



- 2 Outputs, 500 mA ea



- IO-Link, Class B Master **OR**
- 1 Input, PNP/NPN **OR**
- 1 Output, 250 mA ea



- IO-Link, Class B Master **OR**
- 1 Input, PNP/NPN **OR**
- 1 Output, 250 mA ea

Module
N

Blank Cover, No Ports, Only available in Position 3

I/O Module Combinations

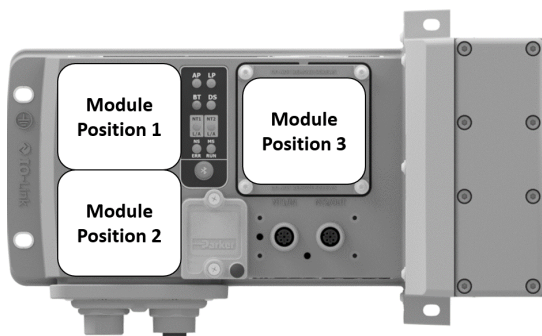

- Below are 16 standard module combinations
- For simplicity, similar combinations of modules are consolidated into one combination

For Example:



Example Model Structure



Below are the standard module configurations

Refer to page 14 for full product Module Structure.

Order Code	Module Position 1	Module Position 2	Module Position 3
AAA	A	A	A
AAB	A	A	B
AAC	A	A	C
AAN	A	A	N
ABB	A	B	B
ABC	A	B	C
ABN	A	B	N
ACC	A	C	C
ACN	A	C	N
BBB	B	B	B
BBC	B	B	C
BBN	B	B	N
BCC	B	C	C
BCN	B	C	N
CCC	C	C	C
CCN	C	C	N

For any module configurations not listed, consult factory.

Power Options

- The PCH Network Portal has 4 available power connectors
- There are two power schemes that can be achieved detailed below
- Any I/O ports using AUX power and any attached H ISO Universal manifold valves draw power from the AUX power pins of the power connector

Consumption @ 24 VDC

AUX power max consumption	12A
Logic power max consumption	8A
Total possible passthrough for AUX line and Logic	20A

Any power left over can be passed on to other devices on the network



Power Connector *	
4-pin power in/out with 1 safe power capable zone	P4
5-pin power in/out with 1 safe power capable zone	P5
4-pin power in/out with 2 safe power zones	S4
5-pin power in/out with 2 safe power zones	S5
AIDA power in/out with 1 safe power capable zone	J1*

* Only available with Profinet AIDA

Power Scheme 1

- All 32 addresses are controlled in the same power zone
- Safety zoning is possible for valve solenoids and, with the H ISO Universal valves, pneumatic pressure
- Power zone is safe power capable
- Available in 4 or 5-pin 7/8" power connectors

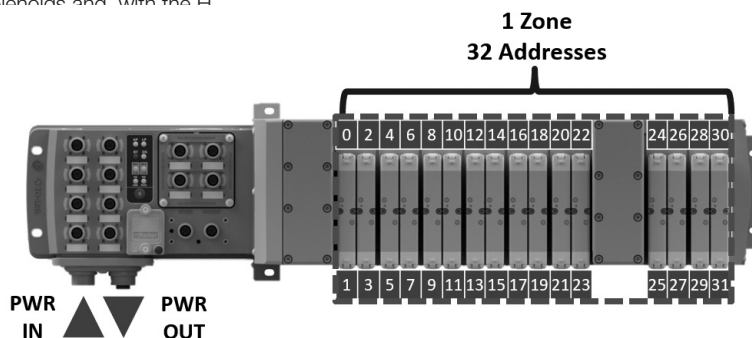

Power Scheme 2

- The power connector separates the valve power
- Each zone has an isolated safe ground pin so each can be powered by a SAFE 24 VDC auxiliary source in PP or PM mode
- Available in 4 or 5 pin 7/8" power connectors

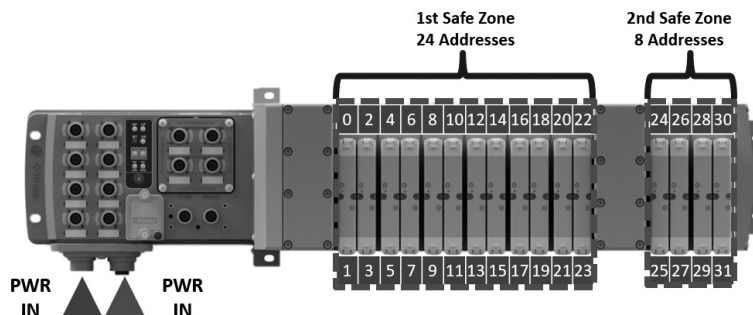

End Plate Kit – Universal Plug-in

The PCH Network Portal is ordered as an endplate kit. This includes the PCH Network Portal, left hand air supply module, and right hand end plate.

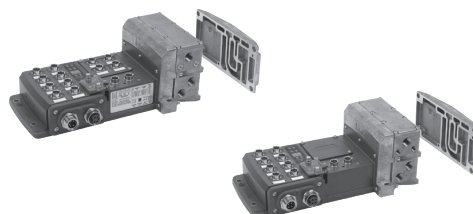

PSHU20 P3 0 0 P E AAA 0 - P4

Valve Type	
Plug-in (Internal pilot)	PSHU20
Plug-in (External pilot)	PSHU2X

Thread Type	
NPT	0
BSPP "G"	1

Network Connections	
EtherNet/IP	E
EtherCAT	T
PROFINET	N
PROFINET AIDA	A
Modbus TCP	M

Power Connector *	
4-pin power IN/OUT with 1 safe power capable zone	P4
5-pin power IN/OUT with 1 safe power capable zone	P5
4-pin power IN/IN with 2 safe power zones	S4
5-pin power IN/IN with 2 safe power zones	S5
AIDA power IN/OUT with 1 safe power capable zone	J1*

* Only available with Profinet AIDA

Right Hand End Plate Type / Thread Size	
Low profile (no ports)	0
1/2 Exhaust and inlet port	1
3/4 Exhaust and inlet port	2
H3 Transition plate and end plate (electrical pass through for plug-in valves only)	3
H3 Transition plate and end plate (expansion to 25th address for plug-in valves only)	4

Module Combinations		
Module Position 1	Module Position 2	Module Position 3
A	A	A
A	A	B
A	A	C
A	A	N
A	B	B
A	B	C
A	B	N
A	C	C
A	C	N
B	B	B
B	B	C
B	B	N
B	C	C
B	C	N
C	C	C
C	C	N

For any module configurations not listed, consult factory.

Mechanical Data

Housing Material	Housing /Enclosure: PBT with 33% GF and UL94-V0 Base Cover (plate): Aluminum 380
Enclosure rating	IP 65 (only when plugged-in and threaded-in)
Power Connectors	7/8" 4 or 5 pin male and female pin connector
Input ports/ Output ports	M12, A-coded (12 x female)
Dimensions (L x B x H in mm)	226.6mm x 130.7mm x 55mm
Mounting type	Screw Mount
Ground strap attachment	M5
Weight	Approx. 1.3 kg

Operating Conditions

Operating Temperature	0°C to 50°C
Storage Temperature	-25°C to 70°C
CE as per	IEC 61000-6-2 (Industrial Immunity)
	IEC 61000-6-4 (Industrial Emission)
Shock/Vibrations	IEC 60068-2-27:2008
	IEC 60068-2-6:2007
Electrostatic Discharge	IEC 61000-4-2
Electrical Fast Transient/ Burst	IEC 61000-4-4
Surge Immunity	IEC 61000-4-5

Electrical Data

Supply Voltage	24VDC (-15% to +20%)
Logic current at 24 V (V1)	Max Current 8A – Actual usage depends on configuration
Auxiliary current at 24 V (V2)	Max Current 12A – Actual usage depends on configuration

Valve Configuration

Compatible Valves	H Universal ISO Valves
Available addresses	24 addresses, 32 addresses with H Universal Extension Slice

I/O Port Pin Outs

- The PCH Network Portal uses threaded M12 Ports for I/O Connections
- All configurable ports are configurable through software at any time

Module Variant	Connector	Pin No.	Function
A *Applies to ports 1-4 of this module		1	+24V, 500mA VLOG (V1)
		2	Input (PNP or NPN) / Output +24V, 250 mA (V1)
		3	GND (V1)
		4	IO-Link/Input (PNP or NPN) / Output +24V, 250mA (V1)
		5	Not Connected
B *Applies to ports 1-4 of this module		1	+24V, 250mA VLOG (V1)
		2	+24V, 1.2A VAUX (V2)
		3	GND (V1)
		4	IO-Link/Input (PNP or NPN) / Output +24V, 250mA (V1)
		5	GND (V2)
C *Applies to ports 1-2 of this module		1	Not Connected
		2	Output +24VAUX (V2), 500mA
		3	GND (V2)
		4	Output +24VAUX (V2), 500mA
		5	Not Connected
C *Applies to ports 3-4 of this module		1	+24V, 250mA VLOG (V1)
		2	+24V, 1.2A VAUX (V2)
		3	GND (V1)
		4	IO-Link/Input (PNP or NPN) / Output +24V, 250mA (V1)
		5	GND (V2)

Power Connector Pin Outs

- The PCH Network Portal uses 7/8" ports for its left IN and right OUT (P4 & P5) or IN (S4 or S5) power connectors
- Any power configuration below can be ordered

*For AIDA power connector, consult factory

Left Power Connector: Power IN				Right Power Connector:			
P4 & P5 - Power OUT - 1 Valve Safe Zone				S4 & S5 - Power IN - 2 Valve Safe Zones			
Connector	Pin No.	Function	Description	Connector	Pin No.	Function	Description
P4 	1	+24V	V2 (VAUX), 12A		1	+24V	V2 (VAUX), 3.8A
	2	+24V	V1 (VLOG), 8A		2	+24V	V1 (VLOG), 1.28A
	3	0V	GND V1 (VLOG)		3	0V	GND V1 (VLOG)
	4	0V	GND V2 (VAUX)		4	0V	GND V2 (VAUX)
P5 	1	0V	GND V2 (VAUX)		1	0V	GND V2 (AUX)
	2	0V	GND V1 (VLOG)		2	0V	GND V1 (VLOG)
	3	Protective Earth	Protective Earth		3	Protective Earth	Protective Earth
	4	+24V	V1 (VLOG), 8A		4	+24V	V1 (VLOG)
	5	+24V	V2 (VAUX), 12A		5	+24V	V2 (VAUX)
S4 	1	+24V	V2 (VAUX), 12A		1	+24V	V3 (VAUX) 3.8A
	2	+24V	V1 (VLOG), 8A		2	+24V	V4 (VAUX) 1,2 A
	3	0V	GND V1 (VLOG)		3	0V	Safe GND V3 (VAUX)
	4	0V	GND V2 (VAUX)		4	0V	Safe GND V4 (VAUX)
S5 	1	0V	GND V2 (VAUX)		1	+24V	V3 (VAUX) 3.8A
	2	0V	GND V1 (VLOG)		2	+24V	V4 (VAUX) 1,2 A
	3	Protective Earth	Protective Earth		3	Protective Earth	Protective Earth
	4	+24V	V1 (VLOG), 8A		4	0V	Safe GND V3 (VAUX)
	5	+24V	V2 (VAUX), 12A		5	0V	Safe GND V4 (VAUX)

Solenoid Addressing

- The PCH Network Portal can use the following H ISO Universal Valves:
 - ISO 15407-2 – sizes 02 & 01
 - ISO 5599-2 – sizes 1, 2 & 3
- The PCH Network Portal can support up to 32 addresses as shown
- The data map and PCH Tool refers to each address with a Valve_X designator. Each Valve_X designator is as shown.
- Addresses 25-31 can be accessed using an Intermediate Air Supply with Electric Expansion
- Each address is one solenoid

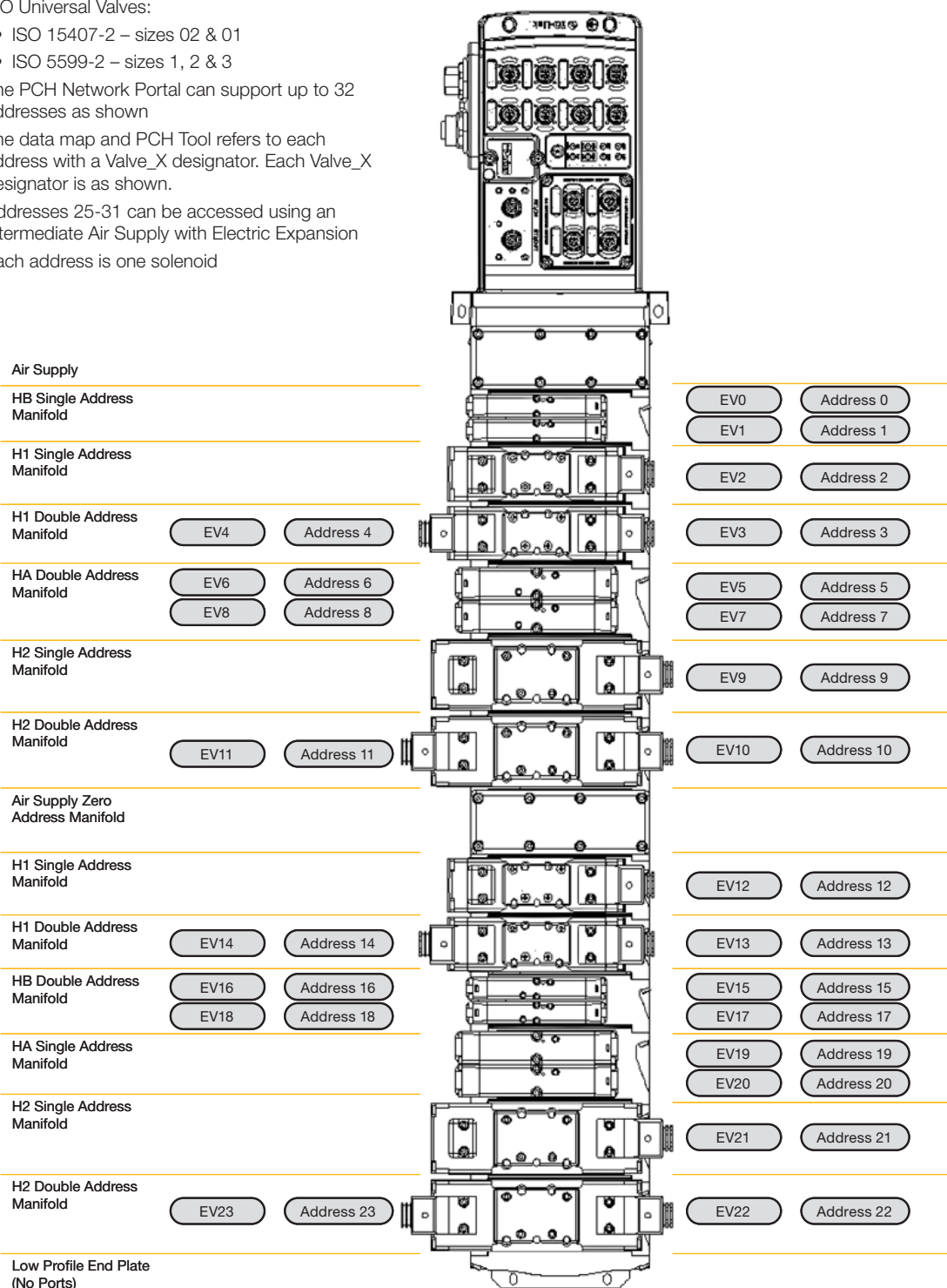

PCH Network Portal with H Series ISO Valves

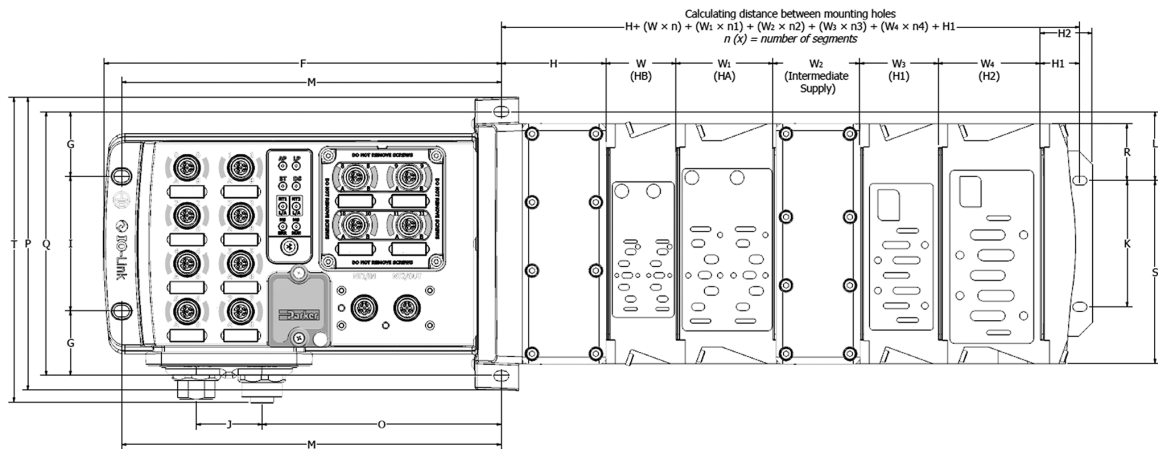

n (x) = number of segments

A	B	C	D	E	F	G	H	H1	H2	J	K	L
4.42 (112.3)	2.64 (67.1)	2.46 (62.5)	1.17 (29.7)	.55 (14)	9.32 (236.7)	1.51 (38.4)	2.36 (59.9)	.9 (22.9)	1.22 (31)	1.55 (39.4)	2.95 (74.9)	1.6 (40.6)
M	O	P	Q	R	S	T	W	W1	W2	W3	W4	
8.91 (226.3)	5.61 (142.5)	6.86 (174.2)	6.18 (157)	1.33 (33.8)	4.28 (108.7)	7.14 (181.4)	1.63 (41.4)	2.28 (57.9)	2.03 (51.6)	1.82 (46.2)	2.39 (60.7)	

Inches (mm)

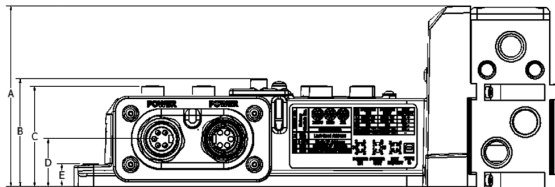

Product Support

- The PCH Network Portal Product Landing page can be accessed at the following:
- The PCH Network Portal support material can be accessed at the following:



www.parker.com/pdn/PCHPortal



www.parker.com/pdn/networkconnectivity

- The PCH Connect - Bluetooth Application



User Manuals

- The PCH Network Portal User Manuals can be accessed at the following website. Click on QR code for hyperlink.

EtherNet/IP™ EtherNet/IP™ User Manual



Profinet User Manual



EtherCAT® EtherCAT User Manual



Modbus User Manual



For more information on IO-link

www.io-link.com

The Turck Network Portal

Turck Network Portal has four major components:

- **Valve Driver Module** provide control for either 16 or 32 solenoids on a manifold
- **I/O Modules** provide the field interface and system-interface circuitry
- **Communication Modules** provide the network-interface circuitry
- **Power Distribution Module** provide 5 additional power inputs to the Turck system

Turck Features

- Highly modular design (4pt – 16pt modularity)
- Broad application coverage
- Expandable 4 port Class A IO-Link master
- Channel-level diagnostics (LED and electronic)
- Channel-level alarm and annunciation (electronic)
- Channel-level open-wire detection with electronic feedback
- Channel-level short-circuit detection with electronic feedback
- Horizontal and vertical mounting without derating
- 5g vibration
- Electronic and mechanical keying
- Robust backplane design
- Quick-disconnects for I/O and network connectivity
- Built-in panel grounding
- Color-coded module labels
- UL, cCSAus, and CE certifications (as marked)
- Highly reliable structural integrity
- Optical isolation between field and system circuits

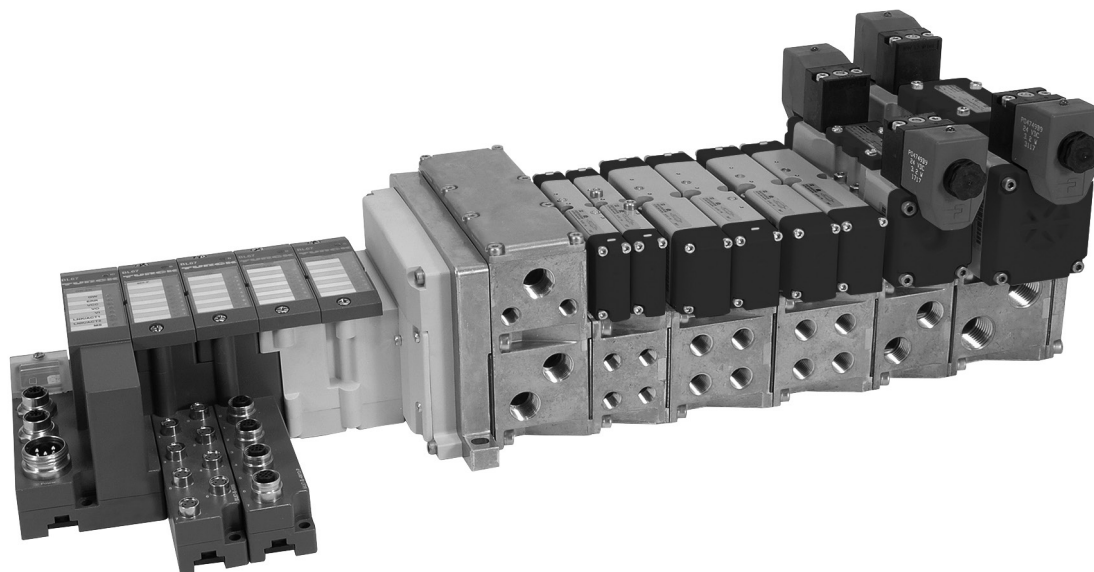

Turck Network Portal

- A complete network communication offering for all H Series ISO and H Series Micro valves
- CSA, cULus and CE certifications (as marked)

I/O Configuration

- Centralized Turck Network Portal
- Pneumatics and I/O are in close proximity with one another
- M23, 12-Pin or 19-Pin output extension to an additional H Series valve manifold
- I/O density per module = 4, 8 or 16

EtherNet/IP™

DeviceNet™

PROFI BUS

PROFI NET

Modbus/TCP™

CANopen

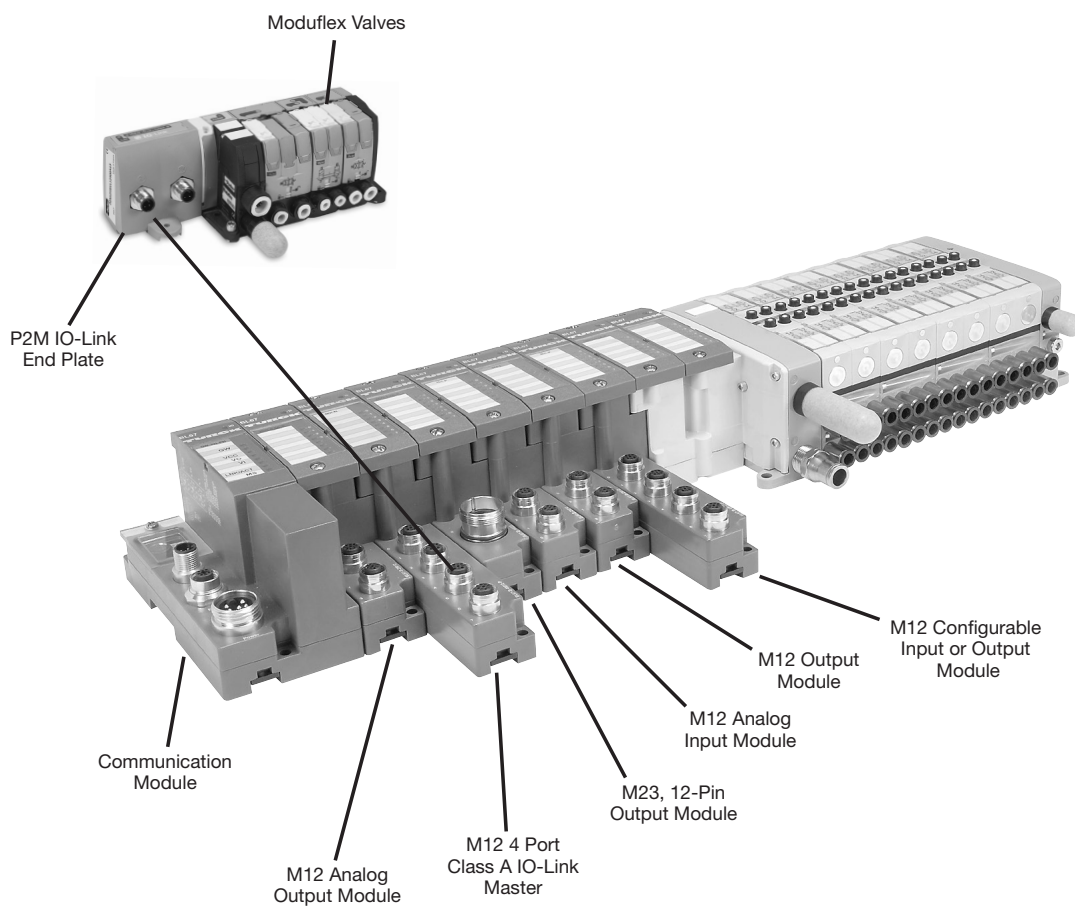

Configure / Program any module with RS232, or directly through Ethernet for any module with an Ethernet physical layer.



Turck Network Portal

- A complete network communication offering for all H Series ISO and H Series Micro valves.
- CSA, cCSAus and CE certifications (as marked).

I/O Configuration

- Complete control of all I/O and valves with stand alone control
- Additional I/O and valves connected over DeviceNet with BL Remote Subnet
- BL Remote connection to P2M and Turck DeviceNet equipped communication modules
- I/O density per module = 4, 8 or 16

EtherNet/IP™

DeviceNet™

PROFIBUS™

PROFINET™

Modbus/TCP™

CANopen

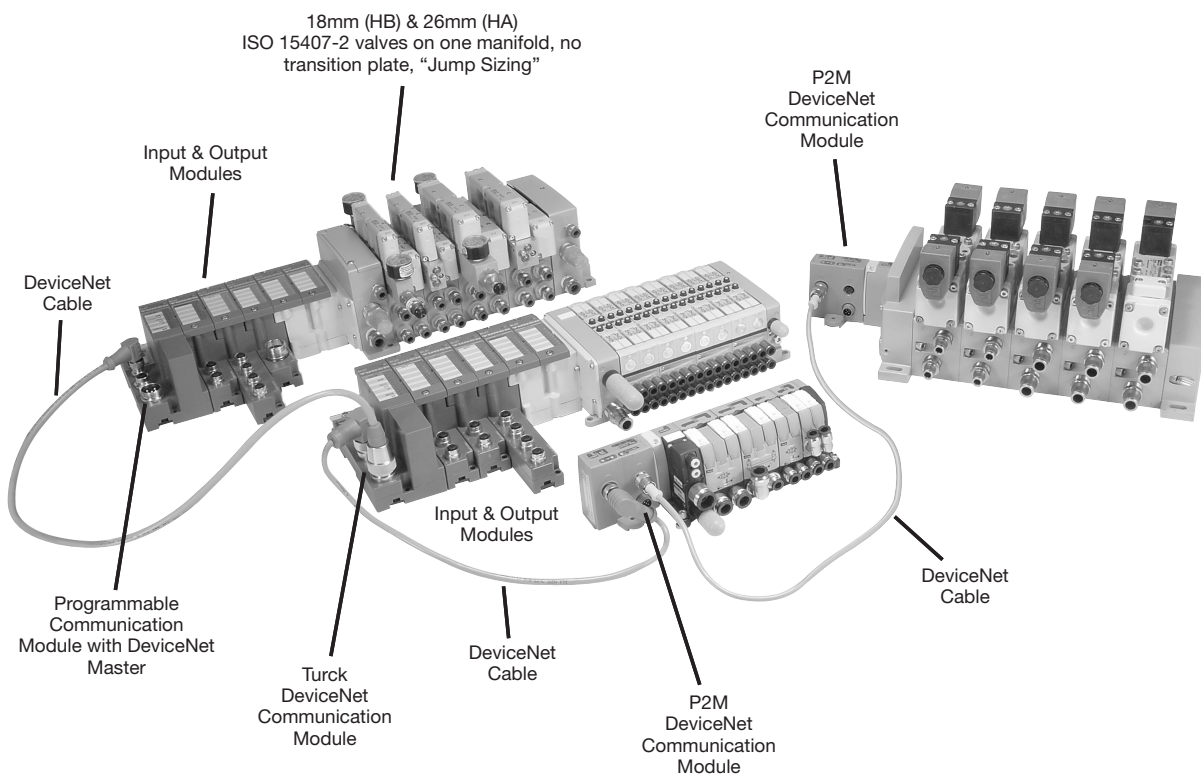

Communications Module

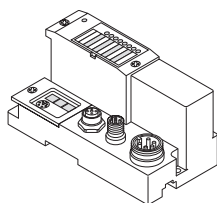

BL67 communication modules are the heart of a BL67 station. They are designed to connect the modular nodes to the higher level network (PROFIBUS-DP, DeviceNet, CANopen, Ethernet).

All BL67 electronic modules communicate over the internal module bus with the communication modules. The communication module structures the data and sends them clustered via network nodes to the higher control system.

This way all I/O modules can be configured independently of the system.

Electronic Module

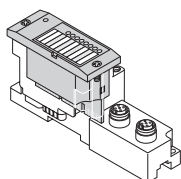

BL67 electronic modules are inserted into the passive base modules from above and then simply affixed with two screws. Maintenance is extremely simplified due to the separation of connection level and module electronics.

Moreover, flexibility is enhanced because the base modules provide different types of connectors. Voltage supply for the electronic modules is either provided via the communication modules or a Power Extender module. Power Extender modules can be used to create galvanically isolated potential groups.

Base Module

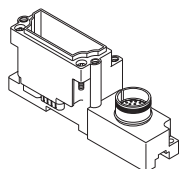

BL67 base modules are aligned one by one to the right of the communication module and are tightened each with two screws, either with the communication modules or with the previous module. A DIN rail is not required. This way a compact and stable unit is created which can be mounted directly on the machine.

The base modules serve for connection of the field devices and are available with different connection types (M8, M12, M23 and 7/8).

A BL67 system can be extended to a total length of 1 m, comprising of a communication module for PROFIBUS-DP, DeviceNet / CANopen or Ethernet and a maximum of 32 modules.

System supply: The power supply for the BL67 system is either derived separately for Profibus-DP and Ethernet communication modules or directly from the DeviceNet / CANopen cable for the DeviceNet / CANopen communication module.

Power Extender modules can be inserted anywhere in the BL67 station. They provide isolated field voltage for the I/O modules mounted to their right.

Thus Power Extender modules can also be used to create different potential groups.

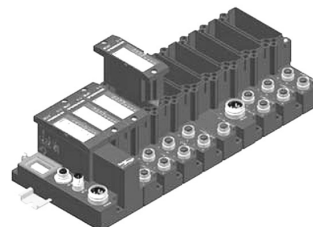

Maximum System Extension

Module type	PROFIBUS		DeviceNet		CANopen		ModbusTCP		EtherNet/IP		PROFIBUS		
	chan.	mod.	chan.	mod.	chan.	mod.	chan.	mod.	chan.	mod.	chan.	mod.	
Digital inputs	4 DI	128	32	128	32	128	32	128	32	128	32	128	32
	8 DI	256	32	256	32	256	32	256	32	256	32	256	32
Digital outputs	4 DO	128	32	128	32	128	32	128	32	128	32	128	32
	8 DO	256	32	256	32	256	32	256	32	256	32	256	32
	16 DO	512	32	512	32	512	32	512	32	512	32	512	32
Analog inputs	2AI	64	32	64	32	64	32	64	32	64	32	64	32
	4AI	112	28	124	31	124	31	128	32	128	32	128	32
	2 AI-PT	56	28	64	32	64	32	64	32	64	32	64	32
	2 AI-TC	64	32	64	32	64	32	64	32	64	32	64	32
Analog outputs	2 AO-I	38	19	64	32	64	32	64	32	64	32	64	32
	2 AO-V	38	19	50	25	50	25	50	25	50	25	50	25

BL67-GW-DN

DeviceNet Communication
 Module with Power Over
 the Network



7/8 Mini bus in wiring,
 view into male connector

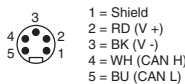

7/8 Mini bus out wiring,
 view into female connector

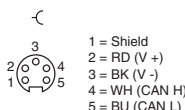

Turck Network Portal with up to 256 inputs, outputs, and 32 solenoids per H Series Micro or H Series ISO manifold. Digital inputs / outputs, analog inputs / outputs, serial interface, and counter modules are available. DeviceNet communication speeds selectable between 120, 250, 500 kbps, and CANopen communication speeds are selectable between 10 kbps up to 1 Mbps. Addressing for either module can be selected via rotary switches or set through software.

With the Power over the Network feature, it is only necessary to connect one cable to the communication module. For networks requiring additional power, a Bus Power Tee can be installed to combine separate network and power feeds into the communication module. See the Cables and Cordsets section for additional information.

BL67-GW-CO

CANopen Communication
 Module



M12 A-code bus out Wiring,
 view into female connector



M12 A-code bus In Wiring,
 view into male connector

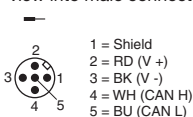

7/8 Mini Power in wiring,
 view into male connector

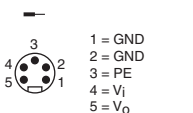

Turck Network Portal with up to 256 inputs, outputs, and 32 solenoids per H Series Micro or H Series ISO manifold. Digital inputs / outputs, analog inputs / outputs, serial interface, and counter modules are available. CANopen communication speeds are selectable between 10 kbps up to 1 Mbps, and addressing can be selected via rotary switches or set through software.

BL67-GW-DPV1

PROFIBUS Communication
 Module



M12 B-code bus out Wiring,
 view into female connector

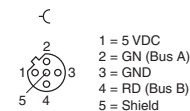

M12 B-code bus In Wiring,
 view into male connector

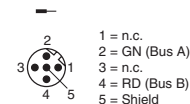

7/8 Mini Power in wiring,
 view into male connector

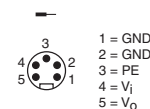

Turck Network Portal with up to 256 inputs, outputs, and 32 solenoids per H Series Micro or H Series ISO manifold. Digital inputs / outputs, analog inputs / outputs, serial interface, and counter modules are available. PROFIBUS communication speeds are selectable between 9.6 kbps up to 12 Mbps, and addressing can be selected via rotary switches or set through software.

BL67-GW-EN

Modbus/TCP, EtherNet/IP, and PROFINET

BL67-GW-EN-PN

PROFINET Communication Module

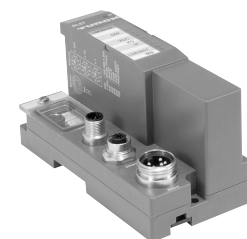

M12 D-code
 Ethernet in Wiring,
 view into female connector

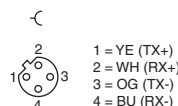

7/8 Mini Power in wiring,
 view into male connector

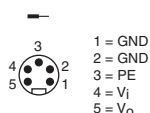

Turck Network Portal with up to 256 inputs, outputs, and 32 solenoids per H Series Micro or H Series ISO manifold. Digital inputs / outputs, analog inputs / outputs, serial interface, and counter modules are available. Communication speeds of 10/100 Mbps, and addressing can be selected via rotary switches, BOOTP, DHCP, or through software.



BL67-GW-EN-DN

Modbus/TCP Communication Module with DeviceNet Subnet

BL67-GW-EN-IP-DN

EtherNet/IP Communication Module with DeviceNet Subnet



DeviceNet OUT

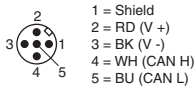

M12 D-code Ethernet in Wiring, view into female connector

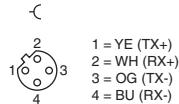

7/8 Mini Power in wiring, view into male connector

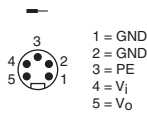

With BL Remote DeviceNet subnet functionality, each communication module has its own DeviceNet master which provides a connection for 63 DeviceNet nodes with additional inputs, outputs, and solenoid control. BL Remote DeviceNet subnet is independent of the main network, and is not visible to the master PLC.

BL67-PG-EN-DN

Modbus/TCP Programmable Communication Module with DeviceNet Subnet

BL67-PG-EN-IP-DN

EtherNet/IP Programmable Communication Module with DeviceNet Subnet

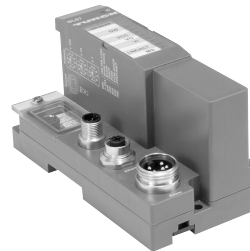

DeviceNet OUT

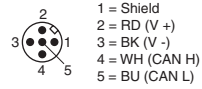

M12 D-code Ethernet in Wiring, view into female connector

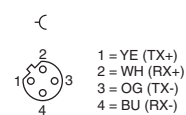

7/8 Mini Power in wiring, view into male connector

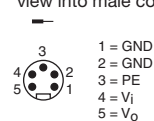

Communication modules are equipped with a built in standalone controller which is programmed according to IEC61131-3 with CoDeSys. Each module has 512KB Program memory with 32 bit RISC processor, and can run 1000 instructions in less than 1 ms. These network equipped modules are optimized to interface with PLC's with network capability or act as standalone controllers that need to interface with other network equipped devices.

With BL Remote DeviceNet subnet functionality, each communication module has its own DeviceNet master which provides a connection for 63 DeviceNet nodes with additional inputs, outputs, and solenoid control. BL Remote DeviceNet subnet is independent of the main network, and is not visible to the master PLC.

BL67-PG-DP

PROFIBUS Programmable Communication Module

BL67-PG-EN

Modbus/TCP Programmable Communication Module

BL67-PG-EN-IP

EtherNet/IP Programmable Communication Module



Profibus Wiring

M12 B-code bus out Wiring, view into female connector

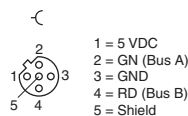

M12 B-code bus in Wiring, view into female connector

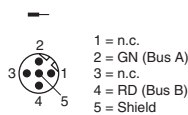

Ethernet Wiring

M12 D-code Ethernet in Wiring, view into female connector

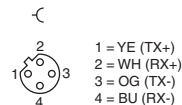

7/8 Mini Power in wiring, view into male connector Common to modules

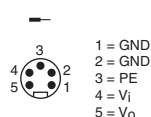

Communication modules are equipped with a built in standalone controller which is programmed according to IEC61131-3 with CoDeSys. Each module has 512KB Program memory with 32 bit RISC processor, and can run 1000 instructions in less than 1 ms. These network equipped modules are optimized to interface with PLC's with network capability or act as standalone controllers that need to interface with other network equipped devices.



	Base Modules												
	BL67-B-4M8	BL67-B-8M8	BL67-B-1M12	BL67-B-1M12-8	BL67-B-2M12	BL67-B-2M12-P	BL67-B-4M12	BL67-B-4M12-P	BL67-B-1M23	BL67-B-1M23-19	BL67-B-1RSM	BL67-B-1RSM-4	BL67-1RSM-VO
Power Extender Modules													
BL67-PF-24VDC											✓	✓	✓
Digital Input Modules													
BL67-4DI-P	✓				✓	✓	✓		✓				
BL67-8DI-P		✓					✓	✓	✓				
BL67-4DI-PD	✓				✓	✓	✓		✓				
BL67-8DI-PD		✓					✓	✓	✓				
BL67-4DI-N	✓				✓	✓	✓		✓				
BL67-8DI-N		✓					✓	✓	✓				
Digital Output Modules													
BL67-4DO-0.5A-P	✓				✓	✓	✓		✓				
BL67-4DO-2A-P	✓				✓	✓	✓		✓				
BL67-8DO-0.5A-P		✓					✓	✓	✓				
BL67-16DO-0.1A-P										✓			
BL67-4DO-2A-N	✓				✓	✓	✓		✓				
BL67-8DO-0.5A-N		✓					✓	✓	✓				
Relay Output Modules													
BL67-8DO-R-NO								✓					
Digital Input / Output Modules													
BL67-4DI4DO-PD		✓					✓	✓	✓				
Configurable Digital Input / Output Modules													
BL67-8XSG-PD		✓					✓	✓	✓				
Analog Input Modules													
BL67-2AI-I					✓								
BL67-2AI-V					✓								
BL67-4AI-V/I							✓						
BL67-2AI-PT					✓								
BL67-2AI-TC					✓								
Analog Output Modules													
BL67-2AO-I					✓								
BL67-2AO-V					✓								
Technology Modules													
BL67-1RS232			✓	✓					✓				
BL67-1RS485/422			✓	✓					✓				
BL67-1SSI				✓					✓				
BL67-1CNT/ENC				✓					✓				
BL67-1CVI			✓										
BL Ident® RFID Modules													
BL67-2RFID-A					✓								
BL67-2RFID-S					✓								

System Supply via the Module Bus

The number of BL67 modules that can be powered by the communication module, depends on the nominal current draw of all the modules in the system. The total bus power current consumption of the installed BL67 modules may not exceed 1.5 A. The total field power current for inputs may not exceed 4 A, and the total field power for outputs may not exceed 8 A for DeviceNet and CANopen with power over the network, or 10A for all other communication modules.

When using the software PACTware, the menu item <Station - Verify> will automatically generate an error message if the system supply via the module bus is not reliably ensured.

Nominal Current Consumption

The following table shows the nominal current consumption of the various BL67 modules:

Modules	Bus power current (mA)	Field power for inputs ¹⁾ (mA)	Field power for outputs (mA)
PROFIBUS-DP communication module	0		150
DeviceNet communication module	0		150
CANopen communication module	0		150
Ethernet communication module	0		150
Valve driver with 16 outputs	30		< 109 mA (plus load current)
Valve driver with 32 outputs	60		< 218 mA (plus load current)
BL67-PF-24VDC	30		9
BL67-4DI-P	30	< 49 mA	
BL67-4DI-N	30	< 10 mA	
BL67-4DI-PD	30	< 109 mA	
BL67-8DI-P	30	< 49 mA	
BL67-8DI-N	30	< 10 mA	
BL67-8-DI-PD	30	< 109 mA	
BL67-4DO-0.5A-P	30		< 109 mA (plus load current)
BL67-4DO-2A-P	30		< 109 mA (plus load current)
BL67-4DO-2A-N	30		< 109 mA (plus load current)
BL67-8DO-0.5A-P	30		< 109 mA (plus load current)
BL67-8DO-0.5A-N	30		< 109 mA (plus load current)
BL67-16DO-0.1A-P	30		< 109 mA (plus load current)
BL67-4DI4DO-PD	30		< 109 mA (plus load current)
BL67-8XSG-PD	30		< 109 mA (plus load current)
BL67-8DO-R-NO	30		< 109 mA (plus load current)
BL67-2AI-V	35	< 22 mA	
BL67-2AI-I	35	< 22 mA	
BL67-4AI-I/V	35	< 22 mA	
BL67-2AI-TC	35	< 40 mA	
BL67-2AI-PT	45	< 58 mA	
BL67-2AO-I	40		< 62 mA
BL67-2AO-V	60		< 67 mA
BL67-1RS232	140	< 90 mA	
BL67-1RS485/422	60	< 42 mA	
BL67-1SSI	50	< 39 mA	
BL67-1CNT/ENC	30	< 109 mA	
BL67-1CVI	30	< 109 mA	

1) Is limited to 4A by means of the integrated short-circuit protection.

Digital Input Modules

I/O modules	Voltage	Part number
8 PNP input module	7 to 30 VDC	BL67-8DI-P
8 PNP input module, with diagnostics	7 to 30 VDC	BL67-8DI-PD
8 NPN input module	24 VDC	BL67-8DI-N



Base module	Part number
8 x M8, 3 pole, female	BL67-B-8M8
4 x M12, 5 pole, female, A-code	BL67-B-4M12
4 x M12, 5 pole, female, A-code	BL67-B-4M12-P
1 x M23, 12 pole, female	BL67-B-1M23



I/O modules	Voltage	Part number
4 PNP input module	7 to 30 VDC	BL67-4DI-P
4 PNP input module, with diagnostics	7 to 30 VDC	BL67-4DI-PD
4 NPN input module	24 VDC	BL67-4DI-N

Base module	Part number
4 x M8, 3 pole, female	BL67-B-4M8
2 x M12, 5 pole, female, A-code	BL67-B-2M12
2 x M12, 5 pole, female, A-code	BL67-B-2M12-P
4 x M12, 5 pole, female, A-code	BL67-B-4M12
1 x M23, 12 pole, female	BL67-B-1M23



Digital Output Modules

I/O modules	Output current	Part number
8 PNP output module	0.5 amps per channel	BL67-8DO-0.5A-P
8 NPN output module	0.5 amps per channel	BL67-8DO-0.5A-N



Base module	Part number
8 x M8, 3 pole, female	BL67-B-8M8
4 x M12, 5 pole, female, A-code	BL67-B-4M12
4 x M12, 5 pole, female, A-code	BL67-B-4M12-P
1 x M23, 12 pole, female	BL67-B-1M23



I/O modules	Output Current	Part number
4 PNP output module	0.5 amps per channel	BL67-4DO-0.5A-P
4 PNP output module	2 amps per channel	BL67-4DO-2A-P
4 PNP output module	4 amps per channel	BL67-4DO-4A-P
4 NPN output module	2 amps per channel	BL67-4DO-2A-N

Base module	Part number
4 x M8, 3 pole, female	BL67-B-4M8
2 x M12, 5 pole, female, A-code	BL67-B-2M12
2 x M12, 5 pole, female, A-code	BL67-B-2M12-P
4 x M12, 5 pole, female, A-code	BL67-B-4M12
1 x M23, 12 pole, female	BL67-B-1M23



Digital Output Modules

I/O modules	Output current	Part number
16 PNP output module	0.14 amps per channel	BL67-16DO-0.1A-P

Base module

Part number
BL67-B-1M23-19

Relay Output Modules

I/O modules	Output current	Part number
8 normally open relays	0.14 amps per channel	BL67-8DO-R-NO

Base module

Part number
BL67-B-4M12-P

Analog Input Modules

I/O modules	Input type	Part number
4 configurable current or voltage analog input module	4 to 20 mA or 0 to 20 mA -10 to +10 VDC or 0 to +10 VDC	BL67-4AI-V/I

Base module

Part number
BL67-B-4M12



I/O modules	Input type	Part number
2 current analog input module	4 to 20 mA or 0 to 20 mA	BL67-2AI-I
2 voltage analog input module	-10 to +10 VDC or 0 to +10 VDC	BL67-2AI-V
2 temperature analog input module	PT100, PT200, PT500, PT1000, Ni100, Ni1000	BL67-2AI-PT
2 temperature analog input module	Type B, E, J, K, N, R, S, T	BL67-2AI-TC

Base module

Part number
BL67-B-2M12

Combination Input / Output Modules

I/O modules	Input voltage & output current	Part number
4 PNP output 4 PNP input module, with diagnostics	7 to 30 VDC 0.5 Amps	BL67-4DI4DO-PD

8 PNP configurable input or output module, with diagnostics	7 to 30 VDC 0.5 Amps	BL67-8XSG-PD
---	-------------------------	---------------------

Base module

Part number
BL67-B-8M8



4 x M12, 5 pole, female, A-code	BL67-B-4M12
---------------------------------	--------------------



4 x M12, 5 pole, female, A-code	BL67-B-4M12P
---------------------------------	---------------------

Analog Output Modules

I/O modules	Input type	Part number
4 voltage analog output module	-10 to +10 VDC or 0 to +10 VDC	BL67-4AO-V

Base module

Part number
BL67-B-4M12



I/O modules	Input type	Part number
2 current analog output module	4 to 20 mA or 0 to 20 mA	BL67-2AO-I
2 voltage analog output module	-10 to +10 VDC or 0 to +10 VDC	BL67-2AO-V

Base module

Part number
BL67-B-2M12



Combination Analog Input / Output Modules

I/O modules	Output current	Part number
4 configurable input and 4 configurable output current or voltage analog module	4 to 20 mA or 0 to 20 mA -10 to +10 VDC or 0 to +10 VDC	BL67-4AI4AO-V/I

Base module	Part number
 8 x M8, 3 pole, female	BL67-B-8M8

 4 x M12, 5 pole, female, A-code	BL67-B-4M12
---	--------------------

I/O modules	Output current	Part number
2 configurable input and 2 configurable output current or voltage analog module	4 to 20 mA or 0 to 20 mA -10 to +10 VDC or 0 to +10 VDC	BL67-2AI2AO-V/I

Base module	Part number
 8 x M8, 3 pole, female	BL67-B-8M8

CANopen Subnet Module

Extender module	Capacity	Part number
1 CANopen connection	64 bits of inputs or outputs	BL67-1CVI

Base module	Part number
 1 x M12, 5 pole, female, A-code	BL67-B-1M12

Serial Interface Module

Extender module	Capacity	Part number
1 RS232 serial interface	300 to 115200 bps	BL67-1RS232

1 RS485 or 422 serial interface	300 to 115200 bps	BL67-1RS485/422
---------------------------------	-------------------	------------------------

Base module	Part number
 1 x M12, 5 pole, female, A-code	BL67-B-1M12

 1 x M12, 8 pole, female, A-code	BL67-B-1M12-8
---	----------------------

 1 x M23, 12 pole, female	BL67-B-1M23
--	--------------------

IO-Link Class A Master

Extender module	Part number
4 master channels	BL67-4IOL

Base module	Part number
 4 x M12, 5 pole, female, A-code	BL67-B-4M12

Power Extender Module

Extender module	Current capacity	Part number
24 VDC field power module	10 amps input	BL67-PF-24VDC

Base module	Part number
 5 pole mini connector to supply bus power and field power	BL67-B-1RSM

 5 pole mini connector to field power only	BL67-B-1RSM-VO
---	-----------------------

 4 pole mini connector to supply bus power and field power	BL67-B-1RSM-4
---	----------------------

SSI and Counting Modules

Extender module	Capacity	Part number
1 SSI sensor interface	65 kbps up to 1 Mbps	BL67-1SSI

1 counter interface	Up to 250 kHz	BL67-1CNT/ENC
---------------------	---------------	----------------------

Base module	Part number
 1 x M12, 8 pole, female, A-code	BL67-B-1M12-8

 1 x M23, 12 pole, female	BL67-B-1M23
--	--------------------

Digital PNP Input Modules

DC Input Module	BL67-4DI-P	BL67-8DI-P	BL67-4DI-PD	BL67-8DI-PD
Number of inputs	4	8	4	8
Sensor requirement	PNP Sourcing		PNP Sourcing	
Voltage, on-state input, nom.	24 VDC		24 VDC	
Field power for inputs current consumption	49 mA		109 mA	
Bus power current consumption	30 mA		30 mA	
Low level signal voltage	<4.5 V		<4.5 V	
High level signal voltage	7...30V		7...30V	
Low level signal current	<1.5 mA		<1.5 mA	
High level signal current	2.1...3.7 mA		2.1...3.7 mA	
Type of diagnostics	Group Diagnostics		Channel Diagnostics	
Short circuit protection	Group Protection		Channel Protection	
Input delay	0.25 ms		0.25; 2.5 ms	

PNP (Sourcing)

PNP input modules provide sourcing capabilities. When the input field device is passing, current flows from the input device into the Turck input module.

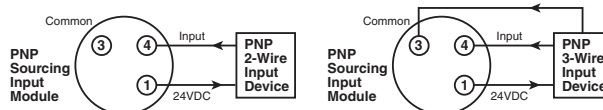

Digital NPN Input Modules

Digital DC Input Module	BL67-4DI-N	BL67-8DI-N
Number of inputs	4	8
Sensor requirement	NPN Sinking	
Voltage, on-state input, nom.	24 VDC	
Field power for inputs current consumption	10 mA	
Bus power current consumption	30 mA	
Low level signal voltage	>7 V	
High level signal voltage	<5 V	
Low level signal current	<2.5 mA	
High level signal current	>3 mA	
Type of diagnostics	Group Diagnostics	
Short circuit protection	Group Protection	
Input delay	0.25 ms	

NPN (Sinking)

NPN input modules provide sinking capabilities. When the input field device is passing, current out of the Turck input module into the field input device.

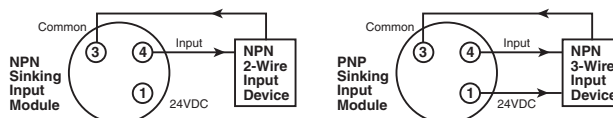

Digital PNP Output Modules

Digital DC Output Module	BL67-4DO-0.5A-P	BL67-8DO-0.5A-P	BL67-4DO-2A-P	BL67-16DO-0.1A-P
Number of outputs	4	8	4	16
Sensor requirement	PNP Sourcing	PNP Sourcing	PNP Sourcing	PNP Sourcing
Output voltage	24 VDC	24 VDC	24 VDC	24 VDC
Field power for outputs current consumption	109 mA (Plus load current)	109 mA (Plus load current)	109 mA (Plus load current)	109 mA (Plus load current)
Bus power current consumption	30 mA	30 mA	30 mA	30 mA
Output current per channel	0.5 A	0.5 A	2.0A	0.1 A
Output delay	3 ms	3 ms	3 ms	3 ms
Load type	Resistive, Inductive, Lamp Load	Resistive, Inductive, Lamp Load	Resistive, Inductive, Lamp Load	Resistive, Inductive
Load resistance, resistive	>48 Ohm	>48 Ohm	>12 Ohm	>250 Ohm
Load resistance, inductive	<1.2 H	<1.2 H	<1.2 H	<1.2 H
Lamp load	< 3W	< 3W	< 10W	< 10W
Switching frequency, resistive	<200 Hz	<200 Hz	<200 Hz	<200 Hz
Switching frequency, inductive	< 2 Hz	< 2 Hz	< 2 Hz	< 2 Hz
Switching frequency, lamp load	< 20 Hz	< 20 Hz	< 20 Hz	< 20 Hz
Short-circuit protection	Group Protection	Group Protection	Group Protection	Group Protection
Diagnostic bits	4	8	4	16

PNP (Sourcing)

PNP input modules provide sourcing capabilities. When the input field device is passing, current flows from the input device into the Turck input module.

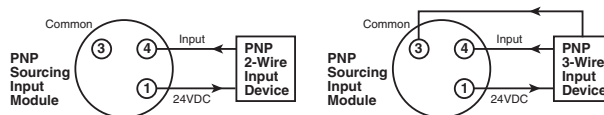

Digital NPN Output Modules

Digital DC Output Module	BL67-8DO-0.5A-N	BL67-4DO-2A-N
Number of outputs	8	4
Sensor requirement	NPN Sinking	NPN Sinking
Output voltage	24 VDC	24 VDC
Field power for outputs current consumption	109 mA (Plus load current)	109 mA (Plus load current)
Bus power current consumption	30 mA	30 mA
Output current per channel	0.5 A	2.0 A
Output delay	3 ms	3 ms
Load type	Resistive, Inductive, Lamp Load	Resistive, Inductive, Lamp Load
Load resistance, resistive	>48 Ohm	>48 Ohm
Load resistance, inductive	<1.2 H	<1.2 H
Lamp load	< 3W	< 3W
Switching frequency, resistive	<200 Hz	<200 Hz
Switching frequency, inductive	< 2 Hz	< 2 Hz
Switching frequency, lamp load	< 20 Hz	< 20 Hz
Short-circuit protection	Group Protection	Group Protection
Diagnostic bits	4	8

NPN (Sinking)

NPN input modules provide sinking capabilities. When the input field device is passing, current out of the Turck input module into the field input device.

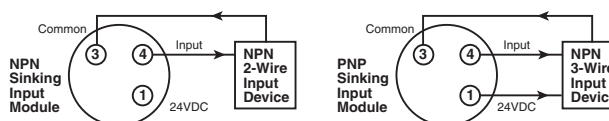

Relay Output Modules

Relay Output Module	BL67-8DO-R-NO
Number of outputs	8
Output type	Relay
Output voltage	24 VDC
Field power for outputs current consumption	109 mA (Plus load current)
Bus power current consumption	30 mA
Output current per channel	100 mA
Output delay	3 ms
Load type	Resistive, TTL logic
Switching resistor	<31 Ohm
Switching frequency, resistive	<200 Hz
Short-circuit protection	None

Combination Digital Modules

Combination Input and Output Modules	BL67-4DI4DO-PD	BL-67-8XSG-PD
Number of outputs	4	Configurable 0 to 8
Number of inputs	4	Configurable 0 to 8
Total channels	8	8
Sensor requirement	PNP Sourcing	PNP Sourcing
Voltage, on-state input, nom.	24 VDC	24 VDC
Output voltage	24 VDC	24 VDC
Field power for outputs current consumption	109 mA	109 mA
Bus power current consumption	30 mA	30 mA
Input low level signal voltage	<4.5 V	<4.5 V
Input high level signal voltage	7...30V	7...30V
Input low level signal current	<1.5 mA	<1.5 mA
Input high level signal current	2.1...3.7 mA	2.1...3.7 mA
Input delay	0.25; 2.5 ms	0.25; 2.5 ms
Output current per channel	0.5 A	0.5 A
Output delay	3 ms	3 ms
Load type	Resistive, Inductive, Lamp Load	Resistive, Inductive, Lamp Load
Load resistance, resistive	>48 Ohm	>48 Ohm
Load resistance, inductive	<1.2 H	<1.2 H
Lamp load	< 3W	< 3W
Switching frequency, resistive	<200 Hz	<200 Hz
Switching frequency, inductive	< 2 Hz	< 2 Hz
Switching frequency, lamp load	< 20 Hz	< 20 Hz
Short-circuit protection	Channel Protection	Channel Protection
Diagnostic bits	8	12

Analog Input Modules

Analog Input Module	BL67-2AI-I	BL67-2AI-V	BL67-4AI-V/I
Number of inputs	2	2	4
Nominal voltage	24 VDC	24 VDC	24 VDC
Field power for inputs current consumption	22 mA	22 mA	22 mA
Bus power current consumption	35 mA	35 mA	35 mA
Analog input type	0/4...20mA	-10/0...+10 VDC	0/4...20mA or -10/0...+10 VDC
Input resistance	<0.125 kOhm	<98.5 kOhm	<0.125 kOhm or <98.5 kOhm
Maximum limiting frequency	50 Hz		20 Hz
Fault limit @ 23 degree C	<0.2%		<0.3%
Repeatability	0.05%	0.05%	0.05%
Temperature coefficient (ppm/degree C of full scale)	<300	<150	<300
Resolution	16 Bit	16 Bit	16 Bit
Measuring principle	Sigma Delta	Sigma Delta	Sigma Delta
Measured value display	16 bit signed integer, 12 bit full range left justified	16 bit signed integer, 12 bit full range left justified	16 Bit signed integer, 12 bit full range left justified
Diagnostic bits	16		32

Temperature Inputs

Analog Input Module	BL67-2AI-PT	BL67-2AI-TC
Number of inputs	2	2
Nominal voltage	24 VDC	24 VDC
Field power for inputs current consumption	58 mA	40 mA
Bus power current consumption	45 mA	35 mA
Temperature input type	PT100, PT200, PT500, PT1000, Ni100, Ni1000	B, E, J, K, N, R, S, T
Voltage resolution	n/a	+/- 50mV; <2uV
Fault limit @ 23 degree C	<0.2%	<0.2%
Repeatability	0.05%	0.05%
Temperature coefficient (ppm/degree c of full scale)	<300	<300
Resolution	16 Bit	16 Bit
Measured value display	16 bit signed integer, 12 bit full range left justified	16 bit signed integer, 12 bit full range left justified
Diagnostic bits	16	16

Analog Input Modules

Analog Input Module	BL67-2AO-I	BL67-2AO-V
Number of inputs	2	2
Nominal voltage	24 VDC	24 VDC
Field power for outputs current consumption	62 mA	67 mA
Bus power current consumption	40 mA	60 mA
Analog output type	0/4...20mA	-10/0...+10 VDC
Output current per channel	n/a	250 mA
Load resistance, resistive	<0.45 kOhm	> 1kOhm
Load resistance, inductive	<1 mH	n/a
Load resistance, capacitive	n/a	> 1 uF
Transmission frequency	<200 Hz	<100 Hz
Fault limit @ 23 degree C	<0.2%	<0.2%
Repeatability	0.05%	0.05%
Temperature coefficient (ppm/degree c of full scale)	<150	<300
Resolution	16 bit	16 bit
Measured value display	16 bit signed integer, 12 bit full range left justified	16 bit signed integer, 12 bit full range left justified

Combination Analog Modules

Analog Combination Module	BL67-4AI4AO-V/I	BL67-2AI2AO-V/I
Number of analog inputs	4	2
Number of analog outputs	4	2
Nominal voltage	24 VDC	24 VDC
Field power for outputs current consumption	67 mA	67 mA
Bus power current consumption	60 mA	60 mA
Analog input type	0/4...20mA or -10/0...+10 VDC	0/4...20mA or -10/0...+10 VDC
Input resistance	0.065 or 225 kOhm	0.065 or 225 kOhm
Maximum limiting frequency	20 Hz	20 Hz
Fault limit @ 23 degree c	<0.3%	<0.3%
Repeatability	0.05%	0.05%
Temperature coefficient (ppm/degree c of full scale)	<300	<300
Resolution	16 bit	16 bit
Measuring principle	Sigma Delta	Sigma Delta
Measured value display	16 bit signed integer, 12 bit full range left justified	16 bit signed integer, 12 bit full range left justified
Analog output type	-10/0...+10 VDC	-10/0...+10 VDC
Output current per channel	250 mA	250 mA
Load resistance, resistive	>1 kOhm	>1 kOhm
Load resistance, capacitive	<1 uF	<1 uF
Transmission frequency	<100 Hz	<100 Hz
Fault limit @ 23 degree C	<0.3%	<0.3%
Repeatability	0.05%	0.05%
Temperature coefficient (ppm/degree c of full scale)	<300	<300
Resolution	16 bit	16 bit
Measured value display	16 bit signed integer, 12 bit full range left justified	16 bit signed integer, 12 bit full range left justified
Diagnostic bits	8	4

Power Extender Module

Power Extender Module	BL67-PF-24VDC
Nominal voltage	24 VDC
Field power for outputs current consumption	9 mA
Bus power current consumption	30 mA
Supply for field power for inputs current	4.0 A
Supply for field power for outputs current	10 A
Diagnostic bits	3

RS232 Interface

RS232 Interface	BL67-1RS232
Number of channels	1
Field power for inputs current consumption	90 mA
Bus power current consumption	140 mA
Transmission level active (u rs1)	-15 to -3 VDC
Transmission level inactive (urso)	3 to 15 VDC
Common-mode range (ugl)	-7 to 12 VDC
Transmission signals	RxD, TxD, RTS, CTS
Data buffer received	128 Byte
Send data buffer	64 Byte
Connection type	Full Duplex
Transmission rate	300 to 115200 bps
Parameter	Transmission Rate, Diagnostics, Data Bits, Stop Bits, XON - Character, XOFF - Character, Parity, Flow Control
Cable length	15 m
Diagnostic bits	8

RS485 / 422 Interface

RS485/422 Interface	BL67-1RS485/422
Number of channels	1
Field power for inputs current consumption	42 mA
Bus power current consumption	60 mA
Transmission signals	RxD, TxD
Connection type	2 Wire Half Duplex or 4 Wire Full Duplex
Transmission rate	300 to 115200 bps
Parameter	RS485/422, Transmission Rate, Diagnostics, Data Bits, Stop Bits, XON - Character, XOFF - Character, Parity, Flow Control
Cable length	1000 m
Line impedance	120 Ohm
Bus termination	External
Diagnostic bits	8



SSI Sensor Interface

SSI Sensor Interface	BL67-1SSI
Number of channels	1
Field power for inputs current consumption	39 mA
Bus power current consumption	50 mA
Transmission signals	CL, D
Connection type	4 Wire Full Duplex (Clock Output/Signal Input)
Transmission rate	62.5 kbps up to 1 Mbps
Parameter	Transmission Rate, Diagnostics, Data Format (Binary / GRAY coded), Data Fram Bits (1-32), Number of Invalid Bits (LSB: 0-15, MSB 0-7)
Cable length	30 m
Diagnostic bits	8

Counting Module

Counting Module	BL67-1CNT/ENC
Number of channels	1
Field power for inputs current consumption	109 mA
Bus power current consumption	30 mA
Input type	PNP
Output type	PNP
Output current per channel	0.5 A
Output delay	2 ms
Load type	Resistive
Frequency measurement	Up to 250 kHz
Speed measurement	Factor Configurable
Period duration measurement	2 usec
Upper count limit	0x80000000 up to 0xFFFFFFFF
Lower count limit	0x80000000 up to 0xFFFFFFFF
Short circuit protection	Channel Protection

CANopen Expansion Module

CANopen Expansion Module	BL67-1CVI
Number of channels	1
Field power for inputs current consumption	109 mA
Bus power current consumption	30 mA
Transmission signals	CAN High, CAN Low
Connection type	CANopen
Transmission speed	10 kbps up to 1 Mbps
Parameter	Transmission Rate, Diagnostics, Bus Termination, Range of I/O Data
Bus termination	Internal
Diagnostic bits	48
Max number of CANopen nodes	8
Max processing data per module	8 Byte
Max data per node	4 Byte

Power Distribution Options for Turck Network Portal

Turck Communication and I/O Modules - DeviceNet and CANopen, Power Over Network

The 24VDC power supply pins from the DeviceNet or CANopen network connection on the communication module provides a single power circuit. This circuit provides 1.5A bus power, 4A field power for inputs and 8A field power for outputs.

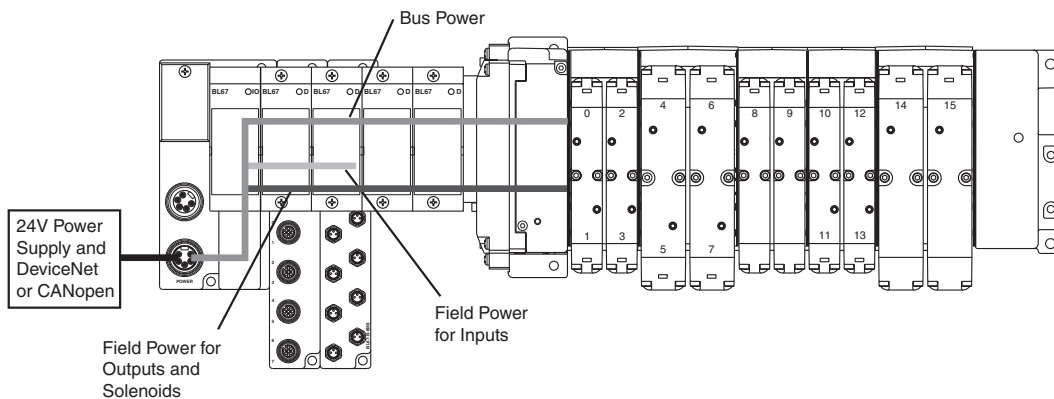

Turck Communication and I/O Modules - EtherNet/IP, Modbus/TCP, PROFINET, PROFIBUS, and CANopen

An auxiliary 24VDC power supply from the communication module provides power across two separate circuits. The first circuit provides 1.5A bus power and 4A field power for inputs. The second circuit provides 10A field power for outputs which can be wired to an e-stop circuit to kill all outputs.

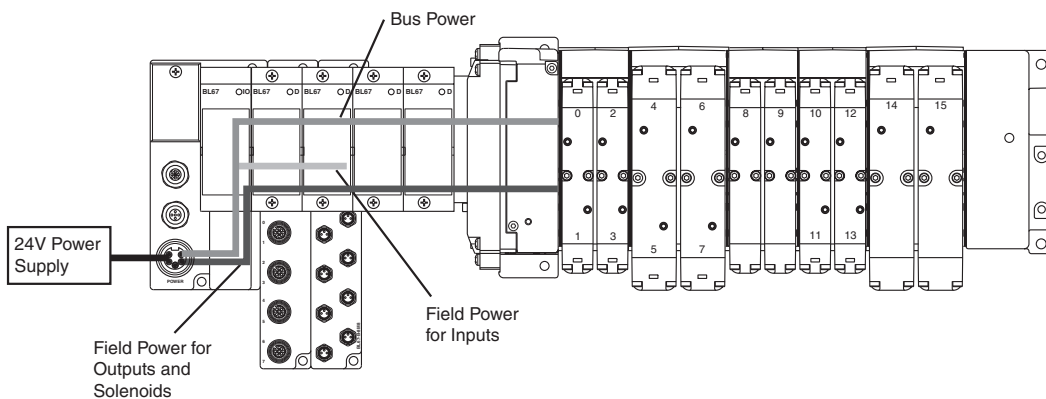

Power Distribution Options for Turck Network Portal (continued)

24VDC Power Extender Module (BL67-PF-24VDC) with Base Module BL67-B-1RSM

This configuration creates an auxiliary 24VDC power supply and provides power across two separate circuits, regardless of the communication module used. The first circuit provides 4A field power for inputs. The second circuit provides 10A field power for outputs which can be wired to an e-stop circuit to kill all outputs and solenoids to the right of the module. The 1.5A bus power is uninterrupted, and is still supplied from the communication module.

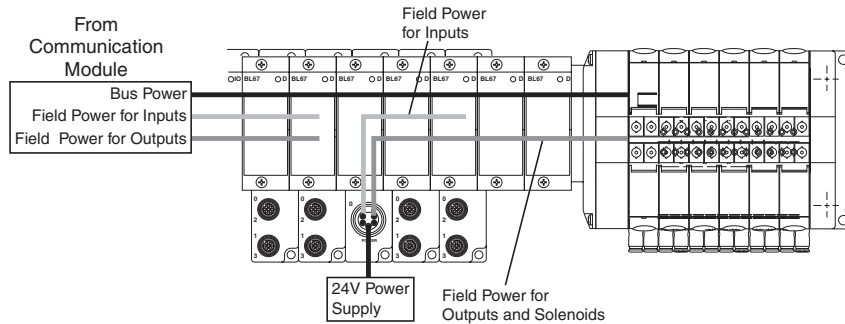

24VDC Power Extender Module (BL67-PF-24VDC) with Base Module BL67-B-1RSM-4

This configuration creates an auxiliary 24VDC power supply and provides power across one circuit, regardless of the communication module used. This circuit provides 4A field power for inputs and 10A field power for outputs. The 1.5A bus power is uninterrupted, and is still supplied from the communication module.

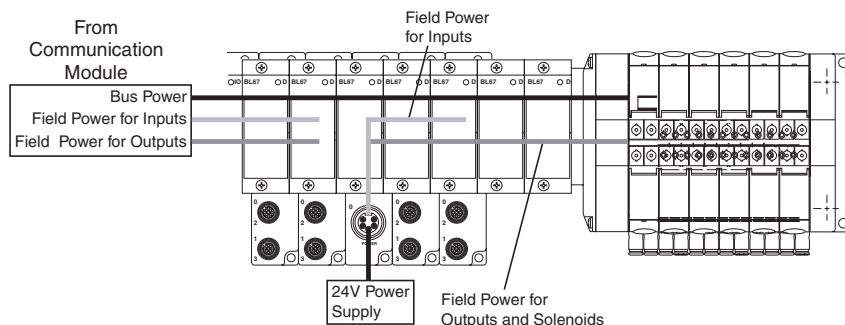

24VDC Power Extender Module (BL67-PF-24VDC) with Base Module BL67-B-1RSM-VO

This configuration creates an auxiliary 24VDC power supply and provides power across one circuit, regardless of the communication module used. This circuit provides 10A field power for outputs which can be wired to an e-stop circuit to kill all outputs and solenoids to the right of the module. The 1.5A bus power and 4A field power for inputs are uninterrupted, and are still supplied from the communication module.

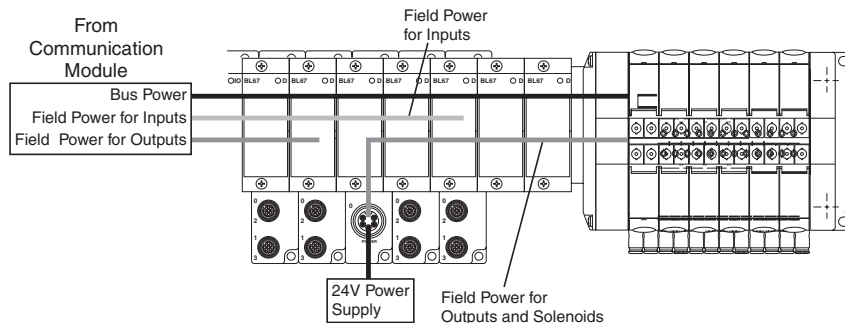

Turck with H Series ISO Valves

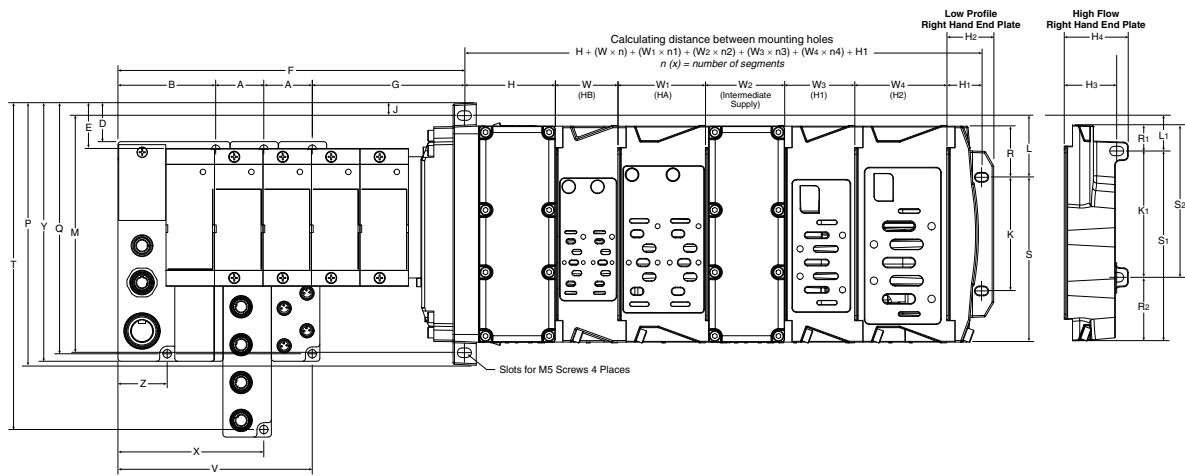

n (x) = number of segments

A	B	D	E	F	G	H	H1	H2	H3	H4	J
32,0	64,5	25,4	29,9	228,4	100,1	60,0	23,0	31,0	34,6	42,3	8,3
K	K1	L	L1	M	P	Q	R	R1	R2	S	S1
75,0	83,4	40,7	24,3	156,5	173,1	165,4	33,7	17,3	41,8	108,8	125,2
S2	T	V	W	W1	W2	W3	W4	X	Y	Z	
100,7	215,4	128,3	41,3	57,8	52,3	46,3	60,8	96,3	170,4	32,5	

H3 Manifold Assembly

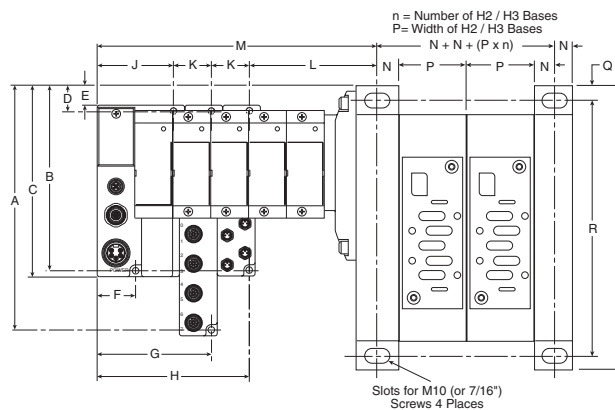

A	B	C	D	E	F	G	H	J	K	L	M	N	P	Q	R	S
218,9	168,9	173,9	33,9	28,9	32,5	96,5	128,5	64,5	32	110	See note 1	16,5	71	15	265	295

Note 1: M = J + L + n₂ × K, where n₂ = Number of Turck input / output modules

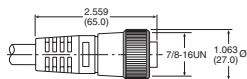
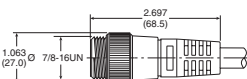
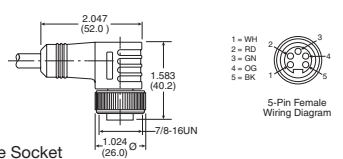

7/8" Mini Power Cables - P2H Network Node, H Series Network Portal, Turck Network Portal

	Description	Part number
 RKM Female Socket	4-pin female to flying lead cable, 5 meters, TPE	RKM 46-5M/S1587
	5-pin female to flying lead cable, 5 meters, TPE	RKM 56-5M/S1587
 RSM Male Pins	4-pin male to female cable, TPE	RSM RKM 46-x/S1587
	5-pin male to female cable, TPE	RSM RKM 56-x/S1587
 WKM Female Socket	4-pin right angle female to flying lead cable, 5 meters, TPE	WKM 46-5M/S1587
	5-pin right angle female to flying lead cable, TPE	WKM 56-5M/S1587
	Where x = 2, 4, 5, 6, 8, 10 meter standard lengths	

Power Tee - P2H Network Node, H Series Network Portal, Turck Network Portal

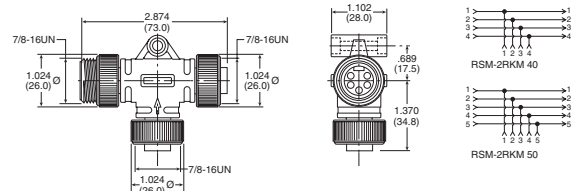
	Description	Part number
	4-pin Male to 2 female sockets	RSM-2RKM 40
	5-pin Male to 2 female sockets	RSM-2RKM 50

M12 A-code Cables - P2M IO-Link, P2H IO-Link, H Series IO-Link Network Portal, Turck IO-Link Network Portal

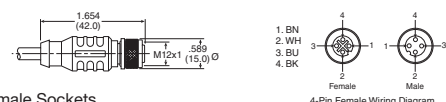
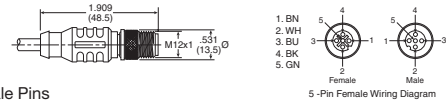
	Description	Part number
 RKC Female Sockets	4-pin female to flying lead cable, PVC	RKC 4.4T-1
	4-pin male to flying lead cable, PVC	RSC 4.4T-*
 RSC Male Pins	4-pin male to female cable, PVC	RKC 4.4T-*/RSC 4.4T
	5-pin female to flying lead cable, TPE	RKC 4.5T-*/S1587
	5-pin male to flying lead cable, TPE	RSC 4.5T-4/S1587
	5-pin male to female cable, TPE	RKC 4.5T-*/RSC 4.5T/S1587
	Where * = 1, 2, 3, 4 meter standard lengths	

M8 Cables - H Series IO-Link Network Portal, Turck IO-Link Network Portal

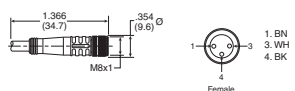
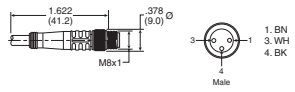
	Description	Part number
 M8x1 Female	3-pin female to flying lead cable, PUR	PKG 3M-4/S90
	3-pin male to flying lead cable, PUR	PSG 3M-*/S90
 M8x1 Male	3-pin male to female cable, PUR	PKG 3M-*/PSG 3M/S90
	Where * = 1, 2, 3, 4 meter standard lengths	

M23 Cables

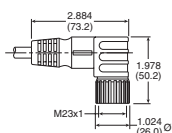
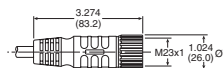

Description	Part number
12-pin, double ended female thread with male pins and female socket, PUR. Pinout optimized for H Series Network Portal.	CSCM CKCM 12-11-x/S90
19-pin, double ended female thread with male pins and female socket, PUR. Pinout optimized for H Series Network Portal.	CSM CKM 19-19-x/S90
19-pin, 90° double ended female thread with male pins and female socket, PUR. Pinout optimized for Turck Network Portal.	CSWM CKWM 19-19-x/CS12852

Where x = 1, 2, 3, 4 meter standard lengths

PROFIBUS Cables - P2M Network Node, Turck Network Portal

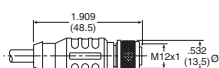
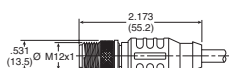

RSSW Side, Male Pins

RKSX Side, Female Sockets

Description	Part number
M12 male to M12 female, PUR	RSSW RKSX 455-xM

Where x = 2, 4, 5, 6, 8, 10 meter standard lengths

PROFIBUS Terminating Resistor - P2M Network Node, Turck Network Portal



Male Pins

Description	Part number
M12 male pin terminating resistor	P8BPA00MB

Ethernet Cables - P2M Network Node, H Series Network Portal, Turck Network Portal

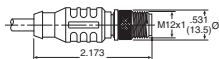
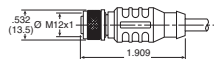

RKSD Side, Female Sockets

RSSD Side, Male Pins

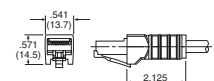

RJ45S Side

Description	Part number
M12 female to M12 male, PUR	RSSD RKSD 443-xM
RJ45 to M12 male, PUR	RSSD RJ45S 443-2M

Where x = 2, 5, 10, 15, 20, 30 meter standard lengths

25-pin, D-Sub Cable (Female)



Description	Length	Part number
25-pin, D-sub cable, IP20	3 meters	P8LMH25M3A
25-pin, D-sub cable, IP20	9 meters	SCD259D
25-pin, D-sub cable, IP65	3 meters	SCD253W
25-pin, D-sub cable, IP65	9 meters	SCD259WE

DeviceNet and CANopen Cables - P2M Network Node, H Series Network Portal, Turck Network Portal

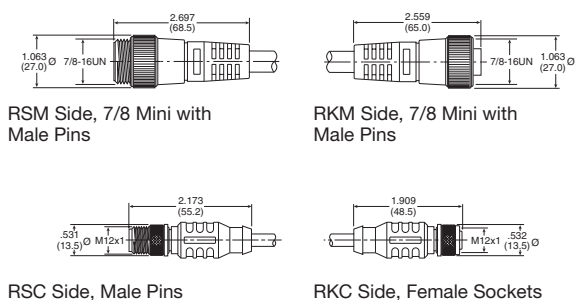

Description	Part number
7/8" mini male to 7/8" mini female, PUR	RSM RKM 5711-xM
7/8" mini male to M12 female, PUR	RSM RKC 5711-xM
M12 male to M12 female, PUR	RSC RKC 5711-xM
M12 male to 7/8" mini female, PUR	RSC RKM 5711-xM

Where x = 2, 4, 5, 6, 8, 10 meter standard lengths

Bus Power Tee - P2M Network Node, H Series Network Portal, Turck Network Portal

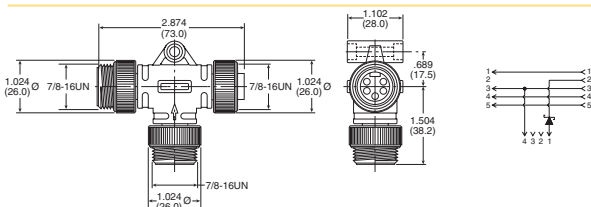

Description	Part number
Bus power tee	RSM RKM 57 WSM 40 PST

For systems not equipped with Power over network, combines separate network and power feeds into the communication module. Includes reverse current protection

DeviceNet & CANopen Terminating Resistor - P2M Network Node, H Series Network Portal, Turck Network Portal

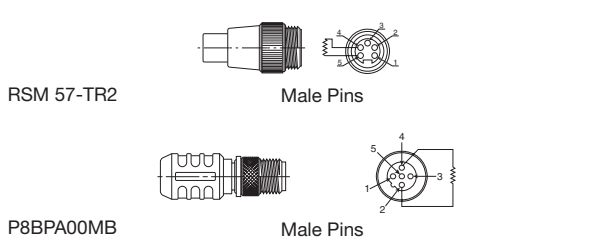

Description	Part number
7/8" Mini Male Pin Terminating Resistor	RSM 57-TR2
M12 Male Pin Terminating Resistor	P8BPA00MA

M12 Power Splitter - PCH Network Portal, Turck Network Portal, P2M IO-Link, P2H IO-Link

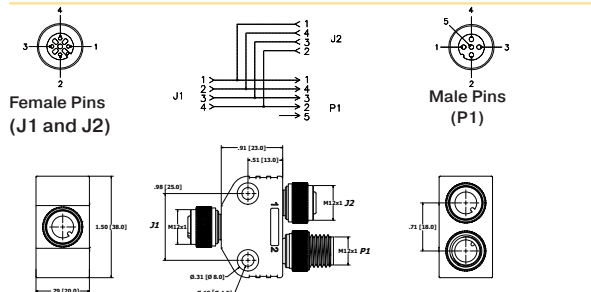

Description	Part Number
M12 Parallel Splitter	100010909

Safety Guide For Selecting And Using Pneumatic Division Products And Related Accessories



WARNING:

FAILURE OR IMPROPER SELECTION OR IMPROPER USE OF PNEUMATIC DIVISION PRODUCTS, ASSEMBLIES OR RELATED ITEMS ("PRODUCTS") CAN CAUSE DEATH, PERSONAL INJURY, AND PROPERTY DAMAGE. POSSIBLE CONSEQUENCES OF FAILURE OR IMPROPER SELECTION OR IMPROPER USE OF THESE PRODUCTS INCLUDE BUT ARE NOT LIMITED TO:

- Unintended or mistimed cycling or motion of machine members or failure to cycle
- Work pieces or component parts being thrown off at high speeds.
- Failure of a device to function properly for example, failure to clamp or unclamp an associated item or device.
- Explosion
- Suddenly moving or falling objects.
- Release of toxic or otherwise injurious liquids or gasses.

Before selecting or using any of these Products, it is important that you read and follow the instructions below.

1. GENERAL INSTRUCTIONS

1.1. Scope: This safety guide is designed to cover general guidelines on the installation, use, and maintenance of Pneumatic Division Valves, FRLs (Filters, Pressure Regulators, and Lubricators), Vacuum products and related accessory components.

1.2. Fail-Safe: Valves, FRLs, Vacuum products and their related components can and do fail without warning for many reasons. Design all systems and equipment in a fail-safe mode, so that failure of associated valves, FRLs or Vacuum products will not endanger persons or property.

1.3 Relevant International Standards: For a good guide to the application of a broad spectrum of pneumatic fluid power devices see: ISO 4414:1998, Pneumatic Fluid Power – General Rules Relating to Systems. See www.iso.org for ordering information.

1.4. Distribution: Provide a copy of this safety guide to each person that is responsible for selection, installation, or use of Valves, FRLs or Vacuum products. Do not select, or use Parker valves, FRLs or vacuum products without thoroughly reading and understanding this safety guide as well as the specific Parker publications for the products considered or selected.

1.5. User Responsibility: Due to the wide variety of operating conditions and applications for valves, FRLs, and vacuum products Parker and its distributors do not represent or warrant that any particular valve, FRL or vacuum product is suitable for any specific end use system. This safety guide does not analyze all technical parameters that must be considered in selecting a product. The user, through its own analysis and testing, is solely responsible for:

- Making the final selection of the appropriate valve, FRL, Vacuum component, or accessory.
- Assuring that all user's performance, endurance, maintenance, safety, and warning requirements are met and that the application presents no health or safety hazards.
- Complying with all existing warning labels and / or providing all appropriate health and safety warnings on the equipment on which the valves, FRLs or Vacuum products are used; and,
- Assuring compliance with all applicable government and industry standards.

1.6. Safety Devices: Safety devices should not be removed, or defeated.

1.7. Warning Labels: Warning labels should not be removed, painted over or otherwise obscured.

1.8. Additional Questions: Call the appropriate Parker technical service department if you have any questions or require any additional information. See the Parker publication for the product being considered or used, or call 1-800-CPARKER, or go to www.parker.com, for telephone numbers of the appropriate technical service department.

2. PRODUCT SELECTION INSTRUCTIONS

2.1. Flow Rate: The flow rate requirements of a system are frequently the primary consideration when designing any pneumatic system. System components need to be able to provide adequate flow and pressure for the desired application.

2.2. Pressure Rating: Never exceed the rated pressure of a product. Consult product labeling, Pneumatic Division catalogs or the instruction sheets supplied for maximum pressure ratings.

2.3. Temperature Rating: Never exceed the temperature rating of a product. Excessive heat can shorten the life expectancy of a product and result in complete product failure.

2.4. Environment: Many environmental conditions can affect the integrity and suitability of a product for a given application. Pneumatic Division products are designed for use in general purpose industrial applications. If these products are to be used in unusual circumstances such as direct sunlight and/or corrosive or caustic environments, such use can shorten the useful life and lead to premature failure of a product.

2.5. Lubrication and Compressor Carryover: Some modern synthetic oils can and will attack nitrile seals. If there is any possibility of synthetic oils or greases migrating into the pneumatic components check for compatibility with the seal materials used. Consult the factory or product literature for materials of construction.

2.6. Polycarbonate Bowls and Sight Glasses: To avoid potential polycarbonate bowl failures:

- Do not locate polycarbonate bowls or sight glasses in areas where they could be subject to direct sunlight, impact blow, or temperatures outside of the rated range.
- Do not expose or clean polycarbonate bowls with detergents, chlorinated hydro-carbons, ketones, esters or certain alcohols.
- Do not use polycarbonate bowls or sight glasses in air systems where compressors are lubricated with fire resistant fluids such as phosphate ester and di-ester lubricants.



2.7. Chemical Compatibility: For more information on plastic component chemical compatibility see Pneumatic Division technical bulletins Tec-3, Tec-4, and Tec-5

- 2.8. Product Rupture:** Product rupture can cause death, serious personal injury, and property damage.
- Do not connect pressure regulators or other Pneumatic Division products to bottled gas cylinders.
 - Do not exceed the maximum primary pressure rating of any pressure regulator or any system component.
 - Consult product labeling or product literature for pressure rating limitations.

3. PRODUCT ASSEMBLY AND INSTALLATION INSTRUCTIONS

3.1. Component Inspection: Prior to assembly or installation a careful examination of the valves, FRLs or vacuum products must be performed. All components must be checked for correct style, size, and catalog number. DO NOT use any component that displays any signs of nonconformance.

3.2. Installation Instructions: Parker published Installation Instructions must be followed for installation of Parker valves, FRLs and vacuum components. These instructions are provided with every Parker valve or FRL sold, or by calling 1-800-CPARKER, or at www.parker.com.

3.3. Air Supply: The air supply or control medium supplied to Valves, FRLs and Vacuum components must be moisture-free if ambient temperature can drop below freezing

4. VALVE AND FRL MAINTENANCE AND REPLACEMENT INSTRUCTIONS

4.1. Maintenance: Even with proper selection and installation, valve, FRL and vacuum products service life may be significantly reduced without a continuing maintenance program. The severity of the application, risk potential from a component failure, and experience with any known failures in the application or in similar applications should determine the frequency of inspections and the servicing or replacement of Pneumatic Division products so that products are replaced before any failure occurs. A maintenance program must be established and followed by the user and, at minimum, must include instructions 4.2 through 4.9.

4.2. Installation and Service Instructions: Before attempting to service or replace any worn or damaged parts consult the appropriate Service Bulletin for the valve or FRL in question for the appropriate practices to service the unit in question. These Service and Installation Instructions are provided with every Parker valve and FRL sold, or are available by calling 1-800-CPARKER, or by accessing the Parker website at www.parker.com.

4.3. Lockout / Tagout Procedures: Be sure to follow all required lockout and tagout procedures when servicing equipment. For more information see: OSHA Standard – 29 CFR, Part 1910.147, Appendix A, The Control of Hazardous Energy – (Lockout / Tagout)

4.4. Visual Inspection: Any of the following conditions requires immediate system shut down and replacement of worn or damaged components:

- Air leakage: Look and listen to see if there are any signs of visual damage to any of the components in the system. Leakage is an indication of worn or damaged components.
- Damaged or degraded components: Look to see if there are any visible signs of wear or component degradation.
- Kinked, crushed, or damaged hoses. Kinked hoses can result in restricted air flow and lead to unpredictable system behavior.
- Any observed improper system or component function: Immediately shut down the system and correct malfunction.
- Excessive dirt build-up: Dirt and clutter can mask potentially hazardous situations.

Caution: Leak detection solutions should be rinsed off after use.

4.5. Routine Maintenance Issues:

- Remove excessive dirt, grime and clutter from work areas.
- Make sure all required guards and shields are in place.

4.6. Functional Test: Before initiating automatic operation, operate the system manually to make sure all required functions operate properly and safely.

4.7. Service or Replacement Intervals: It is the user's responsibility to establish appropriate service intervals. Valves, FRLs and vacuum products contain components that age, harden, wear, and otherwise deteriorate over time. Environmental conditions can significantly accelerate this process. Valves, FRLs and vacuum components need to be serviced or replaced on routine intervals. Service intervals need to be established based on:

- Previous performance experiences.
- Government and / or industrial standards.
- When failures could result in unacceptable down time, equipment damage or personal injury risk.

4.8. Servicing or Replacing of any Worn or Damaged Parts: To avoid unpredictable system behavior that can cause death, personal injury and property damage:

- Follow all government, state and local safety and servicing practices prior to service including but not limited to all OSHA Lockout Tagout procedures (OSHA Standard – 29 CFR, Part 1910.147, Appendix A, The Control of Hazardous Energy – Lockout / Tagout).
- Disconnect electrical supply (when necessary) before installation, servicing, or conversion.
- Disconnect air supply and depressurize all air lines connected to system and Pneumatic Division products before installation, service, or conversion.
- Installation, servicing, and / or conversion of these products must be performed by knowledgeable personnel who understand how pneumatic products are to be applied.
- After installation, servicing, or conversions air and electrical supplies (when necessary) should be connected and the product tested for proper function and leakage. If audible leakage is present, or if the product does not operate properly, do not put product or system into use.
- Warnings and specifications on the product should not be covered or painted over. If masking is not possible, contact your local representative for replacement labels.

4.9. Putting Serviced System Back into Operation: Follow the guidelines above and all relevant Installation and Maintenance Instructions supplied with the valve FRL or vacuum component to insure proper function of the system.



PARKER-HANNIFIN CORPORATION
OFFER OF SALE

1. Definitions. As used herein, the following terms have the meanings indicated.

- Buyer: means any customer receiving a Quote for Products.
- Goods: means any tangible part, system or component to be supplied by Seller.
- Products: means the Goods, Services and/or Software as described in a Quote.
- Quote: means the offer or proposal made by Seller to Buyer for the supply of Products.
- Seller: means Parker-Hannifin Corporation, including all divisions and businesses thereof.
- Services: means any services to be provided by Seller.
- Software: means any software related to the Goods, whether embedded or separately downloaded.
- Terms: means the terms and conditions of this Offer of Sale.

2. Terms. All sales of Products by Seller are expressly conditioned upon, and will be governed by the acceptance of, these Terms. These Terms are incorporated into any Quote provided by Seller to Buyer. Buyer's order for any Products whether communicated to Seller verbally, in writing, by electronic data interface or other electronic commerce, shall constitute acceptance of these Terms. Seller objects to any contrary or additional terms or conditions of Buyer. Reference in Seller's order acknowledgement to Buyer's purchase order or purchase order number shall in no way constitute an acceptance of any of Buyer's terms or conditions of purchase. No modification to these Terms will be binding on Seller unless agreed to in writing and signed by an authorized representative of Seller.

3. Price; Payment. The Products set forth in the Quote are offered for sale at the prices indicated in the Quote. Unless otherwise specifically stated in the Quote, prices are valid for thirty (30) days and do not include any sales, use, or other taxes or duties. Seller reserves the right to modify prices at any time to adjust for any raw material price fluctuations. Unless otherwise specified by Seller, all prices are F.C.A. Seller's facility (INCOTERMS 2020). All sales are contingent upon credit approval and full payment for all purchases is due thirty (30) days from the date of invoice (or such date as may be specified in the Quote). Unpaid invoices beyond the specified payment date incur interest at the rate of 1.5% per month or the maximum allowable rate under applicable law.

4. Shipment; Delivery; Title and Risk of Loss. All delivery dates are approximate, and Seller is not responsible for damages resulting from any delay. Regardless of the manner of shipment, delivery occurs and title and risk of loss or damage pass to Buyer, upon placement of the Products with the carrier at Seller's facility. Unless otherwise agreed prior to shipment and for domestic delivery locations only, Seller will select and arrange, at Buyer's sole expense, the carrier and means of delivery. When Seller selects and

arranges the carrier and means of delivery, freight and insurance costs for shipment to the designated delivery location will be prepaid by Seller and added as a separate line item to the invoice. Buyer shall be responsible for any additional shipping charges incurred by Seller due to Buyer's acts or omissions. Buyer shall not return or repackage any Products without the prior written authorization from Seller, and any return shall be at the sole cost and expense of Buyer.

5. Warranty. The warranty for the Products is as follows: (i) Goods are warranted against defects in material or workmanship for a period of twelve (12) months from the date of delivery or 2,000 hours of use, whichever occurs first; (ii) Services shall be performed in accordance with generally accepted practices and using the degree of care and skill that is ordinarily exercised and customary in the field to which the Services pertain and are warranted for a period of six (6) months from the date of completion of the Services; and (iii) Software is only warranted to perform in accordance with applicable specifications provided by Seller to Buyer for ninety (90) days from the date of delivery or, when downloaded by a Buyer or end-user, from the date of the initial download. All prices are based upon the exclusive limited warranty stated above, and upon the following disclaimer: **EXEMPTION CLAUSE; DISCLAIMER OF WARRANTY, CONDITIONS, REPRESENTATIONS: THIS WARRANTY IS THE SOLE AND ENTIRE WARRANTY, CONDITION, AND REPRESENTATION, PERTAINING TO PRODUCTS. SELLER DISCLAIMS ALL OTHER WARRANTIES, CONDITIONS, AND REPRESENTATIONS, WHETHER STATUTORY, EXPRESS OR IMPLIED, INCLUDING BUT NOT LIMITED TO THOSE RELATING TO DESIGN, NONINFRINGEMENT, MERCHANTABILITY, AND FITNESS FOR A PARTICULAR PURPOSE. SELLER DOES NOT WARRANT THAT THE SOFTWARE IS ERROR-FREE OR FAULT-TOLERANT, OR THAT BUYER'S USE THEREOF WILL BE SECURE OR UNINTERRUPTED. UNLESS OTHERWISE AUTHORIZED IN WRITING BY SELLER, THE SOFTWARE SHALL NOT BE USED IN CONNECTION WITH HAZARDOUS OR HIGH RISK ACTIVITIES OR ENVIRONMENTS. EXCEPT AS EXPRESSLY STATED HEREIN, ALL PRODUCTS ARE PROVIDED "AS IS".**

6. Claims; Commencement of Actions. Buyer shall promptly inspect all Products upon receipt. No claims for shortages will be allowed unless reported to Seller within ten (10) days of delivery. Buyer shall notify Seller of any alleged breach of warranty within thirty (30) days after the date the non-conformance is or should have been discovered by Buyer. Any claim or action against Seller based upon breach of contract or any other theory, including tort, negligence, or otherwise must be commenced within twelve (12) months from the date of the alleged breach or other alleged event, without regard to the date of discovery.

7. LIMITATION OF LIABILITY. IN THE EVENT OF A BREACH OF WARRANTY, SELLER WILL, AT ITS OPTION, REPAIR OR REPLACE THE NON-CONFORMING PRODUCT, RE-PERFORM THE SERVICES, OR REFUND THE PURCHASE PRICE PAID WITHIN A REASONABLE PERIOD OF TIME. **IN NO EVENT IS SELLER LIABLE FOR**



ANY SPECIAL, INDIRECT, INCIDENTAL OR CONSEQUENTIAL DAMAGES INCLUDING ANY LOSS OF REVENUE OR PROFITS, WHETHER BASED IN CONTRACT, TORT OR OTHER LEGAL THEORY. IN NO EVENT SHALL SELLER'S LIABILITY UNDER ANY CLAIM MADE BY BUYER EXCEED THE PURCHASE PRICE PAID FOR THE PRODUCTS.

8. Confidential Information. Buyer acknowledges and agrees that any technical, commercial, or other confidential information of Seller, including, without limitation, pricing, technical drawings or prints and/or part lists, which has been or will be disclosed, delivered or made available, whether directly or indirectly, to Buyer ("Confidential Information"), has been and will be received in confidence and will remain the property of Seller. Buyer further agrees that it will not use Seller's Confidential Information for any purpose other than for the benefit of Seller.

9. Loss to Buyer's Property. Any tools, patterns, materials, equipment or information furnished by Buyer or which are or become Buyer's property ("Buyer's Property"), will be considered obsolete and may be destroyed by Seller after two (2) consecutive years have elapsed without Buyer ordering the Products manufactured using Buyer's Property. Furthermore, Seller shall not be responsible for any loss or damage to Buyer's Property while it is in Seller's possession or control.

10. Special Tooling. "Special Tooling" includes but is not limited to tools, jigs, fixtures and associated manufacturing equipment acquired or necessary to manufacture Goods. Seller may impose a tooling charge for any Special Tooling. Such Special Tooling shall be and remain Seller's property notwithstanding payment of any charges by Buyer. In no event will Buyer acquire any interest in the Special Tooling, even if such Special Tooling has been specially converted or adapted for manufacture of Goods for Buyer and notwithstanding any charges paid by Buyer. Unless otherwise agreed, Seller has the right to alter, discard or otherwise dispose of any Special Tooling or other property owned by Seller in its sole discretion at any time.

11. Security Interest. To secure payment of all sums due from Buyer, Seller retains a security interest in all Products delivered to Buyer and, Buyer's acceptance of these Terms is deemed to be a Security Agreement under the Uniform Commercial Code. Buyer authorizes Seller as its attorney to execute and file on Buyer's behalf all documents Seller deems necessary to perfect Seller's security interest.

12. User Responsibility. Buyer, through its own analysis and testing, is solely responsible for making the final selection of the Products and assuring that all performance, endurance, maintenance, safety and warning requirements of the application of the Products are met. Buyer must analyze all aspects of the application and follow applicable industry standards, specifications, and any technical information provided with the Quote or the Products, such as Seller's instructions, guides and specifications. If Seller provides options of or for Products based upon data or specifications provided by Buyer, Buyer is responsible for determining that such data and specifications are suitable and sufficient for all applications and reasonably foreseeable uses of the Products. In the event Buyer is not the end-user

of the Products, Buyer will ensure such end-user complies with this paragraph.

13. Use of Products, Indemnity by Buyer. Buyer shall comply with all instructions, guides and specifications provided by Seller with the Quote or the Products. **Unauthorized Uses.** If Buyer uses or resells the Products in any way prohibited by Seller's instructions, guides or specifications, or Buyer otherwise fails to comply with Seller's instructions, guides and specifications, Buyer acknowledges that any such use, resale, or non-compliance is at Buyer's sole risk. Further, Buyer shall indemnify, defend, and hold Seller harmless from any losses, claims, liabilities, damages, lawsuits, judgments and costs (including attorney fees and defense costs), whether for personal injury, property damage, intellectual property infringement or any other claim, arising out of or in connection with: (a) improper selection, design, specification, application, or any misuse of Products; (b) any act or omission, negligent or otherwise, of Buyer; (c) Seller's use of patterns, tools, equipment, plans, drawings, designs, specifications or other information or things furnished by Buyer; (d) damage to the Products from an external cause, repair or attempted repair by anyone other than Seller, failure to follow instructions, guides and specifications provided by Seller, use with goods not provided by Seller, or opening, modifying, deconstructing, tampering with or repackaging the Products; or (e) Buyer's failure to comply with these Terms. Seller shall not indemnify Buyer under any circumstance except as otherwise provided in these Terms.

14. Cancellations and Changes. Buyer may not cancel or modify, including but not limited to movement of delivery dates for the Products, any order for any reason except with Seller's written consent and upon terms that will indemnify, defend and hold Seller harmless against all direct, incidental and consequential loss or damage and any additional expense. Seller, at any time, may change features, specifications, designs and availability of Products.

15. Limitation on Assignment. Buyer may not assign its rights or obligations without the prior written consent of Seller.

16. Force Majeure. Seller is not liable for delay or failure to perform any of its obligations by reason of events or circumstances beyond its reasonable control. Such circumstances include without limitation: accidents, labor disputes or stoppages, government acts or orders, acts of nature, pandemics, epidemics, other widespread illness, or public health emergency, delays or failures in delivery from carriers or suppliers, shortages of materials, war (whether declared or not) or the serious threat of same, riots, rebellions, acts of terrorism, fire or any reason whether similar to the foregoing or otherwise. Seller will resume performance as soon as practicable after the event of force majeure has been removed. All delivery dates affected by force majeure shall be tolled for the duration of such force majeure and rescheduled for mutually agreed dates as soon as practicable after the force majeure condition ceases to exist. Force majeure shall not include financial distress, insolvency, bankruptcy, or other similar conditions affecting one of the parties, affiliates and/or sub-contractors.



17. Waiver and Severability. Failure to enforce any provision of these Terms will not invalidate that provision; nor will any such failure prejudice either party's right to enforce that provision in the future. Invalidation of any provision of these Terms shall not invalidate any other provision herein and, the remaining provisions will remain in full force and effect.

18. Termination. Seller may terminate any agreement governed by or arising from these Terms for any reason and at any time by giving Buyer thirty (30) days prior written notice. Seller may immediately terminate, in writing, if Buyer: (a) breaches any provision of these Terms, (b) becomes or is deemed insolvent, (c) appoints or has appointed a trustee, receiver or custodian for all or any part of Buyer's property, (d) files a petition for relief in bankruptcy on its own behalf, or one is filed against Buyer by a third party, (e) makes an assignment for the benefit of creditors; or (f) dissolves its business or liquidates all or a majority of its assets.

19. Ownership of Software. Seller retains ownership of all Software supplied to Buyer hereunder. In no event shall Buyer obtain any greater right in and to the Software than a right in the nature of a license limited to the use thereof and subject to compliance with any other terms provided with the Software.

20. Indemnity for Infringement of Intellectual Property Rights. Seller is not liable for infringement of any patents, trademarks, copyrights, trade dress, trade secrets or similar rights ("Intellectual Property Rights") except as provided in this Section. Seller will defend at its expense and will pay the cost of any settlement or damages awarded in an action brought against Buyer based on a third party claim that one or more of the Products sold hereunder infringes the Intellectual Property Rights of a third party in the country of delivery of the Products by Seller to Buyer. Seller's obligation to defend and indemnify Buyer is contingent on Buyer notifying Seller within ten (10) days after Buyer becomes aware of any such claim, and Seller having sole control over the defense of the claim including all negotiations for settlement or compromise. If one or more Products sold hereunder is subject to such a claim, Seller may, at its sole expense and option, procure for Buyer the right to continue using the Products, replace or modify the Products so as to render them non-infringing, or offer to accept return of the Products and refund the purchase price less a reasonable allowance for depreciation. Seller has no obligation or liability for any claim of infringement: (i) arising from information provided by Buyer; or (ii) directed to any Products provided hereunder for which the designs are specified in whole or part by Buyer; or (iii) resulting from the modification, combination or use in a system of any Products provided hereunder. The foregoing provisions of this Section constitute Seller's sole and exclusive liability and Buyer's sole and exclusive remedy for claims of infringement of Intellectual Property Rights.

21. Governing Law. These Terms and the sale and delivery of all Products are deemed to have taken place in, and shall be governed and construed in accordance with, the laws of the State of Ohio, as applicable to contracts executed and wholly performed therein and without regard to conflicts of laws principles. Buyer irrevocably agrees and consents to the exclusive jurisdiction and venue of the courts of

Cuyahoga County, Ohio with respect to any dispute, controversy or claim arising out of or relating to the sale and delivery of the Products.

22. Entire Agreement. These Terms, along with the terms set forth in the main body of any Quote, forms the entire agreement between the Buyer and Seller and constitutes the final, complete and exclusive expression of the terms of sale and purchase. In the event of a conflict between any term set forth in the main body of a Quote and these Terms, the terms set forth in the main body of the Quote shall prevail. All prior or contemporaneous written or oral agreements or negotiations with respect to the subject matter shall have no effect. These Terms may not be modified unless in writing and signed by an authorized representative of Seller.

23. Compliance with Laws. Buyer agrees to comply with all applicable laws, regulations, and industry and professional standards, including those of the United States of America, and the country or countries in which Buyer may operate, including without limitation the U.S. Foreign Corrupt Practices Act ("FCPA"), the U.S. Anti-Kickback Act ("Anti-Kickback Act"), U.S. and E.U. export control and sanctions laws ("Export Laws"), the U.S. Food Drug and Cosmetic Act ("FDCA"), and the rules and regulations promulgated by the U.S. Food and Drug Administration ("FDA"), each as currently amended. Buyer agrees to indemnify, defend, and hold harmless Seller from the consequences of any violation of such laws, regulations and standards by Buyer, its employees or agents. Buyer acknowledges that it is familiar with all applicable provisions of the FCPA, the Anti-Kickback Act, Export Laws, the FDCA and the FDA and certifies that Buyer will adhere to the requirements thereof and not take any action that would make Seller violate such requirements. Buyer represents and agrees that Buyer will not make any payment or give anything of value, directly or indirectly, to any governmental official, foreign political party or official thereof, candidate for foreign political office, or commercial entity or person, for any improper purpose, including the purpose of influencing such person to purchase Products or otherwise benefit the business of Seller. Buyer further represents and agrees that it will not receive, use, service, transfer or ship any Products from Seller in a manner or for a purpose that violates Export Laws or would cause Seller to be in violation of Export Laws. Buyer agrees to promptly and reliably provide Seller all requested information or documents, including end-user statements and other written assurances, concerning Buyer's ongoing compliance with Export Laws.



www.parker.com



European Headquarters
La Tuilière 6, 1163 Etoy,
Switzerland
Tel: +41 21 821 85 00

Your authorized distributor