

SMH / SMB SERIES
LOW INERTIA SERVO MOTORS





WARNING – USER RESPONSIBILITY

FAILURE OR IMPROPER SELECTION OR IMPROPER USE OF THE PRODUCTS DESCRIBED HEREIN OR RELATED ITEMS CAN CAUSE DEATH, PERSONAL INJURY AND PROPERTY DAMAGE.

- This document and other information from Parker-Hannifin Corporation, its subsidiaries and authorized distributors provide product or system options for further investigation by users having technical expertise.
- The user, through its own analysis and testing, is solely responsible for making the final selection of the system and components and assuring that all performance, endurance, maintenance, safety and warning requirements of the application are met. The user must analyze all aspects of the application, follow applicable industry standards, and follow the information concerning the product in the current product catalog and in any other materials provided from Parker or its subsidiaries or authorized distributors.
- To the extent that Parker or its subsidiaries or authorized distributors provide component or system options based upon data or specifications provided by the user, the user is responsible for determining that such data and specifications are suitable and sufficient for all applications and reasonably foreseeable uses of the components or systems.

SALE CONDITIONS

The items described in this document are available for sale by Parker Hannifin Corporation, its subsidiaries or its authorized distributors. Any sale contract entered into by Parker will be governed by the provisions stated in Parker's standard terms and conditions of sale (copy available upon request).

Low Inertia Servo Motors - SMH / SMB

Overview	5
Technical Characteristics	6
Technical Data	6
Speed Torque Curves	8
Dimensions of Standard Motors with Resolver Feedback	11
Options	12
Holding Brake	12
Medium Inertia.....	12
Feedback	12
Layout and Connectors	15
Associated Drives	17
Order Code	18
Serie SMH /SMB / SME	18
Motor Power Cable for SMH /SMB Motors	20
Feedback Cable for SMH / SMB Motors	21

Parker Hannifin

The global leader in motion and control technologies

A world class player on a local stage

Global Product Design

Parker Hannifin has more than 40 years experience in the design and manufacturing of drives, controls, motors and mechanical products. With dedicated global product development teams, Parker draws on industry-leading technological leadership and experience from engineering teams in Europe, North America and Asia.

Local Application Expertise

Parker has local engineering resources committed to adapting and applying our current products and technologies to best fit our customers' needs.

Manufacturing to Meet Our Customers' Needs

Parker is committed to meeting the increasing service demands that our customers require to succeed in the global industrial market. Parker's manufacturing teams seek continuous improvement through the implementation of lean manufacturing methods throughout the process. We measure ourselves on meeting our customers' expectations of quality and delivery, not just our own. In order to meet these expectations, Parker operates and continues to invest in our manufacturing facilities in Europe, North America and Asia.

Electromechanical Worldwide Manufacturing Locations

Europe

Littlehampton, United Kingdom
Dijon, France
Offenburg, Germany
Filderstadt, Germany
Milan, Italy

Asia

Wuxi, China
Jangan, Korea
Chennai, India

North America

Rohnert Park, California
Irwin, Pennsylvania
Charlotte, North Carolina
New Ulm, Minnesota



Offenburg, Germany

Local Manufacturing and Support in Europe

Parker provides sales assistance and local technical support through a network of dedicated sales teams and authorized technical distributors throughout Europe.

For contact information, please refer to the Sales Offices on the back cover of this document or visit www.parker.com



Milan, Italy



Littlehampton, UK



Filderstadt, Germany



Dijon, France

Low Inertia Servo Motors - SMH / SMB

Overview

Description

The SMH / SMB Series of highly-dynamic brushless servo motors have been design to combine the cutting-edge technology of Parker Hannifin products with an extremely high performance. Thanks to the innovative "salient pole" technology, the motor's dimensions are considerably reduced with significant advantages in terms of specific torque, overall dimensions and dynamic performance. Compared to traditional-technology brushless servo motors, the specific torque is approximately 30 % higher, overall dimensions are considerably reduced and, consequently rotor inertias are extremely low. Thanks to the high quality of Neodymium-Iron-Boron magnets, and also the encapsulation method used to fasten them to the shaft, the SMH/B motors can achieve very high acceleration and withstand high overloads without risk of demagnetisation or detachment of the magnets.

Specific applications for the SMH/B Series include all types especially those for the packaging and handling industry, and all those applications where very high dynamic performances and very low inertias are required.

Features

- High number of feedback options
- Customised windings/voltages
- Increased Inertia option
- Multiple connection options

Application

- Food, Pharma & Beverage
- Packaging Machines
- Material Forming
- Material Handling
- Factory Automation
- Life Science Diagnostic
- Automotive Industry / In-Plant
- Printing Industry
- Textile Machines
- Robotics
- Servo Hydraulic Pumps

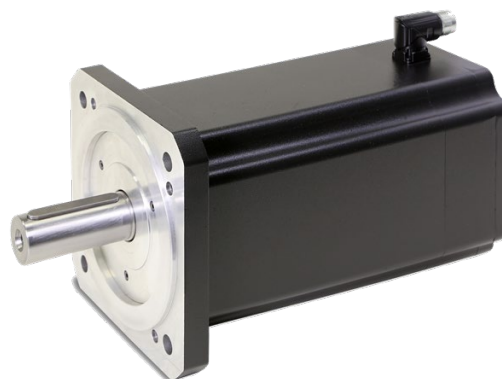

Technical Characteristics - Overview

Motor Type	Permanent magnets synchronous servomotor
Rotor Design	Rotor with surface rare earth magnets
Number of poles	8
Power Range	0.1 – 9.4 kW
Torque Range	0.19 – 60 Nm
Speed Range	0 – 7500 min ⁻¹
Mounting	Flange with smooth holes
Shaft End	Plain keyed shaft Plain smooth shaft (option)
Cooling	Natural ventilation
Protection Level (IEC60034-5)	IP64 IP65 (option/standard for SM_170)
Feedback sensor	Resolver Absolute Endat or Hiperface Incremental Encoder
Thermal protection	PTC for SMB and KTY compatible with SMH
Other options	Brake Second shaft Increased inertia
Marking	CE UL (SM_40 and SM_170 excluded)
Voltage Supply	80 / 230 / 400 VAC other voltage under request
Temperature Class	Class F
Connections	Rotatable connectors Flying cables Terminal Box (see table option for combination) Special connector (under request)

Technical Characteristics

Technical Data

230 VAC supply voltage

Model	Size	Stall ⁽¹⁾		Nominal ⁽¹⁾			Peak ⁽¹⁾	Inertia		Ke ^{(2) (3)}	Kt ^{(2) (3)}
		Torque	Current	Torque	Speed	Current	Torque	No brake	With brake		
		T ₀₆₅ (T ₁₀₅) [Nm]	I ₀₆₅ [A]	T _{n065} [Nm]	n [min ⁻¹]	I _{n065} [A]	T _{max} [Nm]	J [kgmm ²]	J [kgmm ²]	Ke [Vs]	Kt [Nm/A _{rms}]
SM_40 60 0,19	40	0.19	0.78	0.16	6000	0.66	0.6	3.7	-	0.14	0.242
SM_40 60 0,38		0.38	1.2	0.27	6000	0.86	1.17	6.1		0.181	0.31
SM_60 30 0,55	60	0.55 (0.68)	0.7	0.50	3000	0.66	1.7	18	30.5	0.44	0.76
SM_60 45 0,55			1.0	0.39	4500	0.74				0.30	0.53
SM_60 60 0,55			1.4	0.24	6000	0.60				0.23	0.40
SM_60 16 1,4		1.4 (1.7)	0.95	1.35	1600	0.91	4.4	30	42.5	0.85	1.48
SM_60 30 1,4			1.73	1.20	3000	1.50				0.47	0.81
SM_60 45 1,4			2.37	1.00	4500	1.69				0.34	0.59
SM_60 60 1,4			2.98	0.80	6000	1.70				0.27	0.47
SM_60 75 1,4			3.85	0.15	7500	0.41				0.21	0.36
SM_82 10 03	82	3 (3.7)	1.2	2.9	1000	1.2	9	140	183	1.43	2.48
SM_82 16 03			1.8	2.9	1600	1.7				0.96	1.66
SM_82 30 03			3.1	2.7	3000	2.8				0.55	0.96
SM_82 33 03			3.5	2.4	3300	2.8				0.49	0.85
SM_82 45 03			4.7	2.2	4500	3.4				0.37	0.64
SM_82 60 03			6.1	1.5	6000	3.1				0.28	0.49
SM_82 75 03			7.5	0.6	7500	1.6				0.23	0.40
SM_100 16 06	100	6 (9)	3.7	5.8	1600	3.6	18	336	440	0.92	1.60
SM_100 30 06			5.9	5.0	3000	4.9				0.59	1.02
SM_100 45 06			9.4	3.5	4500	5.5				0.37	0.64
SM_100 55 06			11.8	2.6	5500	5.1				0.29	0.51
SM_100 75 06			14.7	0.6	7500	1.5				0.24	0.41
SM_115 16 10	115	10 (12.5)	6.0	9.0	1600	5.4	32	900	1000	0.96	1.66
SM_115 30 10			10.5	8.0	3000	8.4				0.55	0.95
SM_115 40 10			14.7	7.6	4000	11.2				0.39	0.68
SM_115 54 10			18.2	7.1	5400	12.9				0.32	0.55
SM_142 18 15	142	15 (19)	9.7	13.3	1800	8.6	47	1400	1600	0.89	1.54
SM_142 30 15			16.0	12.5	3000	13.4				0.54	0.94
SM_170 11 35	170	35	13.3	30	1100	11.4	111	2900	4500	1.52	2.6
SM_170 16 35			20	28	1600	16.0				1.03	1.8
SM_170 25 35			29	26	2500	22.0				0.69	1.2

⁽¹⁾ Data referred to motor mounted on a steel flange in horizontal position with resolver and without brake. Stall torques refer to motor turning at 100 min⁻¹

⁽²⁾ Data measured at 20 °C. When "hot" consider -0.09 %/K derating

⁽³⁾ Manufacturing tolerance ±10 %

400 VAC power supply

Model	Size	Stall ⁽¹⁾		Nominal ⁽¹⁾			Peak ⁽¹⁾	Inertia		Ke ^{(2) (3)}	Kt ^{(2) (3)}
		Torque	Current	Torque	Speed	Current	Torque	No brake	With brake		
		T ₀₆₅ (T ₁₀₅) [Nm]	I ₀₆₅ [A]	T _{n065} [Nm]	n [min ⁻¹]	I _{n065} [A]	T _{max} [Nm]	J [kgmm ²]	J [kgmm ²]	Ke [Vs]	Kt [Nm/A _{rms}]
SM_60 30 1,4	60	1.4 (1.7)	0.95	1.2	3000	0.81	4.4	30	42.5	0.81	1.48
SM_60 45 1,4			1.37	1.0	4500	0.98				0.59	1.02
SM_60 60 1,4			1.73	0.8	6000	0.99				0.68	0.81
SM_60 75 1,4			2.15	0.15	7500	0.23				0.38	0.65
SM_82 30 03	82	3 (3.7)	1.8	2.7	3000	1.6	9	140	183	0.96	1.66
SM_82 45 03			2.7	2.2	4500	2.0				0.64	1.11
SM_82 56 03			3.1	1.6	5600	1.7				0.55	0.96
SM_82 60 03			3.5	1.7	6000	2.0				0.49	0.85
SM_82 75 03			4.4	0.6	7500	0.9				0.39	0.68
SM_100 30 06	100	6 (9)	3.7	5.0	3000	3.1	18	336	440	0.92	1.60
SM_100 45 06			5.6	3.5	4500	3.3				0.62	1.07
SM_100 56 06			5.9	2.5	5600	2.4				0.59	1.02
SM_100 75 06			9.4	0.6	7500	0.9				0.37	0.64
SM_115 20 10	115	10 (12.5)	4.5	9.0	2000	4.06	32	900	1000	1.28	2.22
SM_115 30 10			6.0	8.0	3000	4.82				0.96	1.66
SM_115 40 10			8.0	7.6	4000	6.05				0.73	1.26
SM_115 56 10			10.5	6.0	5600	6.30				0.55	0.95
SM_142 20 15	142	15 (19)	6.4	13.0	2000	5.5	47	1400	1600	1.36	2.35
SM_142 30 15			9.7	12.5	3000	8.1				0.89	1.54
SM_142 45 15			14.4	10.9	4500	10.5				0.60	1.04
SM_142 56 15			16.0	9.2	5600	9.8				0.54	0.94
SM_142 10 17		17 (21)	3.5	16.4	1000	3.4	54			2.83	4.90
SM_142 30 17			9.6	14.0	3000	8.1				1.02	1.77
SM_142 56 17			15.8	10.6	5600	9.8				0.62	1.08
SM_170 10 35			170	35	6.8	31				1000	6.1
SM_170 20 35	13.3	27			2000	10.3	1.52	2.6			
SM_170 27 35	18	22			2700		1.15	2.0			
SM_170 30 35	20	19			3000	11	1.03	1.8			
SM_170 10 60	60	11.7		53	1000	10.4	190	5800	7400	2.95	5.1
SM_170 20 60		22.6		44	2000	16.6				1.53	2.7
SM_170 30 60		35.7		30	3000	17.9				0.97	1.7

⁽¹⁾ Data referred to motor mounted on a steel flange in horizontal position with resolver and without brake. Stall torques refer to motor turning at 100 min⁻¹

⁽²⁾ Data measured at 20 °C. When "hot" consider -0.09 %/K derating

⁽³⁾ Manufacturing tolerance data ± 10 %

STANDARDS

In compliance with: 2006/95 EC

- EN60034-1
- EN60034-5
- EN60034-5/A1

Marked  Marked  (except SM_40 and SM_170)

Brushless servo motors SMH / SMB
Curves

Speed Torque Curves

SMH/B60

4500 min⁻¹ 230 V

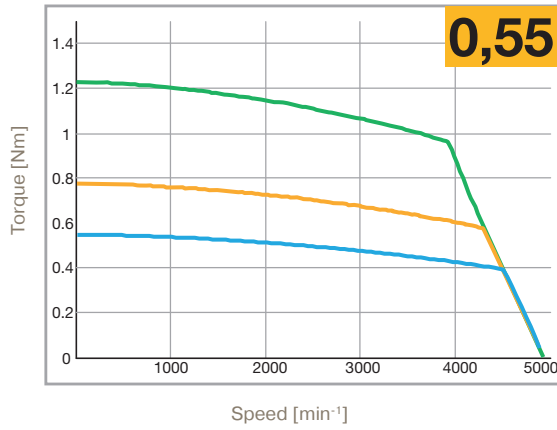

6000 min⁻¹ 230 V

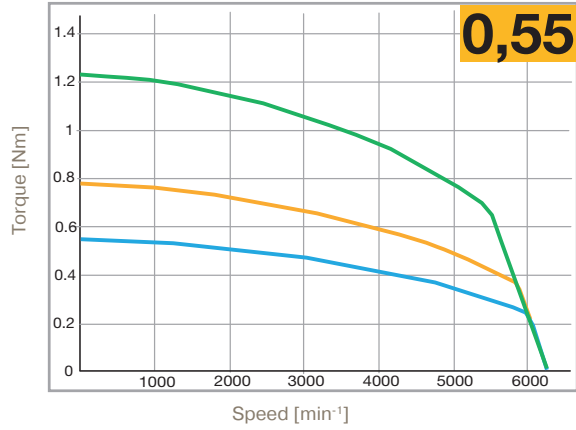

1600 min⁻¹ 230 V - 3000 min⁻¹ 400 V

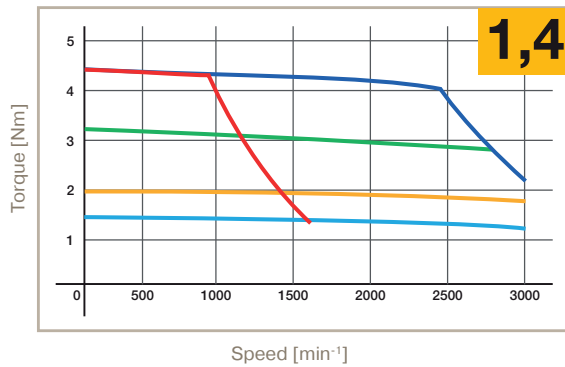

3000 min⁻¹ 230 V - 6000 min⁻¹ 400 V

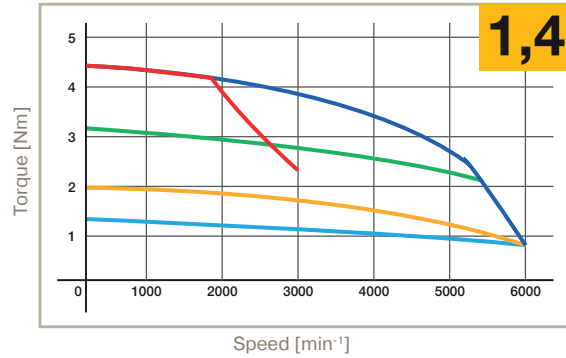

— S1 65 K, ΔT
— S3 10 %, 5 min, 400 V
— S3 50 %, 5 min
— S3 10 %, 5 min, 230 V
— S3 50 %, 5 min
— S3 20 %, 5 min

SMH/B82

1600 min⁻¹ 230 V - 3000 min⁻¹ 400 V

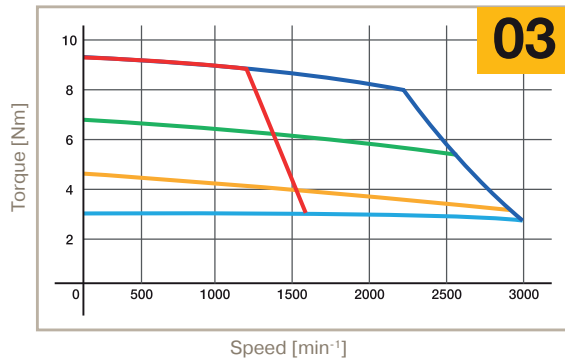

3000 min⁻¹ 230 V - 5600 min⁻¹ 400 V

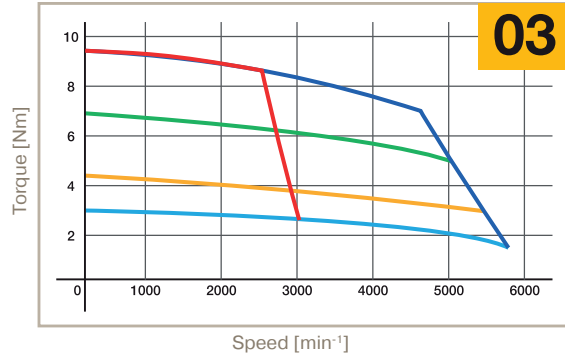

SMH/B100

1600 min⁻¹ 230 V - 3000 min⁻¹ 400 V

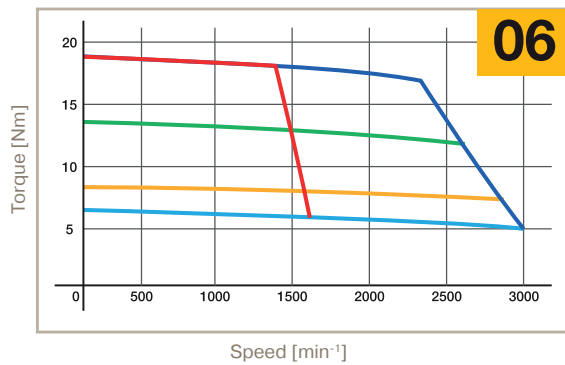

3000 min⁻¹ 230 V - 5600 min⁻¹ 400 V

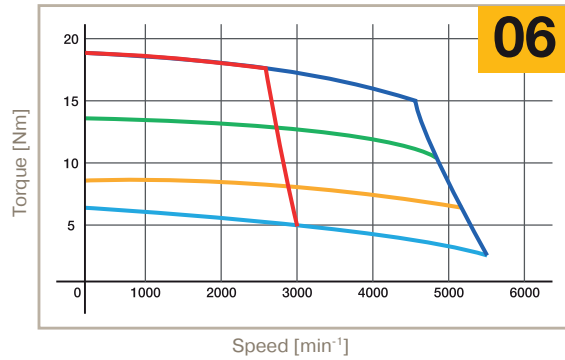

SMH/B115

1600 min⁻¹ 230 V - 3000 min⁻¹ 400 V

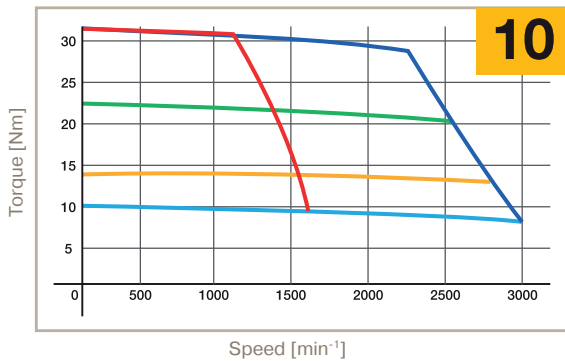

3000 min⁻¹ 230 V - 5600 min⁻¹ 400 V

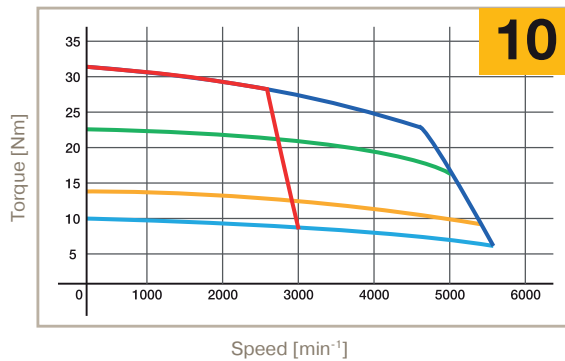

- S1 65 K, ΔT
- S3 10 %, 5 min, 400 V
- S3 50 %, 5 min
- S3 10 %, 5 min, 230 V
- S3 50 %, 5 min
- S3 20 %, 5 min

Brushless servo motors SMH / SMB
Curves

SMH/B142

1800 min⁻¹ 230 V - 3000 min⁻¹ 400 V

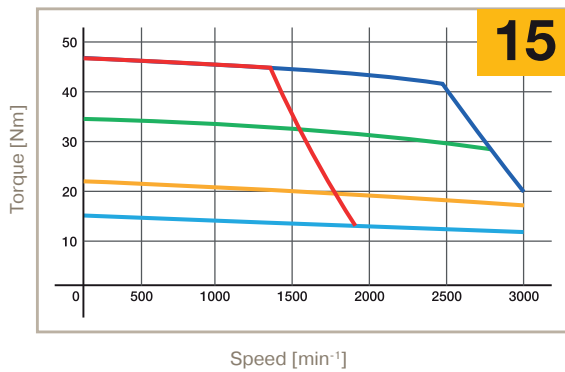

3000 min⁻¹ 230 V - 5600 min⁻¹ 400 V

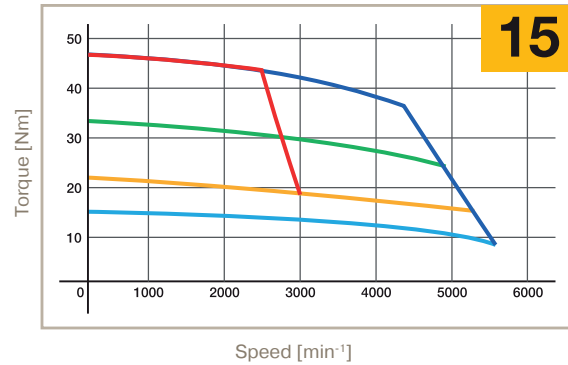

1000 min⁻¹ 400 V

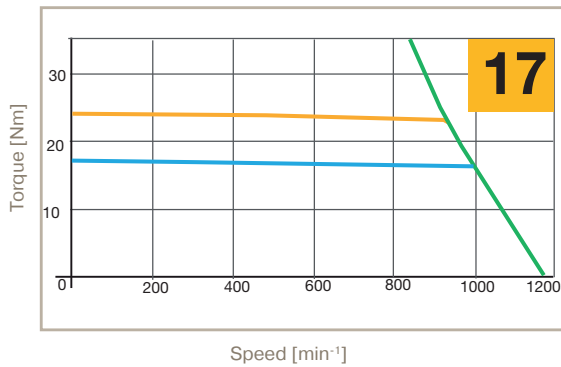

SMH/B170

1600 min⁻¹ 230 V - 3000 min⁻¹ 400 V

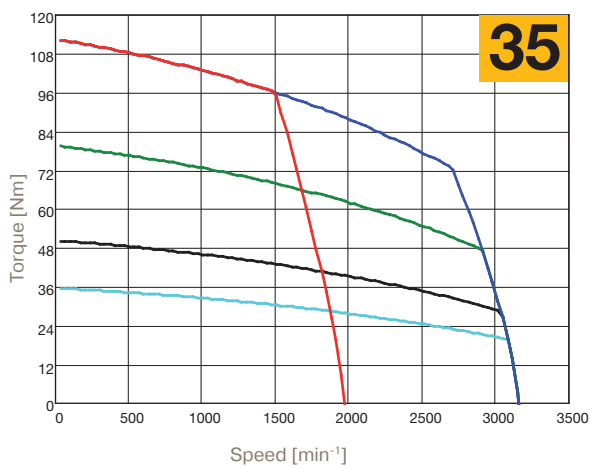

2000 min⁻¹ 400 V

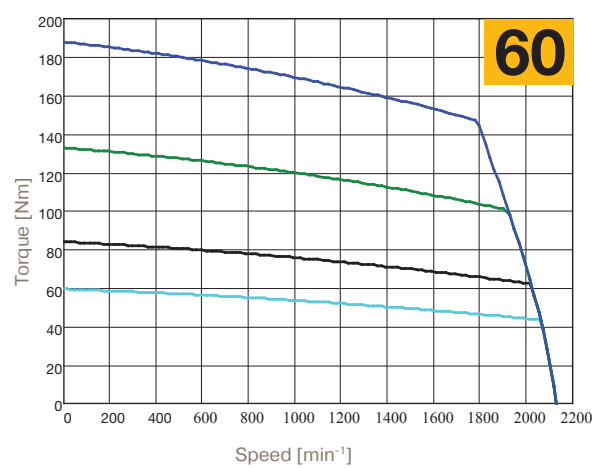

— S1 65 K, ΔT — S3 10 %, 5 min, 230 V
— S3 10 %, 5 min, 400 V — S3 50 %, 5 min
— S3 50 %, 5 min — S3 20 %, 5 min

Dimensions of Standard Motors with Resolver Feedback

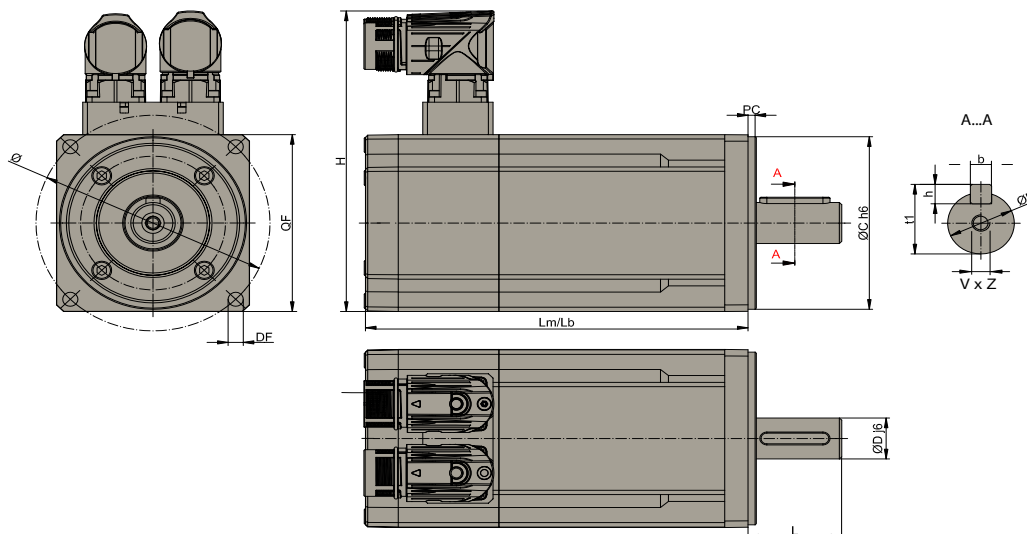

Dimensions [mm]

Motor Size	LM LB	Weight [kg]	DxL	bxh	t1	VxZ	H	C	Ø	DF	PC	QF	Order Code QF		
SMH / B	40	0,19	87.5 119.5	0.53 n.a.	8x20	3x3	9.2	n.a.	60 Layout 2Y	30	50	4.3	2.5	40	5
		0,38	105.5 137.5	0.68 n.a.	8x20	3x3	9.2	n.a.	60 Layout 2Y	30	50	4.3	2.5	40	5
	60	0,55	91.2 137	1 1.3	9x20 11x23	3x3 4x4	10.2 12.5	- M4x10	118 Layout 2I	40	63	5.5	2.5	60	8
			60	75	6	2.5	70	5							
		1,4	129.5 161	1.5 1.8	9x20 11x23	3x3 4x4	10.2 12.5	- M4x10		40	63	5.5	2.5	60	8
	82	03	159 202	3.6 4.3	11x23 ⁽²⁾ 14x30	4x4 5x5	12.5 16	M4x10 M5x12.5	140 Layout 2I	60	75	6	2.5	70	7
			163.5 206.5	3.6 4.3	11x23 ⁽²⁾ 14x30 19x40 ⁽¹⁾	4x4 5x5 6x6	12.5 16 21.5	M4x10 M5x12.5 M6x16		80	100	6.5	3.5	82	8
			95	115	9	3.5	100	5							
	100	06	191.5 238.5	4.7 6.6	19x40 24x50	6x6 8x7	21.5 27	M6x16 M8x19	157.5 Layout 2I	80	100	7	3.5	100	8
			95	115	9	3.5	100	5							
	115	10	220 265	7.7 9.7	19x40 24x50 28x60	6x6 8x7 8x7	21.5 27 31	M6x16 M8x19 M10x22	157.5 Layout 2I	95	115	9	3.5	115	9
										95	130	9	3.5	115	8
										110	130	9	3.5	130	7
	142	15	243 293	13 16	19x40 24x50 28x60	6x6 8x7 8x7	21.5 27 31	M6x16 M8x19 M10x22	185 Layout 2I	130	165	11	3.5	142	5
	170	35	306 409	30 50	38x80	10x8	41	M12x32	212.3 Layout 2I	180	215	14	4	205	5
180										215	14	4	205	5	

LM: Motor's length without brake and with resolver
LB: Motor's length with brake and resolver
DxL: Shaft diameter x shaft length
bxh: Key dimension
t1: Overall shaft height
VxZ: Shaft hole depth
C: Centering

H: Height
DF: Fixing holes
Ø: Interaxis hole
QF: Mounting flange
PC: Centre Depth

¹⁾ not available with flange 7
²⁾ only for torque <2 Nm

Options

Parker SMH / SMB family motors are available with standard and custom options to adapt motor on your application. If the option for your application is not listed, please consult our technical department.

Holding Brake

All SMH / SMB motors are available with option holding brake.

The fail-safe (supply voltage 24 VDC $\pm 10\%$) holding brake is incorporated in the motor at the opposite side of the front flange (SM_170 front side) and is applied when there is no voltage present. Because of the power loss caused by the brake, torque values must be reduced by 5%. The holding brakes shall be used with the motor at a standstill and not for dynamic braking. For maintenance, please refer to technical manual

Motor	Voltage [V]	Current [A]	Torque @20 °C [Nm]	Added Length with resolver [mm]	Added Weight [kg]	Added Inertia [kgmm ²]
SMH / SMB40	24	0.25	0.4	32	0.15	-
SMH / SMB60		0.34	2.2	31.5	0.3	12.5
SMH / SMB82		0.5	4.5	43	0.7	43
SMH / SMB100		0.67	9	47	0.6	104
SMH / SMB115		0.67	9	45	2	100
SMH / SMB142		0.75	22	50	3	200
SMH / SMB170		1.67	72	-	2.9	1600

Medium Inertia

Where the application needs different values of inertia, SMH / SMB can provide a standard adder.

Motor	Added inertia [kgmm ²]	Added length with resolver [mm]	Added weight [kg]
SMH / SMB60	29	31.5	0.32
SMH / SMB82	270	43	0.91
SMH / SMB100	284	47	0.68
SMH / SMB115	900	45	2.28
SMH / SMB142	690	50	2.49
SMH / SMB170	consult Parker	consult Parker	consult Parker

Feedback

Motors may be equipped with various feedback types in order to meet the different requirements for precision, signal that the application needs. The standard motor includes the resolver feedback. Hiperface Encoder, DSL Encoder, EnDat Encoder, Incremental Encoder are available like the following tables.

Resolver

Poles	2
Transformation ratio	0.5
Operating temperature	-50...+150 °C
SM_ associations	All Sizes

Incremental Encoder with Hall Sensor

Code	A1	A2	A3	B3	C4	D3
Resolution [C/T]	2000	2048	4096	2048	5000	5000
Poles	8					
System accuracy	$\pm 32''$	$\pm 32''$	$\pm 16''$	$\pm 32''$	$\pm 13''$	$\pm 13''$
Voltage	+5 VDC $\pm 5\%$ - 200 mA					
Reference mark	Yes					
Max speed [min ⁻¹]	6000					
Output circuit	Line drive differential mode 20 mA					
Operating temperature	-20 °C...+100 °C	-20 °C...+85 °C	-20 °C...+100 °C	-20 °C...+100 °C	-20 °C...+85 °C	-20 °C...+85 °C
SM_ motors associations						
SM_40	N	N	N	N	N	N
SM_60	N	N	N	Y (+17 mm length)	N	Y (+17 mm length)
SM_82	Y	Y	Y	N	Y	N
SM_100	Y	Y	Y	N	Y	N
SM_115	Y	Y	Y	N	Y	N
SM_142	Y	Y	Y	N	Y	N
SM_170	Y	Y	Y	N	Y	N

Hiperface Absolute Encoder

Code	S1	S2	S3	S4	S5	S6
Type	Optical					
Turn	Single	Multi	Single	Multi	Single	Multi
Incremental signals	1 V _{PP}				-	-
Line count	1024		128		-	-
Resolution	32 768 (15 bit)		4096 (12 bit)		262 144 (18 bits)	
Absolute rotation	1	4096	1	4096	1	4096
System accuracy	±45"		±320"		±40"	
Power supply	8 VDC				7...12 VDC	
Max speed [min ⁻¹]	6000		12000	9000		
Temperature	-20 °C...+115 °C		-20 °C...+110 °C		20 °C...+105 °C	
Safety integrity level	SIL2 (IEC 61508), SILCL2 (IEC 62061)				SIL2 (IEC 61508), SILCL2 (IEC 62061)	
SM_motors associations						
SM_40	N	N	N	N	N	N
SM_60	N		Y (+17 mm length without brake) (+30 mm length with brake)		Y (+17 mm length without brake) (+30 mm length with brake)	
SM_82	Y (+17 mm length without brake) (+30 mm length with brake)		Y	Y	Y	Y
SM_100	Y (+20 mm length)				Y (+20 mm length)	
SM_115	Y	Y	Y	Y	Y	Y
SM_142	Y	Y	Y	Y	Y	Y
SM_170	Y	Y	Y	Y	Y	Y

Code	A6	A7	C6	C7
Type	Optical			
Turn	Single	Multi	Single	Multi
Incremental signals	1 V _{PP}			
Line count	1024		128	
Resolution	32 768 (15 bit)		4096 (12 bit)	
Absolute rotation	1	4096	1	4096
System accuracy	±45"		±320"	
Power supply	8 VDC			
Max speed [min ⁻¹]	6000		12000	9000
Temperature	-20 °C...+115 °C		-20 °C...+110 °C	
Safety integrity level	Not Available		Not Available	
SM_motors associations				
SM_40	N	N	N	N
SM_60	N		Y (+17 mm length without brake) (+30 mm length with brake)	
SM_82	Y (+17 mm length without brake) (+30 mm length with brake)		Y	Y
SM_100	Y (+20 mm length)			
SM_115	Y	Y	Y	Y
SM_142	Y	Y	Y	Y
SM_170	Y	Y	Y	Y

Brushless servo motors SMH / SMB
Accessories and Options

EnDat Absolute Encoder

Code	B9	D5	F2	F4
Type	Inductive	Optical		Inductive
Turn	Multi			
Incremental signals	1 V _{PP}			
Line count	32	512		16
Positions per revolutions	131 072 (17 bit)	8192 (13 bit)		262 144 (18 bit)
Distinguishable revolutions	4096	4096		
System accuracy	±400"	±60"		±480"
Power supply	5 VDC			
Max speed [min ⁻¹]	12 000	7 000	12 000	
Temperature	-20 °C...+115 °C	-30 °C...+115 °C	-40 °C...+115 °C	-20 °C...+115 °C
Absolute position values	EnDat 2.1	EnDat 2.2		EnDat 2.1
Safety integrity level	Not Available			
SM_ motors associations				
SM_40	N	N	N	N
SM_60	N	N	Y (+17 mm length without brake) (+9 mm length with brake)	
SM_82	Y (+22.5 mm length without brake) (+18 mm length with brake)		N	N
SM_100	Y (+20 mm length)		N	N
SM_115	Y	Y	N	N
SM_142	Y	Y	N	N
SM_170	Y	Y	N	N

Servofan kit

Designed for the SMH/SMB servo motors family, the new Servofan kit allows extra performances over and above the specified motor torque rating.

Brushless servo motors are meant for high dynamic applications and where the functionality is un-constant (S3 Cycle). In this conditions the new Servofan kit increases by 25% the motor torque and it also permits the use in continuous duty (S1) improving the performances.

Suitable for 100-115, 142 and 170mm frames sizes within the SMB/SMH ranges, the kit is available with an IP20 rating and is ideal for deployment in applications within food/ packaging, hydraulic servo pump application, material forming, factory automation and material handling sectors. For customers who already have motors in the specified frame sizes and would like more torque the new Servofan kit can be purchased separately and added.

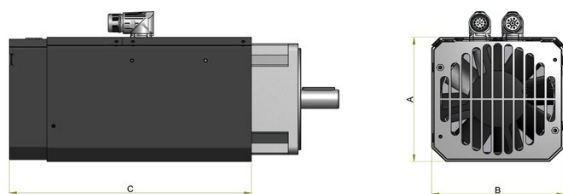

Dimensions

Model	A	B	C
SF-1000-00	131,7	128	271
SF-1420-00	162	159	296
SF-1701-00	184	186	365
SF-1702-00			465

Order code

	1	2	3	4
Order example	SF	-	100	00 - 00

1 Servofan kit	SF	Servofan kit		
2 SMH-SMB motor size	100	For SMH-SMB size 100 or 115		
	142	For SMH-SMB size 142		
	170	For SMH-SMB size 170		
3 Motor lenght	0	Standard for all size except size 170		
	1	Only for 170 size - Lenght 1 - 35Nm		
	2	Only for 170 size - Lenght 2 - 60Nm		
4 Special execution	00	Standard version		
	01	Special version without connectors		

Layout and Connectors

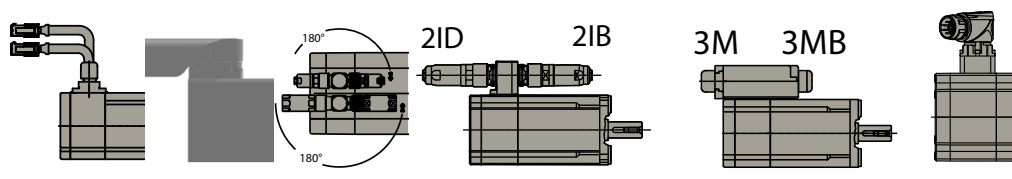

	200 mm Flying leads with molex plugs 0V	Y-Tech rotatable connector 2Y	2x Parallel upright connectors 2I	2x Forward facing connectors 2IB	2x Rear facing connectors 2ID	Terminal box rear facing 3M	Terminal box forward facing 3MB	Hiperface DSL® Connector (IZ)
SMH_40	N	Y	N	N	N	N	N	N
SMH_60	Y	Y	Y	Y	N	N	N	Y
SMH_82	N	N	Y	Y	N	N	N	Y
SMH_100	N	N	Y	Y	N	N	N	Y
SMH_115	N	N	Y	Y	N	N	N	Y
SMH_142	N	N	Y	Y	N	N	N	Y
SMH_170	N	N	Y	N	N	N	N	Y
SMB_40	N	Y	N	N	N	N	N	N
SMB_60	Y	Y	Y	Y	Y	Y	Y	N
SMB_82	N	N	Y	Y	Y	Y	Y	N
SMB_100	N	N	Y	Y	Y	Y	Y	N
SMB_115	N	N	Y	Y	Y	Y	Y	N
SMB_142	N	N	Y	Y	Y	Y	Y	N
SMB_170	N	N	Y	N	N	N	N	N
SME_60	N	Y	N	Y	Y	N	N	Y
SME_82	N	N	N	Y	Y	N	N	Y
SME_100	N	N	N	Y	Y	N	N	Y
SME_115	N	N	Y	N	N	N	N	Y
SME_142	N	N	Y	N	N	N	N	Y
SME_170	N	N	Y	N	N	N	N	Y

Power connector (0V)

6	5	4
3	2	1

Pin	Description
1	GND - shield
2	Brake 0 VDC
3	Brake +24 VDC
4	W
5	V
6	U

Part number

CONMOT6M Female Connector

Resolver connector (0V)

12	11	10	9	8	7
6	5	4	3	2	1

Pin	Description
1	n.c.
2	n.c.
3	n.c.
4	PTC
5	PTC
6	GND - shield
7	SIN +
8	SIN -
9	COS +
10	COS -
11	EXTC -
12	EXTC +

Part number

CONRES12M Female Connector

Hiperface connector (0V)

12	11	10	9	8	7
6	5	4	3	2	1

Pin	Description
1	SIN +
2	SIN -
3	RS485 +
4	0 V
5	PTC
6	PTC
7	VDC +
8	COS +
9	COS -
10	RS485 -
11	GND - shield
12	n.c.

Part number

CONRES12M Female Connector

Brushless servo motors SMH / SMB
Layout and Connectors

Power connector (2I, 2IB, 2ID)

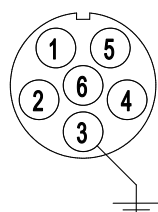

Pin	Description
1	U
2	V
3	GND - shield
4	Brake +24 VDC
5	Brake 0 VDC
6	W

Part number
CONMOT82F Female Connector

Incremental encoder connector (2I, 2IB, 2ID)

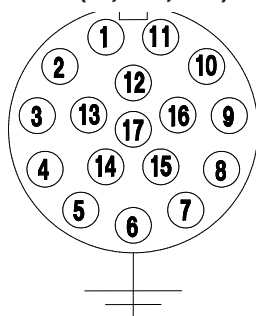

Pin	Description	
1	5 V	
2	0 V	
3	A +	
4	A -	
5	B +	
6	B -	
7	Z +	
8	PTC	KTY -
6	PTC	KTY +
10	Z -	
11	Hall A +	
12	Hall A -	
13	Hall B +	
14	Hall B -	
15	Hall C +	
16	Hall C -	
17	n.c.	

Part number
CONENCF Female Connector

Resolver connector (2I, 2IB, 2ID)

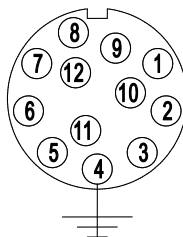

Pin	Description	
1	SIN -	
2	SIN +	
3	n.c.	
4	GND - shield	
5	n.c.	
6	n.c.	
7	EXCT -	
8	PTC	KTY -
9	PTC	KTY +
10	EXCT +	
11	COS +	
12	COS -	

Part number
CONRES82F Female Connector

Absolute encoder SINCOS - EnDat (2I, 2IB, 2ID)

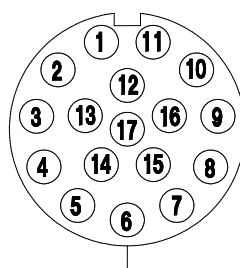

Pin	Description	
1	UP Sensor	
2	n.c.	
3	n.c.	
4	0 V Sensor	
5	PTC	KTY -
6	PTC	KTY +
7	UP	
8	CK +	
9	CK -	
10	0 V	
11	GND - shield	
12	B +	
13	B -	
14	Data +	
15	A +	
16	A -	
17	Data -	

Part number
CONENCF Female Connector

Absolute encoder SINCOS - Hiperface (2I, 2IB, 2ID)

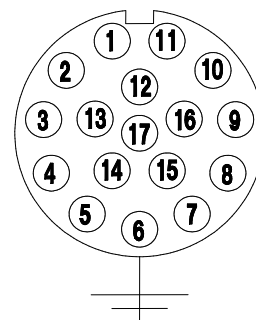

Pin	Description	
1	SIN +	
2	SIN -	
3	RS485 +	
4	n.c.	
5	n.c.	
6	n.c.	
7	GND - shield	
8	PTC	KTY -
9	PTC	KTY +
10	+VDC	
11	COS +	
12	COS -	
13	RS485 -	
14	n.c.	
15	n.c.	
16	n.c.	
17	n.c.	

Part number
CONRES82F Female Connector

Hiperface DSL® Connector (IZ)

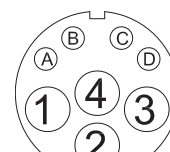

Pin	Description
1	U
2	GND
3	V
4	W
A	Brake +
B	Brake -
C	Signal +
D	Signal -

Part number
CONMOT2IZF Female Connector

Associated Drives

Motor	Rated Speed [min ⁻¹]	Stall Current [A]	PSD1S	PSD1M
230 VAC supply voltage				
SM_40 60 0,19	6000	0.78	PSD1S_1200	PSD1M_1222
SM_40 60 0,38	6000	1.2	PSD1S_1200	PSD1M_1222
SM_60 30 0,55	3000	0.7	PSD1S_1200	PSD1M_1222
SM_60 45 0,55	4500	1	PSD1S_1200	PSD1M_1222
SM_60 60 0,55	6000	1.4	PSD1S_1200	PSD1M_1222
SM_60 16 1,4	1600	0.95	PSD1S_1200	PSD1M_1222
SM_60 30 1,4	3000	1.73	PSD1S_1200	PSD1M_1222
SM_60 45 1,4	4500	2.37	PSD1S_1300	PSD1M_1433
SM_60 60 1,4	6000	2.98	PSD1S_1300	PSD1M_1433
SM_60 75 1,4	7500	3.85	PSD1S_1300	PSD1M_1433
SM_82 10 03	1000	1.2	PSD1S_1200	PSD1M_1222
SM_82 16 03	1600	1.8	PSD1S_1200	PSD1M_1222
SM_82 30 03	3000	3.1	PSD1S_1300	PSD1M_1433
SM_82 33 03	3300	3.5	PSD1S_1300	PSD1M_1433
SM_82 45 03	4500	4.7	PSD1S_1300	PSD1M_1433
SM_82 60 03	6000	6.1	n.a.	PSD1M_1433
SM_82 75 03	7500	7.5	n.a.	PSD1M_1433
SM_100 16 06	1600	3.7	PSD1S_1300	PSD1M_1433
SM_100 30 06	3000	5.9	n.a.	PSD1M_1433
SM_100 45 06	4500	9.4	n.a.	PSD1M_1630
SM_100 55 06	5500	11.8	n.a.	PSD1M_1630
SM_100 75 06	7500	14.7	n.a.	PSD1M_1630
SM_115 16 10	1600	6	n.a.	PSD1M_1433
SM_115 30 10	3000	10.5	n.a.	PSD1M_1630
SM_115 40 10	4000	14.7	n.a.	PSD1M_1630
SM_115 54 10	5400	18.2	n.a.	PSD1M_1800
SM_142 18 15	1800	9.7	n.a.	PSD1M_1630
SM_142 30 15	3000	16	n.a.	PSD1M_1800
SM_170 11 35	1100	13.3	n.a.	PSD1M_1630
SM_170 16 35	1600	20	n.a.	PSD1M_1800
SM_170 25 35	2500	29	n.a.	PSD1M_1800
400 VAC supply voltage				
SM_60 30 1,4	3000	0.95	n.a.	PSD1M_1222
SM_60 45 1,4	4500	1.37	n.a.	PSD1M_1222
SM_60 60 1,4	6000	1.73	n.a.	PSD1M_1222
SM_60 75 1,4	7500	2.15	n.a.	PSD1M_1433
SM_82 30 03	3000	1.8	n.a.	PSD1M_1222
SM_82 45 03	4500	2.7	n.a.	PSD1M_1433
SM_82 56 03	5600	3.1	n.a.	PSD1M_1433
SM_82 60 03	6000	3.5	n.a.	PSD1M_1433
SM_82 75 03	7500	4.4	n.a.	PSD1M_1433
SM_100 30 06	3000	3.7	n.a.	PSD1M_1433
SM_100 45 06	4500	5.6	n.a.	PSD1M_1433
SM_100 56 06	5600	5.9	n.a.	PSD1M_1433
SM_100 75 06	7500	9.4	n.a.	PSD1M_1630
SM_115 20 10	2000	4.5	n.a.	PSD1M_1433
SM_115 30 10	3000	6.0	n.a.	PSD1M_1433
SM_115 40 10	4000	8.0	n.a.	PSD1M_1433
SM_115 56 10	5600	10.5	n.a.	PSD1M_1630
SM_142 20 15	2000	6.4	n.a.	PSD1M_1433
SM_142 30 15	3000	9.7	n.a.	PSD1M_1630
SM_142 45 15	4500	14.4	n.a.	PSD1M_1630
SM_142 56 15	5600	16	n.a.	PSD1M_1800
SM_170 10 35	1000	6.8	n.a.	PSD1M_1630
SM_170 20 35	2000	13.3	n.a.	PSD1M_1630
SM_170 27 35	2700	18	n.a.	PSD1M_1800
SM_170 30 35	3000	20	n.a.	PSD1M_1800
SM_170 10 60	1000	11.7	n.a.	PSD1M_1630
SM_170 20 60	2000	22.6	n.a.	PSD1M_1800
SM_170 30 60	3000	35.7	n.a.	n.a.

Brushless servo motors SMH / SMB
Order Code SMH / SMB

Order Code

Serie SMH / SMB / SME

	1	2	3	4	5	6	7	8	9	10	11	12	13	14
Order example	SMH	A	60	30	1,4	5	9		2I		64	A6	M	2

1 Type Of Motor (mandatory field)	SMH Motor with Resolver for PSD/C3	SMB Motor with Resolver for TPDM/SLVDN	SME Motor with Encoder for TPDM/SLVDN
2 Brake Option	empty field No Brake Option	A Motor with Holding Brake	
3 Motor Frame Size (mandatory field)	40 Torque range 0.19 Nm or 0.35 Nm	60 Torque range 0.55 or 1.4 Nm	82 Torque range 3 Nm
	100 Torque range 6 Nm	115 Torque range 10 Nm	142 Torque range 15 or 17 Nm
	170 Torque range 35 or 60 Nm		
4 Winding (mandatory field)	nn min ⁻¹ (x100) see "Technical Data" (page 6)		
5 Motor Torque (mandatory field)	nn Torque [Nm] see "Technical Data" (page 6)		
6 Flange (mandatory field)	5 All sizes	7 Only for Size 82 and 115	8 Only for Size 60, 82, 100 and 115
	9 Only for Size 115		
7 Shaft (mandatory field)	8 8x20 mm for size 40	9 9x20 mm for size 60	11 11x23 mm for size 60
	14 14x30 mm for size 82	19 19x40 mm for size 82/100/115/142	24 24x50 mm for size 100/115/142
	28 28x60 mm for size 115/142	38 38x80 mm for size 170	
8 Key Shaft option	Empty field Shaft with Key	S Shaft without key	
9 Layout - Connectors (mandatory field)	0V Cable exit and Molex Flying connectors - 200 mm above	2I Rotatable Interconnectron receptacles	2IB 90° Interconnectron receptacles - forward facing
	2ID 90° Interconnectron receptacles - rear facing	3M Terminal box rear facing	3MB Terminal box forward facing
	2Y Y-Tech connectors	IZ DSL® connectore (not for size 40)	
10 Female connectors option (only for SMB/SME)	Empty field With Female / flying connectors	W Without Female / flying connectors	
11 Protection Degree (mandatory field)	64 IP64	65 IP65 (standard for SMB170)	
12 Feedback	Empty field Standard Resolver	A1 Encoder 2000 ppr + Hall - TAMAGAWA OIH48	A2 Encoder 2048 ppr + Hall - TAMAGAWA OIH48
	A3 Encoder 4096 ppr + Hall - TAMAGAWA OIH48	A6 SinCos Hiperface Encoder Single-Turn - STEGMANN SRS50/52	A7 SinCos Hiperface Encoder Multi-Turn - STEGMANN SRS50/52
	B3 Encoder 2048 ppr + Hall - TAMAGAWA OIH35	B9 SinCos EnDat Encoder Multi-Turn - HEIDENHAIN EQI1331	C4 Encoder 5000 ppr + Hall - TAMAGAWA OIH48
	C6 SinCos Hiperface Encoder Single-Turn - STEGMANN SKS36	C7 SinCos Hiperface Encoder Multi-Turn - STEGMANN SKM36	D3 Encoder 5000ppr + Hall - TAMAGAWA OIH35
	D5 SinCos EnDat Encoder Multi-Turn - HEIDENHAIN EQN1325	F2 SinCos EnDat Encoder Multi-Turn - HEIDENHAIN EQN1125	F4 SinCos EnDat Encoder Multi-Turn - HEIDENHAIN EQI1130
	S1 SinCos Hiperface Encoder Single-Turn - STEGMANN SRS50S, SIL2	S2 SinCos Hiperface Encoder Multi-Turn - STEGMANN SRS50S, SIL2	S3 SinCos Hiperface Encoder Single-Turn - STEGMANN SKS36S, SIL2
	S4 SinCos Hiperface Encoder Multi-Turn - STEGMANN SKM36S, SIL2	S5 Hiperface DSL® Encoder Feedback SIL2 32768 steps/rev Single Turn	S6 Hiperface DSL® Encoder Feedback SIL2 32768 steps/rev x 4096 Multi Turn

13 Option Inertia

Empty field Standard Inertia

M Medium Inertia

14 Voltage

0 80 V

2 220-230 V (Standard)

4 380-400 V (Standard)

Brushless servo motors SMH / SMB
Order Code for Cables for SMH / SMB Motors

Order Code

Motor Power Cable for SMH / SMB Motors

	1	2	3	4		5		6		7		8
Order example	CBM	005	H	D	-	M15	-	PSX	-	0010	-	00

1	Power Cable Drive	
	CBM	Power cable drive
2	Section [mm²]	
	005	0.5 mm ²
	007	0.7 mm ²
	010	1 mm ²
	015	1.5 mm ²
	025	2.5 mm ²
3	Cable	
	S	Standard
	H	High Flex
4	Brake	
	0	Power cable standard - without brake
	B	Power cable standard - with brake
	D	DSL® Power cable with brake
5	Motor Connector	
	M15	M15 Interconnectron connector
	M23	M23 Interconnectron connector
	M40	M40 Interconnectron connector
6	Drive	
	PSX	Parker PSD1-S
	PMX	Parker PSD1-M
	SDX	Parker Servonet DC
7	Length	
	0000	Cable length 4 digits (example 50 m = 0500)*
8	Special Execution	
	00	Standard

* Available length in meter: 1; 2.5; 5; 7.5; 10; 15; 20; 25; 30; 35; 40; 45; 50

Motor Feedback Cable for SMH / SMB Motors

	1	2	3	4		5		6		7		8
Order example	CBF	RE0	H	0	-	M15	-	PSX	-	0010	-	00

1	Power Cable Drive	
	CBF	Feedback cable drive
2	Feedback	
	RE0	Resolver
3	Cable	
	H	High Flex
4	Brake	
	0	Power cable standard - without brake
5	Motor Connector	
	M15	M15 Interconnectron connector
	M23	M23 Interconnectron connector
	M40	M40 Interconnectron connector
6	Drive	
	PSX	Parker PSD1-S
	PMX	Parker PSD1-M
	SDX	Parker Servonet DC
7	Length	
	0000	Cable length 4 digits (example 50 m = 0500)*
8	Special Execution	
	00	Standard

* Available length in meter: 1; 2.5; 5; 7.5; 10; 15; 20; 25; 30; 35; 40; 45; 50



Parker's Motion & Control Technologies

At Parker, we're guided by a relentless drive to help our customers become more productive and achieve higher levels of profitability by engineering the best systems for their requirements. It means looking at customer applications from many angles to find new ways to create value. Whatever the motion and control technology need, Parker has the experience, breadth of product and global reach to consistently deliver. No company knows more about motion and control technology than Parker. For further info call 00800 27 27 5374



Aerospace

Key Markets

Aftermarket services
Commercial transports
Engines
General & business aviation
Helicopters
Launch vehicles
Military aircraft
Missiles
Power generation
Regional transports
Unmanned aerial vehicles

Key Products

Control systems & actuation products
Engine systems & components
Fluid conveyance systems & components
Fluid metering, delivery & atomization devices
Fuel systems & components
Fuel tank inerting systems
Hydraulic systems & components
Thermal management
Wheels & brakes



Climate Control

Key Markets

Agriculture
Air conditioning
Construction Machinery
Food & beverage
Industrial machinery
Life sciences
Oil & gas
Precision cooling
Process
Refrigeration
Transportation

Key Products

Accumulators
Advanced actuators
CO₂ controls
Electronic controllers
Filter driers
Hand shut-off valves
Heat exchangers
Hose & fittings
Pressure regulating valves
Refrigerant distributors
Safety relief valves
Smart pumps
Solenoid valves
Thermostatic expansion valves



Electromechanical

Key Markets

Aerospace
Factory automation
Life science & medical
Machine tools
Packaging machinery
Paper machinery
Oil & gas
Primary metals
Semiconductor & electronics
Textile
Wire & cable

Key Products

AC/DC drives & systems
Electric actuators, gantry robots & slides
Electrohydraulic actuation systems
Electromechanical actuation systems
Human machine interface
Linear motors
Stepper motors, servo motors, drives & controls
Structural extrusions



Filtration

Key Markets

Aerospace
Food & beverage
Industrial plant & equipment
Life sciences
Marine
Mobile equipment
Oil & gas
Power generation & renewable energy
Process
Transportation
Water Purification

Key Products

Analytical gas generators
Compressed air filters & dryers
Engine air, coolant, fuel & oil filtration systems
Fluid condition monitoring systems
Hydraulic & lubrication filters
Hydrogen, nitrogen & zero air generators
Instrumentation filters
Membrane & fiber filters
Microfiltration
Sterile air filtration
Water desalination & purification filters & systems



Fluid & Gas Handling

Key Markets

Aerial lift
Agriculture
Bulk chemical handling
Construction machinery
Food & beverage
Fuel & gas delivery
Industrial machinery
Life sciences
Marine
Mining
Mobile
Oil & gas
Renewable energy
Transportation

Key Products

Check valves
Connectors for low pressure fluid conveyance
Deep sea umbilicals
Diagnostic equipment
Hose couplings
Industrial hose
Mooring systems & power cables
PTFE hose & tubing
Quick couplings
Rubber & thermoplastic hose
Tube fittings & adapters
Tubing & plastic fittings



Hydraulics

Key Markets

Aerial lift
Agriculture
Alternative energy
Construction machinery
Forestry
Industrial machinery
Machine tools
Marine
Material handling
Mining
Oil & gas
Power generation
Refuse vehicles
Renewable energy
Truck hydraulics
Turf equipment

Key Products

Accumulators
Cartridge valves
Electrohydraulic actuators
Human machine interfaces
Hybrid drives
Hydraulic cylinders
Hydraulic motors & pumps
Hydraulic systems
Hydraulic valves & controls
Hydrostatic steering
Integrated hydraulic circuits
Power take-offs
Power units
Rotary actuators
Sensors



Pneumatics

Key Markets

Aerospace
Conveyor & material handling
Factory automation
Life science & medical
Machine tools
Packaging machinery
Transportation & automotive

Key Products

Air preparation
Brass fittings & valves
Manifolds
Pneumatic accessories
Pneumatic actuators & grippers
Pneumatic valves & controls
Quick disconnects
Rotary actuators
Rubber & thermoplastic hose & couplings
Structural extrusions
Thermoplastic tubing & fittings
Vacuum generators, cups & sensors



Process Control

Key Markets

Alternative fuels
Biopharmaceuticals
Chemical & refining
Food & beverage
Marine & shipbuilding
Medical & dental
Microelectronics
Nuclear Power
Offshore oil exploration
Oil & gas
Pharmaceuticals
Power generation
Pulp & paper
Steel
Water/wastewater

Key Products

Analytical instruments
Analytical sample conditioning products & systems
Chemical injection fittings & valves
Fluoropolymer chemical delivery fittings, valves & pumps
High purity gas delivery fittings, valves, regulators & digital flow controllers
Industrial mass flow meters/controllers
Permanent no-weld tube fittings
Precision industrial regulators & flow controllers
Process control double block & bleeds
Process control fittings, valves, regulators & manifold valves



Sealing & Shielding

Key Markets

Aerospace
Chemical processing
Consumer
Fluid power
General industrial
Information technology
Life sciences
Microelectronics
Military
Oil & gas
Power generation
Renewable energy
Telecommunications
Transportation

Key Products

Dynamic seals
Elastomeric o-rings
Electro-medical instrument design & assembly
EMI shielding
Extruded & precision-cut, fabricated elastomeric seals
High temperature metal seals
Homogeneous & inserted elastomeric shapes
Medical device fabrication & assembly
Metal & plastic retained composite seals
Shielded optical windows
Silicone tubing & extrusions
Thermal management
Vibration dampening

Parker Hannifin Corporation
Motion Systems Group Europe
Parker Hannifin EMEA Sàrl European Headquarters
La Tuilière 6 Etoy
Switzerland CH-1163
www.parker.com

192-061013 06/2024

Your Local Authorized Parker Distributor

© 2024 Parker Hannifin Corporation

