

# Parker Moduflex Valve System

Catalogue PDE2536TCUK



ENGINEERING YOUR SUCCESS.

PDE2536TCUK

## Moduflex Valve System - P2M

---



### WARNING

**FAILURE OR IMPROPER SELECTION OR IMPROPER USE OF THE PRODUCTS AND/OR SYSTEMS DESCRIBED HEREIN OR RELATED ITEMS CAN CAUSE DEATH, PERSONAL INJURY AND PROPERTY DAMAGE.**

This document and other information from Parker Hannifin Corporation, its subsidiaries and authorized distributors provide product and/or system options for further investigation by users having technical expertise. It is important that you analyse all aspects of your application and review the information concerning the product or system in the current product catalogue. Due to the variety of operating conditions and applications for these products or systems, the user, through its own analysis and testing, is solely responsible for making the final selection of the products and systems and assuring that all performance, safety and warning requirements of the application are met. The products described herein, including without limitation, products features, specifications, designs, availability and pricing, are subject to change by Parker Hannifin Corporation and its subsidiaries at any time without notice.

### SALE CONDITIONS

The items described in this document are available for sale by Parker Hannifin Corporation, its subsidiaries or its authorized distributors. Any sale contract entered into by Parker will be governed by the provisions stated in Parker's standard terms and conditions of sale (copy available upon request).



<b>Summary</b>	<b>Page</b>
Product Overview .....	4 - 7
Cylinder working speed charts .....	8 - 9
Technical characteristics .....	10 - 13
Ordering Guide .....	14 - 33
Ordering options .....	14 - 15
Basic modules order code .....	16 - 29
V Series - Collective Wiring .....	16- 17
V Series - P2M IO-Link Node .....	18 - 19
V Series - P2M Industrial Ethernet 24DO Node .....	20 - 21
V Series - P2M Lite Industrial Ethernet 24DO .....	22 - 23
T Series, Lockable connector IP67 and Clip connector IP40 .....	24 - 25
S Series, Lockable connector IP67 and Clip connector IP40 .....	26 - 27
P Series .....	28 - 29
Complete modules order code .....	30 - 33
T Series, Lockable connector IP67 and Clip connector IP40 & V Series .....	31
S Series, Lockable connector IP67 and Clip connector IP40 .....	32
P Series .....	33
Valve Island Head Module Port Sizing .....	34
Recommendations - Machines to U.S. Standard .....	35
Maintenance .....	36 - 37
Dimensions .....	38 - 44
V Series electrical and communication nodes - Connection and Configuration .....	45 - 48
Moduflex Valve Range Global Overview .....	51

## Moduflex Valve System

The Moduflex Valve System redefines flexibility for pneumatic users. Whether configured from basic components or ordered as a pre-assembled and tested valve island, Moduflex flexibility is unmatched in the market place.



### V Series



Multi wiring

### V Series



Industrial Ethernet & IO-Link

### T Series



Lockable Connector IP67

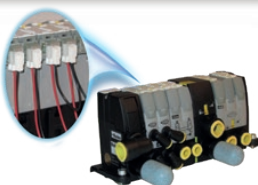

Clip Connector IP40

### S Series



Lockable Connector IP67



Clip Connector IP40

### P Series



### Innovative

The 6 patents awarded to the Moduflex Valve System reflect that innovation is core to the Parker design process. Maintaining a clear understanding of our customer's expectations has defined the individuality of the Moduflex, and clearly differentiated it as a leading automation solution.

### Adaptive

No other system can be adapted so simply once specified. Unique, captive fitting release system, quick release electrical connectors and single mechanical screw connection between manifolds offer the ultimate capability for late system design changes.

### Multi-Functional

From stand-alone valves to communicant ready valve islands, from cylinder flow controls to vacuum generators with integrated blow-off, the Moduflex Valve System meets the requirements of the whole automation spectrum.

### Light-weight

A communicant valve manifold with 8 pneumatic outputs weighs a mere 800grams, making the Moduflex Valve System the perfect choice for end of arm tooling application.

PDE2536TCUK

## Moduflex Valve System - P2M

### Moduflex Valve technology

Two technology platforms enable the compact design and high performance of the Moduflex Valve System. The compact dual 4/2 and 3/2 valves utilise well proven Parker seal technology. The standard 4/2 valves adopt the long life super durable ceramic switching technology.

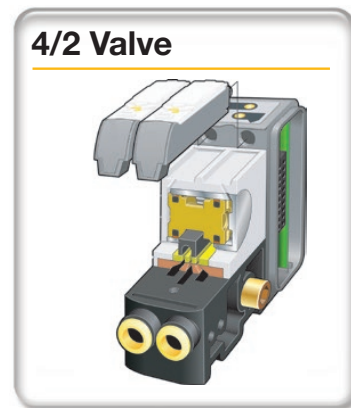
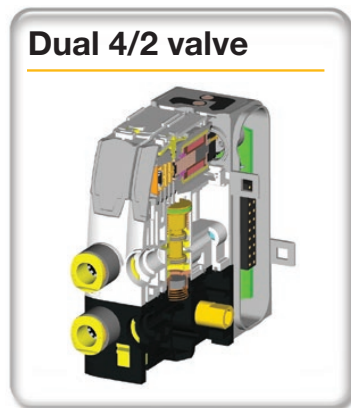

### Moduflex Complete Control

With the introduction of the dual 4/2 size 1 valves, Moduflex now offers unrivalled ability of matching valves to exact flow requirements, ensuring cost and space are minimised. In addition, Moduflex Valve System offers all the necessary control peripherals to provide a complete automation solution. Moduflex is the complete control package.

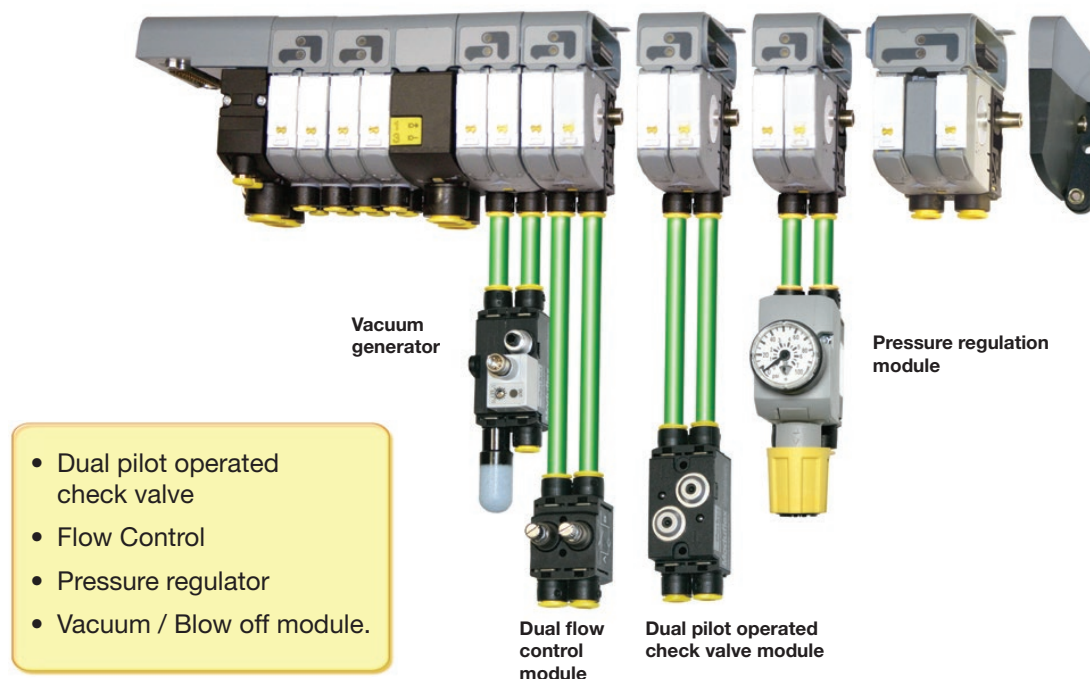

PDE2536TCUK

## Moduflex Valve System - P2M

With high performance technology, Moduflex opens a new era in the field of electro-pneumatic automation. Valves are easily assembled into compact islands that conform to any application requirement.

### Adaptive pneumatic

With the Moduflex Valve design, pneumatic automation is now totally flexible.

- Valves may be stand-alone or assembled into short or long islands, depending on application.
- IP 65-67 water and dust protection allows the valve to be installed near the cylinders for shorter response time and lower air consumption.
- The IP40 water and dust protection allows an optimised electrical connection for applications into cabinet or soft and none aggressive environments.
- Valve island electrical connections may be integrated.
- Push-in pneumatic connectors may be straight or elbow, for 4, 6, 8 or 10 mm OD tubes.
- A given island may incorporate different valve sizes in order to fulfill each cylinder flow requirement. A single island will accommodate all cylinders, up to 100 mm bore size.
- Island modifications are easy: add or remove a valve, change a valve function, change tubing size or change piloting in minutes.
- Manual overrides are also adaptive: locking for set up, non-locking for production.



stand-alone valve

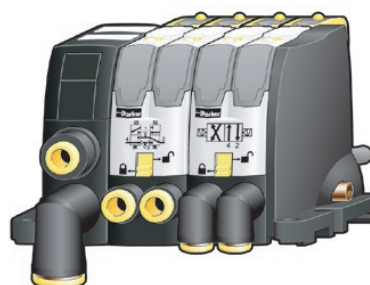

short valve island

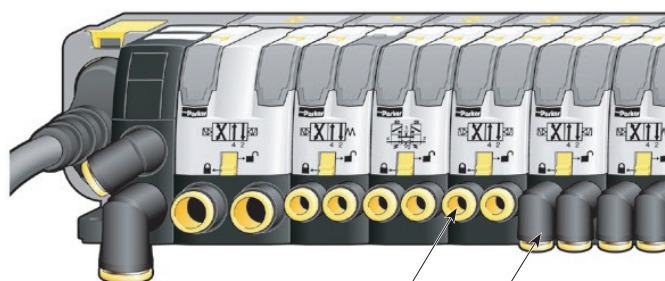

or long valve island

straight or elbow pneumatics connectors

### Easy man-machine dialog

- Moduflex incorporates LED indicators, manual overrides (MAN), in conjunction with valve symbols and identification.
- As compared to traditional 5/2 valve islands, Moduflex offers a more user friendly dialogue: each marking, LED and MAN are all lined up with the corresponding cylinder output.

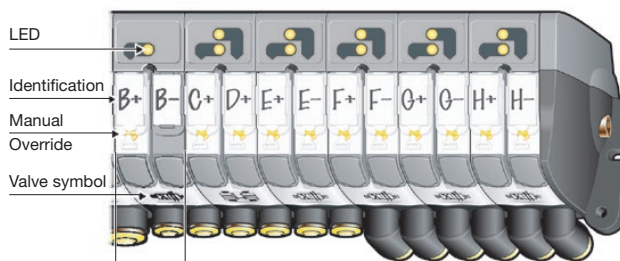

**Island with traditional 5/2 spool valves:**  
Before any action, LED and MAN have to be carefully related to the corresponding output.

Man-machine dialogue is difficult.

**Island with Moduflex 4/2 slides valves:**  
Each marking, LED and MAN line up with the corresponding output.

Man-machine dialogue is easy.

PDE2536TCUK

## Moduflex Valve System - P2M

### Adaptive design

individual electrical connector

Lockable M8 Connector - IP67 or Clip Connector - IP40

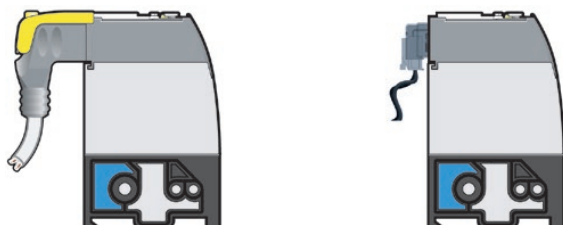

or Valve Bank with integrated IP65 electrical connections

3 valves sizes in the same valve bank

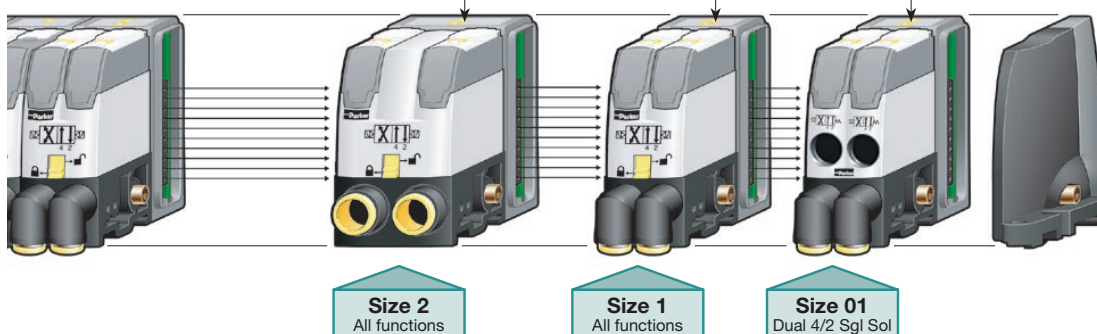

### Flows and tube connections

Optimal nominal section for a full flow with appropriate fitting

**3 valve sizes lead to a global choice of tube sizes, thus covering all usual applications**

Size 2		Size 1		Size 01	
Nominal section 40 mm <sup>2</sup>		Nominal section 12 mm <sup>2</sup>		Nominal section 4 mm <sup>2</sup>	
Qn 800 NI/mn*		Qn 310 NI/mn*		Qn 165 NI/mn*	
* For 3/2 functions Qn 450 NI/mn Qmax 805 NI/mn		* For 3/2 functions Qn 250 NI/mn Qmax 415 NI/mn			
Tube size to cylinder	Ø Ext. 10 mm	Ø Ext. 8 mm	Ø Ext. 6 mm	Ø Ext. 4 mm	
Cylinder bore size	Ø 63 to Ø 100 mm	Ø 40 to Ø 63 mm	Ø 25 to Ø 40 mm	Ø 6 to Ø 25 mm	

### Adaptive pneumatic connection

Valve outputs are equipped with clip-on push-in tube connectors with a choice of straight or elbow in different sizes

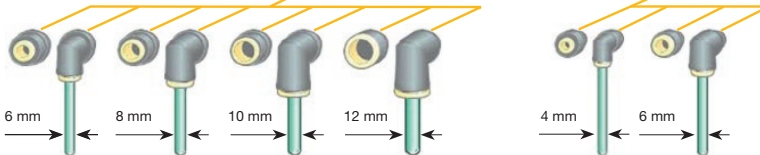

Typical cylinder speeds are shown on next pages. Module size, tube diameter and length, cylinder size, load and exhaust collection are taken into account.

**Cylinder working speed charts**

The charts below give the cylinder working speeds at 6 bar, under different conditions:

- non loaded or 50 % loaded double acting cylinder;
- exhaust piped through 2 m. long tubing, or exhaust muffled.

**cylinder working speeds, in cm/s**

standard conditions:

- 1 double acting cylinder
- 1 working pressure: P = 6 bar

specific conditions:

- exhaust piped through tube 2 m long, with next ID above ID tube from valve to cylinder.

- non loaded cylinder

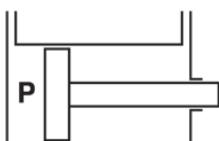

valve module	tube ID	tube OD	tube length	Cylinder bore size							
				25 mm	32 mm	40 mm	50 mm	63 mm	80 mm	100 mm	
<b>Size 1</b>	2 x 4 mm	4 mm	1 m.	43 cm/s	28 cm/s						
			3 m.	27	17						
	2.7 x 4 mm	4 mm	1 m.	85	52	33 cm/s					
			3 m.	55	34	21					
	4 x 6 mm	6 mm	1 m.	167	100	62	41 cm/s	27 cm/s			
			2 m.	157	86	54	37	23			
4 m.			125	73	46	31	19				
8 m.			94	57	36	24	14				
<b>Size 2</b>	5.5 x 8 mm	8 mm	1 m.			146	102	67	40 cm/s	25 cm/s	
			3 m.			122	84	54	32	20	
	6 x 8 mm	8 mm	1 m.				125	78	46	30	
			3 m.				105	65	39	25	
	7 x 10 mm	10 mm	1 m.				135	88	53	33	
			3 m.				120	77	47	30	
	8 x 10 mm	10 mm	1 m.					94	57	40	
			3 m.					85	53	37	

**cylinder working speeds, in cm/s**

standard conditions:

- 1 double acting cylinder
- 1 working pressure: P = 6 bar

specific conditions:

- exhaust piped through tube 2 m long, with next ID above ID tube from valve to cylinder.

- 50% loaded cylinder

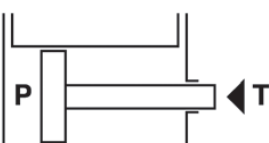

valve module	tube ID	tube OD	tube length	Cylinder bore size						
				25 mm	32 mm	40 mm	50 mm	63 mm	80 mm	100 mm
<b>Size 1</b>	2 x 4 mm	4 mm	1 m.	32 cm/s	20 cm/s					
			3 m.	21	13					
	2.7 x 4 mm	4 mm	1 m.	65	43	25 cm/s				
			3 m.	43	27	16				
	4 x 6 mm	6 mm	1 m.	100	85	53	36 cm/s	22 cm/s		
			2 m.	93	75	44	30	19		
4 m.			83	62	36	24	15			
8 m.			68	46	27	18	11			
<b>Size 2</b>	5.5 x 8 mm	8 mm	1 m.			83	67	44	27 cm/s	18 cm/s
			3 m.			79	54	35	21	15
	6 x 8 mm	8 mm	1 m.				77	51	32	21
			3 m.				69	43	26	17
	7 x 10 mm	10 mm	1 m.				88	59	37	24
			3 m.				81	51	30	21
	8 x 10 mm	10 mm	1 m.					63	39	27
			3 m.					58	35	25

PDE2536TCUK

## Moduflex Valve System - P2M

### Field of application :

- stand-alone valve modules **S** series
- valve island modules, **T** series and **V** series

Note : a complete machine cycle includes:

- the cylinder displacement times that can be deducted from the cylinder speeds given below
- the cylinders starting times that depend on the cylinder strokes and thus could not be included in the charts below.

#### cylinder working speeds, in cm/s

standard conditions:

- 1 double acting cylinder
- 1 working pressure:  
P = 6 bar

specific conditions:

- muffled exhaust (non collected)
- non loaded cylinder

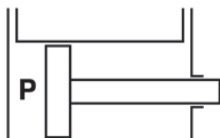

valve module	tube ID	tube OD	tube length	Cylinder bore size							
				25 mm	32 mm	40 mm	50 mm	63 mm	80 mm	100 mm	
<b>Size 1</b>	2 x 4 mm	4 mm	1 m.	43 cm/s	27 cm/s						
			3 m.	27	17						
	2.7 x 4 mm	4 mm	1 m.	88	54	34 cm/s					
			3 m.	55	34	22					
	4 x 6 mm	6 mm	1 m.	170	98	62	42 cm/s	26 cm/s			
			2 m.	150	85	55	37	23			
			4 m.	125	70	45	31	19			
			8 m.	95	56	35	24	15			
<b>Size 2</b>	5.5 x 8 mm	8 mm	1 m.			181	126	80	48 cm/s	30 cm/s	
			3 m.			134	91	58	35	22	
	6 x 8 mm	8 mm	1 m.				139	89	54	34	
			3 m.				112	70	43	27	
	7 x 10 mm	10 mm	1 m.				148	94	57	37	
			3 m.				125	81	49	31	
	8 x 10 mm	10 mm	1 m.						102	60	42
			3 m.						90	55	38

#### cylinder working speeds, in cm/s

standard conditions:

- 1 double acting cylinder
- 1 working pressure:  
P = 6 bar

specific conditions:

- muffled exhaust (non collected)
- 50% loaded cylinder

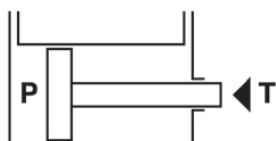

valve module	tube ID	tube OD	tube length	Cylinder bore size							
				25 mm	32 mm	40 mm	50 mm	63 mm	80 mm	100 mm	
<b>Size 1</b>	2 x 4 mm	4 mm	1 m.	35 cm/s	22 cm/s						
			3 m.	23	14						
	2.7 x 4 mm	4 mm	1 m.	67	44	27 cm/s					
			3 m.	44	28	17					
	4 x 6 mm	6 mm	1 m.	100	87	56	38 cm/s	23 cm/s			
			2 m.	93	77	46	31	19			
			4 m.	83	63	37	25	16			
			8 m.	69	46	28	18	12			
<b>Size 2</b>	5.5 x 8 mm	8 mm	1 m.			102	85	54	33 cm/s	22 cm/s	
			3 m.			87	61	40	24	16	
	6 x 8 mm	8 mm	1 m.				91	59	37	25	
			3 m.				77	46	29	19	
	7 x 10 mm	10 mm	1 m.				98	63	40	26	
			3 m.				87	54	33	22	
	8 x 10 mm	10 mm	1 m.						68	43	30
			3 m.						61	38	27

PDE2536TCUK

## Moduflex Valve System - P2M

**Two technology platforms**

**The well proven Parker seal technology**  
WCS Wear Compensating System  
For 3/2 and dual 4/2 functions

**Ceramic switching technology**  
For single 4/2 functions

**Configurable manual override**  
For locking, non-locking or condemned manual override

**24 V DC solenoid valve**

**Pneumatic symbol**

**Locking system for clip-on fittings**

**Straight or elbow clip-on push-in fittings**  
For size 1: 4 or 6 mm OD tubing  
For size 2: from 6 to 12 mm OD tubing

**Auxiliary channels**  
Independent pilot pressure and exhaust

**Internal connection**  
Up to 19 solenoids

**Associating tie-rod**  
For easy module assembly

**Pneumatic valve body**

**Visualisation LED's**  
For easy man-machine dialog

**Clip connector - IP40**  
Economic connection for traditional wiring

**M8 - 3 pins for lockable connector - IP67**  
For traditional wiring

**4 mm orientable push-in fitting**  
For pneumatic remote pilot

### Material Specification

Plastics:	Polyamide reinforced fibreglass
Screws:	Zinc plated steel
Seals:	Nitrile rubber
Valve mechanism:	Aluminium alloy
Plate:	Ceramic

### Certification

EMC / CE mark:	According to EN 61 000-6-2
Dust & water protection:	According to EN 60529 - NEMA 4
- S & T series:	M8 connector: IP67 Clip connector: IP40
- V series:	IP65*

\* For 25 Pins D-Sub connection: IP40 or IP65 depending on the cable

Moduflex specifications answer most industries automation requirements.

Applications run from clean room electronic manufacturing to process industries in aggressive environments.

### Pneumatic specifications

#### General Specification



<b>Fluid</b>	Air or Inert gas, Filtered 40µ (class 5 according to ISO 8573-1) Dry (class 4 according to ISO 8573-1) or Lubricated (with lubricated air, we recommend external pilot supply with non lubricated air)				
<b>Operating Pressure</b>	-0,9 to 8,0 bar				
<b>Piloting Pressure</b>	3/2 N.C. or N.O.	3,5 to 8,0 bar			
for operating pressures below, use external pilot by configuring the head module accordingly (function available on standard head module)	4/2 single solenoid	3,0 to 8,0 bar			
	4/2 double solenoid	3,0 to 8,0 bar			
<b>Pilot supply</b>	S Series	Internal			
	T & V Series	Mixed internal/external (configurable on the standard head module)			
<b>Exhaust collection</b>	All collectable (including pilot solenoid valve exhaust)				
<b>Life cycle (all sizes)</b>	3/2 N.C. or N.O.	60 million operations (with dry air, 2 Hz, 20°C, 6 bar)			
	Single and Dual 4/2	100 million operations (with dry air, 2 Hz, 20°C, 6 bar)			
<b>Operating temperatures</b>	Clip connector	-15°C to 60°C			
	Lockable connector				
	Multiwiring connector				
<b>Stocking temperatures</b>	Industrial	0°C to 55°C			
	Communication	-40°C to 70°C			
<b>Vibration resistance</b>	2G - From 2 to 150 Hz (According to IEC 68 - 2 - 6)				
<b>Impact resistance</b>	15G - 11 ms (According to IEC 68 - 2 - 27)				
<b>Flow specifications</b>		<b>Dual 4/2</b>	<b>Dual 3/2</b>	<b>Single 3/2</b>	<b>Single 4/2</b>
<b>Size 1</b>	Q max. (NI/mn)	275	415	415	510
	Qn (NI/mn)	165	235	235	310
<b>Size 2</b>	Q max. (NI/mn)	-	805	805	1340
	Qn (NI/mn)	-	450	440	800



PDE2536TCUK

## Moduflex Valve System - P2M

### Electrical specifications

Pilot solenoid Specifications			
<b>Electric Connector</b>		M8	Clip connector
<b>Rated Voltage</b>		24 Vdc	
<b>Electric Connection</b>		Not polarized	Polarized
<b>Allowable voltage fluctuation</b>		-15% to +10% (at 20°C)	+/- 10% (at 20°C)
<b>Coil insulation type</b>		Class B	Class F
<b>Power consumption</b>		Without lockable connector: 1W With lockable connector: 1,2W	1W
<b>Visualisation and surge protection</b>		Included into lockable connector	Included on pilot solenoid
<b>Manual override</b>		Configurable: Locking or non-locking, isolated if required	
<b>Response Time of the complete valve (with connector)</b>	3/2 N.C. or N.O. 4/2 single solenoid 4/2 double solenoid	Actuating: 10 ms Return: 15 ms	
<b>Duty factor</b>		ED 100%	
<b>Dust and Water protection</b>	S & T Series V Series	IP67 (with lockable connector) Guillotine connector: IP65 25 Pin D-SUB: IP40 or IP65 (depending on female connector) P2M Node: IP65 P2M Lite Node: IP20	IP40 (with clip connector)

### Communication module specifications

Ethernet Protocols		Profinet IO	EtherNet/IP	Modbus/TCP	EtherCAT	PowerLink	CC-Link IE
	P2M Node	✓	✓	✓	✓	✓	✓
	P2M Lite Node	✓	✓		✓		
Ethernet specifications		According to protocol specifications					
Speed communication		10/100 Mb - Half / Full duplex					1 Gb
Service Web Page		YES			N/A		
Logic power supply		24 Vdc - According to protocol specifications					
Topology (Internal 2 port switch)		Line / Ring			Line		
Valves power Voltage		20,4 Vdc to 26,4 Vdc					
OSSD compability		P2M Node: Test Pulsed supported P2M Lite Node: Test Pulsed not supported					
Galvanic isolation		P2M Node: 2,5 kV (Logic and Auxiliary power) P2M Lite Node: Common power for both Logic & Valves					
Max. current limit Total		P2M Node: 4 A P2M Lite Node: 2 A					
Per channel		150 mA					
Protection		Polarity inversion, short circuit and Over Temperature					
IO-Link 		Standard Version			-SPC Version		
IO-Link specifications		According to IO-Link V1.1.2					
Speed communication		Com2 - 38 kBd					
Logic power supply		Module powered by IO-Link master according to IO-Link V1.1.2					
Aux. power Voltage		20,4 Vdc to 26,4 Vdc					
OSSD compability		No			Yes (Test Pulsed supported)		
Galvanic isolation		Yes					
Max. current limit Total		4A			2A		
Per channel		150 mA					
Protection		Polarity inversion & short circuit					
<b>All Protocols</b>	EMC/CE mark	According to EN 61000-6-2 & EN 50081-2					

**Technical characteristics**

**Vacuum module**

**Fluid**

Compressed air or inert gas, filtered 40µ mini., not lubricated

**Working pressure**

1 to 8 bar

**Working temperature**

-15°C to +60°C

**Materials**

Body: Polyamide 6,6 reinforced fibreglass

Poppet: Nitrile

Nozzle: Brass

Clip connector: Treated steel

**Pressure sensor**

**Fluid**

Air or inert gas, filtered 40µ mini., not lubricated

**Working temperature**

0°C to +50°C

**Supply**

10,8 to 30 V DC

**Digital output**

PNP 125 mA

**Materials**

Body: Polycarbonate

**Connection drawing**

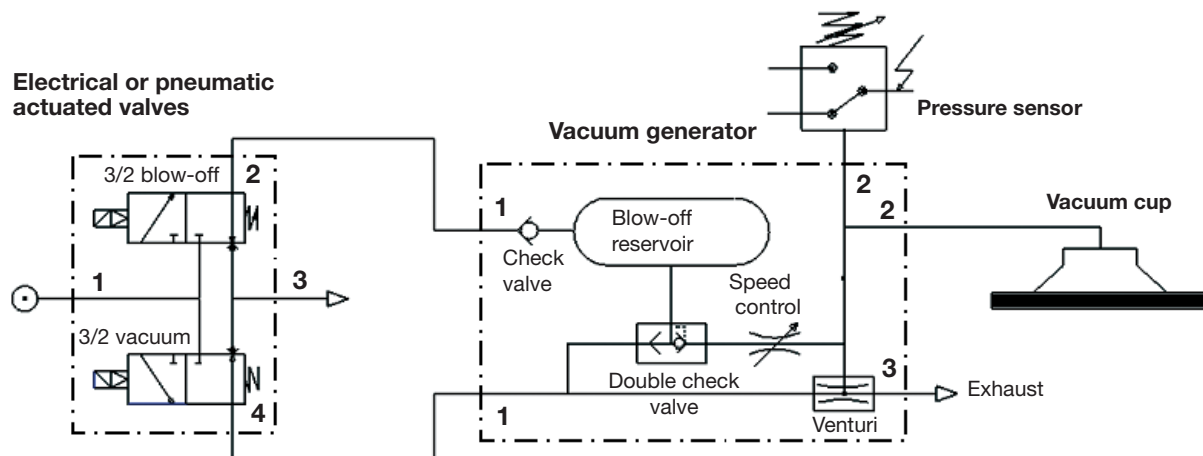

**Specific characteristics**

**Maximum vacuum**

Vacuum level: 90% at 6,5 bar

**Air consumption**

Consumption: 46 NI/min at 5 bar

**Vacuum flow**

Flow: 25NI/min at 0 % vacuum and 6,5 bar

**Evacuation time in s/l to reach different vacuum levels % (at P = 6,5 bar)**

Vacuum %	0	10	20	30	40	50	60	70	80	90
Time in s	0,0 / 0,0	0,3 / 0,3	0,4 / 0,5	0,8 / 0,9	1,4 / 1,5	2,0 / 2,2	2,7 / 3,2	3,7 / 4,9	5,9 / 9,8	10,7 / -
Flow in NI/min	24,9 / 23,2	22,1 / 20,3	19,3 / 17,3	16,6 / 14,4	13,8 / 11,5	11,0 / 8,5	8,2 / 5,6	5,5 / 2,7	2,7 / 0,0	0,0 / -

With silencer / With captured exhaust \*

**Performances**

**Vacuum level**

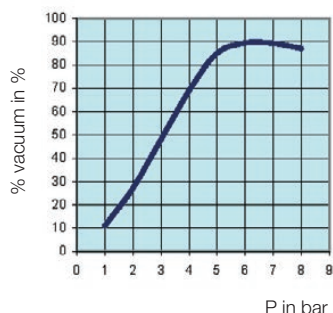

**Vacuum flow**

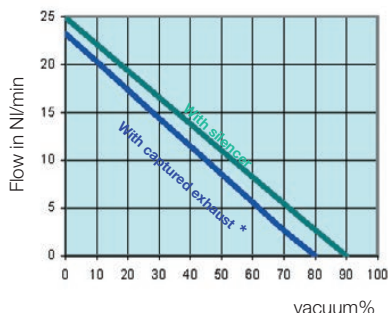

\* 1 m exhaust - tube Ø6 mm  
3 m exhaust - tube Ø8 mm

**Air consumption**

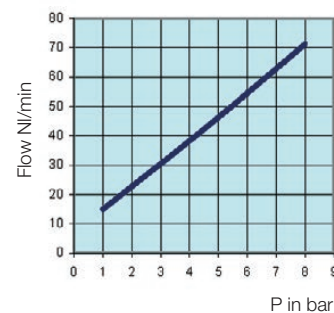

**Operating information**

Working pressure	-0,9 to 8 bar
Pilot pressure	3 to 8 bar *
Working temperature	-15 °C to 60 °C
Protection individual M8 connectors	IP 67 NEMA4
Protection individual clip connector	IP40
Protection integrated connectors	IP 65
Voltage	24 V DC
* Single and double 3/2	3,5 to 8 bar

		Dual 4/2	Dual 3/2	3/2	4/2
<b>Size 1</b>	<b>Qmax.</b>	275 l/min	415 l/min	415 l/min	510 l/min
	<b>Qn</b>	165 l/min	235 l/min	235 l/min	310 l/min
<b>Size 2</b>	<b>Qmax.</b>	-	805 l/min	805 l/min	1340 l/min
	<b>Qn</b>	-	450 l/min	440 l/min	800 l/min

**Total ordering flexibility**

In addition to the complete product adaptability, the Moduflex valve range offers ordering flexibility for V, T, S and P series with 3 different designs; from all components separately ordered (basic module) to pre-assembled and tested valve island.

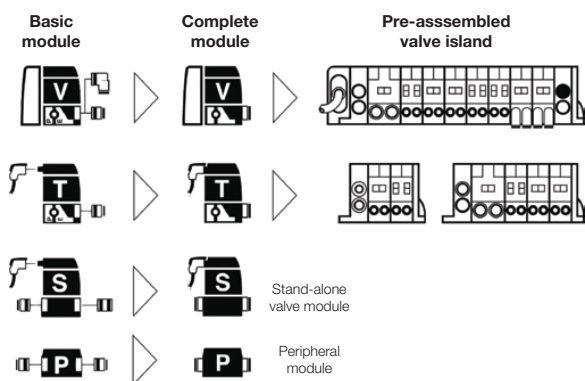

**Ordering options**

**1 - Basic modules ordering**

Using this option, all basic components are separately ordered :

- Head and Tail set
- Valve modules
- Intermediate module kit
- Peripheral modules
- Pneumatic connectors, mufflers and plugs
- Electrical connection or fieldbus module

The complete bill of material needed for the valve island assembly can be easily details using page 1 of the Moduflex Valve Configurator software report.

**2 - Complete modules ordering**

Using this option, modules are defined, ordered and supplied, pneumatic connectors and electrical connection equipped. One part number defines:

- Function module
- Pneumatic connectors, muffler and plugs
- Electrical connection and cable













For an entire valve island configuration, the list of complete modules can be easily details using page 3 of the Moduflex Valve Configurator software report.

**3 - Pre-assembled valve islands ordering**

Using this option, the complete valves island configuration has to be defined, and may be ordered, delivered fully assembly and tested under one part number.

The Moduflex Valve in-line e-Configurator software is an easy way for a clear definition of the requested valve island configuration.

## Moduflex Valve System - P2M

V series	T series	S series	P series
<p><b>Integrated connection field bus or multi-connector valve island</b></p> 	<p><b>Individual connector valve islands</b> Solenoid clip or lockable connector or remote air pilot</p> 	<p><b>Stand alone valves</b> Solenoid clip or lockable connector or remote air pilot</p> 	<p><b>Peripheral modules</b> Flow control, check valves, pressure regulator, vacuum</p> 
 <p>Pages 16-21</p>	 <p>Pages 22-23</p>	 <p>Pages 24-25</p>	 <p>Pages 26-27</p>
 <p>Pages 28-29</p>		 <p>Page 30</p>	 <p>Page 31</p>

### Moduflex Valve in-line e-Configurator

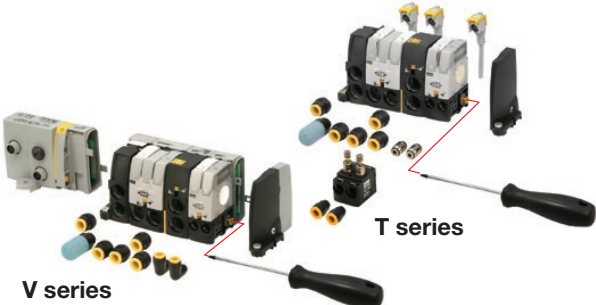

V series

T series

<http://www.parker.com/pde/P2M>



**Integrated connections valve islands: V series**

In a V series Moduflex valve island, electrical controls are all received by the head module and transmitted to the concerned valve modules through the modular integrated circuit.

The head node may either be a cable multi-connector or a Fieldbus communication node: the next pages show multi-connector cable and a complete choice of bus protocols.



**Valve island configuration**

The following page shows all valve sizes and functions that may enter into a V series valve island and, for each valve size, a choice of clip-on pneumatic connectors: tubing size, straight, elbow etc. To receive its pressure supply and collect its exhaust, the island also requires a pneumatic head and tail module set and sometimes an

intermediate module set with 4 configuration plates for different functions. To receive its electrical controls, the island is completed by an electrical head module, either a multi-connector or by a communication node to be chosen from the next pages.

Valve island electrical head module: multi-connector or communication nodes

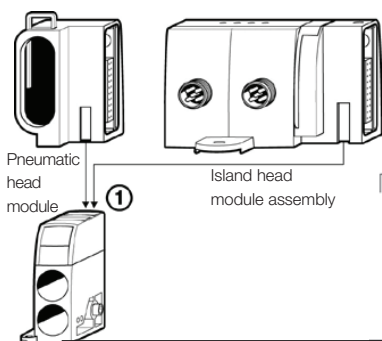

**Valve island assembly**

The above illustration presents:

- **Step 1**: the electrical head module is engaged into the pneumatic head module ;
- **Step 2**: valve modules are one by one screwed onto each other starting from the head module. For this task, the single integrated screw is tightened with a torx T8 standard screwdriver.

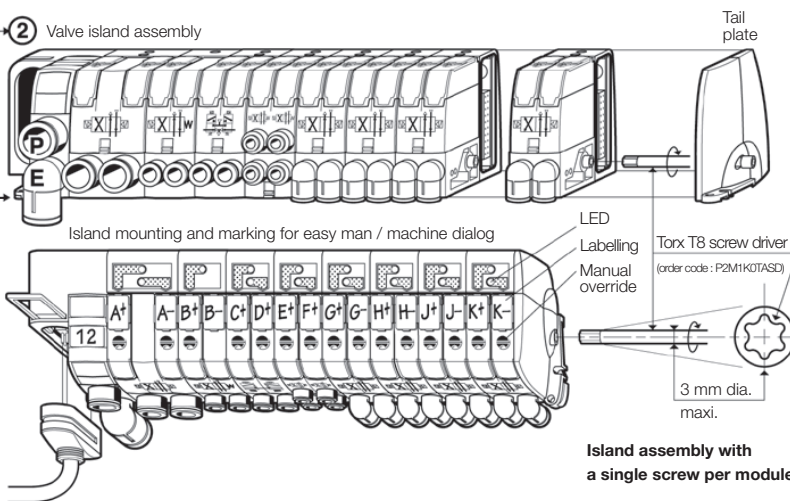

**Island assembly with a single screw per module**

The pneumatic connectors may be clipped or unclipped at any stage.

With a LED, a manual override and a labelling for each valve pilot (see illustration), the island front face eases the "man / machine" dialogue.

The resulting valve island length is expressed by the drawing below, while further size details and mountings are presented on the dimensions pages.

**Modules and island ordering**

Choice between 3 approaches:

**1 - Basic modules ordering:**

The following page shows these modules supplied without connector, together with the choice of clip-on connectors separately supplied (10 units packs). This approach gives the maximum flexibility.

**2 - Complete modules ordering:**

Page 31 shows the ordering chart for modules supplied with their connectors.

**3 - Assembled island ordering:**

An In-Line configurator, available from the product web-page "<http://www.parker.com/pde/P2M>", allows to specify a valve island that may be delivered assembled.

Communication node:  
 • Ethernet nodes, width: 126 mm  
 • IO-Link, width: 94 mm

Multi-connector head module:  
 • guillotine, width: 47 mm  
 • sub-D 25, width: 56 mm

Valve modules  
 size 1:  
 • width: 25 mm

Valve module  
 size 2:  
 • width: 37.5 mm

Intermediate  
 module:  
 • width: 25 mm

Tail  
 plate:  
 • width: 16 mm

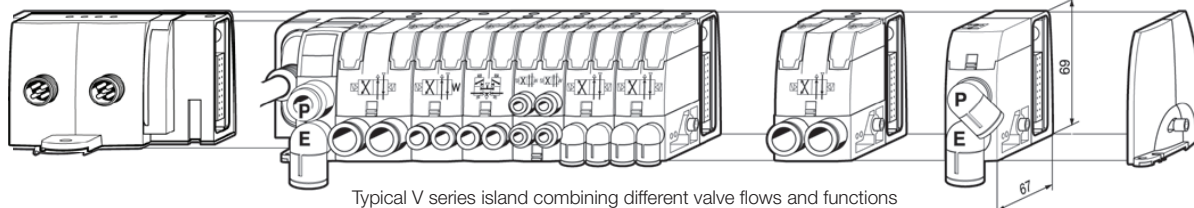

Typical V series island combining different valve flows and functions



**Basic modules (without connector)**

Valve Modules		Size 1			Size 2	
Size 1	Symbol	Description	Weight [g]	Order code	Weight [g]	Order code
		4/2 Solenoid spring	94	<b>P2M1V4ES2CV</b>	100	<b>P2M2V4ES2CV</b>
		4/2 Double solenoid	103	<b>P2M1V4EE2CV</b>	110	<b>P2M2V4EE2CV</b>
		2 x 3/2 NC + NC with exhaust check valves	106	<b>P2M1VDEE2CV</b>	115	<b>P2M2VDEE2CV</b>
		2 x 3/2 NO + NO with exhaust check valves	106	<b>P2M1VCEE2CV</b>	115	<b>P2M2VCEE2CV</b>
		2 x 3/2 NC + NO with exhaust check valves	106	<b>P2M1VEEE2CV</b>	115	<b>P2M2VEEE2CV</b>
		2 x 4/2 Solenoid spring with exhaust check valves	114	<b>P2M1VJEE2CV</b>		
		3/2 NC with exhaust check valves	102	<b>P2M1V3ES2CV</b>	110	<b>P2M2V3ES2CV</b>
		4/3 Centre exhaust 2 x 3/2 NC + NC without exhaust check valves	106	<b>P2M1VGEE2CV</b>		<b>P2M2VGEE2CV</b>

**Island head and intermediate module sets**

Valve Modules		Description	Weight [g]	Size 2 Order code
		Valve island pneumatic head and tail module set	64	<b>P2M2HXT01</b>
		Valve island intermediate supply module with a set of 4 configuration plates	68	<b>P2M2BXV0A</b>

**Clip-On pneumatic connectors \***

Valve Modules		Size 1			Size 2		
	Description	Tube OD	Weight [g]	Order code	Weight [g]	Order code	
	Straight connector	G1/8"	2	<b>FMDG1-1</b>			
				2	<b>FMD04-1</b>		
				3	<b>FMD06-1</b>		
						3	<b>FMD06-2</b>
						4	<b>FMD08-2</b>
						5	<b>FMD10-2</b>
	Elbow connector	G1/8"	3	<b>CMDG1-1</b>			
				3	<b>CMD04-1</b>		
				5	<b>CMD06-1</b>		
						5	<b>CMD06-2</b>
						6	<b>CMD08-2</b>
						7	<b>CMD10-2</b>
	Silencer				5	<b>MMDVA2</b>	
	Plug				5	<b>PMDXX2</b>	

\* Fittings and plugs pack quantity: 10

**V series valve island: Electrical multi-connector head module**

Description		Protection	Cable length	Weight [g]	Order code
	Multi-connection head module			38	<b>P2M2HEV0A</b>
	<b>Guillotine type</b>	IP65	2 m	335	<b>P8LMH20M2A</b>
			5 m	802	<b>P8LMH20M5A</b>
			9 m	1425	<b>P8LMH20M9A</b>
	Multi-connection head module			60	<b>P2M2HEV0D</b>
	<b>Standard Sub-D 25 type</b>	IP40	3 m	435	<b>P8LMH25M3A</b>
			9 m	1425	<b>P8LMH25M9A</b>
			9 m	1425	<b>P8LMH25B9A</b>

**Valve Island V Series with IO-Link connection**

The P2M Moduflex IO-Link 24 DO node allows a very simple and cost efficient connection to any IO-Link master, centralised into the PLC or decentralised through an industrial Ethernet network.

Designed in both Class A and Class B versions with an isolated auxiliary power, it can easily be adapted to all power supply architectures and follow machine directives



**P2M IO-link 24 DO Class A node with independent Auxiliary Power Supply**

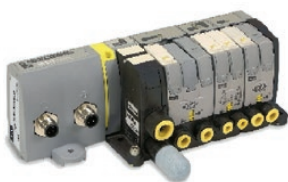

The P2M IO-Link 24 DO Class A node can handle a Moduflex Valve bank having up to 19 pilot solenoid valves.

Thanks to its 2 x M12 A coded male connectors, it can be connected to any IO-Link Class A masters and separately receive its auxiliary power supply for valves from an independent source.

The P2M IO-Link 24 DO Class A node exists in 3 versions with the Auxiliary Power M12 connector pin out adapted to any sourcing through a standard M12 cable:

- P2M2HBVL12400A13 / -SPC version: 24 Vdc / 0 Vdc on pins 1 & 3 – Standard version
- P2M2HBVL12400A43 / -SPC version: 24 Vdc / 0 Vdc on pins 4 & 3 – Compatible with Siemens wiring
- P2M2HBVL12400A42 / -SPC version: 24 Vdc / 0 Vdc on pins 4 & 2 – Compatible with Rockwell wiring

**P2M IO-link 24 DO Class B node**



The P2M IO-Link 24 DO Class B node can handle a Moduflex Valve bank having up to 19 pilot solenoid valves.

Thanks to its single M12 A coded male connectors, it can be connected to any IO-Link Class B masters receiving its auxiliary power supply for valves on pins 2 & 5 from the only cable simplifying the connection.

**Diagnostic**



The P2M IO-Link 24 DO node offers a local diagnostic through 4 LED's located on the visible top side, showing:

- IO-Link com status
- Node error
- Output error
- Auxiliary power

Additional useful diagnostic information can be read by the PLC through the network simplifying diagnostic and allowing predictive maintenance (all details in the user manual)

**Safe Power Capable version (-SPC)**



Auxiliary power of -SPC version of P2M IO-Link 24 DO node can be supplied from a safe output device following machinery directives. This includes:

- Output Signal Switch Device (OSSD) test pulse compatible
- Galvanic isolation between 0 Vdc Logic and Aux power
- PP or PM cabling modes

For more details, refer to the "Communication nodes – connection and configuration" section.

**V series valve island: Communication node for IO-Link**

Communication node for 19 outputs (Moduflex Pilot Valves)  
 (The last 5 outputs of this 24 DO node can't be used with Moduflex Valve)

Description	IO-Link Class	M12 A coded Connector connection			Weight (g)	Order code
		IO-Link	Aux. Power	Aux. Power Pinout		
 P2M IO-Link Communication Node	Class A	3 Pin's	3 Pin's	1 & 3	160	<b>P2M2HBVL12400A13</b>
		3 Pin's	3 Pin's	4 & 3	160	<b>P2M2HBVL12400A43</b>
		3 Pin's	5 Pin's	4 & 2	160	<b>P2M2HBVL12400A42</b>
	Class B	5 Pin's		2 & 5	140	<b>P2M2HBVL12400B25</b>
 P2M IO-Link Communication Node <b>Safe Power Capable</b>	Class A	3 Pin's	3 Pin's	1 & 3	165	<b>P2M2HBVL12400A13-SPC</b>
		3 Pin's	3 Pin's	4 & 3	165	<b>P2M2HBVL12400A43-SPC</b>
		3 Pin's	5 Pin's	4 & 2	165	<b>P2M2HBVL12400A42-SPC</b>
	Class B	5 Pin's		2 & 5	145	<b>P2M2HBVL12400B25-SPC</b>

IODD file can be downloaded from IODD Finder or the Moduflex web site:  
<https://ioddfinder.io-link.com>  
[www.parker.com/pde/io-link](http://www.parker.com/pde/io-link)

**Accessories**

Description	Connector type	Weight (g)	Order code
 P8CS1205AA Quick connect straight connector for both IO-Link communication and auxiliary power supply	M12 - 5 Pin's Female - A Coding	25	<b>P8CS1205AA</b>

**Valve Island V Series with Industrial Ethernet connection**

The P2M Industrial Ethernet 24 DO node allows a very simple and cost efficient connection to the most popular Industrial Ethernet networks.

Designed with an isolated auxiliary power, it can easily be adapted to all power supply architectures and follow machine directives.

PROFINET

EtherNet/IP

ETHERNET POWERLINK

EtherCAT

Modbus

CC-Link IE

**Product Set-Up**



The P2M Industrial Ethernet 24 DO node offers an IP addressing through 3 rotary switches located on the top side.

The 3 rotary switches allow also a Factory Reset, IP address storage, and DHCP mode addressing.

As soon as supported by protocol, this IP address can be modified through an imbedded web page.



For an application requiring a regular disconnection / reconnection of the node, Profinet and EtherNet/IP protocols allow respectively a Fast Start-Up (FSU) and Quick Connect mode. This mode can be enable or disable .

**Technology / Integrated Ethernet Switch**



The P2M Industrial Ethernet 24 DO node offers 2 Ethernet ports allowing a line topology without external switch. The Ring topology can also be supported (enable/disable) for Profinet, EtherNet/IP and Modbus TCP/IP.

The integrated Ethernet switch support Class C Services allowing used in an isochronous real time (IRT) structure.

**Diagnostic**



The P2M Industrial Ethernet 24 DO node offers a local diagnostic through 7 LED's located on the visible top side, showing:

- Logic status
- Ethernet activity on both ports
- Standard Status due to protocol
- Output error / Auxiliary power



This local information as well as trouble shooting and predictive maintenance diagnostics (Power monitoring, Life cycle counting, ...) are available in PLC through the network and reported on imbedded web page.

When PLC is in "STOP", the web page allows to force ON/OFF solenoids state. This function has a password protection.

**Safe Power Capable**

Auxiliary power of P2M Industrial Ethernet 24 DO node can be supplied from a safe output device following machinery directives. This includes:

- Output Signal Switch Device (OSSD) test pulse compatible
- Galvanic isolation between 0 Vdc Logic and Aux power
- PP or PM cabling modes

For more details, refer to the "Communication nodes – connection and configuration" section.



PDE2536TCUK

## Moduflex Valve System - P2M

### V series valve island: Communication node for Industrial Ethernet

Industrial Ethernet node for 19 outputs (Moduflex Pilot Valves)  
(The last 5 outputs of this 24 DO node can't be used with Moduflex Valve)



Description	Protocol	Eth. ports	Aux. Power	Weight (g)	Order code
P2M industrial Ethernet Communication Node	Profinet IO	2 x M12 D-coded	M12 A-coded	190	<b>P2M2HBVN12400</b>
	EtherNet/IP	2 x M12 D-coded	M12 A-coded	190	<b>P2M2HBVE12400</b>
	EtherCAT	2 x M12 D-coded	M12 A-coded	190	<b>P2M2HBVT12400</b>
	PowerLink	2 x M12 D-coded	M12 A-coded	190	<b>P2M2HBVW12400</b>
	Modbus /TCP	2 x M12 D-coded	M12 A-coded	190	<b>P2M2HBVM12400</b>
	CC-Link IE	2 x M12 X-coded	M12 A-coded	190	<b>P2M2HBVK12400*</b>

\*) Coming soon

Configuration file can be download from the dedicated product web page:

[www.parker.com/pde/P2M\\_IE](http://www.parker.com/pde/P2M_IE)

### Accessories



Description	Connector type	Weight (g)	Order code
Quick connect straight connector for module power supply	M12 - 5 Pin's Female - A Coding	25	<b>P8CS1205AA</b>

**Valve Island V Series with Industrial Ethernet connection**

**EtherNet/IP**

The P2M Industrial Ethernet Lite node 24DO allows a very simple and cost efficient connection to the most popular Industrial Ethernet networks.



In its compact IP40 version equipped with two RJ45 Ethernet ports, it saves size in cabinet applications and offers an easy connection to the network in a line topology.



**Product Set-Up**



The P2M Lite Node 24DO is by default in DHCP mode. The module must be assigned to a static IP-Address in order to be controlled via the network.



The Network Configuration settings can be done through the embedded web server of the node as well as "IPconfig", "TIA Portal" or similar methods.

For an application requiring a regular disconnection / reconnection of the node, Profinet and EtherNet/IP protocols allow respectively a Fast Start-Up (FSU) and Quick Connect mode. This mode can be enable or disable .

**Technology / Integrated Ethernet Switch**



The P2M Industrial Ethernet Lite node 24DO offers 2 RJ45 ports allowing a line topology without external switch. The Ring topology can also be supported (enable/disable) for Profinet and EtherNet/IP.

The integrated Ethernet switch support Class C Services allowing used in an isochronous real time (IRT) structure.

**Diagnostic**



The P2M Industrial Ethernet Lite node 24DO offers a local diagnostic through 5 LED's located on the visible top side and 4 additional on both Ethernet connectors showing:

- Logic status
- Ethernet activity on both ports
- Standard Status due to protocol
- Output error / Power Supply

This local information as well as trouble shooting and predictive maintenance diagnostics (Power monitoring, Life cycle counting, ...) are available in PLC through the network and reported on imbedded web page.

When PLC is in "STOP", the web page allows to force ON/OFF solenoids state. This function has a password protection.

PDE2536TCUK

## Moduflex Valve System - P2M

### V series valve island: Communication node for Industrial Ethernet

P2M Lite Industrial Ethernet node for 19 outputs (Moduflex Pilot Valves)  
(The last 5 outputs of this 24 DO node can't be used with Moduflex Valve)



Description	Protocol	Eth. ports	Power	Weight (g)	Order code
P2M Industrial Ethernet Communication Node	Profinet IO	2 x RJ45	3 PIN's male*	190	<b>P2M2HBVN12400RJ</b>
	EtherNet/IP	2 x RJ45	3 PIN's male*	190	<b>P2M2HBVE12400RJ</b>
	EtherCAT	2 x RJ45	3 PIN's male*	190	<b>P2M2HBVT12400RJ</b>

\*) Female 3,81 mm pitch connector included

Configuration file can be download from the dedicated product web page:

[www.parker.com/pde/P2M\\_IE](http://www.parker.com/pde/P2M_IE)

**Individual connection valve islands: T series**

In a T series valve island, electrical controls are individually connected to each valve module, onto its solenoid pilot.

As an alternative, air pilot valve modules are also available, to be controlled by individual pneumatic signals.



**Valve island assembly**

As shown by the above illustration, the valve modules are one by one screwed onto each other, starting from the head module. For this task, the single integrated screw is tightened with a torx T8 standard screwdriver.

The pneumatic connectors may be clipped or unclipped at any stage.

With a LED, a manual override and a labelling for each valve pilot (see above illustration), the island front face eases the "man / machine" dialogue.

The resulting valve island length is expressed by the drawing below, while further size details and mountings are presented on dimensions pages.

**Valve pilot connections**

**1 - Solenoid valve modules**

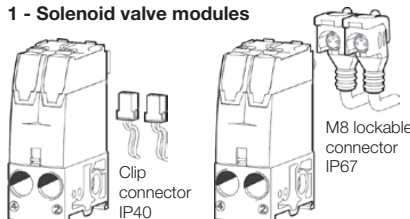

In its IP40 version, each solenoid shows Clip connection integrating LED and voltage surge protection. The clip connector with flying leads may be ordered separately with independent or interconnected common.

In its IP67 version, each solenoid shows a M8 connection. Lockable connectors, IP67 protected, with LED voltage surge protection and flying lead cable may be ordered for the required length.

**2 - Air pilot valve modules**



No connector has to be ordered: each pneumatic pilot port includes its integrated movable elbow 4 mm OD tube push-in connector.

Typical T series short island for single or double acting small cylinders.

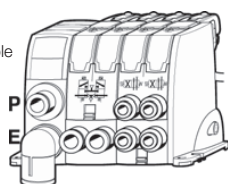

**Valve island configuration**

The following page presents all valve sizes and functions that may enter into a T series valve island and, for each valve size, a choice of clip-on pneumatic connectors: tubing size, straight, elbow etc."

To receive its pressure supply and collect its exhaust, the island also requires a

pneumatic head and tail module set and sometimes an intermediate module set including 4 configuration plates for different functions. Valve modules may either be solenoid versions or air pilot versions. Mixing both versions into the same valve island is possible.

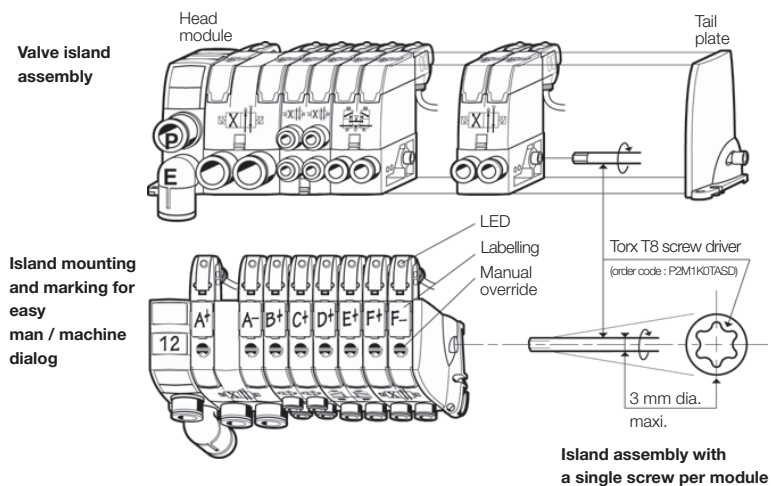

**Modules and island ordering**

Choice between 3 approaches:

**1 - Basic modules ordering:**

The following page shows these modules supplied without connector, together with the choice of clip-on connectors separately supplied (10 units packs). This approach gives the maximum flexibility.

**2 - Complete modules ordering:**

Page 27 shows the ordering chart for modules supplied with their connectors.

**3 - Assembled island ordering:**

Page 30 shows the valve island configurator CD-Rom to specify a valve island that may be delivered assembled.





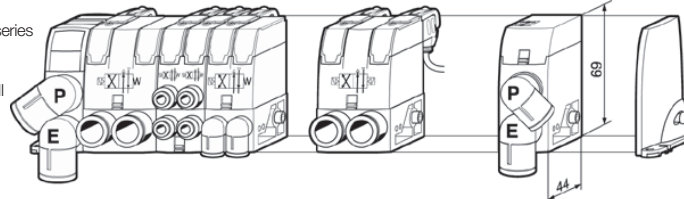





Pneumatic head module: ■ width: 32 mm	Valve module size 1: ■ width: 25 mm	Valve module size 2: ■ width: 37.5 mm	Intermediate module: ■ width: 25 mm	Tail plate: ■ width: 16 mm
--	--	--	--	-------------------------------

Typical T series high flow island for both small and large cylinders.



Typical T series islands combining different valve flows and functions



**Basic modules (without connector)**

Valve Modules					Size 1		Size 2	
	Symbol	Description	Actuator	Pilot connector	W (g)	Order code	W (g)	Order code
 Size 1 Dual 4/2		4/2 Spring return	Solenoid	M8 Lockable	68	<b>P2M1T4ES2C</b>	74	<b>P2M2T4ES2C</b>
			Air pilot	Clip	68	<b>P2M1T4ES2CW</b>	74	<b>P2M2T4ES2CW</b>
		4/2 Double pilot	Solenoid	M8 Lockable	77	<b>P2M1T4EE2C</b>	83	<b>P2M2T4EE2C</b>
			Air pilot	Clip	77	<b>P2M1T4EE2CW</b>	83	<b>P2M2T4EE2CW</b>
 Size 1		2 x 3/2 NC + NC with exhaust check valves	Solenoid	M8 Lockable	80	<b>P2M1TDEE2C</b>	94	<b>P2M2TDEE2C</b>
			Air pilot	Clip	80	<b>P2M1TDEE2CW</b>	94	<b>P2M2TDEE2CW</b>
		2 x 3/2 NO + NO with exhaust check valves	Solenoid	M8 Lockable	80	<b>P2M1TCEE2C</b>	94	<b>P2M2TCEE2C</b>
			Air pilot	Clip	80	<b>P2M1TCEE2CW</b>	94	<b>P2M2TCEE2CW</b>
		2 x 3/2 NC + NO with exhaust check valves	Solenoid	M8 Lockable	80	<b>P2M1TEEE2C</b>	94	<b>P2M2TEEE2C</b>
			Air pilot	Clip	80	<b>P2M1TEEE2CW</b>	94	<b>P2M2TEEE2CW</b>
 Size 2		2 x 4/2 Spring return with exhaust check valves	Solenoid	M8 Lockable	88	<b>P2M1TJEE2C</b>		
			Air pilot	Clip	88	<b>P2M1TJEE2CW</b>		
		3/2 NC with exhaust check valves	Solenoid	M8 Lockable	76	<b>P2M1T3ES2C</b>	90	<b>P2M2T3ES2C</b>
			Air pilot	Clip	76	<b>P2M1T3ES2CW</b>	90	<b>P2M2T3ES2CW</b>
		4/3 Centre exhaust	Solenoid	M8 Lockable	71	<b>P2M1T3PS</b>	70	<b>P2M2T3PS</b>
		2 x 3/2 NC + NC without exhaust check valves	Solenoid	M8 Lockable	80	<b>P2M1TGEE2C</b>	94	<b>P2M2TGEE2C</b>
	Air pilot	Clip	80	<b>P2M1TGEE2CW</b>	94	<b>P2M2TGEE2CW</b>		
		Air pilot	Clip	70	<b>P2M1TGPP</b>	84	<b>P2M2TGPP</b>	

**Island head and intermediate module sets**

Valve Modules					Size 2	
	Description	W (g)	Order code			
 P2M2HXT01      P2M2BXT0A	Valve island pneumatic head and tail module set	64	<b>P2M2HXT01</b>			
	Valve island intermediate supply module with a set of 4 configuration plates	64	<b>P2M2BXT0A</b>			

**Clip-On pneumatic connectors \***

Valve Modules					Size 1		Size 2	
	Description	Tube OD	W (g)	Order code	W (g)	Order code		
	Straight connector	G1/8"	2	<b>FMDG1-1</b>				
		4 mm	2	<b>FMD04-1</b>				
		6 mm	3	<b>FMD06-1</b>	3	<b>FMD06-2</b>		
		8 mm			4	<b>FMD08-2</b>		
		10 mm			5	<b>FMD10-2</b>		
		12 mm			6	<b>FMD12-2</b>		
	Elbow connector	G1/8"	3	<b>CMDG1-1</b>				
		4 mm	3	<b>CMD04-1</b>				
		6 mm	5	<b>CMD06-1</b>	5	<b>CMD06-2</b>		
		8 mm			6	<b>CMD08-2</b>		
		10 mm			7	<b>CMD10-2</b>		
		12 mm			8	<b>CMD12-2</b>		
	Silencer				5	<b>MMDVA2</b>		
	Plug		3	<b>PMDXX1</b>	5	<b>PMDXX2</b>		

\* Fittings and plugs pack quantity: 10

**Electrical connectors**

Valve Modules					Size 1		Size 2		
	Description	Connector type	Cable length	W (g)	Order code				
 M8 lockable connector      Clip connector	Individual lockable connector – IP67	M8 / 2 x Flying leads	2 meters	62	<b>P8LS08L226C</b>				
	Including LED and surge protection		5 meters	155	<b>P8LS08L526C</b>				
	2 Flying leads		9 meters	180	<b>P8LS08L926C</b>				
	Clip connector – IP40	1 x Clip connector	1 meter	8	<b>P8LW021C</b>				
	Individual: Including 2 flying leads		2 meter	12	<b>P8LW022C</b>				
	Multiple: Including 1 common (0 Vdc) and 1 flying lead per connector	2 x Clip connectors	1 meter	12	<b>P8LW021C02</b>				
		4 x Clip connectors	1 meter	20	<b>P8LW021C04</b>				
		8 x Clip connectors	1 meter	36	<b>P8LW021C08</b>				
	Straight cable quick connect to thread connector, IP67 protected		M8		12	<b>P8CS0803J</b>			
			M12		15	<b>P8CS1204J</b>			

**Stand-Alone Valve Modules: S series**

Very useful to control isolated cylinders, these stand-alone valves module are compact and easy to mount on the machines with neat electrical and pneumatic connections.

As an alternative to electrical controls, valves with air pilots are also available, to be controlled by individual pneumatic signals.



**Valve functions**

The following page shows all valve sizes and functions and, for each valve size, a choice of clip-on pneumatic connectors: tubing size, straight, elbow etc."

**Valve main connections**

- Outlets to cylinders (ports 2 and 4) on one side.
- Supply P (port 1) and exhaust E (port 3) on the other side. At port 3, exhaust may be collected or receive a clip-on muffler.

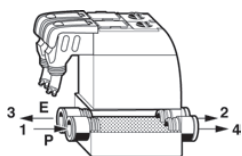

**Valve mounting**

All valves may be mounted either with side screws or with their integrated retractable brackets.

**Side screw mounting**

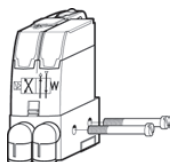

The brackets are then retracted.

**Optional foot mounting**



The brackets are then extended.

**Valve pilot connections**

**1- Solenoid valve modules**

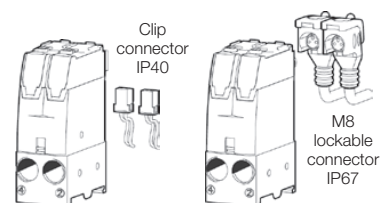

In its IP40 version, each solenoid shows Clip connection integrating LED and voltage surge protection. The clip connector with flying leads may be ordered separately with independent or interconnected common. In its IP67 version, each solenoid shows a M8 connection. Lockable connectors, IP67 protected, with LED voltage surge protection and flying lead cable may be ordered for the required length.

**2- Air pilot valve modules**

No connector has to be ordered : each pneumatic pilot port includes its integrated movable elbow 4 mm OD tube push-in connector.

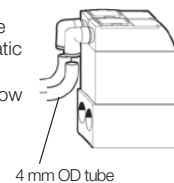

**Modules and island ordering**

Choice between 2 approaches:

**1 - Basic modules ordering:**

The following page shows these modules supplied without connector, together with the choice of clip-on connectors separately supplied (10 units packs). This approach gives the maximum flexibility.

**2 - Complete modules ordering:**

Page 28 shows the ordering chart for modules supplied with their pneumatic and electrical connectors and muffler.



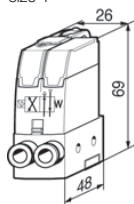



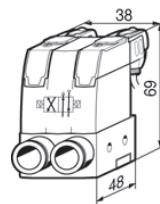



Valve module size 1







Valve module size 2



**Basic modules (without connector)**



Valve Modules	Symbol	Description	Actuator	Pilot connector	Size 1		Size 2	
					W (g)	Order code	W (g)	Order code
		4/2 Spring return	Solenoid	M8 Lockable	72	<b>P2M1S4ES2C</b>	78	<b>P2M2S4ES2C</b>
			Air pilot	Clip	72	<b>P2M1S4ES2CW</b>	78	<b>P2M2S4ES2CW</b>
		4/2 Double pilot	Solenoid	M8 Lockable	87	<b>P2M1S4EE2C</b>	93	<b>P2M2S4EE2C</b>
			Air pilot	Clip	87	<b>P2M1S4EE2CW</b>	93	<b>P2M2S4EE2CW</b>
		2 x 3/2 NC + NC with exhaust check valves	Solenoid	M8 Lockable	85	<b>P2M1SDEE2C</b>	91	<b>P2M2SDEE2C</b>
			Air pilot	Clip	85	<b>P2M1SDEE2CW</b>	91	<b>P2M2SDEE2CW</b>
	2 x 3/2 NO + NO with exhaust check valves	Solenoid	M8 Lockable	85	<b>P2M1SCEE2C</b>	91	<b>P2M2SCEE2C</b>	
		Air pilot	Clip	85	<b>P2M1SCEE2CW</b>	91	<b>P2M2SCEE2CW</b>	
		2 x 3/2 NC + NO with exhaust check valves	Solenoid	M8 Lockable	85	<b>P2M1SEEE2C</b>	91	<b>P2M2SEEE2C</b>
			Air pilot	Clip	85	<b>P2M1SEEE2CW</b>	91	<b>P2M2SEEE2CW</b>
		3/2 NC with exhaust check valves	Solenoid	M8 Lockable	80	<b>P2M1S3ES2C</b>	86	<b>P2M2S3ES2C</b>
			Air pilot	Clip	80	<b>P2M1S3ES2CW</b>	86	<b>P2M2S3ES2CW</b>
		4/3 Centre exhaust 2 x 3/2 NC + NC without exhaust check valves	Solenoid	M8 Lockable	70	<b>P2M1S3PS</b>	76	<b>P2M2S3PS</b>
			Air pilot	Clip	70	<b>P2M1S3PS</b>	76	<b>P2M2S3PS</b>
	2 x 3/2 NC + NC without exhaust check valves	Solenoid	M8 Lockable	85	<b>P2M1SGEE2C</b>	91	<b>P2M2SGEE2C</b>	
		Air pilot	Clip	85	<b>P2M1SGEE2CW</b>	91	<b>P2M2SGEE2CW</b>	
	2 x 3/2 NC + NC without exhaust check valves	Solenoid	M8 Lockable	75	<b>P2M1SGPP</b>	81	<b>P2M2SGPP</b>	
		Air pilot	Clip	75	<b>P2M1SGPP</b>	81	<b>P2M2SGPP</b>	

**Clip-On pneumatic connectors \***

Valve Modules	Description	Tube OD	W (g)	Size 1		Size 2	
				Order code	W (g)	Order code	
	Straight connector	G1/8"	2	<b>FMDG1-1</b>			
		4 mm	2	<b>FMD04-1</b>			
		6 mm	3	<b>FMD06-1</b>	3	<b>FMD06-2</b>	
		8 mm			4	<b>FMD08-2</b>	
		10 mm			5	<b>FMD10-2</b>	
		12 mm			6	<b>FMD12-2</b>	
	Elbow connector	G1/8"	3	<b>CMDG1-1</b>			
		4 mm	3	<b>CMD04-1</b>			
		6 mm	5	<b>CMD06-1</b>	5	<b>CMD06-2</b>	
		8 mm			6	<b>CMD08-2</b>	
		10 mm			7	<b>CMD10-2</b>	
		12 mm			8	<b>CMD12-2</b>	
	Silencer		3	<b>MMDVA1</b>	5	<b>MMDVA2</b>	
			Plug		3	<b>PMDXX1</b>	5

\* Fittings and plugs pack quantity: 10

**Electrical connectors**

	Description	Connector type	Cable length	W (g)	Order code	
					Order code	
	Individual lockable connector – IP67 Including LED and surge protection 2 Flying leads	M8 / 2 x Flying leads	2 meters	62	<b>P8LS08L226C</b>	
				155	<b>P8LS08L526C</b>	
				180	<b>P8LS08L926C</b>	
	Clip connector – IP40 Individual: Including 2 flying leads Multiple: Including 1 common (0 Vdc) and 1 flying lead per connector	1 x Clip connector	2 x Clip connectors	1 meter	8	<b>P8LW021C</b>
					12	<b>P8LW022C</b>
					12	<b>P8LW021C02</b>
					20	<b>P8LW021C04</b>
					36	<b>P8LW021C08</b>
	Straight cable quick connect to thread connector, IP67 protected	M8	M12	1 meter	12	<b>P8CS0803J</b>
					15	<b>P8CS1204J</b>

**Peripheral Valve Modules: P series**

Four additional peripheral modules complete the valve system in order to facilitate the installation of specific cylinder controls:

- Dual flow control, for cylinder speed adjusting;
- Dual pilot operated check valve, for cylinder positioning;
- Pressure regulator, for cylinder thrust adjusting;
- Vacuum generator, for vacuum pad controls.

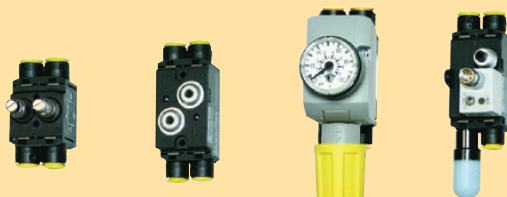

**Module function selection**

**Dual flow control**

By controlling the exhaust flows of a double acting cylinder, this module can adjust both speeds: forwards and backwards.

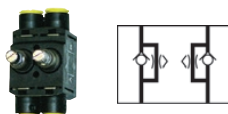

**Dual pilot operated check valve**

Combined with a double 3/2 NC + NC valve, this module will block flows and stop cylinder movement as soon as the valve outputs are both exhausted. Better than a 3 position closed centre valve, it provides accurate positioning when mounted close to the cylinder.

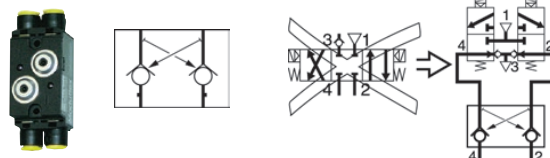

**Pressure regulator**

The thrust developed by a cylinder often requires adjustment by controlling the pressure to the front or back of the piston. This pressure regulator module enables manual adjustment of pressure on one side of the piston, with visual indication provided by the pressure gauge.

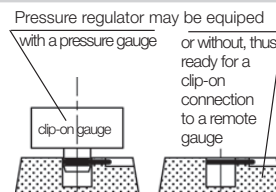
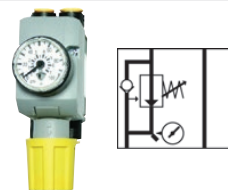

**Vacuum generator**

This multi-purpose module controls vacuum pads with a choice between two basics schematics:

- Controlled with only one 3/2 NC valve, the vacuum generator provides vacuum to the pads during valve actuation and then blow-off supplied from an integrated chamber.
- Controlled with a double 3/2 NC + NC, the vacuum generator provides vacuum during the first valve actuation, and then strong blow-off from the second valve.

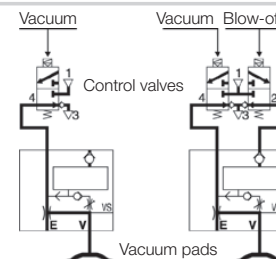
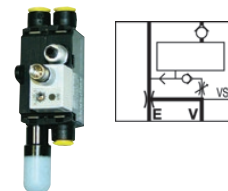

Integrated blow-off flow controller. Optional plug-in vacuum sensor.

**Module installation selection**

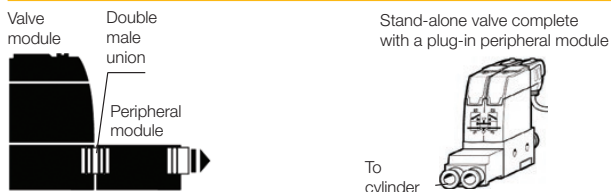





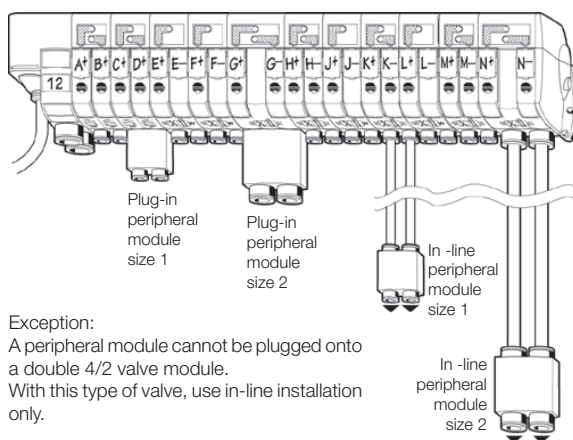



Peripheral modules may either be mounted:

- Plugged into the valve module through double male unions;
- Or in line, close to the cylinder to control it better.





Exception:  
A peripheral module cannot be plugged onto a double 4/2 valve module. With this type of valve, use in-line installation only.

**Basic peripheral modules (without connector)**



Peripheral Modules		Size 1			Size 2		
Symbol	Description	Weight (g)	Order code	Weight (g)	Order code		
	 Dual flow control	50	<b>P2M1PXFA</b>	50	<b>P2M2PXFA</b>		
	 Dual P.O. check valve	50	<b>P2M1PXCA</b>	50	<b>P2M2PXCA</b>		
	 Pressure regulator	Pressure range	Gauge				
		0 - 2 bar	0 - 4 bar	135	<b>P2M1PXSR</b>	135	<b>P2M2PXSR</b>
			Without	105	<b>P2M1PXST</b>	165	<b>P2M2PXST</b>
		0 - 4 bar	0 - 7 bar	135	<b>P2M1PXSM</b>	135	<b>P2M2PXSM</b>
			Without	105	<b>P2M1PXSL</b>	165	<b>P2M2PXSL</b>
		0 - 8 bar	0 - 11 bar	135	<b>P2M1PXSG</b>	135	<b>P2M2PXSG</b>
	Without	105	<b>P2M1PXSN</b>	165	<b>P2M2PXSN</b>		
	 90% Vacuum generator	30	<b>P2M1PXVA</b>				

**Clip-On pneumatic connectors \***

Valve Modules		Size 1			Size 2	
Description	Tube OD	Weight (g)	Order code	Weight (g)	Order code	
	Straight connector	G1/8"	2	<b>FMDG1-1</b>		
		4 mm	2	<b>FMD04-1</b>		
		6 mm	3	<b>FMD06-1</b>	3	<b>FMD06-2</b>
		8 mm			4	<b>FMD08-2</b>
		10 mm			5	<b>FMD10-2</b>
		12 mm			6	<b>FMD12-2</b>
	Elbow connector	G1/8"	3	<b>CMDG1-1</b>		
		4 mm	3	<b>CMD04-1</b>		
		6 mm	5	<b>CMD06-1</b>	5	<b>CMD06-2</b>
		8 mm			6	<b>CMD08-2</b>
		10 mm			7	<b>CMD10-2</b>
		12 mm			8	<b>CMD12-2</b>
	Double male union	5	<b>HMDXX1</b>	8	<b>HMDXX2</b>	
	Silencer	3	<b>MMDVA1</b>			
	Plug	3	<b>PMDXX1</b>	5	<b>PMDXX2</b>	

\* Fittings and plugs pack quantity: 10

**Clip-on accessories**

Description	Connection	Pressure range	Weight (g)	Order code
	Clip-on	0 to 4 bar	30	<b>P2M1K0GT</b>
		0 to 7 bar	30	<b>P2M1K0GL</b>
		0 to 11 bar	30	<b>P2M1K0GN</b>
	Diam. 4 mm tube	0 to -1 bar	25	<b>MPS-V8T4-AG</b>
	Diam. 6 mm tube	0 to -1 bar	25	<b>MPS-V8T-AG</b>
	G 1/8" male	0 to -1 bar	45	<b>MPS-V34G-PCI</b>

**Complete module ordering, as compared to basic module ordering**

**Complete modules**

Ordered from the following pages, the complete modules are supplied all equipped with their electrical and pneumatic connectors. Only one order line is necessary, and each module comes complete, with just the necessary chosen connectors.



**Basic modules**

Ordered from the previous pages, the basic modules are to be equipped with their connectors. The clip-on assembly to the module is easy. The main advantage is flexibility : connector type and size may be chosen at the last moment, to better fit the machine needs.



**V series**

See opposite page for complete module order code chart

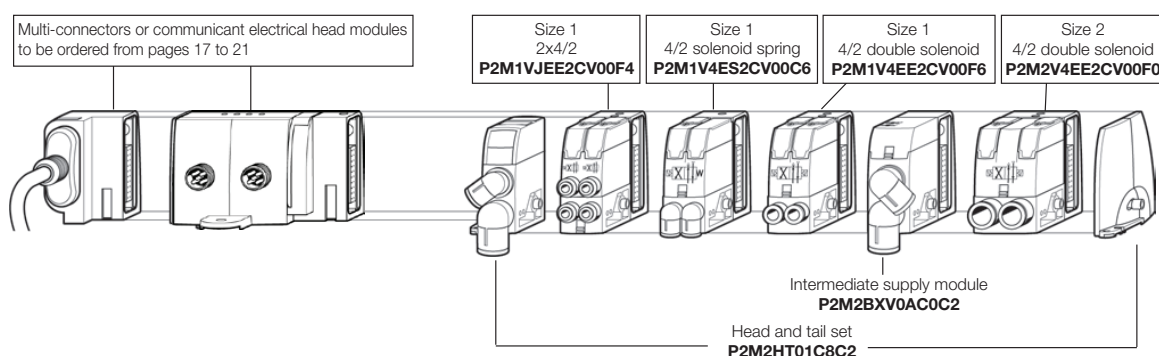

**T series**

See opposite page for complete module order code chart

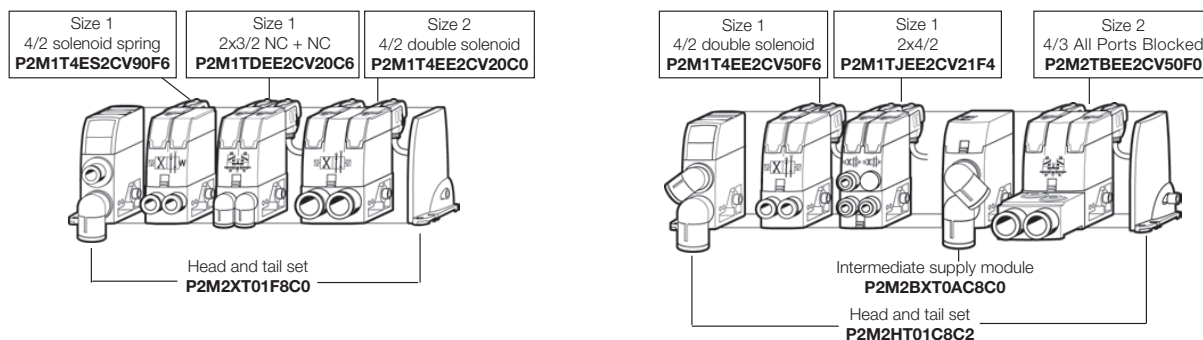

**Special case : the 2 x 4/2 mini-module plug configuration**

For micro-cylinders, this very compact 2 x 4/2 module (order code. JEE) may also be used to obtain 3/2 valves, either Normally Closed or Normally Open.

To do so, the complete module may be supplied with plugs that may replace some of the plug-in connectors. To order, use the top chart from opposite page.

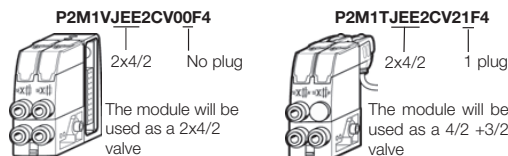

**S and P series**

See page 28 and 29 for complete module order code charts.



Complete Moduflex modules, equipped with their electrical and pneumatic connectors, may be ordered. To do so, use the below chart to define the complete module order codes.

**Valve modules**

1 2 3 4 5 6 7 8 9 10 11 12 13 14 15

**P 2 M 1 V 4 E E 2 C V 0 0 F 6**

Minimum ordering quantity: 10 pieces

Voltage	
00	Pneumatic pilot
2C	24VDC

Pilot Connection & Cable Length	
Valvetronic V Series IP65	
V 0	V Series - Integrated Valvetronic Gallery
T Series - M8 Connector	
0 0	No cable (also for pneumatic remote pilot)
V 2	2 meter cable - M8 connector
V 5	5 meter cable - M8 connector
V 9	10 meter cable - M8 connector
T Series - Clip Connector	
W 0	No cable
W 1	1 meter cable - Clip connector
W 2	2 meter cable - Clip connector
T Series - Pneumatic Remote Pilot	
0 0	4 mm OD tubing

Size	
1	Size 1
2	Size 2

Series	
V	Integrated connections
T	Individual connectors

Valve Function - Solenoid Versions *	
4 ES	4/2 Solenoid spring
4 EE	4/2 Double solenoid
D EE	2 x 3/2NC + NC (with exhaust check valve)
C EE	2 x 3/2 NO + NO (with exhaust check valve)
E EE	2 x 3/2 NC + NO (with exhaust check valve)
3 ES	3/2 NC (with exhaust check valve)
G EE	4/3 centre exhaust (= 2x3/2 without exhaust check valve)
B EE	2x3/2 + clipped dual PO check (= 4/3 APB)

Pneumatic connectors Ports 2 & 4	
Size 1 modules	
F4	Straight 4 mm OD
C4	Elbow 4 mm OD
F6	Straight 6 mm OD
C6	Elbow 6 mm OD
Size 2 modules	
F6	Straight 6 mm OD
C6	Elbow 6 mm OD
F8	Straight 8 mm OD
C8	Elbow 8 mm OD
F0	Straight 10 mm OD
C0	Elbow 10 mm OD

Plug configurations	
0	No plug

Only for JEE 2x4/2 modules (1)	
0	0 plug (2x 4/2)
1	1 plug (4/2 + 3/2)
2	2 plugs (2x3/2 or 1x4/2)
3	3 plugs (1x3/2)

Valve Function - Solenoid Versions *	
J EE	2x4/2 with exhaust check valve with plug configuration

\* For T Series - Pneumatic Pilot: Replace "ES" or "EE" by "PS" or "PP"

**Head/Tail & Intermediate Modules**

Minimum ordering quantity: 10 pieces

1 2 3 4 5 6 7 8 9 10 11 12 13

**P 2 M 2 H X T 0 1 F 0 C 2**

Head and intermediate module	
	<b>HXT01</b> V and T series Pneumatic head and tail set
	<b>BXV0A</b> V series intermediate supply module with a set of 4 configuration plates
	<b>BXT0A</b> T series intermediate supply module with a set of 4 configuration plates

Pressure port connector	
F6	Straight 6 mm OD
C6	Elbow 6 mm OD
F8	Straight 8 mm OD
C8	Elbow 8 mm OD
F0	Straight 10 mm OD
C0	Elbow 10 mm OD
F2	Straight 12 mm OD
C2	Elbow 12 mm OD
PP	Plug
MM	Muffler

Exhaust port connector	
F6	Straight 6 mm OD
C6	Elbow 6 mm OD
F8	Straight 8 mm OD
C8	Elbow 8 mm OD
F0	Straight 10 mm OD
C0	Elbow 10 mm OD
F2	Straight 12 mm OD
C2	Elbow 12 mm OD
PP	Plug
MM	Muffler

Complete Moduflex stand alone valves, equipped with their electrical and pneumatic connectors, may be ordered. To do so, use the below chart to define the complete module order codes.

**Stand alone valve modules**

Minimum ordering quantity: 10 pieces

<b>Size</b>	<b>Series</b>
1 Size 1	S Stand alone valve modules
2 Size 2	

<b>Voltage</b>	
00	Pneumatic pilot
2C	24VDC

<b>Pilot Connection &amp; Cable Length</b>		
<b>M8 Connector</b>		
0	0	No cable
V	2	2 meter cable - M8 connector
V	5	5 meter cable - M8 connector
V	9	10 meter cable - M8 connector
<b>Clip Connector</b>		
W	0	No cable
W	1	1 meter cable - Clip connector
W	2	2 meter cable - Clip connector
<b>Pneumatic Remote Pilot</b>		
0	0	4 mm OD tubing

<b>Valve Function - Solenoid Versions *</b>	
4 ES	4/2 Solenoid spring
4 EE	4/2 Double solenoid
D EE	2 x 3/2NC + NC (with exhaust check valve)
C EE	2 x 3/2 NO + NO (with exhaust check valve)
E EE	2 x 3/2 NC + NO (with exhaust check valve)
3 ES	3/2 NC (with exhaust check valve)
G EE	4/3 centre exhaust (= 2x3/2 without exhaust check valve)
B EE	2x3/2 + clipped dual PO check (= 4/3 APB)

<b>Pneumatic connectors</b>		
<b>Ports 1 &amp; 3</b>	<b>Outlet ports 2 &amp; 4</b>	<b>Tube OD</b>
A Straight & straight	F Straight & straight	<b>Size 1 modules</b>
B Elbow & elbow	C Elbow & elbow	4 4 mm OD
C Straight & muffler	0 No connector for plug-in P module	6 6 mm OD
D Elbow & muffler		<b>Size 2 modules</b>
		6 6 mm OD
		8 8 mm OD
		0 10 mm OD

\* Pneumatic Pilot: Replace "ES" or "EE" by "PS" or "PP"

Size 1  
4/2 solenoid spring  
**P2M1S4ES2CV5CC6**



Size 1  
2x3/2 NC + NC  
**P2M1SDEE2CV2BC6**

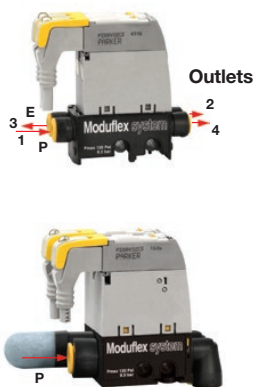

Size 2  
4/2 double solenoid  
**P2M2S4EE2CV9CC8**



Size 2  
2x3/2 NC + NC  
**P2M2SDEE2CV2CC0**



Size 2  
4/3 All Ports Blocked  
**P2M2SBEE2CV2AF0**



PDE2536TCUK

## Moduflex Valve System - P2M

## Moduflex P series complete module order codes

Complete Moduflex peripheral module, equipped with their pneumatic connectors, may be ordered. To do so, use the below chart to define the complete module order codes.

### Dual flow control, dual pilot operated check valve, and pressure regulator peripheral modules

Minimum ordering quantity: 10 pieces

Order Code: **P 2 M 1 P X F A J J F 6**

Peripheral module function	
<b>FA</b>	Dual flow control
<b>CA</b>	Dual P.O. check valve
Pressure regulators	
<b>SR</b>	0-2 bar, with pressure gauge
<b>SM</b>	0-4 bar, with pressure gauge
<b>SG</b>	0-8 bar, with pressure gauge

Size	
<b>1</b>	Size 1
<b>2</b>	Size 2

Inlet port pneumatic connectors	
Size 1 modules	
<b>F4</b>	Straight 4 mm OD
<b>C4</b>	Elbow 4 mm OD
<b>F6</b>	Straight 6 mm OD
<b>C6</b>	Elbow 6 mm OD
Size 2 modules	
<b>F6</b>	Straight 6 mm OD
<b>C6</b>	Elbow 6 mm OD
<b>F8</b>	Straight 8 mm OD
<b>C8</b>	Elbow 8 mm OD
<b>F0</b>	Straight 10 mm OD
<b>C0</b>	Elbow 10 mm OD

Outlet port pneumatic connectors	
Size 1 modules	
<b>F4</b>	Straight 4 mm OD
<b>C4</b>	Elbow 4 mm OD
<b>F6</b>	Straight 6 mm OD
<b>C6</b>	Elbow 6 mm OD
Size 2 modules	
<b>F6</b>	Straight 6 mm OD
<b>C6</b>	Elbow 6 mm OD
<b>F8</b>	Straight 8 mm OD
<b>C8</b>	Elbow 8 mm OD
<b>F0</b>	Straight 10 mm OD
<b>C0</b>	Elbow 10 mm OD

### Vacuum generator peripheral module

Minimum ordering quantity: 10 pieces

Order Code: **P 2 M 1 P X V A F 6 A F 6 C M A**

Peripheral module function	
<b>VA</b>	Vacuum generator

Size	
<b>1</b>	Size 1

Exhaust port (3) *	
<b>F4</b>	Straight 4 mm OD
<b>C4</b>	Elbow 4 mm OD
<b>F6</b>	Straight 6 mm OD
<b>C6</b>	Elbow 6 mm OD
<b>MA</b>	Clip-on muffler

Pressure & Blow-off port connectors	
<b>JJ</b>	Clip-on double male union
<b>F4</b>	Straight 4 mm OD
<b>C4</b>	Elbow 4 mm OD
<b>F6</b>	Straight 6 mm OD
<b>C6</b>	Elbow 6 mm OD
<b>F1</b>	Straight threaded 1/8"
<b>C1</b>	Elbow threaded 1/8"

Vacuum and Vacuum Sensor port connectors	
<b>F4</b>	Straight 4 mm OD
<b>C4</b>	Elbow 4 mm OD
<b>F6</b>	Straight 6 mm OD
<b>C6</b>	Elbow 6 mm OD
<b>F1</b>	Straight threaded 1/8"
<b>C1</b>	Elbow threaded 1/8"

Vacuum and Vacuum Sensor port connectors	
<b>A</b>	2 similar connectors
<b>B</b>	1 connector on vacuum port 1 plug on vacuum sensor port
<b>D</b>	1 Connector on Vacuum Port 1 Dig/Ana Vacuum Sensor MPS-V34G-PCI
<b>E</b>	1 Connector on Vacuum Port 1 Analog Vacuum Sensor MPS-V8T-AG

PDE2536TCUK

## Moduflex Valve System - P2M

### Island head module port sizing

Moduflex is totally flexible: islands may have up to 19 valves for the V Series and is not limited for the T series with a choice of 3 valve sizes, depending on the required flow. Thus, each island has specific needs for the size of its pressure supply and its exhaust collection.

### Choice of connections to an island P and E ports

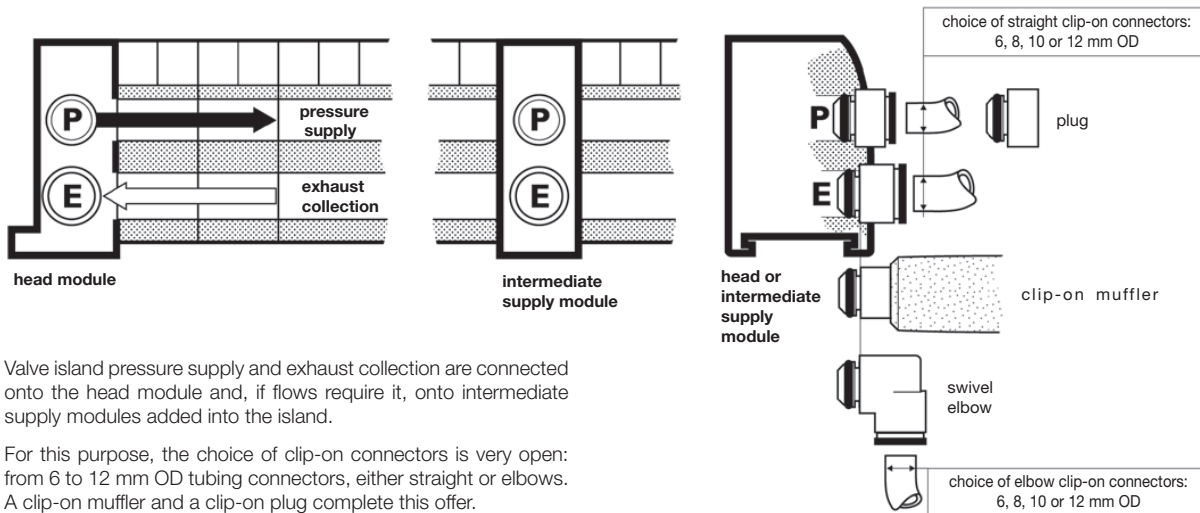

Valve island pressure supply and exhaust collection are connected onto the head module and, if flows require it, onto intermediate supply modules added into the island.

For this purpose, the choice of clip-on connectors is very open: from 6 to 12 mm OD tubing connectors, either straight or elbows. A clip-on muffler and a clip-on plug complete this offer.

### Sizing recommendations

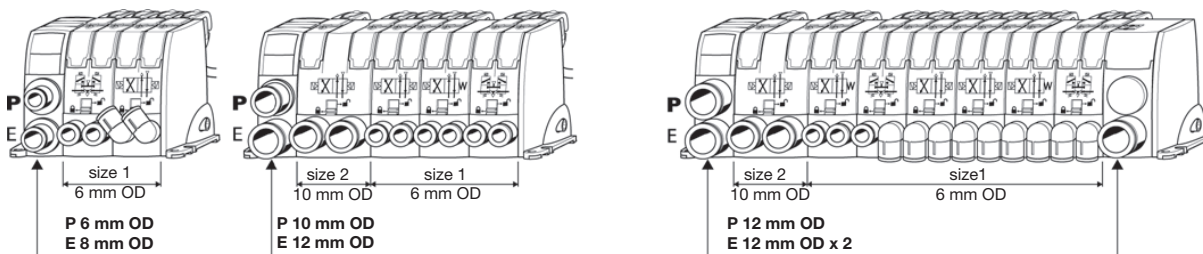

The 3 valve islands above present typical situations for sizing islands pressure supply and exhaust collection.

In a given island, valves do not deliver their flow at the same moment. Thus, the number of valves in an island is not the major factor to consider. More important is the size of the largest valve and of the largest output tubes to the cylinders.

We would recommend the following:

- air supply connection at least equivalent to largest output tube to cylinders;
- exhaust collection at least twice the section area of the largest output tube to cylinders.

For islands with high flows, the following options are possible:

- use tubes up to 12 mm OD or mufflers providing exhaust collection is not necessary;
- provide additional P and/or E connection ports by inclusion of intermediate supply modules, thus keeping tube size small.

At the machine commissioning stage, the supply and exhaust connections can be easily modified until the required performance is achieved.

#### ID section areas of standard tubings

2 x 4 mm: 3 mm <sup>2</sup>	5.5 x 8 mm: 24 mm <sup>2</sup>	10 x 12 mm: 80 mm <sup>2</sup>
2.7 x 4 mm: 6 mm <sup>2</sup>	6 x 8 mm: 28 mm <sup>2</sup>	
4 x 6 mm: 12 mm <sup>2</sup>	7 x 10 mm: 40 mm <sup>2</sup>	muffler: 100 mm <sup>2</sup>
	8 x 10 mm: 50 mm <sup>2</sup>	equivalent

PDE2536TCUK

## Moduflex Valve System - P2M

### Recommendations for building machines with imperial OD tubes (US usual standard)

#### size 1 modules

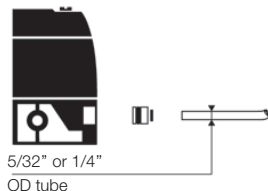

Moduflex is a global product available in the US with the two standards that are commonly used in this country:

- metric OD tubes with the metric connectors shown in this catalogue,
- imperial OD tubes with specific connectors for the US.

Machine builders exporting to the US may propose to their clients one of the following solutions.

- Machines equipped with Moduflex components connected with metric tubes found in this catalogue. Parker will provide products locally for maintenance.
- Or machines equipped with Moduflex components connected with imperial size OD tubes. In this case, use the following procedure to order Moduflex and to build the machine.

#### size 2 modules

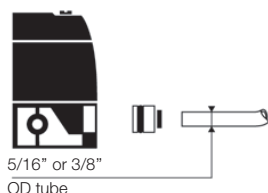

#### Imperial OD tube and metric OD tube comparison

metric standard tube OD	imperial US standard tube OD	metric equivalent	Moduflex clip-on connectors
4 mm	5/32"	4 mm	imperial and metric connectors identical
6 mm	1/4"	6,35 mm	specific imperial connector
8 mm	5/16"	8 mm	imperial and metric connectors identical
10 mm	3/8"	9,53 mm	specific imperial connector
12 mm	1/2"	12,7 mm	specific imperial connector

#### head and intermediate island modules

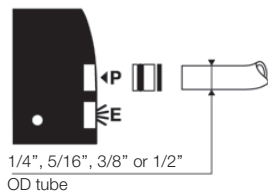

#### Moduflex selection for imperial size OD tubes

Such components will easily be obtained with the following procedure:

- 1 - select the required basic modules (with no connector).

- 2 - Select from the list below the clip-on connectors for the required imperial OD tubes.

- 3 - ports in order to obtain complete modules.

FMD04-1



FMD07-1



#### pneumatic connectors for size 1 modules

		Pack Quant.	elbow version Weight (g) per unit	Order code	straight version Weight (g) per unit	Order code
clip-on tube push-in connector	5/32"= 4 mm OD	10	5	<b>CMD04-1</b>	2	<b>FMD04-1</b>
	1/4"OD	10	5	<b>CMD07-1</b>	3	<b>FMD07-1</b>

CMD04-1



CMD07-1



FMD07-2



FMD13-2



#### pneumatic connectors for size 2 modules head and intermediate island modules

		Pack Quant.	elbow version Weight (g) per unit	Order code	straight version Weight (g) per unit	Order code
clip-on tube push-in connector	1/4"OD	10	5	<b>CMD07-2</b>	3	<b>FMD07-2</b>
	5/16"= 8 mm OD	10	6	<b>CMD08-2</b>	4	<b>FMD08-2</b>
	3/8"OD	10	7	<b>CMD09-2</b>	5	<b>FMD09-2</b>
	1/2"OD	10	8	<b>CMD13-2</b>	6	<b>FMD13-2</b>

CMD13-2



**Maintenance procedure**

The latest generations of compact pneumatic valves have a life expectancy which generally exceeds the equipment they control. Therefore, although maintenance is seldom required,

when necessary the solenoid pilot, valve or connector can be easily replaced without removing the island base, as shown below.

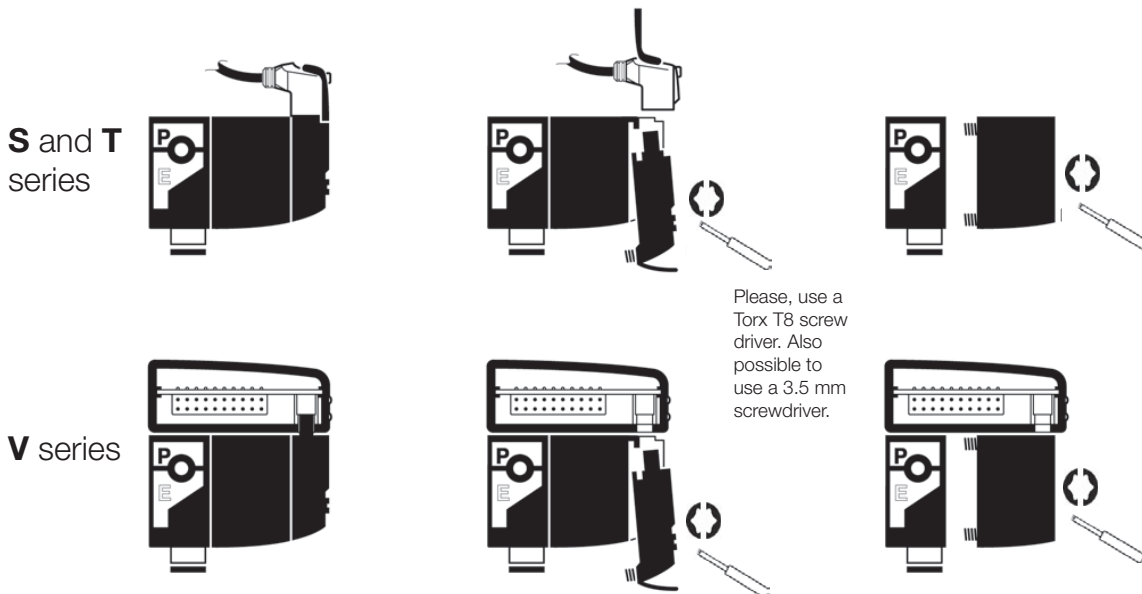

**With only one universal solenoid pilot for all configurations, maintenance is simple**

24V DC is now a global standard for all machines.







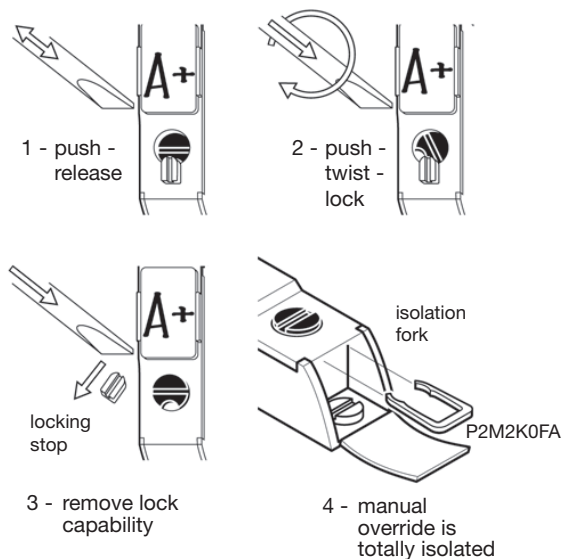

The Moduflex 24V DC unique solenoid pilot is supplied with the multi-function manual override that can be adapted to all requirements, as explained by the drawings.

Because all Moduflex valve and island configurations are supplied with this unique solenoid pilot, maintenance operations remain very simple.

**Multi-function adaptable manual override**



**Maintenance components**

	Valve pilot	Connection	Weight (g)	Order code	
  	Solenoid pilot	M8 - 3 Pins - IP67	15	<b>P2D8V32C5</b>	
		Clip connector - 2 pins - IP40 With LED and voltage surge suppression	15	<b>P2D2W3226C5</b>	
	Pneumatic pilot	4 mm OD tubing push-in elbow fitting	10	<b>P2M2K0PA</b>	
<b>size 1 valve modules without solenoid pilot and without sub-base</b>			Weight (g)	Order code	
	4/2	monostable	26	<b>P2M1X4ES</b>	
		bistable	25	<b>P2M1X4EE</b>	
	3/2	double NC + NC	28	<b>P2M1XDDE</b>	
		double NO + NO	28	<b>P2M1XCEE</b>	
		double NC + NO	28	<b>P2M1XEEE</b>	
		single NC	25	<b>P2M1X3ES</b>	
	4/3 CE	double 3/2 NC + NC without exhaust check valve	28	<b>P2M1XGEE</b>	
	<b>size 2 valve modules without solenoid pilot and without sub-base</b>			Weight (g)	Order code
	4/2	monostable	28	<b>P2M2X4ES</b>	
		bistable	30	<b>P2M2X4EE</b>	
	3/2	double NC + NC	32	<b>P2M2XDDE</b>	
		double NO + NO	32	<b>P2M2XCEE</b>	
		double NC + NO	32	<b>P2M2XEEE</b>	
		single NC	28	<b>P2M2X3ES</b>	
	4/3 CE	double 3/2 NC + NC without exhaust check valve	32	<b>P2M2XGEE</b>	
	<b>Set of maintenance parts</b>			Weight (g)	Order code
	Seals	Set of various seals: 3 under solenoid pilot seals 3 inter island base seals 2 for dual 4/2 valves (2 parts) 2 for single and dual 3/2 – Size 1 – valves 2 for single 4/2 – Size 1 – valves 2 for size 2 valves (all functions)	8	<b>P2M2K0JA</b>	
		Fitting locking clips	Set of 14 clips: 4 for dual 4/2 valves 6 for size 1 valves 2 for size 2 valves 2 for intermediate supply modules	10	<b>P2M2K0CA</b>
			Manual override forks	Set of 10 isolating forks for pilot solenoid manual override	8

**1 - Multi-connector or sub-D 25 valve island**

Multi-connector or sub-D 25 electrical head module width: 15 mm	Head and tail pneumatic module set width: 48 mm	Modules size 1 width: 25 mm	Modules size 2 width: 37.5 mm	Intermediate module width: 25 mm
---	---	-----------------------------	-------------------------------	----------------------------------

Island total width depending on valve composition

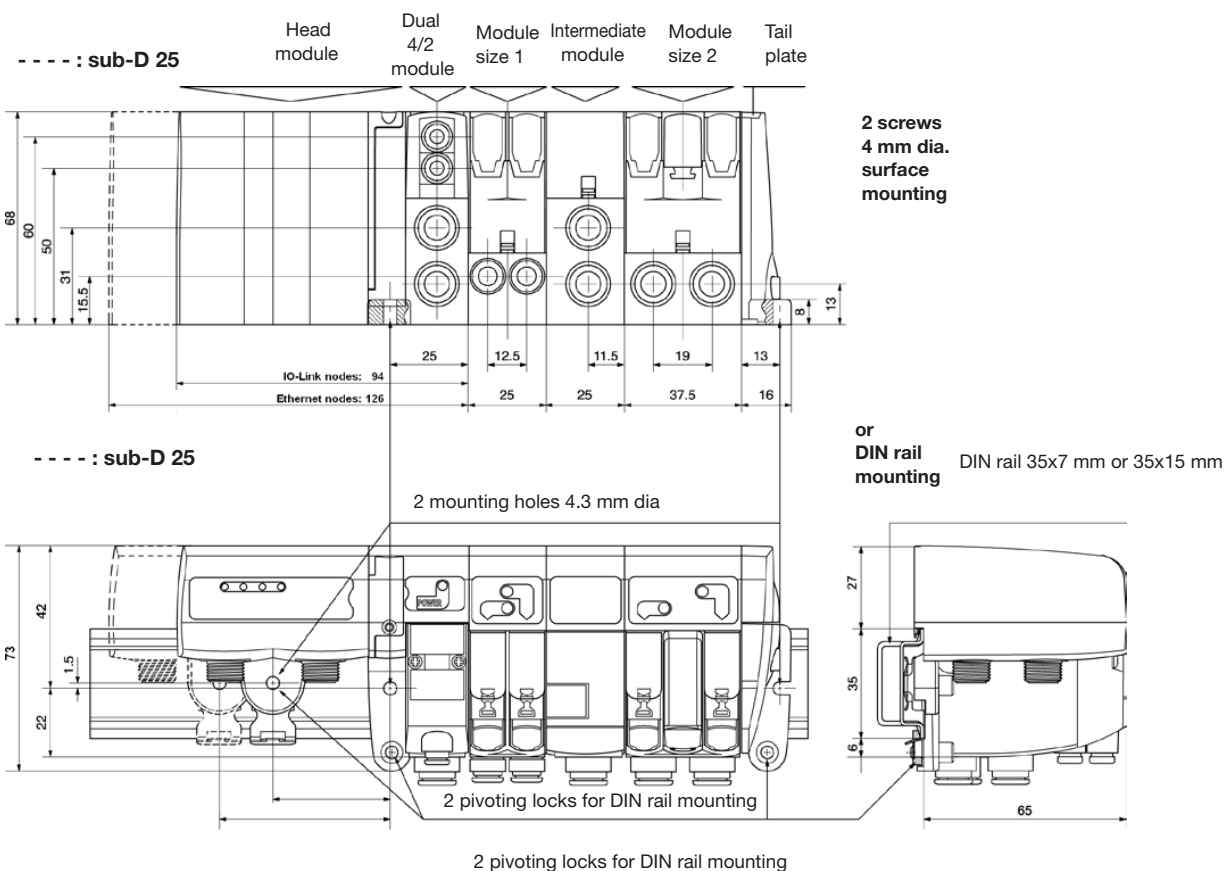
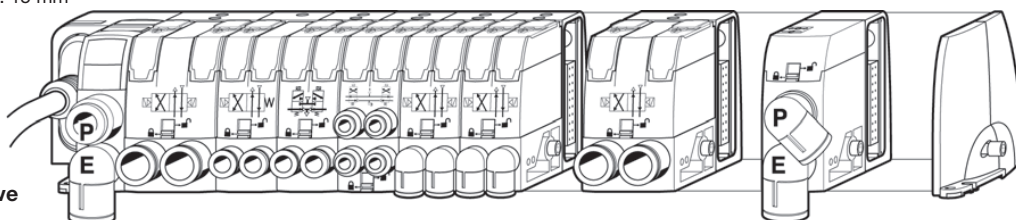

Special case: 4/3 closed centre function within island version:  
Add the dimensions of the dual P.O. check valve module plugged into the island. See pages 39 and 40 for dimensions.

Island head and intermediate modules

	a	b	c
6 mm tube OD	8	13	16
8 mm tube OD	9	16	19
10 mm tube OD	13	18	22
12 mm tube OD	13	19	25
Muffler		40	

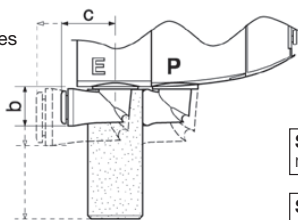

Island valves modules

	OD tube	a	b	c
Size 1 modules	4 mm	8	10	12
	6 mm	8	13	16
Size 2 modules	8 mm	9	16	19
	10 mm	13	18	22

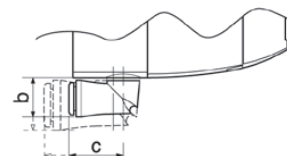



PDE2536TCUK

## Moduflex Valve System - P2M

## T series - Dimensions and mounting

Island total width depending on valve composition

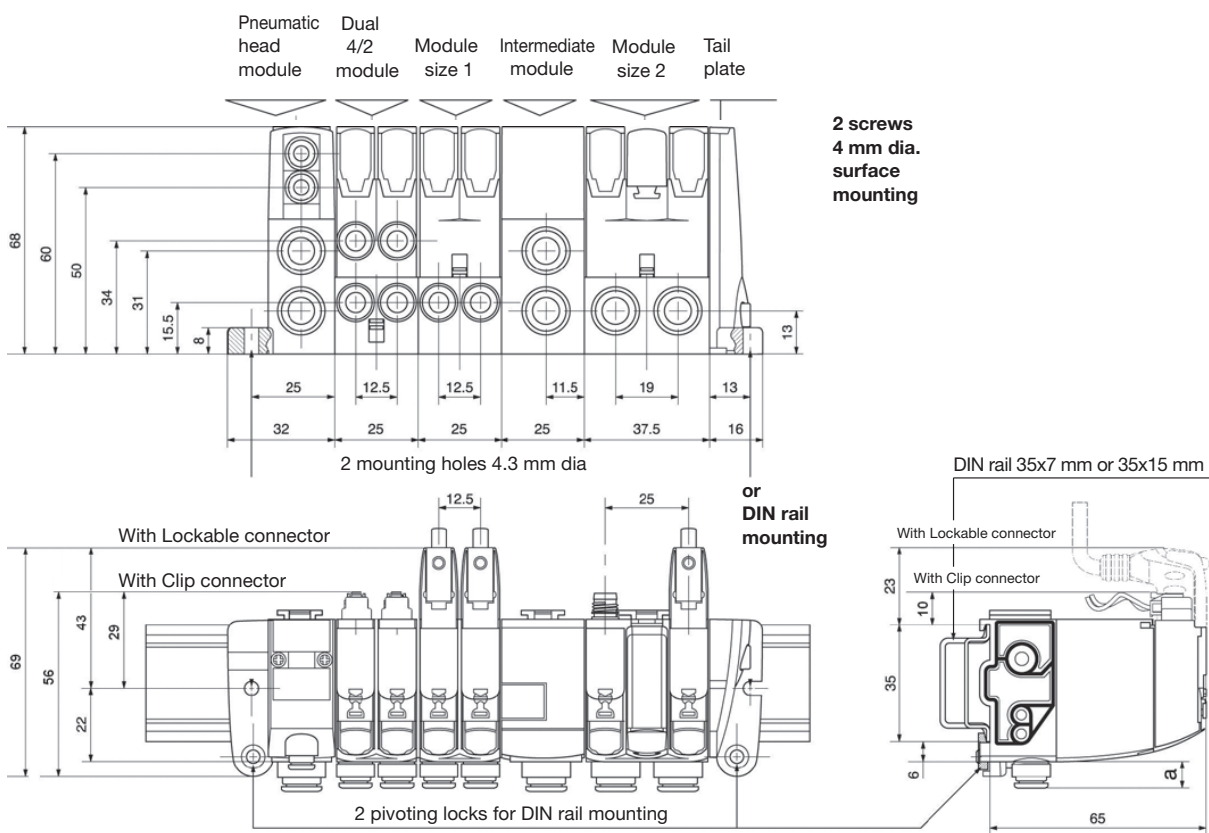
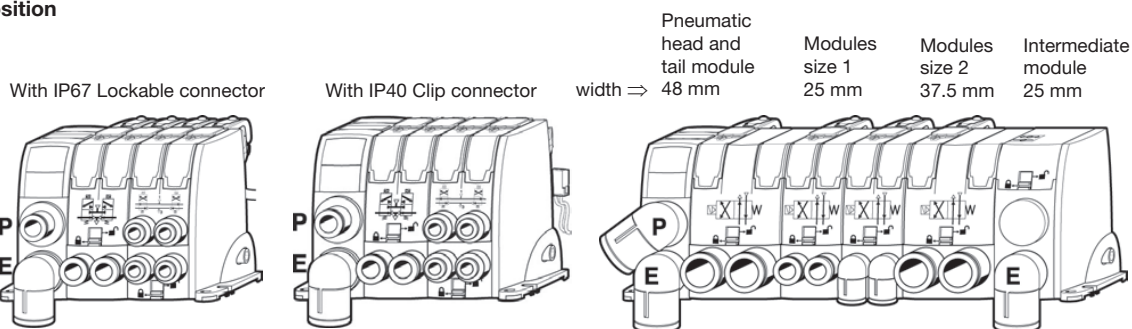

Special case : 4/3 closed centre function within island version:  
Add the dimensions of the dual P.O. check valve module plugged into the island.

Island head and intermediate modules

	a	b	c
6 mm tube OD	8	13	16
8 mm tube OD	9	16	19
10 mm tube OD	13	18	22
12 mm tube OD	13	19	25
Muffler		40	

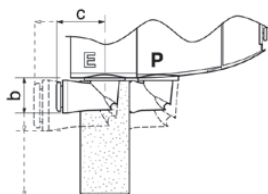

Island valves modules

	OD tube	a	b	c
Size 1 modules	4 mm	8	10	12
	6 mm	8	13	16
Size 2 modules	8 mm	9	16	19
	10 mm	13	18	22

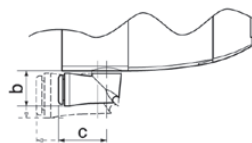

PDE2536TCUK

## Moduflex Valve System - P2M

## S series - Dimensions and mounting

### Stand-alone valve size 1



surface mounting with screws  
4 mm dia. into retractable brackets 3 mm thick

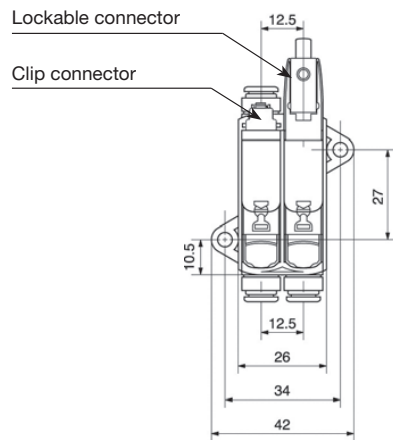

or side mounting with 2 screws 4 mm dia.

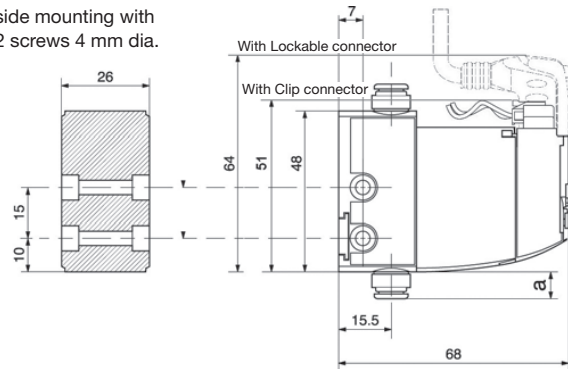

### Stand-alone valve size 2

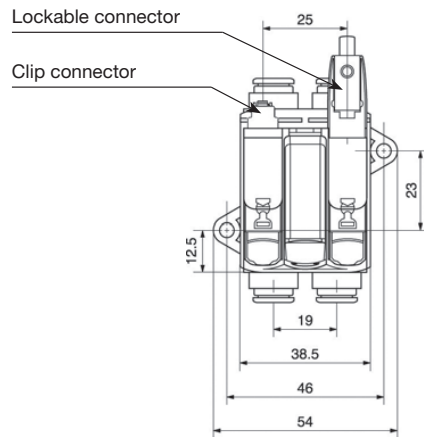

or side mounting with 2 screws 4 mm dia.

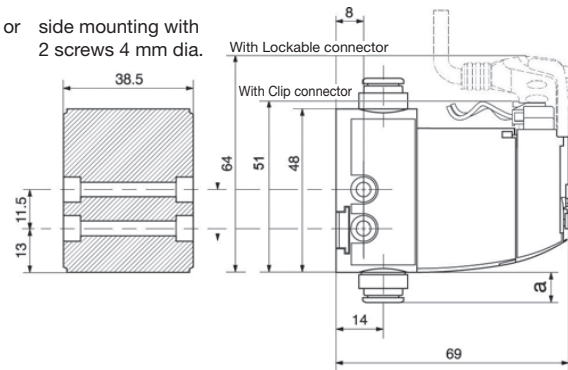

Dimensions and mountings of the stand-alone valves 4/2, double and single 3/2, 4/3 vented centre and 4/3 pressure centre.

Special case : 4/3 closed centre. Add the dual P.O. check valve module that has been plugged in the basic valve.

		a	b	c
Size 1 modules	4 mm tube OD	8	10	12
	6 mm tube OD	8	13	16
	Muffler		31	
Size 2 modules	8 mm tube OD	9	16	19
	10 mm tube OD	13	18	22
	Muffler		40	

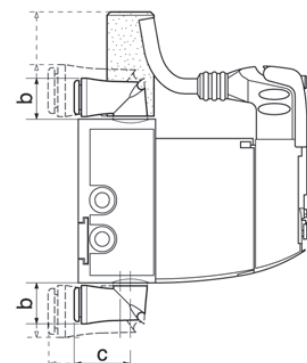

PDE2536TCUK

## Moduflex Valve System - P2M

## P series - Dimensions and mounting

**Reminder:** peripheral modules may either be plugged in a valve or an island



### Dual flow control module size 1

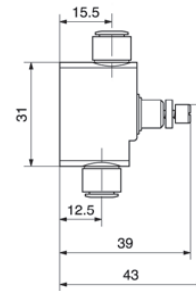
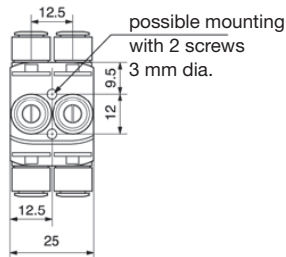
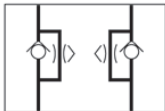

### Pressure regulation module size 1

- with gauge

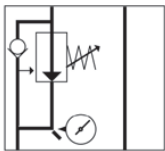

mounting with 2 screws 4 mm dia. on retractable brackets

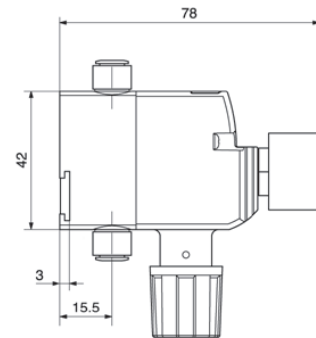
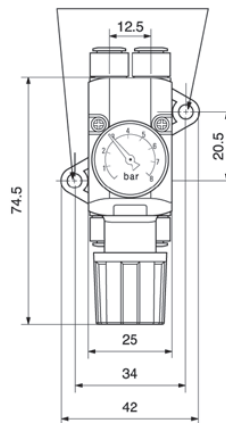

- without gauge

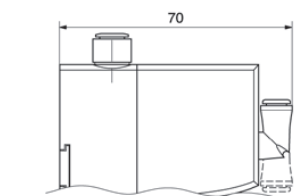
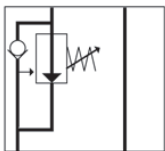

swivel elbow push-in connector 4 mm OD tube

### Dual P.O. check valve module size 1

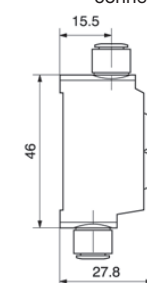
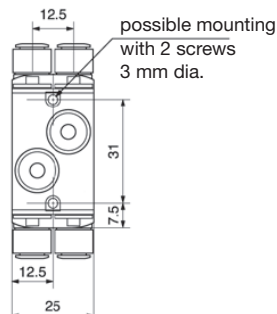
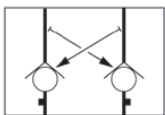

PDE2536TCUK

**Moduflex Valve System - P2M**

**P series - Dimensions and mounting**

**Dual flow control module size 2**

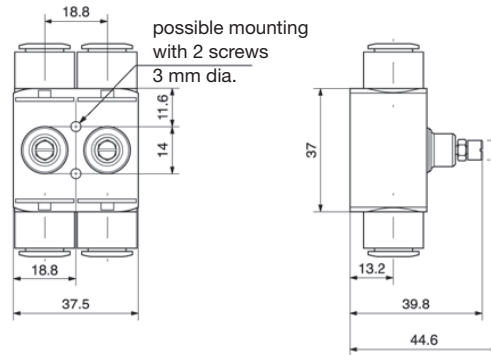
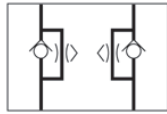

**Pressure regulation module size 2**

- with gauge

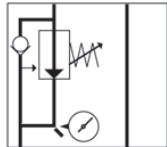

mounting with 2 screws 4 mm dia.  
on retractable brackets

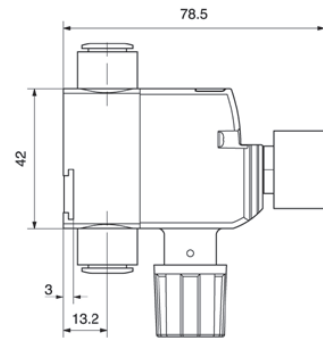
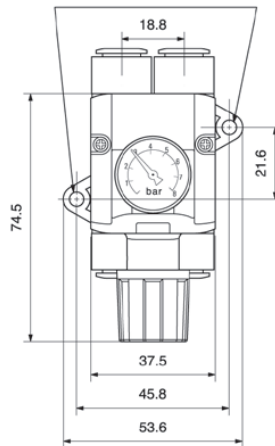

- without gauge

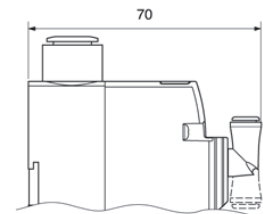
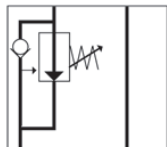

swivel elbow push-in  
connector 4 mm OD tube

**Dual P.O. check valve module size 2**

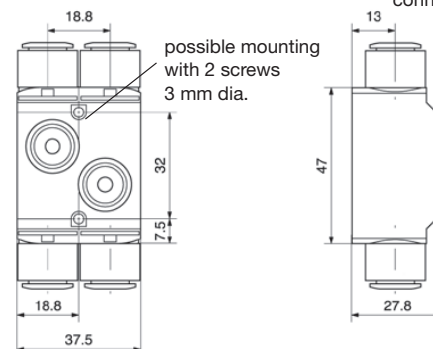
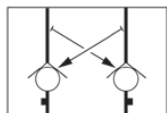

PDE2536TCUK

**Moduflex Valve System - P2M**

**P series - Dimensions and mounting**

**Vacuum generator module**

In-line

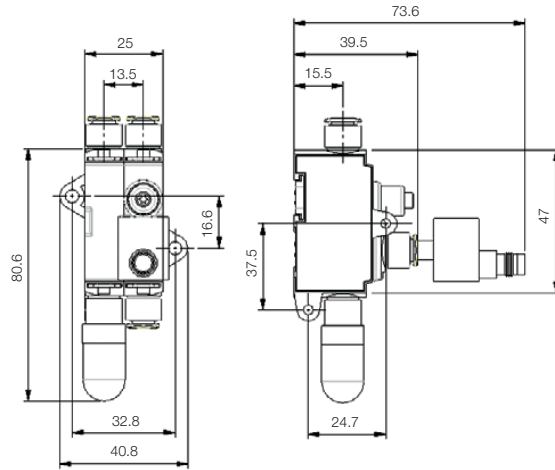

**With Moduflex valve**

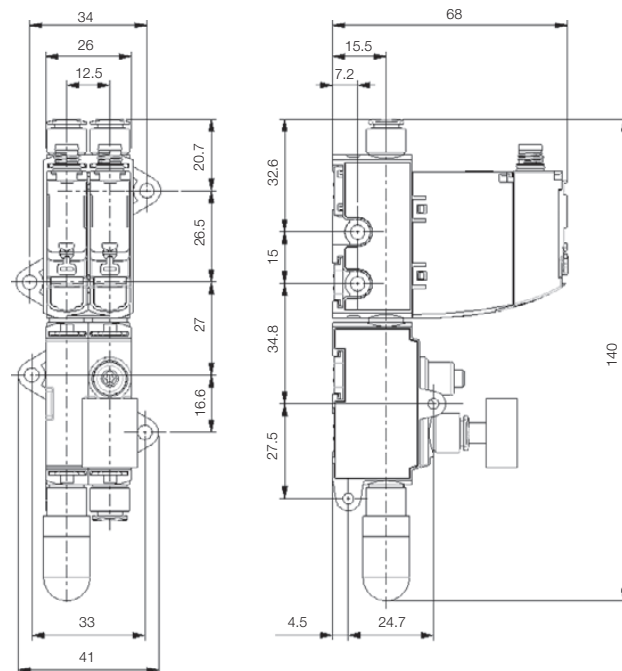

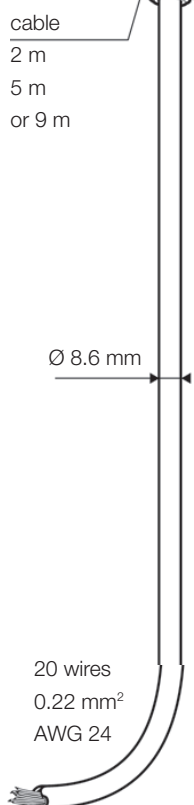
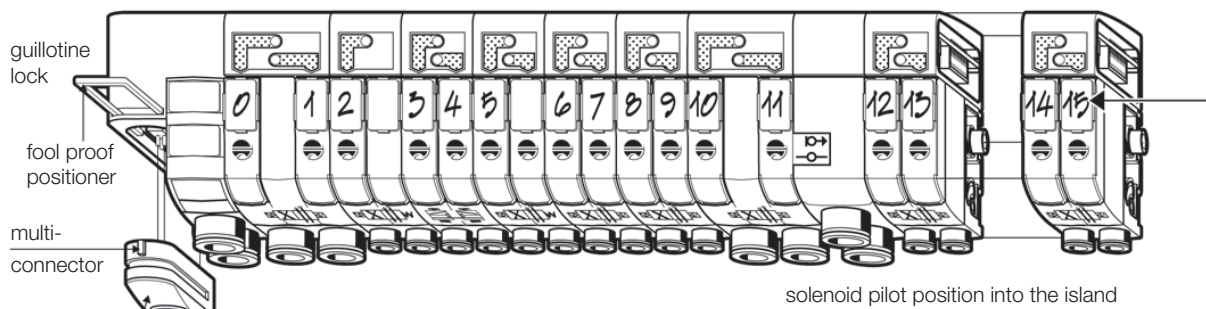

### The valve island head multi-connector

On the island head module, the multi-connector integrates the HE10 connector standard in its 20 pin version. Its plug-in function is secured in position with a guillotine lock with easy access from the front of the island. Just like the whole island, the multi-connector follows the IP65 protection standard.

#### Cable specification:

8,6 mm dia., UL, 20 wires, 0.22 mm<sup>2</sup>, AWG 24.

Minimum static radius : 6.5 mm.

Available with 2 m, 5 m and 9 m lengths.

### Multi-connector addressing

When assembling a V series island, modules are automatically connected to the head module through the modular principle of the integrated electrical connections.

The colour code addressing given below conforms to the DIN 47100 standard.

To each wire colour code corresponds a solenoid pilot position in the island.

solenoid pilot position into the island		
colour code	colour code	colour code
0 pink - brown	7 white - green	14 grey
1 white - pink	8 red - blue	15 yellow
2 grey - brown	9 grey - pink	16 green
3 white - grey	10 violet	17 brown
4 yellow - brown	11 red	18 white
5 white - yellow	12 blue	
6 brown - green	13 pink	common: black

### Sub-D 25 addressing

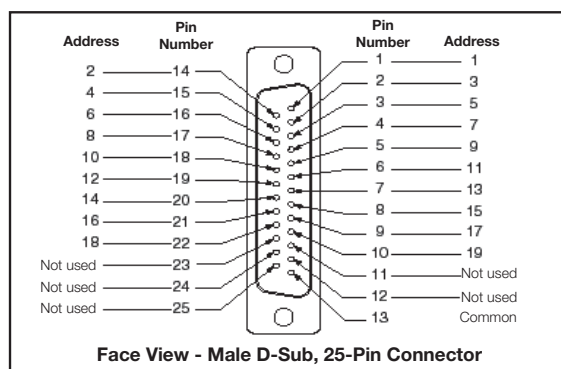
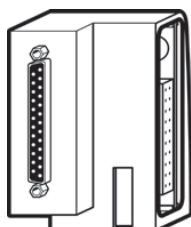

**Industrial Ethernet node connection and diagnostic functions**

**Ethernet Ports and Auxiliary Power Connection**

Ethernet ports: 2 x Standard Female M12 D-Coded – 5 pins  
 Auxiliary Power: Standard Male M12 A-Coded – 4 pins.  
 Usage of standard manufactured cables available from your usual electrical supplier is recommended.

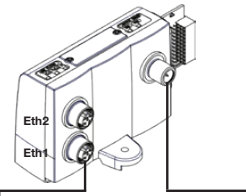

Eth. 1 & 2 – Female M12 D-Coded			Aux. Power – Male M12 A-Coded		
PIN #	Description		PIN #	Description	
1	TxData +		1	Logic Power +	
2	RxData +		2	AUX Power -	
3	TxData -		3	Logic Power -	
4	RxData -		4	AUX Power +	
5	na				

**Configuration File**

The configuration files can be download from the product web page: [www.parker.com/pde/P2M\\_IE](http://www.parker.com/pde/P2M_IE).

**IP Address Setting**

The IP-Address of the device can be assigned via:

- Rotary Switches, DHCP, Web page, Ipconfig Tool or TCP/IP Interface Object, depending on protocol version:

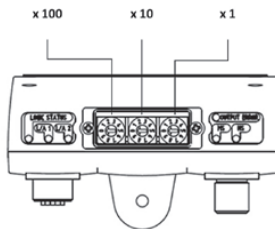

Description	EtherNet/IP Profinet IO Modbus TCP/IP	Ethernet PowerLink	EtherCAT	CC-Link IE
IP-Address setting stored into the NV-memory of the P2M node	000	000	N/A	000
IP-Address setting determined by the 3 rotary switches:				
• IP Address: 192.168.1.xxx	001 – 254	001 – 239	N/A	001 – 120
• Subnet Mask: 255.255.255.0				
• Default Gateway for 001: 192.168.1.2				
• Default Gateway for 002 - 254: 192.168.1.1				
The device will obtains its address via DHCP	888	N/A	N/A	N/A
Reset to factory status	999	999	999	999
Invalid. The module will not start (see Local Visual Diagnostic section for details)	All others	All others	All others	All others

**Case of Use with SAFE Power Source for Valve Control**

The P2M Industrial Ethernet 24 DO nodes can support a SAFE OSSD power source for valve control (Aux + / Aux -). It can also be connected in both PP or PM mode.

For further details, please refer to the Ethernet node user manual available from the product web page:

- [www.parker.com/pde/P2M\\_IE](http://www.parker.com/pde/P2M_IE)

**Local and network diagnostic functions**

**Local diagnostic**

The P2M Industrial Ethernet node offers a local diagnostic via 7 LED's. Pls refer to user manual with interpretation given by this table.

**Network diagnostic**

The P2M Industrial Ethernet node offers additional useful module status information:

- Pilot overload or short circuit
- Auxiliary Voltage out of tolerance
- Cycle counter for every pilot
- Module temperature
- ...

For deeper information on product technical information and a complete interpretation of node diagnostic functionalities, please refer to the User Manual available from the product web page:

[www.parker.com/pde/P2M\\_IE](http://www.parker.com/pde/P2M_IE)

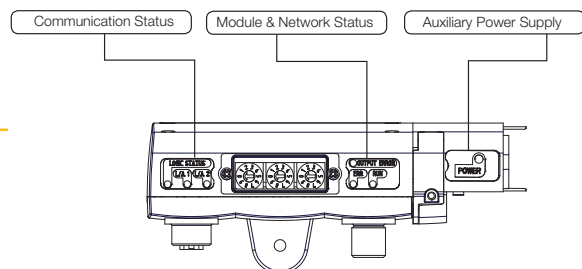

**EtherNet/IP**



**EtherCAT**

**ETHERNET POWERLINK**



**Industrial Ethernet Lite Node connections and diagnostic functions**

**Ethernet and Power Connections**

**Network Communication Ports:**

2 x Standard RJ45 Female connectors

Usage of standard manufactured cables available from your usual electrical supplier is recommended.

**Power Supply:**

Standard 3-Pin Male Connector - 3,81 mm pitch

**Working mode selector:**

DIP-switch

**Configuration Files**

The configuration files can be download from the product web page: [www.parker.com/pde/P2M\\_IE](http://www.parker.com/pde/P2M_IE)

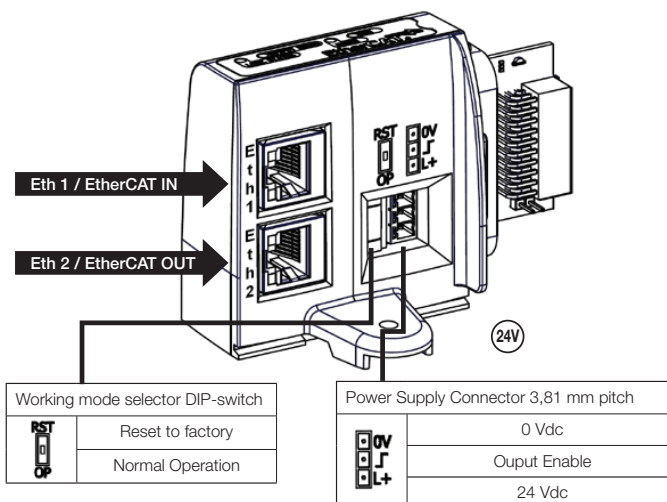

**IP Address Setting**

For both Profinet IO and EtherNet/IP protocols, the P2M Lite 24DO Node is by default in DHCP mode. The module must be assigned to a static IP-Address in order to be controlled via network. Please, refer to the user manual for IP-Address assignment process.

**Local and Network diagnostic functions**

**Local diagnostic**

The P2M Lite 24DO node offers a local diagnostic via 9 LED's. Please refer to user manual with interpretation table.

**Network diagnostic**

The P2M Lite 24DO Node offers additional useful module status information:

- Pilot overload or short circuit
- Power Voltage out of tolerance
- Cycle counter for every pilot
- Module temperature
- ...

For detailed technical information on the P2M Lite 24DO Node and a complete interpretation of node's diagnostic functionalities, please refer to the User Manual available from the product web page:

[www.parker.com/pde/P2M\\_IE](http://www.parker.com/pde/P2M_IE)

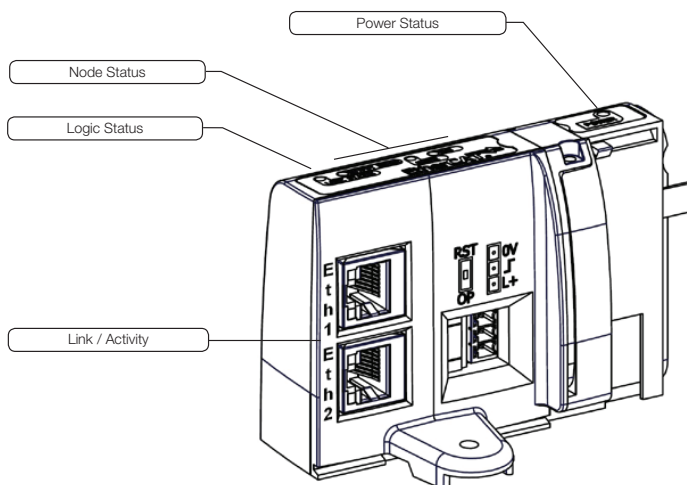

**EtherNet/IP™**

**PROFI INDUSTRIAL ETHERNET NET**

**EtherCAT®**

**IO-Link module connection and diagnostic functions**



**IO-Link module connection**

Standard male M12 – type A

Usage of standard manufactured cables available from your usual electrical supplier is recommended.

Note: Auxiliary power for solenoids can be wired separately allowing users to turn outputs off while the communications remains active.

**Configuration**

IODD file can be downloaded from IODD Finder or the Moduflex web site:  
<https://ioddfinder.io-link.com>  
[www.parker.com/pde/io-link](http://www.parker.com/pde/io-link)

**Class B**



**Class A**

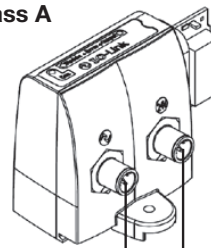

**Legend**

Symbol	Description
L+	IO-Link Power Supply "+"
L-	IO-Link Power Supply "-"
C/Q	IO-Link communication
Aux +	Auxiliary Power Supply 24 Vdc
Aux -	Auxiliary Power Supply 0 Vdc

M12 Pin's	Class A		
	3 Pin's		5 Pin's
	P2M...A13	P2M...A43	P2M...A42
1	L+	Not used	Not used
2	Aux +	Aux -	Aux -
3	L-	Aux -	Not used
4	C/Q	Aux +	Aux +
5	Aux -	-	Not used

**Case of use with SAFE cabling**

The Moduflex IO-Link Module can be powered from a 24Vdc auxiliary source in PP or PM mode as grounds are isolated.

IO-Link nodes Class A & B -SPC version are compatible with SAFE OSSD power source for valve control (Aux + / Aux -). For further details, please refer to the user manual N. 30048690201W05.

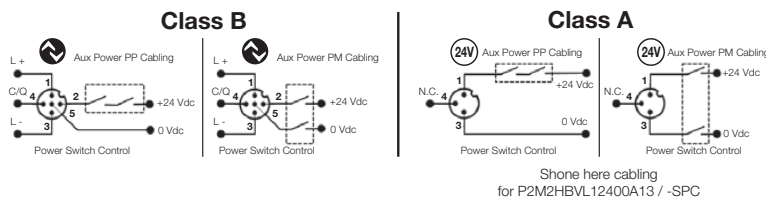

**IO-Link module diagnostic functions**

The P2M IO-Link node offers additional useful module status information:

- Pilot overload or short circuit
- Auxiliary Voltage out of tolerance
- Cycle counter for every pilot
- Module temperature

For deeper information on product technical information and node diagnostic functionalities, please refer to the User Manual available from the product web page:

[www.parker.com/pde/io-link](http://www.parker.com/pde/io-link)

COM Green LED			Module—Error Red LED			Error—Output Red LED			POWER Green LED		
LED Status	Description	Solving	LED Status	Description	Solving	LED Status	Description	Solving	LED Status	Description	Solving
OFF	IO-Link L+ / L- not powered	Check connection	OFF	Standard mode	NA	OFF	Standard mode	NA	OFF	AUX power failure	Check Auxiliary Power Supply
ON	IOL L+ / L- powered IO mode	Set IO-Link mode in IO-Link master	ON	24 Vdc AUX power missing or any active malfunction	Check power supply or change module	ON	Any driver error (overload, over temperature, etc.)	Fix solenoid issue then acknowledge error	ON	Standard	NA
Blinking	IO-Link communication active	NA							Blinking	Aux Power is out of range, alarm level	Check Auxiliary Power Supply

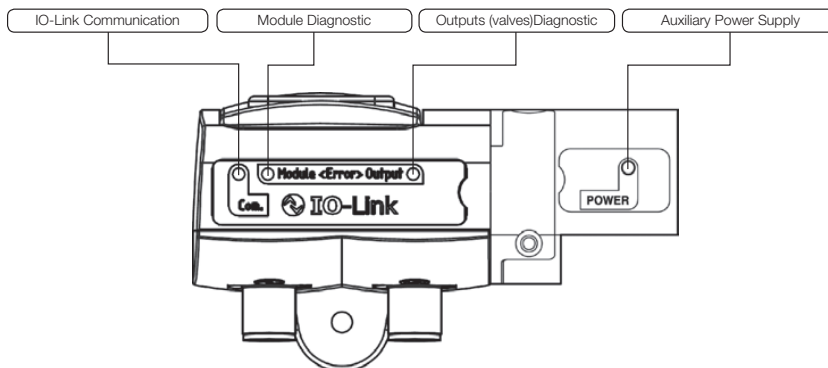

# Moduflex Valve System

## V series

Integrated connection industrial comms or multi-connector valve island



## T series

Individual connector valve islands  
Solenoid clip or lockable connector or remote air pilot



## S series

Stand alone valves  
Solenoid clip or lockable connector or remote air pilot



## P series

Peripheral modules  
Flow control, check valves, pressure regulator, vacuum

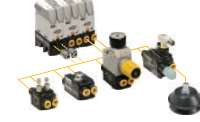

### 1 Industrial communication node head module

Protocol	IP	Nb of DOs	
		Class A - Power	Class B - Power
IO-Link	IP65	Class A - Power 1 - 3	24 DO* P2M2HBVL12400A13 / SPC
		Class A - Power 4 - 2	24 DO* P2M2HBVL12400A2 / SPC
		Class B - Power 2 - 5	24 DO* P2M2HBVL12400B25 / SPC
Industrial Ethernet	IP20	Profiled IO	24 DO* P2M2HBVL12400R1
		EtherNet/IP	24 DO* P2M2HBVL12400R2
		EtherCAT	24 DO* P2M2HBVL12400R3
IP65	IP65	PowerLink	24 DO* P2M2HBVL12400
		Modbus TCP/IP	24 DO* P2M2HBVM12400
		CC-Link IE	24 DO* Coming soon

\* Only the first 19 DO usable with Moduflex Valve

### 1 Island head and intermediate module sets

Description	Size 2	
	V series	T series
Valve island pneumatic head and tail module set	P2M2HXT01	P2M2HXT01
Valve island intermediate supply module with a set of 4 configuration plates	P2M2BXV0A	P2M2BXT0A

### 1 Electrical multi-connector head module

Description	Protection	Cable length	Part number
Guillotine type	IP65	2 m	P2M2HEV0A
		5 m	P8LMH20M2A
		9 m	P8LMH20M2A
Standard Sub-D 25 type	IP40	3 m	P2M2HEV0D
		9 m	P8LMH25M2A
		9 m	P8LMH25B2A

### 1 Electrical connectors

Description	Connector type	Cable length	Part number
Individual lockable connector - IP67 Including LED and surge protection 2 Flying leads	M8 / 2 x Flying leads	2 m	P8LS08L26C
		5 m	P8LS08L26C
		9 m	P8LS08L26C
Clip connector - IP40 Individual - Including 2 flying leads Multiple - Including 1 common (0 Vdc) and 1 flying lead per connector	1 x Clip connector 2 x Clip connectors 4 x Clip connectors 8 x Clip connector	1 m	P8LW021C P8LW021C02 P8LW021C04 P8LW021C08
Straight cable quick connect to thread connector, IP67 protected = Y shape	M8 M12 M12 Male - 2 x M12 Female		P8CS0803J P8CS1204J P8CS1212A

### 2

150 NI/mm, 400 NI/mm, 1200 NI/mm

24 V ~ P = - 0.9 bar / +8 bar

Size	IP	Size 1				Size 2					
		V	T	S	T	V	T	S	T		
4/2	IP65	P2M1V4ES2CV	P2M1T4ES2C	P2M1S4ES2C	P2M1T4ES2CW	P2M1S4ES2CW	P2M2V4ES2CV	P2M2T4ES2C	P2M2S4ES2C	P2M2T4ES2CW	P2M2S4ES2CW
		P2M1V4EE2CV	P2M1T4EE2C	P2M1S4EE2C	P2M1T4EE2CW	P2M1S4EE2CW	P2M2V4EE2CV	P2M2T4EE2C	P2M2S4EE2C	P2M2T4EE2CW	P2M2S4EE2CW
	IP67	P2M1VJEE2CV	P2M1TJEE2C	P2M1SJEE2C	P2M1TJEE2CW	P2M1SJEE2CW	P2M2VJEE2CV	P2M2TJEE2C	P2M2SJEE2C	P2M2TJEE2CW	P2M2SJEE2CW
		P2M1VDEE2CV	P2M1TDEE2C	P2M1SDEE2C	P2M1TDEE2CW	P2M1SDEE2CW	P2M2VDEE2CV	P2M2TDEE2C	P2M2SDEE2C	P2M2TDEE2CW	P2M2SDEE2CW
	IP40	P2M1VCEE2CV	P2M1TCEE2C	P2M1SCEE2C	P2M1TCEE2CW	P2M1SCEE2CW	P2M2VCEE2CV	P2M2TCEE2C	P2M2SCEE2C	P2M2TCEE2CW	P2M2SCEE2CW
		P2M1VEE2CV	P2M1TEE2C	P2M1SEE2C	P2M1TEE2CW	P2M1SEE2CW	P2M2VEE2CV	P2M2TEE2C	P2M2SEE2C	P2M2TEE2CW	P2M2SEE2CW
3/2	IP65	P2M1V3ES2CV	P2M1T3ES2C	P2M1S3ES2C	P2M1T3ES2CW	P2M1S3ES2CW	P2M2V3ES2CV	P2M2T3ES2C	P2M2S3ES2C	P2M2T3ES2CW	P2M2S3ES2CW
		P2M1V3EE2CV	P2M1T3EE2C	P2M1S3EE2C	P2M1T3EE2CW	P2M1S3EE2CW	P2M2V3EE2CV	P2M2T3EE2C	P2M2S3EE2C	P2M2T3EE2CW	P2M2S3EE2CW

### 3

Optimal nominal section for a full flow with appropriate piping

3 valve sizes lead to a global choice of tube sizes, thus covering all usual applications

Size	Nominal section (mm²)	Qn 1200 NI/mm³ (l/min)	Qn 400 NI/mm³ (l/min)	Qn 150 NI/mm³ (l/min)
Size 2	100	1200	400	150
Size 1	50	600	200	75
Size 01	25	300	100	37.5

### 3 Clip-On pneumatic connectors

Tube OD	Size 1	Size 2	
Straight connector	G1/8	FMDG1-1	
	4mm	FMD04-1	
	6mm	FMD06-1	FMD06-2
	8mm		FMD08-2
	10mm		FMD10-2
Elbow connector	G1/8	CMDG1-1	
	4mm	CMD04-1	
	6mm	CMD06-1	CMD06-2
	8mm		CMD08-2
	10mm		CMD10-2
Double male union		HMDXX1	HMDXX2
		MMDVA1	MMDVA2
Silencer		PMDXX1	PMDXX2

### 4

#### 4 Basic peripheral modules (without connector)

Description	Size 1		Size 2	
	Part number	Part number	Part number	Part number
Dual flow control	P2M1PXFA	P2M2PXFA		
Dual P.O. check valve	P2M1PXCA	P2M2PXCA		
Pressure regulator	Pressure range	Gauge		
	0 - 2 bar	0 - 4 bar	P2M1PXSR	P2M2PXSR
	Without		P2M1PXST	P2M2PXST
	0 - 4 bar	0 - 7 bar	P2M1PXSM	P2M2PXSM
90% Vacuum generator	Without		P2M1PXSL	P2M2PXSL
	0 - 8 bar	0 - 11 bar	P2M1PXSG	P2M2PXSG
	Without		P2M1PXSN	P2M2PXSN
			P2M1PXVA	

#### 4 Clip-on accessories

Description	Connection	Pressure range	Part number
Clip-on pressure gauge for pressure regulator modules, size 1 or size 2	Clip-on	0 to 4 bar	P2M1K0GT
		0 - 7 bar	P2M1K0GL
		0 - 11 bar	P2M1K0GN
Analog (1 - 5 Vdc) Vacuum Sensor Flying lead 2 m cable	4 mm tube	0 to -1 bar	MPS-V8T4-AG
	6 mm tube	0 to -1 bar	MPS-V8T-AG
Dig. PNP / Ana (I - 20 mA) Vacuum Sensor 15 cm cable - M8 4 pin's connector	G1/8" male	0 to -1 bar	MPS-V34G-PCI

[www.parker.com/pde/p2m](http://www.parker.com/pde/p2m)

## Parker Worldwide

### Europe, Middle East, Africa

**AE – United Arab Emirates,**  
Dubai

Tel: +971 4 8127100  
parker.me@parker.com

**AT – Austria,** Wiener Neustadt  
Tel: +43 (0)2622 23501-0  
parker.austria@parker.com

**AT – Eastern Europe,** Wiener  
Neustadt  
Tel: +43 (0)2622 23501 900  
parker.easteurope@parker.com

**AZ – Azerbaijan,** Baku  
Tel: +994 50 2233 458  
parker.azerbaijan@parker.com

**BE/LU – Belgium,** Nivelles  
Tel: +32 (0)67 280 900  
parker.belgium@parker.com

**BG – Bulgaria,** Sofia  
Tel: +359 2 980 1344  
parker.bulgaria@parker.com

**BY – Belarus,** Minsk  
Tel: +48 (0)22 573 24 00  
parker.poland@parker.com

**CH – Switzerland,** Etoy  
Tel: +41 (0)21 821 87 00  
parker.switzerland@parker.com

**CZ – Czech Republic,** Klecany  
Tel: +420 284 083 111  
parker.czechrepublic@parker.com

**DE – Germany,** Kaarst  
Tel: +49 (0)2131 4016 0  
parker.germany@parker.com

**DK – Denmark,** Ballerup  
Tel: +45 43 56 04 00  
parker.denmark@parker.com

**ES – Spain,** Madrid  
Tel: +34 902 330 001  
parker.spain@parker.com

**FI – Finland,** Vantaa  
Tel: +358 (0)20 753 2500  
parker.finland@parker.com

**FR – France,** Contamine s/Arve  
Tel: +33 (0)4 50 25 80 25  
parker.france@parker.com

**GR – Greece,** Athens  
Tel: +30 210 933 6450  
parker.greece@parker.com

**HU – Hungary,** Budaörs  
Tel: +36 23 885 470  
parker.hungary@parker.com

**IE – Ireland,** Dublin  
Tel: +353 (0)1 466 6370  
parker.ireland@parker.com

**IL – Israel**  
Tel: +39 02 45 19 21  
parker.israel@parker.com

**IT – Italy,** Corsico (MI)  
Tel: +39 02 45 19 21  
parker.italy@parker.com

**KZ – Kazakhstan,** Almaty  
Tel: +7 7273 561 000  
parker.easteurope@parker.com

**NL – The Netherlands,** Oldenzaal  
Tel: +31 (0)541 585 000  
parker.nl@parker.com

**NO – Norway,** Asker  
Tel: +47 66 75 34 00  
parker.norway@parker.com

**PL – Poland,** Warsaw  
Tel: +48 (0)22 573 24 00  
parker.poland@parker.com

**PT – Portugal**  
Tel: +351 22 999 7360  
parker.portugal@parker.com

**RO – Romania,** Bucharest  
Tel: +40 21 252 1382  
parker.romania@parker.com

**RU – Russia,** Moscow  
Tel: +7 495 645-2156  
parker.russia@parker.com

**SE – Sweden,** Spånga  
Tel: +46 (0)8 59 79 50 00  
parker.sweden@parker.com

**SL – Slovenia,** Novo Mesto  
Tel: +386 7 337 6650  
parker.slovenia@parker.com

**TR – Turkey,** Istanbul  
Tel: +90 216 4997081  
parker.turkey@parker.com

**UA – Ukraine,** Kiev  
Tel: +48 (0)22 573 24 00  
parker.poland@parker.com

**UK – United Kingdom,** Warwick  
Tel: +44 (0)1926 317 878  
parker.uk@parker.com

**ZA – South Africa,** Kempton Park  
Tel: +27 (0)11 961 0700  
parker.southafrica@parker.com

### North America

**CA – Canada,** Milton, Ontario  
Tel: +1 905 693 3000

**US – USA,** Cleveland  
Tel: +1 216 896 3000

### Asia Pacific

**AU – Australia,** Castle Hill  
Tel: +61 (0)2-9634 7777

**CN – China,** Shanghai  
Tel: +86 21 2899 5000

**HK – Hong Kong**  
Tel: +852 2428 8008

**IN – India,** Mumbai  
Tel: +91 22 6513 7081-85

**JP – Japan,** Tokyo  
Tel: +81 (0)3 6408 3901

**KR – South Korea,** Seoul  
Tel: +82 2 559 0400

**MY – Malaysia,** Shah Alam  
Tel: +60 3 7849 0800

**NZ – New Zealand,** Mt Wellington  
Tel: +64 9 574 1744

**SG – Singapore**  
Tel: +65 6887 6300

**TH – Thailand,** Bangkok  
Tel: +662 186 7000

**TW – Taiwan,** Taipei  
Tel: +886 2 2298 8987

### South America

**AR – Argentina,** Buenos Aires  
Tel: +54 3327 44 4129

**BR – Brazil,** Sao Jose dos Campos  
Tel: +55 800 727 5374

**CL – Chile,** Santiago  
Tel: +56 2 623 1216

**MX – Mexico,** Toluca  
Tel: +52 72 2275 4200

#### European Product Information Centre

Free phone: 00 800 27 27 5374  
(from AT, BE, CH, CZ, DE, DK, EE, ES, FI,  
FR, IE, IL, IS, IT, LU, MT, NL, NO, PL, PT, RU,  
SE, SK, UK, ZA)

