

Hi-Check Non-Return Valve

up to 10,000 psi/689 bar



Product Description:

These high performance check valves offer the user two options for cold working pressure ratings of Class 2500 and Class 4500, with an opening pressure of 10 psi max.

By offering a true two piece design, body leakage paths are kept to a minimum.

With the added opportunity to select integral compression ends the user can eliminate the use of taper threads and thread sealant. This avoids system contamination, reduces potential leakage paths, weight, space and, therefore, installation costs.



Product Features:

- Two-piece metal seated body design - minimal leakage paths
- 4:1 Pressure boundary designed safety factor
- Designed to meet pressure and temperature requirements of ANSI/ASME B. 16.34, as limited by the seat materials
- Nitrile, Fluorocarbon, EPR and Highly Fluorinated Fluorocarbon Rubber seat materials available
- Integral compression ends available
- Factory tested - all units fully hydrostatically tested to 1.5 x max. W.P
- Connector thread environmentally sealed
- NACE MR 01 75/ISO 15156 compliant materials available

Product Benefits:

- Self-centering Seal
- Low noise
- Rugged Design - Threads not in contact with media
- Zero coil bounding check spring
- Explosive decompression/Extrusion resistance o-rings for High Pressure Applications
- Optional secured Locking Connector



ENGINEERING YOUR SUCCESS.

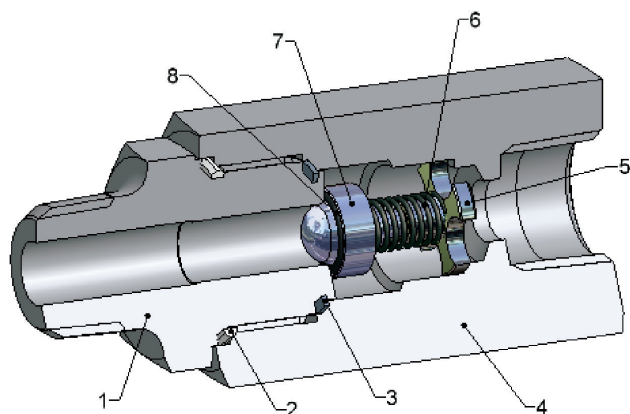

Item	Description
1	Adaptor
2	E-seal™
3	Joint Seal
4	Body
5	Spring Support
6	Spring
7	Poppet
8	O-ring

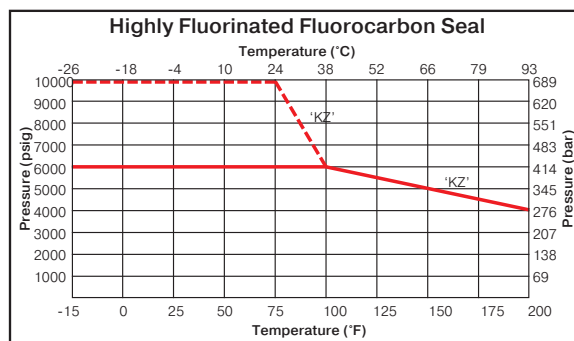
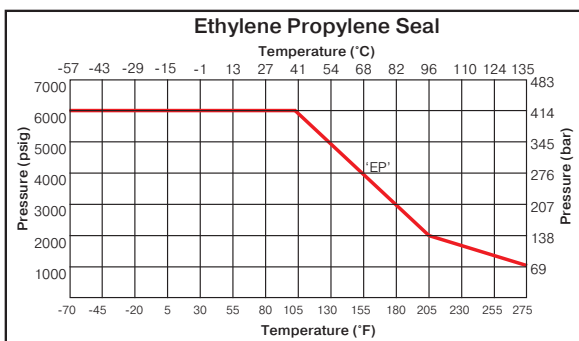
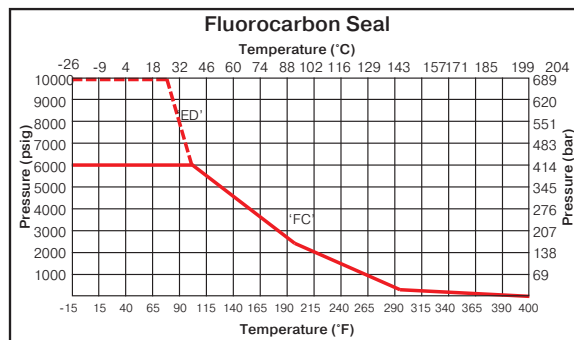
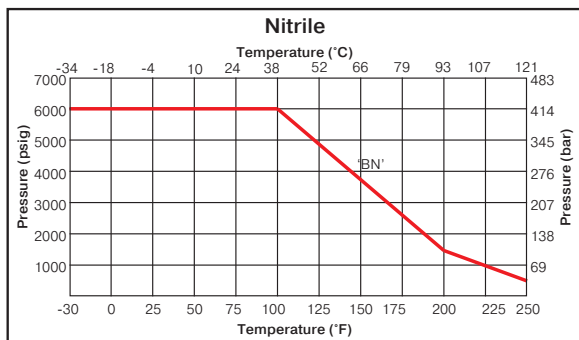
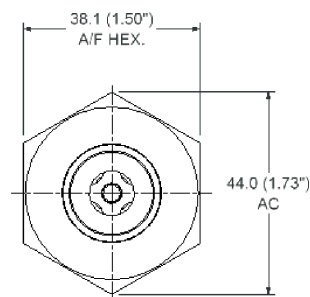
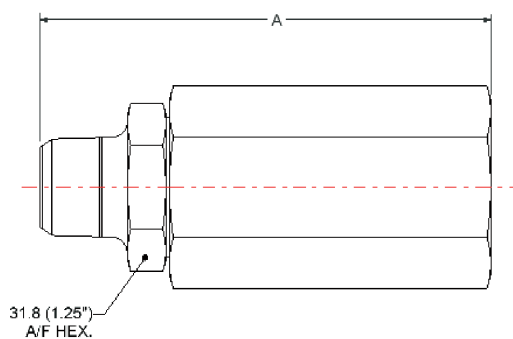

Note: To determine MPa, multiply bar by 0.1 Key: —— 6,000 psi - - - - 10,000 psi

Part Number	Part Number	Inlet	Outlet	Dimensions
6000 psig (414 barg)	10,000 psig (689 barg)	Female	Female	A mm (inch)
HCY*4FF-#	HCY*4FFHP-#	1/4" NPT	1/4" NPT	74.7 (2.94)
HCY*6FF-#	HCY*6FFHP-#	3/8" NPT	3/8" NPT	79.7 (3.14)
HCY*8FF-#	HCY*8FFHP-#	1/2" NPT	1/2" NPT	87.9 (3.46)
6000 psig (414 barg)	10,000 psig (689 barg)	Male	Female	A mm (inch)
HCY*4M4F-#	HCY*4M4FHP-#	1/4" NPT	1/4" NPT	89.7 (3.53)
HCY*8M8F-#	HCY*8M8FHP-#	1/2" NPT	1/2" NPT	97.9 (3.90)
6000 psig (414 barg)	10,000 psig (689 barg)	A-LOK®	A-LOK®	A mm (inch)
HCY*4A-#	HCY*4AHP-#	1/4" OD	1/4" OD	106.8 (4.20)
HCY*6A-#	HCY*6AHP-#	3/8" OD	3/8" OD	107.3 (4.23)
HCY*8A-#	HCY*8AHP-#	1/2" OD	1/2" OD	113.7 (4.48)
HCY*M6A-#	HCY*M6AHP-#	6mm OD	6mm OD	106.8 (4.20)
HCY*M10A-#	HCY*M6AHP-#	10mm OD	10mm OD	107.8 (4.25)
HCY*M12A-#	HCY*M6AHP-#	12mm OD	12mm OD	113.7 (4.48)

*Insert material code - select from material matrix (B = Standard 316 Stainless Steel)
 # O-ring code - select from O-ring compound matrix
 For CPI™ change A to Z. "A" Dimensions given for A-LOK® are finger tight.
 NACE only available on Pipe Thread Connections.
 For Compression ended valve pressures consult tube rating table.

Material	*Insert
316 Stainless Steel	B
Duplex	E
Monel	D

Available Options	Part Number
NACE	NC
Secured End Connector	LC

Above options to be inserted prior to O-ring suffix
 Example 'HCYB8FFHPNC-ED'
 Hi-Check 10mm 316 St.Stl 1/2" NPT (FEM)
 10,000 psi NACE with Fluorocarbon V1238-95 rubber

O-Ring Suffix # 6000 psig (414 barg)	Compound Options
FC	Fluorocarbon Rubber FPM 75
BN	Nitrile
EP	Ethylene Propylene Rubber
ED	Flurocarbon Rubber V1238-95
KZ	Highly Fluorinated Fluorocarbon Seal
O-Ring Suffix # 10,000 psig (689 barg)	Compound Options
ED	Fluorocarbon Rubber V1238-95
KZ	Highly Fluorinated Fluorocarbon Seal

Specifications:

Cold Working Pressure Ratings

- 6000 psig (414 barg) & 10,000 psig (689 barg)

Temperature Rating:

Material Temperatures limited to working temperatures of seals below:

6000 psig (414 barg)

- Fluorocarbon - 15°F to 400°F (-26°C to 204°C)
- Nitrile - 30°F to 275°F (-34°C to 135°C)
- Ethylene Propylene Rubber - 70°F to 275°F (-57°C to 135°C)
- Highly Fluorinated Fluorocarbon Rubber - 15°F to 200°F (-26°C to 93°C)

10,000 psig (689 barg) Option

- Fluorocarbon V1238-95 - 15°F to 400°F (-26°C to 204°C)
- Highly Fluorinated Fluorocarbon Rubber - 15°F to 200°F (-26°C to 93°C)

Crack and Re-seal

- Cracking Pressure: < 10 psi (0.69 barg)
- Re-seal Pressure: < 50 psi (3.45 barg)

Note: Hi-check non-return valves which are not actuated for a period of time, may initially crack at a higher pressure than the above cracking pressure listed.

Cv: 1.54

© 2022 Parker Hannifin Corporation. All rights reserved

Parker Hannifin Manufacturing Ltd
Instrumentation Products
Division Europe
Riverside Road
Pottington Business Park
Barnstaple, Devon, EX31 1NP
United Kingdom
Tel.: +44 (0) 1271 313131
Fax: +44 (0) 1271 373636
www.parker.com/ipd

Parker Hannifin Corporation
Instrumentation Products Division
1005 A Cleaner Way
Huntsville
Alabama
AL 35805
USA
Tel: + 1 (256) 881-2040
Fax: + 1 (256) 881-5072
www.parker.com/ipd

Cat 4190/CV 02/2022



ENGINEERING YOUR SUCCESS.