

Parker Worldwide

Europe, Middle East, Africa

AE – United Arab Emirates, Dubai
Tel: +971 4 8127100
parker.me@parker.com

AT – Austria, St. Florian
Tel: +43 (0)7224 66201
parker.austria@parker.com

AZ – Azerbaijan, Baku
Tel: +994 50 2233 458
parker.azerbaijan@parker.com

BE/NL/LU – Benelux, Hendrik Ido Ambacht
Tel: +31 (0)541 585 000
parker.nl@parker.com

BG – Bulgaria, Sofia
Tel: +359 2 980 1344
parker.bulgaria@parker.com

BY – Belarus, Minsk
Tel: +48 (0)22 573 24 00
parker.poland@parker.com

CH – Switzerland, Etoy
Tel: +41 (0)21 821 87 00
parker.switzerland@parker.com

CZ – Czech Republic, Klecany
Tel: +420 284 083 111
parker.czechrepublic@parker.com

DE – Germany, Kaarst
Tel: +49 (0)2131 4016 0
parker.germany@parker.com

DK – Denmark, Ballerup
Tel: +45 43 56 04 00
parker.denmark@parker.com

ES – Spain, Madrid
Tel: +34 902 330 001
parker.spain@parker.com

FI – Finland, Vantaa
Tel: +358 (0)20 753 2500
parker.finland@parker.com

FR – France, Contamine s/Arve
Tel: +33 (0)4 50 25 80 25
parker.france@parker.com

GR – Greece, Piraeus
Tel: +30 210 933 6450
parker.greece@parker.com

HU – Hungary, Budaörs
Tel: +36 23 885 470
parker.hungary@parker.com

IE – Ireland, Dublin
Tel: +353 (0)1 466 6370
parker.ireland@parker.com

IL – Israel,
Tel: +39 02 45 19 21
parker.israel@parker.com

IT – Italy, Corsico (MI)
Tel: +39 02 45 19 21
parker.italy@parker.com

KZ – Kazakhstan, Almaty
Tel: +7 7273 561 000
parker.easteurope@parker.com

NO – Norway, Asker
Tel: +47 66 75 34 00
parker.norway@parker.com

PL – Poland, Warsaw
Tel: +48 (0)22 573 24 00
parker.poland@parker.com

PT – Portugal,
Tel: +351 22 999 7360
parker.portugal@parker.com

RO – Romania, Bucharest
Tel: +40 21 252 1382
parker.romania@parker.com

RU – Russia, Moscow
Tel: +7 495 645-2156
parker.russia@parker.com

SE – Sweden, Spånga
Tel: +46 (0)8 59 79 50 00
parker.sweden@parker.com

SK – Slovakia, Banská Bystrica
Tel: +421 484 162 252
parker.slovakia@parker.com

SL – Slovenia, Novo Mesto
Tel: +386 7 337 6650
parker.slovenia@parker.com

TR – Turkey, Istanbul
Tel: +90 216 4997081
parker.turkey@parker.com

UA – Ukraine, Kiev
Tel: +48 (0)22 573 24 00
parker.poland@parker.com

UK – United Kingdom, Warwick
Tel: +44 (0)1926 317 878
parker.uk@parker.com

ZA – South Africa, Kempton Park
Tel: +27 (0)11 961 0700
parker.southafrica@parker.com

North America

CA – Canada, Milton, Ontario
Tel: +1 905 693 3000

US – USA, Cleveland
Tel: +1 216 896 3000

Asia Pacific

AU – Australia, Castle Hill
Tel: +61 (0)2-9634 7777

CN – China, Shanghai
Tel: +86 21 2899 5000

HK – Hong Kong
Tel: +852 2428 8008

IN – India, Mumbai
Tel: +91 22 6513 7081-85

JP – Japan, Tokyo
Tel: +81 (0)3 6408 3901

KR – South Korea, Seoul
Tel: +82 2 559 0400

MY – Malaysia, Shah Alam
Tel: +60 3 7849 0800

NZ – New Zealand, Mt Wellington
Tel: +64 9 574 1744

SG – Singapore
Tel: +65 6887 6300

TH – Thailand, Bangkok
Tel: +662 186 7000

TW – Taiwan, Taipei
Tel: +886 2 2298 8987

South America

AR – Argentina, Buenos Aires
Tel: +54 3327 44 4129

BR – Brazil, Sao Jose dos Campos
Tel: +55 800 727 5374

CL – Chile, Santiago
Tel: +56 2 623 1216

MX – Mexico, Toluca
Tel: +52 72 2275 4200

Sensors and switches for Pressure, Temperature, Level and Flow



Sensors and switches for Pressure, Temperature, Level and Flow





At Parker, we're guided by a relentless drive to help our customers become more productive and achieve higher levels of profitability by engineering the best systems for their requirements. It means looking at customer applications from many angles to find new ways to create value. Whatever the motion and control technology need, Parker has the experience, breadth of product and global reach to consistently deliver. No company knows more about motion and control technology than Parker. For further info call 00800 27 27 5374

Parker's Motion & Control Technologies



Aerospace
Key Markets
Aftermarket services
Commercial transports
Engines
General & business aviation
Helicopters
Launch vehicles
Military aircraft
Missiles
Power generation
Regional transports
Unmanned aerial vehicles

Key Products
Control systems & actuation products
Engine systems & components
Fluid conveyance systems & components
Fluid metering, delivery & atomization devices
Fuel systems & components
Fuel tank inerting systems
Hydraulic systems & components
Thermal management
Wheels & brakes



Climate Control
Key Markets
Agriculture
Air conditioning
Construction Machinery
Food & beverage
Industrial machinery
Life sciences
Oil & gas
Precision cooling
Process
Refrigeration
Transportation

Key Products
Accumulators
Advanced actuators
CO₂ controls
Electronic controllers
Filter driers
Hand shut-off valves
Heat exchangers
Hose & fittings
Pressure regulating valves
Refrigerant distributors
Safety relief valves
Smart pumps
Solenoid valves
Thermostatic expansion valves



Electromechanical
Key Markets
Aerospace
Factory automation
Life science & medical
Machine tools
Packaging machinery
Paper machinery
Plastics machinery & converting
Primary metals
Semiconductor & electronics
Textile
Wire & cable

Key Products
AC/DC drives & systems
Electric actuators, gantry robots & slides
Electrohydraulic actuation systems
Electromechanical actuation systems
Human machine interface
Linear motors
Stepper motors, servo motors, drives & controls
Structural extrusions



Filtration
Key Markets
Aerospace
Food & beverage
Industrial plant & equipment
Life sciences
Marine
Mobile equipment
Oil & gas
Power generation & renewable energy
Process
Transportation
Water Purification

Key Products
Analytical gas generators
Compressed air filters & dryers
Engine air, coolant, fuel & oil filtration systems
Fluid condition monitoring systems
Hydraulic & lubrication filters
Hydrogen, nitrogen & zero air generators
Instrumentation filters
Membrane & fiber filters
Microfiltration
Sterile air filtration
Water desalination & purification filters & systems



Fluid & Gas Handling

Key Markets
Aerial lift
Agriculture
Bulk chemical handling
Construction machinery
Food & beverage
Fuel & gas delivery
Industrial machinery
Life sciences
Marine
Mining
Mobile
Oil & gas
Renewable energy
Transportation

Key Products
Check valves
Connectors for low pressure fluid conveyance
Deep sea umbilicals
Diagnostic equipment
Hose couplings
Industrial hose
Mooring systems & power cables
PTFE hose & tubing
Quick couplings
Rubber & thermoplastic hose
Tube fittings & adapters
Tubing & plastic fittings



Hydraulics

Key Markets
Aerial lift
Agriculture
Alternative energy
Construction machinery
Forestry
Industrial machinery
Machine tools
Marine
Material handling
Mining
Oil & gas
Power generation
Refuse vehicles
Renewable energy
Truck hydraulics
Turf equipment

Key Products
Accumulators
Cartridge valves
Electrohydraulic actuators
Human machine interfaces
Hybrid drives
Hydraulic cylinders
Hydraulic motors & pumps
Hydraulic systems
Hydraulic valves & controls
Hydrostatic steering
Integrated hydraulic circuits
Power take-offs
Power units
Rotary actuators
Sensors



Pneumatics

Key Markets
Aerospace
Conveyor & material handling
Factory automation
Life science & medical
Machine tools
Packaging machinery
Transportation & automotive

Key Products
Air preparation
Braz fittings & valves
Manifolds
Pneumatic accessories
Pneumatic actuators & grippers
Pneumatic valves & controls
Quick disconnects
Rotary actuators
Rubber & thermoplastic hose & couplings
Structural extrusions
Thermoplastic tubing & fittings
Vacuum generators, cups & sensors



Process Control

Key Markets
Alternative fuels
Biopharmaceuticals
Chemical & refining
Food & beverage
Marine & shipbuilding
Medical & dental
Microelectronics
Nuclear Power
Offshore oil exploration
Oil & gas
Pharmaceuticals
Power generation
Pulp & paper
Steel
Water/wastewater

Key Products
Analytical instruments
Analytical sample conditioning products & systems
Chemical injection fittings & valves
Fluoropolymer chemical delivery fittings, valves & pumps
High purity gas delivery fittings, valves, regulators & digital flow controllers
Industrial mass flow meters/ controllers
Permanent no-weld tube fittings
Precision industrial regulators & flow controllers
Process control double block & bleed
Process control fittings, valves, regulators & manifold valves



Sealing & Shielding

Key Markets
Aerospace
Chemical processing
Consumer
Fluid power
General industrial
Information technology
Life sciences
Microelectronics
Military
Oil & gas
Power generation
Renewable energy
Telecommunications
Transportation

Key Products
Dynamic seals
Elastomeric o-rings
Electro-medical instrument design & assembly
EMI shielding
Extruded & precision-cut, fabricated elastomeric seals
High temperature metal seals
Homogeneous & inserted elastomeric shapes
Medical device fabrication & assembly
Metal & plastic retained composite seals
Shielded optical windows
Silicone tubing & extrusions
Thermal management
Vibration dampening

All the instruments meet the guidelines of the European Community (EU). It is confirmed that these products are approved acc. to following standards.



DIN/EN 61000-6-2
DIN/EN 61000-6-3

Note!

This document and other information from Parker Hannifin GmbH, provide product or system options for further investigation by users having technical expertise. Before you select or use any product or system it is important that you analyse all aspects of your application and review the information concerning the product or system in the current product catalogue. Due to the variety of operating conditions and applications for these products or systems, the user, through his own analysis and testing, is solely responsible for making the final selection of the products and systems and assuring that all performance and safety requirements of the application are met. The products are subject to change by Parker Hannifin GmbH at any time without notice.

Technical subject to change. October 2021.

© Copyright 2021, Parker Hannifin Corporation. All Rights Reserved.













Table of Contents

	Page
Product overview	4-5
Selection guide pressure sensors	6
Selection guide pressure controller	7
Pressure and temperature sensors	9-35
SCP01 pressure sensor	12-15
SCP02 pressure sensor	16-21
SCP03 pressure sensor	22-26
SCP07 pressure sensor	27-28
SCP08 pressure sensor	29-30
SCPSi pressure switch	31-33
SCT-150 temperature sensor	34-35
Volumetric flow rate sensors	36-51
SCQ flow meter	38-41
SCFT measurement turbine	42-45
SCVF volume counter	46-51
The Controller Family	52-99
SCPSDi PressureController	54-59
SCPSD PressureController	60-65
SCTSD TemperatureController	66-77
SCTSD-L combination switch	78-81
SCLSD LevelController	82-87
SCLTSD LevelTempController	88-93
SCOTC OilTankController	94-99
Accessories	100-105
SCK cable	100-101
SCA adapter	102-103
Software ControllerWIN	104-105
Installation and safety instructions	106
EMC	106
Compatibility with media (substances)	106
Pressure range selection	106
Appendix	107-108
Conversion charts	107
Index	108
Old and new references	108

Product overview

Measurement





Pressure and temperature sensors



SCP01	SCP02	SCP03
		
Pressure sensor for standard applications	Pressure sensor for mobile hydraulics	Pressure sensor for mobile and industrial applications
Page 12-15	Page 16-21	Page 22-26
SCP07	SCP08	SCPSi
		
Pressure sensor for safety requirements	Pressure sensor for press construction and die-casting	Pressure switch with IO-Link
Page 27-28	Page 29-30	Page 31-33
SCT-150		
		
Temperature sensor for high operating pressures		
Page 34-35		
SCQ	SCFT	SCVF
		
For quick flow changes	Low loss measuring of volume flow	Measures different substances
Measures in both directions		Measures lower volume flows (leakage measurements)
Page 38-41	Page 42-45	Page 46-51

Volumetric flow rate sensors



Product overview

Measurement, display and switching

	SCPSDi	SCPSD	SCTSD	SCTSD-L
The Controller Family				
	Pressure display and monitoring		Temperature display and monitoring	Temperature display and level monitoring
	Page 54-59	Page 60-65	Page 66-77	Page 78-81

	SCLSD	SCLTSD	SCOTC
			
	Level display and monitoring	Level/temperature display and monitoring	
	Page 82-87	Page 88-93	Page 94-99

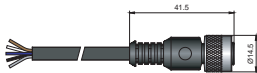
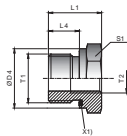
Accessories

SCK cable	SCA adapter	Software ControllerWIN
		
Page 100-101	Page 102-103	Page 104-105

Selection guide pressure sensors

		SCP01	SCP02	SCP03	SCP07	SCP08
Pressure-range	0...bar / (psi) relative	10...1000 (145...14,504)	10...1000 (145...14,504)	04...1000 (58...14,504)	10...600 (145...8702)	600/1000 (8702...14,504)
	-1...bar / -14.5 (psi) relative			3...24 (43,5...348)		
	0...bar / (psi) absolut					
Order qty.			50 pcs	50 pcs	50 pcs	1 / 5 / 50 pcs
Accuracy		0,5 %	0,5 %	0,5 %	0,5 %	0,5 %
Display						
Output	Switching Output					
	IO-Link					
	0,5...4,5 V (ratiometric 5V)		•	•		
	0,5...4,5 V (nominal 24V)	•	•	•		
	0...5 V	•	•	•		
	1...6 V	•	•	•		
	0...10 V	•	•	•		•
	0...20 mA	•		•		
	4...20 mA (3-wire)	•	•	•	•	
	4...20 mA (2-wire)	•	•	•		•
CAN						
Electrical Plug	M12	•	•	•	•	•
	DIN EN 175301-803 Form A	•		•		•
	DIN Micro 9.4	•				
	AMP Superseal		•	•		
	Deutsch DT04 4-pin		•	•		
	Deutsch DT04 3-pin		•	•		
	Junior Timer			•		
	Cable 2m		•	•		
Thread	G1/4 BSPP ED	•	•	•	•	•
	G 1/4 O-ring		•	•		
	1/4 NPT	•	•	•		
	7/16-20 UNF	•	•	•		
	9/16-20 UNF		•	•		
Wetted parts	Stainless steel/ Soft sealing	FKM	FKM	FKM	FKM	FKM
	Stainless steel/ Metall sealing					
Approvals	CE	•	•	•	•	•
	Marine	•				
	Safety SIL / PL				•	

Selection guide pressure controller

		SCPSi	SCPSD	SCPSDi
Pressure-range	0...(bar) relative			
	-1...bar / -14.5 (psi) relative			
	0...(bar) absolut			
Order qty.				
Accuracy				
Display			•	•
Output	Switching	•	•	•
	IO-Link	•		•
	0,5...4,5 V (ratiometric 5V)			
	0,5...4,5 V (nominal 24V)			
	0...5 V			
	1...6 V			
	0...10 V			•
	0...20 mA		•	•
	4...20 mA (3-wire)			•
	4...20 mA (2-wire)			
CAN				
Electrical Plug	M12	•	•	•
	DIN EN 175301-803 Form A		•	
	DIN Micro 9.4			
	AMP Superseal			
	Deutsch DT04 4-pin			
	Deutsch DT04 3-pin			
	Junior Timer			
	Cable 2m			
Thread	G1/4 BSPP ED	•		
	G 1/4 O-Ring			
	1/4 NPT			
	7/16-20 UNF			
	9/16-20 UNF			
Wetted parts	Stainless steel/ Soft sealing	NBR	NBR	NBR
	Stainless steel/ Metall sealing		•	•
Approvals	CE		•	•
	Marine		•	•
	Safety SIL / PL			

Certified sensors and switches for maritime applications



The products designed for maritime use meet the current international approvals:

- **ABS** American Bureau of Shipping
- **DNV** Det Norske Veritas
- **GL** Germanischer Lloyd

The portfolio extends from pressure sensors to electronic switches with display for pressure / level / temperature. Parker offers the chance to upgrade from mechanical to electronic measuring devices in the hydraulic system, with the following advantages:

- | | |
|-----------------|--------------------------|
| ■ High accuracy | ■ Safety |
| ■ Long lifetime | ■ Comfortable functions |
| ■ Reliability | ■ High quality standards |

These certified products will enhance the safety and reliability of maritime hydraulic systems:

SCP01/ SCPSD / SCPSDi / SCLTSD / SCTSD-L



Pressure and temperature sensors

Device features

- Long-term stability
- Immune to interference
- Rugged design
- Dependable



Pressure and temperature sensors

SensoControl® sensors feature long-term stability, interference immunity, a sturdy high-quality construction and a wide range of variants.

The sensors are designed and manufactured in our own production facilities under established standards for the industrial instrumentation and control systems. This allows us to easily adapt them to customer requirements or to critical applications.

We carefully consider the special requirements for automation and mobile hydraulics during the design phase. So our **SensoControl**® sensors are ideally suitable for the permanent series use in industrial and mobile applications.

Pressure sensors

The housing and all parts of the pressure sensors that touch the substances are manufactured from stainless steel. This provides a large range of media tolerability. A wide range of applications is possible due to the combination of high interference immunity and high resistance to external influences (shock, vibration and temperature).

The application areas are varied: from process engineering test rigs, conveying and lifting equipment, mobile hydraulics, general machine construction, pneumatic construction and hydraulic plant construction.

The SCP should be used when the pressure needs to be monitored reliably for long periods.

In this case the optimal sensor type can be selected from different product series according to the needs of the application. Different connecting plugs, output signals and connection threads are also available.



Temperature sensors

The SCT temperature sensor should be used when a temperature signal is required.

These are characterised by their pressure resistance up to 630 bar.

Pressure and temperature sensors

Overview

	SCP01	SCP02	SCP03
			
Range of use	Pressure sensor for standard applications <ul style="list-style-type: none"> Stainless steel measuring cell Small design High burst pressure Resistant to pressure peaks Resistant to shock and vibration 	Pressure sensor for mobile hydraulics <ul style="list-style-type: none"> Stainless steel measuring cell Small design Stainless steel housing High burst pressure ECE approval E1 High protection degree Resistant to shock and vibration 	Pressure sensor for mobile and industrial applications <ul style="list-style-type: none"> Up to 1000 bar G1/4 DIN 3852-11 (E) Compact design Long term stability Wide temperature range -40...125°C (-40...257°F)
Application	<ul style="list-style-type: none"> General machine construction Injection-mould machines Die-casting machines Press construction Test benches Machine tool 	<ul style="list-style-type: none"> Mobile hydraulics Transport vehicles Conveyor vehicles Commercial vehicles Automotive technology Brake systems Oil pressure Test equipment and technology Gearbox control 	<ul style="list-style-type: none"> Mobile hydraulic Transport vehicles Conveyor vehicles Commercial vehicles Automotive technology Brake systems Oil pressure Test equipment and technology Gearbox control
Order code	SCP01-xxxx-xx-0x	SCP02-xxx-xx-0xQ8	SCP03-xxx-xx-xx
Refer to page	12-15	16-21	22-26



SCP07



Range of use	Pressure sensor for safety requirements <ul style="list-style-type: none"> PLd SIL 2 Two inverted 4-20 mA outputs Up to 600 bar G1/4 DIN 3852-11 (E) Compact design Long term stability Wide temperature range -40...85°C (-40...185°F)
Application	<ul style="list-style-type: none"> Safety requirements Mobile hydraulic Cranes Suspended loads Tire presses
Order code	SCP07-xxx-24-05Q8
Refer to page	27-28



Pressure and temperature sensors

	SCP08	SCPSi	SCT-150
			
Range of use	Pressure sensor for press construction and die-casting <ul style="list-style-type: none"> ■ 600 / 1000 bar (8702 / 14,504 psi) ■ G1/4" ■ 0-10 V / 4...20 mA 2-wire ■ M12x1 / DIN ■ Reinforced internal design ■ Persistence against shock & vibration ■ Made for high pressure acceleration ■ High dynamic signal 	IO-Link Pressure sensor or switch <ul style="list-style-type: none"> ■ Pressure sensor / -switch ■ Temperature measurement ■ Industry 4.0-ready ■ IO-Link 1.1 ■ Smart Sensor Profile 2nd edition ■ Plug & Play ■ Compact ■ Optimized design ■ Adjustable via IO-link ■ Readable via IO-Link ■ Useable as IO-Link sensor or switch ■ Monolithic pressure cell 	Measurement of pressure even under high operating pressures <ul style="list-style-type: none"> ■ Resistance to pressures up to 630 bar ■ Compact size ■ Standard output signal ■ Quick reaction time
Application	<ul style="list-style-type: none"> ■ Press construction ■ Die-casting 	<ul style="list-style-type: none"> ■ Injection-mould machines ■ Tool-making machines ■ Power packs ■ Special machine construction ■ Replacement for mechanical pressure switches 	<ul style="list-style-type: none"> ■ Test benches ■ Processing equipment ■ Conveying and lifting equipment ■ Machinery construction ■ Pneumatic plant construction ■ Hydraulic plant construction
Order code	SCP08-xxxx-x4-0x	SCPSi-xxx-04-07	SCT-150-41-07
Refer to page	29-30	31-33	34-35

SCP01 pressure sensor

Device features

- Small design
- Stainless steel measuring cell
- Stainless steel housing
- Shock and vibration proof
- Wide range of compatible substances
- High linearity
- Long-term stability
- Substance temperature -40...125 °C (-40...257°F)
- Pressure range up to 1000 bar (14,504 psi)
- High burst pressure
- Response time 1 ms
- Eroding milling
- Encapsulated electronics



The SCP01 pressure sensor was designed to meet industrial requirements and is used in control, regulating and monitoring systems.

The SCP01 is characterised by its compact design, high linearity and excellent interference immunity. It is suitable for quick control solutions because of its fast response speed. The compact stainless steel housing is good for harsh environmental conditions. All components which come into contact with the substance are made from stainless steel. This feature, combined with the welded, thin-layer measuring cell, ensure optimal compatibility with the substance.

In order to ensure an exact pressure measurement and to avoid disturbances, an EDM hole is integrated. This minimises the cavitation of air and dirt, thus preventing the measuring cell from being influenced by pressure surges and pressure peaks.

This product is ideal for permanent series usage in hydraulic applications because of its long lifespan, high accuracy, high reliability and sturdy stainless steel construction.

Typical application range

- General machine construction
- Injection-mould machines
- Die-casting machines
- Press construction
- Test benches
- Machine tool

SCP01 pressure sensor

Technical data

SCP01-xxx-x4-0x (bar; G1/4" BSPP)

SCP01-	010	016	025	040	060	100	160	250	400	600	1000
Pressure range	10	16	25	40	60	100	160	250	400	600	1000
P _n relative 0...bar / (psi)	(145)	(232)	(363)	(580)	(870)	(1450)	(2321)	(3626)	(5802)	(8702)	(14,504)
Overload pressure* P _{max}	2 x P _n										1.5 x P _n
Burst pressure** P _{burst}	4 x P _n										2.5 x P _n

SCP01-xxxxP-x5-0x (psi; 1/4 NPT) & **SCP01-xxxxP-x7-0x** (psi; 7/16-20 UNF)

SCP01-	0150P	0250P	1000P	3000P	5000P	9000P***
Pressure range	150	250	1000	3000	5000	9000
P _n relative 0... (psi)						
Overload pressure* P _{max}	2 x P _n					
Burst pressure** P _{burst}	4 x P _n					

* DIN EN 60770-1 / ** DIN 16086 / *** only 1/4 NPT

General	
Response time	≤1 ms
Long-term stability	< 0.2 % FS / a
Load change	> 20 million
Weight	Approx. 80 g
MTTFd	> 100 years
Accuracy	
Non-linearity	BFSL acc. to IEC 61298-2 ≤± 0.25 %FS
Accuracy	Type ≤± 0.25 %FS Max. ≤± 0.5 %FS
Total error at 0 to 85 °C	≤±1 %FS
Temperature coefficient	
Zero point	Max. ≤± 0.2 %FS/10 K
Output range	Max. ≤± 0.2 %FS/10 K
Material	
Housing	Stainless steel 1.4404

Ambient conditions	
Ambient temperature range	-40...+85 °C / (-40...185°F)
Fluid temperature range	-40...+125 °C / (-40...257°F)
Compensated range	0...+85 °C / (+32...185°F)
Storage temperature	-40...+125 °C / (-40...257°F)
Vibration resistance	IEC 60068-2-6: 20 g
Shock resistance	IEC 60068-2-27: 500 g
Electrical protection	
Short-circuit, signal to GND, reverse polarity protection	
EM compatibility	
Disturbance emissions	EN 61000-6-3
Resistance to interference	EN 61000-6-2
Process connection	
Eroding milling	0.6 mm
Tightening torque	Max. 35 Nm

Process connection	Seal	Parts in contact with substances
G1/4A BSPP; DIN 3852 T11, Form E	Sealing ring DIN 3869-14-FKM	FKM Stainless steel 1.4404, Stainless steel 1.4548
SAE 7/16 UNF Male O-ring	O-ring 8,12x1,83 FKM	FKM Stainless steel 1.4404, Stainless steel 1.4548
1/4 NPT		Stainless steel 1.4404, Stainless steel 1.4548

Output signal	0...20 mA	2-wire 4...20 mA	4...20 mA	0.5...4.5 V (nom); 0...5 V; 1...6 V; 0...10 V
Auxiliary power V ₊	+9...36 VDC	+9...36 VDC	+9...36 VDC	+14...36 VDC
Max. load	≥50...≤500 Ω (V ₊ - 9 V) / 20 mA	≥50...≤500 Ω (V ₊ - 9 V) / 20 mA	≥50...≤500 Ω (V ₊ - 9 V) / 20 mA	≥10 kΩ



SCP01 pressure sensor

Pressure and temperature sensors

Pin assignment

Device plug DIN EN 175301-803 Form A 4-pole (old 43650)

		SCP01-...-06		SCP01-...-06-MA	
PIN	2-wire 4...20 mA	3-wire 0/4...20 mA; 0.5...4.5 V (nom); 0...5 V; 0...10 V; 1...6 V	2-wire 4...20 mA	3-wire 0/4...20 mA; 0...10 V	
1	P-signal	P-signal	V ₊	V ₊	
2	n.c.*	0 V / GND	n.c.*	0 V / GND	
3	V ₊	V ₊	P-signal	P-signal	
	n.c.*				
Protection class		IP65			

Circular connector M12x1 4-pole

		SCP01-...-07	
PIN	2-wire 4...20 mA	3-wire 0/4...20 mA; 0.5...4.5 (nom); 0...5 V; 0...10 V; 1...6 V	
1	V ₊	V ₊	
2	P-signal	P-signal	
3	n.c.*	0 V / GND	
4	n.c.**		
Material		Metall plug	
Protection class		IP67	

Device plug (L-Industrial 9.4 mm)

		SCP01-...-0C	
PIN	2-wire 4...20 mA	3-wire 0/4...20 mA; 0.5...4.5 (nom); 0...5 V; 0...10 V; 1...6 V	
1	P-signal	P-signal	
2	V ₊	V ₊	
3	n.c.*		
	n.c.*	0 V / GND	
Protection class		IP65	

*n.c. = do not connect

**n.c. = do not connect / When flying leads are used on PIN 4, the PIN 4 has to be connected to GND.

SCP01-...-x4-0x

G1/4 BSPP ED

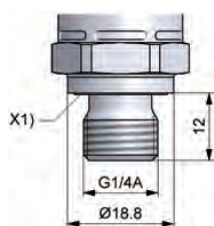

X1) = ED-seal

SCP01-...-x5-0x

1/4 NPT

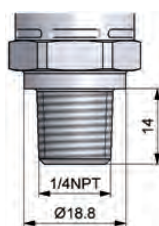
SCP01-...-x7-0x

SAE 7/16-20UNF

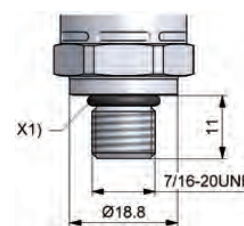

X1) = O ring 8.92 x 1.83



SCP01 pressure sensor

SCP01-xxx-xx-07

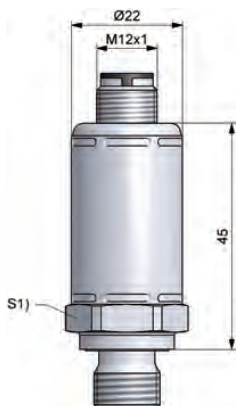

S1) = SW22

SCP01-xxx-xx-06

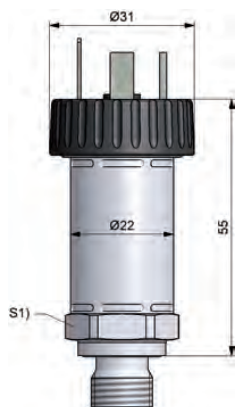

S1) = SW22

SCP01-xxx-xx-0C

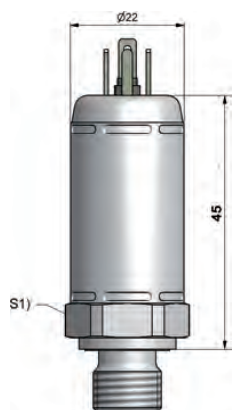

S1) = SW22

Order code

Pressure sensor SCP01 (bar) SCP01-xxx-xx-0x
 Pressure sensor SCP01 (bar) Marine (approved by DNV/GL/ABS) SCP01-xxx-xx-0x-MA

Pressure range (bar)	Order code
0...10 bar	010
0...16 bar	016
0...25 bar	025
0...40 bar	040
0...60 bar	060
0...100 bar	100
0...160 bar	160
0...250 bar	250
0...400 bar	400
0...600 bar	600
0...1000 bar	1000

Output signal	Order code
0...20 mA	1
4...20 mA (3-wire)	2
4...20 mA (2-wire)	3
0...5 V*	A
0,5...4,5 V (nom)*	S
1...6 V*	B
0...10 V	4

*Not approved for marine applications

Process connection	Order code
G 1/4" BSP	4

Connection plug	Order code
Circular connector M12x1 4-pole	7
Device connector DIN EN 175301-803 Form A 4-pole	6
Device plug industrial micro DIN 9.4 mm	C

Pressure sensor SCP01 (psi) SCP01-xxxxP-xx-0xQ8

Pressure range (psi)	Order code
0...150 psi	0150P
0...250 psi	0250P
0...1000 psi	1000P
0...3000 psi	3000P
0...5000 psi	5000P
0...9000 psi	9000P

Output signal	Order code
4...20 mA (3-wire)	2
4...20 mA (2-wire)	3
0...10 V	4

Process connection	Order code
SAE 7/16 UNF Male O ring (P _n max. = 400 bar)	7
1/4 NPT (P _n max. = 600 bar)	5

Connecting plug	Order code
Circular connector M12x1 4-pole	7

Order quantity
 15 Q8: Multiple of 50 pcs.

Catalogue 4083/UK

Pressure and temperature sensors



SCP02 pressure sensor

Device features

- Small design
- Stainless steel measuring cell
- Stainless steel housing
- Shock and vibration proof
- High protection degree
- E1 road approval
- Substance temperature -40...150 °C (-40...302°F)
- Up to 1000 bar (14,504 psi)
- 1 ms
- Up to 36-V wiring systems



The SCP02 was designed specifically for the use in mobile working machines. The SCP02 has e1-approval and is manufactured with state of the art production methods according to ISO/TS 16949.

The shock and vibration resistance, the EMC characteristics, the power supply as well as the extended temperature range all were designed for this application type.

The SCP02 is suitable for quick control solutions because of its fast response speed.

The compact stainless steel housing with the plastic connector allows for use in harsh environmental conditions such as those in mobile hydraulics.

The components which come into contact with the substance are made from stainless steel (1.4548). This feature, combined with the welded, thin-layer measuring cell, ensures optimal compatibility with the substance.

An EDM hole has been added so that you get a precise, interference-free pressure measurement. This minimises the cavitation of air and dirt, thus preventing the measuring cell from being influenced by pressure surges and pressure peaks.

Typical application range

- Mobile hydraulics
- Transport vehicles
- Conveyor vehicles
- Commercial vehicles
- Automotive technology
- Brake systems
- Oil pressure
- Test equipment and technology
- Gearbox control

SCP02 pressure sensor

Technical data

SCP02-	010	025	035/040	060	100	160	250	400	500	600	1000
Pressure range	10	25	40	60	100	160	250	400	500	600	1000
P _n relative 0... bar / (psi)	(145)	(363)	(508/580)	(870)	(1450)	(2321)	(3626)	(5802)	(7252)	(8702)	(14,504)
Overload pressure* P _{max}	2 x P _n										1.5 x P _n
Burst pressure** P _{burst}	4 x P _n										2.5 x P _n

* DIN EN 60770-1

** DIN 16086

General	
Response time	≤1 ms
Long-term stability	< 0.2 % FS / a
Load change	> 100 million
Weight	Approx. 55 g
MTTFd	> 100 years
Accuracy	
Linearity, pressure hysteresis and reproducibility	≤0.5 %FS
Complete accuracy	≤1.0 %FS (0...+80 °C) ≤1.5 %FS (-25...+100 °C) ≤2.5 %FS (-40...+125 °C)
Temperature coefficient	
Zero point	Max. ≤± 0.2 %FS/10 K
Output range	Max. ≤± 0.2 %FS/10 K
Material	
Housing	EN/DIN 1.4301
Electrical plug	Plastic PBT-GF30 Ultradur B4300 G6 black

Ambient conditions	
Ambient temperature range	-40...+125 °C / (-40...257°F)
Fluid temperature range	-40...+150 °C / (-40...284°F)
Storage temperature	-40...+125 °C / (-40...257°F)
Vibration resistance	IEC 60068-2-6: 20 g
Shock resistance	IEC 60068-2-27: 500 g
Electrical protection	
Short circuit, signal against GND/0V and protection against polarity reversal (not with ratiometric output)	
EM compatibility	
Disturbance emissions	EN 61000-6-3
Resistance to interference	EN 61000-6-2
Process connection	
Eroding milling	0,6 mm
Tightening torque	Max. 35 Nm

Process connection	Seal	Parts in contact with substances	Max. pressure range P _n
G1/4A BSPP; DIN 3852 T11, Form E	Sealing ring DIN 3869-14-FKM	EN/DIN 1.4548 / FKM	1000 bar / (14,504 psi)
SAE-4: 7/16-20 UNF O-ring	O-ring FKM	EN/DIN 1.4548 / FKM	400 bar / (5,802 psi)
SAE 6: 9/16-18 UNF O-ring	O-ring FKM	EN/DIN 1.4548 / FKM	400 bar / (5,802 psi)
G1/4 DIN ISO 228-1 O-ring	O-ring FKM	EN/DIN 1.4548 / FKM	600 bar / (8,702 psi)
1/4 NPT		EN/DIN 1.4548	600 bar / (8,702 psi)

Output signal P signal	2-wire 4...20 mA	0...5 V; 1...6 V 0.5...4.5 V nom.	0...10 V	0.5...4.5 V ratiometric
Auxiliary power V+	+9...36 VDC	+9...36 VDC	+14...36 VDC	5 V
Load Ω (Ohm)	≥50...≤500 Ω (V ₊ - 9 V) / 20 mA	≥10 kΩ	≥10 kΩ	≥10 kΩ



SCP02 pressure sensor

Pressure and temperature sensors

Pin assignment

AMP Superseal 1.5

SCP02-xxx-xx-0A

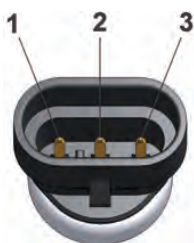

PIN	2-wire 4...20 mA	0...5 V; 1...6 V; 0.5...4.5 V nom.; 0...10 V	0.5...4.5 V ratiometric
1	P-signal	0 V / GND	0 V / GND
2	n.c.*	P-signal	P-signal
3	V ₊	V ₊	V ₊

Material Plastic PBT-GF30 Ultradur B4300 G6 black
Protection class IP67

DT04-4P

SCP02-xxx-xx-0D

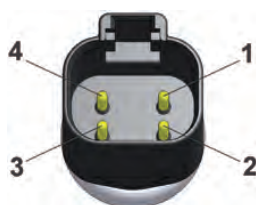

PIN	2-wire 4...20 mA	0...5 V; 1...6 V; 0.5...4.5 V nom.; 0...10 V	0.5...4.5 V ratiometric
1	V ₊	V ₊	V ₊
2	P-signal	0 V / GND	0 V / GND
3	n.c.*	P-signal	P-signal
4	n.c.*	n.c.*	n.c.*

Material Plastic PBT-GF30 Ultradur B4300 G6 black
Protection class IP67

DT04-3P

SCP02-xxx-xx-0E

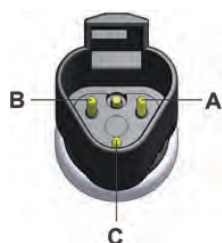

PIN	2-wire 4...20 mA	0...5 V; 1...6 V; 0.5...4.5 V nom.; 0...10 V	0.5...4.5 V ratiometric
A	V ₊	V ₊	V ₊
B	n.c.*	P-signal	P-signal
C	P-signal	0 V / GND	0 V / GND

Material Plastic PBT-GF30 Ultradur B4300 G6 black
Protection class IP67

2 m fixed cable

SCP02-xxx-xx-00



	2-wire 4...20 mA	0...5 V; 1...6 V; 0.5...4.5 V nom.; 0...10 V	0.5...4.5 V ratiometric
bn	V ₊	V ₊	V ₊
black	n.c.*	P-signal	P-signal
blue	P signal	0 V / GND	0 V / GND

Material Plastic PBT-GF30 Ultradur B4300 G6 black
Protection class IP69k

bn = brown-braun / bk = black-schwarz / bu = blue-blau
*n.c. = do not connect



SCP02 pressure sensor

Pin assignment

M12x1

SCP02-xxx-xx-x5

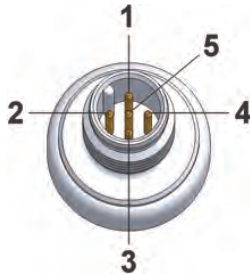

PIN	2-wire 4...20 mA	0...5 V; 1...6 V 0.5...4.5 V nom.; 0...10 V	0.5...4.5V ratiometric	CAN-Assignment
1	V ₊	V ₊	V ₊	CAN shield, PE
2	P-signal	P-signal	P-signal	+U _B , +24 VDC
3	n.c.*	0 V / GND	0 V / GND	GND, 0 V
4	n.c.*	n.c.*	n.c.*	CAN_H, CAN+
5	n.c.*	n.c.*	n.c.*	CAN_L, CAN-

Material

Plastic PBT-GF30 Ultradur B4300 G6 black

Protection class

IP67

*n.c. = do not connect

Pressure and temperature sensors

SCP02-xxx-xx-0A

AMP Superseal

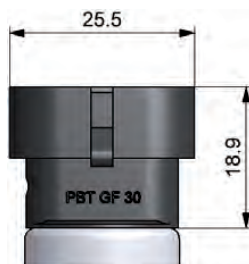

SCP02-xxx-xx-0D

DT04-4P

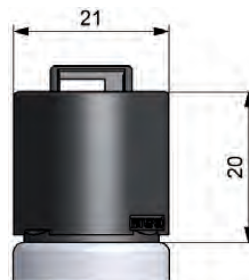

SCP02-xxx-xx-0E

DT04-3P

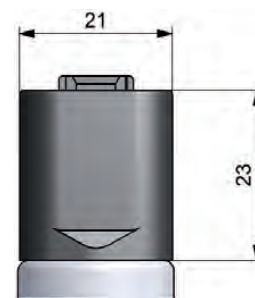

SCP02-xxx-xx-05

M12x1

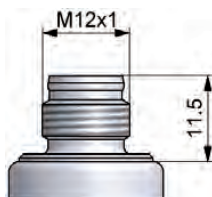

SCP02-xxx-xx-00

Stationary cable (2 m)

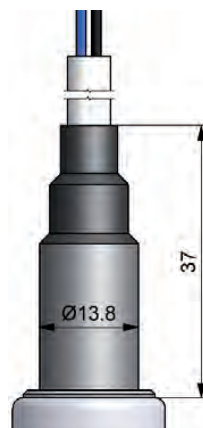

SCP02 pressure sensor

Pressure and temperature sensors

SCP02-xxx-x4-0x

G 1/4, DIN 3852 T 11 (Form E)

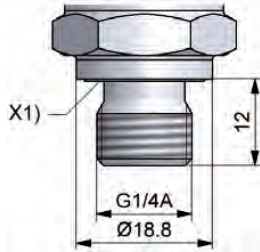

X1) = ED-seal

SCP02-xxx-x8-0x

G1/4 O-ring

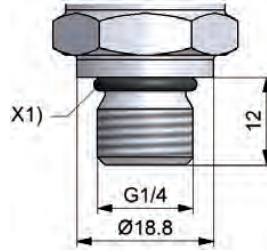

X1) = O-ring

SCP02-xxx-x5-0x

1/4 NPT

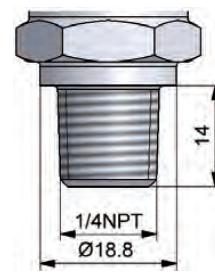

SCP02-xxx-x7-0x

SAE 04 - O-ring

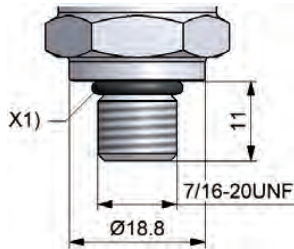

X1) = O-ring 8.92x1.83

SCP02-xxx-x6-0x

SAE 06 - O-ring

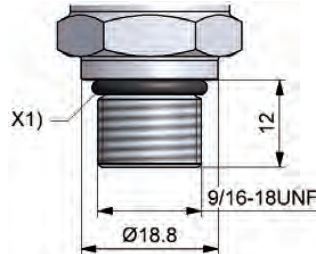

X1) = O-ring 11.89x1.98

SCP02-xxx-xx-0x

M12x1

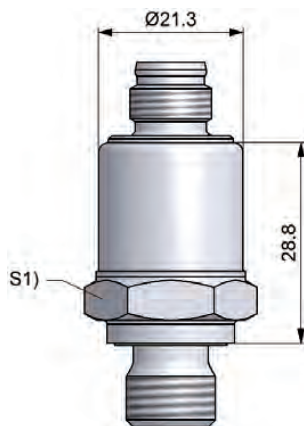

S1) = SW22



SCP02 pressure sensor

Order code

Pressure sensor SCP02	SCP02-xxxx-xx-0xQ8
Pressure range	
0...10 bar	010
0...25 bar	025
0...35 bar	035
0...40 bar	040
0...60 bar	060
0...100 bar	100
0...160 bar	160
0...250 bar	250
0...400 bar	400
0...500 bar	500
0...600 bar	600
0...1000 bar	1000
Output signal	
4...20 mA (2-wire)	3
4...20 mA (3-wire)	2
0...10 V	4
0...5 V	A
1...6 V	B
0.5...4.5 V (ratiometric)	R
0.5...4.5 V (nom.)	S
CAN	K
Process connection	
G1/4 BSPP	4
1/4 NPT (P _n max. = 600 bar)	5
9/16-18 UNF, SAE 6 O-ring (P _n max. = 400 bar)	6
7/16-20 UNF SAE-4 O-ring (P _n max. = 400 bar)	7
G1/4 O-ring (P _n max. = 600 bar)	8
Connecting plug	
Stationary cable 1 m	0
Circular connector M12x1 5-pole	5
Device plug AMP Superseal	A
Device plug DT04 4-pole	D
Device plug DT04 3 pole	E
Order quantity	
Q8: Multiple of 50 pcs.	

Connection cable and single plug

Connection cable, assembled (open cable end)	SCK-400-xx-xx
Cable length (m)	
2 m	02
5 m	05
10 m	10
Connecting plug	
M12 cable jack; straight	45
M12 cable jack; 90° angled	55
Single connector	
M12 cable jack; straight	SCK-145
M12 cable jack; 90° angled	SCK-155

Pressure and temperature sensors

Order example

50x SCP02-400-34-05Q8
 50 Single sensors
 Pressure range 400 bar
 Output signal 4 to 20 mA (2-wire)
 G1/4 BSPP
 M12 connecting plug 5-pole

SCP03 pressure sensor

Device features

- Monolithic design
 - No internal seal
 - No material mix
 - No weld seam
- High media compatibility
- Measuring range from -1 to 1000 bar
- Negative pressure resistant
- Many connections



The SCP03 is a pressure sensor for liquid and gaseous media.

The digitally calibrated piezoresistive measuring cell detects negative pressures from -1 bar up to high pressures of 1000 bar.

The pressure connection in contact with the medium has a monolithic design. This eliminates the need for internal seals and weld seams. A mix of materials is avoided.

The resulting low permeability in combination with the stainless steel results in broad media resistance.

The compact stainless-steel housing allows space-saving use, even in harsh environmental conditions. With its wide range of pressure ranges, output signals and connectors, the SCP03 can be used in industrial and mobile applications.

The packaging variant optimized for OEM's is environmentally friendly, cost-optimized and facilitates handling.

Typical application range

- Mobile hydraulics
- Transport vehicles
- Conveyor vehicles
- Commercial vehicles
- Automotive technology
- Brake systems
- Oil pressure
- Test equipment and technology
- Gearbox control

SCP03 pressure sensor

Technical data

SCP03-	004R	010R	010R	025R
Pressure range -1 ... bar	3	9	15	24
P _n relative (-14.5 ... psi)	(43,5)	(130)	(218)	(348)

SCP03-	004	010	016	025	035	040	060	100	250	400	500	600	1000
Pressure range	4	10	16	25	35	40	60	100	250	400	500	600	1000
P _n relative 0 ... bar / (psi)	(58)	(145)	(232)	(363)	(500)	(580)	(870)	(1450)	(3626)	(5800)	(7300)	(8702)	(14,503)
Overload pressure P _{max} DIN EN 60770-1 (bar) relative	2 x P _n												
Burst pressure P _{burst} DIN EN 60770-1 (bar) relative	3 x P _n												

SCP03-	0150P	0250P	1000P	3000P	5000P	9000P
Pressure range P _n relative 0... (psi)	150	250	1000	3000	5000	9000
Overload pressure* P _{max}	2 x P _n					
Burst pressure** P _{burst}	3 x P _n					

General

Response time	≤1 ms
Load change	> 100 million
Material Housing	EN/DIN 1.4301
Material Electr. Connector	PBT-GF30 black
Weight	Approx. 80 g

Accuracy parameter

Non-linearity + Hysteresis + Repeatability	≤0.3 %FS
Long-term stability	≤1.0 %FS / year

Overall Accuracy

	< 10 bar (145 psi)	≥ 10 bar (145 psi)
@ 25°C	≤ 0.5 %FS	≤ 0.5 %FS
@ 0°C...+85°C	≤ 2 %FS	≤ 1 %FS

Ambient conditions

Media temperature	-40...+125 °C / (-40...257°F)
Operation / Ambient temperature	-40...+105 °C / (-40...221°F)
Storage temperature	-40...+125 °C / (-40...257°F)
Vibration resistance	IEC 60068-2-6: 20 g
Shock resistance	IEC 60068-2-27: 1000 g

Conformity

CE	EN 61326-1 EN61326-3-1
RoHs	Yes
MTTFd	> 100 years

Process connection	Seal	Wetted parts
G1/4A BSPP; DIN 3852 T11, Form E	DIN 3869-14-FKM	EN/DIN 1.4404 / FKM
SAE-4: 7/16-20 UNF O-ring	FKM	EN/DIN 1.4404 / FKM
SAE 6: 9/16-18 UNF O-ring	FKM	EN/DIN 1.4404 / FKM
G1/4 DIN ISO 228-1 O-ring	FKM	EN/DIN 1.4404 / FKM
1/4 NPT		EN/DIN 1.4404



SCP03 pressure sensor

Pressure and temperature sensors

Pin assignment



Output signal	(2 wire) 4...20 mA	0...20 mA 4...20 mA	0.5...4.5 V 0...5 V	1...6 V 0...10 V	0.5...4.5 V ratio.
Supply Voltage V_+	10...32 VDC	12...32 VDC	8...32 VDC	12...32 VDC	5 V \pm 10%
Load $_{max}$	$\leq (V_+ - 10V) / 20 \text{ mA}$ [k Ω]		4.7 [k Ω]		
Overvoltage	50 VDC				
Short circuit	Yes				
Rever polarity	Yes				
Signal on GND / V_+	Yes				

M12x1 4-pole					
Pin 1			V_+		
Pin 2			P-Signal		
Pin 3	n.c.			0 V / GND	
Pin 4	n.c.			n.c.	
IP 67					

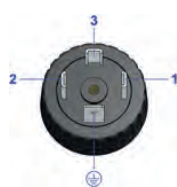

DIN EN 175301-803 Form A 4-pole (old 43650)					
Pin 1			P-Signal		
Pin 2	n.c.			0 V / GND	
Pin 3			V_+		
Pin 4 / GND			n.c.		
IP 65					



AMP Superseal 1.5					
Pin 1	P-Signal			0 V / GND	
Pin 2	n.c.			P-Signal	
Pin 3			V_+		
IP 65					



DT04-4P					
Pin 1			V_+		
Pin 2	P-Signal			0 V / GND	
Pin 3	n.c.			P-Signal	
Pin 4 / GND			n.c.		
IP 65					



DT04-3P					
A			V_+		
B	n.c.			P-Signal	
C	P-Signal			0 V / GND	
IP 65					



Junior Timer					
Pin 1	P-Signal			0 V / GND	
Pin 2	n.c.			P-Signal	
Pin 3			V_+		
IP 65					

Cable					
Bn			V_+		
Black			P-Signal		
Blue	n.c.			0 V / GND	
IP 69K					



SCP03 pressure sensor

Pin assignment

SCP03-...-07
M12 4P

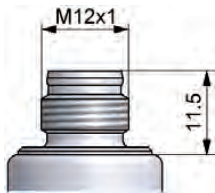

SCP03-...-06
DIN EN 175301-803
Form A

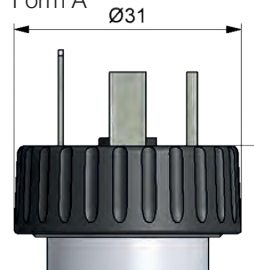

SCP03-...-0D
DT04 4P

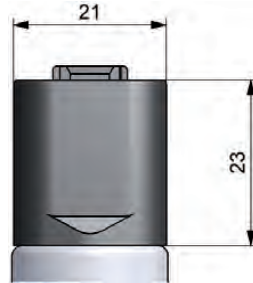

SCP03-...-0E
DT04 3P

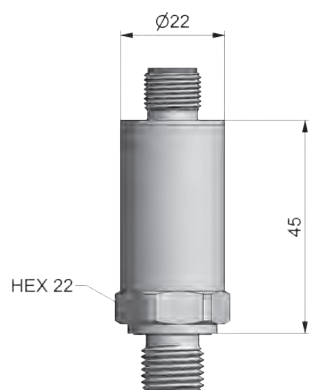
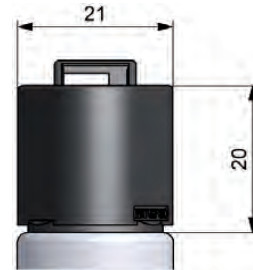

SCP03-...-0A
Superseal

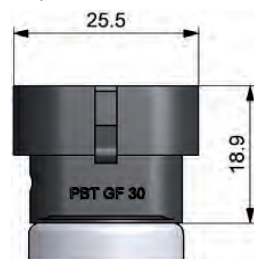

SCP03-...-0J
Junior Timer 3P

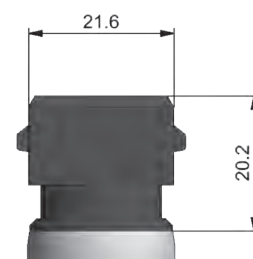

SCP03-...-00
Cable

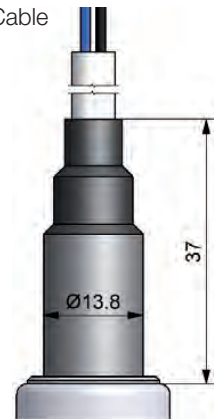

SCP03-xxx-x4-0x
G 1/4, DIN 3852 T 11 (Form E)

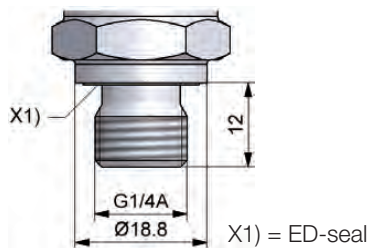

SCP03-xxx-x8-0x
G 1/4 O-ring

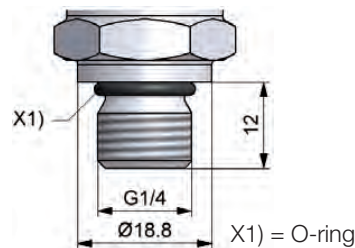

SCP03-xxx-x5-0x
1/4 NPT

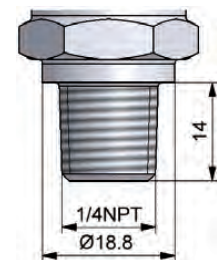

SCP03-xxx-x6-0x
SAE 06 - O-ring

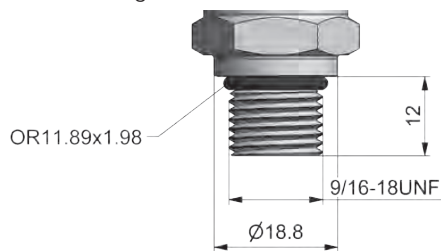

SCP03-xxx-x7-0x
SAE 04 - O-ring

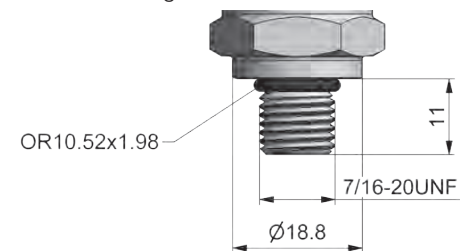

SCP03 pressure sensor

Pressure and temperature sensors

Order code

Pressure sensor SCP03

Pressure range

-1...3 bar	004R
-1...9 bar	010R
-1...15 bar	016R
-1...24 bar	025R
0...4 bar	004
0...10 bar	010
0...16 bar	016
0...25 bar	025
0...35 bar	035
0...60 bar	060
0...100 bar	100
0...160 bar	160
0...250 bar	250
0...400 bar	400
0...500 bar	500
0...600 bar	600
0...1000 bar	1000
0...150 psi	0150P
0...250 psi	0250P
0...1000 psi	1000P
0...3000 psi	3000P
0...5000 psi	5000P
0...9000 psi	9000P

Output signal

0...20 mA	1
4...20 mA (3-wire)	2
4...20 mA (2-wire)	3
0...10 V	4
0...5 V	A
1...6 V	B
0.5...4.5 V (ratiometric)	R
0.5...4.5 V (nom.)	S

Process connection

G1/4 BSPP	4
1/4 NPT (P _n max. = 600 bar)	5
9/16-18 UNF, SAE 6 O-ring (P _n max. = 400 bar)	6
7/16-20 UNF SAE-4 O-ring (P _n max. = 400 bar)	7
G1/4 O-ring (P _n max. = 600 bar)	8

Damping

Without damping	O
With damping	D

Connecting plug

Device connector DIN EN 175301-803 Form A 4-pole	6
Circular connector M12x1 4-pole	7
Stationary cable 2 m	0
Device plug AMP Superseal	A
Device plug DT04 4 pole	D
Device plug DT04 3 pole	E
Junior Timer 3-pole	J

SCP03-xxx-xx-xxQ8

Order quantity

Minimum order qty:

Q8: Multiple of 50 pcs.

Available single versions

Pressure sensor SCP03 Industrial

Pressure range

0...10 bar	010
0...25 bar	025
0...60 bar	060
0...250 bar	250
0...400 bar	400
0...600 bar	600

Output signal

4...20 mA (3-wire)	2
4...20 mA (2-wire)	3
0...10 V	4

Process connection

G1/4 BSPP	4
-----------	----------

Connecting plug

Device connector DIN EN 175301-803 Form A 4-pole	6
Circular connector M12x1 4-pole	7

Pressure sensor SCP03 Mobile

Pressure range

0...10 bar	010
0...25 bar	025
0...60 bar	060
0...250 bar	250
0...400 bar	400
0...600 bar	600

Output signal

4...20 mA (2-wire)	3
0.5...4.5 V (ratiometric)	R

Process connection

G1/4 BSPP	4
-----------	----------

Connecting plug

Device plug DT04 4 pole	D
-------------------------	----------

Order example

150x SCP03-400-34-07Q8

150 Single sensors (multiple of 50's)

Pressure range 0...400 bar

Output signal 4 to 20 mA (2-wire)

G1/4 BSPP

Without damping

M12 connecting plug 4-pole



Pressure sensor SCP07

Device features

- For safety requirements
- PLd
- SIL 2
- Two inverted 4-20 mA outputs
- Up to 600 bar (8,702 psi)
- G1/4 DIN 3852-11 (E)
- Compact design
- Long term stability
- Wide temperature range -40...85°C (-40...185°F)



The SCP07 is a safety-related pressure transmitter and can be used in applications that require a Performance Level d according to EN ISO13849 or a SIL 2 according to IEC61508.

The SCP07 supervises the signals of its measurement cell and convert the pressure in two inverted 4-20 mA output signals. The control unit can monitor the safety-related functionality and the electrical connectivity of the SCP07.

Typical application range

- Mobile hydraulic
- Cranes
- Suspended loads
- Tire presses

Pressure sensor SCP07

Pressure and temperature sensors

Technical data

SCP07-	010	025	060	100	250	400	600
Pressure range P_n 0... bar / (psi) relative	10 (145)	25 (363)	60 (870)	100 (1450)	250 (3626)	400 (5802)	600 (8702)
Overload pressure P_{max} DIN EN 60770-1 bar / (psi) relative	50 (725)	50 (725)	200 (2901)	200 (2901)	500 (7252)	800 (11,603)	1600 (23,206)
Burst pressure P_{burst} 60770-1 bar / (psi) relative	250 (3626)	250 (3626)	1000 (14,504)	1000 (14,504)	2500 (36,259)	4000 (58,015)	>4000 (>58,015)

General		MTBF (SN29500)	420,7 years
Response time	≤1 ms	Output signal	4...20 mA / 20...4 mA
Load change	>100 million	Supply voltage V_+	9...32 VDC ripple @50HZ 10 %
Material Housing	Stainless steel 1.4301	Load _{max}	$(V_+ - 5.5 V) / 0,02 A [\Omega]$
Weight	Approx. 50 g	Protection	Overvoltage yes
Process Connection	G1/4, DIN 3852 T11 (E)		Short circuit yes
Material	Stainless steel 1.4548		Reverse polarity yes
Material diaphragm	Stainless steel 1.4548		Signal on GND/ V_+ yes
Wetted parts	FKM Stainless steel 1.4548		
Seal	ED Type: FKM		
Installation torque	Max. 35 Nm		
Ambient Conditions		M12x1	
Media temperature	-40...125°C / (-40...257°F)	Protection class IEC 60529 (mounted connector)	IP67
Operation / Ambient temperature	-40...85°C / (-40...185°F)	Material	PBT-GF30
Storage temperature	-40...100°C / (-40...212°F)		Pin 1 V_+
Vibration	IEC 60068-2-6 :20g		Pin 2 20...4 mA
Shock	IEC 60068-2-27 :500g		Pin 3 GND
Conformity			Pin 4 4...20 mA
CE	EN 61326-1, EN 61326-3-1		Pin 5 Do not connect!
E1	All vehicle types with +12/24 V and battery (-) at the chassis		

Accuracy Parameter	
Non-linearity + Hysteresis+Repeatability	≤0,5 %FS
Long-term stability	≤0,2 %FS / year
Overall Accuracy	
@ -40°C...-25°C	≤2,5 %FS
@ -25°C...0°C	≤1,5 %FS
@ 0...85°C	≤1 %FS
Safety classification	
IEC 61508:2010	SIL 2
Safety-related subsystem	Type B
Hardware architecture	1oo1
HFT	0
SFF (incl. control unit)	95 %
PFH	8,4 *10E-9
EN ISO 13849-1:2010	PLd
Category	2
DC (incl. control unit)	93,8 %
CCF	70
MTTF _D	>100 years

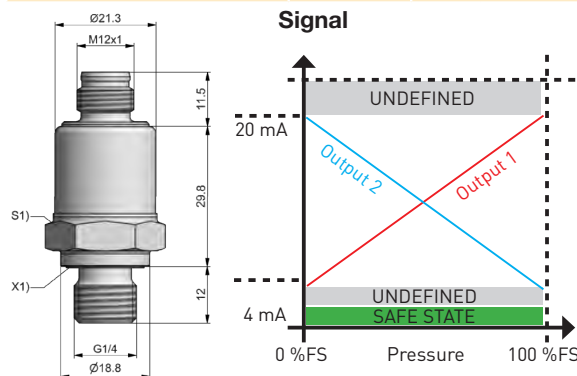

Order code
Pressure sensor SCP07 **SCP07-xxx-24-05Q8**

Pressure range

0...10 bar.....	010
0...25 bar.....	025
0...60 bar.....	060
0...100 bar.....	100
0...250 bar.....	250
0...400 bar.....	400
0...600 bar.....	600

Order quantity
 Q8: Multiple of 50 pcs.



Pressure sensor SCP08

Device features

- 600 / 1000 bar (8,702 / 14,504 psi)
- G1/4"
- 0-10V / 4...20mA 2-wire
- M12x1 / DIN
- Reinforced internal design
- Persistence against shock & vibration
- Made for high pressure acceleration
- High dynamic signal



Particularly in die-casting applications the controlling for the piston requires a high dynamic pressure sensor. During this fast, high energetic process the components are stressed by shock, vibration and pressure acceleration.

The pressure sensor SCP08 measures the pressure via a special designed measurement cell and has a high adapted overload pressure to withstand the pressure peaks.

To avoid abrasion of the cell due to Diesel or similar effects, the process connection is protected by an adjusted drilling. The dimension of the drilling still guaranties an instantaneous pressure response.

To increase shock and vibration resistance, the relevant internal components are covered and reinforced. The speed of the sensor influences directly the quality of the production process.

The unique combination of accuracy, durability and high dynamic response makes the SCP08 ideal for the requirements of die-casting applications.

Typical applications

- Press construction
- Die-casting

Pressure sensor SCP08

Technical data

SCP08-	600	1000
Pressure range P_n 0... bar / (psi) relative	600 (8702)	1000 (14,504)
Overload pressure P_{max} bar / (psi) relative	1200 (17,405)	1500 (21,756)
Burst pressure P_{burst} bar / (psi) relative	1800 (26,107)	2000 (29,008)

General

Response time	0...10 V $\leq 0,3$ ms 4...20 mA 2-Leiter $\leq 0,5$ ms*
Load change	>10 million.
Material Housing	Stainless steel 304
Weight	Approx. 80 g

Ambient Conditions

Media temperature	-40...125°C / (-40...257°F)
Operation- / Ambient temperature	-40 to 105°C / (-40...221°F)
Storage temperature	-40 to 125°C / (-40...257°F)
Vibration	20 g rms
Shock	1 m on concrete

Conformity

CE	yes
----	-----

Overall Accuracy

@ RT *1	$\leq 0,5$ %FS
@ -10°C...85°C *1 *2	≤ 2 %FS
@ -40...105°C *1 *2	$\leq 2,5$ %FS
Long-term stability	$\leq 0,2$ %FS / year

*1 incl. Non-linearity + Hysteresis + Offset + Gain

*2 incl. Repeatability + Temperature effects

RT = Room Temperature 20°C

Process Connection

Thread	G1/4, DIN 3852 T11 (E)
Eroding milling	0,6 mm
Volume measured	< 1 mm ³
Seal	ED Type: FKM
Material	Stainless steel 17-4 PH
Material diaphragm	Stainless steel 17-4 PH
Wetted parts	FKM Stainless steel 17-4 PH

Installation

Installation torque	Max. 35 Nm
General	no restriction

Recommended preventive activities to avoid air inclusion:

- Bleed air
- Installation with Process connection on top

*with 2 m cable

Output signal	0...10 V	4...20 mA 2-wire
Supply voltage V_+	12...32 VDC	10...32 VDC
Load _{max}	10 k Ω	$(V_+ - 10$ V) / 20 mA
Protection	Overvoltage	36 signal on GND/ V_+
	Short circuit	yes
	Reverse polarity	yes
	Signal on GND/ V_+	yes

M12x1

Protection class (mounted connector)	IP67	0...10 V	4...20 mA 2-wire
	Pin 1	V_+	V_+
	Pin 2	P-signal	P-signal
	Pin 3	V_-	
	Pin 4		

DIN EN 175301-803 Form A

Protection class (mounted connector)	IP65	0...10 V	4...20 mA 2-wire
	Pin 1	V_+	V_+
	Pin 2	V_-	P-signal
	Pin 3	P-signal	
	Pin 4		

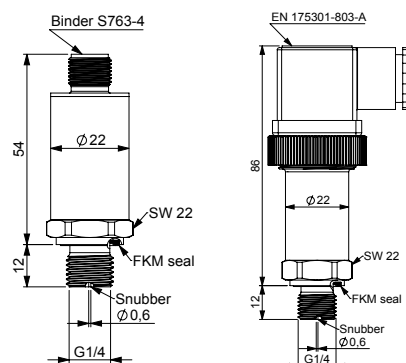

Order code

Pressure sensor SCP-08
4...20 mA; 2-wire

Pressure range (bar)
0...600 bar
0...1000 bar

Output signal
4...20 mA (2-wire)
0...10V

Connecting plug
DIN EN 175301-803 Form A 4 pole
M12x1 4 pole

Order quantity

Q2: Multiple of 5 pcs.
Q8: Multiple of 50 pcs.

SCP08-xxxx-x4-0x

600
1000

3
4

6
7

SCPSi pressure switch

Device features

- Pressure sensor / -switch
- Temperature measurement
- Industry 4.0-ready
- IO-Link 1.1
- Smart Sensor Profile 2nd edition
- Plug & Play
- Compact
- Optimized design
- Adjustable via IO-Link
- Readable via IO-Link
- Useable as IO-Link sensor or switch
- Monolithic pressure cell



The fully electronic pressure switch SCPSi is adjustable and free from susceptible mechanical and moving components.

With its digital interface and smart functions, the SCPSi is future-proof for the increasing demands of automation solutions.

The 2 switching outputs are individually and safely parameterized from the machine control system via the standardized digital IO-Link interface (IEC 61131-9). This replaces manual programming and the commissioning phase is considerably shortened. Devices can be replaced during operation without the need for reparameterization. In order to react promptly to machine status changes or process adjustments, the re-parameterization is carried out during operation.

As an alternative to the switching functions, diagnostic values, process data and status messages are recorded directly via IO-Link and enable subsequent more complex analyses. Via the integrated temperature measurement of the pressure measuring cell, the media or ambient temperature is recorded.

IO-Link replaces time-consuming manual programming and eliminates the need for a sensitive key display with the manufacturer-dependent setting menu. This more compact, more resistant design without key display, in combi-

nation with the smart functions & setting options, opens up new possibilities in machine design for the machine designer, with considerable savings potential.

The compact stainless steel housing allows space-saving use, even in harsh environments.

The proven stainless steel measuring cell with the wide pressure range (from -1 up to 600 bar) allows a wide range of applications for liquid and gaseous media. The media-contacting pressure connection with the pressure measuring cell is monolithically manufactured from a stainless steel without welds and sets new standards in media compatibility and pressure resistance.

The packaging variant optimized for OEM's is environmentally friendly, cost-optimized and facilitates handling.

Application examples

- Injection-mould machines
- Tool-making machines
- Power packs
- Special machine construction
- Replacement for mechanical pressure switches

SCPSi pressure switch

Technical data

SCPSi		001	004	010	025	060	100	250	400	600
Pressure range P _n	bar	-1...1	-1...4	-1...10	-1...25	0...60	0...100	0...250	0...400	0...600
vacuum tight / relative P _n	(psi)	(-14...14)	(-14...58)	(14...145)	(-14...362)	(0...870)	(0...1450)	(0...3625)	(0...5801)	(0...8702)
Overload pressure	bar	6	10	030	80	200	300	750	1200	1400
relative P _{max}	(psi)	(87)	(145)	(435)	(1160)	(2900)	(4351)	(10877)	(17404)	(20305)
Burst pressure	bar	9	15	100	150	500	800	1000	2000	2200
relative P _{burst}	(psi)	(130)	(217)	(1450)	(2175)	(7251)	(11603)	(14503)	(29007)	(31908)
Wetted parts		1.4542 (17-4PH); 1.4548; FKM			Monolitisch 316L; FKM					
Set point SP Range		1 - 100 %								
Reset point rP Range		0 - 99 %								
Steps / Incremental	mbar	0,1	1	1	1	10	10	10	100	100
Smallest hysteresis (SP-rP) & (FH-FL)	bar	0,001	0,01	0,01	0,01	0,1	0,1	0,1	1	1

General

Overall Accuracy @ RT ^[1]	≤ 0,5 %FS
Min. pressure cycles	> 100 million
Material housing	Stainless steel 1.4404
Weight	approx. 80 g

Conformity

RoHS	2011/65/EU, 2015/863
CE	Yes
UKCA	Yes

Process connection

Thread	G1/4, DIN 3852 T11 (E)
Seal	ED type: FKM
Installation torque	Max. 35 Nm

Ambient conditions

Media temperature	-25 to 85 °C (-13 to 185°F)
Operation / Ambient temperature	-25 to 85 °C (-13 to 185°F)
Storage temperature	-40 to 85 °C (-40 to 185°F)
Vibration	DIN EN 60068-2-6, 20 g
Shock	DIN EN 60068-2-27, 500 g
MTTFd	>100 year

Accuracy

@ -40°C...-25°C	≤ 2,5 %FS
@ -25...0°C	≤ 1,5 %FS
@ 0...85°C	≤ 1 %FS

Temperature signal

Output	Via IO-Link
Short circuit	-40 to 125 °C
Resolution	1 K
Accuracy	± 10°K
t _{0,9}	80 sek.

Protection

Overvoltage	70 V
Short circuit	yes
Reverse polarity	yes
Signal on GND/V ₊	yes

Factory setting

SP1 / rP1	40 / 60% FS; Hno
SP2 / rP2	30 / 70% FS; Hno

Electronic Connectivity

Power supply voltage V ₍₊₎	18...30VDC
Connector	M12
Consumption	< 15 mA @ 24V
Output	2 switching outputs, NPN / PNP, 1 IO-Link output
Switch current	Max. 200mA
Max. switch frequency	200 Hz
Response time	≥ 3 ms

IO-Link Interface

Revision	IO-Link V1.1 Process Data Variable; Device Identification; Device Diagnosis
Min. process cycle time	4 ms
Transmission type	COM2, 38.4kBaund
Profile	Smart Sensor Profile 2 nd Edition v1.1.2
SIO-Mode	yes
Master port type	A
Process data analogue (in Pa)	2 Byte Process data 1 Byte scaling factor
Process data binary	1 byte
SDCI Standard	IEC 61131-9
Vendor ID	271 / 10f (hex)
Device IODD	https://ioddfinder.io-link.com/#/

M12x1

Protection class (mounted connector)	IP67	
	Pin 1	V ₍₊₎
	Pin 2	S2 out
	Pin 3	0V / GND
	Pin 4	S1 out / IO-Link

SCPSi pressure switch

Order code

SCPSi Pressure switch

SCPSi-xxx-04-07

Druckbereich	
0...001 bar	001
0...004 bar	004
0...010 bar	010
0...025 bar	025
0...060 bar	060
0...100 bar	100
0...250 bar	250
0...400 bar	400
0...600 bar	600

Pressure and temperature sensors



SCT-150 temperature sensor

Device features

- Withstands pressures up to 630 bar (9137psi)
- Compact design
- Heavy-duty steel housing
- Simple installation
- -25 °C...+100 °C (-13...212°F)



The SCT electronic temperature sensor features a compact design and high pressure resistance.

The SCT is used where temperatures have to be measured under high pressure and a compact housing is necessary.

With its pressure resistance up to 630 bar, the SCT temperature sensor is well suited for hydraulic applications.

It can be used for precise and quick temperature measurements.

The SCT series temperature sensors are compatible with the SCE panel meters. So both the hydraulic pressure and the substance temperature can be measured, checked and evaluated.

Application examples

- Test benches
- Processing equipment
- Conveying and lifting equipment
- Machine construction
- Pneumatic plant construction
- Hydraulic plant construction

SCT-150 temperature sensor

Technical data

Input	
Measuring range	-25...+100 °C / (-13...212°F)
Accuracy	< ± 7 K
Response time	$\tau_{0,9} = 13.5$
Output	
Output _T (scaling for output!)	0...20 mA = -50...+125 °C
Load	≤ 250 Ω
Process connection	
G1/4A ED or M10x1	
Seal	FKM
Housing	Steel C15K/CF
Operating pressure P _n	630 bar / (9137 psi)
Parts in contact with substances	Steel C15K/CF, FKM
Ambient conditions	
Power supply V ₊	+11...+24 VDC
Current consumption	< 30 mA
Ambient temperature range	-20...+70 °C / (-4...158°F)
Fluid temperature range	-25...+125 °C / (-13...257°F)
Storage temperature	-25...+80 °C / (-13...176°F)
Electrical connection	M12x1
Protection degree	IP67

Pin assignment

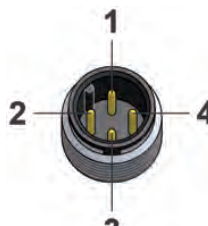

Cable	Assignment
1	V ₊
2	T-signal
3	0 V / GND
4	n.c.*

*n.c. = do not connect

Order code

Temperature sensor G1/4
Temperature sensor M10x1

SCT-150-41-07
SCT-150-14-07

SCT-150-xx-07

Circular connector M12x1; 4-pole

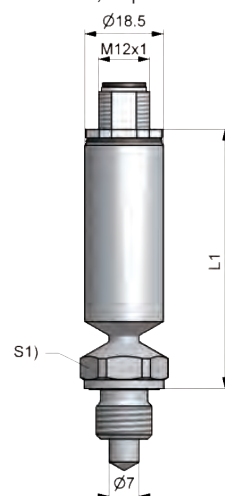

S1) = 19

SCT-150-41-07

G1/4A ED

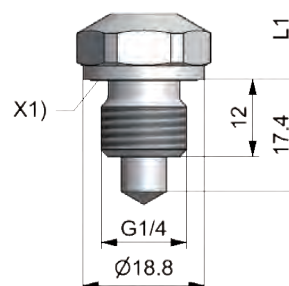

L1) = 61

X1) = ED seal

SCT-150-14-07

M10x1

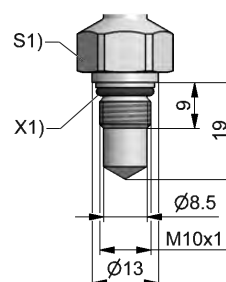

X1) = O-ring

Volumetric flow rate sensors

Device features

- Different measurement techniques
 - Quick
 - Not dependent on viscosity
 - Without loss
- Many measurement ranges
- Analogue output signal
- M12 connecting plug
- 24 VDC



The flow sensors used in **SensoControl®** provide accurate volume flow information in hydraulic systems (e.g. in testing equipment).

The sensors deliver a output signal that is proportional to the volumetric flow rate for further processing to an electronic system. They are compatible with conventional, well-known standards.

- M12 connecting plug
- 24 VDC
- 0/4 to 20 mA

The volumetric flow rate can be easily displayed when using the **SCE-020** panel meter.



In order to meet the many different application requirements, three different measuring principles are available:

- **SCVF** geared counter
- **SCFT** turbine
- **SCQ** spring/piston

The volumetric flow rate sensors are used in control, regulation or monitoring systems where analogue signals are needed to capture the volume flow.

Volumetric flow rate sensors

Overview

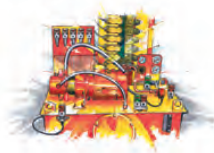
	SCQ	SCFT	SCVF
			
Range of use	For quick flow changes Measures in both directions <ul style="list-style-type: none"> Response speed ≤ 2 ms Reverse operation Wide viscosity range Compact size Up to 420 bar (6092 psi) 	Low loss measuring of volume flow <ul style="list-style-type: none"> Response speed ≤ 50 ms Many measurement ranges Low flow resistance Up to 800 l/min Up to 420 bar (6092 psi) 	Measures different substances Measures lower volume flows (leakage measurements) <ul style="list-style-type: none"> Very wide measurement range Not dependent on viscosity Up to 400 bar (6092 psi)
Applications	<ul style="list-style-type: none"> Test rigs General machine construction Hydraulic plant construction 		
Order code	SCQ-xxx-10-07	SCFT-xxx-22-07	SCVF-xxx-10-07
Refer to page	37-41	42-45	46-51

Volumetric flow rate sensors

SCQ flow meter

Device features

- Measurement principle Spring/piston principle
- Response time ≤ 2 ms
- Measurement in both directions
- Wide viscosity range
- Compact design
- Withstands pressures up to 420 bar (6092 psi)

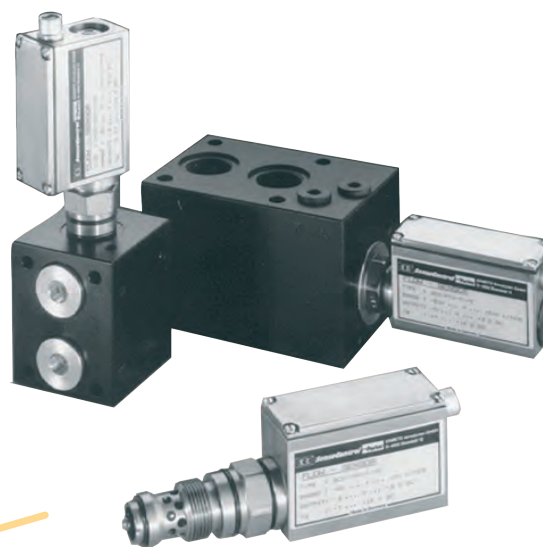

Volumetric flow rate sensors

Function

The piston (K) is moved due to a flow from A to B or from B to A. In the idle state, the spring (F) and the piston (K) are in equilibrium. The delta (S) is proportional to the flow and is converted to a value through the built-in electronics. Through the change in direction of the piston (B to A), the flow direction can be indicated. (e.g. -45.8 l/min) The reaction time of the piston movement is less than 2 ms.

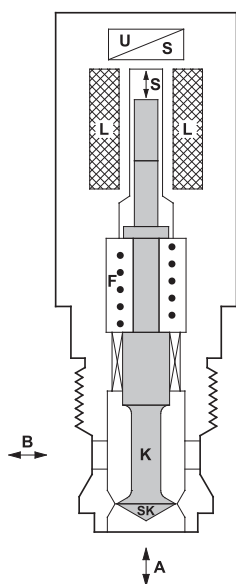

SCQ measurement principle

Application

When working with high-pressure hydraulics, it is very important to be able to quickly detect the flow rate.

Installation with a connection block permits the combined measurement of p, T and Q. Rapid assembly of the **SCQs** is achieved with an in-line adaptor for tube or hose installation. Use under extreme conditions (such as high load changes or rapid pressure increases) is possible because of the sturdy construction.

The **SCQ** is the perfect solution when recording highly dynamic volume flow changes. Rapid load changes, which can cause damage for example in valves and pumps, can be safely detected. Due to its unique measurement process, the **SCQ** can capture volume flow in both directions.

SCQ flow meter

Technical data

SCQ-	150
Measuring range QN	-150...+150 l/min
Q _{max}	-165...+165 l/min
Substance connection	M42 (NG16)
Weight (g)	1050

Accuracy	
Deviation from characteristic curve	±2 % FS @ 46cSt.
Response time	2 ms
Thermal drift	±0.05 % FS/°C
Repeat accuracy	± 0.5 % FS

Resistance to pressure	
Pressure range	3...420 bar
Operating pressure P _n	315 bar / (4569 psi)
Overload pressure P _{max}	420 bar / (6092 psi)
Pressure drop ΔP (bar) @ (FS)	Refer to diagram

Material	
Housing	Steel
Seal	NBR
Parts in contact with substances	Steel, NBR

Ambient conditions	
Operating temperature	+10...+60 °C / (50...140°F)
Storage temperature	-20...80 °C / (-4...176°F)
T _{max} Fluid	+80 °C / (176°F)
Filtration	25 μm

Viscosity range	15...100 cSt.
Protection degree	IP67 DIN EN 60529

Electrical connection	
Plug	M12x1; 4-pole
Supply voltage	+18...+30 VDC
Current consumption	40 mA
Output	0...20 mA = -FS...+FS (10 mA = 0 l/min)
Load	≤ 150 Ω
Signal noise	< 5 mV

EM compatibility	
Disturbance emissions	EN 61000-6-3
Resistance to interference	EN 61000-6-2

Volumetric flow rate sensors

Pin assignment

M12x1; 4-pole

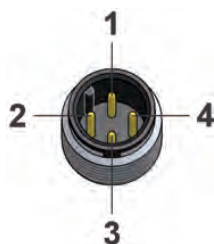

PIN	Assignment
1	V ₊
2	Q signal
3	0 V / GND
4	-

SCQ flow meter

SCAQ-GI-R1/2

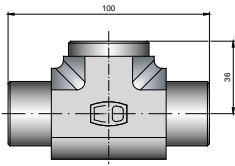

SCAQ-150

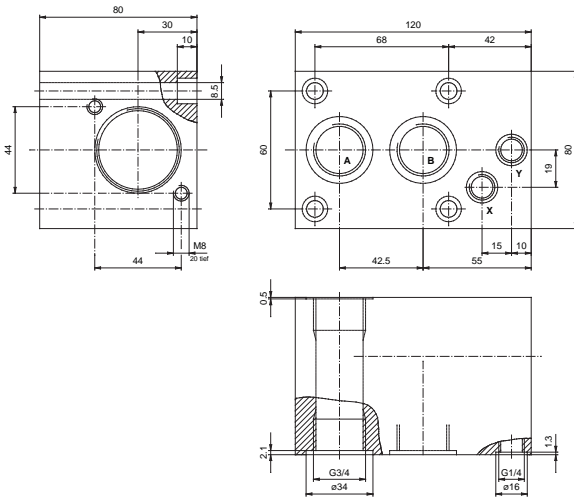

Order code

SCQ-150 (-150 to +150 l/min)

M12x1, 4-pole; connecting plug; IP67
0 to 20 mA; -150...+150 l/min

SCQ-150-10-07

Accessories SCQ-150

Connector block
G3/4 BSPP inner (A-B) and M42 inner
With screw plug:
M42 outer and
G3/4 BSPP outer (A-B)

SCAQ-150

Spare parts

Spacer ring for SCQ-060
Seal kit for SCQ-060
Seal kit for SCQ-150

SC-910

SC-911

SC-912

Connection cable and single plug

Connection cable, assembled
(open cable end)

SCK-400-xx-xx

Cable length (m)

2 m

5 m

10 m

02

05

10

Connecting plug

M12 cable jack; straight

M12 cable jack; 90° angled

45

55

Single connector

M12 cable jack; straight

M12 cable jack; 90° angled

SCK-145

SCK-155

Volumetric flow rate sensors

SCFT measurement turbine

Device features

- Measurement principle: Turbine
- Response speed ≤ 50 ms
- Measurement range from 1 to 800 l/min
- Low flow resistance
- Suitable for reverse operation
- Built-in pressure and temperature ports



Function

The turbine wheel is driven by the oil flow. The generated frequencies are processed through the digital electronics and influences from the disturbing flow effects are compensated for. Because of the low flow resistance Q_R , the hydraulic circuit operates with very low losses.

Reverse operation is also possible because of the special vane (winged) design - so the turbine can be operated in both directions.

The turbine is fitted with an EMA-3 screw coupling for measuring pressure. Oil temperature can be measured directly in the oil flow of the turbine by connecting the temperature sensor (SCT-150). This provides all important measurements at the installation location.

Application

The SCFT is the ideal solution if the volumetric flow rate needs to be recorded loss-free across a wide flow range (up to 800 l/min.).

Volumetric flow rate sensors

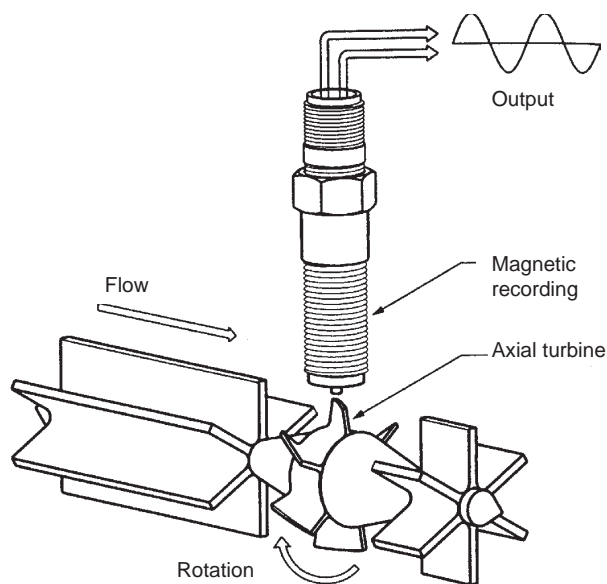

SCFT measurement turbine

Technical data

SCFT-	015	060	150	300	600	800
Flow measuring range Q _n (l/min)	1...15	3...60	5...150	8...300	15...600	20...800
Accuracy (± %) FS/IR @ 21cSt.	± 1 % FS	± 1 % IR	± 1 % IR	± 1 % IR	± 1 % IR	± 1 % IR
Operating pressure P _n bar / (psi)	350 (5076)	350 (5076)	350 (5076)	350 (5076)	290 (4206)	400 (5801)
Ports (A - B)	G1/2 BSPP	G3/4 BSPP	G3/4 BSPP	G1 BSPP	G1 1/4 BSPP	G1 7/8 UNF
Pressure drop ΔP (bar) @ (FS)	1.5	1.5	1.5	4	4	5
Weight (g)	700	1600	1600	1700	2700	5000

FS = Full Scale
IR = Indicated Reading

Accuracy	
Response time	50 ms
Thermal drift	±0.05 % FS/°C
Repeat accuracy	± 0.5 % FS
Resistance to pressure	
Q _{max} (l/min)	Q _N x 1.1
Overload pressure P _{max}	P _N x 1.2
Material	
Housing	Aluminium
Seal	FKM
Parts in contact with sub- stances	Aluminium, steel, FKM
Ambient conditions	
Ambient temperature	-10...+50 °C / (14...122°F)
Storage temperature	-20...+80 °C / (-4...176°F)
T _{max} Fluid	-20...+80 °C / (-4...176°F)
Filtration	25 μm (10 μm for SCFT-015)
Viscosity range	15...100 cSt.
Protection class	IP66 EN60529

Ports	
Temperature measurement (SCT-150-14-07)	M10x1 OR
Pressure connection	EMA3
Pressure (VSTI)	G1/4 BSPP
Electrical connection	
Plug	M12x1; 5-pole
Power supply V ₊	18...30 V
Output signal	4...20 mA ± 0...FS l/min
Complete output current range	0...21 mA
Current consumption	< 30 mA
Protection degree	IP66 EN60529

Volumetric flow rate sensors

Pin assignment

M12x1; 5-pole

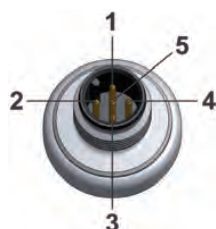

PIN	Assignment
1	V ₊
2	n.c.
3	Q signal
4	n.c.*
5	0 V / GND

*n.c. = do not connect



SCFT measurement turbine

Volumetric flow rate sensors

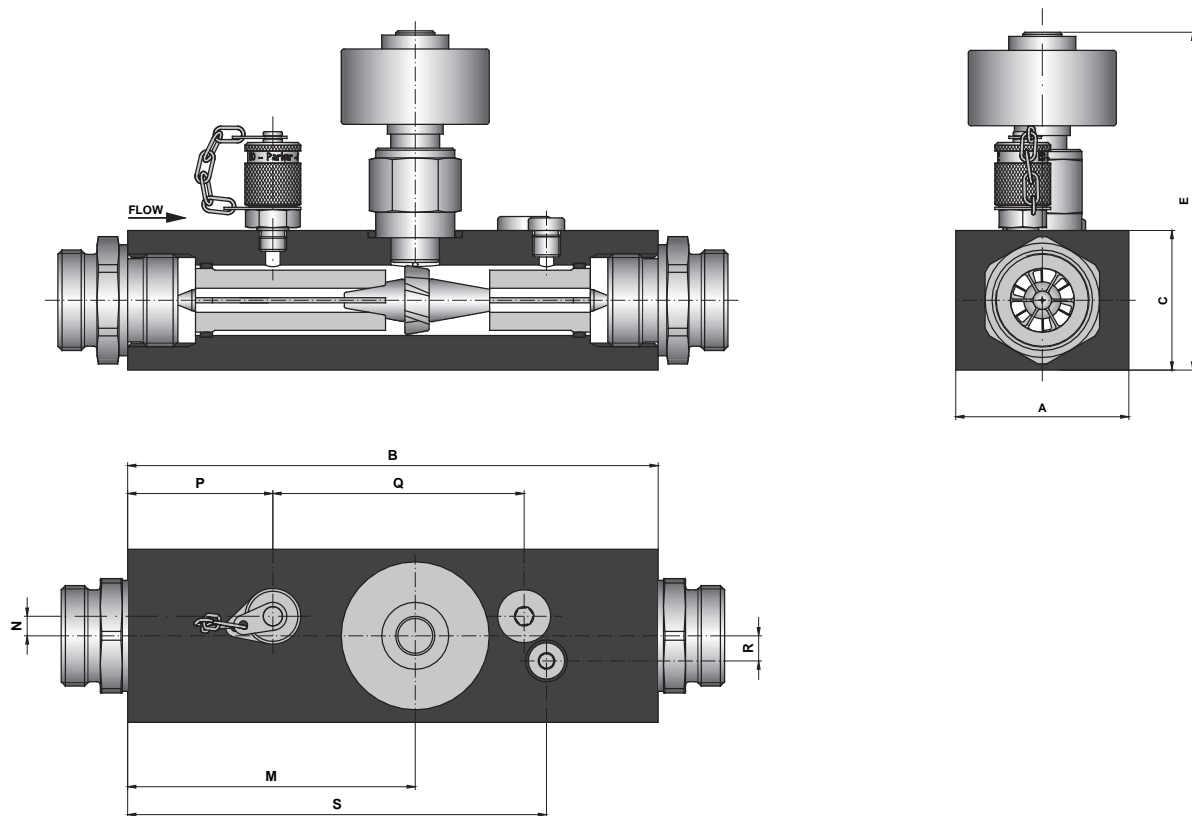

#	SCFT-015	SCFT-060	SCFT-150	SCFT-300	SCFT-600	SCFT-800
A	37	62	62	62	62	100
B	136	190	190	190	212	212
C	37	50	50	50	75	75
E	115	130	130	134	149	152
M	70	103	103	103	127	126
N	0	5	5	7	9	10
P	25	50	50	52	62	60
Q	N/A	92	92	90	106	104
R	0	5	5	9	11	10
S	115	157	157	150	168	181



SCFT measurement turbine

Order code

SCFT

M12x1, 5-pole; connecting plug; IP66

4...20 mA (3-wire)

1...15 l/min

SCFT-015-22-07

3...60 l/min

SCFT-060-22-07

5...150 l/min

SCFT-150-22-07

8...300 l/min

SCFT-300-22-07

15...600 l/min

SCFT-600-22-07

20...800 l/min

SCFT-800-22-07

Connection cable and single plug

Connection cable, assembled

SCK-400-xx-xx

(open cable end)

Cable length (m)

2 m

02

5 m

05

10 m

10

Connecting plug

M12 cable jack; straight

45

M12 cable jack; 90° angled

55

Single connector

M12 cable jack; straight

SCK-145

M12 cable jack; 90° angled

SCK-155

Volumetric flow rate sensors

SCVF volume counter

Device features

- Measurement principle: Volume/geared counter
- Eight measurement ranges from 0.01 - 2 to 1 - 300 l/min
- Accuracy $\pm 0.5\%$ FS
- Withstands pressures up to 400 bar (5802 psi)
- High viscosity range
- Low noise
- Exact flow rate measurement over a wide viscosity range
- Versatile usage for different substances



Gear counter for highly accurate flow rate measurements in hydraulic systems

Function

The SCVF geared counter functions as a volume flow meter. A very precisely crafted pair of geared wheels is driven by the fluid flow.

The SCVF works over a wide viscosity range. Different seals permit usage in many different applications.

Applications

Due to the wide viscosity range, any liquid can be measured that can be pumped and has a certain degree of lubricating capability.

- Brake fluid (EPDM seal)
- Skydrol
- Mineral oils
- Hydraulic oil and
- Grease

The SCVF is the ideal solution when carrying out precise flow rate measurements over a wide viscosity range.

SCVF volume counter

Technical data

SCVF-	002	004	015	040	060	080	150	300
Flow measuring range (l/min)	0.01...2.0	0.02...4.0	0.2...15	0.4...40	0.4...60	0.4...80	0.6...150	1.0...300
Pressure range P _N bar / (psi)	400 (5802)	315 (4569)	400 (5802)	400 (5802)	400 (5802)	400 (5802)	315 (4569)	315 (4569)
Overload pressure P _O bar / (psi)	480 (6962)	400 (5802)	480 (6962)	480 (6962)	480 (6962)	480 (6962)	350 (5076)	350 (5076)
Connection	G3/8 BSPP	G3/8 BSPP	G3/8 BSPP	G1/2 BSPP	G1/2 BSPP	G1/2 BSPP	G1 BSPP	G1 BSPP
Sound level dB (A)	< 60	< 60	< 60	< 70	< 70	< 70	< 70	< 72
Resolution (pulses / litre)	40,000	25,000	4082	965	965	965	333.33	191

Accuracy

Deviation from characteristic curve	± 0.3 % FS ≥ 20 cSt. ± 0.5 % FS ≥ 20 cSt.
Response time	< 10 ms
Repeat accuracy	0.01 % FS
Substance *)	Hydraulic oil (25 micron filter)

Material

	Material 1.7139 Contains no non-ferrous metal or silicone
Housing	Steel
Seal	FKM EPDM on request

Ambient conditions

Ambient temperature	0...+55 °C / (32...131°F)
Storage temperature	-25...+85 °C / (-13...185°F)
Fluid temperature	-30...120 °C / (-22...148°F)
Viscosity range	Refer to diagram p. 48
Protection degree	IP65 DIN EN 60529

FS = Full scale value

*) When using other substances, please state the viscosity range and the type of seals. (Attach the data sheet of the substance if possible)

Electrical connection

Plug	M12x1; 4-pole
Power supply V ₊	+18...+30 VDC
Current consumption	< 28 mA
Output signal	0...20 mA ± 0...FS l/min
Load	≤ 150 Ω

EM compatibility

Disturbance emissions	EN 61000-6-3
Resistance to interference	EN 61000-6-2

Volumetric flow rate sensors

Pin assignment

M12x1; 4-pole

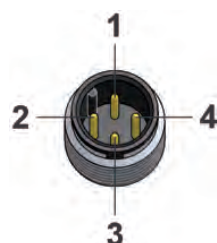

PIN	Assignment
1	V ₊
2	Q-signal
3	0 V / GND
4	-



SCVF volume counter

Technical data

Volumetric flow rate sensors

SCVF-002 Δp - Viscosity

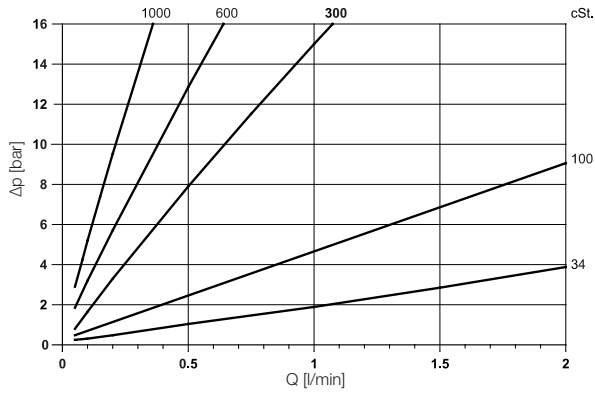

SCVF-004 Δp - Viscosity

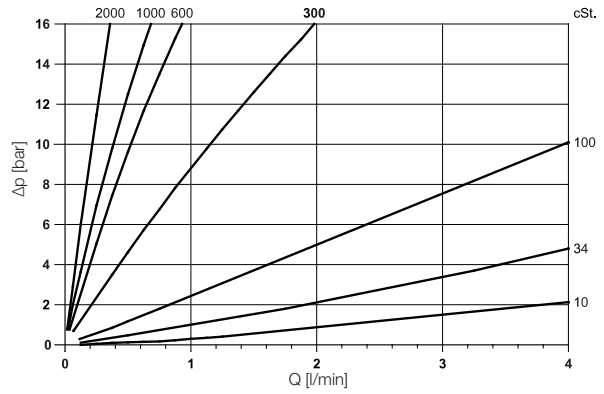

SCVF-015 Δp - Viscosity

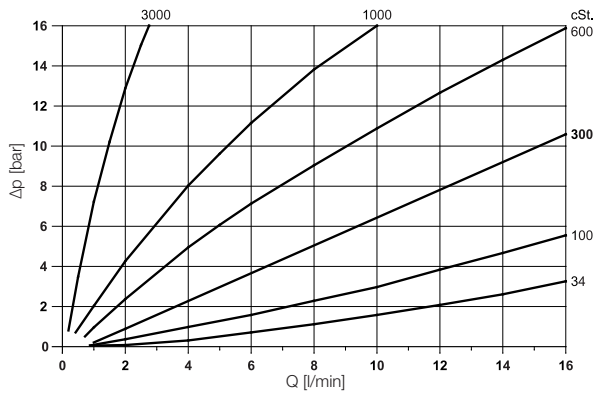

SCVF-040/060/080 Δp - Viscosity

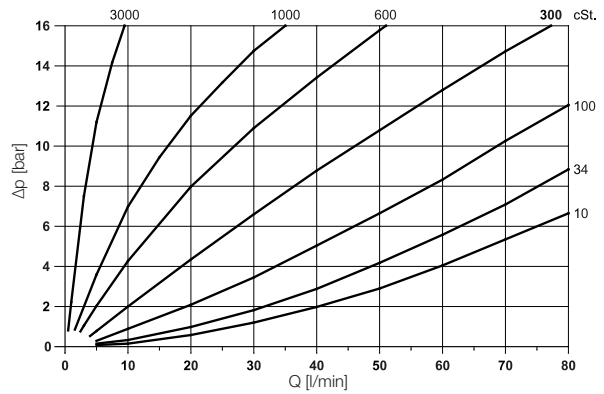

SCVF-150 Δp - Viscosity

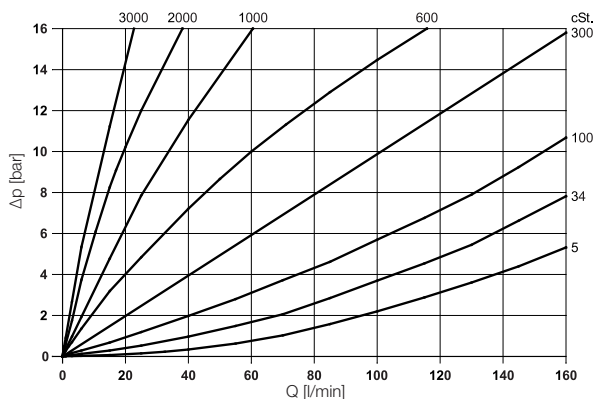

SCVF-300 Δp - Viscosity

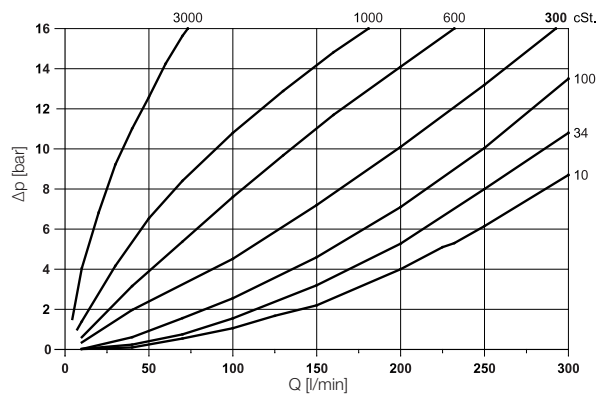

Δp = pressure loss



SCVF volume counter

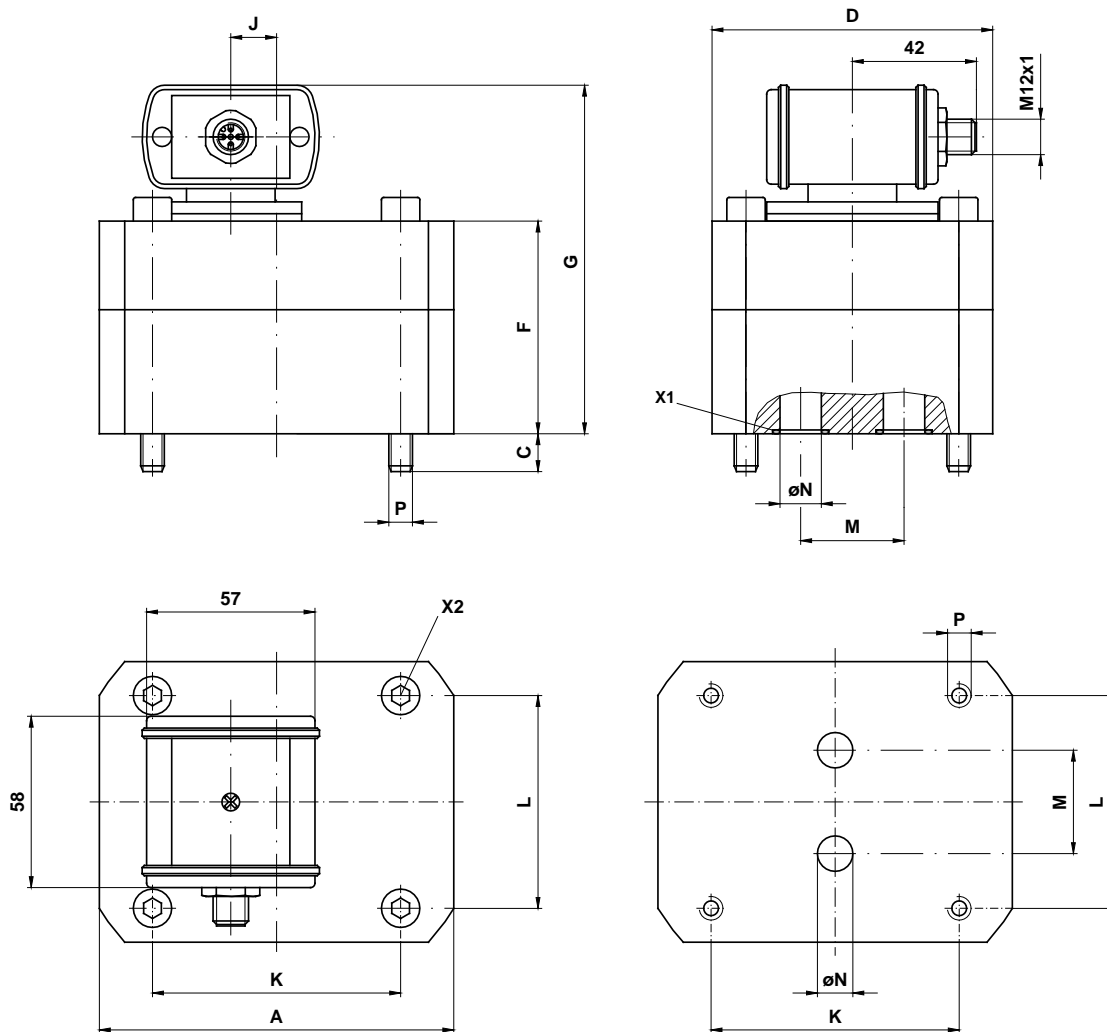

Volumetric flow rate sensors

Type	Weight [kg]	Torque [Nm]	A	C	D	F	G	J	K	L	M	$\varnothing N$	P
SCVF-002	1.8	14	85	10	60	50	87	-	70	40	20	6.5	M6
SCVF-004	2	14	85	9	60	56		-	70	40	20	6.5	M6
SCVF-015	2	14	85	13	60	57	94	-	70	40	20	9	M6
SCVF-040	5.2	35	120	13	95	72	109	10.5	84	72	35	16	M8
SCVF-060													
SCVF-080													
SCVF-150	9	120	170	18	120	89	140	46.5	46	95	50	25	M12
SCVF-300	13	120	170	22	120	105	142	40	46	95	50	25	M12

All measurements in mm



SCVF volume counter

Dimensioned drawings connection plate

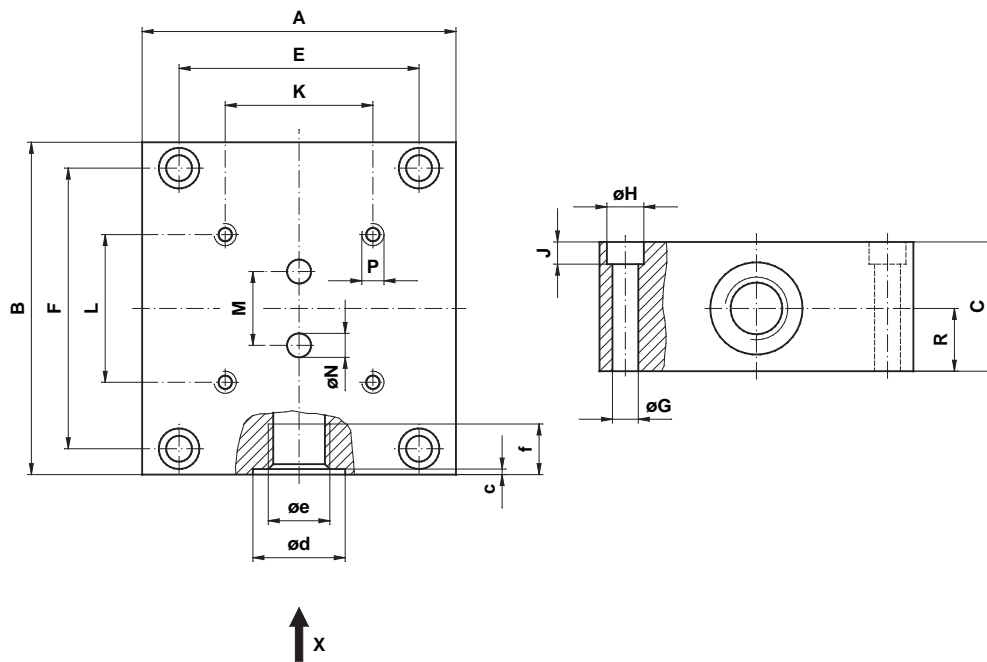

Volumetric flow rate sensors

Type	kg	A	B	C	E	F	øG	øH	J	K	L	M	øN	P	R	c	ød	øe BSPP	f
SCVF-002 SCVF-004 SCVF-015	1.8	85	90	35	65	76	7	11	7	70	40	20	6.5	M6/t = 14	17	0.7	25	G3/8	13
SCVF-040 SCVF-060 SCVF-080	2.9	100	120	37	80	106	7	11	7	84	72	35	12	M8/t = 18	17.5	0.7	29	G 1/2	15
SCVF-150 SCVF-300	14	160	165	80	140	145	9	15	9	46	95	50	25	M12/t = 24	28	1	42	G1	19

All measurements in mm



SCVF volume counter

Order code

SCVF

M12x1, 4-pole; connecting plug; IP65; incl. connection plate

0...20 mA

0.01...2 l/min

0.02...4 l/min

0.2...15 l/min

0.4...40 l/min

0.4...60 l/min

0.4...80 l/min

0.6...150 l/min

1...300 l/min

SCVF-002-10-07

SCVF-004-10-07

SCVF-015-10-07

SCVF-040-10-07

SCVF-060-10-07

SCVF-080-10-07

SCVF-150-10-07

SCVF-300-10-07

Connection cable and single plug

Connection cable, assembled

(open cable end)

SCK-400-xx-xx

Cable length (m)

2 m

5 m

10 m

02

05

10

Connecting plug

M12 cable jack; straight

M12 cable jack; 90° angled

45

55

Single connector

M12 cable jack; straight

M12 cable jack; 90° angled

SCK-145

SCK-155

The Controller Family

Device features

- Large display
- Freely adjustable
- Rugged metal construction
- Compact size
- Long-term stability
- Dependable
- Immune to interference



This controller is used in control, regulation or monitoring systems where switching signals or analogue signals are used or a display is required.

The controller can replace the following:

- Mechanical switches
- Mechanical displays (pressure gauges, thermometers, inspection glass)
- Sensors

All the above mentioned functions can be combined in one device.

All control devices have a compact and pivoting metal housing so that they can be mounted optimally under adverse installation conditions. The large display can always be perfectly positioned so that it is easy to read even at longer distances.

Both of the switching outputs can be set individually either as NO or NC. They also both have hysteresis and the window functions. Therefore the on and off switching values as well as delay times (attenuation) for each of the switching points can be chosen freely.





Thanks to these easy switching functions, intelligent adjustments can be set which are normally not possible using a mechanical switch. Therefore, many switches can be replaced with one controller.



The controllers offer good practical characteristics combined with diverse mounting and setting options.

Because of its compact design, long lifespan and high functionality, this controller is ideal for the permanent series use in hydraulic and pneumatic applications.

The Controller Family

Overview

	SCPSDi	SCPSD	SCTSD	SCTSD-L
				
Range of use	Pressure display and monitoring		Temperature display and monitoring	Temperature display and level monitoring
	<ul style="list-style-type: none"> Compact size Resistant to pressure peaks Resistant to shock and vibration IO link 	<ul style="list-style-type: none"> Compact size Resistant to pressure peaks Resistant to shock and vibration 	<ul style="list-style-type: none"> Temperature display Modular design Suitable for control panel and tank construction High pressure version 	<ul style="list-style-type: none"> Temperature display Fixed level contacts
Applications	<ul style="list-style-type: none"> Test benches Processing equipment Conveying and lifting equipment General machine construction Pneumatic plant construction Hydraulic plant construction 			
Order code	SCPSDi-xxx-x4-x7	SCPSD-xxx-x4-xx	SCTSD-150-xx-xx	SCTSD-L-xxxxx-xxxxxQ2
Refer to page	54-59	60-65	66-77	78-81

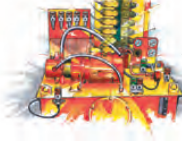
	SCLSD	SCLTSD	SCOTC	
				
Range of use	Level indication and monitoring	Level/temperature display and monitoring		
	<ul style="list-style-type: none"> Level display Practical monitoring with window function Continuous level measurement 	<ul style="list-style-type: none"> Level display Temperature display Continuous level measurement One bore hole 	<ul style="list-style-type: none"> Level display Temperature display Continuous level measurement One bore hole Connection to the filling coupling Connection to the air filter 	
Applications	<ul style="list-style-type: none"> Test benches Processing equipment Conveying and lifting equipment General machine construction Pneumatic plant construction Hydraulic plant construction 			
Order code	SCLSD-xxx-x0-07	SCLTSD-xxx-x0-07	SCOTC-xxx-x0-07	
Refer to page	82-87	88-93	94-99	

SCPSDi PressureController

Device features

- IO LINK
- VDMA menu
- ECO mode
- > 360° pivot function
- 180° reversible display
- Analogue output V/mA
- Operator safety improved with LOCK
- Compact size
- Rugged
- MPa, bar, PSI
- Metal housing
- Installation width 35 mm
- Installation height 78 mm



The SCPSDi is an electronic pressure switch with:

- Pressure display
- Two programmable switching outputs
- Optional analogue output signal
- IO-Link interface
- VDMA menu navigation

The key features of the SCPSDi are the innovative design and the resulting installation options combined with the diverse connection possibilities.

These unique functions make the SCPSDi ideal for permanent series use in industrial applications.

Innovative construction design

The external-thread pressure port is stop-free and can be turned independently of the housing. So you can install the pressure connection without turning the housing. The small size means that it can easily be installed in cramped quarters. After the installation, the housing can be fully rotated over 360° with no stop. It also locks into position while under pressure.

For the internal-thread pressure port, all components that come into contact with the pressurized substance are made from stainless steel. It does not have any seals so it can be used with a wide range of substances including corrosive and aggressive media.

The display is readable from large distances and can be rotated through 180° for overhead installation. A horizontally-mounted display is optionally available.

Reliable / safe / sturdy

The pressure is recorded with a long-term stable and maintenance-free measuring cell. A functional error is signalled and can be processed further according to DESINA. The metal housing is void of moving seals and is resistant to moisture, shock and vibrations.

Easy to use

The terminology and symbols used, as well as the menu structure used for setting parameters can be easily browsed using the buttons in accordance with the VDMA standard journal (VDMA 24574-1) or automatically using IO Link.

Universal

Each switching output can be adjusted individually:

- NO/NC contact
- On/off switching pressures
- Delay times
- Hysteresis / window function

The optional analogue output is switchable between 0/4 to 20 mA and 0 to 10 V. An unintentional parameter change is prevented with use of the LOCK function (button lock).

Numerous versions are available for the many different applications.

- Diverse pressures ranges up to 600 bar
- Diverse inner and outer threads
- With or without analogue output



SCPSDi PressureController

Device features

Display

- Active-lit LED display
- Pressure display
- Units are displayed
- Bar / PSI / MPa
- Switch status is shown
- 180° rotation for top mount
- ECO mode*

Design

- No moveable seals
- Few housing elements
- No mixing of materials
- Ergonomic
- Minimal surface area for dirt
- Compact size
- Plug in the front
- Compact installation dimensions
- Sloped display

Measuring component

- Hermetically sealed and welded stainless steel membrane
- Zero-point stability
- Long-term stability
- No wear and tear
- Excellent pressure resistance
- Up to a nominal pressure of 600 bar

Innovative construction of external threads

- The external-thread pressure port is stop-free and can be turned independently of the housing. So you can install the pressure connection without turning the housing.
- The housing can be set in any direction for optimal cable routing and locks under pressure.
- Self-contained housing
- No force is exerted on the measuring component during installation
- Stainless steel
- BSP/UNF/NPT
- NBR sealing

Housing

- Metal housing
- No movable elements, therefore wear-free
- Not sensitive to external environment
- Waterproof IP67
- Rugged

Adjustments and settings

- VDMA menu navigation
- Two large buttons
- LOCK function**

M12

- Threaded metal connection
- The plug cannot be over-rotated or broken off
- VDMA-compliant assignment of pins
- IO link
- DESINA
- 2 switching outputs
- Switchable analogue output
 - 0...20 mA
 - 4...20 mA
 - 0...10 V
- Excellent interference immunity

Inner thread

- All components that come into contact with the substance being measured are made from stainless steel
- No internal sealing components
- Wide range of compatible substances
- Resistant against corrosive and aggressive substances

* ECO mode (activated via menu): pressure switch is run with minimum power in this mode

** LOCK function (button lock): Prevents accidental changing of the pressure switch parameters



SCPSDi PressureController

Technical data

SCPSDi-	010	016	025	060	100	250	400	600
Pressure range P_n , relative bar / (psi)								
Adjusting range RSP...SP (Lowest reset switch point ... highest switch point)	-1...10 (-14.5...145)	-1...16 (-14.5...232)	-1...25 (-14.5...363)	0...60 (0...870)	0...100 (0...1450)	0...250 (0...3625)	0...400 (0...5802)	0...600 (0...8702)
Overload pressure * P_{max}	$2 \times P_n$							
Burst pressure ** P_{burst}	$3 \times P_n$							
Display resolution	0.01	0.01	0.01	0.1	0.1	1	1	1
Increment size bar / (psi)	(0.15)	(0.15)	(0.15)	(1.45)	(1.45)	(14.5)	(14.5)	(14.5)
Smallest adjustable difference between SP and RSP (SP-RSP) bar / (psi)	0.01 (0.15)	0.01 (0.15)	0.01 (0.15)	0.1 (1.45)	0.1 (1.45)	1 (14.5)	1 (14.5)	1 (14.5)

* DIN EN 60770-1

** DIN 16086

Input values	
Switching cycles	≥ 100 million
Scanning rate	≤ 10 ms
Process connection Inner/outer thread	G1/4 BSPP, 7/16 UNF, NPT
Tightening torque	35 Nm
Parts in contact with substances	Inner thread Stainless steel 1.4301; 1.4404 Outer thread Stainless steel 1.4301; 1.4404; 1.0718 CF; NBR
Temperature range of substance	-20...+105 °C
MTTFd	> 100 years
Output values	
Accuracy*	$\pm 0.5\%$ FS typ.; +/- 1% FS max.
Temperature drift	$\pm 0.03\%$ FS/K
Long-term stability	$\pm 0.2\%$ FS/a
Repeat accuracy	$\pm 0.25\%$ FS
Switch point accuracy	$\pm 0.5\%$ FS typ.; +/- 1% FS max.
Display accuracy	$\pm 0.5\%$ FS +/- 1 digit typ. $\pm 1\%$ FS +/- 1 digit max.
Max. display value	110% P_n
Analogue output	+/- 0.5% FS typ.; +/- 1% FS max.

* Including non-linearity, hysteresis, zero-point and full-scale deviations (corresponds to measurement deviations according to IEC 61298-2)

Response speed	
Switching output	≤ 10 ms
Analogue output	≤ 10 ms

Electrical connection	
Supply voltage V_+	Nominal 24 VDC; 12...30 VDC
Electrical connection	M12x1; 4-pole according to DIN EN 61076-2-101
Short circuit protection	Yes
Reverse polarity protection	Yes
Overload protection	Yes
Current consumption	< 50 mA; in ECO mode < 40 mA
Switch-on current	< 100 mA
Outputs	
Switching output 1	High-side/low-side switch (PNP/NPN)
	Switching current: max. 200 mA
	Short-circuit current: 400 mA (short-term), Short-circuit resistance
	Switching voltage: Supply voltage - 1.5 VDC
Switching output 2	High-side (PNP)* Optional
	Switching current: max. 500 mA
	Short-circuit current: 800 mA (momentary), short-circuit-proof
	Switching voltage: $V_+ - 1.5$ VDC
IO Link	Specification V1.0 PNO Order No. 2.802
Analogue output	4...20 mA, 0...20 mA, 0...10 V

*see ECN15003

SCPSDi PressureController

Technical data

Housing	
Rotating	> 360°
Readability of the display	viewing angle can be rotated 180° Configurable (programming)
Display	4-digit 7-segment LED with additional symbols for units and switching status display; Digit height: ~6 mm, Height of units: ~2 mm
Material	Die-cast nickel-plated zinc
Protection degree	IP67
Weight	148 g
Ambient conditions	
Ambient temperature range	-25...+85 °C (-13...185°F)
Storage temperature range	-40...+85 °C (-40...185°F)
Vibration resistance	20 g; 10...500 Hz; IEC60068-2-6
Shock resistance	50 g; 11 ms; IEC60068-2-29
EM compatibility	
Disturbance emissions	EN 61000-6-3
Interference immunity	EN 61000-6-2
General	
MTTFd	> 100 years
RoHS-compliant	Yes

Pin assignment

M12x1; 4-pole

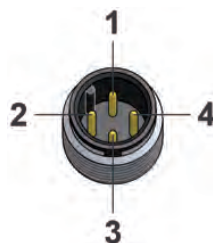

PIN	Assignment
1	V ₊
2	S2 out / analogue
3	0 V / GND
4	S1 out / IO Link

SCPSDi PressureController

SCPSDi-xxx-xx-17

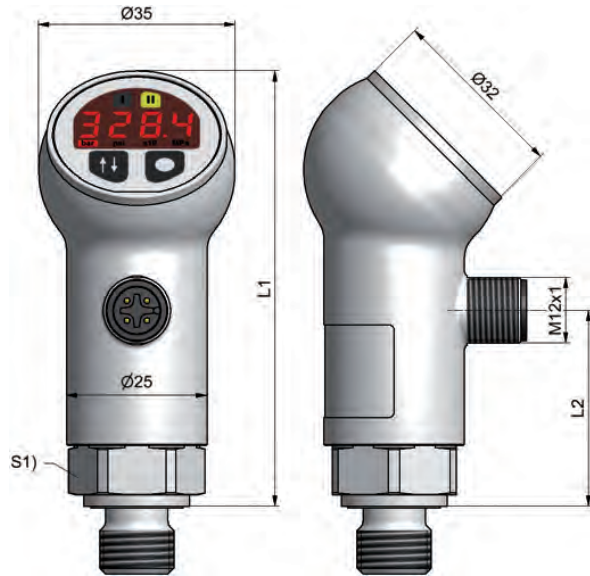

S1) SW22

SCPSDi-xxx-xx-27

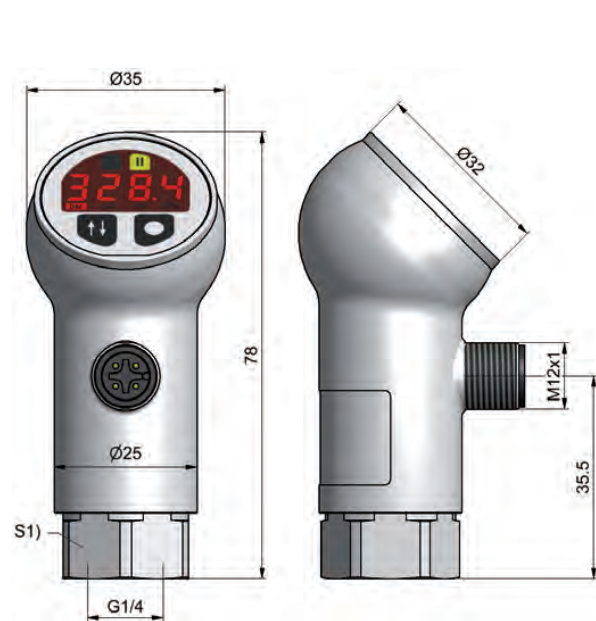

SCSD-S22

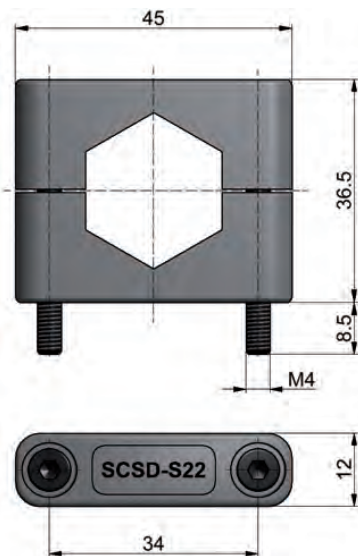

The Controller Family



SCPSDi PressureController

SCPSDi-xxx-x4-17

G1/4ED

L1) 77.5

L2) 35

X1) ED seal

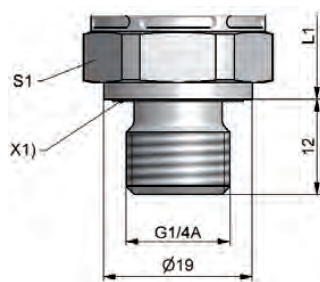

SCPSDi-xxx-x4-27

G1/4

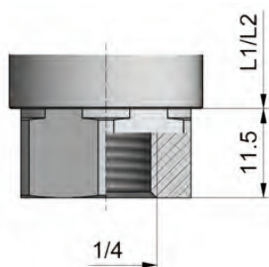

Order code

SCPSDi 2 switching outputs;

SCPSDi 2 switching outputs Marine; (approved by DNV/GL/ABS)

without analogue output,

G 1/4, M12x1; 4-pole

1 switching output;

1 switching output Marine; (approved by DNV/GL/ABS)

switchable analogue output,

G 1/4, M12x1; 4-pole

SCPSDi-xxx-04-x7-

SCPSDi-xxx-04-x7-MA

SCPSDi-xxx-14-x7

SCPSDi-xxx-14-x7-MA

Pressure range

010	010
016	016
025	025
060	060
100	100
250	250
400	400
600	600

Version

Outer thread	1
Inner thread	2

Connection cable and single plug

Connection cable, assembled

(open cable end)

SCK-400-xx-xx

Cable length (m)

2 m	02
5 m	05
10 m	10

Connecting plug

M12 cable jack; straight	45
M12 cable jack; 90° angled	55

Single connector

M12 cable jack; straight	SCK-145
M12 cable jack; 90° angled	SCK-155

Accessories:

Securing clamp	SCSD-S27
----------------	----------

SCPSD PressureController

Device features

- Compact size
- Rugged
- Dependable
- Easily operable
- Long-term stability
- Excellent interference immunity
- Metal housing
- High protection class
- Many variants
- Pivoting
- Analogue output
- Password
- MPa, bar, PSI



The PressureController combines the functions of a pressure switch, a pressure sensor and a display device.

- Pressure gauge (manometer)
- Switching outputs
- Analogue signal

The PressureController is easy to operate, has a compact design and is very reliable. The PressureController features excellent technical specifications, optimal pressure management and a wide variety of installation options. This makes it perfect for permanent series use in industrial applications.

Easy to use

The parameters are set using the keys or over a programming module.

High functionality

Each switching output can be adjusted individually:

- NO/NC contact
- On/off switching pressures
- Delay times
- Hysteresis / window function
- Attenuation

Thanks to these easy switching functions, intelligent adjustments can be set which are normally not possible using a mechanical switch. Therefore, many switches can be replaced with one controller.

The analogue output is individually adjustable

- 0/4...20 mA switchable
- Starting pressure selectable
- End pressure selectable

Reliable and safe

The pressure is recorded with a long term stable measuring cell. A functional error is signalled and can be processed further according to DESINA. Parameters can be password protected to avoid unauthorised changes.

Rugged

The housing is made of metal and is resistant to moisture, shock and vibrations. The electronics are protected against reverse polarity, over-voltage and short-circuits.

Everything at a glance

The large illuminated display can be read from long distances. The pressures can be displayed in MPa, bar or PSI.

Optimal installation possibilities

The SCPSD is ideal for installation under critical conditions because of its compact design and excellent interference immunity. The display is always easy to read because the housing can be positioned as needed.

Universal

Diverse versions are available for the many different applications.



SCPSD PressureController

Device features

Everything at a glance

- Sloped display
- Digital display
 - Large
 - Illuminated
- Display
 - PSI/bar/Mpa
 - Current pressure
 - Minimum pressure
 - Maximum pressure
 - Switching points

Variable installation

- Compact size
- 290° pivotable

Pressure port

- Stainless steel
- Long term stable measuring cell
- Wide range of compatible substances

Thread

- Inner thread



- Outer thread



Optical interface

- Switch status is shown

Easy to use

- 3 large buttons
- Display of the unit

Rugged

- Metal housing
- Waterproof
- Excellent interference immunity
- Vibration proof
- Shock proof

Tube clamp

- Safe installation with the sturdy SCSD-S27 clamp



Programming module

- Adjustable through ControllerWIN Software

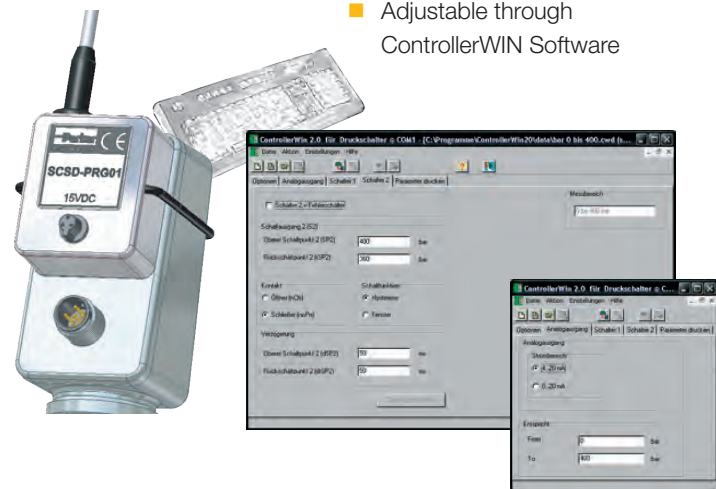

The Controller Family



SCPSD PressureController

Technical data

SCPSD-	004	010	016	060	100	250	400	600
Pressure range P _n relative bar / (psi)	-1...4 (-14.5...58)	-1...10 (-14.5...145)	-1...16 (-14.5...232)	0...60 (0...870)	0...100 (0...1450)	0...250 (0...3626)	0...400 (0...5802)	0...600 (0...8702)
Adjusting range RSP...SP								
Overload pressure P _n bar / (psi)	10 (145)	20 (290)	40 (580)	120 (1740)	200 (2400)	500 (7521)	800 (11,603)	1200 (17,405)
Burst pressure P _n bar / (psi)	12 (174)	25 (363)	50 (725)	550 (7977)	800 (11,603)	1200 (17,405)	1700 (24,656)	2200 (31,908)
Display resolution bar / (psi)	0.01 (0.15)	0.01 (0.15)	0.01 (0.15)	0.1 (1.45)	0.1 (1.45)	1 (14.5)	1 (14.5)	1 (14.5)
Smallest adjustable difference between SP and RSP (SP-RSP) bar / (psi)	0.03 (0.44)	0.06 (0.87)	0.09 (1.31)	0.3 (4.35)	0.6 (8.7)	2 (29)	3 (43.5)	3 (43.5)
Measuring component	Ceramic			Thin film DMS				
Parts in contact with substances	Stainless steel 1.4404; Ceramic AL2O3; NBR			Stainless steel 1.4404; 1.4542				

Input parameters

Switching cycles	≥ 100 million
Polling rate	≥ 5 ms
Connector thread	G1/4 BSPP; ED soft seal NBR* (DIN 3852 T2, Form X); ED (DIN3852 T11, Form E)
Tightening torque	35 Nm
Temperature range of substance	-20...+85 °C (-4...185°F)
Weight	Approx. 300 g
MTTFd	> 100 years

Output values

Accuracy	± 0.5 % FS typ.; ± 1 % FS max.
Temperature drift	± 0.02 % FS/°K type (at -20...+85 °C) ± 0.03 % FS/°K max.
Long-term stability	± 0.2 % FS/a
Repeat accuracy	± 0.25 % FS
Switching point accuracy	± 0.5 % FS typ.; ± 1 % FS max.
Display accuracy	± 0.5 % FS type ± 1 Digit ± 1 % FS max. ± 1 Digit

Response speed

Switching output	≤ 10 ms
Analogue output	≤ 10 ms

Electrical connection

Supply voltage V _s	15 to 30 VDC nominal 24 VDC; Protection class 3
Electrical connection	M12x1; 4-pole; 5-pole; with gold-plated contacts device connector
Short-circuit protection	Yes
Protection against wrong insertion	Yes
Overload protection	Yes
Current consumption	< 100 mA

Housing

	Adjustable direction to 290°C (554°F)
Material	Painted zinc die cast Z 410
Foil material	Polyester
Display	4-digit 7-segment LED; red; digit height 9 mm
Protection degree	IP67 DIN EN 60529;

SCPSD PressureController

Technical data

Ambient conditions	
Ambient temperature range	-20...+85 °C (-4...185°F)
Storage temperature range	-40...+100 °C (-40...212°F)
Vibration resistance	20 g; 10...500 Hz IEC60068-2-6**
Shock resistance	50 g; 11 ms IEC60068-2-29**
EM compatibility	
Disturbance emissions	EN 61000-6-3
Resistance to interference	EN 61000-6-2
Outputs	
Switching outputs	Two MOSFET high-side switches (PNP)
Contact functions	NO / NC contact; window / hysteresis; function freely adjustable
Switching voltage	V ₊ -1.5 VDC
Switching current max.	0.5 A per switch
Short-circuit current	2.4 A per switch
Analogue output	0/4...20 mA; programmable; freely scalable; RL ≤ (Supply voltage - 8 V) / 20 mA (≤ 500 Ω)

* different sealing material (FKM, EPDM etc.) upon request
 ** does not apply for version DIN EN 175301-803 Form A (old DIN43650)

Information about selecting the pressure range

The following parameters are relevant when working with pressure switches:

- System pressure
- Switching point pressure

Since a 400-bar (5802 psi) pressure switch has a comparable resolution (of 1 bar, 14.5 psi) as that of a 600-bar (8702 psi) pressure switch (also 1 bar), it is possible to use a 600-bar (8702 psi) pressure switch even when there is a smaller nominal pressure (for example, 315 bar, 4569 psi).

This is a positive feature because it provides the same precision with improved safety and fewer product variants.

Pin assignment

SCPSD-xxx-14-x7

1 switching and 1 analogue output

M12x1; 4-pole

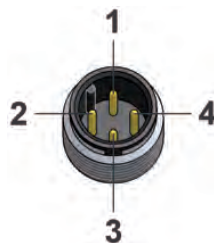

PIN	Assignment
1	V ₊
2	Analogue out
3	0 V / GND
4	S1 out

SCPSD-xxx-04-x7

2 switching outputs;

M12x1; 4-pole

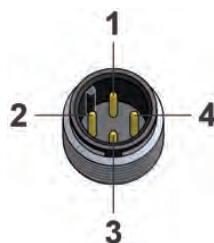

PIN	Assignment
1	V ₊
2	S2 out
3	0 V / GND
4	S1 out

SCPSD-xxx-14-x5

2 switching outputs; 1 analogue output;

M12x1; 5-pole



PIN	Assignment
1	V ₊
2	S2 out
3	0 V / GND
4	S1 out
5	Analogue out

SCPSD PressureController

Outer thread

SCPSD-xxx-x4-1x

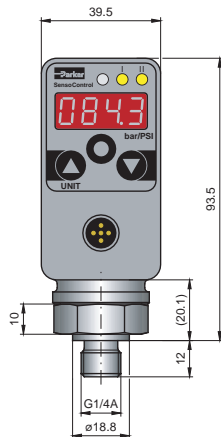

Inner thread

SCPSD-xxx-x4-2x

Up to 10 bar (145 psi)

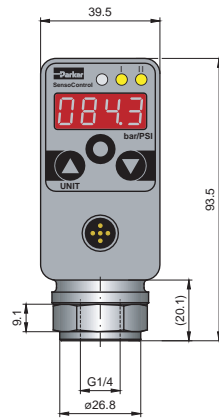

From 16 bar (232 psi)

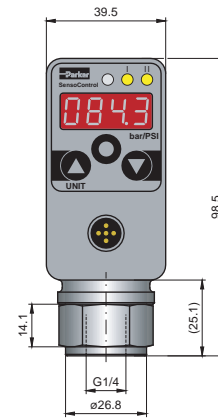

M12 connecting plug

SCPSD-xxx-x4-x5

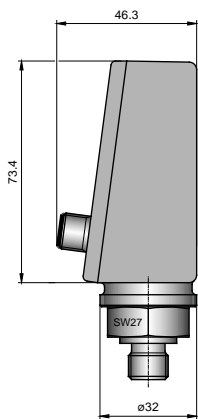

Clamp (accessory)

SCSD-S27

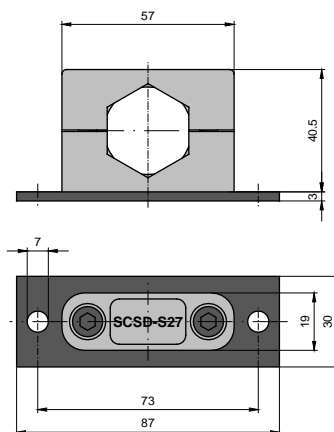

SCPSD PressureController

Order code

SCPSD digital pressure switch

2 switching outputs; no analogue output: SCPSD-xxx-04-x7

M12x1 connecting plug; 4-pole

1 switching output; with analogue output: SCPSD-xxx-14-x7

M12x1 connecting plug; 4-pole

2 switching outputs; with analogue output SCPSD-xxx-14-x5

M12x1 connecting plug; 5-pole

Pressure range

004	004
010	010
016	016
060	060
100	100
250	250
400	400
600	600

Version

G1/4 BSPP outer thread	1
G1/4 BSPP inner thread	2

Accessories:

- PC Programming KIT
- Securing clamp
- Reducing adapter M22x1.5
- Reducing adapter G1/2 BSPP
- Attenuation adapter
- Attenuation adapter
- Flange adapter
- for mechanical pressure switch

- SCSD-PRG-KIT
- SCSD-S27
- SCA-1/4-M22x1.5-ED
- SCA-1/4-ED-1/2-ED
- SCA-1/4EDX1/4-D
- SCA-1/2EDX1/2-D
- SCAF-1/4-40

Connection cable and single plug

Connection cable, assembled

(open cable end)

SCK-400-xx-xx

Cable length (m)

2 m	02
5 m	05
10 m	10

Connecting plug

M12 cable jack; straight	45
M12 cable jack; 90° angled	55

Single connector

M12 cable jack; straight	SCK-145
M12 cable jack; 90° angled	SCK-155

Order example

SCPSD-100-04-27

- Pressure range 100 bar
- 2 switching outputs
- G1/4 BSPP inner thread
- M12 connecting plug



SCPSD-004-14-17

- Pressure range 4 bar
- 1 switching output
- 1 analogue output
- G1/4 BSPP outer thread
- M12 connecting plug

SCTSD TemperatureController

Device features

- Compact size
- Rugged
- Dependable
- Easily operable
- Metal housing
- High protection class
- Modular construction
- Many variants
- Analogue output
- Pivoting
- Password
- °C, °F

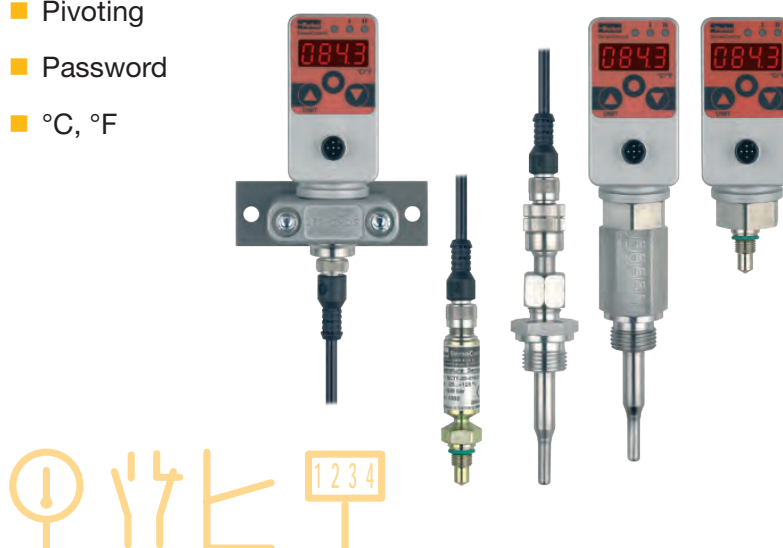

The TemperatureController combines the functions of a temperature switch, a temperature sensor and a display device.

- Temperature display (Thermometer)
- Switching outputs
- Analogue signal

Simple operation, extensive functionality and a modular design are the most important characteristics of the TemperatureController.

The TemperatureController offers excellent technical specifications, optimum temperature management, combined with a variety of installation options. It is perfect for applications when the temperature needs to be reliably monitored and easily viewed.

Easy to use

The normal temperature monitoring limit values adjustments (e.g. cooling and alarm) are made either with the keys or the programming module.

High functionality

Each switching output can be adjusted individually:

- NO/NC contact
- On/off switching pressures
- Delay times
- Hysteresis / window function
- time delay

Thanks to these easy switching functions, intelligent adjustments can be set which are normally not possible using a mechanical switch. Therefore, many switches can be replaced with one controller.

The analogue output is individually adjustable

- 0/4...20 mA switchable
- Adjustable start temperature
- Adjustable end temperature

Reliable and safe

A functional error is signalled and can be processed further according to DESINA. Parameters can be password protected to avoid unauthorised changes.

Rugged

The housing is made of metal and is resistant to moisture, shock and vibrations. The electronics are protected against reverse polarity, over-voltage and short-circuits.

Everything at a glance

The large illuminated display can be read from long distances. The temperature can be selected to °C or °F. The temperature is always optimally readable due to the modular construction and the pivoting housing.

Optimal installation possibilities

Sensors in various lengths are available for different tank sizes. These can be directly connected to the TemperatureController via a cable. Additionally the temperature sensor is available up to 630 bar for high pressure applications.

Universal

Diverse versions are available for the many different applications.



SCTSD TemperatureController

Application example Tank temperature monitoring

Machine On / Off

The facility should shut down when the tank temperature falls below 10°C (50°F) or climbs above 60°C (140°F).

A protective wire-break mechanism should be considered to improve safety.

Cooling

If the temperature climbs above 50°C (122°F), the tank temperature should be cooled with a refrigerating unit down to 40°C (104°F).

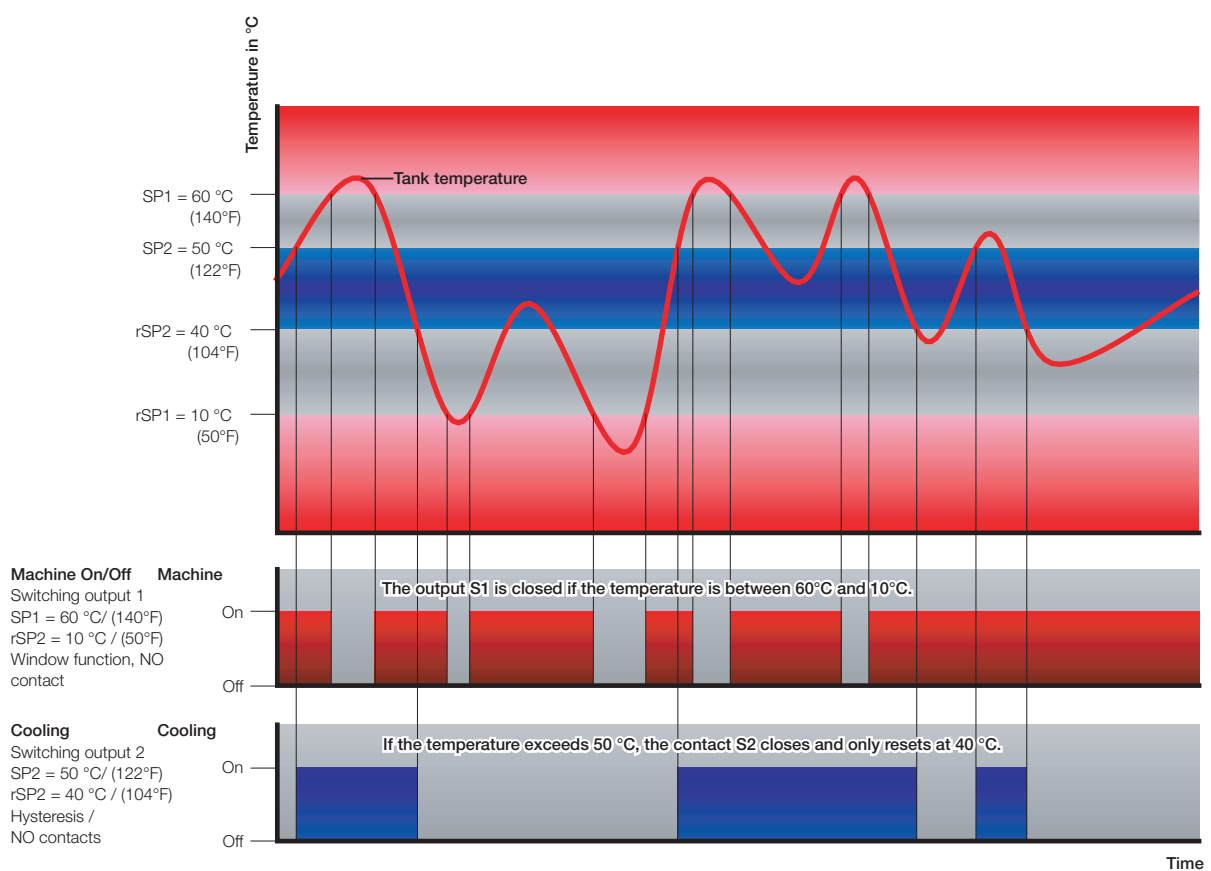

SCTSD Modular Temperature Controller

Device features

Everything at a glance

- Sloped display
- Digital display
 - Large
 - Illuminated
- Display
 - °C, °F
 - Current temperature
 - Minimum temperature
 - Maximum temperature
 - Switching points

Variable installation

- Compact size
- 290° pivotable

Connect as required

- 2 switching outputs
- Analogue output
- 0...20 or 4...20 mA
- Freely programmable
- Scalable
- Plug
 - M12
 - DIN EN 175301-803 Form A (old DIN43650)



Optical interface

- Switch status is shown

Easy to use

- 3 large buttons
- Display of the unit

Rugged

- Metal housing
- Waterproof
- Excellent interference immunity
- Vibration proof
- Shock proof

Tube clamp

- Safe installation with the sturdy SCSD-S27 clamp



Programming module

- Adjustable through ControllerWIN Software

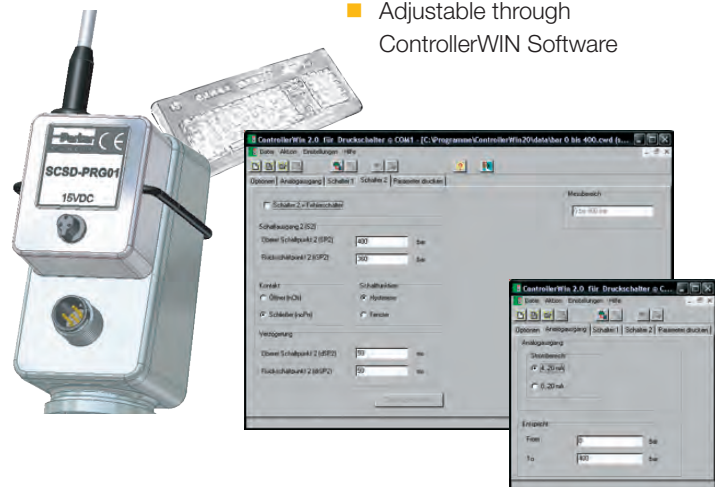

The Controller Family



SCTSD Modular Temperature Controller

Device features

Adjustable height

- Through clamping thread
- SCA-TT-10-1/2



High pressure temperature sensor

- 630 bar
- SCTT-20-010-07



Immersion tube

- Additional with
- High pressures
- Aggressive substance
- Immersion tube SCA-TT-10-xxx



Cable

- SCK-410-03-45-45



Temperature sensor

- Stainless steel
- Wide range of compatible substances
- Diverse lengths
- SCTT-10-xxx-07

Connection adapter

- SCA-TT-10-SD



SCTSD Modular TemperatureController

Technical data

Input parameters SCT-150	
Display range	-50...+150 °C / (-58...302°F)
Sensor input	PT1000
Sensor connection	M12x1; 4-pole
Output values	
Switching accuracy at 25 °C	± 0.35 % FS
Display accuracy at 25 °C	± 0.35 % FS ± 1 Digit
Electrical connection	
Supply voltage V_+	15...30 VDC nominal 24 VDC; Protection class 3
Electrical connection	M12x1; 4-pole; 5-pole; Device plug DIN EN 175301-803 Form A (old DIN43650)
Short-circuit protection	Yes
Overload protection	Yes
Current consumption	< 100 mA
EM compatibility	
Disturbance emissions	EN 61000-6-3
Resistance to interference	EN 61000-6-2

* does not apply for version DIN EN 175301-803 Form A (old DIN43650)

Housing	
	Orientation adjustable to 290°
Material	Die-cast zinc Z 410; painted
Foil material	Polyester
Display	4-digit 7-segment LED; red; digit height 9 mm
Protection degree	IP67 EN 60529 IP65 with device plug DIN EN 175301-803 Form A (old DIN43650)
Ambient conditions	
Ambient temperature range	-20...+85 °C / (-4...185°F)
Storage temperature range	-40...+100 °C / (-40...212°F)
Vibration resistance	20 g; 10...500 Hz IEC60068-2-6*
Shock resistance	50 g; 11 ms IEC60068-2-29*
Outputs	
Switching outputs	2 x PNP high-side switch, 0.7 A/switch
Contact functions	NO / NC contact; window / hysteresis
Response speed	300 ms
Accuracy	± 1 % FS
Analogue output	0/4...20 mA; programmable; freely scalable; 4...20 mA = -40...125 °C / (-40...257°F)

Temperature sensor SCTT-10-xxx-07	
Measuring component	PT1000/DIN EN 60751, Class B
Measuring range	-40...+125 °C
Response time	$\tau_{0,5} = 6 \text{ s} / \tau_{0,9} = 25 \text{ s}$
Accuracy	± 0.3 K + 0.005* t
Material	Stainless Steel 1.4571
Nominal pressure (max)	10 bar
Temperature of substance	-40...+125 °C / (-40...257°F)
Ambient temperature	-25...+80 °C / (-13...176°F) (for the connector area)
Storage temperature	-25...+85 °C / (-13...185°F)

High pressure sensor SCTT-20-010-07	
Measuring component	PT1000/DIN EN 60751, Class B
Measuring range	-40...+125 °C / (-40/257°F)
Response time	$\tau_{0,5} = 3 \text{ s} / \tau_{0,9} = 15 \text{ s}$
Accuracy	± 0.3 K + 0.005*t
Material	Stainless Steel 1.4404
Threaded stud	M10x1
Seal	O ring 7.65x1.78 mm; FKM
Measuring pipe diameter	7 mm
Installation length	18.5 mm
Nominal pressure P_n	630 bar
Overload pressure P_{max}	800 bar
Burst pressure P_{burst}	1200 bar
Temperature of substance	-40...+125 °C / (-40...257°F)
Ambient temperature	-25...+80 °C / (-13...176°F) (for the connector area)
Storage temperature	-25...+85 °C / (-13...185°F)

SCTSD Modular Temperature Controller

Pin assignment

SCTSD-150-00-06

1 switching output
DIN EN 175301-803 Form A 4-pole (old 43650)

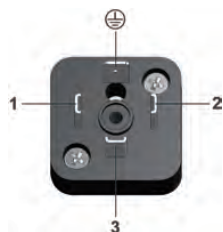

PIN	Assignment
1	V ₊
2	0 V / GND
3	S1 out
	-

SCTSD-150-00-07

2 switching outputs
M12x1; 4-pole

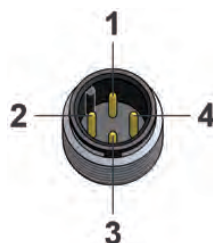

PIN	Assignment
1	V ₊
2	S2 out
3	0 V / GND
4	S1 out

SCTSD-150-10-07

1 switching output, 1 analogue output
M12x1; 4-pole

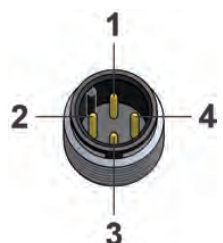

PIN	Assignment
1	V ₊
2	Analogue out
3	0 V / GND
4	S1 out

SCTSD-150-10-05

2 switching outputs, 1 analogue output
M12x1; 5-pole



PIN	Assignment
1	V ₊
2	S2 out
3	0 V / GND
4	S1 out
5	Analogue out

SCTT-x0-xxx-07

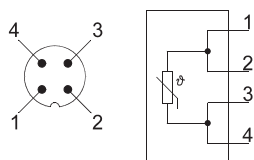

Measuring range	Display resolution Increment size	Lowest reset switch point RSP	Largest switching value SP	Smallest adjustable difference between SP and RSP (SP-RSP)
-50...150 °C / (-58...302°F)	0.1 °C / (32.2°F)	-50 °C / (-58°F)	150 °C / (302°F)	0.8 / (33.4°F)

SCTSD Modular Temperature Controller

M12 connecting plug

SCTSD-150-x4-05

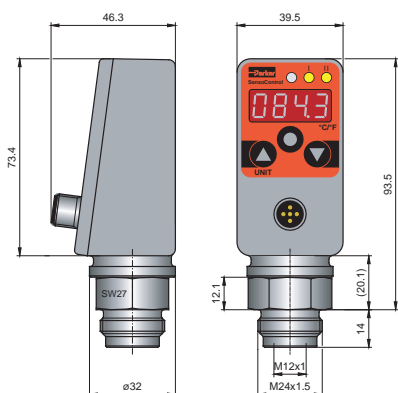

DIN 43650

SCTSD-xxx-00-06

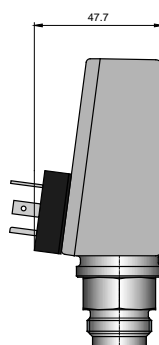

High pressure temperature sensor

SCTT-20-010-07

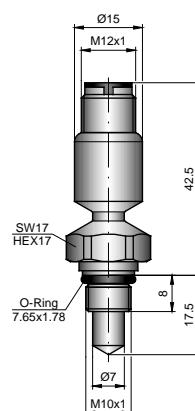

Temperature sensor

SCTT-10-xxx-07

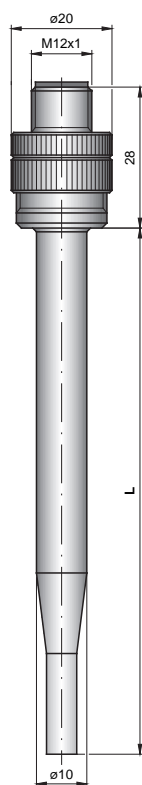

Connection adapter (accessory)

SCA-TT-10-SD

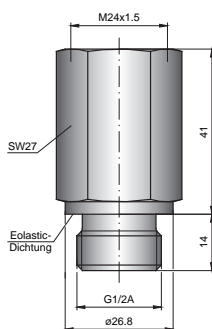

Clamping thread (accessory)

SCA-TT-10-1/2

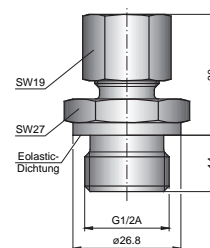

Material:

Stainless Steel 1.4404

Male stud:

G1/2A BSPP DIN3852-E

Seal type:

ED (Eolastic seal type)

Screw plug hole

G1/2A BSPP DIN3852-E

Replacement seals:

ED1/2VITX (FKM)

GE10LR1/2EDOMD71:

(with 10 mm bore hole)

Stainless Steel 1.4571

EO-2-functional nut:

FM10L71

Male stud:

G1/2A BSPP DIN3852-E

Seal type:

ED (Eolastic seal type)

Replacement seal:

ED1/2VITX (FKM)

SCTSD Modular Temperature Controller

Sensor cable 3 m (accessory)

SCK-410-03-45-45



Clamp (accessory)

SCSD-S27

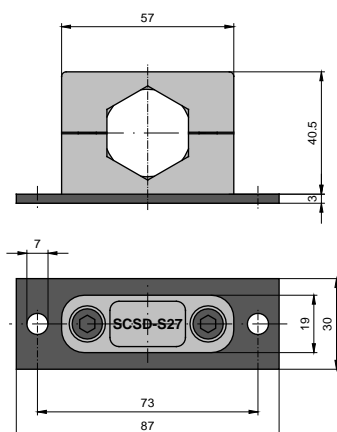

Order example

Components for the control panel - high pressure version

Securing clamp **SCSD-S27**
 Sensor cable 3 m (SCTSD-SCTT) **SCK-410-03-45-45**
 High pressure temperature sensor **SCTT-20-10-07**

Components for the control panel

Securing clamp **SCSD-S27**
 Sensor cable 3 m (SCTSD-SCTT) **SCK-410-03-45-45**
 Clamping thread G1/2 BSPP **SCA-TT-10-1/2**
 Temperature sensor 150 mm **SCTT-10-150-07**
 Optional: Immersion tube G1/2 BSPP 100 mm **SCA-TT-10-100**

Direct mounting components

Connection adapter (SCTSD-SCTT) **SCA-TT-10-SD**
 Temperature sensor 100 mm **SCTT-10-100-07**
 Optional: Immersion tube G1/2 BSPP 200 mm **SCA-TT-10-200**

Order code

SCTSD module

1 switch output; no analogue output **SCTSD-150-00-06**
 DIN EN 175301-803 Form A
 (old DIN 43650) connecting plug

2 switch outputs; no analogue output **SCTSD-150-00-07**
 M12x1 connecting plug; 4-pole

1 switch output; with analogue output **SCTSD-150-10-07**
 M12x1 connecting plug; 4-pole

2 switch outputs; with analogue output **SCTSD-150-10-05**
 M12x1 connecting plug; 5-pole

Accessories:

Securing clamp **SCSD-S27**
 Sensor cable 3 m (SCTSD-SCTT) **SCK-410-03-45-45**
 Clamping thread G1/2 BSPP **SCA-TT-10-1/2**
 Connection adapter (SCTSD-SCTT) **SCA-TT-10-SD**
 High pressure temperature sensor **SCTT-20-10-07**
 Immersion tube G1/2 BSPP **SCA-TT-10-xxx**

Length mm

100 mm **100**
 150 mm **150**
 250 mm **250**

Temperature sensor

SCTT-10-xxx-07

Length mm

100 mm **100**
 150 mm **150**
 250 mm **250**

Connection cable and single plug

Connection cable, assembled

SCK-400-xx-xx

(open cable end)

Cable length (m)

2 m **02**
 5 m **05**
 10 m **10**

Connecting plug

M12 cable jack; straight **45**
 M12 cable jack; 90° angled **55**

Single connector

M12 cable jack; straight **SCK-145**
 M12 cable jack; 90° angled **SCK-155**

The Controller Family

SCTSD high pressure TemperatureController

Device features

Everything at a glance

- Sloped display
- Digital display
 - Large
 - Illuminated
- Display
 - °C, °F
 - Current temperature
 - Minimum temperature
 - Maximum temperature
 - Switching points

Rugged

- Metal housing
- Waterproof
- Excellent interference immunity
- Vibration proof
- Shock proof

Variable installation

- Compact size
- 290° pivotable

Programming module

- Adjustable through ControllerWIN Software

Optical interface

- Switch status is shown

Easy to use

- 3 large buttons
- Display of the unit

Connect as required

- 2 switching outputs
- Analogue output
- 0...20 or 4...20 mA
- Freely programmable
- Scalable
- M12 connecting plug

High pressure resistance

- Up to 630 bar (1166 psi)



The Controller Family



SCTSD high pressure TemperatureController

Technical data

Input values SCTSD-150-x2-0x		Ambient conditions	
Measuring range	-40...+100 °C / (-40...212°F)	Ambient temperature range	-25...+80 °C / (-13...185°F)
Input for measuring element	PT1000/DIN EN 60751; Class B	Storage temperature range	-25...+85 °C / (-13...185°F)
Range of use	Liquid media, air	Media temperature range	-40...+100 °C / (-40...212°F)
Output values		EM compatibility	
Switching accuracy at 25 °C	± 0.35 % FS	Disturbance emissions	EN 61000-6-3
Display accuracy at 25 °C	± 0.35 % FS ± 1 Digit	Resistance to interference	EN 61000-6-2
Temperature margin of error	± 0.01 % FS/°C typ. (for -20...+85 °C / -4...185°F)	Outputs	
Long-term stability	± 0.2 % FS/a	Switching outputs	2 x PNP high-side switch
Electrical connection		Contact functions	NO / NC contact; window / hysteresis
Supply voltage V ₊	15 to 30 VDC (with protection against polarity reversal)	Switching current:	0.5 A / switch to 85 °C; / (185°F) 0,7 A / switch to 70 °C / (158°F)
Electrical connection	M12x1; 4-pole; 5-pole; with gold-plated contacts	Response speed	≤ 0.7 s maximum load current
Short-circuit protection	Yes	Optional analogue output	
Overload protection	Yes	Measuring range	0/4...20 mA
Current consumption	< 100 mA	Response speed (0-95 %)	≤ 300 ms
Mechanical connection		Analogue output error	± 1 % FS
Threaded male stud	M10x1	Load	≤ 500 Ω from V ₊ > 18 VDC
Seal	O-ring 7.65x1.78 mm; FKM		
Measuring pipe diameter	7 mm		
Installation length	18.5 mm		
Material	Stainless Steel 1.4404		
P _N pressure	630 bar		
P _{max}	800 bar		
Burst pressure	1200 bar		
Housing			
	Adjustable direction to 290°C		
Material	Die-cast zinc Z 410; painted		
Foil material	Polyester		
Display	4-digit 7-segment LED; red; digit height 9 mm		
Protection degree	IP67 EN 60529		

SCTSD high pressure TemperatureController

M12 connecting plug

SCTSD-150-x4-05

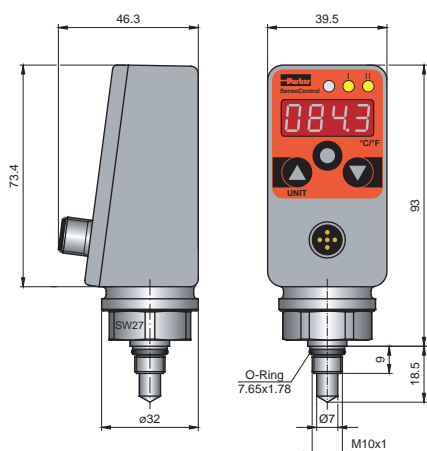

Pin assignment

SCTSD-150-02-07

2 switching outputs
M12x1; 4-pole

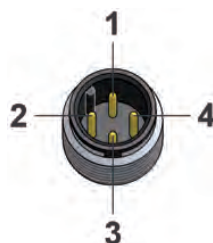

PIN	Assignment
1	V ₊
2	S2 out
3	0 V / GND
4	S1 out

SCTSD-150-12-07

1 switching output, 1 analogue output
M12x1; 4-pole

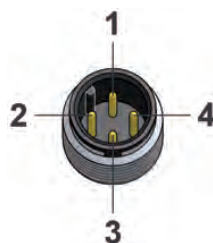

PIN	Assignment
1	V ₊
2	Analogue out
3	0 V / GND
4	S1 out

SCTSD-150-12-05

2 switching outputs, 1 analogue output
M12x1; 5-pole



PIN	Assignment
1	V ₊
2	S2 out
3	0 V / GND
4	S1 out
5	Analogue out

Measuring range	Display resolution Increment size	Lowest reset switch point RSP	Largest switching value SP	Smallest adjustable difference between SP and RSP (SP-RSP)
-40...100 °C / (-40...212°F)	0.1 °C / (32.2°F)	-40 °C / (-40°F)	100 °C / (212°F)	0.8 / (33.4°F)

SCTSD high pressure TemperatureController

Order code

SCTSD high pressure

2 switch outputs; no analogue output **SCTSD-150-02-07**
M12x1 connecting plug; 4-pole

1 switch output; with analogue output **SCTSD-150-12-07**
M12x1 connecting plug; 4-pole

2 switch outputs; with analogue output **SCTSD-150-12-05**
M12x1 connecting plug; 5-pole

Accessories

PC Programming Kit **SCSD-PRG-KIT**

Connection cable and single plug

Connection cable, assembled **SCK-400-xx-xx**
(open cable end)

Cable length (m)

2 m	02
5 m	05
10 m	10

Connecting plug

M12 cable jack; straight	45
M12 cable jack; 90° angled	55

Single connector

M12 cable jack; straight	SCK-145
M12 cable jack; 90° angled	SCK-155

SCTSD-L combination switch

Device features

- Compact design
- Temperature display
- Individually adjustable temperature switching outputs
- Small switching hysteresis
- Preset
 - For standard oils
 - For cooling
 - For switching off (T_{max})
- Fixed level contacts
- Only one float
- Preset level
 - Warning and shutdown min.
 - Shut-down min./max.
- Up to one meter probe length



The SCTSD-L combination switch was designed to meet the requirements of hydraulic facility construction. It combines the functions of a fixed mechanical level switch with an adjustable temperature switch with display.

Level

The tank level is measured using a highly dynamic, fully encapsulated magnetic float which switches the bi-stable reed contacts. The M12 pin assignments are compatible with conventional existing systems. The level contacts are pre-determined according to the normal tank sizes. There are two standard switch output versions available:

- Warning minimum level and shutdown minimum level
- Shutdown maximum and minimum levels

The switching positions were chosen according to the proven experiences of plant constructors and the DIN. For safety reasons (fail-safe / closed circuit), the switching behaviour of the standard switch is an NC contact.

Optionally the contacts can be changed at the factory and pre-set in line with the customer's requirements.

Temperature

The temperature is detected using a sensor; it is then evaluated and constantly displayed using the SCTSD TemperatureController (as described in the SCTSD section). Thanks to the easy switching functions (e.g. switching windows), intelligent switching settings can be achieved that are not possible using a mechanical temperature switch.

Normally the outputs for the normal temperature functions cooling on/off and shutdown are pre-installed as standard. The temperature thresholds were designed for standard oils (HLP).

It is possible to adjust the temperature monitoring temperature limits (e.g. cooling and shutdown) for each output individually using the keys:

- On/off switching temperature limits
- NO/NC contact
- Hysteresis / window function
- Time delay and attenuation

Optional (see: SCTSD-L-....-KIT5) 3 different versions of temperature switching outputs are available:

- 2 switching outputs
- 1 switching and 1 analogue output
- 2 switching outputs and one analogue output



SCTSD-L combination switch

Technical data

General	
Measurement principle	Magnetic float reed switches
Float	NBR, Ø 18 mm, length 25 mm, magnetic
Viscosity	Max. 250 cSt at 25 °C
Density	at least 0.750 g/cm ³
Connector thread	G3/4 outer thread
Protection tube	Ø 8 mm
Probe length Lmax	Lowest switching point + 35 mm
Operating pressure	1 bar max.
Accuracy	±2 mm
Material	
Protection tube	Brass
Connector thread	Brass
Ambient conditions	
Temperature of substance	-20...+85 °C / (-4...185°F)
Storage temperature	-40...+100 °C / (-40...212°F)

Preset temperatures	
Switching output 1*	50 °C (122°F) contact closed (cooling on)
	45 °C (113°F) contact open (cooling off)
Switching output 2*	63 °C (145°F) contact open (shutdown)
	60 °C (140°F) contact closed
Level switching outputs	
Switching current:	0.5 A max.
Switching voltage	100 V max.
Switching power	10 W max.
Switching function	NO or NC (bi-stable)
Contact material	Rhodium
Plug	M12x1; 4 pin
Smallest difference between L1 and L2	30 mm
Smallest switching position L1	30 mm from the tank lid

*) Each temperature switching output can be individually re-programmed or adjusted:

- NO/NC contact
- On/off switching temperature
- Hysteresis / window function
- Time delay and attenuation

Fill level pin assignments

M12x1; 4-pole

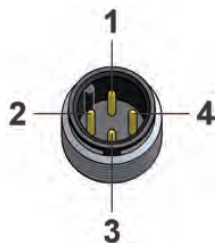

PIN	Assignment
1	IN
2	OUT S2
3	n.c.*
4	OUT S1

*n.c. = do not connect

SCTSD-L combination switch

Temperature pin assignment

SCTSD-150-0X-0X
(Refer chapter SCTSD)

SCTSD-L-xxxxO-xxFO
SCTSD-L-xxxxx-xxxxx-KIT5
2 switching outputs
M12x1; 4-pole

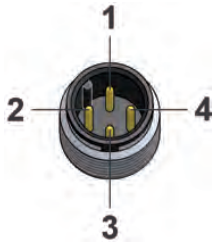

PIN	Assignment
1	V ₊
2	S2 out
3	0 V / GND
4	S1 out

SCTSD-L-xxxxx-xxxxx-17-KIT5
1 switching output, 1 analogue output
M12x1; 4-pole

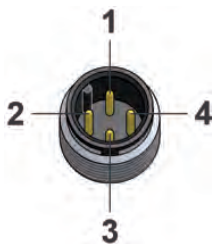

PIN	Assignment
1	V ₊
2	Analogue out
3	0 V / GND
4	S1 out

SCTSD-L-xxxxO-xxFO
SCTSD-L-xxxxx-xxxxx-15-KIT5
2 switching outputs, 1 analogue output
M12x1; 5-pole



PIN	Assignment
1	V ₊
2	S2 out
3	0 V / GND
4	S1 out
5	Analogue out

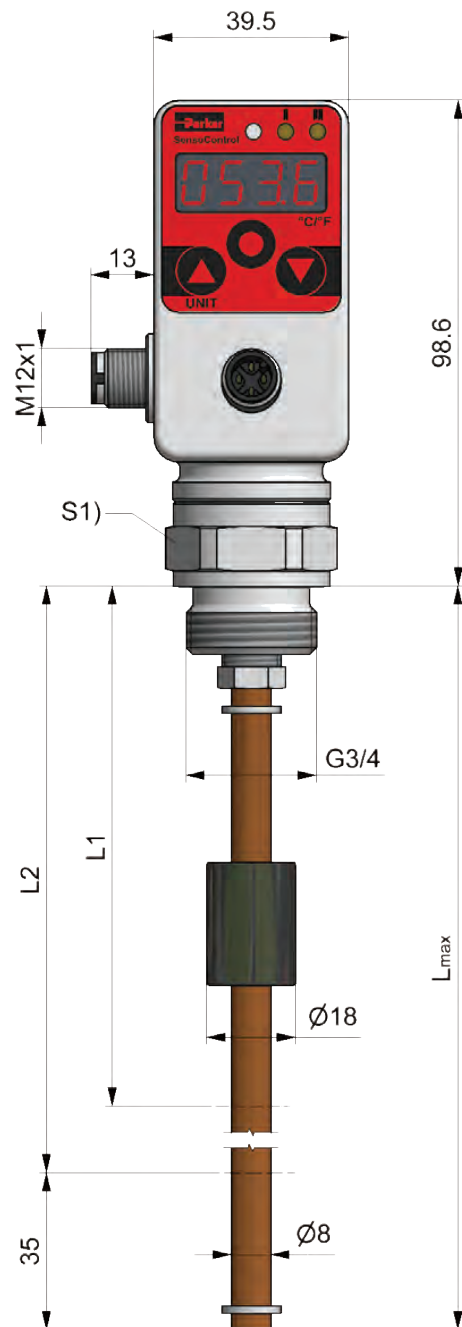

SCTSD-L combination switch

Order code

Combination switch ———— **SCTSD-L-xxxxx-xxxxxQ2**
Combination switch Marine ———— **SCTSD-L-xxxxx-xxxxx-MAQ2**

(approved by DNV/GL/ABS)
 2 level outputs, temperature display
 2 temperature switching outputs

Combination switch ———— **SCTSD-L-xxxxx-xxxxx-1xQ2**
Combination switch Marine ———— **SCTSD-L-xxxxx-xxxxx-1x-MAQ2**

(approved by DNV/GL/ABS)
 2 level outputs, temperature display
 1 temperature-analogue output
 (0/4..20 mA)

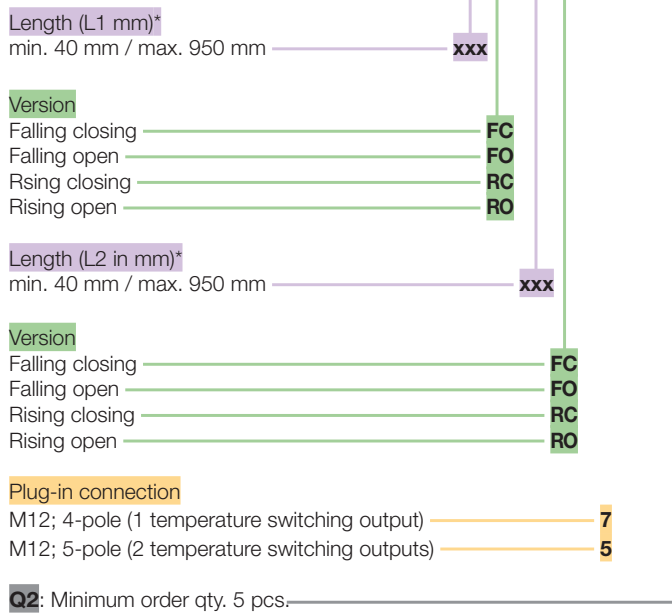

*Switching output 1 (L1) can be above or below switching output 2 (L2)
 L1 and L2 are multiples of 10 mm
 Smallest difference between L1 and L2 = 30 mm

SCLSD LevelController

Device features

- Proven measuring system
- Level display
- mm / inch / % display
- High and low display
- Analogue output
- Switching outputs
- No surge pipe necessary
- Replacement for several mechanical switches
- Pivoting



The LevelController combines the functions of a level switch, a level sensor and a level display.

- Level display (inspection glass)
- Switching outputs
- Analogue signal

The LevelController is ideal for the monitoring tank contents.

Easy to use

The parameters are set using the keys or over a programming module.

High functionality

Each switching output can be adjusted individually:

- NO/NC contact
- Upper and lower level switching point
- Delay times
- Hysteresis / window function
- Attenuation

The analogue output is individually adjustable:

- 0/4...20 mA switchable
- Upper level adjustable
- Lower level adjustable

Reliable and safe

The position of the float is finely (≥ 5 mm) and continuously recorded and shown in the display in mm or inch. Through this continuous recording, the danger of individual mechanical contacts "sticking" no longer exists. Therefore the operational reliability of the monitored plant is increased. Parameters can be password protected to avoid unauthorised changes.

Everything at a glance

The display can be read from long distances. Using the selectable percent display the full level is uniformly displayed independent of the tank shape. An offset can also be entered (difference from the sensor to the tank bottom) to give a realistic indication of the level from the tank bottom.

Different uses can easily be implemented or corrected at a later date using the menu-driven level switching points. As the switching point no longer needs to be specified at the time of order, the versions of mechanical level switches required is reduced.

Universal

Thanks to these easy switching functions (hysteresis and window functions, NC or NO functions), intelligent adjustments can be set which are normally not possible using a mechanical level switch. Therefore, many switches can be replaced with one controller. With the optional analogue output, the level and temperature can be monitored easily with a controller (e.g. for leakage monitoring).

SCLSD LevelController

Application example: Tank temperature monitoring

Since the conventional specifications for mechanical level switches (the mm data from the tank lid) are often used during project planning, these data are selected here for a practical example.

Facility off

If the tank level falls below 310 mm (measured from the tank top / dry run) or climbs above 70 mm (measured from the tank top / overflow), switch off should occur. A protective wire-break mechanism should be considered to improve safety.

Automatic tank filling

If the tank level falls below 240 mm (measured from the tank top), the tank should be automatically filled to 110 mm (measured from the tank top) with a pump.

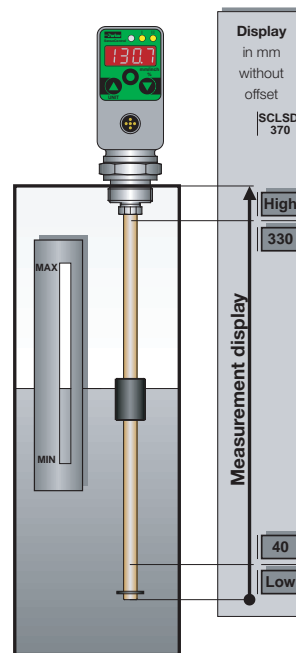

Resulting switch value for a SCLSD-370 mm

Stop above:
370 mm - 70 mm = 300 mm
Stop below:
370 mm - 310 mm = 60 mm
Window function, NO contact

The output S1 is closed, if the level is between 300 and 60 mm.

Load stop:
370 mm - 110 mm = 260 mm
Load on:
370 mm - 240 mm = 130 mm
Hysteresis function, NC contact

If the level falls below 130 mm, the contact closes and opens again when 260 mm is exceeded.

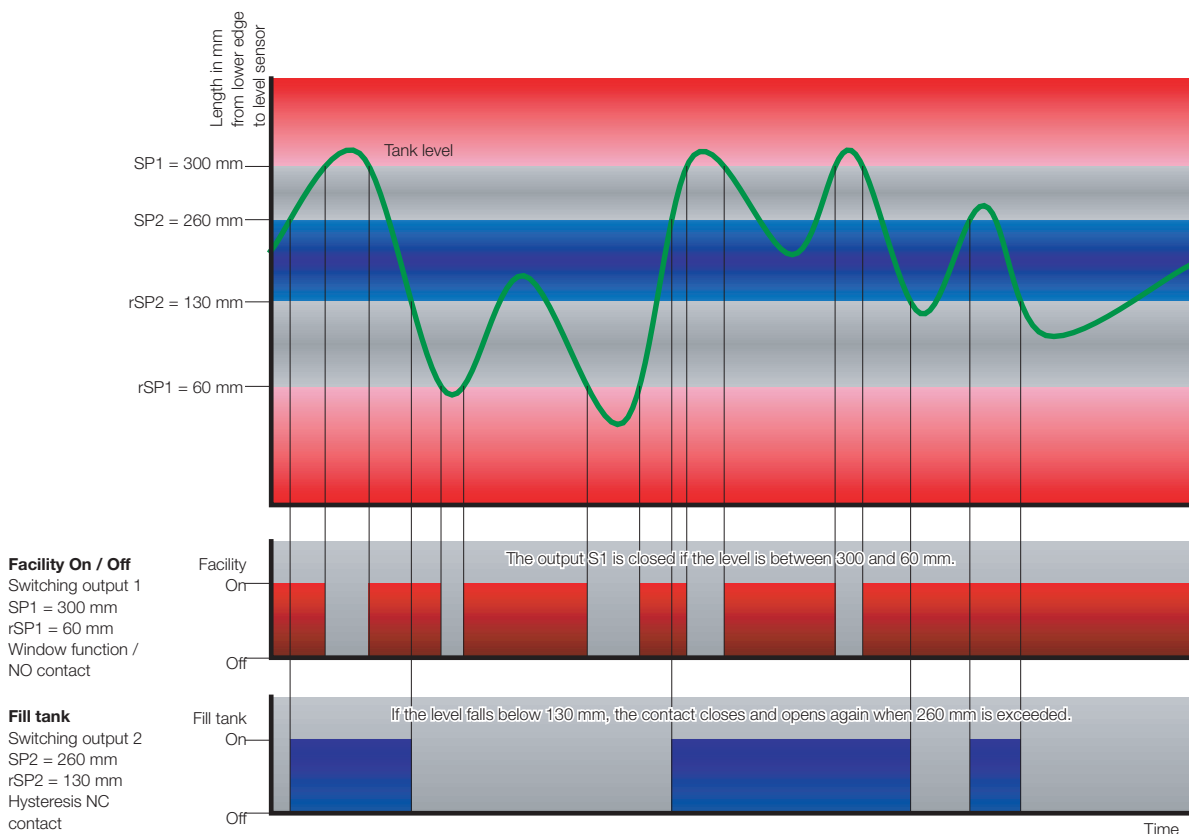

The Controller Family

SCLSD LevelController

Device features

Everything at a glance

- Sloped display
- Digital display
 - Large
 - Illuminated
- Display
 - mm, inch, or %
 - Actual level
 - High and low display
 - Switching points

Rugged

- Metal housing
- Waterproof
- Excellent interference immunity
- Vibration proof
- Shock proof

Variable installation

- Compact size
- 290° pivotable
- G3/4 BSPP
- Flange for DIN

Programming module

- Adjustable with ControllerWIN Software

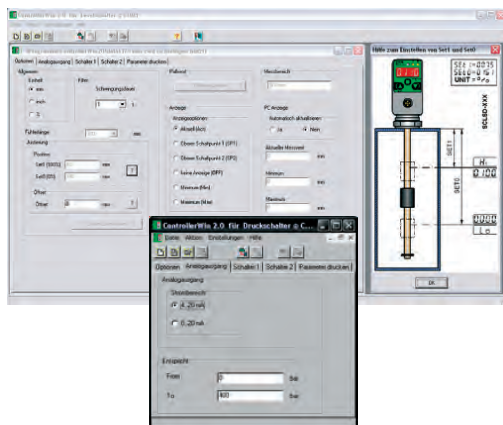

Optical interface

- Switch status is shown

Easy to use

- 3 large buttons
- Display of the unit

Connect as required

- 2 switching outputs
- Analogue output
- 0...20 or 4...20 mA
- Freely programmable
- Scalable
- M12 connecting plugs



No surge pipe necessary

- Electronic attenuation adjustable attenuation

Proven measuring system

- High float dynamics
- Small design
- Universal usage

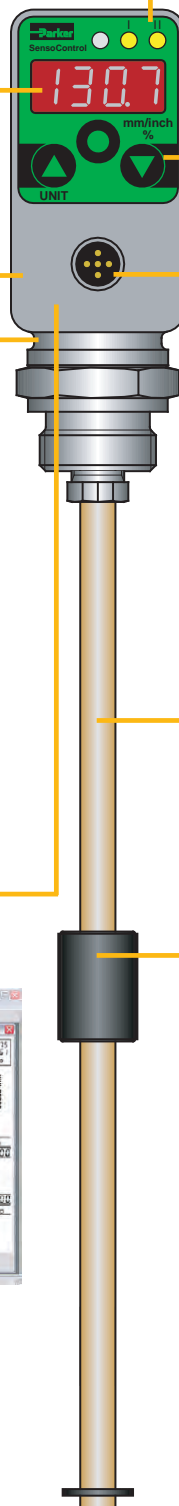

SCLSD LevelController

Technical data

Input parameters	
Measuring component	Resistance reed chain with float
Connector thread	G3/4 BSPP; nickel-plated brass; ED soft seal NBR*
Parts in contact with substances	Brass; nickel-plated brass; NBR*
Temperature range of substance	-20...+85 °C / (-4...185°F)
Output values	
Switching point accuracy	± 1 % FS at 25 °C (77°F)
Display accuracy	± 1 % FS ± 1 Digit at 25 °C (77°F)
Response speed	≤ 700 ms
Resolution	7.5 mm
Float	
Material	NBR
Dimensions	Ø 18 mm, Length 35 mm
Viscosity	Max. 250 cSt at 25 °C (77°F)
Density	at least 0.750 g/cm ³
Level rod	
Material	Stainless steel
Dimensions	Ø 8 mm
Operating pressure	1 bar
Electrical connection	
Supply voltage V ₊	15...30 VDC nominal 24 VDC; Protection class 3
Electrical connection	M12x1; 4-pole; 5-pole; with gold-plated contacts
Short-circuit protection	Yes
Protection against wrong insertion	Yes
Overload protection	Yes
Current consumption	< 100 mA

Housing	
	Adjustable direction to 290°C
Material	Die-cast zinc Z 410; painted
Foil material	Polyester
Display	4-digit 7-segment LED; red; digit height 9 mm
Protection degree	IP67 DIN EN 60529
Ambient conditions	
Ambient temperature range	-20...+85 °C / (-4...185°F)
Storage temperature range	-40...+100 °C / (-40...212°F)
EM compatibility	
Disturbance emissions	EN 61000-6-3
Resistance to interference	EN 61000-6-2
Outputs	
Switching outputs	Two MOSFET high-side switches (PNP)
Contact functions	NO / NC contact; window / hysteresis function freely adjustable
Switching voltage	V ₊ -1.5 VDC
Switching current max.	0.5 A per switch
Short-circuit current	2.4 A per switch
Analogue output	0/4...20 mA; programmable; freely scalable RL ≤ (power supply - 8 V) / 20 mA (≤ 500 Ω)

* different sealing material (FKM, EPDM etc.) upon request

SCLSD LevelController

Display possibilities

Example of a percent display

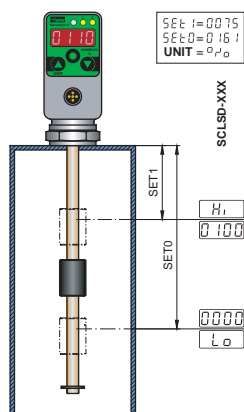

Example of a mm display

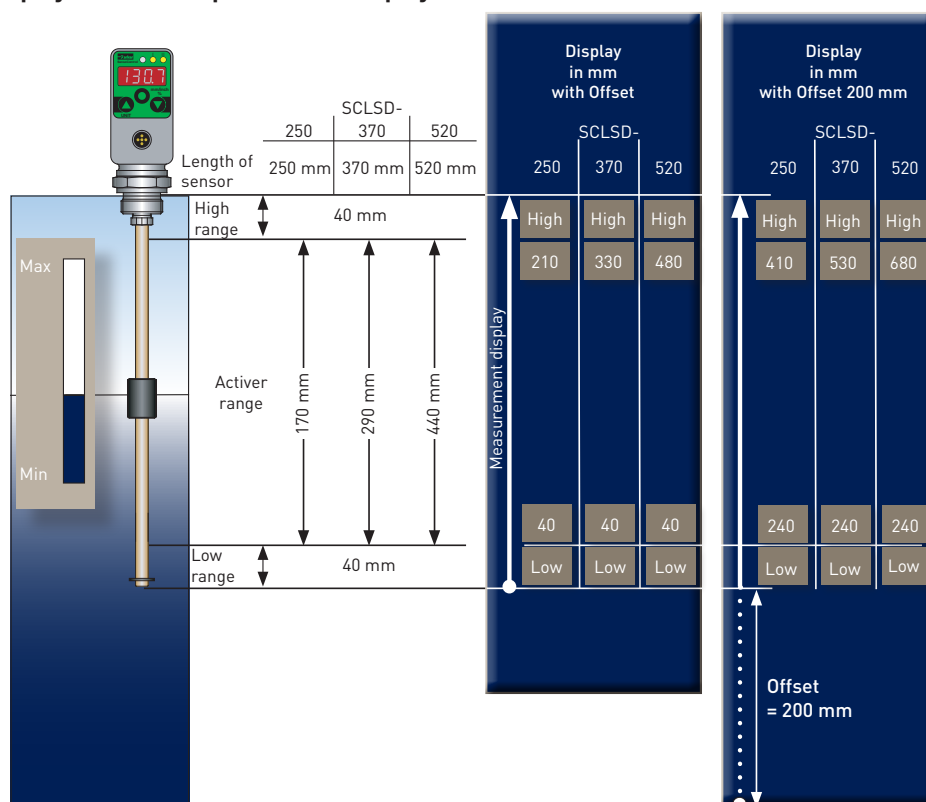

L1 Sensor length Measurement range	L2 active range	Display resolution Increment size	Incre- ment size	Lowest reset switch point RSP	Largest switch- ing value SP	Smallest adjustable difference between SP and RSP (SP-RSP)
250 mm	40...210 mm	1 mm	5 mm	40 mm	210 mm	5 mm
370 mm	40...330 mm	1 mm	5 mm	40 mm	330 mm	5 mm
520 mm	40...480 mm	1 mm	5 mm	40 mm	480 mm	5 mm
800 mm	40...760 mm	1 mm	10 mm	40 mm	760 mm	10 mm
1000 mm	40...960 mm	1 mm	10 mm	40 mm	960 mm	10 mm

Pin assignment

SCLSD-xxx-00-07

2 switching outputs; M12x1; 4-pole

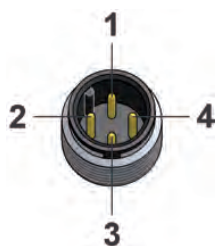

PIN	Assignment
1	V ₊
2	S2 out
3	0 V / GND
4	S1 out

SCLSD-xxx-10-07

1 switching output, 1 analogue output, M12x1; 4-pole

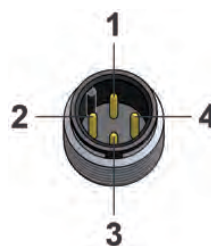

PIN	Assignment
1	V ₊
2	Analogue out
3	0 V / GND
4	S1 out



SCLSD LevelController

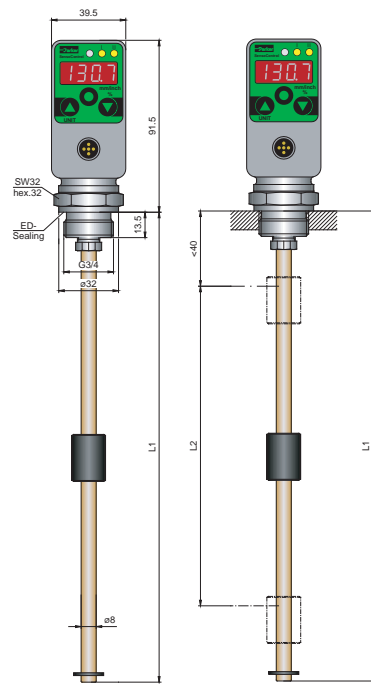

L1 = length of the sensor (mm)
L2 = active range (mm)

Order code

SCLSD LevelController
2 switching outputs;
2 switching outputs Marine;
(approved by DNV/GL/ABS)
no analogue output
M12x1 connecting plug; 4-pole

SCLSD-xxx-00-07
SCLSD-xxx-00-07-MA

1 switching output;
1 switching output Marine;
(approved by DNV/GL/ABS)
with analogue output
M12x1 connecting plug; 4-pole

SCLSD-xxx-10-07
SCLSD-xxx-00-07-MA

2 switching outputs;
2 switching outputs Marine;
(approved by DNV/GL/ABS)
with analogue output
M12x1 connecting plug; 5-pole

SCLSD-xxx-10-05
SCLSD-xxx-10-05-MA

Length (Installation length L1 mm)

250 mm	250
370 mm	370
520 mm	520
800 mm	800
1000 mm	1000

Accessories

PC Programming Kit

SCSD-PRG-KIT

Flange adapter

SCAF-3/4-90

6-hole connection DIN 24557, part 2

Connection cable and single plug

Connection cable, assembled

SCK-400-xx-xx

(open cable end)

Cable length (m)

2 m	02
5 m	05
10 m	10

Connecting plug

M12 cable jack; straight	45
M12 cable jack; 90° angled	55

Single connector

M12 cable jack; straight	SCK-145
M12 cable jack; 90° angled	SCK-155

SCLSD-xxx-10-05

2 switching outputs, 1 analogue output
M12x1; 5-pole



PIN	Assignment
1	V+
2	S2 out
3	0 V / GND
4	S1 out
5	Analogue out



SCLTSD LevelTempController

Device features

- Proven measuring system
- Pivoting
- Level display
- mm / inch / % display
- High and low display
- Analogue output
- Switching outputs
- Only one hole
- No surge pipe necessary
- Replacement for several mechanical switches



With the **LevelTempController**, you can set up and display the temperature and the level individually using a common platform. When monitoring the tank, this integration of level and temperature functionality opens up many possibilities.

The **LevelTempController** combines the functions of a level and temperature switch, a level and temperature sensor and a level and temperature indicator:

- Level and temperature display (thermometer / inspection glass)
- Switching outputs
- Analogue signal

Level

The position of the float is finely (≥ 5 mm) and continuously recorded and shown in the display in mm or inch. Because the level is continuously recorded, the danger of individual mechanical contacts "sticking" no longer exists. Therefore the operational reliability of the monitored plant is greatly increased.

Using the selectable percent display, the full level is uniformly displayed for the users, independent of the tank shape. An offset can also be entered (difference from the sensor to the tank bottom) to give a realistic indication of the level from the tank bottom.

Different uses can easily be implemented or corrected at a later date using the menu-driven level switching points.

As the switching point no longer needs to be specified at the time of order, the versions of mechanical level switches required is reduced.

Temperature

The temperature in the substance is continuously recorded and displayed. The switching outputs can be individually set up just like the LevelController. Naturally all the convenient switching functions are available: window, hysteresis function and open / close as well as an analogue output for temperature.

Reliable and safe

Parameters can be password protected to avoid unauthorised changes.

Universal

Thanks to these easy switching functions (hysteresis and window functions, NC or NO functions), intelligent adjustments can be set on the LevelTempController which are normally not possible using a mechanical level switch. Therefore, many switches can be replaced with one controller. With the optional analogue outputs, the level and temperature can be monitored easily with a controller.

Level: e.g. for leakage monitoring

Temperature: e.g. coolers, heating, alarm, shutdown

SCLTSD LevelTempController

Application examples

SCLSD



Application example
Refer to page 83

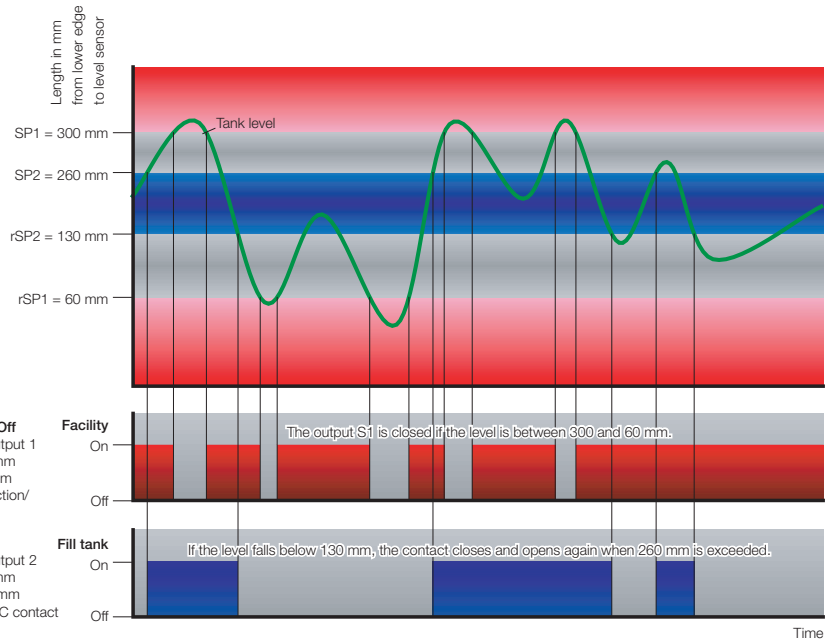

SCTSD



Application example
Refer to page 67

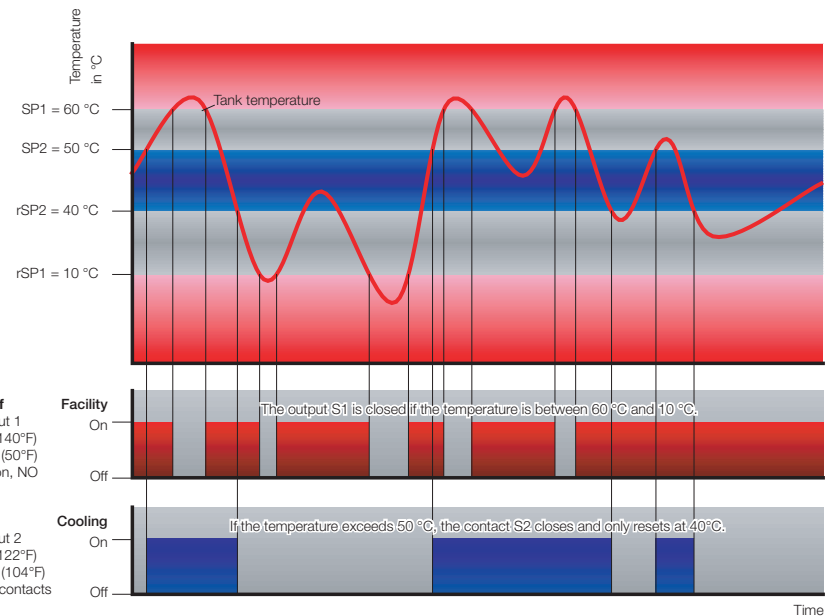

The Controller Family



SCLTSD LevelTempController

Device features

Everything at a glance

- Sloped display
- Digital display
 - Large
 - Illuminated
 - Switching points
- Display level
 - mm, inch, or %
 - Actual level
 - High and low display
- Temperature display
 - °C, °F
 - Current temperature

Rugged

- Metal housing
- Waterproof
- Excellent interference immunity
- Vibration proof
- Shock proof

Variable installation

- A coupling hole
- Compact size
- 290° pivotable
- G3/4 BSPP
- DIN flange

Programming module

- Adjustable with ControllerWIN Software

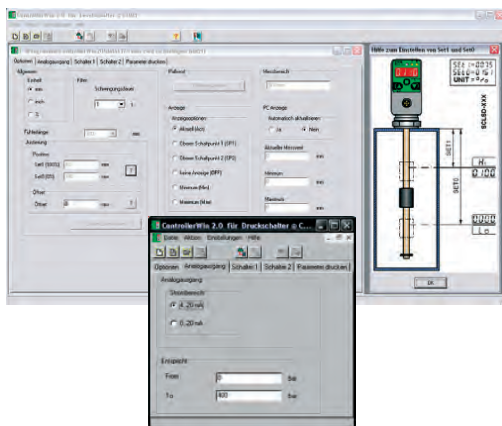

Optical interface

- Switch status is shown

Easy to use

- 3 large buttons
- Display of the unit

Connect as required

- 2 switching outputs
- Analogue output
- 0...20 or 4...20 mA
- Freely programmable
- Scalable
- M12 connecting plugs

Twin concept

- 2 in 1

No surge pipe necessary

- Electronic attenuation adjustable attenuation

Level

- Proven measuring system
- High float dynamics
- Small design
- Universal usage

Temperature sensor

- Integrated in the rod end



SCLTSD LevelTempController

Technical data

Electrical connection	
Supply voltage V_+	15...30 VDC nominal 24 VDC; Protection class 3
Electrical connection	M12x1; 4-pole; 5-pole; with gold-plated contacts
Short-circuit protection	Yes
Protection against wrong insertion	Yes
Overload protection	Yes
Current consumption	< 100 mA
Housing	
	Adjustable direction to 290°C
Material	Die-cast zinc Z 410; painted
Foil material	Polyester
Display	4-digit 7-segment LED; red; digit height 9 mm
Protection degree	IP67 DIN EN 60529
Ambient conditions	
Ambient temperature range	-20...+85 °C / (-4...185°F)
Temperature range of substance	≤ 80 °C / (≤ 176°F)
Storage temperature range	-40...+100 °C / (-40...212°F)
EM compatibility	
Disturbance emissions	EN 61000-6-3
Resistance to interference	EN 61000-6-2
Outputs	
Switching outputs	Two MOSFET high-side switches (PNP)
Contact functions	NO / NC contact; window / hysteresis function freely adjustable
Switching voltage	$V_+ - 1.5$ VDC
Switching current max.	0.5 A per switch
Short-circuit current	2.4 A per switch
Analogue output	0/4 to 20 mA; programmable; freely scalable $RL \leq (V_+ - 8 \text{ V}) / 20 \text{ mA} (\leq 500 \Omega)$

Level

Input parameters	
Measuring component	Resistance reed chain with float
Connector thread	G3/4 BSPP; nickel-plated brass; ED soft seal NBR*
Parts in contact with substances	Brass; nickel-plated brass; NBR*
Temperature range of substance	≤ 80 °C / (≤ 176°F)
Output values	
Switching point accuracy	± 1 % FS at 25 °C / (77°F)
Display accuracy	± 1 % FS ± 1 Digit at 25 °C / (77°F)
Response speed	≤ 700 ms
Resolution	7.5 mm
Float	
Material	NBR
Dimensions	Ø 18 mm, Length 35 mm
Viscosity	Max. 250 cSt at 25 °C / (77°F)
Density	at least 0.750 g/cm ³
Level rod	
Material	Stainless steel
Dimensions	Ø 8 mm
Operating pressure	1 bar

Temperature

Output values	
Switching point accuracy	± 0.35 % FS at 25 °C / (77°F)
Display accuracy	± 0.35 % FS ± 1 Digit at 25 °C / (77°F)
Response speed	≤ 300 ms
Analogue output	0/4...20 mA; programmable; freely scalable; 4...20 mA = -40...125 °C / (-40...257°F)

* different sealing material (FKM, EPDM etc.) upon request

SCLTSD LevelTempController

Display possibilities

Example of a percent display

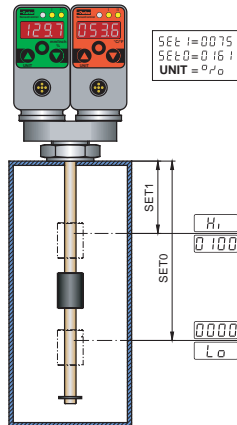

Example of a mm display

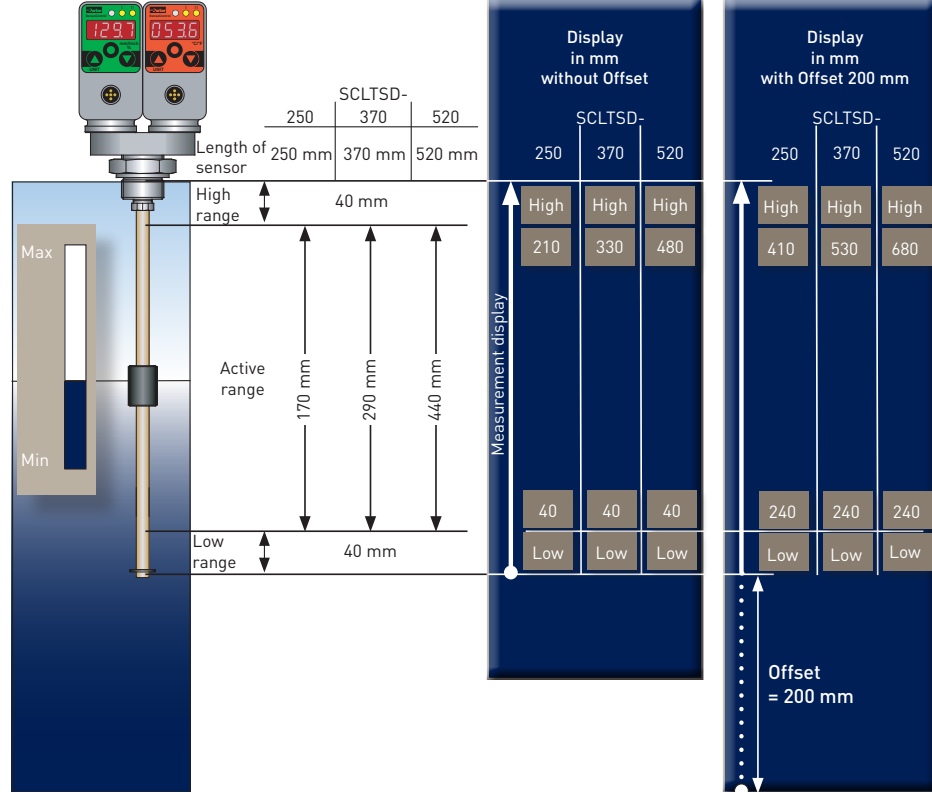

L1 Sensor length Measurement range	L2 active range	Display reso- lution Increment size	Increment size	Lowest reset switch point RSP	Largest switch- ing value SP	Smallest adjustable difference between SP and RSP (SP-RSP)
250 mm	40...210 mm	1 mm	5 mm	40 mm	210 mm	5 mm
370 mm	40...330 mm	1 mm	5 mm	40 mm	330 mm	5 mm
520 mm	40...480 mm	1 mm	5 mm	40 mm	480 mm	5 mm
800 mm	40...760 mm	1 mm	10 mm	40 mm	760 mm	10 mm
1000 mm	40...960 mm	1 mm	10 mm	40 mm	960 mm	10 mm

Pin assignment

SCLTSD-xxx-00-07 for temperature and level
2 switching outputs; M12x1; 4-pole

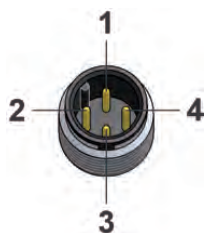

PIN	Assignment
1	V ₊
2	S2 out
3	0 V / GND
4	S1 out

SCLTSD-xxx-10-07 for temperature and level
1 switching output, 1 analogue output, M12x1; 4-pole

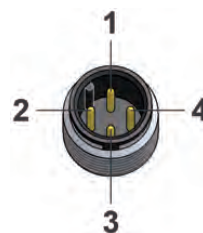

PIN	Assignment
1	V ₊
2	Analogue out
3	0 V / GND
4	S1 out



SCLTSD LevelTempController

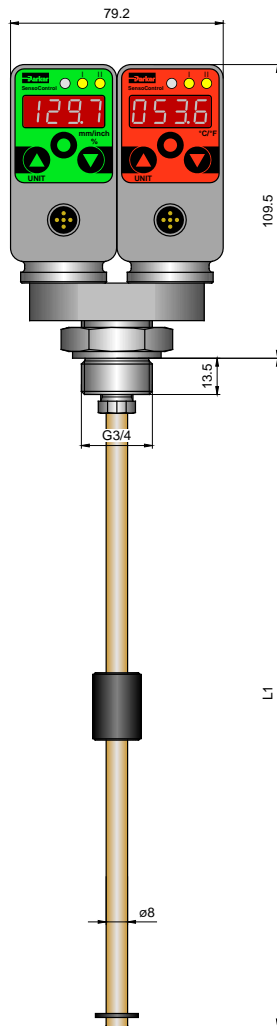

L1 = length of the sensor (mm)
L2 = active range (mm)

SCLTSD-xxx-10-05 for temperature and level
2 switching outputs, 1 analogue output; M12x1; 5-pole



PIN	Assignment
1	V ₊
2	S2 out
3	0 V / GND
4	S1 out
5	Analogue out



Order code

SCLTSD LevelTempController

2 switching outputs;
2 switching outputs Marine;
(approved by DNV/GL/ABS)
no analogue output
M12x1 connecting plug; 4-pole

SCLTSD-xxx-00-07
SCLTSD-xxx-00-07-MA

1 switching output;
1 switching output Marine;
(approved by DNV/GL/ABS)
with analogue output
M12x1 connecting plug; 4-pole

SCLTSD-xxx-10-07
SCLTSD-xxx-10-07-MA

2 switching output;
2 switching output Marine
(approved by DNV/GL/ABS)
with analogue output
M12x1 connecting plug; 5-pole

SCLTSD-xxx-10-05
SCLTSD-xxx-10-05-MA

Installation length (L1 mm)

250 mm	250
370 mm	370
520 mm	520
800 mm	800
1000 mm	1000

Accessories

PC Programming Kit

SCSD-PRG-KIT

Flange adapter

SCAF-3/4-90

6-hole connection DIN 24557, part 2

Connection cable and single plug

Connection cable, assembled

SCK-400-xx-xx

(open cable end)

Cable length (m)

2 m	02
5 m	05
10 m	10

Connecting plug

M12 cable jack; straight	45
M12 cable jack; 90° angled	55

Single connector

M12 cable jack; straight	SCK-145
M12 cable jack; 90° angled	SCK-155

SCOTC OilTankController

Device features

- Proven measuring system
- Level and temperature display
- mm / inch / % display
- High and low display
- Only one hole
- Continuous level measurement
- Connection
 - Filling coupling
 - Air filter
 - Low pressure
- No surge pipe necessary

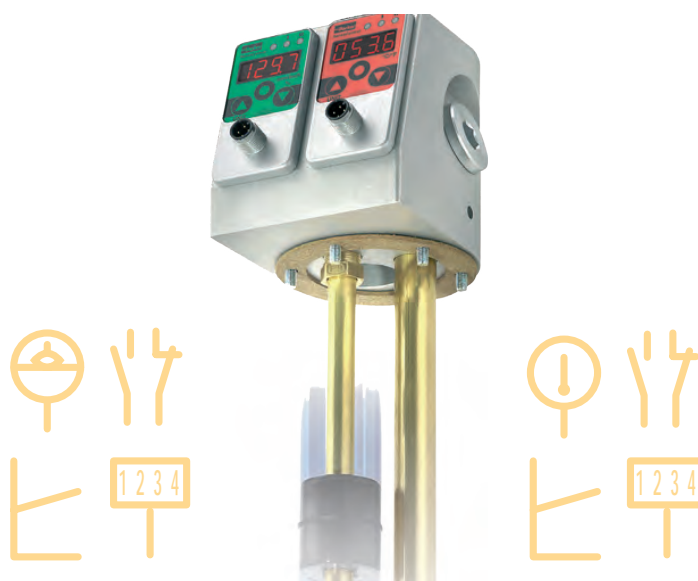

In addition to the **LevelTempController**, the **OilTankController** also offers standardised connections for an air filter and a fill coupling.

When monitoring the tank for series use, this integration of level and temperature functionality together with air filter and fill adapter port opens up many possibilities. An additional connecting hole is required for the four functions.

The OilTankController combines the functions of a level and temperature switch, a level and temperature sensor and a level and temperature display:

- Level and temperature display (thermometer / inspection glass)
- Switching outputs
- Analogue signal

Level

The position of the float is finely (≥ 5 mm) and continuously recorded and shown in the display in mm or inch. Because the level is continuously recorded, the danger of individual mechanical contacts "sticking" no longer exists. Therefore the operational reliability of the monitored plant is greatly increased.

Using the selectable percent display, the full level is uniformly displayed for the users, independent of the tank shape. An offset can also be entered (difference from the sensor to the tank bottom) to give a realistic indication of the level from the tank bottom.

Different uses can easily be implemented or corrected at a later date using the menu-driven level switching points.

As the switching point no longer needs to be specified at the time of order, the versions of mechanical level switches required is reduced.

Temperature

The temperature in the substance is continuously recorded and displayed. The switching outputs can be individually set up just like the LevelController. Naturally all the convenient switching functions are available: window, hysteresis function and open/close as well as an analogue output for temperature.

Reliable and safe

Parameters can be password protected to avoid unauthorised changes.

Universal

In combination with the comfortable switch functions like hysteresis and window function, open/close contact functions **LevelTempController** intelligent settings can be made which are not possible with a mechanical level/temperature switch. Therefore, many switches can be replaced with one controller. With the optional analogue outputs, the level and temperature can be monitored easily with a controller.

Level: e.g. for leakage monitoring

Temperature: e.g. coolers, heating, alarm, shutdown



SCOTC OilTankController

Application examples

SCLSD

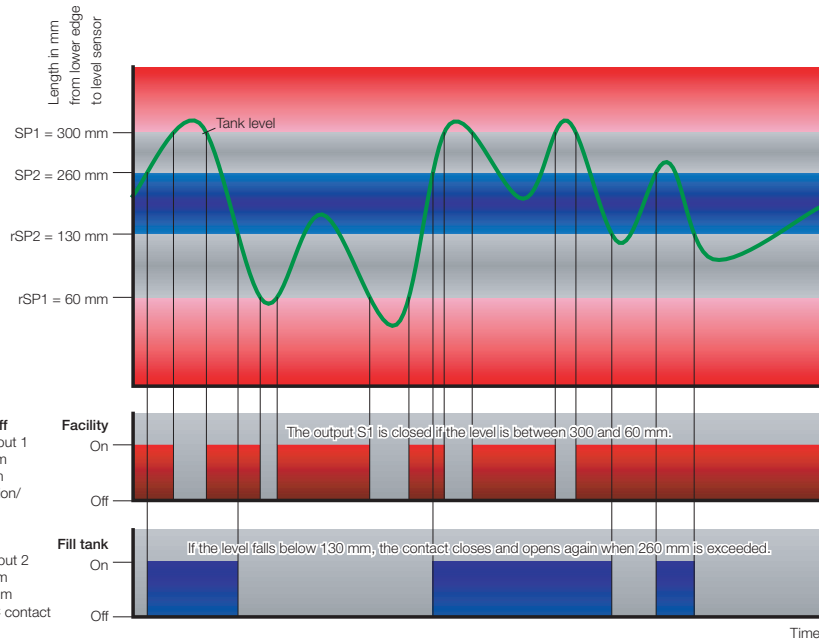

Application example
Refer to page 83

SCTSD

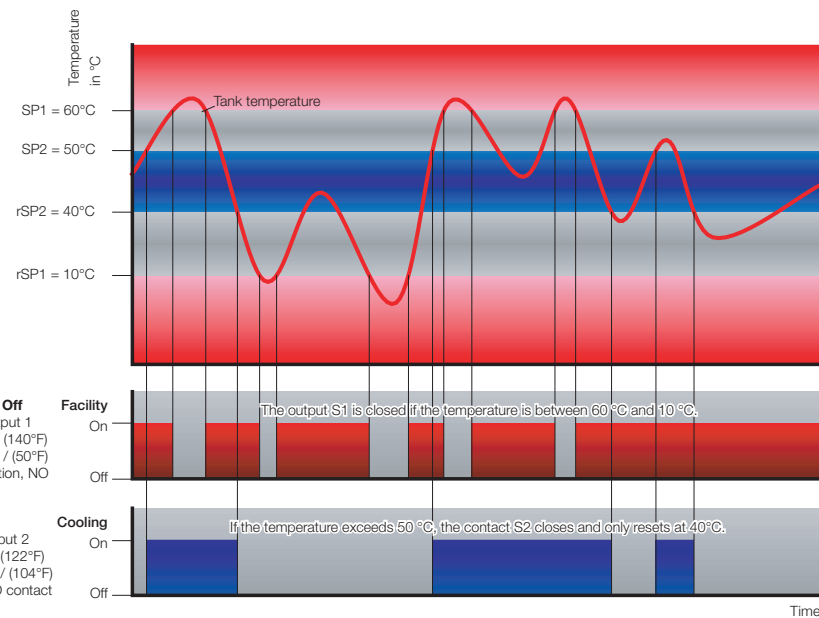

Application example
Refer to page 67

The Controller Family



SCOTC OilTankController

Device features

Getting to the point

- Compact construction (4 in 1)
- Easy adjustment of the switching points using the menu
- Analogue output
- Safety control
- Cost savings in the logistics, assembly and maintenance

Level and temperature

- Display
- Adjustable switching output
- Analogue output

The extended version

with safety control

- Additional fixed switching contacts
- Level min/max
- Temperature too high

Real fill level

- The level controller continuously measures the position of the float and continuously shows the position in the display.
- Up to 1000 mm

No surge pipe necessary

- Electronic attenuation
- adjustable attenuation

Temperature sensor

- Integrated in the rod end

6-hole standard for

- Ventilation filter* (DIN 24557, part 2)

G3/4 BSPP for

- Filling coupling*

G1/8 BSPP for

- Low pressure switch*
- Clogging indicator*

6-hole standard for

- Tank connection (DIN 24557, part 2)

Filling tube

No whirl-up

- Whirl-up protection

Programming module

- Adjustable with ControllerWIN Software

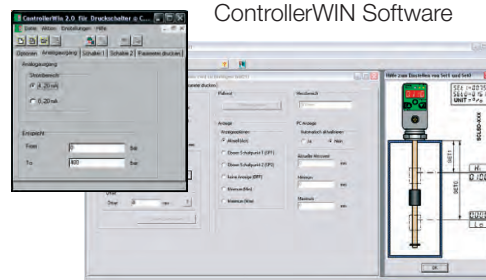
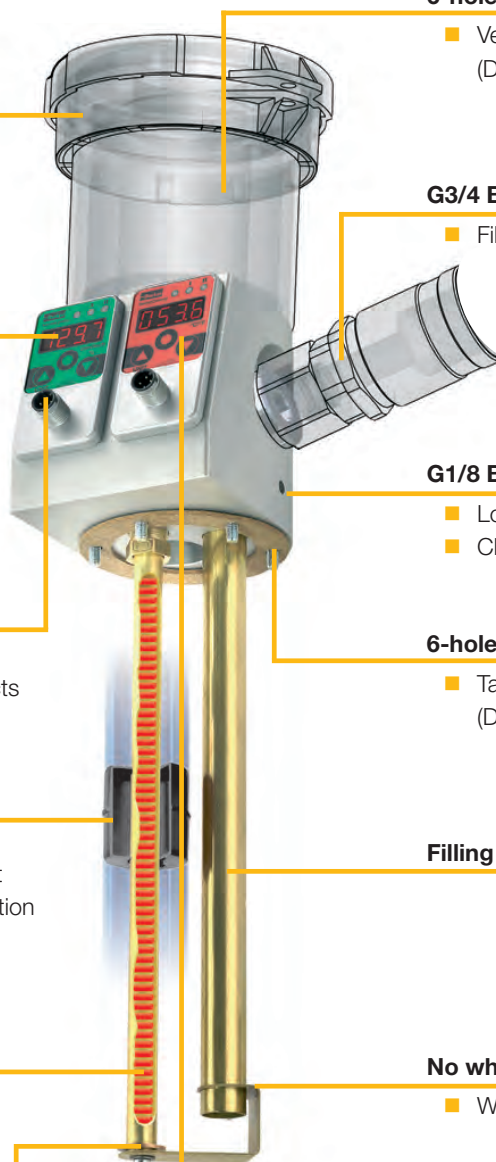

* Venting filter, filling coupling, low pressure switch and clogging indicator are not included in the delivery.

SCOTC OilTankController

Technical data

SCOTC	250	370	520	800	1000
Tank installation length	250 mm	370 mm	520 mm	800 mm	1000 mm
Adjustment range	40...210 mm	40...330 mm	40...480 mm	40...760 mm	40...960 mm

Electrical connection	
Supply voltage V_+	15 to 30 VDC nominal 24 VDC; Protection class 3
Electrical connection	M12x1; 4-pole; 5-pole; with gold-plated contacts
Short-circuit protection	Yes
Protection against wrong insertion	Yes
Overload protection	Yes
Current consumption	< 100 mA
Housing	
Material	Die-cast zinc Z 410; painted Aluminium
Foil material	Polyester
Display	4-digit 7-segment LED; red; digit height 9 mm
Protection degree	IP67 DIN EN 60529
Ambient conditions	
Ambient temperature range	-20...+80 °C / (-4...176°F)
Temperature range of substance	≤ 80 °C / (≤ 176°F)
Storage temperature range	-40...+100 °C / (-40...212°F)
Sampling period	300 ms
Display refresh	1 s
EM compatibility	
Disturbance emissions	EN 61000-6-3
Resistance to interference	EN 61000-6-2
Outputs	
Switching outputs	Two MOSFET high-side switches (PNP)
Contact functions	NO / NC contact; window / hysteresis function freely adjustable
Switching voltage	V_+ -1.5 VDC
Switching current max.	0.5 A per switch
Short-circuit current	2.4 A per switch
Optional analogue output	
Measuring range	0/4...20 mA; programmable
Response speed (0 to 95%)	≤ 300 ms
Error	± 1 % FS
Load	≤ 500 Ω from V_b > 18 VDC

Level	
Input variables	
Measuring component	Reed chain resistance
Connector thread	6 hole standard- DIN 24557, part 2
Output variables	
Switching point accuracy	± 1 % FS at 25 °C
Display accuracy	± 1 % FS ± 1 Digit at 25 °C
Response speed	≤ 700 ms
Resolution	5 mm...520 mm; 10 mm > 520 mm
Float	
Material	Polypropylene
Dimensions	Ø 35 mm, Length 40 mm
Level rod	
Material	Brass
Dimensions	Ø 12 mm
Operating pressure	1 bar max.
Optional Lo-Hi contact (S3 out)	
Alarm contact	In series switched Lo and Hi NC contact
Maximum load current	0.7 A
Temperature	
Input variables	
Sensor element	PT1000
Filling tube	Ø 18x1 mm
Response time	$\tau_{0.9} = 60$ s
Output variables	
Switching point accuracy	± 0.5 % FS at 25 °C / (77°F)
Display accuracy	± 0.5 % FS ± 1 Digit at 25 °C / (77°F)
Response speed	≤ 300 ms
Analogue output	0/4...20 mA; programmable; freely scalable; 4...20 mA = -40...125 °C / (-40...257°F)
Optional temperature switch (S3 out)	
Alarm contact with > 65 °C	Open contact
Maximum charging current	0.7 A

SCOTC OilTankController

Pin assignment

Without safety-control-output

SCOTC-xxxx-00-07

for temperature and level

2 switching outputs

M12x1; 4-pole

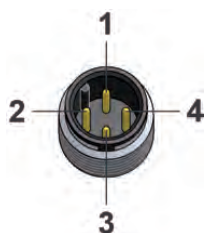

PIN	Assignment
1	V ₊
2	S2 out
3	0 V / GND
4	S1 out

With safety-control-output

SCOTC-xxxx-00-05

Level:

Two variable switching outputs,

One fixed safety-control-output level min/max;

M12x1; 5-pole



PIN	Assignment
1	V ₊
2	S2 out
3	0 V / GND
4	S1 out
5	S3 out (L-Low / L-High)

SCOTC-xxxx-10-07

for temperature and level

1 switching outputs, 1 analogue output

M12x1; 5-pole

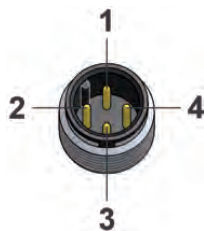

PIN	Assignment
1	V ₊
2	Analogue out
3	0 V / GND
4	S1 out

SCOTC-xxxx-00-05

Temperature:

Two variable switching outputs,

One fixed safety-control-output temperature max. 65 °C

M12x1; 5-pole



PIN	Assignment
1	V ₊
2	S2 out
3	0 V / GND
4	S1 out
5	S3 out (T-High)

SCOTC-xxxx-10-05

for temperature and level

2 switching outputs, 1 analogue output

M12x1; 5-pole



PIN	Assignment
1	V ₊
2	S2 out
3	0 V / GND
4	S1 out
5	Analogue out

L1 Sensor length Measurement range	L2 active range	Display resolu- tion increment size	Increment size	Lowest reset switch point RSP	Largest switch- ing value SP	Smallest adjustable difference between SP and RSP (SP-RSP)
250 mm	170 mm	1 mm	5 mm	40	210	5 mm
370 mm	290 mm	1 mm	5 mm	40	330	5 mm
520 mm	440 mm	1 mm	5 mm	40	480	5 mm
800 mm	720 mm	1 mm	10 mm	40	760	10 mm
1000 mm	920 mm	1 mm	10 mm	40	960	10 mm

SCOTC OilTankController

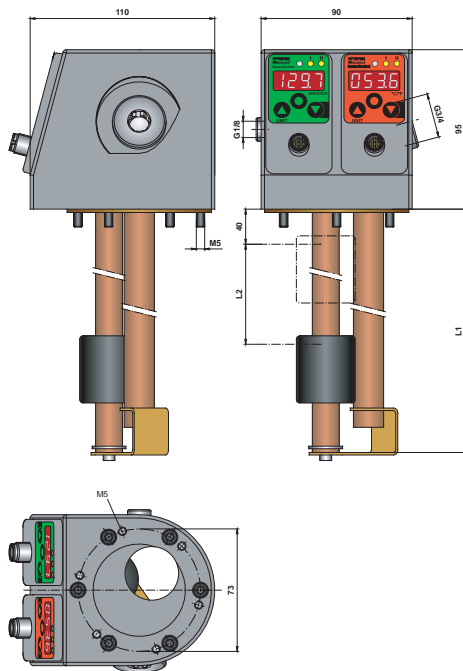

L1 = length of the sensor (mm)
L2 = active range (mm)

Order code

SCOTC OilTankController *

2 switching outputs; no analogue output SCOTC-xxxx-00-07
M12x1 connecting plug; 4-pole

2 switching outputs; with analogue output SCOTC-xxxx-10-07
M12x1 connecting plug; 4-pole

1 switching output; with analogue output SCOTC-xxxx-10-05
M12x1 connecting plug; 5-pole

3 switching outputs; no analogue output SCOTC-xxxx-00-05
M12x1 connecting plug; 5-pole
with safety control

Length (Installation length L1 mm)

250 mm	250
370 mm	370
520 mm	520
800 mm	800
1000 mm	1000

Accessories

PC Programming Kit

SCSD-PRG-KIT

Connection cable and single plug

Connection cable, assembled

SCK-400-xx-xx

(open cable end)

Cable length (m)

2 m	02
5 m	05
10 m	10

Connecting plug

M12 cable jack; straight	45
M12 cable jack; 90° angled	55

Single connector

M12 cable jack; straight	SCK-145
M12 cable jack; 90° angled	SCK-155

* Venting filter, filling coupling, low pressure switch and clogging indicator are not included in the delivery.

SCK cable

Device features

- One cable for all
- Compact size
- Interference-free
- Compatible to:
 - Sensors
 - Controllers
- M12 plug
- DIN EN 175301 (Device plug)
- Available in a variety of lengths



The **SensoControl**® cable was designed for use with the industrial sensors and switches.

Thus the M12 cable and M12 plug are

- Compact
- Shielded
- Five-pole

5-pole version

The 5-pole cable is suitable for both 4-pole and 5-pole connections. The sensor variants with a 4-pole connector are fully compatible with the 5-pole cable.

So despite different pin counts on the pressures switch (Controller Family SCxSD and SCOTC) and sensors, it is always possible to use just one cable version (5-pole) regardless of the plug version.

The SCK-400-xxx-x5 cables fit to all components in this catalogue using M12 connectors.

Shielding

Shielding protects against interference and ensures improved operational safety.

- Higher EMC protection

Pin assignment

SCK-400-xx-x5

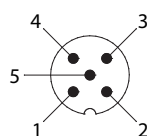

PIN			
1	bn	brown	braun
2	wh	white	weiß
3	bu	blue	blau
4	bk	black	schwarz
5	gy	grey	grau

SCK-400-xx-56



PIN			
1	ye	yellow	gelb
2	gn	green	grün
3	bn	brown	braun

SCK cable

Connection cable

SCK-400-xx-45

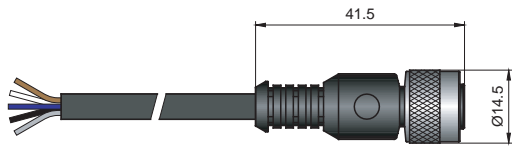

SCK-400-xx-55

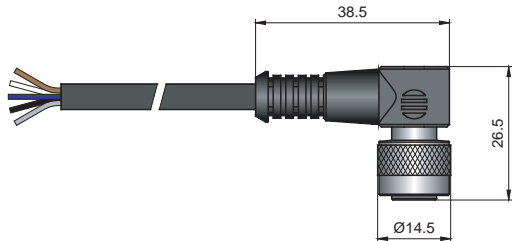

SCK-400-xx-56

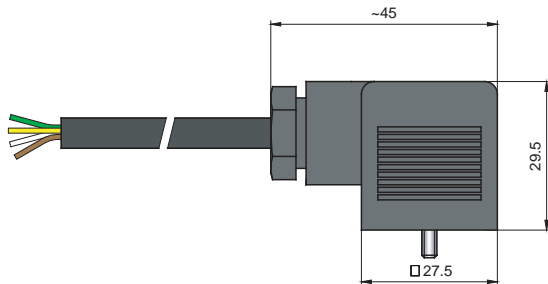

Single connector

SCK-145

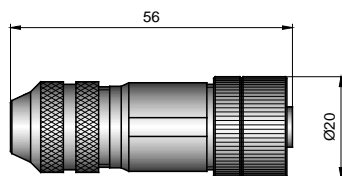

SCK-155

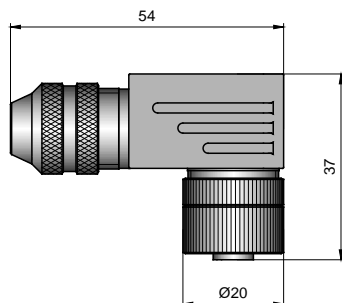

Single connector

SCK-006 (Device plug)

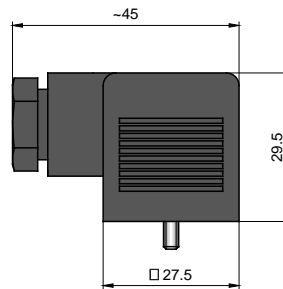

Accessories

Connection cable and single plug

Connection cable, assembled

(open cable end)

Cable length (m)

2 m	02
5 m	05
10 m	10

Connecting plug

M12 cable jack; straight	45
M12 cable jack; 90° angled	55
Cable socket DIN EN 175301-803 Form A (old DIN 43650)	56

Single connector

M12 cable jack; straight	SCK-145
M12 cable jack; 90° angled	SCK-155
Cable socket DIN EN 175301-803 Form A (old DIN 43650)	SCK-006



SCA adapter

SCA-1/4 reduction adapter

The SCA-1/4 provides compatibility for earlier sensor versions with the hydraulic connection M22x1.5 or G1/2 BSPP.

- When replacing earlier versions

This allows facilities to be updated without major planning overhead.

SCA-1/4-M22x1.5-ED
SCA-1/4-ED-1/2-ED

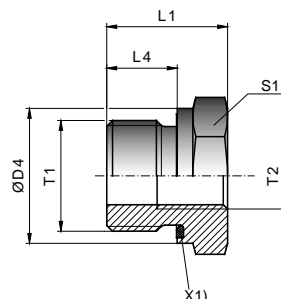

X1) EOLASTIC-seal

	T1	T2	ØD4	L1	L4	S1	Weight (g/1 St)	PN (bar) ¹⁾	DF **
SCA-1/4-M22x1.5-ED	M22x1.5	G1/4 BSPP	27	24	14	27	56	400	4
SCA-1/4ED1/2-ED	G1/2 BSPP	G1/4 BSPP	27	24	14	27	56	400	4

SCA-1/4 attenuation adapter

System-related pressure spikes are reduced with the SCA-1/4-EDX-1/4-D.

- Attenuation for pressure peaks

The G1/2 BSPP version ensures compatibility for earlier sensor versions to the G1/2 BSPP hydraulic connection.

- When replacing earlier versions

SCA-1/4-EDX-1/4-D

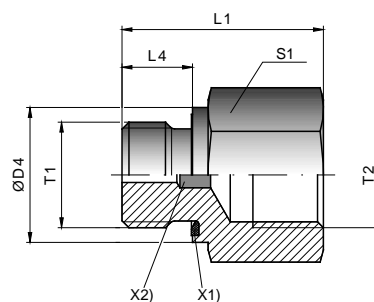

X1) EOLASTIC-seal

	T1	T2	ØD4	L1	L4	S1	Weight (g/1 St)	PN (bar) ¹⁾	DF **
SCA-1/4EDX1/4-D	G1/4A BSPP	G1/4 BSPP	19	34	12	22	61	630	3.5

SCA adapter

SCPSD flange adapter SCAF-1/4-40 for mechanical pressure switch

When replacing existing mechanical pressures switches with 40x40mm flange connections SCAF-1/4-40

SCAF-1/4-40
for mechanical pressure switch

SCAF-1/4-40

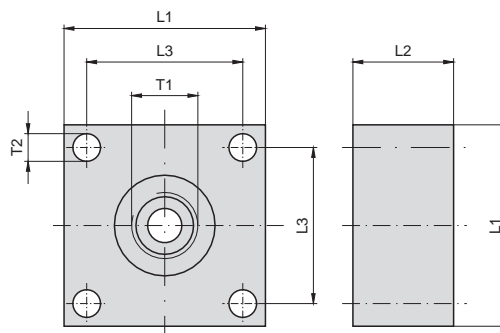

Accessories

T1	T2	L1	L2	L3	Weight (g/1 St)	PN (bar) ¹⁾ Alu	DF **
G1/4 BSPP	5.5	40	20	31	15	400	4

SCLSD/SCLTSD flange adapter SCAF-3/4-90 6-hole connection DIN 24557, part 2

For LevelController and LevelTemp Controller (SCLSD and SCLTSD), a compatibility to the tank connections 6-hole DIN 24557, part 2, is ensured. SCAF-3/4-90

SCAF-3/4-90
6-hole connection DIN 24557, part 2

SCAF-3/4-90

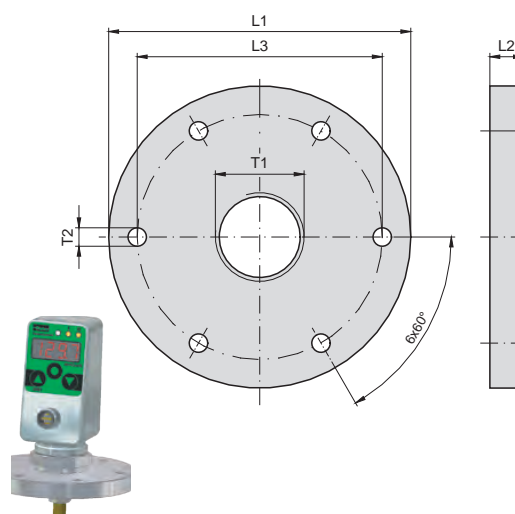

T1	T2	L1	L2	L3	Weight (g/1 St)	Material
G3/4 BSPP	5.5	90	10	73	520	Nickel-plated brass

** DF = Design Factor (safety factor)



ControllerWIN software

Device features

- Suitable for the Controller Family
- Simple adjustment of all parameters
- Saving of the parameters
- Adjustment with PC/laptop
 - at the workbench
 - at the desk
 - in the plant

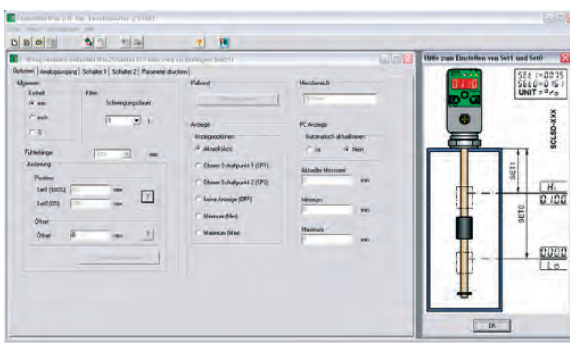

The ControllerWIN software allows the adjustment and saving of all parameters, including:

- Switching points
- NO / NC contact function
- Window / hysteresis
- Scaling of the analogue output
- Passwords

From the Controller Family product series:

- SCPSD
- SCTSD
- SCLSD
- SCLTSD
- SCOTC

Function

A no-contact infra-red interface is used to compare the data with the corresponding functional controller. This can take place directly in the facility or externally using a power supply unit (not included in the delivery).

- It is not necessary to disconnect the power supply or pull the cable out (operations are not interrupted).

A programming adapter is connected to the corresponding controller and the data is transmitted to a PC.

The SCSD-PRG_KIT programming kit includes all components (adapter, software and power supply) required for adjusting the controller with the PC or laptop:

- At the workbench
- At the desk
- In the plant

Application

- Saving and logging the adjusted values
- Programming multiple controllers
- Easy exchange of existing controllers

The programming kit is the ideal solution in each of these cases.

ControllerWIN software

Technical data

System requirements

Operating system	PC / laptop connection	Controller connection
WIN 98/2000/ME/NT/XP	RS232 (USB using conventional adapter)	Parker infra-red interface SCxSD/SCOTC

Accessories



Accessories for:

PressureController	TemperatureController	LevelController	LevelTempController	OilTankController
Pressure display and monitoring	Temperature display and monitoring	Level indication and monitoring	Level and temperature display and monitoring	

Order code

PC Programming KIT

SCSD-PRG-KIT



Installation and safety instructions

CE The CE mark indicates a high-quality device that complies with the European directive 89/336/EEG and EMVG.



The sensor will be damaged if the data sheet specifications and maximum recommended feed voltage levels are exceeded!

We confirm that these products comply with the following standards:

EMC

- Electromagnetic emission: EN 61000-6-3
- Electromagnetic immunity: EN 61000-6-2

Important

- Electromagnetic disturbances can affect the desired signal.
- Apply all general EMC strategies when planning facilities and machines.
- We recommend using shielded cables (SCK-400-xx-x5) in order to achieve better EMC immunity.
- Make sure you route analogue and data cables so that there is a sufficient gap between them.
- An effective earthing strategy will help you to avoid measuring errors.

Always connect metal housings with the reference ground. The PE protective earth should have a low-ohm connection. According to VDE 0701, the PE resistance must be measured.

Power feed voltage



Each sensor series specifies the recommended feed voltage to be used when operating the standard sensor. We recommend using a low-noise, high-quality, constant voltage source. Certain specifications (such as sensitivity and thermal sensitivity shift) may change when other power feeds are used. Each sensor is trimmed to its peak performance. The sensor's performance may change when other power feed types are used. Make sure you comply with the polarity and earthing regulations.

Improperly connected feed wires can damage sensors and amplifiers!

If one pole of the sensor feed is automatically earthed via the sensor's processing system, then you should avoid an additional earth on the sensor signal wire. This would cause the sensor to short circuit and damage the sensor.

Do not apply feed-in voltage to the output wires. This will permanently damage the sensors!

Compatibility with media (substances)

SensoControl® products which come into contact with the substance are not produced in an oil-free or fat-free environment.

Therefore these products are **not** suitable for use in applications which use explosive mixtures of oil and gas (e.g. oxygen or compression). This could lead to a danger of explosion!

Danger of explosion!

Only use substances which are compatible with the components that come into contact with the substance. (Refer to the data sheets)

Please consult with the plant manufacturer or the manufacturer of the substance if you have any questions. (Refer to catalogue 4100 chapter C).

Pressure range selection

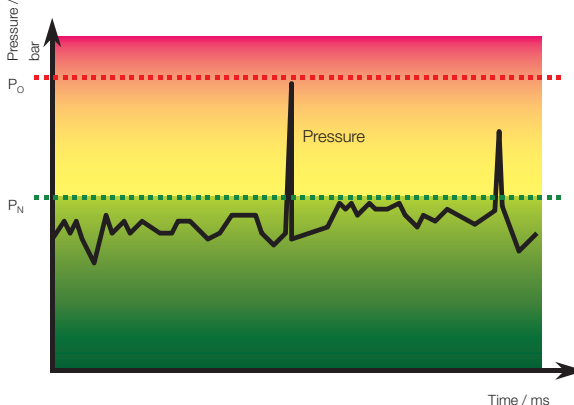

When selecting pressure components, ensure that the overload pressure P_{max} will not be exceeded.

It is possible that the pressure cell can be deformed when the overload pressure P_{max} is exceeded (depending on the duration, frequency and level of the pressure spike).

Note: The "diesel effect" caused by entrapped air can result in pressure spikes that far exceed the maximum pressure.

The nominal pressure P_N of the pressure component (sensor/switch) should be higher than the nominal pressure of the system to be measured.

Appendix

Temperature conversion table

Celsius to Fahrenheit

°C	°F
150	302
145	293
140	284
135	275
130	266
125	257
120	248
115	239
110	230
105	221
100	212
95	203
90	194
85	185
80	176
75	167
70	158
65	149
60	140
55	131
50	122
45	113
40	104
35	95
30	86
25	77
20	68
15	59
10	50
5	41
0	32
-5	23
-10	14
-15	5
-20	-4
-25	-13
-30	-22
-35	-31
-40	-40
-45	-49
-50	-58

Fahrenheit to celsius

°F	°C
340	171
330	166
320	160
310	154
300	149
290	143
280	138
270	132
260	127
250	121
240	116
230	110
220	104
210	99
200	93
190	88
180	82
170	77
160	71
150	66
140	60
130	54
120	49
110	43
100	38
90	32
80	27
70	21
60	16
50	10
40	4
30	-1
20	-7
10	-12
0	-18
-10	-23
-20	-29
-30	-34
-40	-40
-50	-46
-60	-51

Pressure conversion table

bar to psi

bar	psi
1000	14505
800	11604
600	8703
500	7253
400	5802
250	3626
160	2321
100	1451
60	870
40	580
35	508
25	363
16	232
10	145
6	87
4	58
2.5	36
1.6	23
1	15

psi to bar

psi	bar
10000	689
9000	620
7000	483
6000	414
4000	276
3000	207
2500	172
1000	69
900	62
600	41
500	34
400	28
250	17
150	10.3
100	6.9
90	6.2
60	4.1
40	2.8
25	1.7
10	0.7

Examples

Temperature conversion

Initial value: 100

°C in °F: 212 °F

°F in °C: 37.78 °C

Pressure conversion

Initial value: 35

bar in psi: 507.675 psi

psi in bar: 2.41296 bar

Appendix

Index

SCxSD	52-53	SCP07	27-28
SC-910	41	SCP08	29-30
SC-911	41	SCPSD-...	60-65
SC-912	41	SCPSDI-...	54-59
SCA-1/4EDX1/2-ED	102	SCPSi	31-33
SCA-1/4EDX1/4-D	102	SCQ-150-10-07	41
SCA-1/4-M22x1.5-ED	102	SCSD-PRG-KIT	105
SCAF-1/4-40	103	SCSD-S27	59
SCAF-3/4-90	103	SCT-150-...	34-35
SCAQ-150	41	SCTSD-150-...	71
SCAQ-GI-R1/2	41	SCTSD-L-...	78-81
SCA-TT-10-1/2	72	SCTT-10-xxx-07	70
SCA-TT-10-xxx	72	SCTT-20-10-07	70
SCFT-...	42-45	SCVF-...	46-51
SCK-006	101		
SCK-145	101		
SCK-155	101		
SCK-400-...	100		
SCK-410-03-45-45	73		
SCLSD-...	82-87		
SCLTSD-...	88-93		
SCOTC-...	94-99		
SCP01-...	12-15		
SCP02-...	16-21		
SCP03-...	22-26		

Old and new references

Old order number	New order number	Old order number	New order number
SCK-007	SCK-145	SCP-xxx-x4-0x-MO	SCP02-xxx-x4-0x
SCK-045	SCK-145	SCP-xxx-x4-0x	SCP01-xxx-x4-0x
SCK-047	SCK-145	SCP-xxx-10-06	SCP01-xxx-14-06 + SCA-1/4-M22x1.5-ED
SCK-055	SCK-155	SCP-xxx-10-07	SCP01-xxx-14-07 + SCA-1/4-M22x1.5-ED
SCK-057	SCK-155	SCP-xxx-12-06	SCP01-xxx-14-06 + SCA-1/4-ED-1/2-ED
SCK-147	SCK-145	SCP-xxx-12-07	SCP01-xxx-14-07 + SCA-1/4-ED-1/2-ED
SCK-157	SCK-155	SCP-xxx-20-06	SCP01-xxx-24-06 + SCA-1/4-M22x1.5-ED
SCK-200-xxx-45	SCK-400-xxx-45	SCP-xxx-20-07	SCP01-xxx-24-07 + SCA-1/4-M22x1.5-ED
SCK-200-xxx-47	SCK-400-xxx-45	SCP-xxx-22-06	SCP01-xxx-24-06 + SCA-1/4-ED-1/2-ED
SCK-200-xxx-55	SCK-400-..55	SCP-xxx-22-07	SCP01-xxx-24-07 + SCA-1/4-ED-1/2-ED
SCK-200-xxx-56	SCK400-xxx-56	SCP-xxx-30-06	SCP01-xxx-34-06 + SCA-1/4-M22x1.5-ED
SCK-200-xxx-57	SCK-400-..55	SCP-xxx-30-07	SCP01-xxx-24-07 + SCA-1/4-M22x1.5-ED
SCK-400-xxx-06	SCK-400-xxx-56	SCP-xxx-32-06	SCP01-xxx-34-06 + SCA-1/4-ED-1/2-ED
SCK-400-xxx-07	SCK-400-xxx-45	SCP-xxx-32-07	SCP01-xxx-24-07 + SCA-1/4-ED-1/2-ED
SCK-400-xxx-47	SCK-400-xxx-45	SCP-xxx-40-06	SCP01-xxx-44-06 + SCA-1/4-M22x1.5-ED
SCK-400-xxx-57	SCK-400-..55	SCP-xxx-40-07	SCP01-xxx-44-07 + SCA-1/4-M22x1.5-ED
SCPSD-xxx-04-05	SCPSD-xxx-04-17	SCP-xxx-42-06	SCP01-xxx-44-06 + SCA-1/4-ED-1/2-ED
SCPSD-xxx-04-06	SCPSD-xxx-04-16	SCP-xxx-42-07	SCP01-xxx-44-07 + SCA-1/4-ED-1/2-ED
SCPSD-xxx-04-07	SCPSD-xxx-04-17	SCT-150-14-00	SCT-150-14-07+SCK-400-05-45
SCPSD-xxx-14-05	SCPSD-xxx-14-15		

Please ask about compatible products for non-listed items.



