



aerospace
 climate control
 electromechanical
 filtration
 fluid & gas handling
 hydraulics
pneumatics
 process control
 sealing & shielding



ISOMAX DX ISO Valve Series

Catalogue PDE2568TCUK June 2016



ENGINEERING YOUR SUCCESS.

PDE2568TCUK

ISOMAX DX ISO Valve Series



Important !

Before carrying out any service work, ensure that the valve and manifold have been vented. Remove the primary supply air hose to ensure total disconnection of the air supply before dismantling valves or blank connection blocks.



NB !

All technical data in this catalogue is typical only. The air quality is decisive for the valve life: see ISO 8573.



WARNING

FAILURE OR IMPROPER SELECTION OR IMPROPER USE OF THE PRODUCTS AND/OR SYSTEMS DESCRIBED HEREIN OR RELATED ITEMS CAN CAUSE DEATH, PERSONAL INJURY AND PROPERTY DAMAGE.

This document and other information from Parker Hannifin Corporation, its subsidiaries and authorized distributors provide product and/or system options for further investigation by users having technical expertise. It is important that you analyze all aspects of your application and review the information concerning the product or system in the current product catalog. Due to the variety of operating conditions and applications for these products or systems, the user, through its own analysis and testing, is solely responsible for making the final selection of the products and systems and assuring that all performance, safety and warning requirements of the application are met. The products described herein, including without limitation, product features, specifications, designs, availability and pricing, are subject to change by Parker Hannifin Corporation and its subsidiaries at any time without notice.

SALE CONDITIONS

The items described in this document are available for sale by Parker Hannifin Corporation, its subsidiaries or its authorized distributors. Any sale contract entered into by Parker will be governed by the provisions stated in Parker's standard terms and conditions of sale (copy available upon request).



Contents	Page
ISO Specifications	4 - 5
Overview	6 - 7
Flow Characteristics	8
Material Specification	9
Technical Characteristics	9
ISO 15407-1 - Sizes 02 & 01 Order Chart	10
ISO 15407-1 - Order Codes	11
ISO 5599-1 - Sizes 1, 2 & 3 Order Chart	12
ISO 5599-1 - Order Codes	13 - 15
Solenoid Operators	16 - 19
Subbase, Manifolds	20 - 23
Sandwich Modules	24 - 25
Dimensions	26 - 33

PDE2568TCUK

ISOMAX DX ISO Valve Series

ISO Specifications

Individual connection

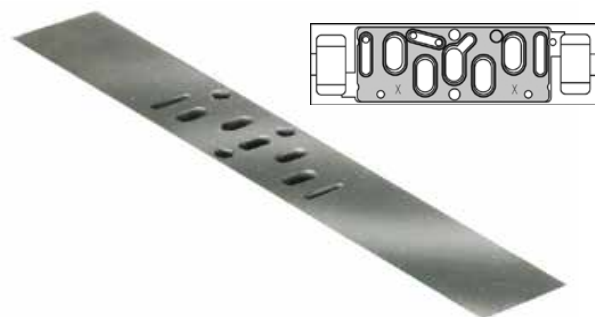

15407-1

(VDMA 24563)



ISO 15407-1

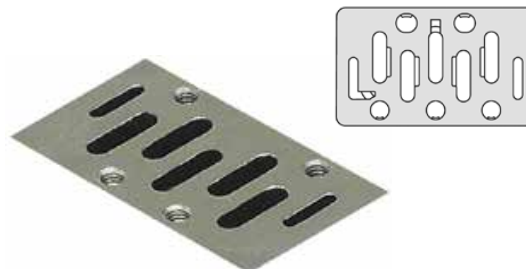

5599-1



ISO 5599-1

External electrical connection subbase valves

The ISO Standard 15407-1 specifies an interface pattern for a common subbase valve consisting of pressure passages 1, 3, 5, 2 & 4 and pilot passages 12 & 14. The width of the pattern and location of the 4 bolt holes are also specified. There are no specifications for the type of external electrical connection used to control the valve.

Size : 02 01

External electrical connection subbase valves

The ISO Standard 5599-1 specifies an interface pattern for a common subbase valve consisting of pressure passages 1, 3, 5, 2 & 4 and pilot passages 12 & 14. The width of the pattern and location of the 4 bolt holes are also specified. There are no specifications for the type of external electrical connection used to control the valve.

Size : 1 2 3

Plug-in connection



15407-2



ISO 15407-2

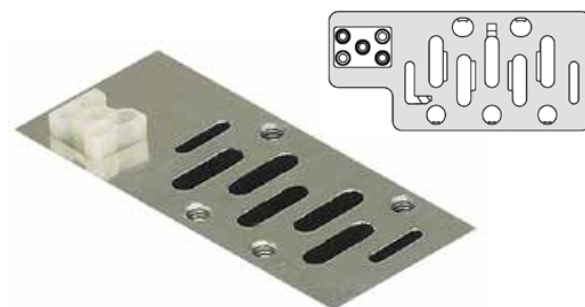

5599-2



ISO 5599-2

Body-to-base plug-in subbase valves

Same as 15407-1 for pneumatic pressure passages, 15407-2 standard also specifies a plug-in electrical connection.

Size : 01 02

Pin 1 = 14 solenoid
Pin 2 = 12 solenoid
Pin 3 = Ground +
Pin 4 = Common -

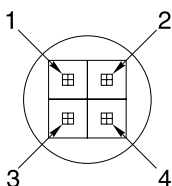

Body-to-base plug-in subbase valves

Same as 5599-1 for pneumatic pressure passages, 5599-2 standard also specifies a plug-in electrical connection.

Sizes : 1 2 3

1 = 12 solenoid
2 = 14 solenoid
3 = 12 solenoid
4 = 14 solenoid
5 = Ground

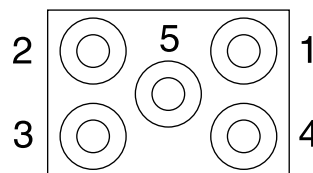

CNOMO and VDMA Standards

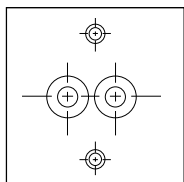

CNOMO 06-05-01

The solenoid pilot interface often used with ISO 5599-1 valves is the CNOMO interface. The CNOMO interface specifies the pressure and actuator port, and the screw holes for the mounting of this solenoid pilot. It is commonly used in European automotive plants, and its usage is becoming more prevalent for industrial ISO 5599-1 valves.

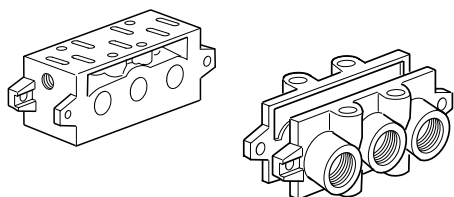

VDMA 24345

The VDMA 24345 is a standard for Manifolds and Subbase specifying a common base mounting footprint in addition to ISO 5599-1 Interface standard. (VDMA is a German organisation - Verband Deutscher Maschinen und Anlagen-Bauer - which is translated to Federation of German Machine and Unit Builders.)

Choice of components for air supply to cylinders

In the chart below can you find the suitable valves, tubes etc. for each cylinder size. If you have a tube length over 2 m, choose one tube size larger than in the chart.

Following data is valid:
 Supply pressure: min 7,0 bar
 Regulator pressure setting: 6,0 bar
 Pipe length between air treatment unit and valve: max 1 m
 Pipe length between valve and cylinder : max 2 m

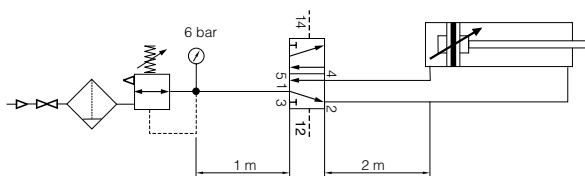

Cylinder bore	<Ø20	Ø20-32	Ø40-50	Ø63	Ø80	Ø100	Ø125	Ø160	Ø200
Cylinder port	M5	G1/8	G1/4	G3/8	G3/8	G1/2	G1/2	G3/4	G3/4
Tubing Ext / Int	4 / 2.7	6 / 4	8 / 6	10 / 7	10 / 7 12 / 9	12 / 9 14 / 11	14 / 11	18 / 15	20 / 18
Size 02	G1/8	G1/8	G1/8	G1/8					
Size 01	G1/4	G1/4	G1/4	G1/4	G1/4				
Size 1	G1/4	G1/4	G1/4	G1/4	G1/4	G1/4			
Size 2			G3/8	G3/8	G3/8	G3/8	G3/8		
Size 3				G1/2	G1/2	G1/2	G1/2	G1/2	G1/2

Cylinder speed < 0.5 m/s
 Cylinder speed < 1 m/s
 Cylinder speed > 1 m/s

ISOMAX - General Applications

Market Application

- Automotive Handling
- Packaging
- Manufacturing
- General application



Ceramic technology

All ISOMAX products use high-tech ceramic switching technology :

- **Excellent reliability :**

Long life in excess of 100 million operations*.
Operates with lubricated or non lubricated air.
Low sensitivity to air quality changes ;
switching without seal.
Stiction free.

- **High performances :**

Slide valve concept allows high flow / size ratio and short response time due to short slide stroke and low friction.

- **Size 02 & Size 01**

Solenoid exhaust pilot

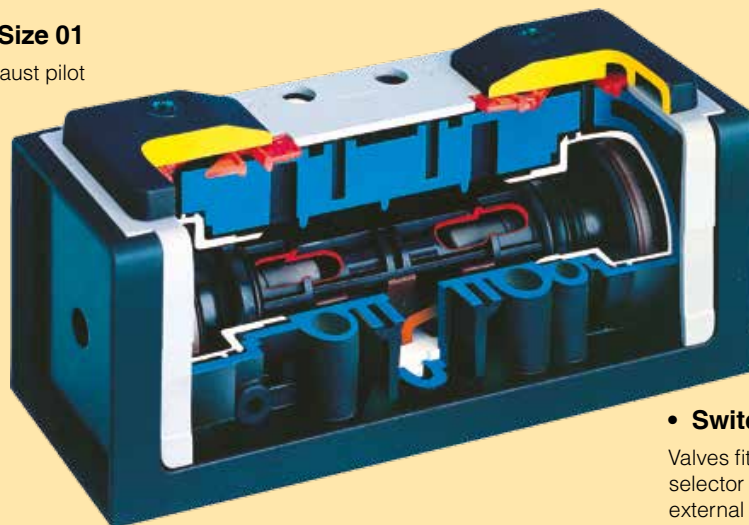

- **Switchable selector**

Valves fitted with switchable selector to give internal or external pilot supply

- **Stable long lasting performances**

Low friction switching : minimum wear of the valve member/seal assembly.

Ceramic plate

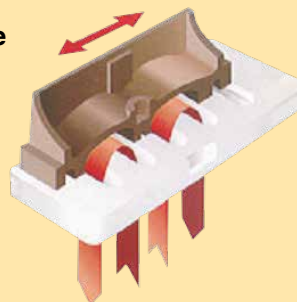

PDE2568TCUK

ISOMAX DX ISO Valve Series

Rust and corrosion resistant body

With the valve body in polyamide reinforced fiberglass and the casting in anodised aluminium, the Isomax range presents a comprehensive modern design to suit most industrial environments.

Central M12 connection or M12 coil

All sizes of ISO 5599-1 are supplied with central M12 integrated connector, a M12 bridge cable or with a 30 x 30mm coil having M12 interface.

External supply selection

In order to use actuator with low pressure, it is possible to connect an external pressure on port 14 to supply both solenoids. Selection is easily made by reversing the gasket under the operator.

High reliability

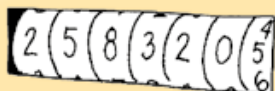

Valves easily comply with the requirements for the component reliability in accordance with EU Machinery Directive standards EN292-2 and EN983.

Maintenance

Spares are not required for the main valve or spool but solenoid operators can be replaced if required.

Manual Override

Solenoids are available with locking or non-locking manual overrides so that valves can be operated when the electrical supply is turned off.

Solenoid valves, CNOMO interface, 15mm solenoid



The standard valve is fitted with a 30mm solenoid having DIN 43650 Industrial form A connector for sizes 1, 2 and 3 15mm solenoid for sizes 01 and 02.

Low noise level

Size 01 and 02 valves fitted with the 15mm solenoid option use captured pilot exhaust which is channelled through the valve body and exhausts to atmosphere through channel 12

High electrical encapsulation class



The solenoid valves are protected to IP65 with the standard cable plug. Available with DIN A or M12 connection.

Wide choice of solenoid connectors/cable plugs

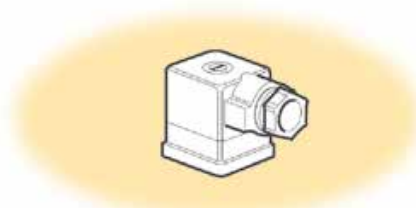

Solenoid connectors are available with or without LED and rectifier and may be selected fitted pre-wired with flying leads.

Valves having ATEX approval

ATEX approved options are available for use in explosive atmospheres. Consult our Technical Sales Department for further information.

Bottom or side ported manifold

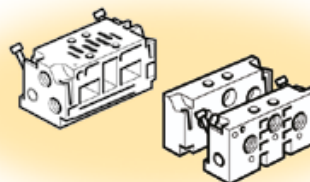

Manifolds with common ducts for ports 1,3 and 5, outlet port 2 and 4, and supply port for 12 and 14 are available side or bottom ported. Those manifolds are common for Isomax and Isys ISO.

Subbase installation VDMA

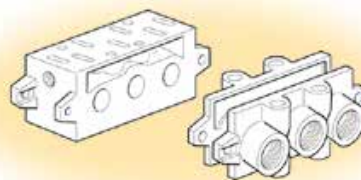

A large range of subbase, VDMA or not VDMA, bottom or side ported.



ISOMAX Flow Characteristics

Flow capacities in accordance with ISO6358, for 5/2 function. 5/3 function are around 10 to 20% less.

Technical Data ISOMAX Size 02

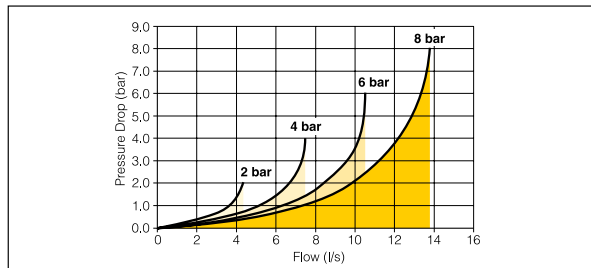

Operating pressure.	
5/2 Spring return	4,0 - 10 bar
5/2 Differential	3,0 - 10 bar
5/2 Double solenoid or pneumatic	2,0 - 10 bar
5/3 Double solenoid or pneumatic	4,0 - 10 bar
Working temperature.	
-10°C to + 60°C	
Flow (acc. to ISO 6358)	
c = 1,5 NI/s x bar	
b = 0,25	
Qn = 6,3 l/s	
Qmax = 10,6 l/s	

Technical Data ISOMAX Size 01

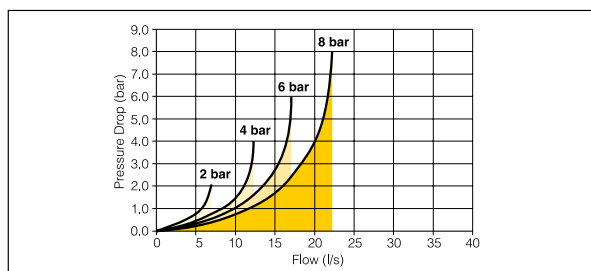

Operating pressure.	
5/2 Spring return	4,0 - 10 bar
5/2 Differential	3,0 - 10 bar
5/2 Double solenoid or pneumatic	2,0 - 10 bar
5/3 Double solenoid or pneumatic	4,0 - 10 bar
Working temperature.	
-10°C to + 60°C	
Flow (acc. to ISO 6358)	
c = 2,5 NI/s x bar	
b = 0,25	
Qn = 9,8 l/s	
Qmax = 17,1 l/s	

Technical Data ISOMAX Size 1

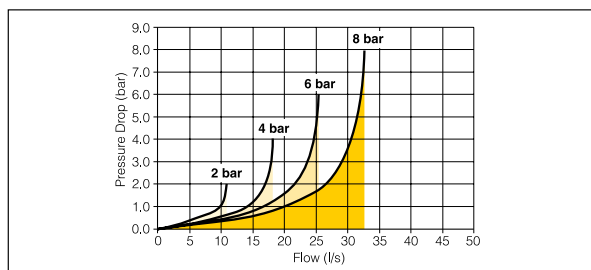

Operating pressure.	
5/2 Spring return	3,0 - 10 bar
5/2 Differential	2,0 - 10 bar
5/2 Double solenoid	1,0 - 10 bar
5/3 Double solenoid	3,5 - 10 bar
Pneumatic version	
12 bar	
Working temperature.	
-10°C to + 60°C	
Flow (acc. to ISO 6358)	
c = 3,8 NI/s x bar	
b = 0,35	
Qn = 17,2 l/s	
Qmax = 25,5 l/s	

Technical Data ISOMAX Size 2

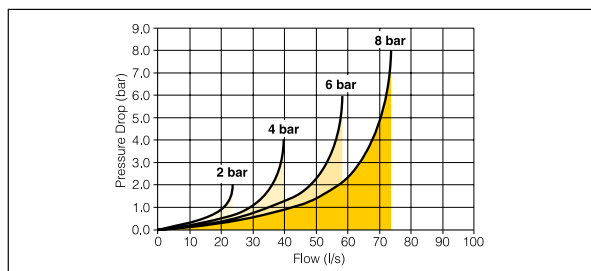

Operating pressure.	
5/2 Spring return	2,5 - 10 bar
5/2 Differential	2,0 - 10 bar
5/2 Double solenoid	1,0 - 10 bar
5/3 Double solenoid	3,0 - 10 bar
Pneumatic version	
12 bar	
Working temperature.	
-10°C to + 60°C	
Flow (acc. to ISO 6358)	
c = 8,2 NI/s x bar	
b = 0,35	
Qn = 38,3 l/s	
Qmax = 58,7 l/s	

Technical Data ISOMAX Size 3

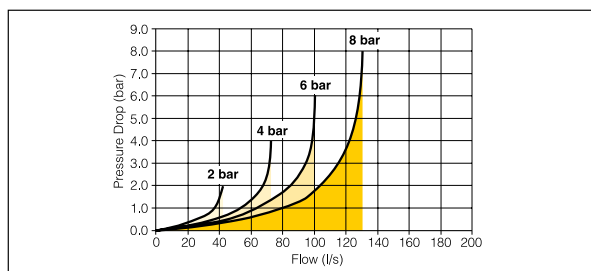

Operating pressure.	
5/2 Spring return	2,5 - 10 bar
5/2 Differential	2,0 - 10 bar
5/2 Double solenoid	1,0 - 10 bar
5/3 Double solenoid	3,0 - 10 bar
Pneumatic version	
12 bar	
Working temperature.	
-10°C to + 60°C	
Flow (acc. to ISO 6358)	
c = 14,5 NI/s x bar	
b = 0,35	
Qn = 64,0 l/s	
Qmax = 101,0 l/s	





ISOMAX Material Specification and Characteristics



Material Specification

Valve member - seat :	Self lubricating acetal - ceramic
Body :	Polyamide reinforced fibreglass
Casing - End plates :	Anodised aluminium - Painted zinc - Plated steel
Valve plate :	Zamak
Seals :	Nitrile
Springs :	Stainless steel
Screws :	Zinc plated steel
Top cover - Seal :	Polyamide reinforced fiberglass - Polyester

Technical Characteristics

Fluid :	Air or inert gas filtered 40u class 5 according to ISO 8573-1 Dry class 4 according to ISO 8573-1 non-lubricated, or lubricated
Storage temperature :	-20° to + 70°
Vibration :	2g - from 2 to 150 Hz according to IEC 68-2-6
Shock :	15g - 11ms according to IEC 68-2-7

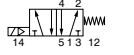
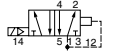
Changeover time (ms) at 6 bar - Actua. / Return

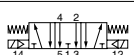
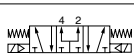
Valve Function	Solenoid Operated Valves					Pneumatic Operated Valves				
	02	01	1	2	3	02	01	1	2	3
	15/25	25/35	40/55	60/105	85/160	15/25	25/35	30/45	50/95	80/160
	15/30	20/40	30/70	55/110	80/180	15/30	20/40	25/60	45/100	70/170
	12/12	15/15	25/25	30/30	40/40	12/12	14/14	20/20	25/25	35/35
	20/60	20/60	30/95	40/190	55/330	20/50	20/50	20/80	30/170	45/330
	20/60	20/60	25/70	40/140	60/270	20/50	20/50	20/65	30/140	50/270
			25/65	40/150				20/60	25/140	

ISOMAX - ISO 15407-1 - Sizes 02 & 01
Pneumatic remote pilot or 15 mm DIN C solenoid valve operated

Order chart



**For Electro-Pneumatic pilot valve only
Solenoid valve operator definition**

DX 01 - 6 21 - 95 1 M S

Size	
02	Size 02 : 18 mm
01	Size 01 : 26 mm

Pilot	
4	Pneumatic
6	Electro-Pneumatic

Valve function	
06	5/2 double solenoid
56	5/2 double solenoid, 14 prioritised
21	5/2 single solenoid, spring return
51	5/2 single solenoid, differential return
11	5/3 double solenoid vented centre
16	5/3 double solenoid closed centre

Internal pilot supply / Capture exhaust 12	
06	5/2 double solenoid
56	5/2 double solenoid, 14 prioritised
21	5/2 single solenoid, spring return
51	5/2 single solenoid, differential return
11	5/3 double solenoid vented centre
16	5/3 double solenoid closed centre

External pilot 14 supply / Capture exhaust 12	
05	5/2 double solenoid
59	5/2 double solenoid, 14 prioritised
23	5/2 single solenoid, spring return
54	5/2 single solenoid, differential return
09	5/3 double solenoid vented centre
19	5/3 double solenoid closed centre

Connector	
Blank	Without any
C	Standard connector No cable
S	Connector with LED and protection - No cable
S3	Connector with LED and protection - 3 m cable
S5	Connector with LED and protection - 5 m cable

Voltage	
L	12 Vdc
M	24 Vdc
N	48 Vdc
C	24 Vac - 50 Hz
D	48 Vac - 50/60 Hz
J	110 Vac - 50/60 Hz
A	230 VAC - 50/60 Hz

Manual override	
0	Without any
1	Flush non locking
2	Flush non locking (extended 15 mm)
3	Flush locking
5	Flush locking (extended 15 mm)

Operator	
60	Remote pneumatic pilot operated

For pneumatic pilot valve	
60	Remote pneumatic pilot operated

For electro-pneumatic pilot valve	
60	Without 15 mm solenoid valve operator*
95	15 mm solenoid valve operator - DIN 43650 Form C

* 15 mm solenoid valve operator to be ordered separately

Shaded part numbers constituted with shaded voltage code are available from stock.
 Shaded part numbers constituted by unshaded voltage code are available on request but are subject to a minimum order quantity. Otherwise, select « Blank » as voltage code and order coil separately.

PDE2568TCUK

ISOMAX DX ISO Valve Series
ISOMAX - ISO 15407-1 - Sizes 02 & 01
Pneumatic remote pilot operated

Without valve spool manual override

	Symbol	Description	Size	Weight (g)	Order code
		5/2 Air pilot - Spring return	02 - 18 mm	90	DX02-421-60
			01 - 26mm	130	DX01-421-60
		5/2 Air pilot - Differential	02 - 18 mm	90	DX02-451-60
			01 - 26mm	130	DX01-451-60
		5/2 Double air pilot	02 - 18 mm	90	DX02-406-60
			01 - 26mm	130	DX01-406-60
		5/3 Closed Centre	02 - 18 mm	90	DX02-416-60
			01 - 26mm	130	DX01-416-60
		5/3 Vented Center	02 - 18 mm	90	DX02-411-60
			01 - 26mm	130	DX01-411-60

ISOMAX - ISO 15407-1 - Sizes 02 & 01
15 mm DIN C / 24 Vdc / 1,2 W solenoid valve operator

	Symbol	Description	Size	Weight (g)	Order code
		5/2 Single solenoid - Spring return	02 - 18 mm	130	DX02-621-951M
			01 - 26mm	170	DX01-621-951M
		5/2 Single solenoid - Differential	02 - 18 mm	130	DX02-651-951M
			01 - 26mm	170	DX01-651-951M
		5/2 Double solenoid	02 - 18 mm	130	DX02-606-951M
			01 - 26mm	170	DX01-606-951M
		5/3 Closed Centre	02 - 18 mm	130	DX02-616-951M
			01 - 26mm	170	DX01-616-951M
		5/3 Vented Center	02 - 18 mm	160	DX02-611-951M
			01 - 26mm	170	DX01-611-951M

Solenoid connectors & cable plugs to be ordered separately. See solenoid section

ISOMAX - ISO 15407-1 - Sizes 02 & 01
Without 15 mm DIN C solenoid valve operator

	Symbol	Description	Size	Weight (g)	Order code
		5/2 Single solenoid - Spring return	02 - 18 mm	130	DX02-621-60
			01 - 26mm	170	DX01-621-60
		5/2 Single solenoid - Differential	02 - 18 mm	130	DX02-651-60
			01 - 26mm	170	DX01-651-60
		5/2 Double solenoid	02 - 18 mm	130	DX02-606-60
			01 - 26mm	170	DX01-606-60
		5/3 Closed Centre	02 - 18 mm	130	DX02-616-60
			01 - 26mm	170	DX01-616-60
		5/3 Vented Center	02 - 18 mm	160	DX02-611-60
			01 - 26mm	170	DX01-611-60

15mm solenoid valve operator, solenoid connectors & cable plug to be ordered separately. See solenoid section

ISOMAX - ISO 5599-1 - Sizes 1, 2 & 3

Pneumatic remote pilot or CNOMO operator - DIN or M12 connection

Order chart

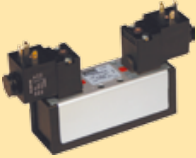

**For Electro-Pneumatic pilot valve only
Solenoid valve operator definition**

DX 1 - 6 51 - B L 49

Size	
1	Size 1
2	Size 2
3	Size 3

Pilot	
4	Pneumatic
6	Electro-Pneumatic

Valve function	
06	5/2 double solenoid
56	5/2 double solenoid, 14 prioritised
21	5/2 single solenoid, spring return
51	5/2 single solenoid, differential return
11	5/3 double solenoid vented centre
13	5/3 double solenoid pressurised center *
16	5/3 double solenoid closed centre

Internal pilot supply	
06	5/2 double solenoid
56	5/2 double solenoid, 14 prioritised
21	5/2 single solenoid, spring return
51	5/2 single solenoid, differential return
11	5/3 double solenoid vented centre
13	5/3 double solenoid pressurised center *
16	5/3 double solenoid closed centre

External pilot 14 supply / Capture exhaust 12	
05	5/2 double solenoid
59	5/2 double solenoid, 14 prioritised
23	5/2 single solenoid, spring return
54	5/2 single solenoid, differential return
09	5/3 double solenoid vented centre
14	5/3 double solenoid pressurised center *
19	5/3 double solenoid closed centre

Voltage	
Blank	Operator only (without coil)

M12 connection	
19	24 Vdc

DIN connector	
45	12 Vdc
49	24 Vdc
40	12 Vac - 50/60 Hz
42	24 Vac - 50/60 Hz
53	110 Vac - 50Hz / 120 Vac - 60Hz
57	230 Vac - 50/60 Hz

Solenoid enclosure	
L	Operator with coil
N	Operator only without coil

CNOMO 30 x 30 Operator for Low Power Coil	
L	Operator with coil
N	Operator only without coil

M12 connector	
2	One connector per distributor
6	One built-in connector per coil

Manual override	
60	Without direct spool override
70	With direct spool override

On Pneumatic Valves or Electric Valves without operator	
60	Without direct spool override
70	With direct spool override





On electric operator *	
A	Without any
B	Non locking - Flush - Metal
C	Locking - Flush - Plastic

*) Without direct valve spool manual override





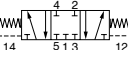
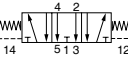
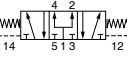

Shaded part numbers constituted with shaded voltage code are available from stock.
 Shaded part numbers constituted by unshaded voltage code are available on request but are subject to a minimum order quantity. Otherwise, select « Blank » as voltage code and order coil separately.

PDE2568TCUK

ISOMAX DX ISO Valve Series
**ISOMAX - ISO 5599-1 - Sizes 1, 2 & 3
Pneumatic remote pilot operated**
With direct valve spool manual override



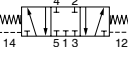

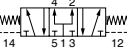
Symbol	Description	Size	Weight (g)	Order code
 	5/2 Air pilot - Spring return	1 - 43 mm	350	DX1-421-70
		2 - 56 mm	600	DX2-421-70
		3 - 71 mm	1100	DX3-421-70
	5/2 Air pilot - Differential	1 - 43 mm	350	DX1-451-70
		2 - 56 mm	600	DX2-451-70
		3 - 71 mm	1100	DX3-451-70
	5/2 Double air pilot	1 - 43 mm	350	DX1-406-70
		2 - 56 mm	600	DX2-406-70
		3 - 71 mm	1100	DX3-406-70
	5/3 Closed Center	1 - 43 mm	350	DX1-416-70
		2 - 56 mm	600	DX2-416-70
		3 - 71 mm	1100	DX3-416-70
	5/3 Vented Center	1 - 43 mm	350	DX1-411-70
		2 - 56 mm	600	DX2-411-70
		3 - 71 mm	1100	DX3-411-70
	5/3 Pressurised Center	1 - 43 mm	350	DX1-413-70
		2 - 56 mm	600	DX2-413-70

**ISOMAX - ISO 5599-1 - Sizes 1, 2 & 3
Pneumatic remote pilot operated**
Without direct valve spool manual override

Symbol	Description	Size	Weight (g)	Order code
 	5/2 Air pilot - Spring return	1 - 43 mm	350	DX1-421-60
		2 - 56 mm	600	DX2-421-60
		3 - 71 mm	1100	DX3-421-60
	5/2 Air pilot - Differential	1 - 43 mm	350	DX1-451-60
		2 - 56 mm	600	DX2-451-60
		3 - 71 mm	1100	DX3-451-60
	5/2 Double air pilot	1 - 43 mm	350	DX1-406-60
		2 - 56 mm	600	DX2-406-60
		3 - 71 mm	1100	DX3-406-60
	5/3 Closed Center	1 - 43 mm	350	DX1-416-60
		2 - 56 mm	600	DX2-416-60
		3 - 71 mm	1100	DX3-416-60
	5/3 Vented Center	1 - 43 mm	350	DX1-411-60
		2 - 56 mm	600	DX2-411-60
		3 - 71 mm	1100	DX3-411-60
	5/3 Pressurised Center	1 - 43 mm	350	DX1-413-60
		2 - 56 mm	600	DX2-413-60

ISOMAX - ISO 5599-1 - Sizes 1, 2 & 3 CNOMO operator with 30 x 30 DIN Form A / 24 Vdc / 2,7 W solenoid

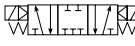

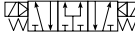
With non locking manual override on solenoid valve operator - Without direct valve spool manual override

Symbol	Description	Size	Weight (g)	Order code
	5/2 Single solenoid - Spring return	1 - 43 mm	500	DX1-621-BL49
		2 - 56 mm	750	DX2-621-BL49
		3 - 71 mm	1250	DX3-621-BL49
	5/2 Single solenoid - Differential	1 - 43 mm	500	DX1-651-BL49
		2 - 56 mm	750	DX2-651-BL49
		3 - 71 mm	1250	DX3-651-BL49
	5/2 Double solenoid	1 - 43 mm	650	DX1-606-BL49
		2 - 56 mm	900	DX2-606-BL49
		3 - 71 mm	1400	DX3-606-BL49
	5/3 Closed Center	1 - 43 mm	560	DX1-616-BL49
		2 - 56 mm	900	DX2-616-BL49
		3 - 71 mm	1400	DX3-616-BL49
	5/3 Vented Center	1 - 43 mm	650	DX1-611-BL49
		2 - 56 mm	900	DX2-611-BL49
		3 - 71 mm	1400	DX3-611-BL49
	5/3 Pressurised Center	1 - 43 mm	650	DX1-613-BL49
		2 - 56 mm	900	DX2-613-BL49

Solenoid connectors & cable plug to be ordered separately. See solenoid section

ISOMAX - ISO 5599-1 - Sizes 1, 2 & 3 CNOMO operator without coil

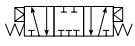
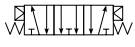
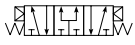

With non locking manual override on solenoid valve operator - Without direct valve spool manual override

Symbol	Description	Size	Weight (g)	Order code
	5/2 Single solenoid - Spring return	1 - 43 mm	400	DX1-621-BN
		2 - 56 mm	650	DX2-621-BN
		3 - 71 mm	1150	DX3-621-BN
	5/2 Single solenoid - Differential	1 - 43 mm	400	DX1-651-BN
		2 - 56 mm	650	DX2-651-BN
		3 - 71 mm	1150	DX3-651-BN
	5/2 Double solenoid	1 - 43 mm	550	DX1-606-BN
		2 - 56 mm	800	DX2-606-BN
		3 - 71 mm	1300	DX3-606-BN
	5/3 Closed Center	1 - 43 mm	550	DX1-616-BN
		2 - 56 mm	800	DX2-616-BN
		3 - 71 mm	1300	DX3-616-BN
	5/3 Vented Center	1 - 43 mm	550	DX1-611-BN
		2 - 56 mm	800	DX2-611-BN
		3 - 71 mm	1300	DX3-611-BN
	5/3 Pressurised Center	1 - 43 mm	550	DX1-613-BN
		2 - 56 mm	800	DX2-613-BN

30 x 30 DIN Form A or 22 x 30 DIN Form B coil & coil connectors to be ordered separately. See solenoid section

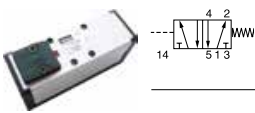

ISOMAX - ISO 5599-1 - Sizes 1, 2 & 3 Valve alone without operator

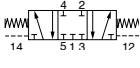
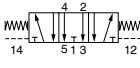
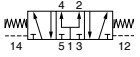
With direct valve spool manual override

Symbol	Description	Size	Weight (g)	Order code
	5/2 Single pilot - Spring return	1 - 43 mm	350	DX1-621-70
		2 - 56 mm	600	DX2-621-70
		3 - 71 mm	1100	DX3-621-70
	5/2 Single pilot - Differential	1 - 43 mm	350	DX1-651-70
		2 - 56 mm	600	DX2-651-70
		3 - 71 mm	1100	DX3-651-70
	5/2 Double pilot	1 - 43 mm	350	DX1-606-70
		2 - 56 mm	600	DX2-606-70
		3 - 71 mm	1100	DX3-606-70
	5/3 Closed Center	1 - 43 mm	350	DX1-616-70
		2 - 56 mm	600	DX2-616-70
		3 - 71 mm	1100	DX3-616-70
	5/3 Vented Center	1 - 43 mm	350	DX1-611-70
		2 - 56 mm	600	DX2-611-70
		3 - 71 mm	1100	DX3-611-70
	5/3 Pressurised Center	1 - 43 mm	350	DX1-613-70
		2 - 56 mm	600	DX2-613-70

ISOMAX - ISO 5599-1 - Sizes 1, 2 & 3 Valve alone without operator

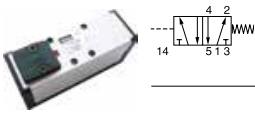
Without direct valve spool manual override

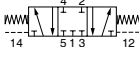
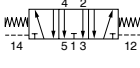
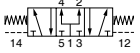
Symbol	Description	Size	Weight (g)	Order code
	5/2 Single pilot - Spring return	1 - 43 mm	350	DX1-621-60
		2 - 56 mm	600	DX2-621-60
		3 - 71 mm	1100	DX3-621-60
	5/2 Single pilot - Differential	1 - 43 mm	350	DX1-651-60
		2 - 56 mm	600	DX2-651-60
		3 - 71 mm	1100	DX3-651-60
	5/2 Double pilot	1 - 43 mm	350	DX1-606-60
		2 - 56 mm	600	DX2-606-60
		3 - 71 mm	1100	DX3-606-60
	5/3 Closed Center	1 - 43 mm	350	DX1-616-60
		2 - 56 mm	600	DX2-616-60
		3 - 71 mm	1100	DX3-616-60
	5/3 Vented Center	1 - 43 mm	350	DX1-611-60
		2 - 56 mm	600	DX2-611-60
		3 - 71 mm	1100	DX3-611-60
	5/3 Pressurised Center	1 - 43 mm	350	DX1-613-60
		2 - 56 mm	600	DX2-613-60

15 mm N.C. Solenoid Operator - DIN Form C for ISOMAX 15407-1 Sizes 02 & 01

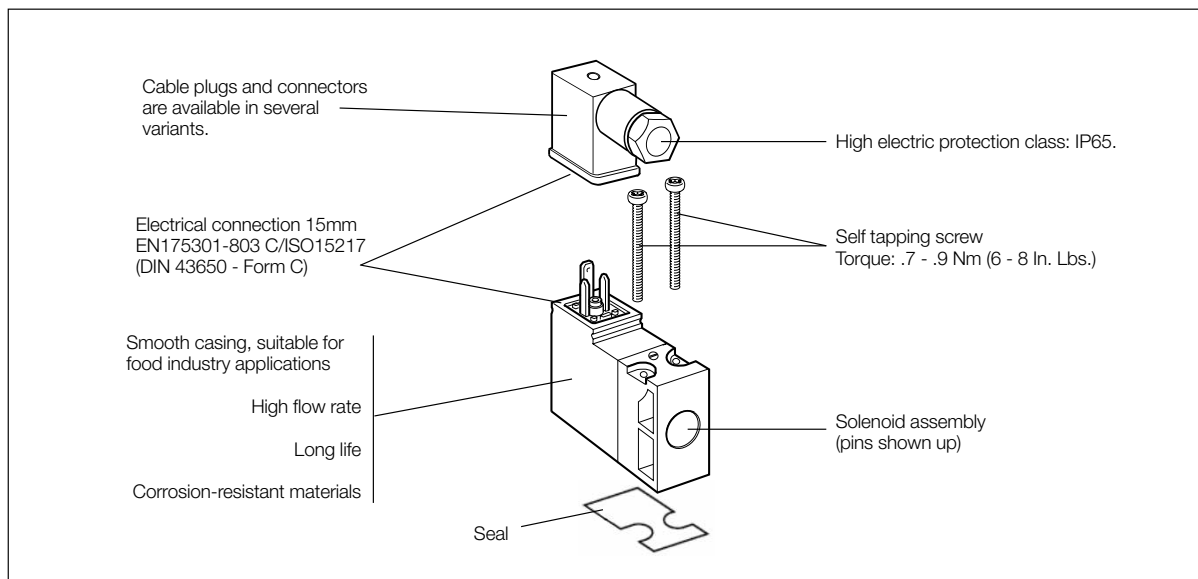

Technical data

	NC, Standard	NC, Food¹⁾	NC, Mobile²⁾
Working pressure	0 to 10 bar	0 to 10 bar	0 to 10 bar
Working temperature	-15 °C to +60 °C	-15 °C to +60 °C	-40 °C to +70 °C
Orifice	1,0 mm	1,0 mm	1,0 mm
Flow Qmax	33 NI/min	33 NI/min	22 NI/min
Power, hold	DC 1,2 W / AC 1,6 VA *	DC 1,2 W / AC 1,6 VA *	DC 1,4 W
Power, surge	DC 1,2 W / AC 3,5 VA *	DC 1,2 W / AC 3,5 VA *	DC 1,4 W
Connection time	100%	100%	100%
Voltage tolerance	+10%/-15%	+10%/-15%	+25%/-30%
Electric connection:	Form C/ISO15217		
Port pattern:	To future CNOMO standard		
Protection:	IP 65		
Approval:	Some valves are UL 429 recognised and marked with the following symbol		
Working media:	All neutral media, such as compressed air, water, hydraulic oil and many gases.		
1) Design:	Completely smooth exterior, suitable for food industry.		
2) Mobile standard	According to European standard EN 50 155.		

* Power , hold for 230VAC 2.4VA
Power, surge for 230VAC 5.5VA

Transients

Interrupting the current through the solenoid coil produces momentary voltage peaks which, under unfavourable conditions, can amount to several hundred times the rated operating voltage. Normally, these transients do not cause problems, but to achieve the maximum life of relays in the circuit (and particularly of transistors, thyristors and integrated circuits) it is desirable to provide protection by means of voltage-dependent resistors (varistors). All cable plugs with a yellow LED also incorporate such protection.

Service life

With compressed air at 6 bar, 20 °C and complying with the requirements for compressed air quality as set out in ISO8573-1 norm (class 4 for dry and class 5 for filtered air), the valves should have a life of at least 50 million cycles.

Materials

Operator

Body, coil casing	Thermoplastic
Internal metal parts	Steel
Screws	Stainless steel
Bottom plug	Thermoplastic
Sealing materials	FPM (Viton™) and nitrile rubber

Cable head

Sheath	Thermoplastic
Retaining screw	Stainless steel, zinc-plated steel

PDE2568TCUK

ISOMAX DX ISO Valve Series



15mm DIN Form C (8mm spacing) pilot solenoid valve

For use with 15mm pilot solenoid valve PVL-B2 body

	Manual Overrides		Flush (Not Extended)		Extended			
	Without Manual Override	Order code	Blue Override, non locking	Yellow Override, Locking	Blue Override, non locking	Yellow Override, Locking		
Voltage	W (g)		Order code	Order code	Order code	Order code		
	12 Vdc	38	P2E-KV32B0	P2E-KV32B1	P2E-KV32B2	P2E-KV32B3	P2E-KV32B4	
	24 Vdc	38	P2E-KV32C0	P2E-KV32C1	P2E-KV32C2	P2E-KV32C3	P2E-KV32C4	
	48 Vdc	38	P2E-KV32D0	P2E-KV32D1	P2E-KV32D2	P2E-KV32D3	P2E-KV32D4	
	24 Vac 50Hz	38	P2E-KV31C0	P2E-KV31C1	P2E-KV31C2	P2E-KV31C3	P2E-KV31C4	
	48 Vac 50/60Hz	38	P2E-KV34D0	P2E-KV34D1	P2E-KV34D2	P2E-KV34D3	P2E-KV34D4	
	115 Vac 50Hz	38	P2E-KV31F0	P2E-KV31F1	P2E-KV31F2	P2E-KV31F3	P2E-KV31F4	
	120 Vac 60 Hz							
	230 Vac 50Hz							
	240 Vac 60 Hz	38		P2E-KV31J0	P2E-KV31J1	P2E-KV31J2	P2E-KV31J3	P2E-KV31J4

15 mm N.C. Solenoid Operator - Mobile version

	Without Manual Override		Not Extended Blue Override non locking flush	
	Order code	Order code	Order code	Order code
Voltage	W (g)			
	12 Vdc	38	P2E-MV35B0	P2E-MV35B1
	24 Vdc	38	P2E-MV35C0	P2E-MV35C1
	37,5 Vdc	38	P2E-MV35W0	P2E-MV35W1
	48 Vdc	38	P2E-MV35D0	P2E-MV35D1
	72 Vdc	38	P2E-MV35T0	P2E-MV35T1
	78 Vdc	38	P2E-MV35Y0	P2E-MV35Y1
	96 Vdc	38	P2E-MV35V0	P2E-MV35V1
	110 Vdc	38	P2E-MV35E0	P2E-MV35E1

Suppressor and LED indicators

For 8 mm solenoid pin spacing -

For mounting between the solenoid valve and the cable plug

Description	Electrical voltage	W (g)	Order code
	24 VAC/DC	3	P8V-CR26C
	115 VAC 50 Hz		
	120 VAC 60 Hz	3	P8V-CR24F
	230 VAC 50 Hz		
	240 VAC 60 Hz	3	P8V-CR24J

Mounting screws included with the solenoid valve operator

15 mm N.C. Solenoid Operator - Food Industry version

	Manual Overrides		Flush (Not Extended)		Extended			
	Without Manual Override	Order code	Blue Override, non locking	Yellow Override, Locking	Blue Override, non locking	Yellow Override, Locking		
Voltage	W (g)		Order code	Order code	Order code	Order code		
	24 Vdc	38	P2E-QV32C0	P2E-QV32C1	P2E-QV32C2	P2E-QV32C3	P2E-QV32C4	
	48 Vdc	38	P2E-QV32D0	P2E-QV32D1	P2E-QV32D2			
	24 Vac 50 Hz	38	P2E-QV31C0	P2E-QV31C1	P2E-QV31C2	P2E-QV31C3	P2E-QV31C4	
	48 Vac 50/60Hz	38	P2E-QV34D0	P2E-QV34D1	P2E-QV34D2			
	115 Vac 50Hz/	38	P2E-QV31F0	P2E-QV31F1	P2E-QV31F2	P2E-QV31F3	P2E-QV31F4	
	120 Vac 60Hz							
	230 Vac 50Hz	38		P2E-QV31J0	P2E-QV31J1	P2E-QV31J2	P2E-QV31J3	P2E-QV31J4
	240 Vac 60Hz/							

Mounting screws included with the solenoid valve operator

Solenoid Connectors 15 mm DIN Form C / ISO15217

Description	Characteristic	Visualisation	Cable length	W (g)	Order code	
	Standard IP65	No LED	No cable	20	P8C-C	
			24 Vdc LED	No cable	20	P8C-C26C
			110 Vac LED	No cable	20	P8C-C21E
	Standard IP65	No LED	No cable	15	P8C-D	
			2 meters	115	P8L-C2	
			5 meters	240	P8L-C5	
			24 Vdc/Vac LED	No cable	15	P8C-D26C
			2 meters	170	P8L-C226C	
			5 meters	240	P8L-C526C	
			10 meters	440	P8L-CA26C	
			110 Vac LED	No cable	115	P8C-D21E
			2 meters	115	P8L-C221E	
			5 meters	230	P8L-C521E	

In accordance with the EU Machine Directive, EN 983, solenoid valves with manual override should have spring-return operating arms for safety.



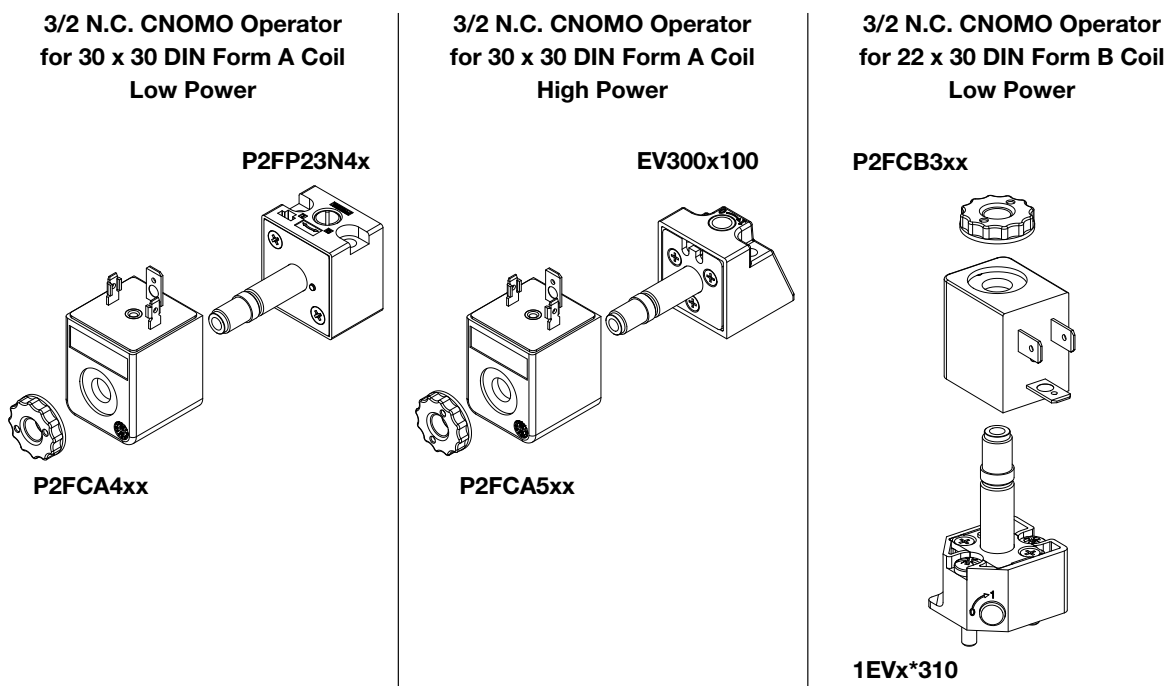

Parker Hannifin Corporation
Pneumatic Division - Europe

3/2 N.C. CNOMO Operator for 30 x 30 DIN Form A or 22 x 30 DIN Form B coils

Technical data - Solenoid operator & Coil combinations

		3/2 N.C. CNOMO Operators		
		30 x 30 DIN Form A Coil		22 x 30 DIN Form B Coil
		Low Power	High Power	Low Power
Working pressure		0 to 10 bar		
Ambient temperature		-10°C to 60°C (1)	-10°C to 60°C (1)	-25°C to 60°C (1)
Orifice		1.3/1.5mm	1.3/1.5mm	1.2/1.3mm
Nominal Flow Qn		0.84 dm ³ /s	0.84 dm ³ /s	0.7 dm ³ /s
Power	AC Voltages	2,5W	4,5W	3 W
	DC Voltages	3VA	5VA	50 Hz : 5 VA / 60 Hz : 4,2 VA
Voltage tolerance		+/- 10%		
Duty cycle		100%		
Insulation class		F		
Electric connection		DIN A		DIN B
Protection IP65		IP65		
Shock		According to IEC 68-2-6 (2G - from 2 to 150 Hz)		
Vibration		According to IEC 68 - 2 - 7 (15G - 11 m/s)		
Working media		All neutral media such as compressed air and inert gases		

3/2 N.C. CNOMO Operator - Without Coil

Description	Manual override	W (g)	Order code
 Solenoid operator for 30 x 30 DIN Form A Coil Dedicated to Low Power 2,5W / 3VA Coil	No manual override	65	P2FP23N4A
	Pulse non locking	65	P2FP23N4B
	Locking	65	P2FP23N4C
 Solenoid operator for 30 x 30 DIN Form A Coil Dedicated to High Power 4,5W / 5VA Coil	No manual override	65	EV3000100
	Pulse non locking	65	EV3001100
	Locking	65	EV3003100
 Solenoid operator for 22 x 30 DIN Form B Coil Dedicated to Low Power 2,5W / 4,5VA Coil	No manual override	65	1EV0*310
	Pulse non locking	65	1EV1*310
	Locking	65	1EV3*310



30 x 30 DIN Form A and 22 x 30 DIN Form B Coils for CNOMO Operator

Voltage	30 x 30 DIN Form A		22 x 30 DIN Form B	
	W (g)	Order code	W (g)	Order code
 12 Vdc 24 Vdc 48 Vdc	105	P2FCA445	93	P2FCB345
	105	P2FCA449	93	P2FCB349
12 Vac 50/60 Hz 24 Vac 50/60 Hz 48 Vac 50/60 Hz	105	P2FCA453	93	P2FCB351
	105	P2FCA440	93	P2FCB340
110 Vac 50 Hz / 120 Vac 60 Hz 230 Vac 50 Hz / 240 Vac 60 Hz	105	P2FCA445	93	P2FCB345
	105	P2FCA449	93	P2FCB349
	105	P2FCA453	93	P2FCB353
	105	P2FCA457	93	P2FCB357

Spare Solenoid Nuts

Description	Usage	W (g)	Order code
 Plastic knurled nut Diffuser plastic nut	For valve requiring Captured exhaust	5	P2FNPA
	For valve requiring Vented exhaust	5	P2FNDA

30 x 30 DIN Form A and 22 x 30 DIN Form B Solenoid Connectors

Description	Characteristic	Visualisation	Cable length	W (g)	Order code
 30 x 30 DIN Form A connector With standard screw	Standard IP65	No LED	No cable	15	3EV290V10
		24 Vdc/Vac LED	No cable	30	3EV290V20-24
			5 meters	355	3EV290V20-24L5
		110 Vac LED	No cable	30	3EV290V20-110
			5 meters	470	3EV290V20-110L5
		230 Vac LED	No cable	30	3EV290V20-230
5 meters		350	3EV290V20-230L5		
	 22 x 30 DIN Form B connector With standard screw	Standard IP65	No LED	No cable	15
24 Vdc/Vac LED			No cable	20	3EV10V20-24
			5 meters	350	3EV10V20-24L5
110 Vac LED			No cable	25	3EV10V20-110
			5 meters	355	3EV10V20-110L5
230 Vac LED			No cable	25	3EV10V20-230
5 meters		360	3EV10V20-230L5		

M12 Adaptor for 30 x 30 DIN Form A Coil

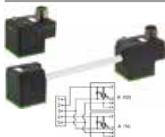
Description	Characteristics	Visualisation	Cable	W (g)	Order code
 M12 Connector for one coil M12 Connector for two coils	24 V AC/DC - 4A	LED	No cable	30	P8C-A626C
	24 V AC/DC - 4A	LED	No cable	70	P8C-AM26C



Note: Solenoid pilot operators are fitted to the ISO valve range.
 Order the above part numbers for spares.
 The operators are supplied with mounting screws and interface 'O' rings.
Coils and connectors must be ordered separately.

ISO 15407-1 Subbases & Manifolds

Side ported individual subbase - ISO 15407-1 - Sizes 02 & 01

Description	Size	Port Size	Weight (g)	Order code
 <p>Individual Subbase Can be used for External pilot supply or Single or Double pneumatic remote pilot</p>	02 - 18 mm	1/8 BSPP	70	PL02-01-70
		1/8 NPT	70	PL02-01-80
	01 - 26 mm	1/4 BSPP	120	PL01-02-70
		1/4 NPT	120	PL01-02-80

Front ported manifold & End plate - ISO 15407-1 - Sizes 02 & 01





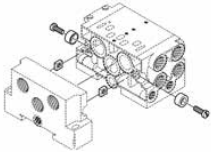

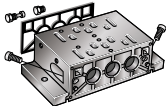
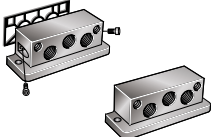

Description	Size	Port Size	Weight (g)	Order code
 <p>Two position manifold base Can be used for External pilot supply Cannot be used for remote pilot</p>	02 - 18 mm	1/8 BSPP	140	PJLP02-201-70
		1/8 NPT	140	PJLP02-201-80
	01 - 26 mm	1/4 BSPP	700	PJLP01-202-70
		1/4 NPT	700	PJLP01-202-80
 <p>Two position manifold base Can be used for External pilot supply using #14 or Single or Double pneumatic remote pilot</p>	01 - 26 mm	1/4 BSPP	730	PJL01-202-70
		1/4 NPT	730	PJL01-202-80
 <p>End plate kit</p>	02 - 18 mm	1/4 BSPP	150	PEJ02-02-70
		1/4 NPT	150	PEJ02-02-80
	01 - 26 mm	3/8 BSPP	520	PEJ01-03-70
		3/8 NPT	520	PEJ01-03-80

Accessories

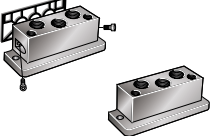
Description	Size	Weight (g)	Order code
 <p>Blanking plate</p>	02 - 18 mm	40	DX02BLK
	01 - 26 mm	50	DX01BLK
 <p>Blanking plug</p>	02 - 18 mm	10	D02BD0
	01 - 26 mm	20	D01BD0
	02 - 18 mm & 01 - 26 mm	120	DX02M2MB
<p>Front Ported Manifold Assembling Kit Including 10 Bolts, 10 Washers & 10 Nuts</p>			

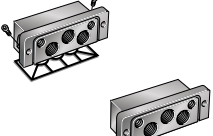
PDE2568TCUK

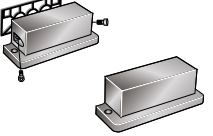
ISOMAX DX ISO Valve Series
Bottom ported manifold & End plate - ISO 15407-1 - Sizes 02 & 01

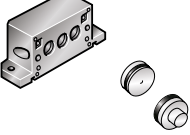

Description		Size	Port Size	Weight (g)	Order code
 Two valve position manifold	Int. pilot supply	02 - 18 mm	1/8 BSPP	200	P2V-AM511PB
		01 - 26 mm	1/4 BSPP	400	P2V-BM512PB
	Ext. pilot supply	02 - 18 mm	1/8 BSPP	200	P2V-AM511NB
		01 - 26 mm	1/4 BSPP	400	P2V-BM512NB
Including seal, fitting screws and plugs.					
 Side ported	 Left end plate	02 - 18 mm	1/4 BSPP	180	P2V-AM512GS
	Including seal and fitting screws	01 - 26 mm	3/8 BSPP	210	P2V-BM513GS
	 Right end plate	02 - 18 mm	1/4 BSPP	180	P2V-AM512HS
		01 - 26 mm	3/8 BSPP	210	P2V-BM513HS
 Top ported	 Left end plate	02 - 18 mm	1/4 BSPP	180	P2V-AM512GT
	Including seal and fitting screws	01 - 26 mm	3/8 BSPP	210	P2V-BM513GT
	 Right end plate	02 - 18 mm	1/4 BSPP	180	P2V-AM512HT
		01 - 26 mm	3/8 BSPP	210	P2V-BM513HT
 Bottom ported	 Left end plate	02 - 18 mm	1/4 BSPP	180	P2V-AM512GB
	Including seal and fitting screws	01 - 26 mm	3/8 BSPP	220	P2V-BM513GB
	 Right end plate	02 - 18 mm	1/4 BSPP	180	P2V-AM512HB
		01 - 26 mm	3/8 BSPP	220	P2V-BM513HB
 End cover	 Left end plate	02 - 18 mm		190	P2V-AM500G0
	Including seal and fitting screws	01 - 26 mm		240	P2V-BM500G0
	 Right end plate	02 - 18 mm		190	P2V-AM500H0
		01 - 26 mm		240	P2V-BM500H0
Size manifolds adaptor plate		01 to 02		330	P2V-AM500BE
 Plug	Left end plate	02 - 18 mm		4	P2V-AK0P
		01 - 26 mm		10	P2V-BK0P

ISO 5599-1 Subbase & Manifolds

VDMA Side Ported Subbases

Description	Size	Port size	Weight (g)	Order code
 <p>Subbases VDMA Side port according to VDMA</p>	1 - 43mm	G1/4	160	P2N-VS512SD
	2 - 56mm	G3/8	280	P2N-WS513SD
	3 - 71mm	G1/2	350	P2N-YS514SD

VDMA Bottom Ported Manifold

Description	Size	Port size	Weight (g)	Order code
 <p>VDMA Form C Bottom port according to VDMA</p>	1 - 43mm	G1/4	240	P2N-VM512MB
	2 - 56mm	G3/8	360	P2N-WM513MB
	3 - 71mm	G1/2	700	P2N-YM514MB
 <p>VDMA Transition plate Size 1 to Size 3 Kit includes: Transition plate only</p>	1 to 3	G1/4		P2N-VM500AK
 <p>VDMA Form D - End plate According to VDMA</p>	1 - 43mm	G3/8	210	P2N-VM513ES
	2 - 56mm	G1/2	360	P2N-WM514ES
	3 - 71mm	G1	680	P2N-YM518ES
<p>VDMA Isolation - Main galley According to VDMA</p> <p>Kit includes: (1) Isolator plug.</p>	1 - 43mm			P2N-VK0P
	2 - 56mm			P2N-WK0P
	3 - 71mm			P2N-YK0P

Accessories

Description	Size	Port size	Weight (g)	Order code
 <p>Blanking plate</p> <p>Kit includes: (1) Blanking plate, (1) Gasket and (4) Mounting bolts</p>	1 - 43mm	G1/4	100	P2N-AA5B
	2 - 56mm	G3/8	150	P2N-BA5B
	3 - 71mm	G1/2	200	P2N-CA5B

PDE2568TCUK
ISOMAX DX ISO Valve Series









Side ported subbases

Description	Size	Port size	Weight (g)	Order code BSP	Order code NPT
 Single subbase 1 3 5 2 4 ports & 12 14	1 - 43mm	G1/4	160	PL1-1/4-70	PL1-1/4-80
		G3/8	160	PL1-3/8-70	
	2 - 56mm	G3/8	280	PL2-3/8-70	PL2-3/8-80
		G1/2		P2N-HS514SS	
	3 - 71mm	G1/2		PL3-1/2-70	PL3-1/2-80
		G3/4		P2N-JS516SD	





Bottom ported subbases

Description	Size	Port size	Weight (g)	Order code BSP	Order code NPT
 Single subbase 1 3 5 2 4 ports & 12 14	1 - 43mm	G1/4	370	PD1-1/4-70	PD1-1/4-80
	2 - 56mm	G3/8	590	PD2-3/8-70	PD2-3/8-80
	3 - 71mm	G1/2	590	PD3-1/2-70	

Size 1 bottom ported manifold

Description	Size	Port size	Weight (g)	Order code
  Manifold with bottom ports low profile	1 - 43mm	G1/4	20	P2N-AM512MB
  Connecting block Top or bottom ported connecting block for above manifold "low profile"	1 - 43mm	G3/8	150	P2N-AM513GT
  End End piece for above manifold "low profile"	1 - 43mm	no	6	P2N-AM500J
  Intermediate supply Top or bottom ported intermediate supply for above manifold "low profile"	1 - 43mm	G3/8	140	P2N-AM513BT
 Isolation plugs isolating seal for above manifold "low profile"	1 - 43mm		070	P2N-AK0P

Sizes 1 & 2 side ported manifold

Description	Size	Port size	Weight (g)	Order code
  Manifold Manifold with side port	1 - 43mm	G1/4	240	P2N-EM512MD
	2 - 56mm	G3/8	210	P2N-FM513MD
  End Side ported connecting kit for above manifold with side ports	1 - 43mm	G3/8	360	P2N-EM513ES
	2 - 56mm	G1/2	290	P2N-FM514ES

Sandwich regulator for Plug-in or not Plug-in ISO 15407 (Sizes 02 & 01) and 5599 (Sizes 1, 2 & 3)

Order chart

Function Description see below

PS40	37	1	6	6	CP
-------------	-----------	----------	----------	----------	-----------

ISO Size	
ISO 15407	
PS56	Size 02 (HB - 18 mm)
PS55	Size 01 (HA - 26 mm)
ISO 5599	
PS40	Size 1 (H1 - 43 mm)
PS41	Size 2 (H2 - 56 mm)
PS42	Size 3 (H3 - 71 mm)

ISO Version	
P	For ISO 15407
CP	For ISO 5599

Port Regulator / Gauge*	
0	Line By-Pass Plate**
1	0-2 Bar - without gauge
2	0-4 Bar - without gauge
3	0-8 Bar - without gauge
4	0-2 Bar - with gauge
5	0-4 Bar - with gauge
6	0-8 Bar - with gauge

Connecting version	
37	ISO-1 : For Non Plug-in Valve
38	ISO-2 : For Plug-in Valve

Regulator function	
1	Common Pressure Regulator
2	Independent Pressure Regulator

* For Common Pressure Regulator Option, Regulator Gauge callout must be the same number for both port #4 and Port #2 (Example: 166)

** For H1, H2 & H3 only. Pressure Line By-Pass Option can only be used with Independent Pressure Regulators

Pressure Regulators functions

Common port regulation

Provides adjustable regulated air pressure to the valves #1 port which gives the same regulated pressure to both the #2 and #4 port of the manifold or subbase. The regulator is always on the 14 end of the valve.

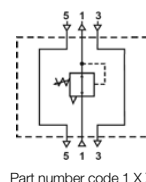

Independent port regulation

Single Port Regulator

Provides regulated pressure to both ports. Pressure regulation can occur out of the #2 or #4 port of the valve. Full line pressure would be provided with a pass plate.

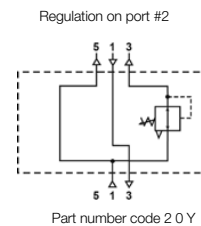
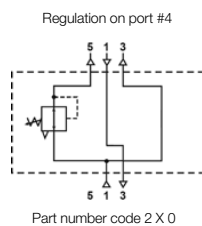

Dual Port Regulator

When using an independent Pressure Sandwich Regulator, the cylinder outlet ports are reversed. The 12 end energizes the #2 port. The 3-position CE and PC functions are also reversed.

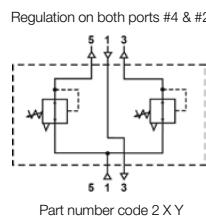

Sandwich regulator with Gauge

	ISO Size	Regulator function	Pressure On port 4 and / or port 2	w (g)	ISO-1 Non Plug-in	ISO-2 Plug-in
	02 - 18 mm	Common	0 to 4 bar		PS5637155P	PS5638155P
			0 to 8 bar		PS5637166P	PS5638166P
		Independent	0 to 4 bar		PS5637255P	PS5638255P
			0 to 8 bar		PS5637266P	PS5638266P
	01 - 26 mm	Common	0 to 4 bar		PS5537155P	PS5538155P
			0 to 8 bar		PS5537166P	PS5538166P
		Independent	0 to 4 bar		PS5537255P	PS5538255P
			0 to 8 bar		PS5537266P	PS5538266P
	1 - 43 mm	Common	0 to 4 bar		PS4037155CP	PS4038155CP
			0 to 8 bar		PS4037166CP	PS4038166CP
		Independent	0 to 4 bar		PS4037255CP	PS4038255CP
			0 to 8 bar		PS4037266CP	PS4038266CP
	2 - 56 mm	Common	0 to 4 bar		PS4137155CP	PS4138155CP
			0 to 8 bar		PS4137166CP	PS4138166CP
		Independent	0 to 4 bar		PS4137255CP	PS4138255CP
			0 to 8 bar		PS4137266CP	PS4138266CP
	3 - 71 mm	Common	0 to 4 bar		PS4237155CP	PS4238155CP
			0 to 8 bar		PS4237166CP	PS4238166CP
		Independent	0 to 4 bar		PS4237255CP	PS4238255CP
			0 to 8 bar		PS4237266CP	PS4238266CP

How to Configure Sandwich Regulator / Valve Combinations

Ordering Components

- Manifold or Subbase Kit required.
- Sandwich Regulator Kit configured for Internal Pilot as standard.
- Order valve as External Pilot.

Internal Pilot Configuration

Pressure in Base Port 1 feeds regulator configured for Internal Pilot which feeds valve configured for External Pilot.

External Pilot Configuration - H1, H2, H3

An External Pilot pressure in port 12 or 14 of the base feeds through the Sandwich Regulator 12 or 14 galley directly to the 12/14 pilot of the valve. This configuration takes an External Pilot from the 12 port of the base and passes it through the regulator to feed the 12 galley of the valve.

Sandwich Regulator Accessories

	Description	Pressure range	w (g)	Order code
	Gauge kit Including: Gauge 1/8" female to 1/8" female coupling 1/8" male to 1/8" male long nipple	0 to 8 bar	80	PS5651160P

Sandwich Flow Control

	ISO Size	w (g)	ISO-1 Non Plug-in	ISO-2 Plug-in
	02 - 18 mm	180	PS5635P	PS5642P
	01 - 26 mm	240	PS5535P	PS5542P
	1 - 43 mm	340	PS4035CP	PS4042CP
	2 - 56 mm	520	PS4135CP	PS4142CP
	3 - 71 mm	1180	PS4235CP	PS4242CP

Note:

- Both adjustment screws are located on the same 12 end of the unit
- Sandwich Flow Control mounts with its own studs, which means the valve uses standard bolts for mounting
- Sandwich Flow Control is not to be used as a shut off device and is not bubble tight when needles are fully turned down

PDE2568TCUK

ISOMAX DX ISO Valve Series

Dimensions

15 mm DIN Form C solenoid operators and connectors

P2E Operator

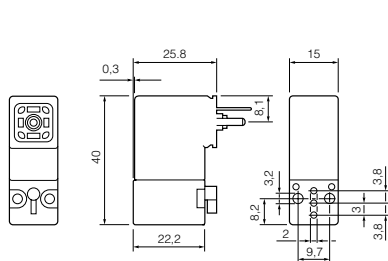

Connector with standard screw

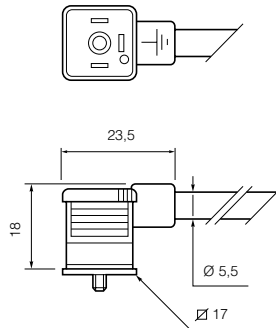

Connector with large headed screw

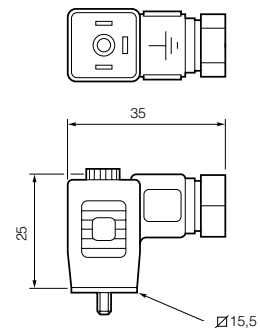

CNOMO 22 x 30 solenoid operators and connectors

P2F Operator with 30 x 30 DIN form A coil

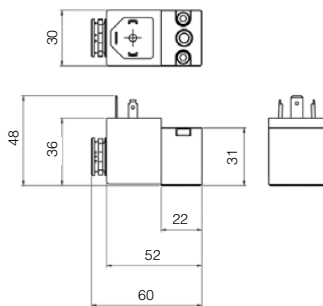

EV30 Operator with 30 x 30 DIN form A coil

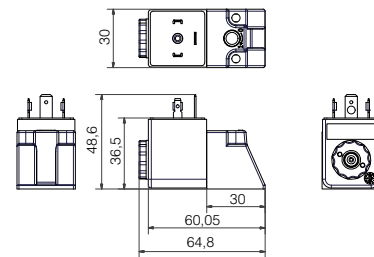

30 x 30 DIN form A connector

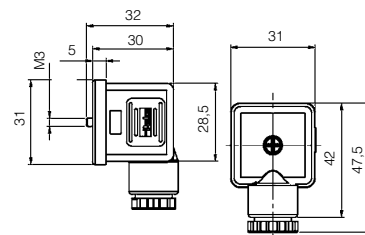

EV310 Operator with 22 x 30 DIN form B coil

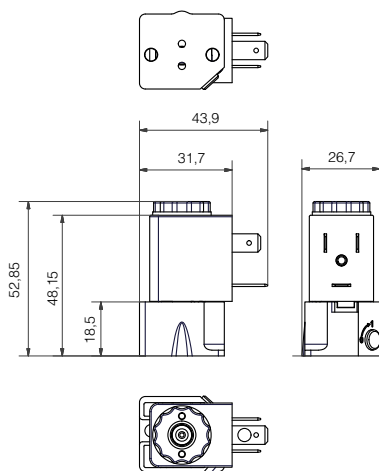

22 x 30 DIN form B connector

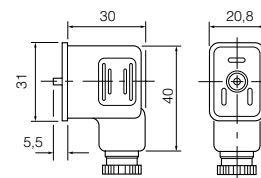

PDE2568TCUK

ISOMAX DX ISO Valve Series

Dimensions

ISOMAX - ISO 15407-1 - Sizes 02 & 01

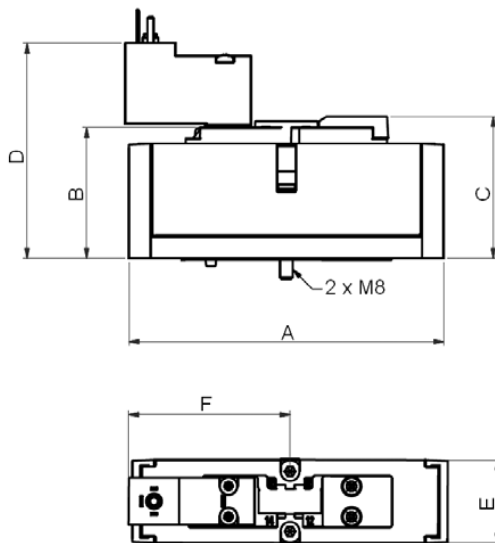

	A	B	C	D	E	F
ISOMAX 02	80	41	44,5	67,8	18	51,2
ISOMAX 01	100	42	45,5	68,8	26	51,2

ISOMAX - ISO 5599-1 - Sizes 1, 2 & 3

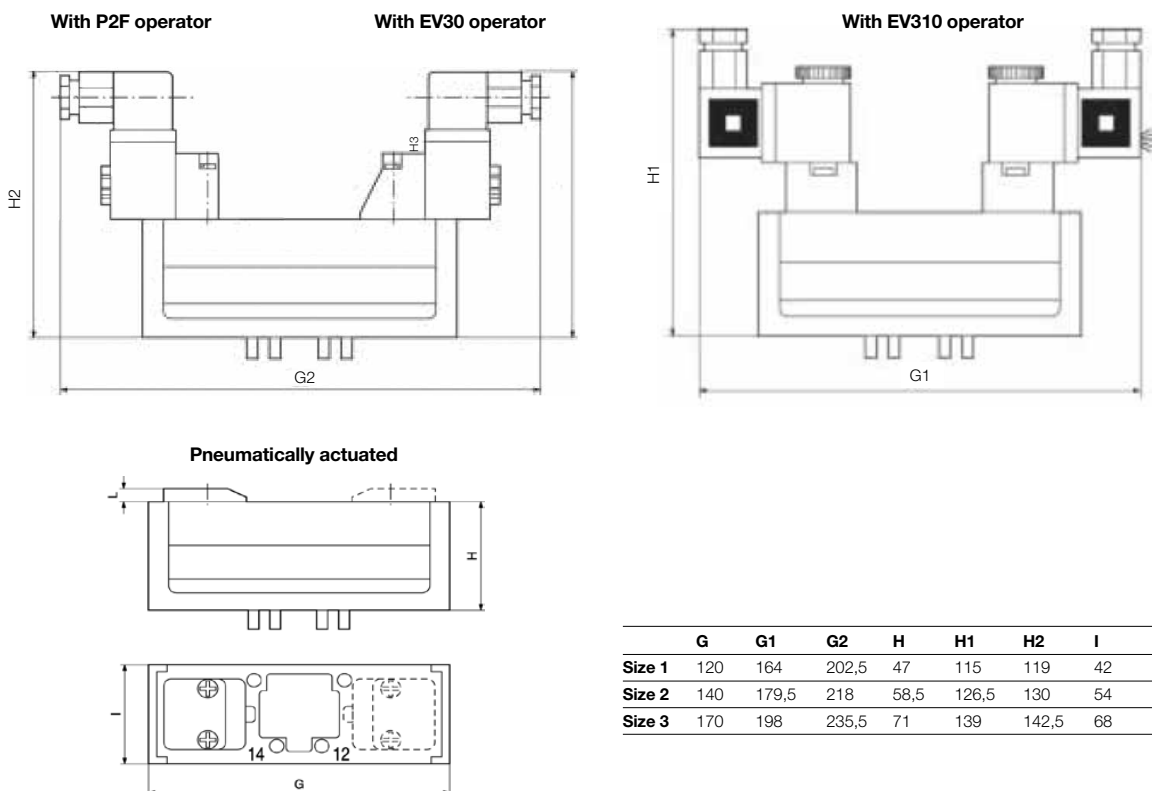

	G	G1	G2	H	H1	H2	I	L
Size 1	120	164	202,5	47	115	119	42	5
Size 2	140	179,5	218	58,5	126,5	130	54	5
Size 3	170	198	235,5	71	139	142,5	68	5



PDE2568TCUK

ISOMAX DX ISO Valve Series

Dimensions

Side ported individual subbase - ISO 15407-1 - Sizes 02 & 01

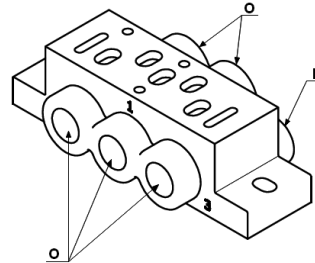
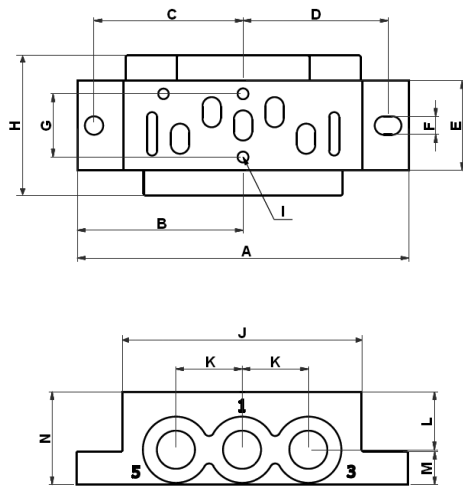

		Size	A	B	C	D	E	F	G	H	I	J	K	L	M	N	O	P
PL02-01-70	BSPP	02	80	40	35	33.75	19	5.5	12.5	27	M8	50	16	14	8	22.5	1/8	1/8
PL02-01-80	NPT	02	80	40	35	33.75	19	5.5	12.5	27	M8	50	16	14	8	22.5	1/8	1/8
PL01-02-70	BSPP	01	100	50	45	43.75	27	5.5	19	42,5	M8	72	20	17,5	10	28	1/4	1/8
PL01-02-80	NPT	01	100	50	45	43.75	27	5.5	19	42,5	M8	72	20	17,5	10	28	1/4	1/8

Front ported manifold & End plate - ISO 15407-1 - Sizes 02 & 01

		Size	A	B	C	D	E	F	G	H
PJLP02-201-70	BSPP	02	38,5	80	-	-	38	-	-	-
PJLP02-201-80	NPT	02	38,5	80	-	-	38	-	-	-
PJLP01-202-70	BSPP	01	55	100	-	-	54	-	-	-
PJLP01-202-80	NPT	01	55	100	-	-	54	-	-	-
PJL01-202-70	BSPP	01	55	100	-	-	54	-	-	-
PJL01-202-80	NPT	01	55	100	-	-	54	-	-	-
PEJ02-02-70	BSPP	02	38,5	80	12	Ø4,2	-	14	18	70
PEJ02-02-80	NPT	02	38,5	80	12	Ø4,2	-	14	18	70
PEJ01-03-70	BSPP	01	55	100	24	Ø5,5	-	17	22	90
PEJ01-03-80	NPT	01	55	100	24	Ø5,5	-	17	22	90

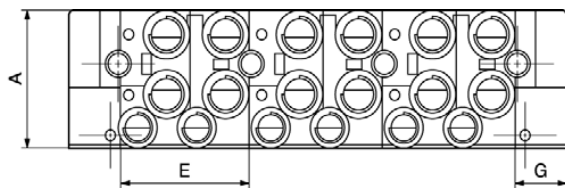

PJLP01-201-70
PJLP01-202-70

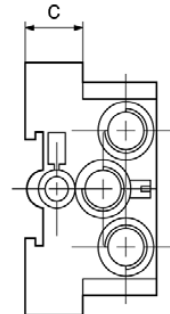
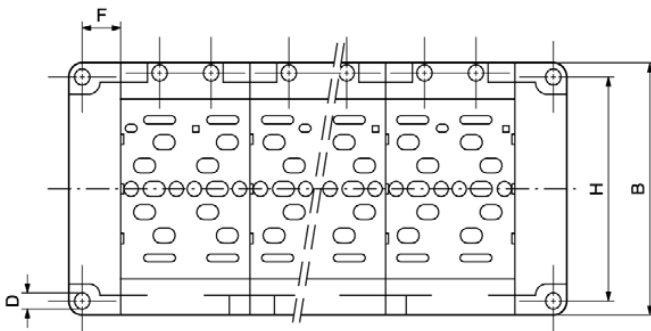

PDE2568TCUK

ISOMAX DX ISO Valve Series

Dimensions

Bottom ported manifold - ISO 15407-1 - Sizes 02 & 01

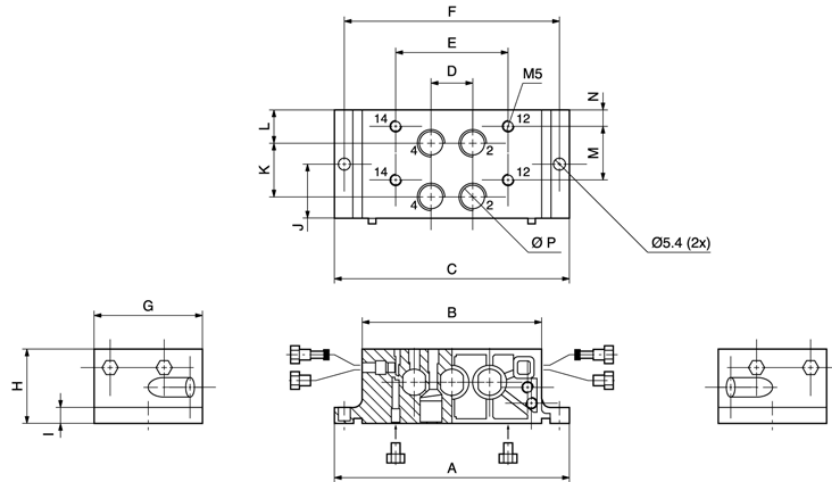

	Size	A	B	C	D	E	F	G	H	I	J	K	L	M	N	P
P2V-AM511PB	02	102	74	74,6	16	43	92	38	26	7	19	19	11	19	5	G1/8
P2V-BM512PB	01	118	90	90,6	21	56,5	108	54	37	8	27	27	16,5	27	8	G1/4

Bottom ported End plate - ISO 15407-1 - Sizes 02 & 01

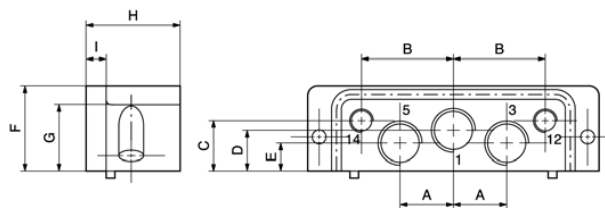

	Size	Port size 1,2,3	Port size 12, 14	A	B	C	D	E	F	G	H	I
P2V-AM512XX and P2V-AM512XX	02	G1/4	G1/8	17	29	21	18,5	9,5	35,5	28	33	7
P2V-BM513XX and P2V-BM513XX	01	G3/8	G1/8	21,5	37	20	16	11	34,5	28	38	8

Transfer plate size 01 to size 02 for above bottom ported manifold

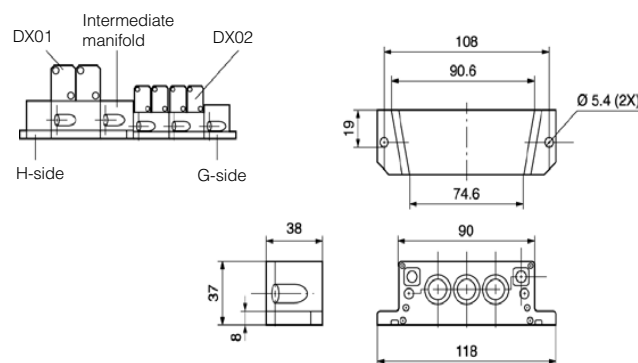

PDE2568TCUK

ISOMAX DX ISO Valve Series

Dimensions

ISO 5599-1 Subbase & Manifolds

VDMA Side Ported Subbases

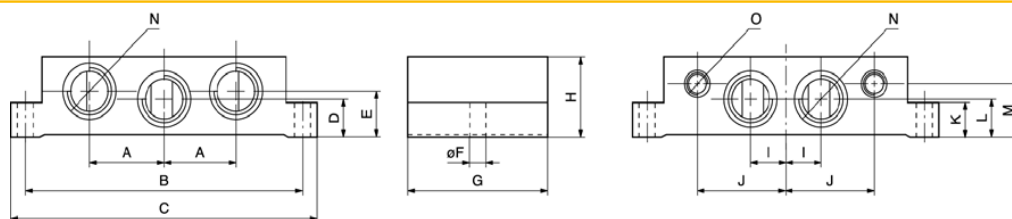

Order code	ISO Size	Port Size	A	B	C	D	E	F	G	H	I	J	K	L	M	N	O
P2N-VS512SD	1	G1/4	21,5	98	110	11	20	5,5	48	32	12	29	10	11	23	G1/4	G1/8
P2N-WS513SD	2	G3/8	28	112	124	14	26	6,6	56	40	15	37	13	14	30	G3/8	G1/8
P2N-YS514SD	3	G1/2	34	136	149	17	17	6,6	71	32	16	45	18	17	22	G1/2	G1/8

VDMA Bottom Ported Manifold

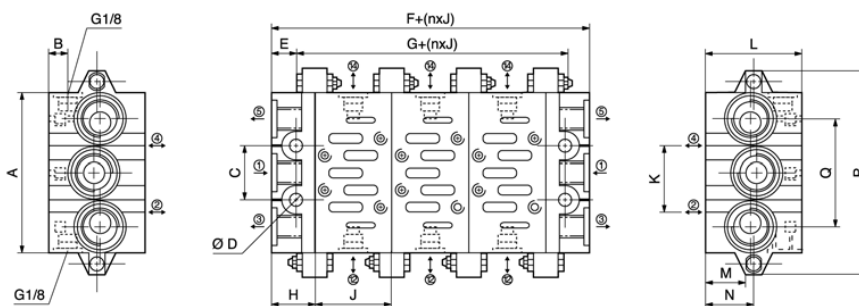

Order code	ISO Size	Port 1, 3, 5	Port 2, 4	A	B	C	D	E	F	G	H	J	K	L	M	N	O	P
P2N-VM512MB	1	G3/8	G1/4	85	8,5	28	7	11	44	22	22	43	26	46	21	24	56	110
P2N-WM513MB	2	G1/2	G3/8	100	9	35	9	13	52	26	26	56	30	47	22	24	68	135
P2N-YM514MB	3	G1	G1/2	140	10	52	12	15	60	30	30	71	38	56	31	34	104	190

Side ported subbases

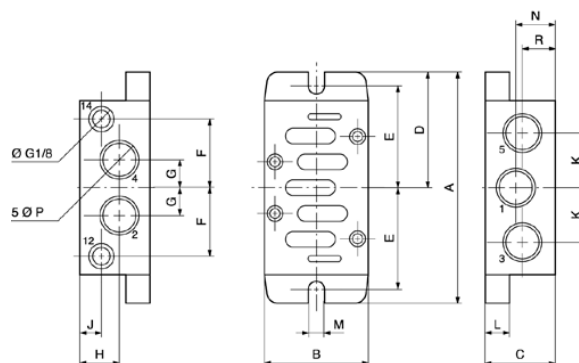

Order code	ISO Size	ØP	A	B	C	D	E	F	G	H	J	K	L	M	N	R
PL1-1/4-70	1	G1/4	110	46	29	55	49	30	11	17,75	17,75	22	6	5,5	17,75	17,75
PL2-3/8-70	2	G3/8	124	56	37	62	55	37	14,5	22,5	14	28	6	5,5	22,5	14,5
P2N-JS516SD	3	G3/4	149	71	60	74,5	68	45	21	33	10	40	18	6,6	37,5	22,5



Bottom ported subbases

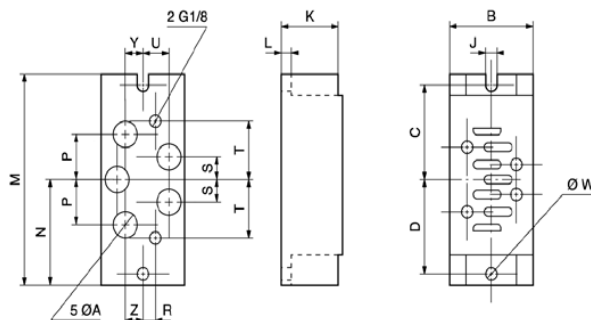

Order code	ISO Size	A	B	C	D	J	K	L	M	N	P	R	S	T	U	W	Y	Z
PD1-1/4-70	1	G1/4	46	49	49	5,5	29	6	110	55	22	10	11	30	10	5,5	10	10
PD2-3/8-70	2	G3/8	56	55	55	5,5	37	6	124	62	29	10	14,5	37	12,5	5,5	12,5	12,5
PD3-1/2-70	3	G1/2	77	68	68	6,6	32	18	149	74,5	34	10	17	45	17	6,5	17	17

Size 1 bottom ported manifold

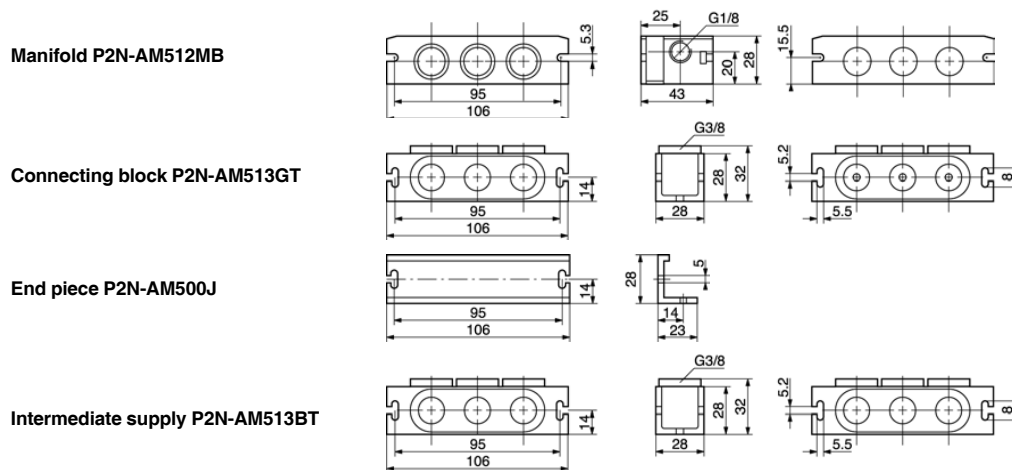

Sizes 1 & 2 side ported manifold

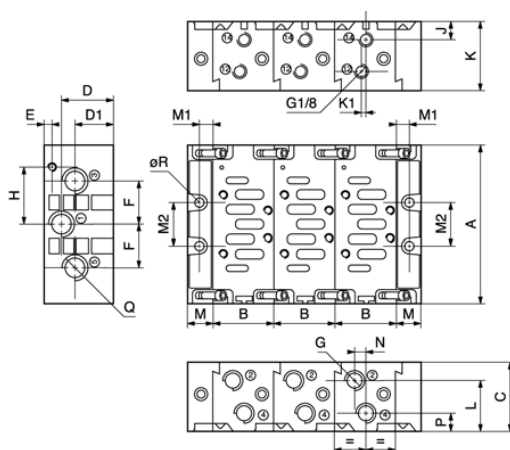

Order code	A	B	C	D	D1	E	F	G	H	J	K	K1	L	M	M1	M2	N	P	Q	R
P2N-EM ...	110	43	48	35,5	26,5	5,5	28	G1/4	36	15,5	35	3	32	20	11	28	12	12,5	G3/8	6
P2N-FM ...	129	56	60	44,5	35,5	6	34,5	G3/8	45	16	41,5	3	41	24	13	35	12,5	16	G1/2	8



Sandwich Regulator with Gauge

HA / HB Series

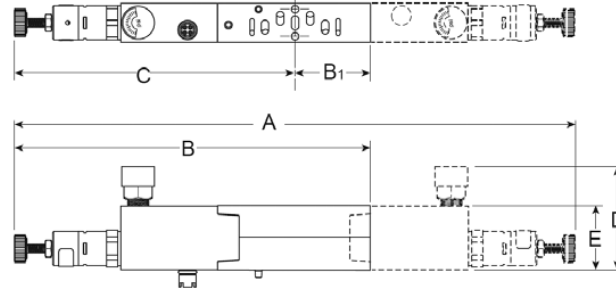

	A	B	B1	C	D	E
HB	261	156	26	130	66	30
HA	254	163	36	127	69	30

H1 Series

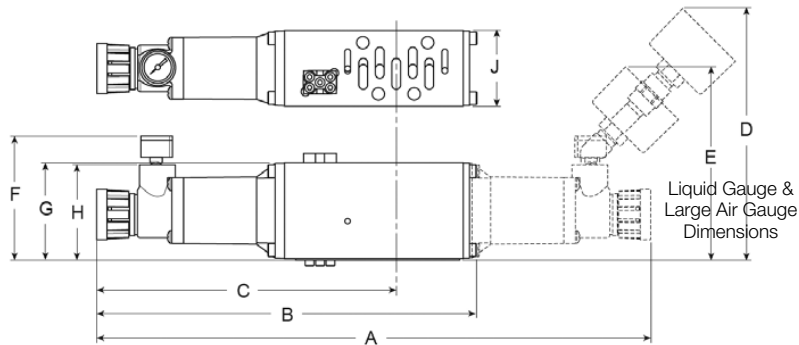

	A	B	C	D	E	F	G	H	J
H1	301	207	163	138	108	72	53	52	41

H2 / H3 Series

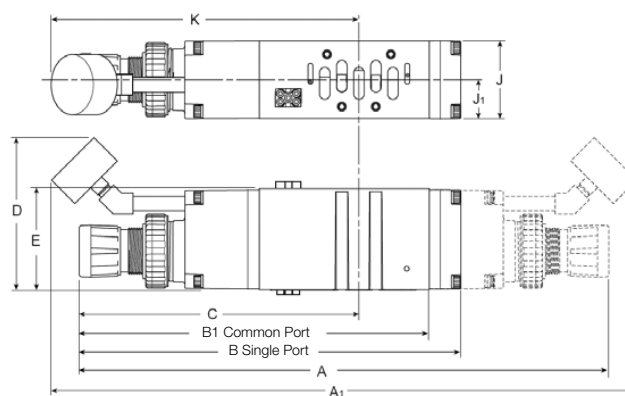

	A	A1	B	B1	C	D	E	J	J1	K
H2	372	411	268	250	196	107	71	55	27	216
H3	398	436	293	271	213	107	75	64	32	231

Sandwich Flow Control

HA Series

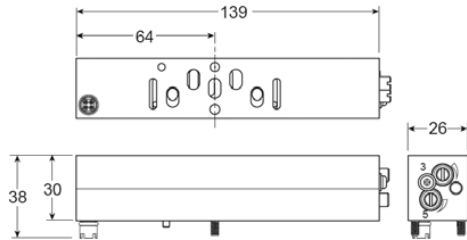

HB Series

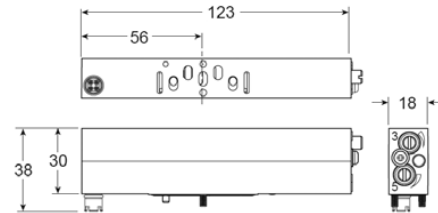

H1 Series

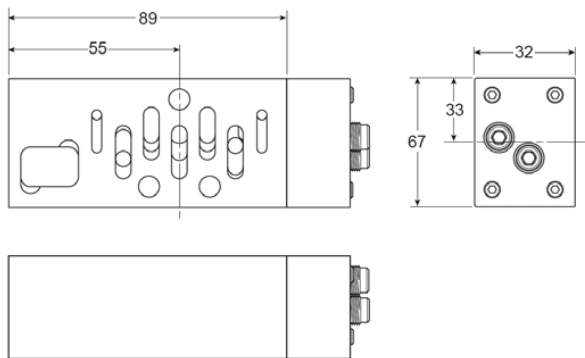

H2 Series

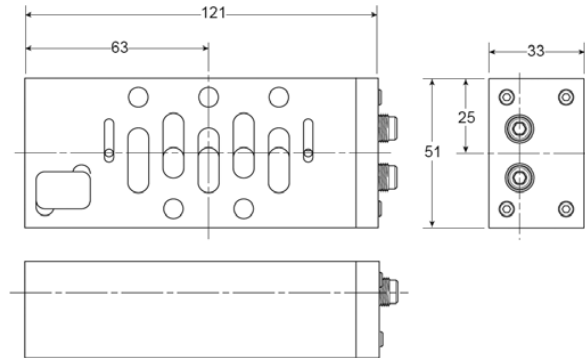

H3 Series

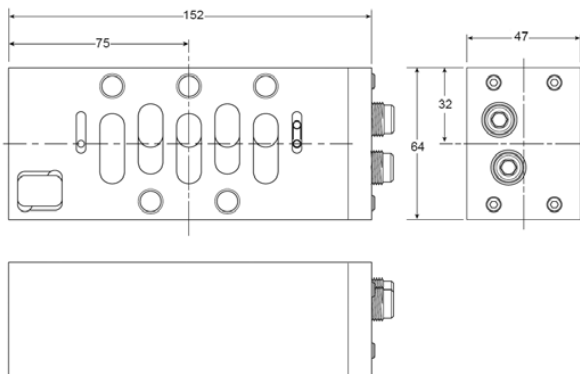

PDE2568TCUK

ISOMAX DX ISO Valve Series



PDE2568TCUK

ISOMAX DX ISO Valve Series



Parker Worldwide

Europe, Middle East, Africa

AE – United Arab Emirates,
Dubai

Tel: +971 4 8127100
parker.me@parker.com

AT – Austria, Wiener Neustadt
Tel: +43 (0)2622 23501-0
parker.austria@parker.com

AT – Eastern Europe, Wiener
Neustadt
Tel: +43 (0)2622 23501 900
parker.easteurope@parker.com

AZ – Azerbaijan, Baku
Tel: +994 50 2233 458
parker.azerbaijan@parker.com

BE/LU – Belgium, Nivelles
Tel: +32 (0)67 280 900
parker.belgium@parker.com

BG – Bulgaria, Sofia
Tel: +359 2 980 1344
parker.bulgaria@parker.com

BY – Belarus, Minsk
Tel: +48 (0)22 573 24 00
parker.poland@parker.com

CH – Switzerland, Etoy
Tel: +41 (0)21 821 87 00
parker.switzerland@parker.com

CZ – Czech Republic, Klecany
Tel: +420 284 083 111
parker.czechrepublic@parker.com

DE – Germany, Kaarst
Tel: +49 (0)2131 4016 0
parker.germany@parker.com

DK – Denmark, Ballerup
Tel: +45 43 56 04 00
parker.denmark@parker.com

ES – Spain, Madrid
Tel: +34 902 330 001
parker.spain@parker.com

FI – Finland, Vantaa
Tel: +358 (0)20 753 2500
parker.finland@parker.com

FR – France, Contamine s/Arve
Tel: +33 (0)4 50 25 80 25
parker.france@parker.com

GR – Greece, Athens
Tel: +30 210 933 6450
parker.greece@parker.com

HU – Hungary, Budaörs
Tel: +36 23 885 470
parker.hungary@parker.com

IE – Ireland, Dublin
Tel: +353 (0)1 466 6370
parker.ireland@parker.com

IL – Israel
Tel: +39 02 45 19 21
parker.israel@parker.com

IT – Italy, Corsico (MI)
Tel: +39 02 45 19 21
parker.italy@parker.com

KZ – Kazakhstan, Almaty
Tel: +7 7273 561 000
parker.easteurope@parker.com

NL – The Netherlands, Oldenzaal
Tel: +31 (0)541 585 000
parker.nl@parker.com

NO – Norway, Asker
Tel: +47 66 75 34 00
parker.norway@parker.com

PL – Poland, Warsaw
Tel: +48 (0)22 573 24 00
parker.poland@parker.com

PT – Portugal
Tel: +351 22 999 7360
parker.portugal@parker.com

RO – Romania, Bucharest
Tel: +40 21 252 1382
parker.romania@parker.com

RU – Russia, Moscow
Tel: +7 495 645-2156
parker.russia@parker.com

SE – Sweden, Spånga
Tel: +46 (0)8 59 79 50 00
parker.sweden@parker.com

SL – Slovenia, Novo Mesto
Tel: +386 7 337 6650
parker.slovenia@parker.com

TR – Turkey, Istanbul
Tel: +90 216 4997081
parker.turkey@parker.com

UA – Ukraine, Kiev
Tel: +48 (0)22 573 24 00
parker.poland@parker.com

UK – United Kingdom, Warwick
Tel: +44 (0)1926 317 878
parker.uk@parker.com

ZA – South Africa, Kempton Park
Tel: +27 (0)11 961 0700
parker.southafrica@parker.com

North America

CA – Canada, Milton, Ontario
Tel: +1 905 693 3000

US – USA, Cleveland
Tel: +1 216 896 3000

Asia Pacific

AU – Australia, Castle Hill
Tel: +61 (0)2-9634 7777

CN – China, Shanghai
Tel: +86 21 2899 5000

HK – Hong Kong
Tel: +852 2428 8008

IN – India, Mumbai
Tel: +91 22 6513 7081-85

JP – Japan, Tokyo
Tel: +81 (0)3 6408 3901

KR – South Korea, Seoul
Tel: +82 2 559 0400

MY – Malaysia, Shah Alam
Tel: +60 3 7849 0800

NZ – New Zealand, Mt Wellington
Tel: +64 9 574 1744

SG – Singapore
Tel: +65 6887 6300

TH – Thailand, Bangkok
Tel: +662 186 7000

TW – Taiwan, Taipei
Tel: +886 2 2298 8987

South America

AR – Argentina, Buenos Aires
Tel: +54 3327 44 4129

BR – Brazil, Sao Jose dos Campos
Tel: +55 800 727 5374

CL – Chile, Santiago
Tel: +56 2 623 1216

MX – Mexico, Toluca
Tel: +52 72 2275 4200

European Product Information Centre

Free phone: 00 800 27 27 5374

(from AT, BE, CH, CZ, DE, DK, EE, ES, FI,
FR, IE, IL, IS, IT, LU, MT, NL, NO, PL, PT, RU,
SE, SK, UK, ZA)



Parker Hannifin Ltd.
Tachbrook Park Drive
Tachbrook Park,
Warwick, CV34 6TU
United Kingdom
Tel.: +44 (0) 1926 317 878
Fax: +44 (0) 1926 317 855
parker.uk@parker.com
www.parker.com