



## Air Motors

P1V-M Robust Type  
0.2, 0.4, 0.6, 0.9 & 1.2 kW

Catalogue PDE2539TCUK



ENGINEERING YOUR SUCCESS.

## P1V-M - Robust Air Motors

Features	Air motor	Hydraulic motor	Electric motor	Electric motor regulated	Electric motor regulated with feed back
Overload safe	***	***	*	**	***
Increased torque at higher loads	***	**	*	**	***
Easy to limit torque	***	***	*	*	***
Easy to vary speed	***	***	*	***	***
Easy to limit power	***	***	*	**	***
Reliability	***	***	***	***	***
Robustness	***	***	*	*	*
Installation cost	***	*	**	**	**
Ease of service	***	**	*	*	*
Safety in damp environments	***	***	*	*	*
Safety in explosive atmospheres	***	***	*	*	*
Safety risk with electrical installations	***	***	*	*	*
Risk of oil leak	***	*	***	***	***
Hydraulic system required	***	*	***	***	***
Weight	**	***	*	**	*
Power density	**	***	*	*	*
High torque for size	**	***	*	*	*
Noise level during operation	*	***	**	**	**
Total energy consumption	*	**	***	***	***
Service interval	*	**	***	***	***
Compressor capacity required	*	***	***	***	***
Purchase price	*	*	***	***	**
Accuracy, speed	*	**	*	**	***
Regulating dynamic	*	*	*	*	***
Communication	*	*	*	***	***

\* = good, \*\*=average, \*\*\*=excellent



### Important

Before carrying out service activities, make sure the air motor is vented. Before disassembling the motor, disconnect the primary air hose to ensure that the air supply is interrupted.



### Note

All technical data in the catalogue are typical values.  
The air quality is a major factor in the service life of the motor, see ISO 8573-1.



### WARNING

**FAILURE OR IMPROPER SELECTION OR IMPROPER USE OF THE PRODUCTS AND/OR SYSTEMS DESCRIBED HEREIN OR RELATED ITEMS CAN CAUSE DEATH, PERSONAL INJURY AND PROPERTY DAMAGE.**

This document and other information from Parker Hannifin Corporation, its subsidiaries and authorized distributors provide product and/or system options for further investigation by users having technical expertise. It is important that you analyze all aspects of your application and review the information concerning the product or system in the current product catalog. Due to the variety of operating conditions and applications for these products or systems, the user, through its own analysis and testing, is solely responsible for making the final selection of the products and systems and assuring that all performance, safety and warning requirements of the application are met. The products described herein, including without limitation, product features, specifications, designs, availability and pricing, are subject to change by Parker Hannifin Corporation and its subsidiaries at any time without notice.

### SALE CONDITIONS

The items described in this document are available for sale by Parker Hannifin Corporation, its subsidiaries or its authorized distributors. Any sale contract entered into by Parker will be governed by the provisions stated in Parker's standard terms and conditions of sale (copy available upon request).

<b>Contents</b>	<b>Page</b>
The steps to size .....	4 - 9
Air quality & lubrication .....	10
P3X Air Preparation System .....	11
Features .....	12
Robust air motors P1V-M .....	13
Material and technical specification .....	14
Choice of air motor .....	15
Robust air motors without gear boxes, 200 to 1200 watts .....	16
Dimensions .....	17
Robust air motors with gear box 200 watts .....	18
Dimensions .....	19
Robust air motors with gear box 400 watts .....	20
Dimensions .....	21
Robust air motors with gear box 600 watts .....	22
Dimensions .....	23
Robust air motors with gear box 900 watts .....	24
Dimensions .....	25
Robust air motors with gear box 1200 watts .....	26
Dimensions .....	27
Permitted shaft loadings .....	28
Order key .....	29
Service - Easier - Faster - Cheaper .....	30 - 31

---

## Choosing the correct air motor for your application

### ① Which drive principle of the air motor is suitable for your application?

- Air vane motor are suitable for regular operating cycles, speed is very small e.g. 16 rpm
- Tooth gear air motor or turbines are more suitable for continuous operation, 24 hours non-stop, speed is in a upper range, up to 140,000 rpm
- Oil free operation is often an option for these three principles of air motors.

### ② Which motor materials are suitable for your application?

- Will the air motor work in a normal production area
- Or in a paper industry
- Or in the food processing industry, in contact or not with food
- Or in underwater usage
- Or in the medical, pharmaceutical industries
- Or in potentially explosive areas
- Others, please describe your environment

### ③ How do you calculate the motor power taking the application conditions into consideration?

1. Which rotational direction? Clockwise, anti-clockwise, reversible?
2. Air pressure working range? Which air class quality is available?
3. Which torque and which speed under load do you expect to obtain?
4. Calculate the basic power with the formula

$$P = M \times n / 9550 \text{ with } P \text{ power output in kW, } M \text{ nominal torque in Nm, } n \text{ nominal speed in rpm}$$

5. Check performance data of air motors in our catalogues. Note that all data is at 6 bar in the inlet of the air motor, max 3 meters for tubes and oil lubricated operations.
6. To adapt the difference of air pressure with your operation conditions, please check graphs in our catalogues and how to do it.
7. or you can adapt the need of air to fit your operation conditions by throttling the outlet flow in the air motor you will reduce speed without loss of torque.
8. Check if you need an oil free or not working operation. 1 to 2 drops of oil per cube meter are needed to optimize performance and life time of air motors. Oil free operation will decrease by 10 to 15% the performance of air motors.

### ④ How do you integrate your air motor in your system?

- In which position is the air motor used?
- Do you need to use a brake?
- Do you want to use your own gear box and put it somewhere else in the machine?
- Do you need extra components like fittings, tubes, valves and FRLs?

### ⑤ How do you ensure a long life and high performance of the air motor?

- Ensure you air quality is in accordance with our specifications, oil or oil free lubrication operations.
- Keep the recommended maintenance intervals

### ⑥ How do you determine the purchasing and running costs after the air motor installation?

- Keep same level of your air quality.

PDE2539TCUK

## P1V-M - Robust Air Motors

### Principles of air motor functioning

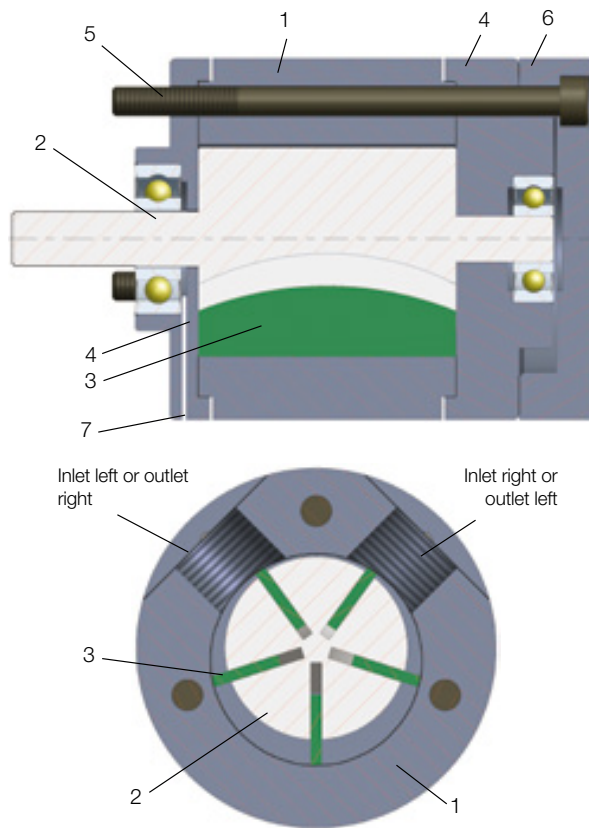

- |   |                          |
|---|--------------------------|
| 1 | Rotor cylinder           |
| 2 | Rotor                    |
| 3 | Vanes                    |
| 4 | End piece with bearing   |
| 5 | Mounting screw for motor |
| 6 | Removable rear piece     |
| 7 | Pressure unloading       |

### Torque, power and air consumption graphs



The curve is for 6 bar  
**P** = power      **Q** = air consumption  
**M** = torque      **n** = speed

- Possible working range of motor.
- Optimum working range of motor.  
Higher speeds = more vane wear  
Lower speeds with high torque = more gearbox wear

There are a number of designs of air motors. Parker has chosen to use the vane rotor design, because of its simple design and reliable operation. The small external dimensions of vane motors make them suitable for all applications.

The principle of the vane motor is that a rotor with a number of vanes is enclosed in a rotor cylinder. The motor is supplied with compressed air through one connection and air escapes from the other connection. The air pressure always bears at right angles against a surface. This means that the torque of the motor is a result of the vane surfaces and the air pressure. a family of curves as above, from which torque, power and air consumption can be read off as a function of speed. Power is zero when the motor is stationary and also when running at free speed (100%) with no load. Maximum power (100%) is normally developed when the motor is braked to approximately half the free speed (50%). Torque at free speed is zero, but increases as soon as a load

is applied, rising linearly until the motor stalls. As the motor can stop with the vanes in various positions, it is not possible to specify an exact starting torque. However, a minimum starting torque is shown in all tables.

Air consumption is greatest at free speed, and decreases with decreasing speed, as shown in the above diagram.

PDE2539TCUK

## P1V-M - Robust Air Motors

### Introduction

The performance of an air motor is dependent on the inlet pressure. At a constant inlet pressure, air motors exhibit the characteristic linear output torque / speed relationship. However, by simply regulating the air supply, using the techniques of throttling or pressure regulation, the output of an air motor can easily be modified. The most economical operation of an air motor (least wear, least air consumption, etc.) is reached by running close to nominal speed. By torque of  $M = 0$ , the maximum speed (idle speed) is reached. Shortly before standstill ( $n = 0$ ), the air motor reaches its maximum torque ( $M_{max} = 2 \times M_0$ ). At nominal speed ( $n_n$ ), for example in the middle of the speed range, air motor reaches its maximum power output ( $P_{max}$ ).

### Energy Efficiency

A pneumatic motor achieves its maximum power when it is operating as close as possible to its rated speed (50% of the rated idle speed). The energy balance is best in this area, because the compressed air is used efficiently.

### Air pressure correction factors

To adapt the difference of air pressure with your operation conditions

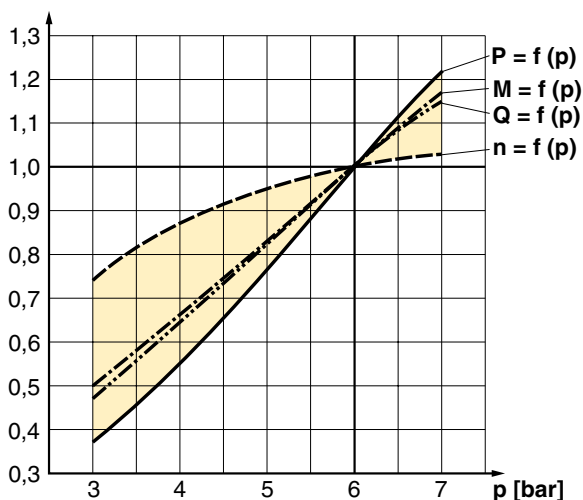

P = Power, M = Torque, Q = Air consumption, N = Speed

Pressure (p) bar / PSI	Power (P) %	Speed (n) %	Torque (M) %	Air Consumpt. (Q) %
7 / 99	121	103	117	117
6 / 85	100	100	100	100
5 / 71	77	95	83	83
4 / 57	55	87	67	67
3 / 42	37	74	50	50

All catalogue data and curves are specified at a supply pressure of 6 bar to the motor. This diagram shows the effect of pressure on speed, specified torque, power and air consumption. Start off on the curve at the pressure used and then look up to the lines for power, torque and air consumption. Read off the correction factor on the Y axis for each curve and multiply this by the specified catalogue data in the table, or data read from the torque and power graphs.

Example: at 4 bar supply pressure, the power is only 0.55 x power at 6 bar supply pressure. This example shows how strongly power falls if supply pressure is reduced. You must therefore ensure that the motor is supplied through pipes of sufficient diameter to avoid pressure drop.

The speed and torque can also be regulated by installing a pressure regulator in the inlet pipe. This means that the motor is constantly supplied with air at lower pressure, which means that when the motor is braked, it develops a lower torque on the output shaft.

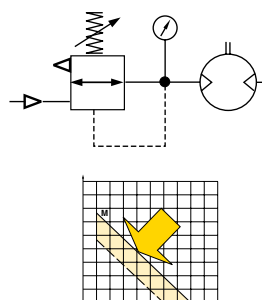

Pressure regulation at motor inlet.

Theoretically torque curve change caused by pressure change

### Speed regulation, air flow reduction

Every size reduction or restriction on the air line, whether of the supply hose itself or fittings, before the air motor affects the amount of the supplied air. By throttling you reduce the speed of your motor and simultaneously, the required torque. That means that you reduce the motor performance. The most common way to reduce the speed of a motor is to install a flow control valve in the air outlet, you can set the speed without loss of the torque. When the motor is used in applications where it must reverse and it is necessary to restrict the speed in both directions, flow control valves with by-pass should be used in both directions. If the inlet air is restricted, the air supply is restricted and the free speed of the motor falls, but there is full pressure on the vanes at low speeds. This means that we get full torque from the motor at low speeds despite the low air flow. Since the torque curve becomes "steeper", this also means that we get a lower torque at any given speed than would be developed at full air flow. The benefit of throttling the inlet is that air consumption is reduced, whereas throttling the exhaust air maintains a slightly higher starting torque.

PDE2539TCUK

## P1V-M - Robust Air Motors

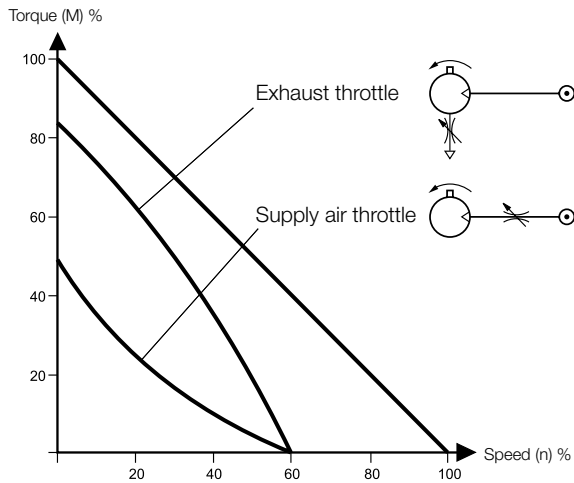

### Throttling

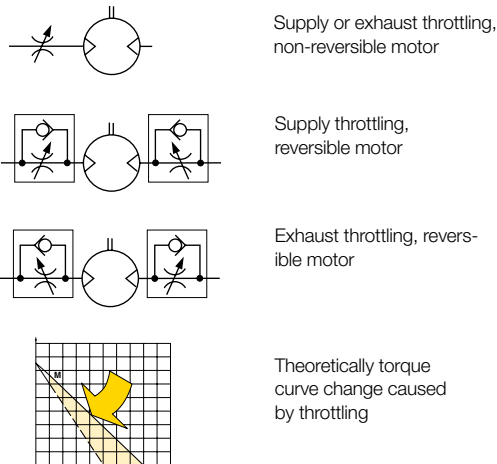

### Component choice for air supply

#### Direction of motor rotation

The direction of rotation of reversible motors is obtained by supplying inlet L or inlet R with compressed air. The motor can be stopped and started continually without damage occurring.

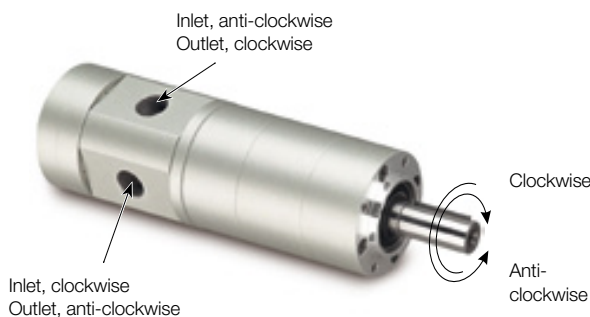

Reversible means in both directions.

### Compressed air quality

Oil and oil mist are avoided whenever possible to ensure a clean work environment. In addition, purchasing, installation and maintenance of oil equipment can be expensive. All users in all industries now try to avoid using components which have to be lubricated. The P1V air motors series are equipped with vanes for intermittent lubrication free operation as standard, which is the most common application of air motors.

### Dry unlubricated compressed air



If unlubricated compressed air is used, the compressed air should comply with the purity standards below in order to guarantee the longest possible overall service life. If the unlubricated compressed air has a high water content, condensation forms inside the motor, causing corrosion in all internal components. A ball bearing can be destroyed in a remarkably short time if it comes into contact with a single water droplet. For indoor use, we recommend ISO8573-1 purity class 3.4.1. To achieve this, compressors must be fitted with after coolers, oil filters, refrigerant air dryers and air filters. For indoor/outdoor use, we recommend ISO8573-1 purity class 1.2.1. To achieve this, compressors must be fitted with after coolers, oil filters, adsorption dryers and dust filters.

### Oil mist



If oil mist is used (approx. 1 drop of oil per m<sup>3</sup> of compressed air), the oil not only acts as a lubricant but also protects against corrosion. This means that compressed air with a certain water content may be used without causing corrosion problems inside the motor. ISO8573-1 purity class 3.-.5 may be used without difficulty. The following oils are recommended for use in the food stuffs industry: Shell Cassida Fluid HF 32 or Klüberoil 4 UH 1-32

### ISO 8573-1 purity classes

Quality class	Contaminants		Water max. pressure dew point (°C)	Oil max. concentration (mg.m <sup>3</sup> )
	particle size (µm)	max. concentration (mg/m <sup>3</sup> )		
1	0.1	0.1	-70	0.01
2	1	1	-40	0.1
3	5	5	-20	1.0
4	15	8	+3	5.0
5	40	10	+7	25
6	-	-	+10	-

For example: compressed air to purity class 3.4.3. This means a 5 µm filter (standard filter), dew point +3°C (refrigerant cooled) and an oil concentration of 1,0 mg oil/m<sup>3</sup> (as supplied by a standard compressor with a standard filter).

PDE2539TCUK

## P1V-M - Robust Air Motors

### Air supply

Since the supply pressure at the air motor inlet port is of considerable importance for obtaining the power, speed and torque quoted in the catalogue, the recommendations below should be observed.

The following data must be complied with:

- Supply pressure: 7 bar
- Regulator pressure setting: 6.7 bar
- Pipe length between air treatment unit and valve: max. 1 m
- Pipe length valve and air motor: max 2 m

The pressure drop through the air preparation unit, pipe, valve means that 6 bar pressure is obtained at the motor supply port. Please refer to the correction diagram and factors to see what lower supply pressure means for power, speed and torque.

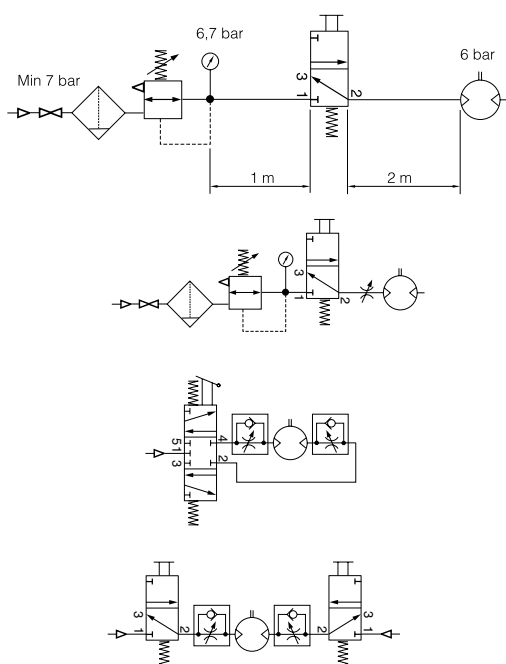

The air with which the motor is supplied must be filtered and regulated. Directional valves are needed to provide it with air, to get the motor to rotate when we want it to. These valves can be equipped with several means of actuation, such as electric, manual and pneumatic control. When the motor is used in a non-reversible application, it is sufficient to use a 2/2 or 3/2 valve function for supply. Either one 5/3 or two 3/2 valves functions are needed for a reversible motor, to ensure that the motor receives compressed air and the residual air outlet is vented. A flow control valve can be installed in the supply pipe to regulate the motor speed if the motor is not used as a reversible motor.

One flow control valve with by-pass is needed to regulate each direction of rotation if the motor is used as a reversible motor. The built-in check valve will then allow air from the residual air outlet to escape through the outlet port in the control valve. The compressed air supply must have sufficiently large pipes and valves to give the motor the maximum power. The motor needs 6 bar at the supply port all the time. For example, a reduction of pressure to 5 bar reduces the power developed to 77% and to 55% at 4 bar!

### Silencing

Exhaust silencer

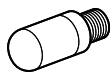

Central silencer

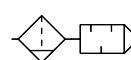

The noise from an air motor consists of both mechanical noise and a pulsating noise from the air flowing out of the outlet. The installation of the motor has a considerable effect on mechanical noise. It should be installed so that no mechanical resonance effects can occur. The outlet air creates a noise level which can amount to 115 dB(A) if the air is allowed to exhaust freely into the atmosphere. Various types of exhaust silencers are used to reduce this level. The most common type screws directly onto the exhaust port of the motor. Since the motor function causes the exhaust air to pulsate, it is a good idea to allow the air to exhaust into some kind of chamber first, which reduces the pulsations before they reach the silencer. The best silencing method is to connect a soft plastic hose to a large central silencer with the largest possible area, to reduce the speed of the out-flowing air as far as possible.

**NOTE!** Remember that if a silencer which is too small or is blocked, generates back pressure on the outlet side of the motor, which reduces the motor power.

### CE marking

The air motors are supplied as "Components for installation" – the installer is responsible for ensuring that the motors are installed safely in the overall system. Parker Pneumatic guarantees that its products are safe, and as a supplier of pneumatic equipment we ensure that the equipment is designed and manufactured in accordance with the applicable EU directive.

Most of our products are classed as components as defined by various directives, and although we guarantee that the components satisfy the fundamental safety requirements of the directives to the extent that they are our responsibility, they do not usually carry the CE mark.

The following are the currently applicable directives:

- Machinery Directive(essential health and safety requirements relating to the design and structure of machines and safety components)
- EMC Directive
- Simple Pressure Vessels Directive
- Low Voltage Directive
- ATEX Directive (ATEX = ATmosphere EXplosive)

**Torque, power and air consumption graphs**

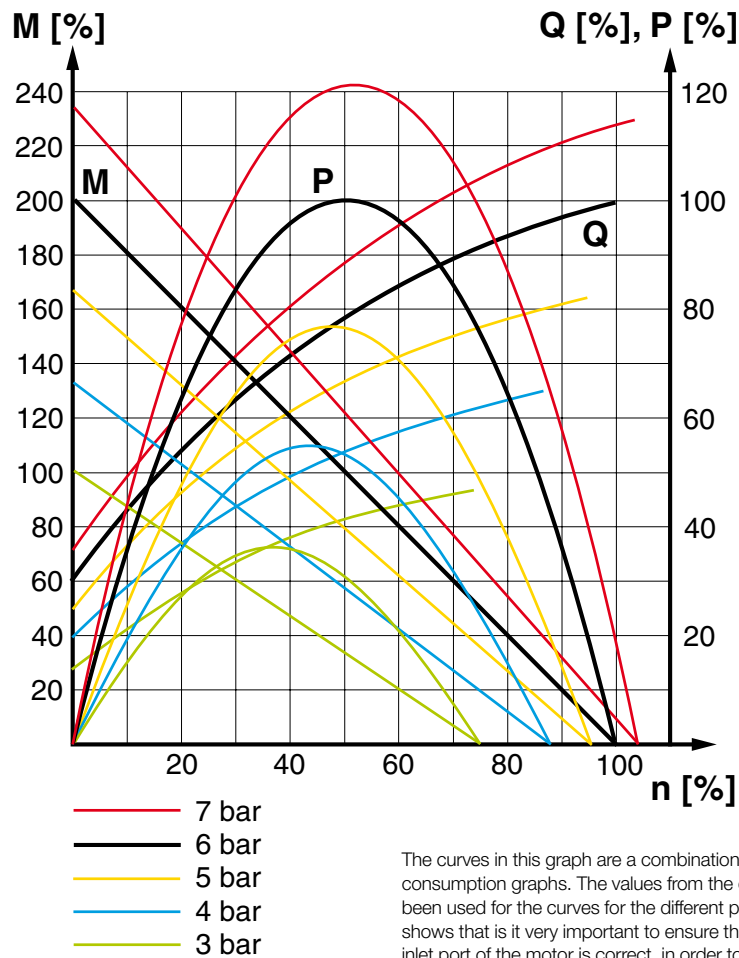

<b>P = power</b>	<b>Q = air consumption</b>
<b>M = torque</b>	<b>n = speed</b>

The curves in this graph are a combination of the torque, power and air consumption graphs. The values from the correction diagram have also been used for the curves for the different pressure values. The graph also shows that it is very important to ensure that the pressure supplied to the inlet port of the motor is correct, in order to allow the motor to work at maximum capacity. If the valve supplying a large motor is too small or if the supply line is underspecified, the pressure at the inlet port may be so low that the motor is unable to do its work. One solution would be to upgrade the valve and supply system, or alternatively you could replace the motor with a smaller motor with lower air consumption. The result would be increased pressure at the inlet port, which means that the smaller motor could carry out the necessary work. However, you may need to select a smaller motor with a lower free speed in order to obtain sufficient torque at the outgoing shaft.

**Choice of an air motor, general**

The motor to be used should be selected by starting with the torque needed at a specific spindle speed. In other words, to choose the right motor, you have to know the required speed and torque. Since maximum power is reached at half the motor's free speed, the motor should be chosen so that the point aimed at is as close as possible to the maximum power of the motor.

The design principle of the motor means that higher torque is generated when it is braked, which tends to increase the speed. This means that the motor has a kind of speed selfregulation function built in. Use the following graph to choose the correct motor size and the correct type of gear as appropriate. The graph contains the points for the maximum torque of each motor at maximum power. Put in your point on the graph and select a marked point above and to the right of the point you need.

Then check the characteristic graph of each motor to find more accurate technical data. Always select a motor where the data required is in the orange field. Also use the correction diagram to see what it would mean to use different air supply pressures or different air flow in the motor.

**Tip:** Select a motor which is slightly too fast and powerful, regulate its speed and torque with a pressure regulator and/or restriction to achieve the optimum working point.

Do you need any support to select the right air motor, please feel free to consult your local sales office.



## Specifying air quality (purity) in accordance with ISO8573-1:2010, the international standard for compressed air quality

ISO8573-1 is the primary document used from the ISO8573 series as it is this document which specifies the amount of contamination allowed in each cubic metre of compressed air.

ISO8573-1 lists the main contaminants as Solid Particulate, Water and Oil. The purity levels for each contaminant are shown separately in tabular form, however for ease of use, this document combines all three contaminants into one easy to use table.

ISO8573-1:2010 CLASS	Solid Particulate			Mass Concentration mg/m <sup>3</sup>	Water		Oil Total Oil (aerosol liquid and vapour) mg/m <sup>3</sup>
	Maximum number of particles per m <sup>3</sup>				Vapour Pressure Dewpoint	Liquid g/m <sup>3</sup>	
	0,1 - 0,5 micron	0,5 - 1 micron	1 - 5 micron				
<b>0</b>	As specified by the equipment user or supplier and more stringent than Class 1						
<b>1</b>	≤ 20 000	≤ 400	≤ 10	-	≤ -70 °C	-	0,01
<b>2</b>	≤ 400 000	≤ 6 000	≤ 100	-	≤ -40 °C	-	0,1
<b>3</b>	-	≤ 90 000	≤ 1 000	-	≤ -20 °C	-	1
<b>4</b>	-	-	≤ 10 000	-	≤ +3 °C	-	5
<b>5</b>	-	-	≤ 100 000	-	≤ +7 °C	-	-
<b>6</b>	-	-	-	≤ 5	≤ +10 °C	-	-
<b>7</b>	-	-	-	5 - 10	-	≤ 0,5	-
<b>8</b>	-	-	-	-	-	0,5 - 5	-
<b>9</b>	-	-	-	-	-	5 - 10	-
<b>X</b>	-	-	-	> 10	-	> 10	> 10

### Specifying air purity in accordance with ISO8573-1:2010

When specifying the purity of air required, the standard must always be referenced, followed by the purity class selected for each contaminant (a different purity class can be selected for each contamination if required).

An example of how to write an air quality specification is shown below:

#### ISO 8573-1:2010 Class 1.2.1

ISO 8573-1:2010 refers to the standard document and its revision, the three digits refer to the purity classifications selected for solid particulate, water and total oil. Selecting an air purity class of 1.2.1 would specify the following air quality when operating at the standard's reference conditions:

#### Class 1 - Particulate

In each cubic metre of compressed air, the particulate count should not exceed 20,000 particles in the 0.1 - 0.5 micron size range, 400 particles in the 0.5 - 1 micron size range and 10 particles in the 1 - 5 micron size range.

#### Class 2 - Water

A pressure dewpoint (PDP) of -40°C or better is required and no liquid water is allowed.

#### Class 1 - Oil

In each cubic metre of compressed air, not more than 0.01mg of oil is allowed. This is a total level for liquid oil, oil aerosol and oil vapour.

### ISO8573-1:2010 Class zero

- **Class 0 does not mean zero contamination.**
- **Class 0 requires the user and the equipment manufacturer to agree contamination levels as part of a written specification.**
- **The agreed contamination levels for a Class 0 specification should be within the measurement capabilities of the test equipment and test methods shown in ISO8573 Pt 2 to Pt 9.**
- **The agreed Class 0 specification must be written on all documentation to be in accordance with the standard.**
- **Stating Class 0 without the agreed specification is meaningless and not in accordance with the standard.**
- **A number of compressor manufacturers claim that the delivered air from their oil-free compressors is in compliance with Class 0.**
- **If the compressor was tested in clean room conditions, the contamination detected at the outlet will be minimal. Should the same compressor now be installed in typical urban environment, the level of contamination will be dependent upon what is drawn into the compressor intake, rendering the Class 0 claim invalid.**
- **A compressor delivering air to Class 0 will still require purification equipment in both the compressor room and at the point of use for the Class 0 purity to be maintained at the application.**
- **Air for critical applications such as breathing, medical, food, etc typically only requires air quality to Class 2.2.1 or Class 2.1.1.**
- **Purification of air to meet a Class 0 specification is only cost effective if carried out at the point of use.**

PDE2539TCUK

## P1V-M - Robust Air Motors

### Maximise Your Air Motor Application with the P3X Lite

The P3X Lite air preparation system is constructed from ultra light weight technopolymers instead of the traditional aluminium or zinc die cast, making it 45% lighter than conventional units.

This non-metal construction also means that the P3X Lite is corrosion free enabling it to be used in harsh industrial environments where anti freeze or aggressive synthetic oils are present.

The use of technopolymers in the design of P3X Lite has facilitated a universal body design, this has resulted in reducing the number of variants required to cover the full spectrum of applications. This can dramatically lower logistic costs and simplify stock holding for customers making the P3X Lite a very cost effective solution.



# Nano Mist

## Nano Mist Technology

### Self-Adjusting Lubricator

With conventional lubricators, only the oil volume per time unit can be adjusted. If the demand changes, the quantity move to be on one line, not split in two still remains constant.

The P3X Lite lubricator concept sets new benchmarks here. For the first time, the oil volume is automatically adjusted to the flow rate. This ensures that there is neither too little nor too much oil in the system, which leads to clear economic and ecological advantages.

In addition, with conventional systems, the distance between the lubricator and the equipment has to be less than 8 meters. With larger distances, the dispensed oil is deposited as a wall flow.

The new lubricator principle of the P3X Lite allows for distances of up to 40 meters. This opens up new scope for the design of even more efficient production systems.

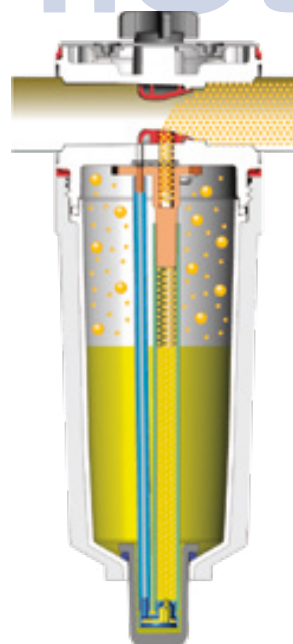

PDE2539TCUK

## P1V-M - Robust Air Motors

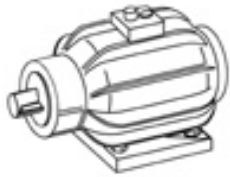

Air motors have much smaller installation dimensions than corresponding electric motors.



Air motors can be loaded until they stall, without damage. They are designed to be able to withstand the toughest heat, vibration, impact etc.



Air motors can be stopped and started continually without damage.



The simple design principle of air motors makes them very easy to service.



The weight of an air motor is several times less than corresponding electric motors.



Air motors can be used in the harshest environments.



The motors are reversible as standard.



The reliability of air motors is very high, thanks to the design and the low number of moving parts.

PDE2539TCUK

## P1V-M - Robust Air Motors

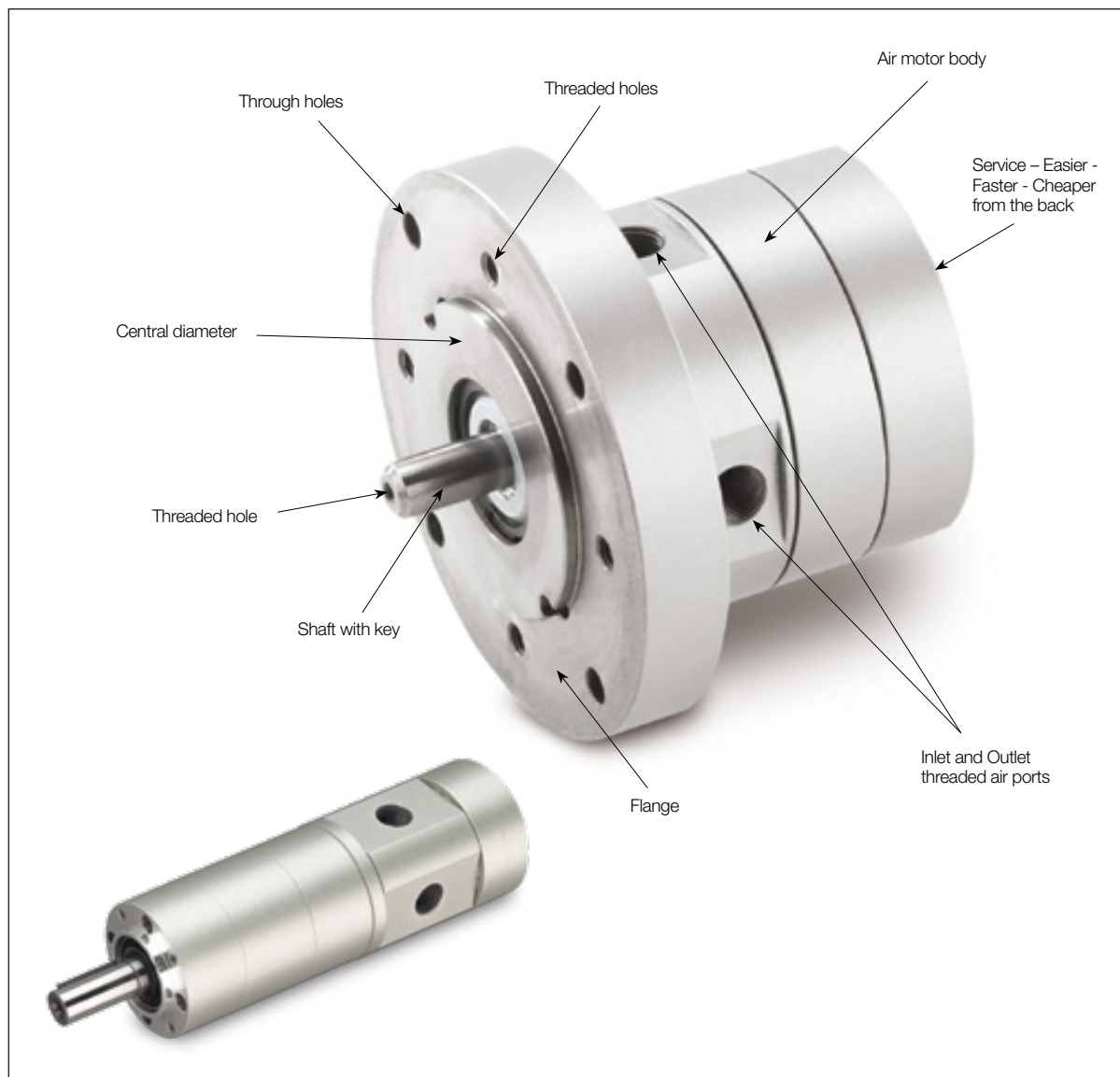

### Robust Air Motors

P1V-M is a series of air motors, with planetary gearbox and motor made of grey casted iron. Its robustness makes it suitable for all normal air motor applications.

The range contains three different sizes with power ratings of 200, 400, 600, 900 and 1200 Watts. The motor and gearbox are built to be extremely strong, making the motors suitable for applications requiring considerable robustness. The gearbox is of the planetary type, permanently lubricated with grease. The flange mounting is cast as an integral part of the case, and give, together with the foot bracket, plenty of opportunity for simple and robust installation.

A new design principle has made service activities quicker and easier than for any comparable motor. Servicing involves loosening the screws holding the rear piece to the motor, removing the worn vanes from the back and inserting the new vanes.

Unlike traditional air motors, there is no need to fully open the P1V-M for servicing, making the process much easier.

**Technical data**

**Note:** All technical data are based on a working pressure of 6 bar and with oil.  
 For oil-free performances are -10 to 15% lower than data in charts.  
 Speed tolerance accuracy in between clock and anti-clockwise directions is  $\pm 10\%$ .

Air motor size & type	P1V-M020	P1V-M040	P1V-M060	P1V-M090	P1V-M120
Nominal power (watts)	200	400	600	900	1200
Working pressure (bar)	3 to 7, 6 in explosive atmosphere				
Working temperature (°C)	-20 to +110				
Ambient temperature (°C)	-20 to +40 in explosive atmosphere				
Air flow required (NI/min)	300	600	900	2200	2600
Min pipe ID, inlet (mm)	10	12	13	13	13
Min pipe ID, outlet (mm)	10	12	13	13	13
<b>Choice of treatment unit: recommended min air flow (l/min) at p1 7.5 bar and 0.8 bar pressure drop</b>					
	330	660	990	2500	2900
<b>Choice of valve: recommended min nominal air flow (l/min) at p1 6 bar and 1 bar pressure drop</b>					
	360	720	1080	2800	3200
Medium	40µm filtered, oil mist or dry unlubricated compressed air				
Oil free operation, indoor	ISO8573-1 purity class 3.4.1				
Oil free operation, outdoor	ISO8573-1 purity class 1.2.1				
Oil operation	1-2 drop(s) per cube meter, ISO8573-1 purity class 3.-.5				
Recommended oil	Foodstuffs industry Klüber oil 4 UH1- 32 N				
Sound level free outlet (dB(A))	107	107	107	120	120
With outlet silencer (dB(A))	97	98	99	81	81

**Note:** Sound levels are measured at free speed with the measuring instrument positioned 1 meter away from the air motor at an height of 1 meter.

**Material specification**

Air motor size & type	P1V-M020	P1V-M040	P1V-M060	P1V-M090	P1V-M120
<b>Without gear box</b>					
Motor housing	Cast iron, synthetic paint, grey color				
Shaft	Hardened steel				
Key	Hardened steel				
External seal	NBR				
Internal steel parts	High grade steel				
Motor lubrication	Bearings: grease				
Vanes	Patented, no data				
<b>With gear box</b>					
Planetary gearbox	Steel / cast iron, synthetic paint, grey color				
Shaft	Hardened steel				
Key	Hardened steel				
External seal	NBR				
Internal steel parts	High grade steel				
Gearbox lubrication	Grease, Shell Cassida RLS2				



**Choice of an air motor**

Nominal torque [Nm]

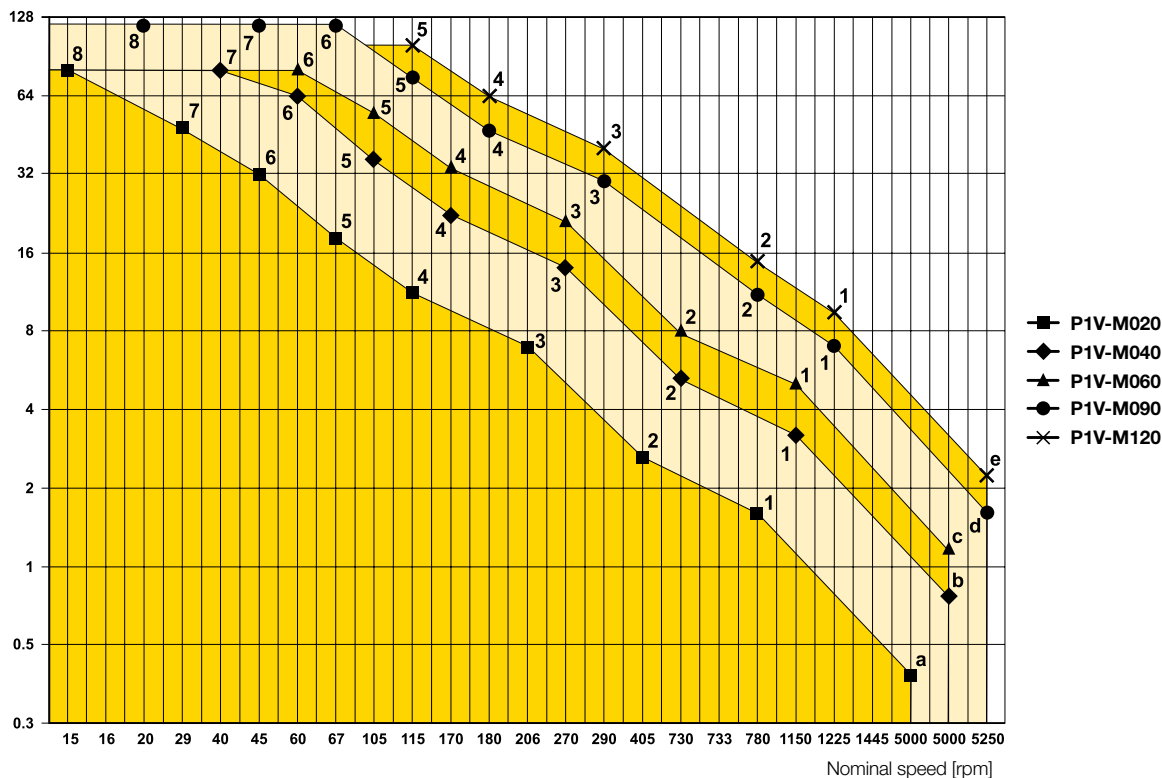

The motor to be used should be selected by starting with the torque needed at a specific shaft speed. In other words, to choose the right motor, you have to know the required speed and torque. Since maximum power is reached at half the motor's free speed, the motor should be chosen so that the operating point is as close as possible to the maximum power of the motor.

The design principle of the motor means that higher torque is generated when it is braked, which tends to increase the speed, etc. This means that the motor has a kind of speed self-regulation function built in.

Use the above graph to choose the correct motor size. The graph contains the points for the maximum torque of each motor at maximum output. Add your operating point to the graph, then select a marked point above and to the right of your point.

Then use the correct working diagram of the chosen motor to get more detailed technical data. Always select a motor whose requisite technical data are in the shaded area. Also use the correction diagram to find out what operation with different supply pressures would mean for the motor.

**Tip:** Select a motor which is slightly too fast and powerful, then regulate its speed and torque with a pressure regulator and/or throttle to achieve the optimum working point.

**Air motors in diagram above**

- |     |               |     |               |
|-----|---------------|-----|---------------|
| ■ a | P1V-M020B0A00 | ▲ 1 | P1V-M060C0230 |
| ◆ b | P1V-M040B0A00 | ▲ 2 | P1V-M060C0146 |
| ▲ c | P1V-M060B0A00 | ▲ 3 | P1V-M060C0054 |
| ● d | P1V-M090B0A00 | ▲ 4 | P1V-M060C0034 |
| X e | P1V-M120B0A00 | ▲ 5 | P1V-M060C0021 |
|     |               | ▲ 6 | P1V-M060C0012 |
| ■ 1 | P1V-M020C0230 | ● 1 | P1V-M090C0245 |
| ■ 2 | P1V-M020C0146 | ● 2 | P1V-M090C0156 |
| ■ 3 | P1V-M020C0054 | ● 3 | P1V-M090C0058 |
| ■ 4 | P1V-M020C0034 | ● 4 | P1V-M090C0036 |
| ■ 5 | P1V-M020C0021 | ● 5 | P1V-M090C0023 |
| ■ 6 | P1V-M020C0012 | ● 6 | P1V-M090C0013 |
| ■ 7 | P1V-M020C0008 | ● 7 | P1V-M090C0009 |
| ■ 8 | P1V-M020C0003 | ● 8 | P1V-M090C0004 |
| ◆ 1 | P1V-M040C0230 | X 1 | P1V-M120C0245 |
| ◆ 2 | P1V-M040C0146 | X 2 | P1V-M120C0156 |
| ◆ 3 | P1V-M040C0054 | X 3 | P1V-M120C0058 |
| ◆ 4 | P1V-M040C0034 | X 4 | P1V-M120C0036 |
| ◆ 5 | P1V-M040C0021 | X 5 | P1V-M120C0023 |
| ◆ 6 | P1V-M040C0012 |     |               |
| ◆ 7 | P1V-M040C0008 |     |               |

PDE2539TCUK

## P1V-M - Robust Air Motors

200 to 1200 Watts without gear boxes

**NOTE!** All technical data are based on a working pressure of 6 bar and with oil. For oil-free performances are -10 to 15% lower. Speed tolerance accuracy +-10%



CE II 2G Ex h IIC T4 Gb X  
 II 2D Ex h IIC T130°C Db X



### Robust motor reversible with keyed shaft, flange

Max power	Free speed*	Nominal speed	Nominal torque	Min start torque	Air consumption at max power	Conn.	Min pipe ID	Weight	Order code
kW	rpm	rpm	Nm	Nm	l/s		mm	Kg	
0,200	10 000	5 000	0,38	0,57	5	G1/8	10	1,00	<b>P1V-M020B0A00</b>
0,400	10 000	5 000	0,76	1,10	10	G3/8	12	1,40	<b>P1V-M040B0A00</b>
0,600	10 000	5 000	1,10	1,70	15	G3/8	13	1,60	<b>P1V-M060B0A00</b>
0,900	10 500	5 250	1,60	2,40	36,7	G1/2	13	3,10	<b>P1V-M090B0A00</b>
1,200	10 500	5 250	2,20	3,30	43,3	G1/2	13	3,80	<b>P1V-M120B0A00</b>

\* maximum admissible speed (idling)

#### P1V-M020B0A00

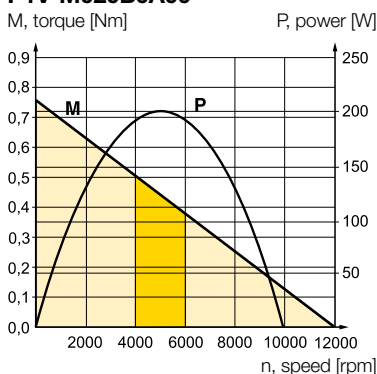

#### P1V-M040B0A00

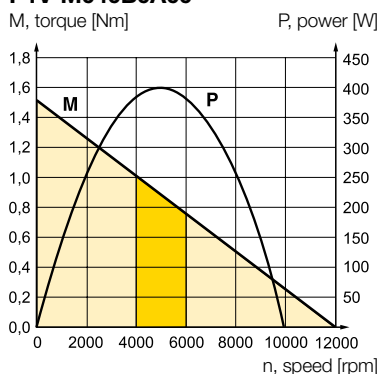

#### P1V-M060B0A00

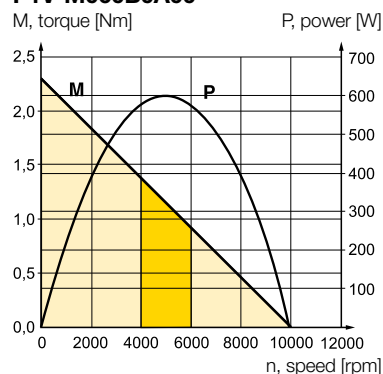

#### P1V-M090B0A00

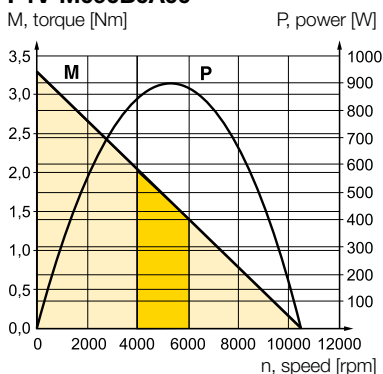

#### P1V-M120B0A00

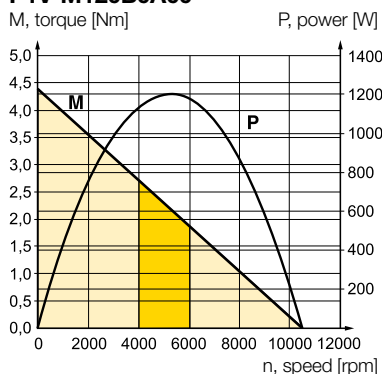

Possible working range of motor.



Optimum working range of motor.

Higher speeds = more vane wear  
 Lower speeds with high torque = more gearbox wear



PDE2539TCUK

**P1V-M - Robust Air Motors**

**200 to 1200 Watts without gear boxes**

**Dimensions (mm)**

**Motor P1V-M020B0A00**

**Motor P1V-M040B0A00**

**Motor P1V-M060B0A00**

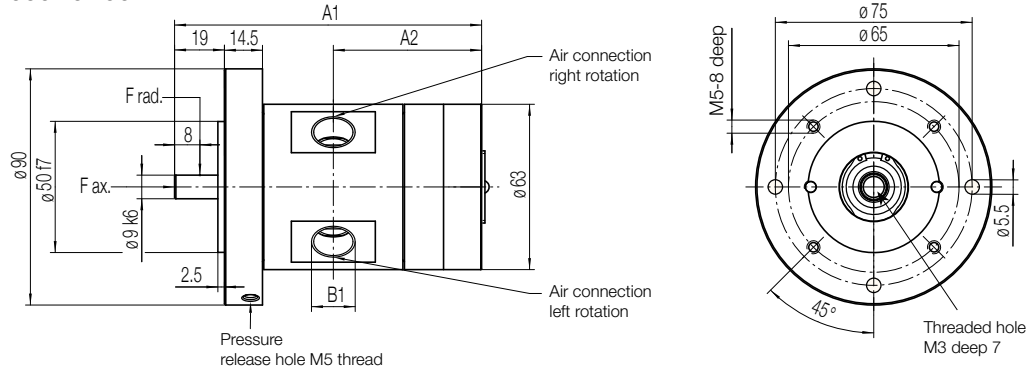

**Motor P1V-M090B0A00**

**Motor P1V-M120B0A00**

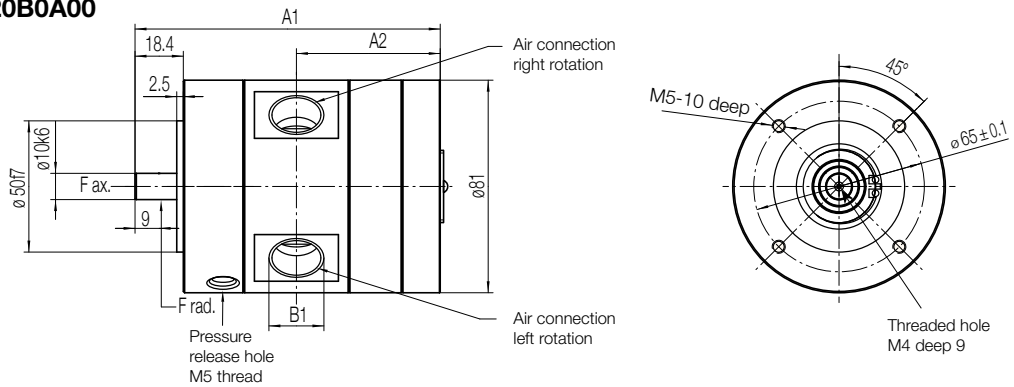

**Foot bracket P1V-MF3**

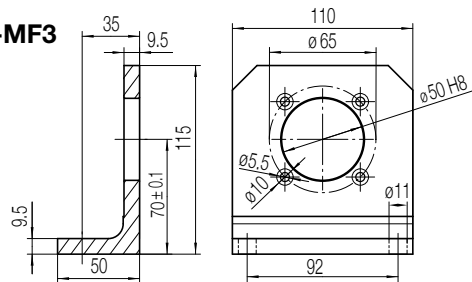

Motor type	Dimensions (mm)			Key on shaft
	A1	A2	B1	
<b>P1V-M020B0A00</b>	82	39	G1/8	DIN6885 A3x3x10
<b>P1V-M040B0A00</b>	102	49	G3/8	DIN6885 A3x3x10
<b>P1V-M060B0A00</b>	117	56.5	G3/8	DIN6885 A3x3x10
<b>P1V-M090B0A00</b>	116.3	54.8	G1/2	DIN6885 A3x3x18
<b>P1V-M120B0A00</b>	136.3	64.3	G1/2	DIN6885 A3x3x18

PDE2539TCUK

## P1V-M - Robust Air Motors

200 Watts

**NOTE!** All technical data are based on a working pressure of 6 bar and with oil. For oil-free performances are -10 to 15% lower. Speed tolerance accuracy +-10%



II 2G Ex h IIC T4 Gb X

II 2D Ex h IIC T130°C Db X



### Robust reversible motor with keyed shaft, flange

Max power	Free speed*	Nominal speed	Nominal torque	Min start torque	Air consumption at max power	Conn.	Min pipe ID	Weight	Order code
kW	rpm	rpm	Nm	Nm	l/s		mm	Kg	
0,200	2 300	1 150	1,60	2,40	5	G1/8	10	2,40	<b>P1V-M020C0230</b>
0,200	1 460	730	2,60	3,90	5	G1/8	10	2,40	<b>P1V-M020C0146</b>
0,200	540	270	7,00	10,50	5	G1/8	10	2,80	<b>P1V-M020C0054</b>
0,200	340	170	11,20	16,80	5	G1/8	10	2,80	<b>P1V-M020C0034</b>
0,200	210	105	18,20	27,30	5	G1/8	10	2,80	<b>P1V-M020C0021</b>
0,200	120	60	31,80	47,70	5	G1/8	10	3,20	<b>P1V-M020C0012</b>
0,200	80	40	47,80	71,70	5	G1/8	10	3,20	<b>P1V-M020C0008</b>
0,200	32	16	80**	80**	5	G1/8	10	3,20	<b>P1V-M020C0003</b>

\* maximum admissible speed (idling) / \*\* gear box restriction

#### P1V-M020C0230

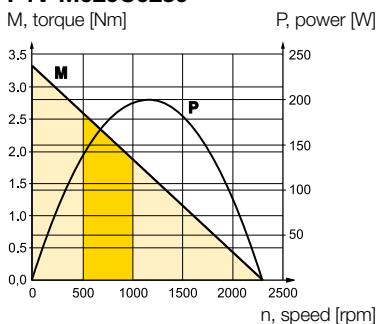

#### P1V-M020C0146

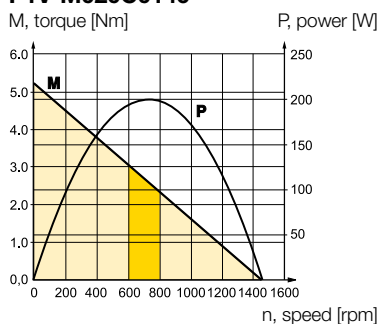

#### P1V-M020C0054

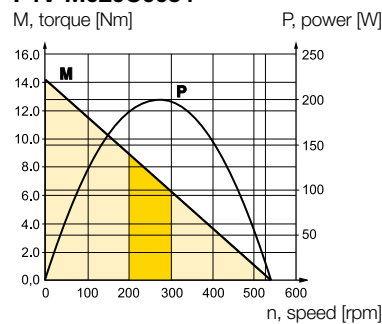

#### P1V-M020C0034

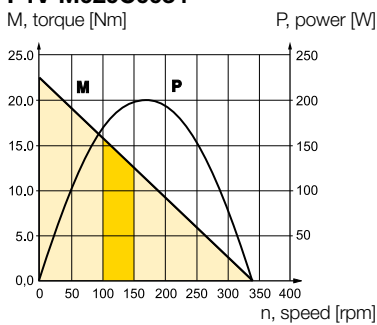

#### P1V-M020C0021

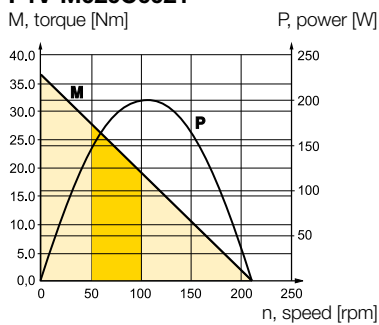

#### P1V-M020C0012

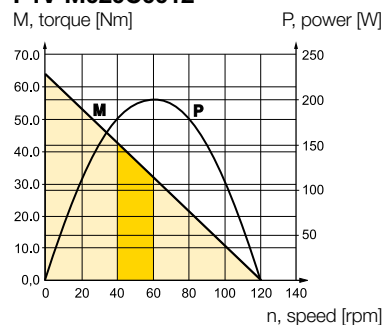

#### P1V-M020C0008

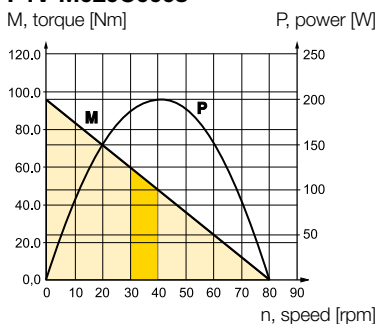

#### P1V-M020C0003

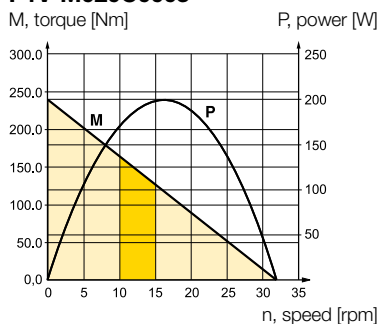

Possible working range of motor.

Optimum working range of motor.  
Higher speeds = more vane wear  
Lower speeds with high torque = more gearbox wear



**Dimensions (mm)**

**Motor P1V-M020C**

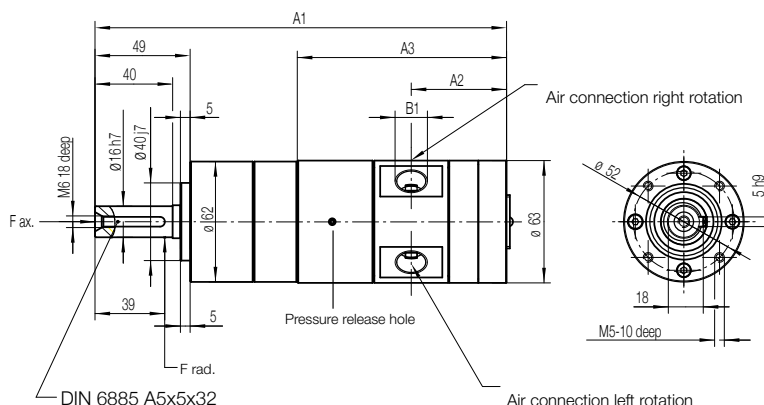

Motors have 2 or 3 openings at the outside of the gearbox which must stay open in order to guarantee troublefree operation.

**Foot bracket**

**P1V-MF4**

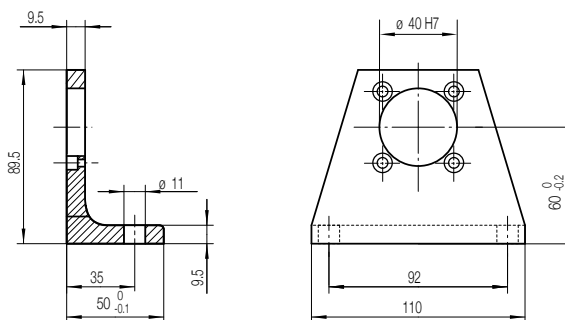

**Flanges**

**P1V-MF8, P1V-MF9**

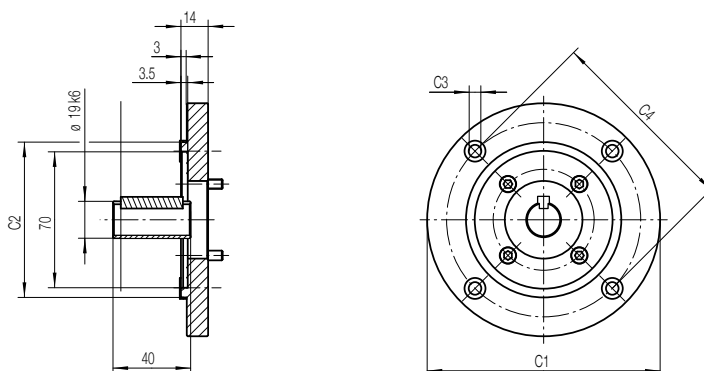

Motor size				Dimensions (mm)			
				A1	A2	A3	B1
200 watts	<b>P1V-M020C0230</b>	<b>P1V-M020C0034</b>		192.5	39	88	G1/8
	<b>P1V-M020C0146</b>	<b>P1V-M020C0021</b>	<b>P1V-M020C0008</b>	208.5	39	88	G1/8
	<b>P1V-M020C0054</b>	<b>P1V-M020C0012</b>	<b>P1V-M020C0003</b>	224	39	88	G1/8

Motor type	Dimensions (mm)				
	C1	C2	C3	C4	
P1V-M020C	<b>(IEC80 B5) P1V-MF9</b>	200	130f7	11	165
	<b>(IEC80 B14) P1V-MF8</b>	120	80f7	M6	100



PDE2539TCUK

# P1V-M - Robust Air Motors

400 Watts

**NOTE!** All technical data are based on a working pressure of 6 bar and with oil. For oil-free performances are -10 to 15% lower. Speed tolerance accuracy +-10%



II 2G Ex h IIC T4 Gb X  
 II 2D Ex h IIIC T130°C Db X

## Robust reversible motor with keyed shaft, flange

Max power	Free speed*	Nominal speed	Nominal torque	Min start torque	Air consumption at max power	Conn.	Min pipe ID	Weight	Order code
kW	rpm	rpm	Nm	Nm	l/s		mm	Kg	
0,400	2 300	1 150	3,20	4,80	10	G3/8	12	2,80	<b>P1V-M040C0230</b>
0,400	1 460	730	5,20	7,80	10	G3/8	12	2,80	<b>P1V-M040C0146</b>
0,400	540	270	14,00	21,00	10	G3/8	12	3,20	<b>P1V-M040C0054</b>
0,400	340	170	22,40	33,60	10	G3/8	12	3,20	<b>P1V-M040C0034</b>
0,400	210	105	36,40	54,60	10	G3/8	12	3,20	<b>P1V-M040C0021</b>
0,400	120	60	63,60	80**	10	G3/8	12	3,60	<b>P1V-M040C0012</b>
0,400	80	40	80**	80**	10	G3/8	12	3,60	<b>P1V-M040C0008</b>

\* maximum admissible speed (idling) / \*\* gear box restriction

### P1V-M040C0230

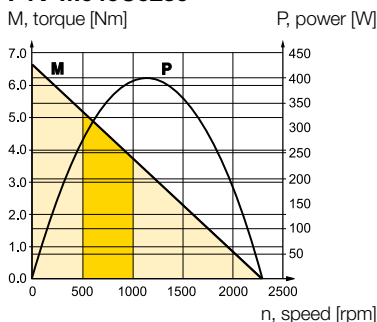

### P1V-M040C0146

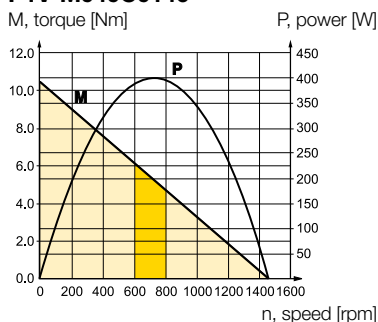

### P1V-M040C0054

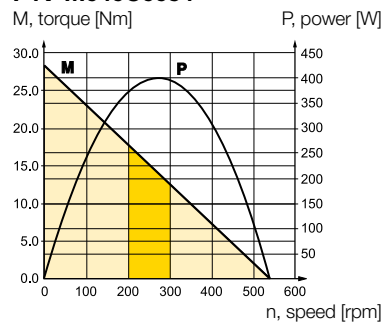

### P1V-M040C0034

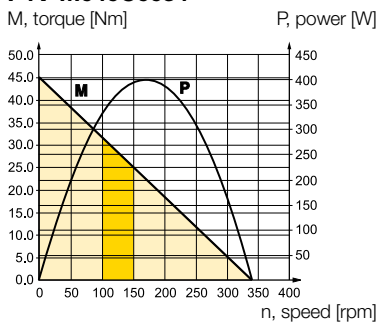

### P1V-M040C0021

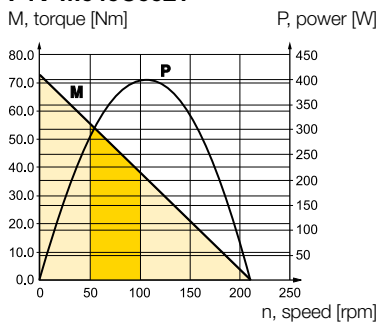

### P1V-M040C0012

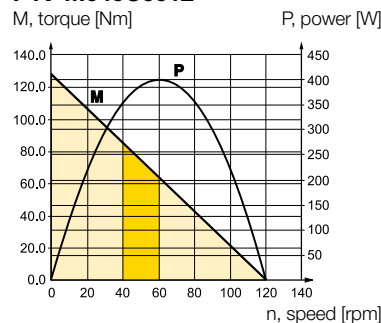

### P1V-M040C0008

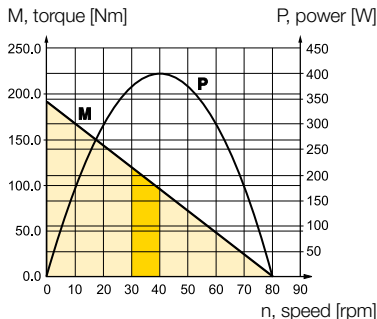

Possible working range of motor.

Optimum working range of motor.  
 Higher speeds = more vane wear  
 Lower speeds with high torque = more gearbox wear





PDE2539TCUK

## P1V-M - Robust Air Motors

600 Watts

**NOTE!** All technical data are based on a working pressure of 6 bar and with oil. For oil-free performances are -10 to 15% lower. Speed tolerance accuracy +-10%



CE  $\text{Ex}$  II 2G Ex h IIC T4 Gb X  
 $\text{Ex}$  II 2D Ex h IIIC T130°C Db X



### Robust reversible motor with keyed shaft, flange

Max power	Free speed*	Nominal speed	Nominal torque	Min start torque	Air consumption at max power	Conn.	Min pipe ID	Weight	Order code
kW	rpm	rpm	Nm	Nm	l/s		mm	Kg	
0,600	2 300	1 150	5,00	7,50	15	G3/8	13	3,00	<b>P1V-M060C0230</b>
0,600	1 460	730	7,80	11,70	15	G3/8	13	3,00	<b>P1V-M060C0146</b>
0,600	540	270	21,00	31,50	15	G3/8	13	3,40	<b>P1V-M060C0054</b>
0,600	340	170	33,60	50,40	15	G3/8	13	3,40	<b>P1V-M060C0034</b>
0,600	210	105	54,50	80**	15	G3/8	13	3,40	<b>P1V-M060C0021</b>
0,600	120	60	80**	80**	15	G3/8	13	3,80	<b>P1V-M060C0012</b>

\* maximum admissible speed (idling) / \*\* gear box restriction

#### P1V-M060C0230

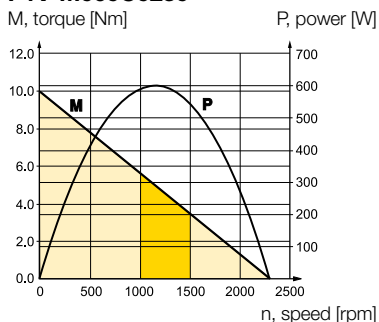

#### P1V-M060C0146

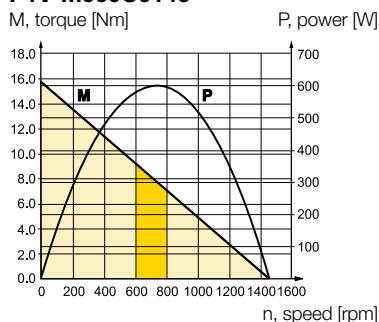

#### P1V-M060C0054

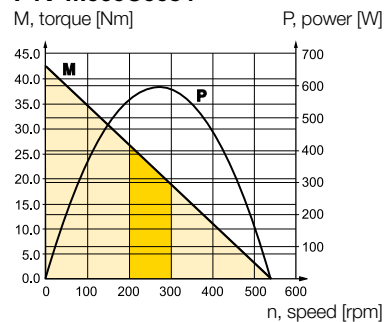

#### P1V-M060C0034

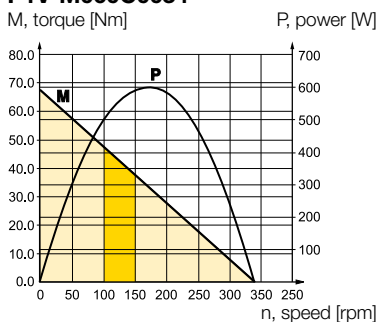

#### P1V-M060C0021

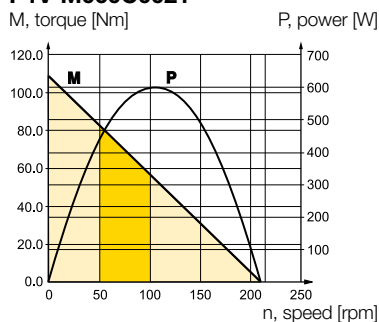

#### P1V-M060C0012

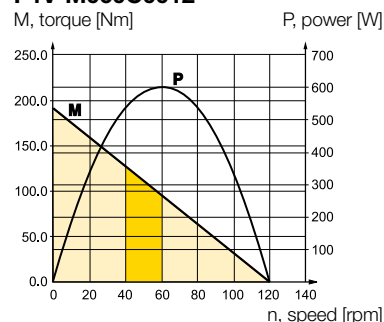

Possible working range of motor.

Optimum working range of motor.  
 Higher speeds = more vane wear  
 Lower speeds with high torque = more gearbox wear





PDE2539TCUK

## P1V-M - Robust Air Motors

900 Watts

**NOTE!** All technical data are based on a working pressure of 6 bar and with oil. For oil-free performances are -10 to 15% lower. Speed tolerance accuracy +-10%



CE II 2G Ex h IIC T4 Gb X  
 II 2D Ex h IIIC T130°C Db X



### Robust motor reversible with keyed shaft, flange

Max power	Free speed*	Nominal speed	Nominal torque	Min start torque	Air consumption at max power	Conn.	Min pipe ID	Weight	Order code
kW	rpm	rpm	Nm	Nm	l/s		mm	Kg	
0,900	2 450	1 225	7,00	10,50	36,7	G1/2	13	4,90	<b>P1V-M090C0245</b>
0,900	1 560	780	11,00	16,50	36,7	G1/2	13	4,90	<b>P1V-M090C0156</b>
0,900	580	290	30,00	45,00	36,7	G1/2	13	5,60	<b>P1V-M090C0058</b>
0,900	360	180	47,00	71,00	36,7	G1/2	13	5,60	<b>P1V-M090C0036</b>
0,900	230	115	75,00	112,00	36,7	G1/2	13	5,60	<b>P1V-M090C0023</b>
0,900	134	67	120**	120**	36,7	G1/2	13	6,30	<b>P1V-M090C0013</b>
0,900	90	45	120**	120**	36,7	G1/2	13	6,30	<b>P1V-M090C0009</b>
0,900	40	20	120**	120**	36,7	G1/2	13	6,30	<b>P1V-M090C0004</b>

\* maximum admissible speed (idling) / \*\* gear box restriction

#### P1V-M090C0245

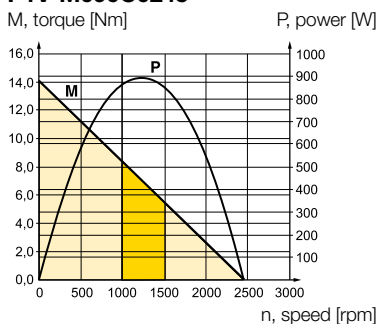

#### P1V-M090C0156

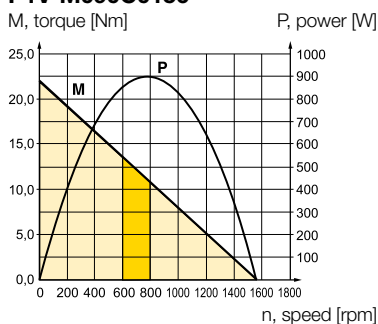

#### P1V-M090C0058

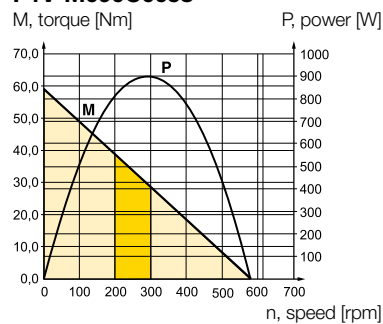

#### P1V-M090C0036

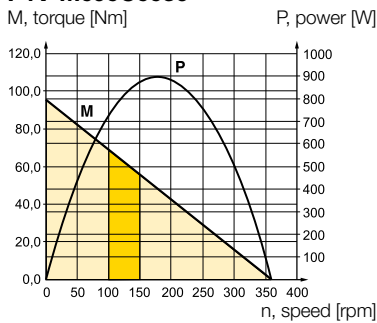

#### P1V-M090C0023

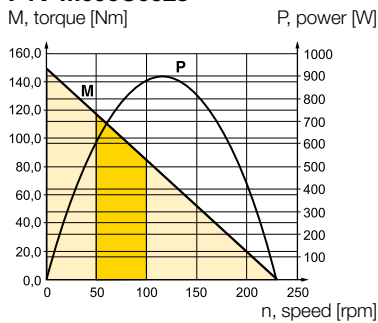

#### P1V-M090C0013

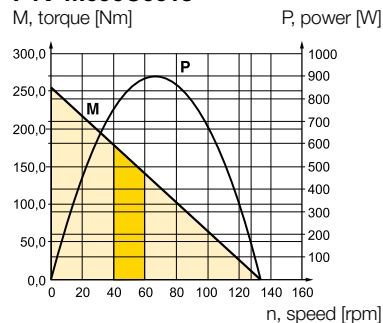

#### P1V-M090C0009

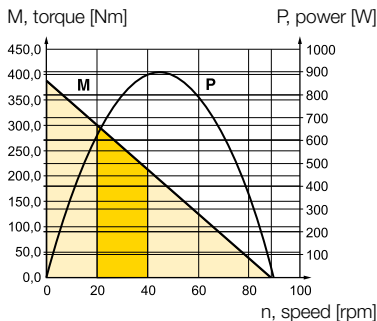

#### P1V-M090C0004

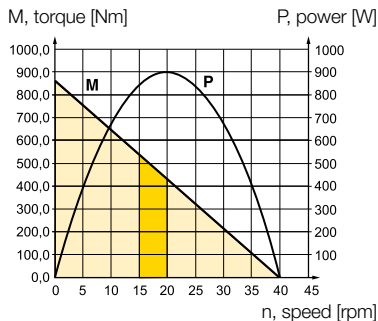

Possible working range of motor.

Optimum working range of motor.

Higher speeds = more vane wear  
 Lower speeds with high torque = more gearbox wear



PDE2539TCUK

**P1V-M - Robust Air Motors**

**900 Watts**

**Dimensions (mm)**

**Motor P1V-M090C**

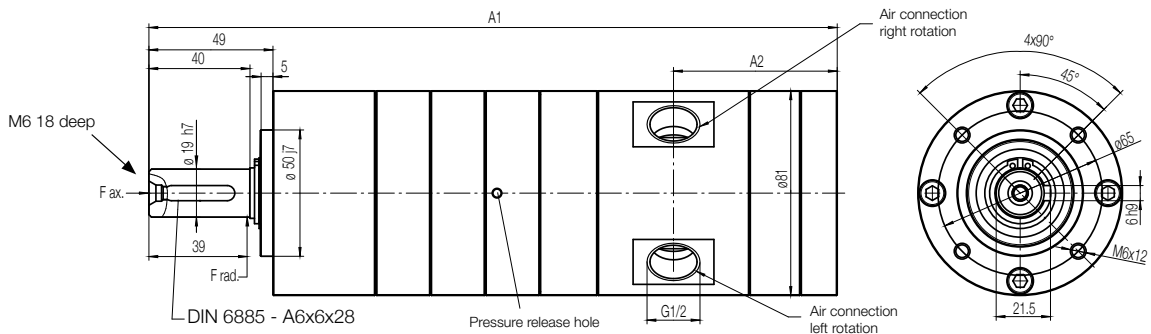

Motors have 2 or 3 openings at the outside of the gearbox which must stay open in order to guarantee troublefree operation.

**Foot bracket**

**P1V-MF5**

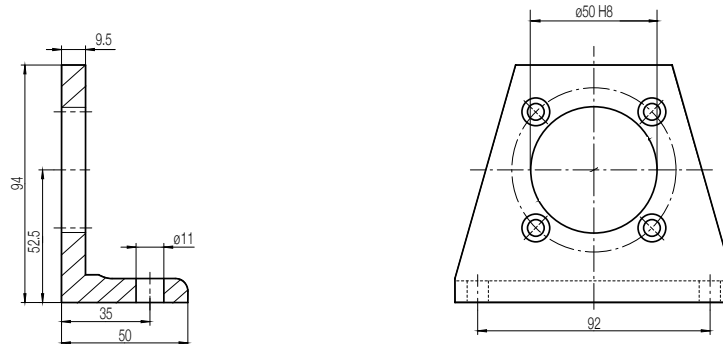

**Flanges**

**P1V-MF6, P1V-MF7**

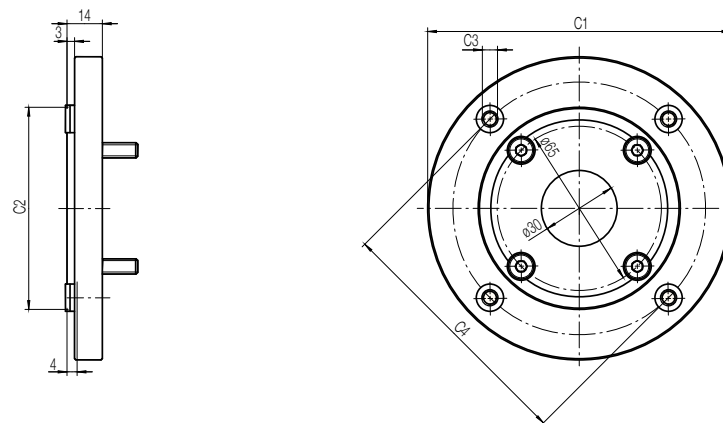

Motor size				Dimensions (mm)	
				A1	A2
900 watts	<b>P1V-M090C0245</b>	<b>P1V-M090C0156</b>		209	55
	<b>P1V-M090C0058</b>	<b>P1V-M090C0036</b>	<b>P1V-M090C0023</b>	231	55
	<b>P1V-M090C0013</b>	<b>P1V-M090C0009</b>	<b>P1V-M090C0004</b>	252.5	55

Motor type					Dimensions (mm)			
					C1	C2	C3	C4
P1V-M090C	<b>(IEC80 B5) P1V-MF7</b>				200	130f7	11	165
	<b>(IEC80 B14) P1V-MF6</b>				120	80f7	M6	100



PDE2539TCUK

## P1V-M - Robust Air Motors

1200 Watts

**NOTE!** All technical data are based on a working pressure of 6 bar and with oil. For oil-free performances are -10 to 15% lower. Speed tolerance accuracy +-10%

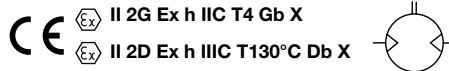

### Robust motor reversible with keyed shaft, flange

Max power	Free speed*	Nominal speed	Nominal torque	Min start torque	Air consumption at max power	Conn.	Min pipe ID	Weight	Order code
kW	rpm	rpm	Nm	Nm	l/s		mm	Kg	
1,20	2 450	1 225	9,40	14,00	43,3	G1/2	13	5,60	<b>P1V-M120C0245</b>
1,20	1 560	780	14,70	22,00	43,3	G1/2	13	5,60	<b>P1V-M120C0156</b>
1,20	580	290	40,00	60,00	43,3	G1/2	13	6,30	<b>P1V-M120C0058</b>
1,20	360	180	63,00	94,00	43,3	G1/2	13	6,30	<b>P1V-M120C0036</b>
1,20	230	115	100,00	120**	43,3	G1/2	13	6,30	<b>P1V-M120C0023</b>

\* maximum admissible speed (idling) / \*\* gear box restriction

#### P1V-M120C0245

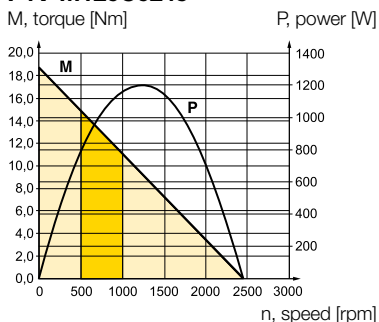

#### P1V-M120C0156

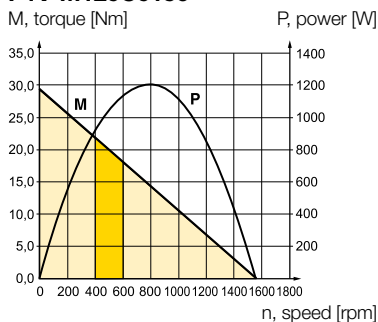

#### P1V-M120C0058

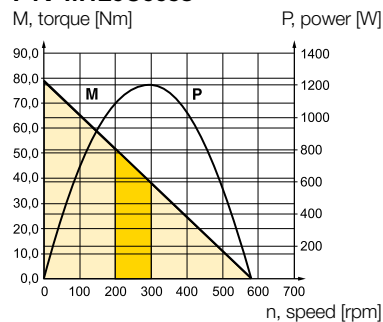

#### P1V-M120C0036

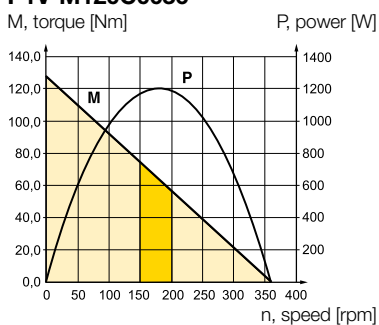

#### P1V-M120C0023

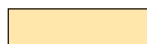
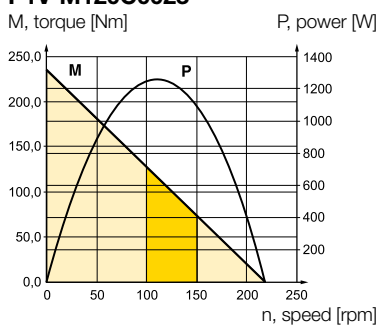

Possible working range of motor.



Optimum working range of motor.

Higher speeds = more vane wear  
Lower speeds with high torque = more gearbox wear





**Permissible forces air motors with gear boxes**

Max. permitted load on output shaft for basic motors (based on 10,000 rpm at input shaft with 90 % probable service life for ball bearings).

a (mm)	Radial force (N)	Axial force (N)
<b>Motors P1V-M020C0230, P1V-M020C0146</b>		
39	240	50
<b>Motors P1V-M020C0054, P1V-M020C0034, P1V-M020C0021</b>		
39	360	70
<b>Motors P1V-M020C0012, P1V-M020C0008, P1V-M020C0003</b>		
39	520	120

<b>Motors P1V-M040C0230, P1V-M040C0146</b>		
39	240	50
<b>Motors P1V-M040C0054, P1V-M040C0034, P1V-M040C0021</b>		
39	360	70
<b>Motors P1V-M040C0012, P1V-M040C0008</b>		
39	520	120

<b>Motors P1V-M060C0230, P1V-M060C0146</b>		
39	240	50
<b>Motors P1V-M060C0054, P1V-M060C0034, P1V-M060C0021</b>		
39	360	70
<b>Motors P1V-M060C0012</b>		
39	520	120

<b>Motors P1V-M090C0245, P1V-M090C0156</b>		
39	400	80
<b>Motors P1V-M090C0058, P1V-M090C0036, P1V-M090C0023</b>		
39	600	120
<b>Motors P1V-M090C0013, P1V-M090C0009, P1V-M090C0004</b>		
39	1000	200

<b>Motors P1V-M120C0245, P1V-M120C0156</b>		
39	400	80
<b>Motors P1V-M120C0058, P1V-M120C0036, P1V-M120C0023</b>		
39	600	120

**Permissible forces air motors without gear boxes**

	a (mm)	Radial force (N)	Axial force (N)
<b>P1V-M020B</b>	8	145	0
<b>P1V-M040B</b>	8	145	0
<b>P1V-M060B</b>	8	145	0
<b>P1V-M090B</b>	9	145	0
<b>P1V-M120B</b>	9	145	0

Frad = Radial loading (N)

Fax = Axial loading (N)

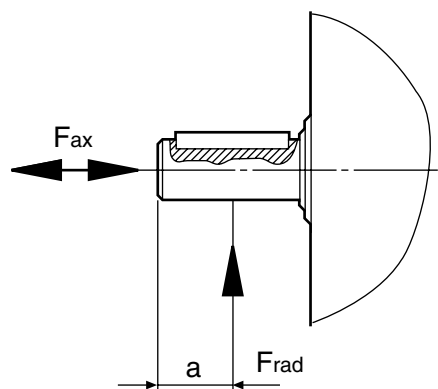

Loads on output shaft for basic motor with shaft with key slot.

**Order key**

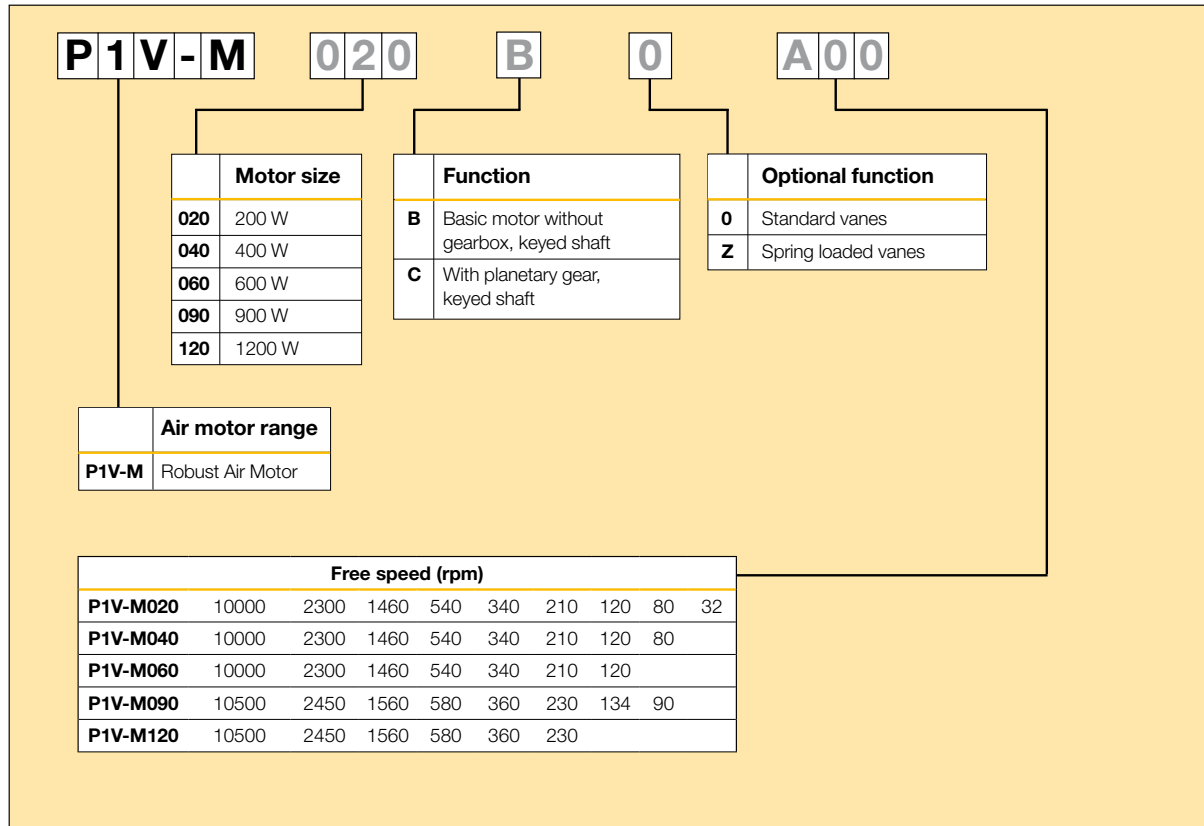

**Note :** This model code can not be used for creating new part numbers. All possible combinations between motor size, function and free speed are in all previous pages except for optional function.

PDE2539TCUK

## P1V-M - Robust Air Motors

200 to 1200 Watts

### Service – Easier - Faster - Cheaper

Replacing vanes - step by step.

#### Step 1.

Remove the rear piece.



#### Step 2.

Remove the inspection plug.



#### Step 3.

Use a screwdriver to rotate the motor until you can see a vane in the centre of the inspection hole.



#### Step 4.

Remove the old vane and replace it with a new one.

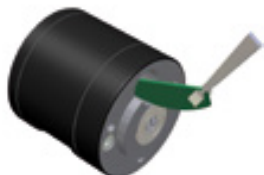

Repeat steps 3 and 4 until all the vanes have been replaced.

#### Step 5.

Replace the inspection plug.

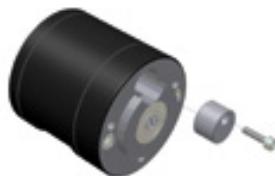

#### Step 6.

Replace the rear piece.

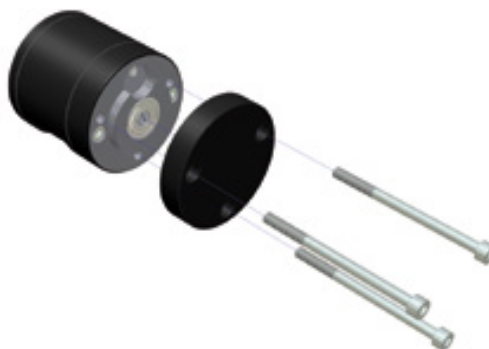

#### Replacing vanes with motor still fitted to the machine

The P1V-M motor has been developed to allow the vanes to be replaced without the need to remove the motor from the machine. This makes vane replacement easier, quicker and cheaper, while minimising stoppages.

PDE2539TCUK

## P1V-M - Robust Air Motors

200 to 1200 Watts

### Lubrication and service life

The first service is due after approximately 500 hours of operation. After the first service, the service interval is determined by the degree of vane wear\*. The table below shows new dimensions and the minimum dimensions of worn vanes.

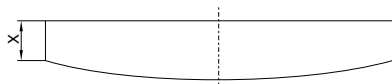

Air motors	Dimensions on new vanes X [mm]	Minimum dimensions on vane X [mm]
<b>P1V-M020</b>	8,5	6,5
<b>P1V-M040</b>	7,0	5,0
<b>P1V-M060</b>	8,0	6,0
<b>P1V-M090</b>	X	X
<b>P1V-M120</b>	X	X

### Spare parts

For motor with Z optional function, please consult factory

Spare parts Order Code		
Motor	Air Motor (1)	Gear Box (2)
P1V-M020C0230	<b>P1V-M/202193A</b>	<b>P1V-M/202202B</b>
P1V-M020C0146	<b>P1V-M/202193A</b>	<b>P1V-M/202202D</b>
P1V-M020C0054	<b>P1V-M/202193A</b>	<b>P1V-M/202202G</b>
P1V-M020C0034	<b>P1V-M/202193B</b>	<b>P1V-M/202202C</b>
P1V-M020C0021	<b>P1V-M/202193B</b>	<b>P1V-M/202202E</b>
P1V-M020C0012	<b>P1V-M/202193B</b>	<b>P1V-M/202202F</b>
P1V-M020C0008	<b>P1V-M/202193B</b>	<b>P1V-M/202202H</b>
P1V-M020C0003	<b>P1V-M/202193B</b>	<b>P1V-M/202202I</b>
<b>Motor</b>	<b>Air Motor (1)</b>	<b>Gear Box (2)</b>
P1V-M040C0230	<b>P1V-M/202194A</b>	<b>P1V-M/202202B</b>
P1V-M040C0146	<b>P1V-M/202194A</b>	<b>P1V-M/202202D</b>
P1V-M040C0054	<b>P1V-M/202194A</b>	<b>P1V-M/202202G</b>
P1V-M040C0034	<b>P1V-M/202194B</b>	<b>P1V-M/202202C</b>
P1V-M040C0021	<b>P1V-M/202194B</b>	<b>P1V-M/202202E</b>
P1V-M040C0012	<b>P1V-M/202194B</b>	<b>P1V-M/202202F</b>
P1V-M040C0008	<b>P1V-M/202194B</b>	<b>P1V-M/202202H</b>
<b>Motor</b>	<b>Air Motor (1)</b>	<b>Gear Box (2)</b>
P1V-M060C0230	<b>P1V-M/202179A</b>	<b>P1V-M/202202B</b>
P1V-M060C0146	<b>P1V-M/202179A</b>	<b>P1V-M/202202D</b>
P1V-M060C0054	<b>P1V-M/202179A</b>	<b>P1V-M/202202G</b>
P1V-M060C0034	<b>P1V-M/202179B</b>	<b>P1V-M/202202C</b>
P1V-M060C0021	<b>P1V-M/202179B</b>	<b>P1V-M/202202E</b>
P1V-M060C0012	<b>P1V-M/202179B</b>	<b>P1V-M/202202F</b>
<b>Motor</b>	<b>Air Motor (1)</b>	<b>Gear Box (2)</b>
P1V-M090C0245	<b>P1V-M/202409A</b>	<b>P1V-M/807015B</b>
P1V-M090C0156	<b>P1V-M/202409B</b>	<b>P1V-M/807015C</b>
P1V-M090C0058	<b>P1V-M/202409A</b>	<b>P1V-M/807015D</b>
P1V-M090C0036	<b>P1V-M/202409B</b>	<b>P1V-M/807015E</b>
P1V-M090C0023	<b>P1V-M/202409B</b>	<b>P1V-M/807015F</b>
P1V-M090C0013	<b>P1V-M/202409A</b>	<b>P1V-M/807015G</b>
P1V-M090C0009	<b>P1V-M/202409B</b>	<b>P1V-M/807015H</b>
P1V-M090C0004	<b>P1V-M/202409B</b>	<b>P1V-M/807015I</b>
<b>Motor</b>	<b>Air Motor (1)</b>	<b>Gear Box (2)</b>
P1V-M120C0245	<b>P1V-M/202457A</b>	<b>P1V-M/807015B</b>
P1V-M120C0156	<b>P1V-M/202457B</b>	<b>P1V-M/807015C</b>
P1V-M120C0058	<b>P1V-M/202457A</b>	<b>P1V-M/807015D</b>
P1V-M120C0036	<b>P1V-M/202457B</b>	<b>P1V-M/807015E</b>
P1V-M120C0023	<b>P1V-M/202457B</b>	<b>P1V-M/807015F</b>

### Service kits

The following kits are available for the basic motors, consisting of vanes.



#### Service kits, vanes for intermittent lubrication operation, option "0"

For motors	Order code
P1V-M020	<b>P1V-6/4462971A</b>
P1V-M040	<b>P1V-6/4462981A</b>
P1V-M060	<b>P1V-6/4462991A</b>
P1V-M090	<b>P1V-6/4449171A</b>
P1V-M120	<b>P1V-6/4449181A</b>

The following kits are available for the basic motors, consisting of vanes and springs.



#### Service kits, vanes for intermittent lubrication operation, option "Z"

For motors	Order code
P1V-M020	<b>P1V-6/4449144B</b>
P1V-M040	<b>P1V-6/4449154B</b>
P1V-M060	<b>P1V-6/4449164B</b>
P1V-M090	<b>P1V-6/4449174B</b>
P1V-M120	<b>P1V-6/4449184B</b>

\* The following normal service intervals should be applied to in order to guarantee problem-free operation in air motors working at load speeds. The specified hours of operation apply when the motor is running at the speed corresponding to maximum power (load speed). This is approximately half free speed. If the motor operates at higher speeds, the service interval is shorter. If the motor operates at lower speeds, the service interval is longer.



# Parker Worldwide

## Europe, Middle East, Africa

### AE – United Arab Emirates,

Dubai  
Tel: +971 4 8127100  
parker.me@parker.com

### AT – Austria, Wiener Neustadt

Tel: +43 (0)2622 23501-0  
parker.austria@parker.com

### AT – Eastern Europe, Wiener Neustadt

Tel: +43 (0)2622 23501 900  
parker.easteurope@parker.com

### AZ – Azerbaijan, Baku

Tel: +994 50 2233 458  
parker.azerbaijan@parker.com

### BE/LU – Belgium, Nivelles

Tel: +32 (0)67 280 900  
parker.belgium@parker.com

### BY – Belarus, Minsk

Tel: +375 17 209 9399  
parker.belarus@parker.com

### CH – Switzerland, Etoy

Tel: +41 (0)21 821 87 00  
parker.switzerland@parker.com

### CZ – Czech Republic, Klecany

Tel: +420 284 083 111  
parker.czechrepublic@parker.com

### DE – Germany, Kaarst

Tel: +49 (0)2131 4016 0  
parker.germany@parker.com

### DK – Denmark, Ballerup

Tel: +45 43 56 04 00  
parker.denmark@parker.com

### ES – Spain, Madrid

Tel: +34 902 330 001  
parker.spain@parker.com

### FI – Finland, Vantaa

Tel: +358 (0)20 753 2500  
parker.finland@parker.com

### FR – France, Contamine s/Arve

Tel: +33 (0)4 50 25 80 25  
parker.france@parker.com

### GR – Greece, Athens

Tel: +30 210 933 6450  
parker.greece@parker.com

### HU – Hungary, Budapest

Tel: +36 23 885 475  
parker.hungary@parker.com

### IE – Ireland, Dublin

Tel: +353 (0)1 466 6370  
parker.ireland@parker.com

### IT – Italy, Corsico (MI)

Tel: +39 02 45 19 21  
parker.italy@parker.com

### KZ – Kazakhstan, Almaty

Tel: +7 7272 505 800  
parker.easteurope@parker.com

### NL – The Netherlands, Oldenzaal

Tel: +31 (0)541 585 000  
parker.nl@parker.com

### NO – Norway, Asker

Tel: +47 66 75 34 00  
parker.norway@parker.com

### PL – Poland, Warsaw

Tel: +48 (0)22 573 24 00  
parker.poland@parker.com

### PT – Portugal, Leca da Palmeira

Tel: +351 22 999 7360  
parker.portugal@parker.com

### RO – Romania, Bucharest

Tel: +40 21 252 1382  
parker.romania@parker.com

### RU – Russia, Moscow

Tel: +7 495 645-2156  
parker.russia@parker.com

### SE – Sweden, Spånga

Tel: +46 (0)8 59 79 50 00  
parker.sweden@parker.com

### SK – Slovakia, Banská Bystrica

Tel: +421 484 162 252  
parker.slovakia@parker.com

### SL – Slovenia, Novo Mesto

Tel: +386 7 337 6650  
parker.slovenia@parker.com

### TR – Turkey, Istanbul

Tel: +90 216 4997081  
parker.turkey@parker.com

### UA – Ukraine, Kiev

Tel: +380 44 494 2731  
parker.ukraine@parker.com

### UK – United Kingdom, Warwick

Tel: +44 (0)1926 317 878  
parker.uk@parker.com

### ZA – South Africa, Kempton Park

Tel: +27 (0)11 961 0700  
parker.southafrica@parker.com

## North America

### CA – Canada, Milton, Ontario

Tel: +1 905 693 3000

### US – USA, Cleveland

Tel: +1 216 896 3000

## Asia Pacific

### AU – Australia, Castle Hill

Tel: +61 (0)2-9634 7777

### CN – China, Shanghai

Tel: +86 21 2899 5000

### HK – Hong Kong

Tel: +852 2428 8008

### IN – India, Mumbai

Tel: +91 22 6513 7081-85

### JP – Japan, Tokyo

Tel: +81 (0)3 6408 3901

### KR – South Korea, Seoul

Tel: +82 2 559 0400

### MY – Malaysia, Shah Alam

Tel: +60 3 7849 0800

### NZ – New Zealand, Mt Wellington

Tel: +64 9 574 1744

### SG – Singapore

Tel: +65 6887 6300

### TH – Thailand, Bangkok

Tel: +662 186 7000

### TW – Taiwan, Taipei

Tel: +886 2 2298 8987

## South America

### AR – Argentina, Buenos Aires

Tel: +54 3327 44 4129

### BR – Brazil, Sao Jose dos Campos

Tel: +55 800 727 5374

### CL – Chile, Santiago

Tel: +56 2 623 1216

### MX – Mexico, Apodaca

Tel: +52 81 8156 6000

### European Product Information Centre

Free phone: 00 800 27 27 5374

(from AT, BE, CH, CZ, DE, DK, EE, ES, FI, FR, IE, IL, IS, IT, LU, MT, NL, NO, PL, PT, RU, SE, SK, UK, ZA)



### Parker Hannifin Ltd.

Tachbrook Park Drive  
Tachbrook Park,  
Warwick, CV34 6TU  
United Kingdom  
Tel.: +44 (0) 1926 317 878  
Fax: +44 (0) 1926 317 855  
parker.uk@parker.com  
www.parker.com

Your local authorized Parker distributor