

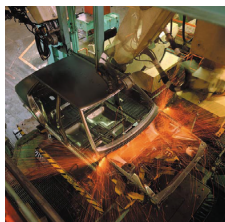

aerospace
climate control
electromechanical
filtration
fluid & gas handling
hydraulics
pneumatics
process control
sealing & shielding



Thermoplastic Hoses for Hydraulics & Industry

Catalogue 4460-UK



ENGINEERING YOUR SUCCESS.

!

Introduction and General Statements

<i>How to use the catalog</i>	II
<i>Part number system & Explanation of symbols</i>	IV
<i>Parker Hannifin – Polymer Hose Division Europe</i>	VI
<i>Why choose Parker thermoplastic hose?</i>	VII
<i>Preformed hoses</i>	XIII
<i>Non conductive hoses</i>	XV
<i>Twinline and multiline hoses</i>	XVI
<i>Hose bundles</i>	XVII
<i>Parkrimp system</i>	XVIII
<i>Value added services</i>	XIX

A

Hose and Fitting Selection

<i>Hose selection</i>	A – 2
<i>Fitting selection</i>	A – 18

B

Push-Lok® Hose and Fittings

<i>Push-Lok® hose</i>	B – 4
-----------------------------	--------------

C

PTFE / Fluoropolymer Hose and Fittings

<i>PTFE hose</i>	C – 4
<i>Fittings for PTFE hose</i>	C – 13

D

Hose and Fittings for Alternative Fuels

<i>SCR hose</i>	D – 4
<i>CNG hose</i>	D – 5
<i>LPG hose</i>	D – 6
<i>Fittings</i>	D – 7

E	<i>Hose and Fittings for Hydraulic and Industrial Applications</i>	
	<i>Small bore hose/mini-hydraulic hose</i>	<i>E – 4</i>
	<i>Medium pressure hose</i>	<i>E – 7</i>
	<i>High pressure hose</i>	<i>E –14</i>
	<i>Paint spray hose</i>	<i>E –27</i>
	<i>Gas hose</i>	<i>E –33</i>
	<i>Hose fittings</i>	<i>E –41</i>

F	<i>Accessories</i>	
	<i>Protective equipment (guards & sleeves)</i>	<i>F – 4</i>
	<i>Banjo bolts & copper rings</i>	<i>F – 6</i>
	<i>Tape</i>	<i>F – 8</i>

G	<i>Technical Information</i>	
	<i>Crimpsource Online</i>	<i>G – 4</i>
	<i>Measure and cut hose to length</i>	<i>G – 7</i>
	<i>Assembly instruction – KarryKrimp® 1 / KarryKrimp® 2</i>	<i>G – 8</i>
	<i>Assembly procedures – Push-Lok® self-grip hose</i>	<i>G – 9</i>
	<i>Twinline and multiline hose separation instructions</i>	<i>G –10</i>
	<i>Determining the hose length for over-the-sheaf applications</i>	<i>G –11</i>
	<i>Selection, installation and maintenance</i>	<i>G –12</i>
	<i>Installation standards and Installation tips</i>	<i>G –14</i>
	<i>Unit Conversion Table</i>	<i>G –17</i>
<i>Parker safety guide</i>	<i>G –18</i>	

H	<i>Index of Part Numbers</i>	
	<i>Index</i>	<i>H – 1</i>
	<i>Safety note</i>	<i>H –14</i>

The content contained in this catalogue has been compiled with the greatest care and corresponds to the information currently available to us.

However, we would like to point out that we reserve the right to make technical changes and we kindly request you to contact us should you have any special questions.



How to use the catalogue

Overall structure of the catalogue:

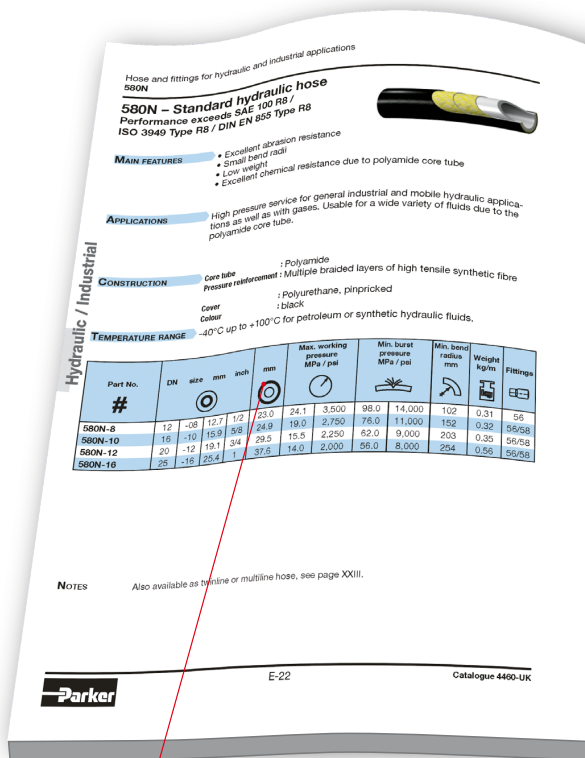
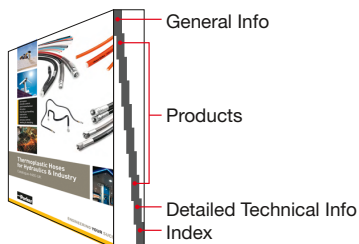

Hose data is always colored in blue

Thermoplastic Hose, Fittings and Accessories for Hydraulic and Industrial Applications
 How to use the catalogue

For general information please refer also to the overview pages at the beginning of the individual chapters

Chapter selector if you know the chapter you are looking for – this is the quickest way to get there

On fitting pages: supported hose types which hose works with which fitting?

E

010A • 518C • 520N/528N • 53DM • 540N • 550N • 55LT • 550 • 580N/588N • 590 • 532DM • 2040N • 2040H

1D056 – Metric male 24°
Light series – ISO 12151-2

Hose fittings 1D056 – 1C356

MATERIAL Galvanized steel with transparent Cr(VI)-free plating. Other materials available on request.

Part No. #	DN size mm inch	Thread size	Connection type			Max. WP MPa	
			Thread size	Tube OD mm	Max. WP MPa		
1D056-6-3	6 -03 4.8 3/16	M12x1.5	6	41.0	23.0	12	25.0
1D056-8-4	8 -04 6.4 1/4	M16x1.5	8	45.8	22.4	14	42.5
1D056-10-5	8 -05 7.9 5/16	M18x1.5	10	49.8	24.0	17	40.0
1D056-12-6	10 -06 9.5 3/8	M18x1.5	12	51.7	25.9	18	35.8
1D056-10-6	10 -06 9.5 3/8	M18x1.5	12	49.5	24.3	17	40.0
1D056-12-6	10 -06 9.5 3/8	M22x1.5	12	49.5	24.3	17	40.0
1D056-15-8	12 -08 12.7 1/2	M22x1.5	15	51.7	25.5	19	35.0
1D056-15-8	12 -08 12.7 1/2	M26x1.5	15	54.9	26.6	22	31.5
1D056-18-10	16 -10 15.9 5/8	M30x2	18	53.6	26.8	22	31.5
1D056-22-12	20 -12 19.0 3/4	M30x2	22	57.6	28.7	27	31.5
1D056-28-16	25 -16 25.4 1	M36x2	28	81.9	33.8	36	21.0

1C356 – Metric female swivel 24°/60°
Light series – Metric swivel nut

MATERIAL Galvanized steel with transparent Cr(VI)-free plating. Other materials available on request.

Part No. #	DN size mm inch	Thread size	Connection type			Max. WP MPa	
			Thread size	Tube OD mm	Max. WP MPa		
1C356-6-3	6 -03 4.8 3/16	M12x1.5	6	37.4	19.7	14	25.0
1C356-8-4	8 -04 6.4 1/4	M16x1.5	8	44.1	19.6	17	25.0
1C356-10-4	8 -04 6.4 1/4	M16x1.5	10	45.0	20.0	19	25.0
1C356-10-5	8 -05 7.9 5/16	M16x1.5	10	45.1	20.3	19	25.0
1C356-12-5	8 -05 7.9 5/16	M18x1.5	12	47.0	12.1	22	25.0
1C356-10-6	10 -06 9.5 3/8	M16x1.5	10	45.8	20.6	19	25.0
1C356-12-6	10 -06 9.5 3/8	M18x1.5	12	46.6	21.4	22	25.0
1C356-15-8	12 -08 12.7 1/2	M22x1.5	15	49.8	21.2	27	25.0
1C356-18-12	20 -12 19.0 3/4	M25x1.5	18	57.6	23.7	32	16.0
1C356-22-12	20 -12 19.0 3/4	M30x2	22	50.4	26.5	35	16.0

Parker E-53 Catalogue 4460-UK

Category selector superordinates chapters, the quickest way to find product groups

Fitting data is always colored in yellow

Part number system

Hoses



2370 N - 06 V10

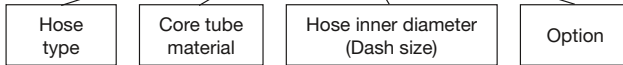



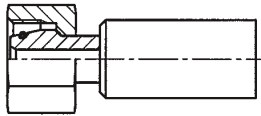



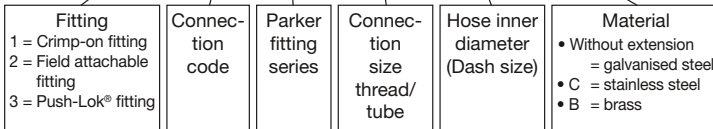



Fittings



1 C9 9X - 12 - 06 C



Explanation of symbols

Symbol	Definition	Symbol	Definition
#	Part number		Volumetric expansion
	Hose ID		Weight
	Hose OD		Thread size
	Working Pressure		Hex size
	Burst pressure		Diameter
	Minimum bend radius		Vacuum

Parker Hannifin – Polymer Hose Division Europe

Parker Hannifin offers an extensive programme of systems and components for fluid technology. Parker is structured by sales offices and manufacturing divisions to guarantee optimum focus on our customers' demands and market interests at any time.

The Polymer Hose Division Europe, with headquarters located in Hüttenfeld, Germany, provides thermoplastic hoses and tubes. These are applied in a variety of different markets such as standard hydraulics, ultra high pressure applications, and oil & gas industry. As a market leader in many areas and with a unique product range we are pleased to assist you with all your queries.

This catalogue includes hoses and fittings for a pressure range up to 70 MPa. The indicated fittings are always adapted to the correspondent hose and offer optimum performance.

Other catalogues with thermoplastic hoses

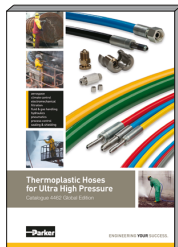

Catalogue 4462-UK

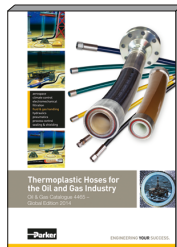

Catalogue 4465-UK



Why use Parker thermoplastic hoses?

Parker thermoplastic hose is the right answer for many technical challenges. With unique features and performance characteristics thermoplastic hose outperforms even established alternatives. Whether the task requires extreme temperatures, pressures, robustness or special custom designs, these hoses will not disappoint you.

See below the features offered by our hose range – in comparison to other standard hose types :

Temperature Range

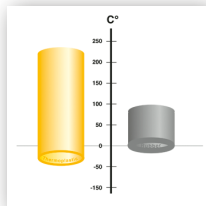

- Operating temperatures ranging from -50°C up to $+230^{\circ}\text{C}$
- Best choice for dynamic applications even at very low temperatures
- Full working pressure even at extreme temperatures



Chemical Resistance



- Chemically inert, no interaction with the media
- Resistant against virtually all acids and alkalines



Abrasion



- Outer covers to withstand extreme wear
- Superior resistance and extended service life

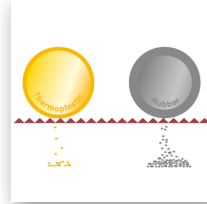

UV / Ozone & Seawater Resistance



- Build for harsh and exposed installations
- Environmental influences have minimal effect on hose life



Compact OD



- Space saving due to very small diameters
- Optimized routing and design in constricted installation spaces
- Prevent using overdimensioned hoses

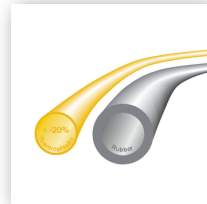



Thermoplastic Hose, Fittings and Accessories for Hydraulic and Industrial Applications
Why use Parker thermoplastic hoses?

Small ID



- Only thermoplastic hoses allow small IDs down to below 2mm
- Space saving
- Offers improved technical solutions in constricted installation spaces



Low Weight

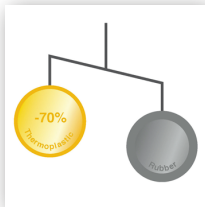

- Major weight savings
- Energy savings as less mass needs to be moved



Non-Conductive



- Mandatory safety feature for applications with high voltage and high frequency
- Electrically isolating according to SAE J517

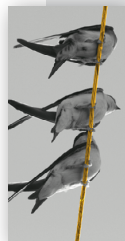

Customization

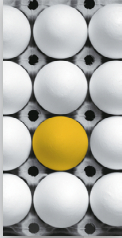

- Multiple colors
- Twin and multiple lines
- Hose bundles
- Customer specific designs

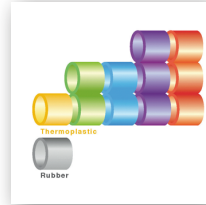

Preforming



- Combining the advantages of bent metal pipe with the flexibility of hose
- Reducing weight, noise and vibration compared to bent metal pipe solutions
- Preformed hoses are maintaining their full technical specifications

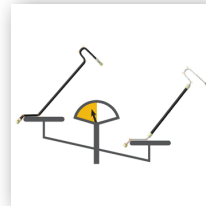

Cleanliness



- Less abrasion and contamination inside the hose
- Reduced residue build up
- Extended lifetime for filters, valves and hydraulic systems

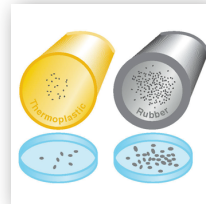



Thermoplastic Hose, Fittings and Accessories for Hydraulic and Industrial Applications

Why use Parker thermoplastic hoses?

Permeation Resistance

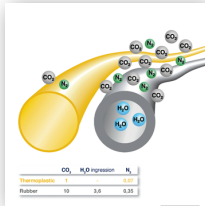

- Low gas permeation
- Reduced ingresson reduced risk of media contamination

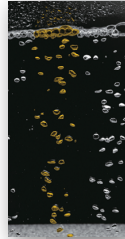

Long Length



- Up to 5,000 m and more continuous length
- Reduced scrap of bulk hose
- Easy winching and handling offer fast deployment of long length



Highest Pressure



- Up to 4,000 bar working pressure
- Highest technical standards and production controls assure safety



Wide range of applications



- Standard hydraulics
- Industrial hydraulics e.g.
 - alternative energies
 - machine tools
 - injection molding
- Mobile hydraulics e.g.
 - material handling
 - construction
 - agriculture
- Automotive and truck industry
- Mini hydraulics
- Chemical industry
- Process industry
- Industrial gases
- Alternative fuels
- Boats and yachts
- Pneumatics
- Life Science
- Media transfer



Preformed hose

Technical benefits of Polyflex thermoplastic preformed assemblies

- **Little space required:**
The assemblies have a very compact design and can be installed or just clipped on wherever they disturb least and where the designer wants them to be.
- **Installation feasible even in difficult to reach places:**
The assemblies can be preformed into almost any shape.
- **Reduction of potential leaks:**
In many cases, the flexible assemblies can replace hose / rigid tube combinations. This means fewer fittings and fewer screwed connections.
- **Compensation of manufacturing inaccuracies:**
Thanks to their flexibility, the assemblies can easily compensate manufacturing tolerances between different components during installation.
- **Noise reduction:**
The good vibrational behaviour reduces wear and tear caused by vibration and lowers the noise level.
- **Weight reduction:**
As compared to steel tubes but also to conventional hose assemblies, Polyflex preformed assemblies are extremely light-weight.



Preformed thermoplastic products

From high pressure hose to thermoplastic tube – combines the advantages of a custom formed steel tube with the flexibility of a hose.

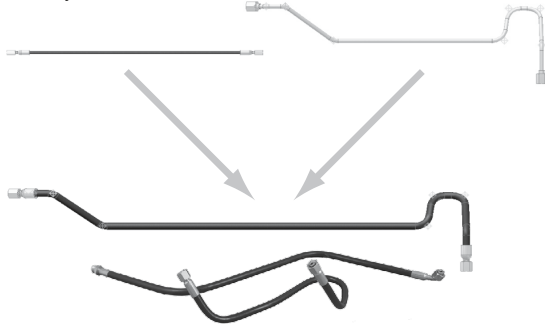

- Your advantages:
- Improvement of efficiency
 - Cost reduction
 - Improvement of quality

Please contact us for individual custom solutions.

Hose coils

For applications where the hose assembly has to be able to perform long distance back and forth movements, hose coils are the ideal solution.

Hose coils from following hose types are available:

540N -3,-4,-5,-6,-8

520N -3,-4,-5

Other hose types on request.





Non conductive hoses

Non conductive hoses are required in many situations:

- non-conductive connection required against electrostatic discharge
- environments with strong magnetic fields or high frequency fields

Common applications for these products are

- work on high voltage lines
- cooling applications of high-power switchboards or other electric systems
- metal processing, e.g. Aluminum smelters (crust breakers), aluminium melting furnaces
- non-conductive cooling systems with de-ionized water

Parker's thermoplastic hoses are electrically non-conductive according to SAE J517 (less than 50 microAmpere and 250.000 Volts per meter)



Twinline and multiline hose

Applications

Twinline or multiline hoses ensure easier installation, and especially in applications such as fork-lift trucks, aerial lifts and hydraulic cranes they form a compact unit. On request twinline and multiline hose can be joined using various combinations of hose sizes and types.

Tools

For separating multiline hose and the appropriate tools see page H-20.

Examples

Part No. #	Part No. for twin hose #
2040H-04V10	2040H-04-04V10V10
2040H-05V10	2040H-05-05V10V10
2040H-06V10	2040H-06-06V10V10
2040H-08V10	2040H-08-08V10V10

Part No. #	Part No. for twin hose #
550H-4	550H-4-4
550H-5	550H-5-5
550H-6	550H-6-6
550H-8	550H-8-8



The following hose types are available in twinline or multiline configuration:

540N	2040H
550H	520N
53DM	580N
55LT	2370N
590TJ	560TJ
5CNG	

Other hose types on request.

General comment:

All hoses with Polyurethane cover can be supplied as twinline or multiline hose.

Hose bundles

In Parker hose bundles, multiple hoses are combined into one compact unit. Hoses with different pressure ratings and sizes can be combined.

Options:

- With integrated electric cables
- With strain relief (avoids destructive tensile stress of the hose)
- Integrated cutting protection in the cover as safeguard for the hoses

Advantages:

- Extremely compact and space saving unit
- No abrasion between the individual hoses
- Length compensation of the hoses due to twisted construction

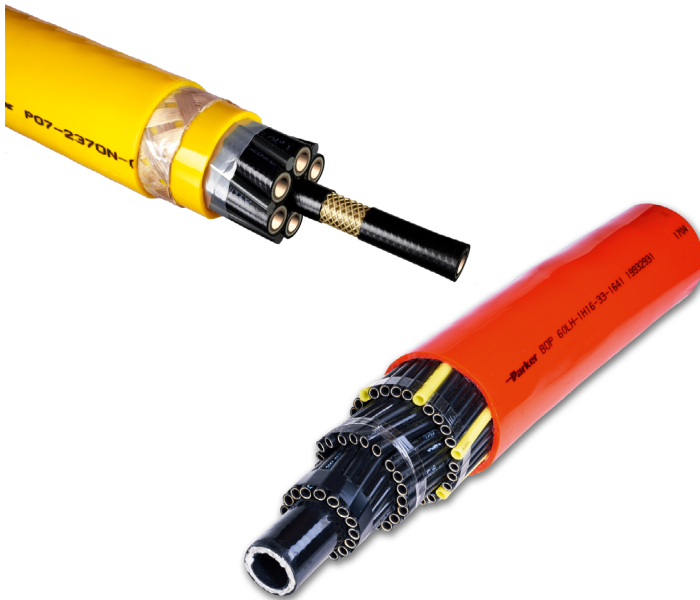

Parkrimp system

Parkrimp is synonymous with the best solution for assembling hydraulic and related hose and fittings from both the technical and the manufacturing points of view!

Throughout the progressive thermoplastic material and metal compression during the crimping process, the reinforcement always remains intact. The meticulous design, testing and manufacturing processes of Parkrimp hose and one piece fittings, combined with the approved crimping diameters provide an excellent mechanical connection between the hose and the fitting. This absolutely leak-free connection gives long service life even with the highest pressures associated most thermoplastic hoses below 700bar and one-piece fittings.

The smartly designed and timetested Parkrimp assembling equipment combined with Parker's assembling know how allow the safest, most efficient and mistake-proof assembly process. The Parkrimp equipment allows cost and time savings to the assembler and guarantees a defect-free, reliable and durable final product to the end-user.

Parkrimp – the system for fast and leak-free assemblies

- For crimping Parkrimp One-Piece fittings (not for two piece and re-usable fittings)
- Quick and easy: no gauges to set on the machine
- Portable machines for field repair
- Meets EN safety regulations
- Both thermoplastic and rubber hoses can be crimped on the same machine (only different die rings are needed)

The perfect match

- The complete system from one source
- Thermoplastic hoses, matching one piece fittings and crimping machine
- World-wide guarantee and availability

Parker's colour-coded die sets

- No loose parts to mismatch or misplace
- Die set segments linked together
- Die sets provide 360° evenly applied crimping forces for an ideal crimp result



Value added services

Parker Polymer Hose Division Europe and the Parker Sales Companies offer value added services that compliment our production capabilities and product portfolio. These services are in place to meet the increasing customization and system criteria that our customers expect from a world-class supplier. The value added services detailed below are typical of the products and secondary services that we provide to our customers. If you have additional service needs that we have not detailed below please contact us. We are happy to discuss all potential solutions for your requirements.

ParkerStore™

At Parker Hannifin, we're continually looking for ways to deliver more products, more efficiently.

The Global ParkerStore™ network enables Parker to provide:

- Prompt, efficient, professional in-store services while you wait
- Expert local services and support
- A safe, friendly and convenient shopping environment
- A greater range of parts options so you get exactly what you're looking for.



Customers trust ParkerStores to provide OEM and MRO customers with direct access to:

- Custom-made hydraulic hose assemblies and complementary products to support their applications and decrease their downtime
- Expert technical support
- Professional, personalized services, including 24/7/365 support
- The convenience, comfort and amenities of a local service provider.

The Parker® Tracking System Enterprise (PTS)



is designed to help customers reduce vehicle or asset down-time through increases in the speed, timing and accuracy of necessary repairs. PTS provides a unique 8 digit identification code and bar code printed on a durable label for each hose assembly. PTS labels are specifically engineered to withstand harsh chemicals, temperatures, UV exposure and other challenging conditions.

- PTS captures, records and recalls unique hose assembly information – on demand
- Provides fast and accurate product identification to speed up replacement regardless of where the original assembly was made.
- Assembly can be replaced with only the 8 digit PTS ID number/bar code eliminating the need to remove hoses prior to replacement. This can provide critical machine uptime and enable more conveniently scheduled repair.
- PTS includes additional reporting tools to assist in continuous improvement programmes and preventative maintenance initiatives.

Parker HOSE DOCTORS



are a network of independently-owned, mobile service technicians built around the commitment to identify and replace hose assemblies wherever their customers need them, with the fastest response times possible. HOSE DOCTORS® are an extension of the worldwide Parker distribution network, coupling their service commitment with Parker products – the highest quality hoses and fittings available in the market today.

Parker Store Container Service



The ParkerStore container is a transportable workshop, providing on-site maintenance and product support for large construction projects such as roadworks, tunnels, railways, underground systems, etc. Provides an on-site product and hose replacement service. With this service on your site, you can reduce your downtime keeping your project on time and on budget!

XX

Tech Services

Optimises the performance of your hydraulic and pneumatic circuits

- With Parker Tech Services involved, your time to market is shorter, which saves on development costs
- The 3 year no-leak guarantee enhances your reputation and lowers your warranty costs
- More reliable operation lowers your customer's operating costs
- More efficient performance and no-leak guarantee is beneficial to the environment
- Parker worldwide coverage ensures you can use the service and save costs wherever you are



Breadman

Lean logistics and delivery of Parker products and kits directly to the customer's assembly line, work stations or warehouse

- 100 % parts availability minimises downtime, increases production and reduces costs
- Elimination of stock checking reduces manpower and maintains production levels
- Daily delivery reduces inventory and overheads
- Electronic order processing eliminates paperwork and reduces administration costs



Kitting

Multiple components are supplied under a single part number

- Reduced number of suppliers
- Reduced stocks and no obsolete items
- Optimized management (stock and supplies)
- Simplified and optimised order handling
- Reduced assembly costs
- Greater productivity



Chapter A

Hose and Fitting Selection

Hose selection	A-2
Hose selection by application.....	A-4
Hose selection by working pressure and ID	A-6
Hose selection by fluid compatibility/chemical resistance	A-8
Hose selection by standards and approvals.....	A-15
Determination of hose size	A-16
Pressure drop.....	A-17
Fitting selection	A-18
Fittings overview	A-19

Hose selection

Several criteria must be considered, when selecting the optimal hose for your application. According to the particular application there is – as a rule – at least one of these characteristics crucial for the selection. In this section you will find the most important criteria and relevant selection guidelines.



Hose selection by application

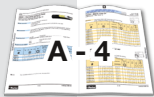

This overview designates some application ranges together with hoses, which have proved to be especially suited for the associated application. Please note that only the most important applications can be listed. Moreover, the suitability of the desired hose for the individual environmental conditions must be verified.

Hose selection by working pressure and ID

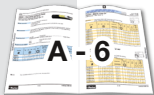

When working pressure and ID are given, use this table to select the possible hoses for the desired pressure range.

Hose selection by fluid compatibility/chemical resistance

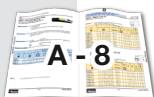

Many applications require highly chemical resistant materials due to aggressive media. The table lists chemical fluids and rating codes for different hose materials.

Hose selection by standards and approvals

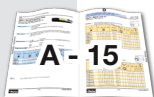

This overview lists hose types by international standards, approvals and certificates.

Determination of hose size

If you are not sure about the hose ID suitable for your application, the flow capacity nomogram and the pressure drop chart will assist you in selecting the correct hose size.

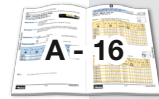

Hose selection by temperature

Ambient and fluid temperatures must not exceed the hose/fittings rated design temperature. Also the rated ambient temperature of the fluid inside the hose must not be exceeded. Attempt to route hose or shield hose from high temperature sources.

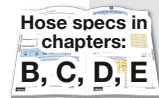

Hose selection by environment

Conditions such as ozone, UV light, harsh chemicals, salt water, and other airborne contaminants can degrade hose and shorten its life.

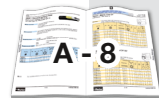

Further Selection Criteria

Always follow manufacturers specifications and do not mix components of different manufacturers.

If the end-connections are pre-defined, always follow manufacturers specifications and do not mix components of different manufacturers.

Conditions such as tensile and side loads, vibration, excessive flexing, and twist will reduce hose life. Use swivel fittings and adaptors to avoid hose twisting. Test the hose if the application is potentially problematic or unusual.



**Please contact
your local Parker
representative**

Hose selection by application

Application	Hose type										
	2010H	2020N	2030T	2030T	2033T	2040H	2040N	2245N	2246F	2370N	2380F
2-component systems			●		●			●			●
Aluminium plants											
Cranes						●					
Chemical industry			●	●	●						
Steam applications											
Diagnosis & test systems		●									
Compressed-air systems						●					
Electrically non-conductive applications											
Energy chains						●					
Earth-moving machines/construction machines	●	●				●					
Paint spray systems (airless)			●		●		●	●		●	
Fire fighting equipment							●				
Motor and Sailing boats		●					●				
Gas applications		●	●				●	●		●	
Operating tables	●	●			●						
Platforms for lifting persons						●					
Hot melt applications								●			
High temperature applications			●	●	●			●		●	
Lifting devices/fork-lifts											
Cooling systems											
Agricultural machinery	●	●				●					
Food industry											
Mini hydraulics	●	●				●	●				
General hydraulics		●				●		●		●	
Engines				●							
PU foaming			●					●			
Tyre press machines			●	●							
Hose reels						●				●	
Lubricating systems	●										
Welding robots											
Solar plants		●				●					
Telehandler		●									
Low temperature applications (dynamic & static)											
Pilot lines	●										
Machine tools		●				●					
Wind turbines						●					
Page	E-5	E-6	C-4 E-31	C-5	C-6 E-32	E-16	E-15 E-29	E-25	C-12	E-24 E-30	C-11

Note: Please refer also to our safety guide when selecting hoses (page H-29 ff.)



Hose and Fitting Selection
Hose selection by working pressure and ID

Selection

Hose selection by working pressure and ID

Pressure and ID / Hose selection by working pressure

nom. size	DN	Working pressure (MPa)																Fitting series	P.
		2	2.5	3	4	5	6	8	10	12	16	20	25	32	40	50			
		size	-012	-016	-02	-025	-03	-04	-05	-06	-08	-10	-12	-16	-20	-24	-32		
mm*	2.0	2.4	3.2	4.0	4.8	6.4	7.9	9.5	12.7	15.9	19.0	25.4	31.8	38.1	50.8				
inch	5/64	3/32	1/8	5/32	3/16	1/4	5/16	3/8	1/2	5/8	3/4	1	1 1/4	1 1/2	2				
Push-Lok® hose																			
830M						1.6		1.6	1.6	1.6	1.6						82	B-4	
838M						1.6		1.6	1.6	1.6	1.6						82	B-5	
PTFE-/FEP hose																			
2030T					27.5	24.0	20.0	17.5	15.0	12.5	10.0	8.0					YX	C-4	
2030T-##CON						17.2	15.5	13.8	10.3	8.3	6.9	4.6	3.4				PC	C-5	
2033T						27.5	25.0	22.5	20.0	17.5	15.0	11.0					PX/YX	C-6	
919						21.0	21.0	17.5	14.0	10.3	8.3	6.9					91N	C-7	
919U						21.0		17.5	14.0		8.3	6.9					91N	C-8	
929/929B						21.0		17.5	14.0		8.4	8.8					91N	C-9	
939/939B								10.3	9.5	6.9	7.5	6.9	6.9	5.0	1.7		93N	C-10	
2380F						42.5	37.5	35.0	32.5	30.0	27.5	22.5					NX	C-11	
2246F						41.5	37.5	34.0	32.5	30.0	26.5	21.0					NX	C-12	
Hose for alternative fuels																			
5CNG						34.5		34.5	34.5		34.5	34.5					CG	D-5	
8LPG					3.0	3.0	3.0	3.0									PX-LPG	D-6	
Small bore hose/Mini hydraulic hose																			
2010H				21.0													EX	E-5	
2020N (V30)	47.5	40.0	40.0	44.0													EX	E-6	
2020N (V50)	63.0																EX	E-6	
Medium pressure hose																			
550H					22.5	21.0	17.5	15.5	14.0	10.0	8.5	7.0					56	E-8	
540N			21.0		21.0	19.0	17.5	15.5	14.0		8.5						56	E-09	
560TJ					25.0	22.4	20.6	19.0	17.2	13.7	12.0						56	E-10	
518C			17.5		22.5	20.7	17.5	15.5	15.5	10.5	8.5	7.0					56	E-11	
53DM								20.7	20.7	20.7							56	E-12	
55LT			21.0		22.5	21.0	17.5	15.5	14.0								56	E-13	

*: Exact value may vary, please check hose spec



Hose and Fitting Selection
Hose selection by working pressure and ID

Selection

		Working pressure (MPa)															Fitting series	P.
nom. size	DN	2	2.5	3	4	5	6	8	10	12	16	20	25	32	40	50		
	size	-012	-016	-02	-025	-03	-04	-05	-06	-08	-10	-12	-16	-20	-24	-32		
	mm*	2.0	2.4	3.2	4.0	4.8	6.4	7.9	9.5	12.7	15.9	19.0	25.4	31.8	38.1	50.8		
inch	5/64	3/32	1/8	5/32	3/16	1/4	5/16	3/8	1/2	5/8	3/4	1	1 1/4	1 1/2	2			
High pressure hose																		
	2040N (V00)			35.0		34.0	31.0	25.0	24.0	18.5	14.0	12.5	10.0				56/PX	E-15
	2040H					34.0	31.0	25.0	24.0	18.5	14.0	12.5	10.0				56/PX	E-16
	520N					34.5	34.5	31.0	27.5	24.0							56	E-17
	528N					34.5	34.5	31.0	27.5	24.0							56	E-18
	580N									24.5	19.0	15.5	14.0				56	E-19
	588N									24.5	19.0	15.5	14.0				56	E-20
	590TJ						34.5		27.6	24.1		17.2	13.8				43/48/56	E-21
	594TJ									28.0	28.0						43/46/48	E-22
	575X				34.5	34.5			34.5	34.5		34.5	34.5				CG	E-23
	2370N					46.5	44.0	42.0	35.0								9X/NX	E-24
	2245N					45.0	40.0	37.5	35.0	33.0	30.0	27.5					9X/NX	E-25
Paint spray hose																		
	2040N			35.0		34.0	31.0	25.0	24.0	18.5	14.0	12.5	10.0				56/PX	E-29
	2370N						46.5	44.0	42.0	35.0							9X/NX	E-30
	2030T					27.5	24.0	20.0	17.5	15.0	12.5	10.0	8.0				YX	E-31
	2033T						27.5	25.0	22.5	20.0	17.5	15.0	11.0				PX/YX	E-32
Gas hose																		
	527BA					48.3	48.3										CG	E-38
	5CNG						34.5		34.5	34.5		34.5	34.5				CG	E-39
	8LPG					3.0	3.0	3.0	3.0								PX-LPG	E-40



Hose and Fitting Selection

Hose selection by fluid compatibility/chemical resistance

Selection

Hose selection by fluid compatibility/ chemical resistance

Ratings code

- G : Good to excellent. Little or no swelling, tensile or surface changes. Preferred choice.
- L : Marginal or conditional. Noticeable effects but not necessarily indicating lack of safety. Further testing suggested for specific application.
- P : Poor or unsatisfactory. Not recommended without extensive and realistic testing.
- : Indicates that this was not tested.
- * : Biopetroleum must be tested individually due to its varying composition.

Material codes for hose core tubes		<i>polyflex</i> / Parflex Part No.
H	Polyester elastomer	2040H, 518C, 550H, 55LT, 560TJ, 590TJ, 53DM
N	Polyamide	2020N, 2040N, 2245N, 2370N, 520N, 528N, 540N, 575X, 580N, 588N, 8LPG, SCR
NC	Nylon copolymer	5CNG
FEP	Fluorethylenpropylen	2380F, 2246F
TFE	Polytetrafluoroethylene (PTFE)	2030T (V70, CON), 2033T, 929/929B, 939/939B, 919U
EPDM	Ethylen Propylen Dien	SCR
Material codes for hose covers		
U	Polyurethane	2010N, 2040N (V00), 2040H, 2245N, 2370N, 510, 830, 838, 540N, 550H, 560TJ, 520N, 528N, 580N, 588N, 590TJ, 919U, 5CNG
HF	Special elastomer	55LT, 53DM
PFX	Special elastomer	518C
N	Polyamide	2010N, 2020N, 2245N, 8LPG
Material code for sealing components		
V	FKM	

Notes on the chemical resistance table

- (1) The fluid resistance tables are simplified rating tabulations based on immersion tests at 24 °C. Higher temperatures tend to reduce ratings. Since final selection depends on pressure, fluid and ambient temperature and other factors not known to Parker Hannifin, no performance guarantee is expressed or implied. The indications do not imply any compliance with standards and regulations and do not refer to possible changes of colour, taste or smell. For food and drinking water specially approved materials have to be used. For fluids not listed or for advice on particular applications, please consult Parker Hannifin Manufacturing Germany GmbH & Co. KG, Polymer Hose Division Europe in Hüttenfeld, Germany.
- (2) Hose applications for these fluids must take into account legal and insurance regulations. The chemical resistance indicated does not express or imply approval by certain institutions.
- (3) Satisfactory at some concentrations and temperatures, unsatisfactory at others.
- (4) For gas applications, the cover should be pin-pricked and the pressure must not be released quickly. Special safety guard accessories are to be used to prevent damage or personal injury in the event of failure.
- (5) Chemical resistance does not imply low permeation rates. Please consult Parker Hannifin GmbH for a recommendation for your specific requirements.
- (6) The indication of chemical resistance does not imply any special food compatibility; it refers only to the chemical resistance of the material.
- (7) Chemical resistance does not imply acceptability for use in airless paint spray applications. These applications require a special, electrically conductive hose.

Hose and Fitting Selection

Hose selection by fluid compatibility/chemical resistance
Selection

Chemical	H	N	U	HF	V	NC	PFX	FEP	TFE
Acetaldehyde	G	L	L	L	P	-	L	G	G
Acetic Acid Glacial	L	L	L	L	G	P	L	L	G
Acetone	L	G	P	P	P	G	P	G	G
Acetylene	-	-	-	-	-	-	-	-	-
Air (4)	G	G	G	G	G	G	G	G	G
Ammonium Chloride	G	P	G	G	G	P	G	L	G
Ammonium Hydroxyde	L	G	P	P	L	-	P	G	G
Anhydrous Ammonia	P	P	P	P	P	P	P	-	P
Aniline	P	P	P	P	P	P	P	G	G
Animal Oils (6)	G	G	G	G	G	G	G	-	G
Aromatic Hydrocarbons	L	G	L	L	P	G	L	-	G
Asphalt	G	G	G	G	G	G	G	L	G
Baygon (insecticide)	L	G	P	P	-	-	P	-	G
Beer	G	G	G	G	G	-	G	G	G
Benzene	L	G	L	L	P	L	L	G	G
Biopetroleum	*	*	*	*	*	*	*	*	*
Brake Fluid (DOT #3)	-	G	P	P	P	-	P	-	G
Butane (2) (4)	G	G	L	L	L	P	L	-	-
Butter (6)	G	G	G	G	G	-	G	-	G
Calcium Chloride	G	-	G	G	L	-	G	G	G
Carbon Dioxide (4)	G	G	G	G	G	G	G	-	-
Carbon Monoxide (4)	G	-	G	G	G	-	G	-	-
Carbon Tetrachloride	L	G	P	P	L	G	P	G	G
Castor Oil	G	L	L	L	G	L	L	-	G
Chlordane (insecticide)	L	G	P	P	-	-	P	-	-
Chlorinated Hydrocarbon Base Fluids	L	G	L	L	P	-	L	-	G
Chlorinated Petroleum Oil	G	G	L	L	-	L	L	-	-
Chlorinated Solvents	P	-	P	P	L	-	P	-	G
Chlorine, Gaseous, Dry	P	P	P	P	G	P	P	-	-
Chloroform	P	P	P	P	P	P	P	G	G
Chromic Acid	P	-	P	P	G	P	P	L	G
Citric Acid Solutions	G	G	L	L	G	G	L	G	G
Crude Petroleum Oil	G	G	G	G	G	G	G	-	G
Cyclohexane (2)	G	G	G	G	-	-	G	G	G
Cygon (insecticide)	L	G	P	P	-	-	P	-	-
Diazion (insecticide)	L	G	P	P	-	-	P	-	-
Diesel Fuel (2)	G	G	G	G	L	G	G	-	G

G : Good to excellent. Little or no swelling, tensile or surface changes. Preferred choice.

L : Marginal or conditional. Noticeable effects but not necessarily indicating lack of safety. Further testing suggested for specific application.

P : Poor or unsatisfactory. Not recommended without extensive and realistic testing.

- : Indicates that this was not tested.

* : Biopetroleum must be tested individually due to its varying composition.



Hose and Fitting Selection
Hose selection by fluid compatibility/chemical resistance

Chemical	H	N	U	HF	V	NC	PFX	FEP	TFE
Diester Oils	L	G	P	P	P	-	P	-	G
Enamels	G	G	G	G	L	-	G	-	G
Ethanol (6)	G	G	L	L	L	L	L	-	G
Ethers	L	G	P	P	L	G	P	G	G
Ethylene Glycol	G	G	L	L	G	G	L	G	G
Ethylene Oxide	G	G	L	L	P	-	L	-	-
Fatty Acids	G	G	-	-	G	G	-	G	G
Formaldehyde	L	L	P	P	L	L	P	G	G
Formic Acid J	P	P	P	P	G	P	P	G	G
Freon 12 (5)	P	G	L	L	G	G	L	-	-
Freon 22 (5)	P	G	L	L	G	G	L	-	-
Fruit Juices	G	G	G	G	G	-	G	-	G
Fuel Oil (2)	G	G	L	L	L	G	L	G	G
Gas (Oil) (2)	G	G	G	G	G	G	G	-	G
Gasoline	G	G	-	-	P	G	-	G	G
Glue	-	-	-	-	-	-	-	-	-
Glycerine	G	G	L	L	G	G	L	G	G
Glycols (to 135 °F)	G	G	L	L	G	G	L	G	G
Grease (petroleum base)	G	G	G	L	G	G	G	-	G
Heptachlor (insecticide)	L	G	P	L	L	-	P	-	G
Hexane (2)	G	G	G	L	L	G	G	G	G
Houghto Safe-1000 Series (phosphate esters)	L	G	P	P	G	G	P	-	G
Houghto Safe-600 Series (hydraulic fluid)	G	G	L	L	G	G	L	-	G
Hydraulic Fluid (petroleum base)	G	G	G	G	G	G	G	L	G
Hydraulic Fluid (phosphate ester base)	L	G	L	L	L	G	P	-	G
Hydraulic Fluid (water glycol base)	G	G	G	G	L	G	G	-	G
Hydraulic Oil (petroleum base)	G	G	G	G	G	G	G	L	G
Hydrochloric Acid	P	L	P	P	L	P	P	G	G
Hydrofluoric Acid	P	P	P	P	L	P	P	G	G
Hydrolube (hydraulic fluid/water glycol base)	G	G	L	L	G	G	L	-	G
IRUS 902 (hydraulic fluid/water-oil emulsion)	G	G	G	G	G	G	G	-	G
Isocyanates (2)	L	L	L	L	P	-	L	-	G
Isooctane (2)	G	G	G	G	L	G	L	G	G
Isopropyl Alcohol	G	G	L	L	L	G	L	G	G
Kerosene (2)	G	G	L	L	L	G	P	G	G
Ketones	L	G	P	P	P	G	P	G	G
Lacquer Solvents	L	G	P	P	P	-	P	L	G

G : Good to excellent. Little or no swelling, tensile or surface changes. Preferred choice.
L : Marginal or conditional. Noticeable effects but not necessarily indicating lack of safety. Further testing suggested for specific application.
P : Poor or unsatisfactory. Not recommended without extensive and realistic testing.
- : Indicates that this was not tested.
* : Biopetroleum must be tested individually due to its varying composition.

Hose and Fitting Selection

Hose selection by fluid compatibility/chemical resistance

Selection

Chemical	H	N	U	HF	V	NC	PFX	FEP	TFE
Lactic Acid	P	G	P	P	G	G	P	G	G
Lime (calcium oxide)	G	G	G	G	G	-	G	G	G
Lindol (hydraulic fluid/phosphate esters)	L	G	P	P	-	-	P	-	G
Linseed Oil	G	G	G	G	L	G	G	G	G
LP-Gas	-	-	-	-	-	-	-	-	-
Lubricating Oils (diester base)	L	G	P	P	-	G	P	-	G
Lubricating Oils (petroleum base)	G	G	G	G	G	G	G	G	G
Magnesium Hydroxide	L	G	L	L	G	-	L	G	G
Magnesium Salts	-	G	G	G	G	-	G	-	G
Malathion (insecticide)	L	G	P	P	-	-	P	-	G
Mercury	G	G	G	G	G	G	G	G	G
Meropa Oil (sulphur base)	G	G	-	-	-	-	-	-	G
Methane	-	-	-	-	-	-	-	-	-
Methanol	G	G	P	P	P	G	P	-	G
Methoxychlor (insecticide)	L	G	P	P	-	-	P	-	G
Methyl Alcohol (6)	G	G	P	P	P	G	P	G	G
Methyl Ethyl Ketone (MEK)	L	G	P	P	P	G	P	G	G
Methyl Ethyl Ketone Peroxide (MEKP)	-	L	P	P	-	-	P	-	G
Methyl Isobutyl Ketone (MIBK)	L	G	P	P	P	G	P	G	G
Methylene Chloride	P	L	P	P	L	P	P	G	G
Milk (6)	G	G	G	G	G	-	G	G	G
Mineral Oil	G	G	G	G	G	G	G	G	G
Mineral Spirits	P	-	L	L	P	-	L	-	G
Motor Oils	G	G	G	G	G	G	G	G	G
Naphta	L	G	P	P	P	G	P	G	G
Natural Gas (4)	-	-	-	-	-	-	-	-	-
Nitric Acid	P	P	P	P	L	P	P	L	G
Nitrobenzene	P	G	P	P	P	G	P	G	G
Nitrogen, Gaseous (4) (5)	G	G	G	G	G	G	G	G	G
Nitrous Oxide	-	L	-	-	G	-	G	-	-
Oil (SAE)	G	G	G	G	G	G	G	-	G
Oil of Turpentine	G	G	P	P	G	G	P	-	G
Oleic Acid	G	G	G	G	L	G	G	G	G
OS 45 Type 3 Hydraulic Fluid (silicate esters)	L	G	L	L	P	-	L	-	-
Ozone	L	P	L	L	G	P	P	G	G
Paint (Oil Base) (7)	G	G	G	G	P	-	G	-	G
Paint Solvents (Oil base)	L	G	L	L	P	-	L	-	G

G : Good to excellent. Little or no swelling, tensile or surface changes. Preferred choice.

L : Marginal or conditional. Noticeable effects but not necessarily indicating lack of safety. Further testing suggested for specific application.

P : Poor or unsatisfactory. Not recommended without extensive and realistic testing.

- : Indicates that this was not tested.

* : Biopetroleum must be tested individually due to its varying composition.



Hose and Fitting Selection
Hose selection by fluid compatibility/chemical resistance

Chemical	H	N	U	HF	V	NC	PFX	FEP	TFE
Pentane (2)	G	G	L	L	L	-	L	G	G
Perchloric Acid	P	P	P	P	L	P	P	L	G
Perchloroethylene	P	P	P	P	L	P	P	-	G
Petroleum Ether	-	-	-	-	P	-	-	-	-
Petroleum Oils	G	G	G	G	G	G	G	-	G
Phenols	P	P	P	P	L	P	P	-	G
Phosphate Esters (above 135 °F)	P	G	P	P	P	-	P	-	G
Phosphate Esters (to 135 °F)	G	G	P	P	P	G	P	-	G
Polyol Esters	L	G	P	P	P	-	P	-	G
Potassium Hydroxide, 50%	P	P	P	P	L	-	P	G	G
Propane (4) (5)	-	-	-	-	-	-	-	-	-
Propylene Glycol	-	-	G	G	G	-	-	G	G
Pydraul 312C, 625 (to 135 °F)	P	G	P	P	P	G	P	-	G
Pydraul F-9, 150, 160 (to 135 °F)	G	G	P	P	P	G	P	-	G
Quintolubric 822 Fluid	-	G	G	G	-	-	-	-	G
Salt Water	-	-	G	-	-	-	-	G	G
Sevin (insecticides in water)	G	G	G	G	-	-	G	-	G
Silicone Greases	G	G	G	G	G	G	G	-	G
Silicone Oils	G	G	G	G	G	G	G	-	G
Skydrol 500 & 7000	L	G	P	P	P	G	P	G	G
Soap Solutions	G	G	G	G	G	G	G	G	G
Soda Water	G	G	G	G	G	G	G	-	G
Sodium Borate	G	G	G	G	G	G	G	G	G
Sodium Carbonate	-	-	-	-	-	-	-	-	-
Sodium Chloride Solutions	G	G	G	G	G	-	G	G	G
Sodium Hydroxide, 50%	L	P	P	P	L	P	P	G	G
Sodium Hypochloride	L	P	P	P	L	-	P	G	G
Steam	P	P	P	P	P	P	P	G	G
Stoddard Solvent	P	G	P	P	L	G	P	G	G
Straight Synthetic Oils (phosphate esters)	L	G	P	P	P	G	P	-	G
Sulphur	G	G	G	P	G	-	G	G	G
Sulphur Dioxide	P	L	L	L	L	-	L	G	G
Sulphur Hexafluoride Gas (4) (5)	G	G	G	G	G	-	G	-	G
Sulphuric Acid	P	P	P	P	-	P	P	-	G
Toluol, Toluene	L	G	L	L	P	G	P	G	G
Transmission Fluid	G	G	G	G	P	G	G	-	G
Trichlorethylene	P	L	P	P	L	G	P	G	G

G : Good to excellent. Little or no swelling, tensile or surface changes. Preferred choice.

L : Marginal or conditional. Noticeable effects but not necessarily indicating lack of safety. Further testing suggested for specific application.

P : Poor or unsatisfactory. Not recommended without extensive and realistic testing.

- : Indicates that this was not tested.

* : Biopetroleum must be tested individually due to its varying composition.

Hose and Fitting Selection

Hose selection by fluid compatibility/chemical resistance

Selection

Chemical	H	N	U	HF	V	NC	PFX	FEP	TFE
Trisodium Phosphate Solutions	L	G	P	P	G	G	P	G	G
Turpentine	G	G	L	L	L	G	P	G	G
Ucon (hydraulic fluid/water glycol base)	G	G	L	L	G	G	L	–	G
Varnish	G	G	G	G	P	G	G	–	G
Vinegar (6)	L	G	L	L	G	G	L	G	G
Water (above 60 °C) (6)	P	G	P	P	L	–	P	L	G
Water (to 60 °C) (6)	G	G	G	G	G	G	L	G	G
Water Glycols (above 60 °C)	P	G	P	P	L	–	P	–	G
Water Glycols (to 60 °C)	G	G	L	L	G	G	L	–	G
Water in oil Emulsions (above 60 °C)	P	G	P	P	L	–	P	–	G
Water in oil Emulsions (to 60 °C)	G	G	L	L	G	G	L	–	G
Whiskey, Wines (6)	G	G	L	L	G	G	G	G	G
Wood Oils	G	G	L	L	G	G	G	–	G
Xylene	L	G	P	P	P	G	P	G	G
Zinc Chloride	G	G	G	G	G	P	G	G	G

G : Good to excellent. Little or no swelling, tensile or surface changes. Preferred choice.

L : Marginal or conditional. Noticeable effects but not necessarily indicating lack of safety. Further testing suggested for specific application.

P : Poor or unsatisfactory. Not recommended without extensive and realistic testing.

– : Indicates that this was not tested.

* : Biopetroleum must be tested individually due to its varying composition.





Hose selection by standards and approvals

Standards, approvals and certificates	<i>polyflex/Parflex</i> hose (page no.)	
International standards	Pressure ratings for hydraulic service:	
	SAE 100R1	560TJ (E-10)
	SAE 100R2	590TJ (E-21)
	SAE 100R7	550H (E-8), 540N (E-9), 518C (E-11), 55LT (E-13)
	SAE 100R8	520N (E-17), 528N (E-18), 580N (E-19), 588N (E-20)
	SAE 100R9	2245N (E-25)
	SAE 100R14	919 (C-7)
	SAE 100R18	53DM (E-12)
	ISO 3949 Typ R7	550H (E-8), 540N (E-9), 518C (E-11), 55LT (E-13)
	ISO 3949 Typ R8	520N (E-17), 528N (E-18), 580N (E-19), 588N (E-20)
	ISO 3949 Typ R18	53DM (E-12)
	DIN EN 853-1SN	560TJ (E-10), 2040N (E-15), 2040H (E-16)
	DIN EN 853-2SN	2370N (E-24)
	DIN EN 855 Typ R7	550H (E-8), 540N (E-9), 518C (E-11), 55LT (E-13)
	DIN EN 855 Typ R8	520N (E-17), 528N (E-18), 580N (E-19), 588N (E-20)
	Electrical non-conductivity:	
SAE J517	518C (E-11), 528N (E-18), 588N (E-20), 838M (B-5)	
Flame resistance:		
AS/NZS 1869	8LPG- , with additional flame resistant outer cover type -FR (D-6)	
DNV (Det Norske Veritas):		
Marine steel vessels, mobile and stationary offshore drilling units	540N (E-9), 560TJ (E-10), 520N (E-17), 580N (E-19), 588N (E-20), 590TJ (E-21), 575X (E-23), 2020N (E-6), 2245N (E-25)	
FDA approved material:		
FDA 21 CFR 177.1550 (dry food contact)	2030T (C-4), 919 (C-7), 2030T-##CON (C-5), 2033T (C-6), 2246F (C-12), 2380F (C-11), 919U (C-8), 929 (C-9), 939 (C-10)	
CSA:		
ANSI/IAS NGV4.2-CSA 12.52	5CNG (D-5)	
ECE:		
ECE R110	5CNG (D-5), 8LPG (D-6)	
ECE R67	8LPG and 8LPG-FR version (D-6)	

Determination of hose size

Flow capacities of Parker hose at recommended flow velocities

The chart below is provided as an aid in the determination of the correct hose size.

Example:

At 10 gallons per minute (gal/min), what is the proper hose size within the recommended velocity range for pressure lines?

Locate 10 gallons per minute in the left-hand column and 25 feet per second in the right-hand column (the maximum recommended velocity range for pressure lines).

Lay a straight line across these two points. The inside diameter shown in the centre column is above -6 so we have to use -8 (1/2").

For suction lines, follow the same procedure except use recommended velocity range for intake lines in the right-hand column.

where: Q = flow in gallons per minute (gal/min & l/min)
 V = velocity in feet per second (f/s & m/s)
 d = hose inside diameter (mm & dash size)

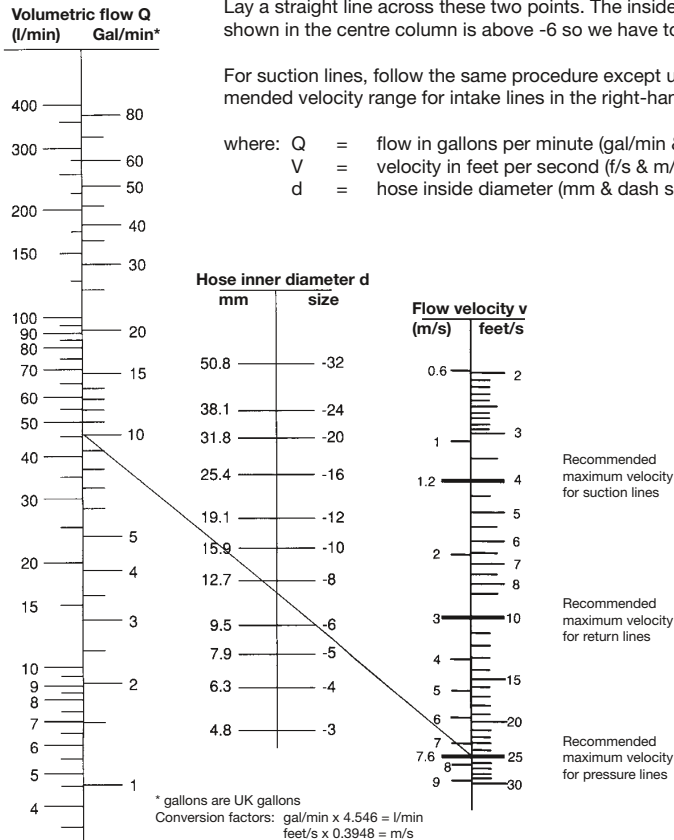

* Recommended velocities are according to hydraulic fluids of maximum viscosity 315 S.S.U. at 38 °C working at room temperature within 18 ° and 68 °C.



Pressure drop

When sizing hydraulic systems, internal pressure drops must be taken into account. These pressure drops result from friction loss of the flowing hydraulic fluids.

For calculation of the pressure drop in a straight line the following pressure loss diagram can be used, when flow quantity Q and nominal size are given.

The resulting pressure drop p applies to one metre line length.

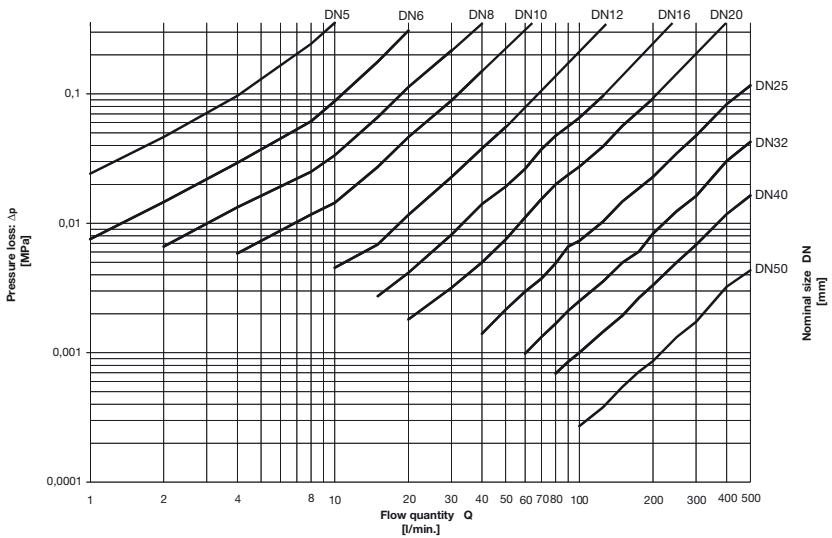

Fitting selection

Which is the approved fitting series for the selected hose?

For each hose type at least one fitting series is approved. Please refer to the related hose table contained in each hose description to find out which fitting series is available for the desired hose type.

Which is the correct fitting with the required end connection for the relevant hose assembly?

Each end connection in this catalogue has its own alphanumeric code. For example, the alphanumeric code for a DKOL connection with 90° elbow is "CF". Pages A-19 to A-24 show a complete overview of all end connections and the related codes.

You have problems to locate the desired fitting? Please contact your local dealer.

For new designs according to current industry standards, standpipes are no longer recommended.

Fittings overview
Metric DIN fittings

C3 Metric female swivel 24°/60°

Light series –
Metric swivel nut

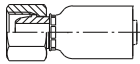

56	E-44
91N	C-13
9X	E-56
NX	E-70
PC	C-30
PX	E-76
PX-LPG	D-7
YX	C-41

Correspondence between
Fitting Part No. and fitting
representation in this overview

Example:
1 C5 56 - 10 - 06

See fittings table
on page E-45.

C4 Metric female swivel 24°/60°

45° elbow –
Light series –
Metric swivel nut

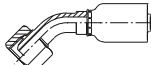

56	E-45
----	-------	------

C5 Metric female swivel 24°/60°

90° elbow –
Light series –
Metric swivel nut

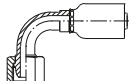

56	E-45
----	-------	------

C6 Metric female swivel 24°/60°

Heavy series –
Metric swivel nut

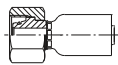

56	E-48
NX	E-70

CA Metric female swivel 24°
with O-ring

Light series –
Metric swivel nut –
ISO 12151-2

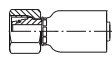

56	E-42
EX	E-63
PC	C-30
PX	E-77
YX	C-42

CE Metric female swivel 24°
with O-ring

45° elbow – Light series –
Metric swivel nut –
ISO 12151-2

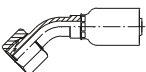

56	E-43
PC	C-31
PX	E-79

CF Metric female swivel 24°
with O-ring

90° elbow – Light series –
Metric swivel nut –
ISO 12151-2

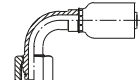

56	E-43
PC	C-32
PX	E-80

C9 Metric female swivel 24°
with O-ring

Heavy series –
Metric swivel nut –
ISO 12151-2

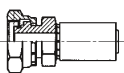

56	E-46
9X	E-56
EX	E-63
NX	E-71
PC	C-31
PX	E-78
YX	C-42

OC Metric female swivel 24°
with O-ring

45° elbow – Heavy series –
Metric swivel nut –
ISO 12151-2

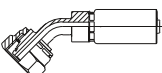

56	E-46
9X	E-57
NX	E-71
PC	C-32
PX	E-79

1C Metric female swivel 24°
with O-ring

90° elbow – Heavy series –
Metric swivel nut –
ISO 12151-2

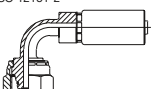



56	E-47
9X	E-57
NX	E-72
PC	C-33
PX	E-80



Hose and Fitting Selection
Fitting overview

Selection

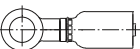
Metric DIN fittings

<p>D0 Metric male 24°</p> <p>Light series – ISO 12151-2</p> 	<p>56 E-44 91N C-14 PC C-33 PX E-81 YX C-43</p>	<p>D2 Metric male 24°</p> <p>Heavy series – ISO 12151-2</p> 	<p>56 E-47 9X E-58 NX E-72 PC C-34 PX E-81 YX C-43</p>	<p>Correspondence between Fitting Part No. and fitting representation in this overview</p> <p>Example: 1 49 EX - 8 - 02</p> <p>See fittings table on page E-68.</p>
<p>49 Banjo union</p> <p>DIN 7642</p> 	<p>56 E-48 EX E-68 PX-LPG D-7</p>			

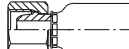
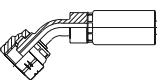
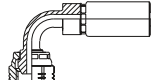
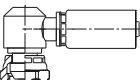
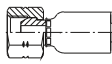
BSP fittings

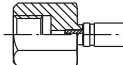
<p>92 BSP female swivel 60° cone</p> 	<p>56 E-49 91N C-17 9X E-58 EX E-65 NX E-73 PC C-35 PX E-83 YX C-44</p>	<p>E1 BSP female swivel 60° cone</p> <p>45° elbow</p> 	<p>56 E-49 PC C-35 PX E-83 YX C-45</p>	<p>B2 BSP female swivel 60° cone</p> <p>90° elbow</p> 	<p>56 E-60 PC C-36 PX E-84 YX C-45</p>
<p>B4 BSP female swivel 60° cone</p> <p>90° compact elbow</p> 	<p>PX E-84 YX C-47</p>	<p>U0 BSP female swivel (ballnose)</p> <p>BSP swivel nut</p> 	<p>NX E-73 PC C-36 PX E-85 PX-LPG D-8 YX C-47</p>	<p>D9 BSP male</p> <p>DIN 3852 Form A</p> 	<p>56 E-51 91N C-17 EX E-65 PC C-37 PX E-86 YX C-48</p>
<p>91 BSP male taper pipe</p> 	<p>PX E-87</p>	<p>BP BSP female</p> <p>Rigid</p> 	<p>EX E-66</p>		

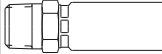
SAE and JIC fittings
01 National Pipe Tapered (NPT) male

56	E-51
91N	C-18
93N	C-27
CG	D-12/E-60
EX	E-66
NX	E-74
PC	C-37
PX	E-87
YX	C-46

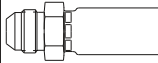
03 SAE (JIC) 37° male

56	E-52
NX	E-74
PC	C-38
PX	E-88
YX	C-46

06 SAE (JIC) 37° female swivel

UNF swivel nut

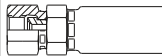

56	E-52
91N	C-19
93N	C-27
9X	E-59
CG	D-12/E-60
EX	E-67
NX	E-75
PC	C-38
PX	E-88
YX	C-49

37 SAE (JIC) 37° female swivel

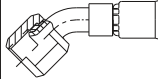
 45° elbow –
 UNF swivel nut

56	E-53
91N	C-20
PC	C-39
PX	E-89
YX	C-50

39 SAE (JIC) 37° female swivel

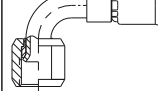
 90° elbow –
 UNF swivel nut

56	E-53
91N	C-20
CG	D-13/E-61
PC	C-40
PX	E-90
YX	C-50

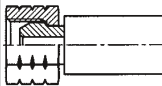
07 NPSM female swivel

91N	C-19
NX	E-75
PC	C-39
PX	E-89
YX	C-49

08 SAE (JIC) 45° female swivel

UNF swivel nut

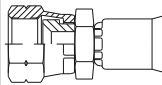

91N	C-21
PX-LPG	D-9

77 SAE (JIC) 45° female swivel

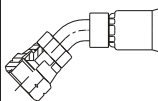
 45° elbow –
 UNF swivel nut

91N	C-21
-----	-------	------

79 SAE (JIC) 45° female swivel

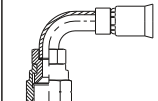
 90° elbow –
 UNF swivel nut

91N	C-22
-----	-------	------

28 SAE (JIC) 45° male swivel

UNF male swivel

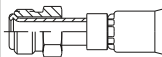

PX-LPG	D-10
--------	-------	------

Hose and Fitting Selection
Fitting overview

Selection

ORFS fittings

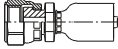
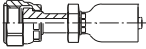
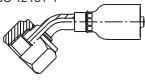
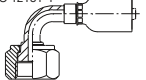
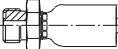
<p>JC O-Lok® ORFS swivel nut</p> <p>Short version – UNF swivel nut ISO 12151-1</p>  <p>56 E-54 91N C-22 93N C-28 CG D-13/E-61 EX E-67 PX E-90</p>	<p>JS O-Lok® ORFS swivel nut</p> <p>Long version – UNF swivel nut ISO 12151-1</p>  <p>PX E-91</p>	<p>Correspondence between Fitting Part No. and fitting representation in this overview</p> <p>Example: 1 J9 91N - 10 - 10</p> <p><small>See fittings table on page C-23.</small></p>
<p>J7 O-Lok® ORFS swivel nut</p> <p>45° elbow – UNF swivel nut ISO 12151-1</p>  <p>56 E-54 91N C-23 93N C-28 CG D-14/E-62 PX E-91</p>	<p>J9 O-Lok® ORFS swivel nut</p> <p>90° elbow – UNF swivel nut ISO 12151-1</p>  <p>56 E-55 91N C-23 93N C-29 CG D-14/E-62 PX E-92</p>	
<p>JO O-Lok® ORFS male</p> <p>ISO 12151-1</p>  <p>56 E-55</p>		

Others

7A LPG 30° male swivel

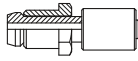

PX-LPG D-8

AL A-Lok® connector with clamp ring

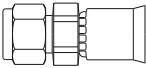

91N C-24

GA Female gas joint

according to NEN 176

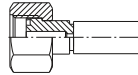

PX E92

P6 CPI® connector with female swivel and clamp ring

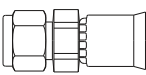

91N C-25

PH LPG quick connector



PX-LPG D-11

Q1 "Ultra Seal" connector

UNF swivel nut

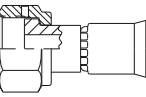

91N C-25

R8 Quick connect fitting with metric swivel nut

Knurled

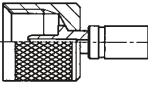

EX E-68

Hose and Fitting Selection
Fitting overview

Selection

Others

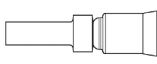
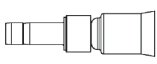
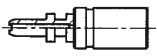
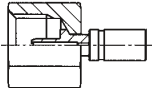
<p>TU A-Lok® tube stub end</p> <p>91N C-26</p> 	<p>YW A-Lok® metric standpipe</p> <p>91N C-26</p> 
<p>YP Quick connect fitting with clip</p> <p>EX E-69</p> 	<p>YR Quick connect fitting with metric swivel nut</p> <p>EX E-69</p> 

Correspondence between Fitting Part No. and fitting representation in this overview

Example:

1 YR EX - 10 - 012

See fittings table on page E-69.

Chapter B

Push-Lok® Hose and Fittings

Push-Lok® hose

Introduction	B-2
830M – Push-Lok® self-grip hose	B-4
838M – Push-Lok® self-grip hose, electrically non-conductive	B-5

Push-Lok®

Fittings for Push-Lok® hose

Push-Lok® fittings – 82 series, see Catalogue CAT/4400-UK

Introduction

Parker Push-Lok® – The Most Complete Line of Premium-Quality, Low-Pressure Hose and Fittings.

Push-lok® is a registered trademark of Parker and is used for low pressure applications up to working pressures of 1.6 Mpa with all sizes of Parker Thermoplastic Hose. The Push Lok® hose and fittings are a qualified system with a design factor of 4:1 (burst pressure > 64 bar). With its “tool-free” assembly due to Parker Push-Lok® fittings it is very well recommended for many applications.



Application



The Push Lok® hose range can be used for a wide range of applications and media such as

- Air systems
- Hydraulic applications
- In plant automotive applications for air, water, lubricating oils and antifreeze fluids.
- Non-conductive cooling systems with de-ionized water
- Energy chains

For details of fluid compatibility please refer to chapter A “Hose selection by fluid compatibility/chemical resistance”

Features

- High abrasion resistance
- Electrically non-conductive
- Free of paint effecting substances (labs free, compliant with automotive requirements)
- Tight bend radius
- Excellent UV and OZONE resistance
- Temperature range from -40°C up to +80°C
- Fast & easy assembly
- No hose clamps required
- Colour variety



Push-Lok®

Benefits

- Long product lifetime
- Less downtime in the application
- Less maintenance necessary compared to other solutions
- Suitable for in plant automotive equipment
- Easy identification of hose function due to colouring
- Safe and fast hose assembly



Push-Lok® Hose and Fittings
830M

830M – Push-Lok® self-grip hose

Labs free



Push-Lok®

MAIN FEATURES

- High abrasion resistance
- Free of paint effecting substances (labs free)
(complies with the requirements of the automotive industry)
- Colour variety
- Assembly with Parker Push-Lok® fittings (no additional clamps required)
- Excellent UV and OZONE resistance

APPLICATIONS

Factory air systems, many hydraulic applications (fluid compatibility see page A-8 ff.); automotive applications for air, water, lubricating oils and antifreeze fluids.
Not recommended for applications where extreme pulsations are encountered.

CONSTRUCTION

Core tube : Polyurethane
Pressure reinforcement : One layer of high tensile synthetic fibre

Cover : Polyurethane
Colour : black, red, green, blue, grey

TEMPERATURE RANGE

-40°C up to +80°C.

Part No. #	DN size				mm	Max. working pressure		Min. burst pressure		Min. bend radius	Weight	Fittings
	mm	inch	mm	inch		MPa	psi	MPa	psi			
830M-4-xxx-RL	6	-04	6.3	1/4	11.2	1.6	232	6.4	928	30	0.10	82
830M-6-xxx-RL	10	-06	9.5	3/8	15.0	1.6	232	6.4	928	50	0.14	82
830M-8-xxx-RL	12	-08	12.7	1/2	19.1	1.6	232	6.4	928	70	0.18	82
830M-10-xxx-RL	16	-10	16	5/8	23.0	1.6	232	6.4	928	75	0.24	82
830M-12-xxx-RL	20	-12	19	3/4	26.0	1.6	232	6.4	928	110	0.28	82

NOTES

Colour code (xxx):
 BLK = black
 BLU = blue
 GRN = green
 TRA = transparent
 RED = red
 Example: 830M-6-GRN-RL



838M – Push-Lok® self-grip hose

Electrically non-conductive / labs free



Push-Lok®

MAIN FEATURES

- **Electrically non-conductive**
- High abrasion resistance
- Free of paint effecting substances (labs free)
(complies with the requirements of the automotive industry)
- Assembly with Parker Push-Lok® fittings
- Excellent UV and OZONE resistance

APPLICATIONS

Especially for applications where a non-conductive hose is required (min. 5 MΩ/m), e.g. for **non-conductive cooling systems with de-ionised water**; factory air systems; many hydraulic applications (fluid compatibility see page A-8 ff.)
 Not recommended for applications where extreme pulsations are encountered.

CONSTRUCTION

Core tube : Polyurethane
Pressure reinforcement : One layer of high tensile synthetic fibre

Cover : Polyurethane
Colour : orange

TEMPERATURE RANGE

-40°C up to +80°C.

Part No. #	DN size				mm	Max. working pressure		Min. burst pressure		Min. bend radius	Weight	Fittings
	mm	inch	mm	inch		MPa	psi	MPa	psi			
838M-4-RL	6	-04	6.3	1/4	11.2	1.6	232	6.4	928	30	0.10	82
838M-6-RL	10	-06	9.5	3/8	15.0	1.6	232	6.4	928	50	0.14	82
838M-8-RL	12	-08	12.7	1/2	19.1	1.6	232	6.4	928	70	0.18	82
838M-10-RL	16	-10	16	5/8	23.0	1.6	232	6.4	928	75	0.24	82
838M-12-RL	20	-12	19	3/4	26.0	1.6	232	6.4	928	110	0.28	82

NOTES

Electrically non-conductive acc. to SAE J517 (less than 50 µA leakage under 250,000 Volts per metre).

Chapter C

PTFE / Fluoropolymer Hose and Fittings

PTFE hose

Introduction	C-2
2030T	– PTFE hose.....	C-4
2030T-##CON	– PTFE hose – convoluted.....	C-5
2033T	– PTFE hose.....	C-6
919	– PTFE hose.....	C-7
919U	– PTFE hose with PU cover.....	C-8
929/929B	– Heavy-wall PTFE hose.....	C-9
939/939B	– PTFE hose – convoluted.....	C-10
2380F	– FEP high pressure hose.....	C-11
2246F	– FEP high pressure hose.....	C-12

PTFE / FEP

Fittings for PTFE hose

91N series	C-13
93N series	C-27
PC series	C-30
YX series	C-41

Introduction

PTFE (polytetrafluoroethylene) is a high performance fluoroplastic with high crystallinity and high molecular weight, discovered in 1938 by DuPont chemist, Dr. Roy J. Plunkett.

Parker PTFE hose provides full conveyance solutions for a wide array of markets and applications because of the unique properties of PTFE. A flexible fluoropolymer tubing with unmatched chemical resistance and a non-stick surface that facilitates flow and eliminates media build up. The Parker PTFE hose portfolio ranges from smooth bore and convoluted hose types to high pressure types with FEP inner core for up to 42.5 MPa.

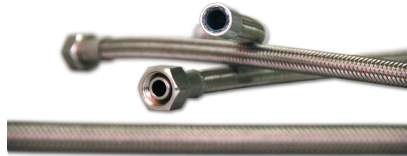

Application



PTFE hoses are used in many different industries and applications

- Transportation and Mobile Hydraulics such as compressor discharge lines and coolant lines
- Fluid Transfer and Handling such as chemicals transfer lines and steam lines, e.g. in the process industry
- Industrial Hydraulics and Pneumatics such as thermo oil line and supply line for hot air

Features

- Chemical resistant to virtually all chemicals and mixed media
- Extreme Temperature range from -73 °C up to +230 °C
- Low friction minimizes pressure drop and build up of deposits
- Convoluted design available for small bend radius and great flexibility
- Resists moisture – no hydrolysis
- Low permeation rate



PTFE / FEP

Benefits

- High operating temperatures
- Handles aggressive Chemicals
- Non-stick and easy to clean
- Low tendency to hydrolysis
- Convoluted versions can be used in very tight installation areas or critical applications to avoid hose kinking

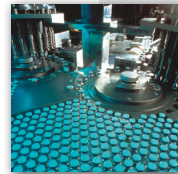

PTFE Hoses
2030T

2030T – PTFE hose



MAIN FEATURES

- Suitable for high temperatures
- Inert to virtually all hydraulic and chemical fluids

PTFE / FEP

APPLICATIONS

Medium pressure service for use with hydraulic fluids at high temperatures and aggressive chemicals in the chemical industry, surface engineering, 2-component systems.
The core tube material conforms to FDA 21 CFR177.1550.

CONSTRUCTION

Core tube : Polytetrafluoroethylene
Pressure reinforcement : One braided layer of stainless steel wire

Cover : –
Colour : –

TEMPERATURE RANGE

-50°C up to +150°C permanent temperature
+230°C at working pressures up to 2 MPa

Part No. #	DN	size		mm	mm	Max. working pressure		Min. burst pressure		Min. bend radius	Weight	Fittings
		mm	inch			MPa	psi	MPa	psi			
2030T-03V70	5	-03	4.7	3/16	7.8	27.5	3,985	110.0	15,950	50	0.09	YX
2030T-04V70	6	-04	6.3	1/4	9.5	24.0	3,480	96.0	13,920	75	0.13	YX
2030T-05V70	8	-05	8.2	5/16	11.5	20.0	2,900	80.0	11,600	100	0.17	YX
2030T-06V70	10	-06	9.7	3/8	13.0	17.5	2,535	70.0	10,150	120	0.19	YX
2030T-08V70	12	-08	12.8	1/2	16.7	15.0	2,175	60.0	8,700	135	0.29	YX
2030T-10V70	16	-10	16.0	5/8	20.0	12.5	1,810	50.0	7,250	160	0.34	YX
2030T-12V70	20	-12	19.4	3/4	23.5	10.0	1,450	40.0	5,800	200	0.41	YX
2030T-16V70	25	-16	25.0	1	29.0	8.0	1,160	32.0	4,640	250	0.51	YX

NOTES

- Not recommended for dynamic applications.

2030T-##CON – PTFE hose – convoluted



MAIN FEATURES

- Suitable for high temperatures
- Inert to virtually all hydraulic and chemical fluids
- **Extremely flexible and small bend radius**

APPLICATIONS

Medium pressure service for use with hydraulic fluids at **high temperatures** and **aggressive fluids** in the chemical and other industries, when **small bend radii and high flexibility** are required.

The core tube material conforms to FDA 21 CFR177.1550. Due to its high purity the hose can also be used in the food industry.

CONSTRUCTION

Core tube : Polytetrafluoroethylene

Pressure reinforcement : One braided layer of stainless steel wire (AISI 304)

Cover : -

Colour : -

TEMPERATURE RANGE

-70°C up to +230°C

PTFE / FEP

Part No. #	DN size				min. max. mm mm		Max. working pressure MPa / psi		Min. burst pressure MPa / psi		Min. bend radius mm	Weight kg/m	Fittings
	mm	inch	mm	inch	mm	mm	MPa	psi	MPa	psi	mm	kg/m	
2030T-04CON	6	-04	6.4	1/4	9.3	9.9	17.2	2,500	68.8	10,000	18	0.11	PC
2030T-05CON	8	-05	8.2	5/16	12.3	12.9	15.5	2,250	62.0	9,000	25	0.16	PC
2030T-06CON	10	-06	9.9	3/8	13.8	14.5	13.8	2,000	55.2	8,000	30	0.21	PC
2030T-08CON	12	-08	12.8	1/2	17.8	18.5	10.3	1,500	41.2	6,000	40	0.25	PC
2030T-10CON	16	-10	16.0	5/8	22.2	23.1	8.3	1,200	33.2	4,800	51	0.30	PC
2030T-12CON	20	-12	19.3	3/4	24.0	25.2	6.9	1,000	27.6	4,000	64	0.37	PC
2030T-16CON	25	-16	25.5	1	32.2	33.3	4.6	670	18.4	2,680	89	0.54	PC
2030T-20CON	32	-20	32.2	1 1/4	40.2	41.5	3.4	490	13.6	1,960	125	0.69	1)

NOTES

1) Factory made assemblies only for size -20.

- For temperatures above 120 °C working pressure is to be adjusted by 1% for each temperature increase of 1 °C (Example: for 170 °C the max. WP is 50% of the value indicated in the table).
- Bigger sizes available on request.

PTFE Hoses
2033T

2033T – PTFE hose



MAIN FEATURES

- Increased working pressure due to two braided layers of stainless steel wire
- Suitable for high temperatures
- Inert to virtually all hydraulic and chemical fluids

APPLICATIONS

Medium pressure service for use with hydraulic fluids at high temperatures and aggressive chemicals in the chemical industry, surface engineering, 2-component systems.
The core tube material conforms to FDA 21 CFR177.1550.

CONSTRUCTION

Core tube : Polytetrafluoroethylene
Pressure reinforcement : Two braided layers of stainless steel wire

Cover : –
Colour : –

TEMPERATURE RANGE

-50°C up to +150°C permanent temperature
+230°C at working pressures up to 2 MPa

Part No. #	DN	size			mm	Max. working pressure		Min. burst pressure		Min. bend radius	Weight	Fittings
		mm	inch	mm		MPa / psi	MPa / psi	kg/m				
2033T-04V70	6	-04	6.3	1/4	11.0	27.5	3,985	110.0	15,950	75	0.23	PX ¹⁾
2033T-05V70	8	-05	8.2	5/16	13.2	25.0	3,625	100.0	14,500	100	0.26	PX ¹⁾
2033T-06V70	10	-06	9.7	3/8	15.0	22.5	3,260	90.0	13,050	120	0.34	PX ¹⁾
2033T-08V70	12	-08	12.8	1/2	18.6	20.0	2,900	80.0	11,600	135	0.47	PX ¹⁾
2033T-10V70	16	-10	16.0	5/8	21.5	17.5	2,535	70.0	10,150	160	0.53	YX
2033T-12V70	20	-12	19.4	3/4	25.5	15.0	2,175	60.0	8,700	200	0.69	YX
2033T-16V70	25	-16	25.0	1	31.0	11.0	1,595	44.0	6,380	250	0.81	YX

NOTES

- 1) Please refer to chapter E for the PX series fittings (page E-91 ff.).
• Not recommended for dynamic applications.

919 – PTFE hose

Performance acc. to SAE 100 R14A



MAIN FEATURES

- Conforms to requirements of SAE 100R14
- 100% working pressure at continuous temperatures of 232 °C max.
- Inert to virtually all hydraulic and chemical fluids
- One-piece fittings suitable for the Parker assembly system

APPLICATIONS

Medium pressure service for use with hydraulic fluids at high temperatures, steam and aggressive chemicals in the chemical industry. Especially suitable for the food industry.
 The core tube material conforms to FDA 21 CFR177.1550.

CONSTRUCTION

Core tube : Polytetrafluoroethylene
Pressure reinforcement : One braided layer of stainless steel wire (AISI304)

Cover : -
Colour : -

TEMPERATURE RANGE

-73°C up to +232°C

PTFE / FEP

Part No. #	DN size		mm		inch	mm	Max. working pressure MPa / psi		Min. burst pressure MPa / psi		Min. bend radius mm	Weight kg/m	Fittings
919-4	5	-4	4.7	3/16	7.8	21.0	3,000	84.0	12,000	51	0.09	91N	
919-5	6	-5	6.5	1/4	9.5	21.0	3,000	84.0	12,000	76	0.13	91N	
919-6	8	-6	7.9	5/16	11.0	17.5	2,500	70.0	10,000	102	0.15	91N	
919-8	10	-8	10.5	13/32	13.5	14.0	2,000	56.0	8,000	127	0.19	91N	
919-10	12	-10	12.7	1/2	15.9	10.5	1,500	42.0	6,000	165	0.22	91N	
919-12	16	-12	15.9	5/8	19.1	8.4	1,200	33.5	4,800	191	0.28	91N	
919-16	22	-16	22.2	7/8	26.2	7.0	1,000	28.0	4,000	229	0.40	91N	

NOTES

- Vacuum rating: 95 kPa (13.8 psi) size -4 up to -10
 40 kPa (5.8 psi) size -12
 47 kPa (6.8 psi) size -16

PTFE Hoses
919U

919U – PTFE hose with PU cover

Performance exceeds SAE 100 R14A



MAIN FEATURES

- With polyurethane cover
- Inert to virtually all hydraulic and chemical fluids
- One-piece fittings suitable for the Parker assembly system

PTFE / FEP

APPLICATIONS

Medium pressure service for use with hydraulic fluids at high temperatures and aggressive chemicals in the chemical industry, when **high abrasion resistance** is required.
Suitable for the food industry. The core tube material conforms to FDA 21 CFR177.1550.

CONSTRUCTION

Core tube : Polytetrafluoroethylene
Pressure reinforcement : One braided layer of stainless steel wire

Cover : Polyurethane
Colour : black

TEMPERATURE RANGE

-40°C up to +135°C

Part No. #	ID mm	ID inch	OD mm	OD inch	Wall thickness mm	Max. working pressure MPa / psi		Min. burst pressure MPa / psi		Min. bend radius mm	Weight kg/m	Fittings
919U-4	4.8	3/16	9.5	3/8	0.76	21.0	3,000	83.0	12,000	51	0.12	91N
919U-6	7.9	5/16	12.7	1/2	0.76	17.5	2,500	69.0	10,000	101	0.20	91N
919U-8	10.3	13/32	15.9	5/8	0.76	14.0	2,000	56.0	8,000	127	0.22	91N
919U-12	15.9	5/8	21.4	27/32	0.76	8.3	1,200	34.5	5,000	191	0.33	91N
919U-16	22.2	7/8	27.0	1 1/16	0.89	6.9	1,000	27.5	4,000	229	0.47	91N

NOTES

- Vacuum rating: 95 kPa (13.8 psi) size -4 up to -8
40 kPa (5.8 psi) size -12
47 kPa (6.8 psi) size -16.
- Cover must be skived prior to fitting attachment.



929/929B – Heavy-wall PTFE hose

929: Performance acc./exceeds SAE 100 R14A

929B: Performance exceeds SAE 100 R14B



MAIN FEATURES

- Heavy-wall core tube
- Suitable for high temperatures
- Inert to virtually all hydraulic and chemical fluids
- One-piece fittings suitable for the Parker assembly system

APPLICATIONS

Medium pressure service for use with hydraulic fluids at high temperatures, steam and aggressive chemicals in the chemical industry, when **low permeation is essential**.

Suitable for the food industry. The core tube material conforms to FDA 21 CFR177.1550 (except 929B).

CONSTRUCTION

Core tube : Heavy-wall polytetrafluoroethylene; 929B: conductive
Pressure reinforcement : One braided layer of stainless steel wire

Cover : -

Colour : -

TEMPERATURE RANGE

-73°C up to +232°C

PTFE / FEP

Part No. #	ID mm	ID inch	OD mm	OD inch	Wall thickness mm	Max. working pressure MPa / psi		Min. burst pressure MPa / psi		Min. bend radius mm	Weight kg/m	Fittings
929/929B-4	4.8	3/16	7.9	5/16	1.02	21.0	3,000	83.0	12,000	38	0.12	91N
929/929B-6	7.9	5/16	11.1	7/16	1.02	17.5	2,500	69.0	10,000	89	0.18	91N
929/929B-8	10.3	13/32	14.3	9/16	1.07	14.0	2,000	56.0	8,000	114	0.23	91N
929B-12	15.9	5/8	19.1	3/4	1.22	8.4	1,200	33.6	4,800	165	0.28	91N
929B-16	22.2	7/8	28.6	1 1/8	1.22	8.8	1,250	35.0	5,000	188	0.73	91N

NOTES

- Vacuum rating: 95 kPa (13.8 psi) size -4 up to -8
 40 kPa (5.8 psi) size -12
 47 kPa (6.8 psi) size -16.
- 929B for use in explosion protected areas with black, static dissipative core tube.

PTFE Hoses
939/939B

939/939B – PTFE hose – convoluted



MAIN FEATURES

- Suitable for high temperatures
- Inert to virtually all hydraulic and chemical fluids
- **Extremely flexible and small bend radius**

PTFE / FEP

APPLICATIONS

Medium pressure service for use with hydraulic fluids at **high temperatures** and **aggressive fluids** in the chemical and other industries, when **small bend radii** and **high flexibility** are required.
The core tube material conforms to FDA 21 CFR177.1550 (except 939B).

CONSTRUCTION

Core tube : Polytetrafluoroethylene, 939B: conductive
Pressure reinforcement : One braided layer of stainless steel wire

Cover : -
Colour : -

TEMPERATURE RANGE

-73°C up to +232°C

Part No. #	DN size			mm	Max. working pressure		Min. burst pressure		Min. bend radius	Weight	Fittings	
	mm	inch	mm		MPa / psi	MPa / psi	mm	kg/m				
939/939B-6	10	-06	9.5	3/8	15.0	10.3	1,500	41.5	6,000	57	0.18	93N
939/939B-8	12	-08	12.7	1/2	20.1	9.5	1,350	37.5	5,400	73	0.31	93N
939/939B-10	16	-10	15.9	5/8	22.4	6.9	1,000	27.5	4,000	76	0.36	93N
939/939B-12	20	-12	19.1	3/4	27.7	7.5	1,100	30.5	4,400	95	0.47	93N
939/939B-16	25	-16	25.4	1	33.8	6.9	1,000	27.5	4,000	127	0.67	93N
939/939B-20	32	-20	31.8	1 1/4	44.5	6.9	1,000	27.5	4,000	159	1.04	93N
939/939B-24	40	-24	38.1	1 1/2	52.1	5.0	750	21.0	3,000	191	1.18	93N
939/939B-32	50	-32	50.8	2	65.0	1.7	250	6.9	1,000	254	1.50	93N

NOTES

- Vacuum rating:
 - 95 kPa (13.8 psi) size -6 up to -16
 - 67 kPa (9.8 psi) size -20
 - 40 kPa (5.8 psi) size -24
 - 17 kPa (2.5 psi) size -32.



2380F – FEP high pressure hose



MAIN FEATURES

- Working pressures up to 42 MPa
- With polyurethane cover
- Inert to virtually all hydraulic and chemical fluids

APPLICATIONS

Glue applications in the automotive industry and material lines for temperatures below +80°C.

CONSTRUCTION

Core tube : Fluoroethylenepropylene
Pressure reinforcement : Two spiral layers and two open spiral layers of high tensile steel wire
Cover : Polyurethane
Colour : grey

TEMPERATURE RANGE

-40°C up to +80°C

Part No. #	DN size				mm	Max. working pressure		Min. burst pressure		Min. bend radius	Weight	Fittings
	mm	inch	mm	inch		MPa / psi	MPa / psi	mm	kg/m			
2380F-04V07	6	-04	6.3	1/4	12.5	42.5	6,160	170.0	24,650	60	0.26	NX ¹⁾
2380F-05V07	8	-05	8.0	5/16	14.3	37.5	5,435	150.0	21,750	85	0.35	NX ¹⁾
2380F-06V07	10	-06	9.7	3/8	17.0	35.0	5,075	140.0	20,300	110	0.41	NX ¹⁾
2380F-08V07	12	-08	12.8	1/2	20.5	32.5	4,710	130.0	18,850	140	0.58	NX ¹⁾
2380F-10V07	16	-10	16.0	5/8	24.5	30.0	4,350	120.0	17,400	175	0.75	NX ¹⁾
2380F-12V07	20	-12	19.4	3/4	28.5	27.5	3,985	110.0	15,950	205	0.96	NX ¹⁾
2380F-16V07	25	-16	25.0	1	34.0	22.5	3,260	90.0	13,050	240	1.28	NX ¹⁾

NOTES

- 1) Please refer to chapter E for the NX series fittings (page E-81 ff.).
 - For pinpricked hose please add "-P", e.g. **2380F-04V07-P**.
 - Not recommended for applications where extreme pulsations are encountered.

PTFE Hoses
2246F

2246F – FEP high pressure hose

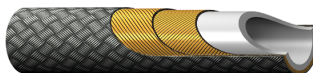

MAIN FEATURES

- Working pressures up to 41.5 MPa
- Without hose cover
- Suitable for temperatures up to 150 °C
- Inert to virtually all hydraulic and chemical fluids

APPLICATIONS

- Suitable for applications with additional heating elements
- Hotmelt applications in the automotive industry

CONSTRUCTION

Core tube : Fluoroethylenpropylene
Pressure reinforcement : Two spiral layers and one braided layer of high tensile steel wire
Cover : –
Colour : –

TEMPERATURE RANGE

-50°C up to +150°C

Part No. #	DN size		mm	mm	Max. working pressure		Min. burst pressure		Min. bend radius	Weight	Fittings	
	mm	inch			MPa / psi	MPa / psi	kg/m					
2246F-04V70	6	-04	6.3	1/4	11.4	41.5	6,015	165.0	23,925	60	0.26	NX ¹⁾
2246F-05V70	8	-05	8.2	5/16	13.8	37.5	5,435	150.0	21,750	85	0.33	NX ¹⁾
2246F-06V70	10	-06	9.7	3/8	16.0	34.0	4,930	136.0	19,720	110	0.35	NX ¹⁾
2246F-08V70	12	-08	12.8	1/2	18.5	32.5	4,710	130.0	18,850	140	0.53	NX ¹⁾
2246F-10V70	16	-10	16.0	5/8	23.4	30.0	4,350	120.0	17,400	175	0.70	NX ¹⁾
2246F-12V70	20	-12	19.4	3/4	27.0	26.5	3,840	106.0	15,370	205	0.92	NX ¹⁾
2246F-16V70	25	-16	25.0	1	32.5	21.0	3,045	84.0	12,180	240	1.18	NX ¹⁾

NOTES

- 1) Please refer to chapter E for the NX series fittings (page E-81 ff.).
- Not recommended for applications where extreme pulsations are encountered.



919 • 919U • 929 • 929B



Fittings
1C391N

1C391N – Metric female swivel 24°/60° Light series – Metric swivel nut

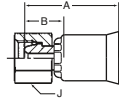

MATERIAL Galvanised steel with transparent Cr(VI)-free plating.
For stainless steel (AISI 316) please add **C** to the Part No. Example: 1C391N-6-4**C**.
Other materials available on request.

Part No. #	DN	size		Thread size	Connection type			J mm	Max. WP MPa
		mm	inch		Tube OD mm	A mm	B mm		
1C391N-6-4-RD	5	-04	4.8 / 3/16	M12x1.5	6	29	14	14	25.0
1C391N-6-5-RD	6	-05	6.4 / 1/4	M12x1.5	6	30	14	14	25.0
1C391N-8-5-RD	6	-05	6.4 / 1/4	M14x1.5	8	31	14	17	25.0
1C391N-8-6-RD	8	-06	7.9 / 5/16	M14x1.5	8	32	14	17	25.0
1C391N-10-6-RD	8	-06	7.9 / 5/16	M16x1.5	10	34	16	19	25.0
1C391N-10-8-RD	10	-08	10.3 / 13/32	M16x1.5	10	36	17	19	25.0
1C391N-12-8-RD	10	-08	10.3 / 13/32	M18x1.5	12	35	15	22	25.0
1C391N-12-10-RD	12	-10	12.7 / 1/2	M18x1.5	12	38	18	22	25.0
1C391N-15-10-RD	12	-10	12.7 / 1/2	M22x1.5	15	37	17	27	25.0
1C391N-18-10-RD	12	-10	12.7 / 1/2	M26x1.5	18	37	17	32	16.0
1C391N-18-12-RD	16	-12	15.9 / 5/8	M26x1.5	18	40	17	32	16.0
1C391N-22-16-RD	22	-16	22.2 / 7/8	M30x2	22	49	22	36	16.0

PTFE / FEP

Fittings
1D091N

919 • 919U • 929 • 929B



1D091N – Metric male 24°

Light series
ISO 12151-2

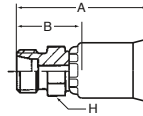

MATERIAL Galvanised steel with transparent Cr(VI)-free plating.
For stainless steel (AISI 316) please add **C** to the Part No. Example: 1D091N-8-6**C**.
Other materials available on request.

PTFE / FEP

Part No. #	DN size				Connection type		A mm	B mm	H mm	Max. WP MPa
	mm	inch	Thread size	Tube OD						
1D091N-6-4	5	-04	4.8	3/16	M12x1.5	6	31	16	12	25.0
1D091N-8-5	6	-05	6.4	1/4	M14x1.5	8	33	16	14	42.5
1D091N-8-6	8	-06	7.9	5/16	M14x1.5	8	34	16	14	42.5
1D091N-10-6	8	-06	7.9	5/16	M16x1.5	10	35	17	17	40.0
1D091N-10-8	10	-08	10.3	13/32	M16x1.5	10	39	19	17	40.0
1D091N-12-8	10	-08	10.3	13/32	M18x1.5	12	39	19	19	35.0
1D091N-12-10	12	-10	12.7	1/2	M18x1.5	12	41	20	19	35.0
1D091N-15-10	12	-10	12.7	1/2	M22x1.5	15	42	21	22	31.0
1D091N-18-12	16	-12	15.9	5/8	M26x1.5	18	46	23	27	28.0
1D091N-22-16	22	-16	22.2	7/8	M30x2	22	54	27	30	28.0



919 • 919U • 929 • 929B



Fittings
11D91N

11D91N – Metric standpipe

Light series

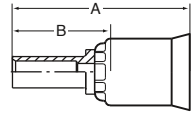

MATERIAL Galvanised steel with transparent Cr(VI)-free plating.
For stainless steel (AISI 316) please add **C** to the Part No. Example: 11D91N-8-6**C**.
Other materials available on request.

Part No. #	DN	size	mm	inch	Tube OD mm	A mm	B mm	Max. WP MPa
11D91N-6-4	5	-04	4.8	3/16	6	44	29	25.0
11D91N-6-5	6	-05	6.4	1/4	6	43	26	25.0
11D91N-8-5	6	-05	6.4	1/4	8	47	30	25.0
11D91N-8-6	8	-06	7.9	5/16	8	46	28	25.0
11D91N-10-6	8	-06	7.9	5/16	10	45	27	25.0
11D91N-10-8	10	-08	10.3	13/32	10	47	27	25.0
11D91N-12-8	10	-08	10.3	13/32	12	53	34	25.0
11D91N-12-10	12	-10	12.7	1/2	12	47	27	25.0
11D91N-15-10	12	-10	12.7	1/2	15	49	29	25.0
11D91N-18-10	12	-10	12.7	1/2	18	50	30	16.0
11D91N-18-12	16	-12	15.9	5/8	18	53	30	16.0
11D91N-22-16	22	-16	22.2	7/8	22	60	33	16.0

PTFE / FEP

Fittings
13D91N

919 • 919U • 929 • 929B



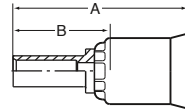

13D91N – Metric standpipe Heavy series

MATERIAL Galvanised steel with transparent Cr(VI)-free plating.
For stainless steel (AISI 316) please add **C** to the Part No. Example: 13D91N-6-3**C**.
Other materials available on request.



PTFE / FEP

Part No. #	DN	size	mm	inch	Tube OD mm	A mm	B mm	Max. WP MPa
								
13D91N-6-3	3	-03	3.2	1/8	6	41	30	63.0
13D91N-8-4	5	-04	4.8	3/16	8	43	27	63.0
13D91N-10-5	6	-05	6.4	1/4	10	46	29	63.0
13D91N-12-6	8	-06	7.9	5/16	12	48	30	63.0
13D91N-14-8	10	-08	10.3	13/32	14	53	33	63.0
13D91N-16-10	12	-06	12.7	1/2	16	55	35	40.0
13D91N-20-12	16	-10	15.9	5/8	20	63	40	40.0
13D91N-25-16	22	-12	22.2	7/8	25	71	44	40.0
13D91N-30-16	22	-16	22.2	7/8	30	75	48	25.0



919 • 919U • 929 • 929B



Fittings
19291N – 1D991N

19291N – BSP female swivel 60° cone

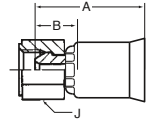

MATERIAL Galvanised steel with transparent Cr(VI)-free plating.
For stainless steel (AISI 316) please add **C** to the Part No. Example: 19291N-4-4**C**-RD.
Other materials available on request.

Part No. #	DN size				Connection type		A mm	B mm	J mm	Max. WP MPa
	mm	inch	Thread size	Tube OD inch						
19291N-4-4-RD	5	-04	4.8	3/16	G 1/4	1/4	27	11	19	63.0
19291N-4-5-RD	6	-05	6.4	1/4	G 1/4	1/4	28	11	19	63.0
19291N-6-6-RD	8	-06	7.9	5/16	G 3/8	3/8	33	15	22	55.0
19291N-6-8-RD	10	-08	10.3	13/32	G 3/8	3/8	34	15	22	55.0
19291N-8-10-RD	12	-10	12.7	1/2	G 1/2	1/2	37	17	27	43.0
19291N-12-12-RD	16	-12	15.9	5/8	G 3/4	3/4	40	17	32	35.0
19291N-12-16-RD	22	-16	22.2	7/8	G 3/4	3/4	46	19	32	35.0

PTFE / FEP

1D991N – BSP male DIN 3852 Form A

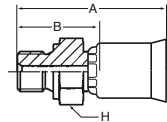

MATERIAL Galvanised steel with transparent Cr(VI)-free plating.
For stainless steel (AISI 316) please add **C** to the Part No. Example: 1D991N-6-6**C**.
Other materials available on request.

Part No. #	DN size				Connection type		A mm	B mm	H mm	Max. WP MPa
	mm	inch	Thread size	Tube OD inch						
1D991N-4-4	5	-04	4.8	3/16	G 1/4	1/4	38	23	19	63.0
1D991N-4-5	6	-05	6.4	1/4	G 1/4	1/4	38	22	19	63.0
1D991N-6-6	8	-06	7.9	5/16	G 3/8	3/8	40	22	22	55.0
1D991N-6-8	10	-08	10.3	13/32	G 3/8	3/8	41	21	22	55.0
1D991N-8-10	12	-10	12.7	1/2	G 1/2	1/2	47	27	27	43.0
1D991N-12-12	16	-12	15.9	5/8	G 3/4	3/4	51	28	32	35.0
1D991N-12-16	22	-16	22.2	7/8	G 3/4	3/4	57	30	32	35.0



Fittings
10191N

919 • 919U • 929 • 929B



10191N – National Pipe Tapered (NPT) male

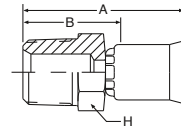

MATERIAL Galvanised steel with transparent Cr(VI)-free plating.
For stainless steel (AISI 303) please add **C** to the Part No. Example: 10191N-4-6**C**.
Other materials available on request.

PTFE / FEP

Part No. #	DN		size		mm	inch	Connection type	A mm	B mm	H inch	Max. WP MPa
	mm	inch	Thread size								
10191N-2-4	5	-04	4.8	3/16			1/8 - 27NPTF	32	19	1/2	34.5
10191N-4-4	5	-04	4.8	3/16			1/4 - 18NPTF	38	24	1/2	34.5
10191N-4-5	6	-05	6.4	1/4			1/4 - 18NPTF	39	25	9/16	34.5
10191N-4-6	8	-06	7.9	5/16			1/4 - 18NPTF	41	24	5/8	34.5
10191N-6-6	8	-06	7.9	5/16			3/8 - 18NPTF	42	25	5/8	27.5
10191N-4-8	10	-08	10.3	13/32			1/4 - 18NPTF	50	30	7/8	34.5
10191N-6-8	10	-08	10.3	13/32			3/8 - 18NPTF	43	25	3/4	27.5
10191N-8-8	10	-08	10.3	13/32			1/2 - 14NPTF	49	32	3/4	24.0
10191N-8-10	12	-10	12.7	1/2			1/2 - 14NPTF	50	32	7/8	24.0
10191N-8-12	16	-12	15.9	5/8			1/2 - 14NPTF	61	38	1 1/8	24.0
10191N-12-12	16	-12	15.9	5/8			3/4 - 14NPTF	56	35	1	21.0
10191N-16-16	22	-16	22.2	7/8			1 - 11 1/2NPTF	60	38	1 3/8	17.0



919 • 919U • 929 • 929B



Fittings
10691N – 10791N

10691N – SAE (JIC) 37° female swivel UNF swivel nut

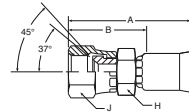

MATERIAL Galvanised steel with transparent Cr(VI)-free plating.
For stainless steel (AISI 316) please add **C** to the Part No. Example: 10691N-6-6**C**.
Other materials available on request.

Part No. #	DN size				Connection type		A mm	B mm	H inch	J inch	Max. WP MPa
	mm	inch	Thread size	Tube OD inch							
10691N-4-4	5	-04	4.8	3/16	7/16 - 20UNF	1/4	36	22	3/8	9/16	41.0
10691N-5-5	6	-05	6.4	1/4	1/2 - 20UNF	5/16	40	24	7/16	5/8	41.0
10691N-6-6	8	-06	7.9	5/16	9/16 - 18UNF	3/8	41	25	1/2	11/16	34.5
10691N-8-8	10	-08	10.3	13/32	3/4 - 16UNF	1/2	48	30	11/16	7/8	34.5
10691N-10-10	12	-10	12.7	1/2	7/8 - 14UNF	5/8	52	33	13/16	1	34.5
10691N-12-12	16	-12	15.9	5/8	1 1/16 - 12UNF	3/4	54	33	1	1 1/4	34.5
10691N-16-16	22	-16	22.2	7/8	1 5/16 - 12UNF	1	62	40	1 1/4	1 1/2	27.5

PTFE / FEP

10791N – NPSM female swivel

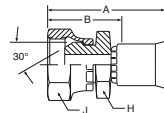

MATERIAL Galvanised steel with transparent Cr(VI)-free plating.
For stainless steel (AISI 303) please add **C** to the Part No. Example: 10791N-4-4**C**.
Other materials available on request.

Part No. #	DN size				Connection type		A mm	B mm	H inch	J inch	Max. WP MPa
	mm	inch	Thread size	Tube OD inch							
10791N-4-4	5	-04	4.8	3/16	1/4 - 18NPSM	1/4	38	24	9/16	3/4	34.5
10791N-6-6	8	-06	7.9	5/16	3/8 - 18NPSM	3/8	42	25	5/8	7/8	27.5
10791N-8-8	10	-08	10.3	13/32	1/2 - 14NPSM	1/2	46	29	3/4	1	24.0
10791N-12-12	16	-12	15.9	5/8	3/4 - 14NPSM	3/4	53	33	1	1 1/4	21.0
10791N-16-16	22	-16	22.2	7/8	1 - 11 1/2NPSM	1	57	33	1 3/16	1 3/8	17.0

Fittings
13791N – 13991N

919 • 919U • 929 • 929B



13791N – SAE (JIC) 37° female swivel 45° elbow – UNF swivel nut

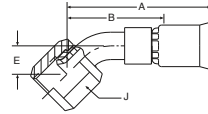

MATERIAL Galvanised steel with transparent Cr(VI)-free plating.
Other materials available on request.

PTFE / FEP

Part No. #	DN size			Connection type		Tube OD inch	A mm	B mm	E mm	J inch	Max. WP MPa
	mm	inch	Thread size	Thread size							
13791N-4-4	5	-04	4.8	3/16	7/16 - 20UNF	1/4	44	29	8	9/16	41.0
13791N-5-5	6	-05	6.4	1/4	1/2 - 20UNF	5/16	50	30	9	5/8	41.0
13791N-6-6	8	-06	7.9	5/16	9/16 - 18UNF	3/8	51	32	14	11/16	34.5
13791N-8-8	10	-08	10.3	13/32	3/4 - 16UNF	1/2	59	41	14	7/8	34.5
13791N-10-10	12	-10	12.7	1/2	7/8 - 14UNF	5/8	65	49	16	1	34.5
13791N-12-12	16	-12	15.9	5/8	1 1/16 - 12UNF	3/4	72	52	20	1 1/4	34.5
13791N-16-16	22	-16	22.2	7/8	1 5/16 - 12UNF	1	80	57	23	1 1/2	27.5

13991N – SAE (JIC) 37° female swivel 90° elbow – UNF swivel nut

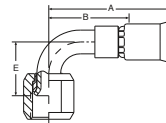

MATERIAL Galvanised steel with transparent Cr(VI)-free plating.
Other materials available on request.

Part No. #	DN size			Connection type		Tube OD inch	A mm	B mm	E mm	J inch	Max. WP MPa
	mm	inch	Thread size	Thread size							
13991N-4-4	5	-04	4.8	3/16	7/16 - 20UNF	1/4	41	27	24	9/16	41.0
13991N-5-5	6	-05	6.4	1/4	1/2 - 20UNF	5/16	43	29	20	5/8	41.0
13991N-6-6	8	-06	7.9	5/16	9/16 - 18UNF	3/8	49	32	22	11/16	34.5
13991N-8-8	10	-08	10.3	13/32	3/8 - 16UNF	1/2	52	30	28	7/8	34.5
13991N-10-10	12	-10	12.7	1/2	7/8 - 14UNF	5/8	61	43	31	1	34.5
13991N-12-12	16	-12	15.9	5/8	1 1/16 - 12UNF	3/4	76	54	46	1 1/2	34.5
13991N-16-16	22	-16	22.2	7/8	1 5/16 - 12UNF	1	80	56	54	1 1/2	27.5



919 • 919U • 929 • 929B



Fittings
10891N – 17791N

10891N – SAE (JIC) 45° female swivel UNF swivel nut

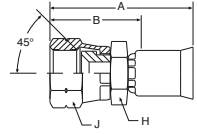

MATERIAL Galvanised steel with transparent Cr(VI)-free plating.
Other materials available on request.

Part No. #	DN size				Connection type		A mm	B mm	H inch	J inch	Max. WP MPa
	mm	inch	Thread size	Tube OD inch							
10891N-6-6	8	-06	7.9	5/16	5/8 - 18UNF	3/8	43	27	5/8	3/4	34.5
10891N-12-12	16	-12	15.9	5/8	1 1/16 - 14UNF	3/4	54	33	1	1 1/4	34.5

PTFE / FEP

17791N – SAE (JIC) 45° female swivel 45° elbow – UNF swivel nut

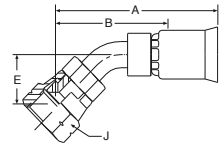

MATERIAL Galvanised steel with transparent Cr(VI)-free plating.
Other materials available on request.

Part No. #	DN size				Connection type		A mm	B mm	E mm	J inch	Max. WP MPa
	mm	inch	Thread size	Tube OD inch							
17791N-6-6	8	-06	7.9	5/16	5/8 - 18UNF	3/8	52	33	10	3/4	34.5
17791N-12-12	16	-12	15.9	5/8	1 1/16 - 14UNF	3/4	78	62	20	1 1/4	34.5



Fittings
17991N – 1JC91N

919 • 919U • 929 • 929B



17991N – SAE (JIC) 45° female swivel 90° elbow – UNF swivel nut

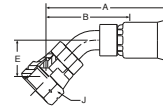

MATERIAL Galvanised steel with transparent Cr(VI)-free plating.
Other materials available on request.

PTFE / FEP

Part No. #	DN size				Connection type		A mm	B mm	E mm	J inch	Max. WP MPa
	mm	inch	Thread size	Tube OD inch							
17991N-6-6	8	-06	7.9	5/16	5/8 - 18UNF	3/8	52	49	30	3/4	34.5
17991N-12-12	16	-12	15.9	5/8	1 1/16 - 14UNF	3/4	74	54	46	1 1/4	34.5

1JC91N – O-Lok® ORFS swivel nut Short version – UNF swivel nut – ISO 12151-1

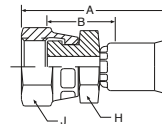

MATERIAL Galvanised steel with transparent Cr(VI)-free plating.
For stainless steel (AISI 303) please add **C** to the
Part No. Example: 1JC91N-8-8C.
Other materials available on request.

Part No. #	DN size				Connection type Thread size	A mm	B mm	H inch	J inch	Max. WP MPa
	mm	inch	Thread size							
1JC91N-4-4	5	-04	4.8	3/16	9/16 - 18UNF	37	16	9/16	11/16	41.0
1JC91N-6-6	8	-06	7.9	5/16	11/16 - 16UNF	39	14	5/8	13/16	41.0
1JC91N-8-8	10	-08	10.3	13/32	13/16 - 16UNF	49	21	3/4	15/16	41.0
1JC91N-10-10	12	-10	12.7	1/2	1 - 14UNF	48	30	7/8	1 1/8	41.0
1JC91N-12-10	12	-10	12.7	1/2	1 3/16 - 12UNF	50	32	15/16	1 1/4	41.0
1JC91N-12-12	16	-12	15.9	5/8	1 3/16 - 12UNF	52	32	15/16	1 3/8	41.0
1JC91N-16-16	16	-12	15.9	5/8	1 7/16 - 12UNF	65	40	1.1	1 5/8	41.0
1JC91N-20-16	22	-16	22.2	7/8	1 11/16 - 12UNF	58	35	1 5/8	1 7/8	27.5



919 • 919U • 929 • 929B



Fittings
1J791N – 1J991N

1J791N – O-Lok® ORFS swivel nut 45° elbow – UNF swivel nut

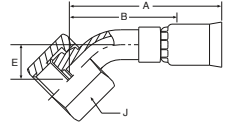

MATERIAL Galvanised steel with transparent Cr(VI)-free plating.
Other materials available on request.

Part No. #	DN size				Connection type		A mm	B mm	E mm	J inch	Max. WP MPa
	mm	inch	Thread size	Tube OD inch							
1J791N-4-4	5	-04	4.8	3/16	9/16 - 18UNF	1/4	44	32	10	11/16	41.0
1J791N-4-6	8	-06	7.9	5/16	9/16 - 18UNF	1/4	49	33	10	11/16	41.0
1J791N-6-6	8	-06	7.9	5/16	11/16 - 16UNF	3/8	51	35	11	13/16	41.0
1J791N-8-8	10	-08	10.3	13/32	13/16 - 16UNF	1/2	55	38	15	15/16	41.0
1J791N-10-10	12	-10	12.7	1/2	1 - 14UNF	5/8	63	44	15	1 1/8	41.0
1J791N-12-12	16	-12	15.9	5/8	1 3/16 - 12UNF	3/4	70	49	21	1 3/8	41.0
1J791N-16-16	22	-16	22.2	7/8	1 7/16 - 12UNF	1	89	64	24	1 5/8	41.0

PTFE / FEP

1J991N – O-Lok® ORFS swivel nut 90° elbow – UNF swivel nut

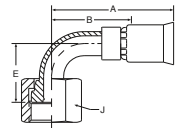

MATERIAL Galvanised steel with transparent Cr(VI)-free plating.
Other materials available on request.

Part No. #	DN size				Connection type		A mm	B mm	E mm	J inch	Max. WP MPa
	mm	inch	Thread size	Tube OD inch							
1J991N-4-4	5	-04	4.8	3/16	9/16 - 18UNF	1/4	45	32	21	11/16	41.0
1J991N-6-6	8	-06	7.9	5/16	11/16 - 16UNF	3/8	47	32	23	13/16	41.0
1J991N-8-8	10	-08	10.3	13/32	13/16 - 16UNF	1/2	53	35	29	15/16	41.0
1J991N-10-10	12	-10	12.7	1/2	1 - 14UNF	5/8	57	38	32	1 1/8	41.0
1J991N-12-12	16	-12	15.9	5/8	1 3/16 - 12UNF	3/4	67	48	47	1 3/8	41.0
1J991N-16-16	22	-16	22.2	7/8	1 7/16 - 12UNF	1	88	65	56	1 5/8	41.0



Fittings
1J191N – 1AL91N

919 • 919U • 929 • 929B



1J191N – O-Lok® ORFS swivel nut 90° elbow – Long drop length – UNF swivel nut

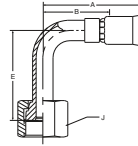

MATERIAL Galvanised steel with transparent Cr(VI)-free plating.
Other materials available on request.

PTFE / FEP

Part No. #	DN size				Connection type		A mm	B mm	E mm	J inch	Max. WP MPa
	mm	inch	Thread size	Tube OD inch							
1J191N-4-4	5	-04	4.8	3/16	9/16 - 18UNF	1/4	42	27	46	11/16	41.0
1J191N-6-5	6	-05	6.4	1/4	11/16 - 16UNF	3/8	49	30	54	13/16	41.0
1J191N-6-6	8	-06	7.9	5/16	11/16 - 16UNF	3/8	49	30	54	13/16	41.0
1J191N-8-8	10	-08	10.3	13/32	13/16 - 16UNF	1/2	55	37	64	15/16	41.0
1J191N-16-16	22	-16	22.2	7/8	1 7/16 - 12UNF	1	80	57	114	1 1/2	41.0

1AL91N – A-Lok® connector with clamp ring

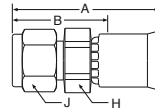

MATERIAL Nipple, swivel nut and ferrule stainless steel (AISI 316);
stainless steel shell (AISI 303)

Part No. #	DN size				Tube OD	A	B	H	J	Max. WP MPa
mm	inch	inch	inch	inch	mm	mm	inch	inch	inch	
1AL91N-4-4C	5	-04	4.8	3/16	1/4	33	11	1/2	9/16	45.5
1AL91N-4-5C	6	-05	6.4	1/4	1/4	25	11	1/2	9/16	45.5
1AL91N-6-6C	8	-06	7.9	5/16	3/8	39	13	5/8	11/16	36.5
1AL91N-8-8C	10	-08	10.3	13/32	1/2	41	11	13/16	7/8	35.9
1AL91N-12-12C	16	-12	15.9	5/8	3/4	47	13	1 1/8	1 1/8	29.7
1AL91N-16-16C	22	-16	22.2	7/8	1	54	11	1 3/8	1 1/2	31.0



919 • 919U • 929 • 929B



Fittings
1P691N – 1Q191N

1P691N – CPI® connector with female swivel and clamp ring

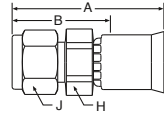

MATERIAL Nipple, swivel nut and ferrule stainless steel (AISI 316);
stainless steel shell (AISI 303)

Part No. #	DN size				Tube OD	A	B	H	J	Max. WP
	mm	inch	mm	inch	inch	mm	mm	inch	inch	MPa
1P691N-4-4C	5	-04	4.8	3/16	1/4	33	11	1/2	9/16	45.5
1P691N-6-6C	8	-06	7.9	5/16	3/8	39	13	5/8	11/16	36.5
1P691N-8-8C	10	-08	10.3	13/32	1/2	41	11	13/16	7/8	35.9

PTFE / FEP

1Q191N – “Ultra Seal” connector UNF swivel nut

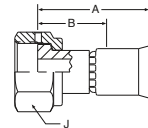

MATERIAL Nipple and swivel nut stainless steel (AISI 316);
stainless steel shell (AISI 303)

Part No. #	DN size				Connection type		A	B	J	Max. WP
	mm	inch	mm	inch	Thread size	Tube OD				
1Q191N-4-4C	5	-04	4.8	3/16	9/16 - 20UNF	1/4	41	19	11/16	21.0
1Q191N-8-8C	10	-08	10.3	13/32	7/8 - 20UNF	1/2	41	24	1	14.0

Fittings
1TU91N – 1YW91N

919 • 919U • 929 • 929B



1TU91N – A-Lok® tube stub end

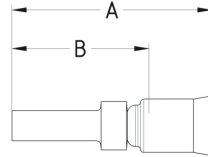

MATERIAL Stainless steel (AISI 303).
Other materials available on request.

PTFE / FEP

Part No. #	DN	size	mm	inch	Tube OD inch	A mm	B mm	Max. WP MPa
1TU91N-4-4C	5	-04	4.8	3/16	1/4	41.4	28.4	21.0
1TU91N-6-6C	8	-06	7.9	5/16	3/8	46.0	30.4	21.0
1TU91N-8-8C	10	-08	10.3	13/32	1/2	57.9	40.8	17.5
1TU91N-12-12C	16	-12	15.9	5/8	3/4	56.9	37.4	14.0
1TU91N-16-16C	22	-16	22.2	7/8	1	69.4	46.5	8.3

1YW91N – A-Lok® metric standpipe

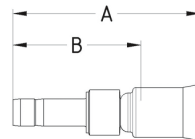

MATERIAL Stainless steel (AISI 303).
Other materials available on request.

Part No. #	DN	size	mm	inch	Tube OD mm	A mm	B mm	Max. WP MPa
1YW91N-6-4C	5	-04	4.8	3/16	6	41.0	28.0	21.0
1YW91N-8-4C	5	-04	4.8	3/16	8	41.9	28.8	21.0
1YW91N-10-6C	8	-06	7.9	5/16	10	47.6	32.0	17.5
1YW91N-12-8C	10	-08	10.3	13/32	12	55.6	38.5	17.5



939 • 939B



Fittings
10193N – 10693N

10193N – National Pipe Tapered (NPT) male

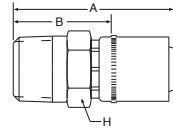

MATERIAL Galvanised steel with transparent Cr(VI)-free plating.
For stainless steel (nipple AISI 316, shell AISI 303)
please add **C** to the Part No. Example: 10193N-8-8**C**.
Other materials available on request.

Part No. #	DN size mm inch				Connection type Thread size	A mm	B mm	H inch	Max. WP MPa
10193N-8-8	12	-08	12.7	1/2	1/2 - 14NPTF	50	38	7/8	24.0
10193N-12-12	20	-12	19.0	3/4	3/4 - 14NPTF	66	43	1 1/8	21.0
10193N-16-16	25	-16	25.4	1	1 - 11 1/2NPTF	76	44	1 3/8	17.0
10193N-20-20	32	-20	31.8	1 1/4	1 1/4 - 11 1/2NPTF	79	48	1 11/16	15.0
10193N-24-24	40	-24	38.1	1 1/2	1 1/2 - 11 1/2NPTF	87	52	2	14.0
10193N-32-32	50	-32	50.8	2	2 - 11 1/2NPTF	94	59	2 1/2	14.0

PTFE / FEP

10693N – SAE (JIC) 37° female swivel UNF swivel nut

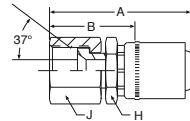

MATERIAL Galvanised steel with transparent Cr(VI)-free plating.
For stainless steel (nipple AISI 316, shell AISI 303)
please add **C** to the Part No. Example: 10693N-8-8**C**.
Other materials available on request.

Part No. #	DN size mm inch				Connection type Thread size	A mm	B mm	H inch	J inch	Max. WP MPa
10693N-8-8	12	-08	12.7	1/2	3/4 - 16UNF	48	35	7/8	7/8	34.5
10693N-10-10	16	-10	15.9	5/8	7/8 - 14UNF	63	41	1	1	34.5
10693N-12-12	20	-12	19.0	3/4	1 1/16 - 12UNF	70	44	1 1/8	1 1/4	34.5
10693N-16-16	25	-16	25.4	1	1 5/16 - 12UNF	78	46	1 3/8	1 1/2	27.5
10693N-20-20	32	-20	31.8	1 1/4	1 5/8 - 12UNF	81	49	1 3/4	1 13/16	20.0
10693N-24-24	40	-24	38.1	1 1/2	1 7/8 - 12UNF	91	57	2	2 1/8	17.0
10693N-32-32	50	-32	50.8	2	2 1/2 - 12UNF	98	62	2 1/2	2 3/4	17.0



Fittings
1JC93N – 1J793N

939 • 939B



1JC93N – O-Lok® ORFS swivel nut

Short version – UNF swivel nut – ISO 12151-1

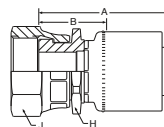

MATERIAL Galvanised steel with transparent Cr(VI)-free plating.
For stainless steel (nipple AISI 316, shell AISI 303)
please add **C** to the Part No. Example: 1JC93N-16-16**C**.
Other materials available on request.

PTFE / FEP

Part No. #	DN size mm inch				Connection type		Tube OD inch	A mm	B mm	H inch	J inch	Max. WP MPa
	size	mm	inch	Thread size	Thread size							
1JC93N-16-16	25	-16	25.4	1	1 7/16 - 12UNF	1	66	35	1 3/8	1 5/8	41.0	
1JC93N-20-20	32	-20	31.8	1 1/4	1 11/16 - 12UNF	1 1/4	65	33	1 5/16	1 7/8	27.5	

1J793N – O-Lok® ORFS swivel nut

45° elbow – UNF swivel nut

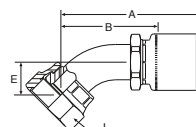

MATERIAL Galvanised steel with transparent Cr(VI)-free plating.
For stainless steel (AISI 316) please add **C** to the
Part No. Example: 1J793N-16-16**C**.
Other materials available on request.

Part No. #	DN size mm inch				Connection type		Tube OD inch	A mm	B mm	E mm	J inch	Max. WP MPa
	size	mm	inch	Thread size	Thread size							
1J793N-20-20	32	-20	31.8	1 1/4	1 11/16 - 12UNF	1 1/4	106	75	25	1 7/8	27.5	

C

 Fittings
1J993N

1J993N – O-Lok® ORFS swivel nut 90° elbow – UNF swivel nut

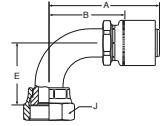

MATERIAL Galvanised steel with transparent Cr(VI)-free plating.
 For stainless steel (AISI 316) please add **C** to the
 Part No. Example: 1J993N-16-16**C**.
 Other materials available on request.

Part No. #	DN size			mm		inch		Connection type		Tube OD inch	A mm	B mm	E mm	J inch	Max. WP MPa
	mm	inch	mm	inch	Thread size	mm	inch								
1J993N-20-20	32	-20	31.8	1 1/4	1	11/16 - 12UNF	1	1 1/4	108	76	64	1 7/8	27.5		

PTFE / FEP

Fittings
1C3PC – 1CAPC

2030T-##CON



1C3PC – Metric female swivel 24°/60°

Light series – Metric swivel nut

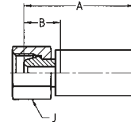

MATERIAL Galvanised steel with transparent Cr(VI)-free plating.
Other materials available on request.

PTFE / FEP

Part No. #	DN size				Connection type		A mm	B mm	J mm	Max. WP MPa
	mm	inch	Thread size	Tube OD mm						
1C3PC-8-04	6	-04	6.4	1/4	M14x1.5	8	46	18	17	25.0
1C3PC-10-04	6	-04	6.4	1/4	M16x1.5	10	46	18	19	25.0
1C3PC-10-05	8	-05	7.9	5/16	M16x1.5	10	46	18	19	25.0
1C3PC-10-06	10	-06	9.5	3/8	M16x1.5	10	49	20	22	25.0
1C3PC-12-06	10	-06	9.5	3/8	M18x1.5	12	48	19	22	25.0
1C3PC-12-08	12	-08	12.7	1/2	M18x1.5	12	52	20	24	25.0
1C3PC-15-08	12	-08	12.7	1/2	M22x1.5	15	51	20	27	25.0

1CAPC – Metric female swivel 24° with O-ring

Light series – Metric swivel nut – ISO 12151-2

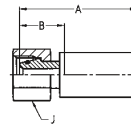

MATERIAL Galvanised steel with transparent Cr(VI)-free plating.
Other materials available on request.

Part No. #	DN size				Connection type		A mm	B mm	J mm	Max. WP MPa
	mm	inch	Thread size	Tube OD mm						
1CAPC-6-04	6	-04	6.4	1/4	M12x1.5	6	48	20	17	31.5
1CAPC-8-04	6	-04	6.4	1/4	M14x1.5	8	51	23	17	42.5
1CAPC-10-04	6	-04	6.4	1/4	M16x1.5	10	50	22	19	40.0
1CAPC-10-05	8	-05	7.9	5/16	M16x1.5	10	50	22	19	40.0
1CAPC-12-05	8	-05	7.9	5/16	M18x1.5	12	50	22	22	35.0
1CAPC-10-06	10	-06	9.5	3/8	M16x1.5	10	51	22	22	40.0
1CAPC-12-06	10	-06	9.5	3/8	M18x1.5	12	52	23	22	35.0
1CAPC-15-08	12	-08	12.7	1/2	M22x1.5	15	59	28	27	31.5
1CAPC-18-10	16	-10	15.9	5/8	M26x1.5	18	56	25	32	31.5
1CAPC-22-12	20	-12	19.0	3/4	M30x2	22	62	27	36	28.0
1CAPC-28-16	25	-16	25.4	1	M36x2	28	64	29	41	21.0



2030T-##CON



Fittings
1C9PC – 1CEPC

1C9PC – Metric female swivel 24° with O-ring

Heavy series – Metric swivel nut – ISO 12151-2

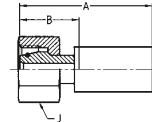

MATERIAL Galvanised steel with transparent Cr(VI)-free plating.
Other materials available on request.

Part No. #	DN size			mm		inch		Connection type		Tube OD mm	A mm	B mm	J mm	Max. WP MPa
	size	mm	inch	Thread size	Tube OD mm									
1C9PC-10-04	6	-04	6.4	1/4	M18x1.5	10	55	27	22	63.0				
1C9PC-12-05	8	-05	7.9	5/16	M20x1.5	12	56	28	24	63.0				
1C9PC-12-06	10	-06	9.5	3/8	M20x1.5	12	54	25	24	63.0				
1C9PC-14-06	10	-06	9.5	3/8	M22x1.5	14	59	30	27	63.0				
1C9PC-16-08	12	-08	12.7	1/2	M24x1.5	16	65	34	30	42.0				
1C9PC-20-10	16	-10	15.9	5/8	M30x2	20	68	37	36	42.0				

PTFE / FEP

1CEPC – Metric female swivel 24° with O-ring

45° elbow – Light series – Metric swivel nut – ISO 12151-2

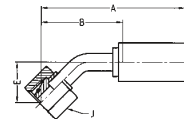

MATERIAL Galvanised steel with transparent Cr(VI)-free plating.
Other materials available on request.

Part No. #	DN size			mm		inch		Connection type		Tube OD mm	A mm	B mm	E mm	J mm	Max. WP MPa
	size	mm	inch	Thread size	Tube OD mm										
1CEPC-6-04	6	-04	6.4	1/4	M12x1.5	6	72	43	23	17	31.5				
1CEPC-8-04	6	-04	6.4	1/4	M14x1.5	8	72	43	23	17	42.5				
1CEPC-10-05	8	-05	7.9	5/16	M16x1.5	10	72	43	20	19	40.0				
1CEPC-10-06	10	-06	9.5	3/8	M16x1.5	10	70	40	18	19	40.0				
1CEPC-12-06	10	-06	9.5	3/8	M18x1.5	12	70	40	18	22	35.0				
1CEPC-15-08	12	-08	12.7	1/2	M22x1.5	15	83	51	21	27	31.5				
1CEPC-18-10	16	-10	15.9	5/8	M26x1.5	18	96	65	27	32	31.5				
1CEPC-22-12	20	-12	19.0	3/4	M30x2	22	114	79	32	36	28.0				
1CEPC-28-16	25	-16	25.4	1	M36x2	28	112	77	35	41	21.0				



Fittings
10CPC – 1CFPC

2030T-##CON



10CPC – Metric female swivel 24° with O-ring

45° elbow – Heavy series – Metric swivel nut – ISO 12151-2

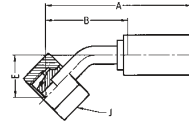

MATERIAL Galvanised steel with transparent Cr(VI)-free plating.
Other materials available on request.

PTFE / FEP

Part No. #	DN size			Connection type		Tube OD mm	A mm	B mm	E mm	J mm	Max. WP MPa
	mm	inch	Thread size	mm	inch						
10CPC-10-04	6	-04	6.4	1/4	M18x1.5	10	74	45	24	22	63.0
10CPC-12-05	8	-05	7.9	5/16	M20x1.5	12	71	42	20	24	63.0
10CPC-14-06	10	-06	9.5	3/8	M22x1.5	14	70	40	19	27	63.0
10CPC-16-08	12	-08	12.7	1/2	M24x1.5	16	85	53	23	30	42.0
10CPC-20-10	16	-10	15.9	5/8	M30x2	20	99	68	29	36	42.0

1CFPC – Metric female swivel 24° with O-ring

90° elbow – Light series – Metric swivel nut – ISO 12151-2

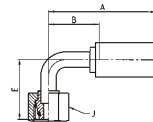

MATERIAL Galvanised steel with transparent Cr(VI)-free plating.
Other materials available on request.

Part No. #	DN size			Connection type		Tube OD mm	A mm	B mm	E mm	J mm	Max. WP MPa
	mm	inch	Thread size	mm	inch						
1CFPC-6-04	6	-04	6.4	3/8	M12x1.5	6	59	30	33	17	31.5
1CFPC-8-04	6	-04	6.4	1/4	M14x1.5	8	59	30	33	17	42.5
1CFPC-10-05	8	-05	7.9	5/16	M16x1.5	10	59	30	33	19	40.0
1CFPC-10-06	10	-06	9.5	3/8	M16x1.5	10	60	30	35	19	40.0
1CFPC-12-06	10	-06	9.5	3/8	M18x1.5	12	60	30	35	22	35.0
1CFPC-15-08	12	-08	12.7	1/2	M22x1.5	15	74	42	42	27	31.5
1CFPC-18-10	16	-10	15.9	5/8	M26x1.5	18	84	53	52	32	31.5
1CFPC-22-12	20	-12	19.0	3/4	M30x2	22	100	65	62	36	28.0



2030T-##CON



Fittings
11CPC – 1D0PC

11CPC – Metric female swivel 24° with O-ring 90° elbow – Heavy series – Metric swivel nut – ISO 12151-2

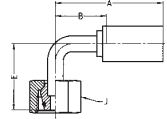

MATERIAL Galvanised steel with transparent Cr(VI)-free plating.
Other materials available on request.

Part No. #	DN size				Connection type		A mm	B mm	E mm	J mm	Max. WP MPa
	mm	inch	Thread size	Tube OD mm							
11CPC-6-04	6	-04	6.4	1/4	M14x1.5	6	59	30	29	17	63.0
11CPC-10-04	6	-04	6.4	1/4	M18x1.5	10	59	30	36	22	63.0
11CPC-12-05	8	-05	7.9	5/16	M20x1.5	12	59	30	36	24	63.0
11CPC-14-06	10	-06	9.5	3/8	M22x1.5	14	60	30	36	27	63.0
11CPC-16-08	12	-08	12.7	1/2	M24x1.5	16	74	42	44	30	42.0
11CPC-20-10	16	-10	15.9	5/8	M30x2	20	84	53	61	36	42.0

PTFE / FEP

1D0PC – Metric male 24° Light series – ISO 12151-2

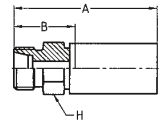

MATERIAL Galvanised steel with transparent Cr(VI)-free plating.
Other materials available on request.

Part No. #	DN size				Connection type		A mm	B mm	H mm	Max. WP MPa
	mm	inch	Thread size	Tube OD mm						
1D0PC-6-04	6	-04	6.4	1/4	M12x1.5	6	51	23	14	25.0
1D0PC-8-04	6	-04	6.4	1/4	M14x1.5	8	51	23	14	42.5
1D0PC-10-05	8	-05	7.9	5/16	M16x1.5	10	54	26	17	40.0
1D0PC-12-06	10	-06	9.5	3/8	M18x1.5	12	56	27	19	40.0
1D0PC-15-06	10	-06	9.5	3/8	M22x1.5	15	57	28	22	31.0
1D0PC-15-08	12	-08	12.7	1/2	M22x1.5	15	59	28	22	31.0
1D0PC-18-10	16	-10	15.9	5/8	M26x1.5	18	59	28	27	28.0
1D0PC-22-12	20	-12	19.0	3/4	M30x2	22	67	32	30	28.0
1D0PC-28-16	25	-16	25.4	1	M36x2	28	67	32	36	21.0



Fittings
1D2PC – 11DPC

2030T-##CON



1D2PC – Metric male 24°

Heavy series – ISO 12151-2

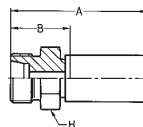

MATERIAL Galvanised steel with transparent Cr(VI)-free plating.
Other materials available on request.

PTFE / FEP

Part No. #	DN size		mm		inch		Connection type				Max. WP MPa
	mm	inch	mm	inch	Thread size	Tube OD mm	A mm	B mm	H mm		
1D2PC-10-04	6	-04	6.4	1/4	M18x1.5	10	55	27	19	63.0	
1D2PC-12-05	8	-05	7.9	5/16	M20x1.5	12	55	27	22	63.0	
1D2PC-14-06	10	-06	9.5	3/8	M22x1.5	14	59	30	22	63.0	
1D2PC-16-08	12	-08	12.7	1/2	M24x1.5	16	61	30	24	42.0	
1D2PC-20-10	16	-10	15.9	5/8	M30x2	20	65	34	30	42.0	
1D2PC-25-12	20	-12	19.0	3/4	M36x2	25	71	36	36	42.0	
1D2PC-30-16	25	-16	25.4	1	M42x2	30	73	38	46	42.0	

11DPC – Metric standpipe

Light series

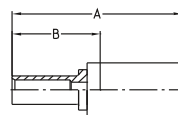

MATERIAL Galvanised steel with transparent Cr(VI)-free plating.
Other materials available on request.

Part No. #	DN size		mm		inch		Tube OD mm	A mm	B mm	Max. WP MPa
11DPC-8-04	6	-04	6.4	1/4	8	58	30	25.0		
11DPC-10-05	8	-05	7.9	5/16	10	59	31	25.0		
11DPC-10-06	10	-06	9.5	3/8	10	79	32	25.0		
11DPC-12-06	10	-06	9.5	3/8	12	79	32	25.0		
11DPC-15-08	12	-08	12.7	1/2	15	65	34	25.0		
11DPC-18-10	16	-10	15.9	5/8	18	66	35	16.0		
11DPC-22-12	20	-12	19.0	3/4	22	72	37	16.0		
11DPC-28-16	25	-16	25.4	1	28	74	39	10.0		

NOTE: Not recommended for new constructions. Please refer to end connections C3 or CA.



2030T-##CON

 Fittings
192PC – 1B1PC

192PC – BSP female swivel 60° cone

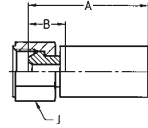

MATERIAL Galvanised steel with transparent Cr(VI)-free plating.
 Other materials available on request.

Part No. #	DN size				Connection type Thread size	A mm	B mm	J mm	Max. WP MPa
	mm	inch	mm	inch					
192PC-4-04	6	-04	6.4	1/4	G 1/4	45	17	17	63.0
192PC-6-05	8	-05	7.9	5/16	G 3/8	45	17	19	55.0
192PC-6-06	10	-06	9.5	3/8	G 3/8	48	19	22	55.0
192PC-8-06	10	-06	9.5	3/8	G 1/2	48	19	27	43.0
192PC-8-08	12	-08	12.7	1/2	G1/2	53	21	27	43.0
192PC-12-10	16	-10	15.9	5/8	G 3/4	50	19	32	35.0
192PC-12-12	20	-12	19.0	3/4	G 3/4	56	21	32	35.0
192PC-16-12	20	-12	19.0	3/4	G 1	56	22	41	28.0
192PC-16-16	25	-16	25.4	1	G 1	57	22	41	28.0
192PC-20-16	25	-16	25.4	1	G 1 1/4	58	24	50	21.0

PTFE / FEP

1B1PC – BSP female swivel 60° cone 45° elbow

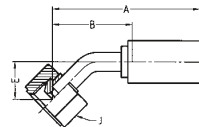

MATERIAL Galvanised steel with transparent Cr(VI)-free plating.
 Other materials available on request.

Part No. #	DN size				Connection type Thread size	A mm	B mm	E mm	J mm	Max. WP MPa
	mm	inch	mm	inch						
1B1PC-4-04	6	-04	6.4	1/4	G 1/4	70	41	21	17	63.0
1B1PC-6-05	8	-05	7.9	5/16	G 3/8	68	39	17	22	55.0
1B1PC-6-06	10	-06	9.5	3/8	G 3/8	66	36	14	22	55.0
1B1PC-8-06	10	-06	9.5	3/8	G 1/2	67	37	15	27	43.0
1B1PC-8-08	12	-08	12.7	1/2	G 1/2	86	54	18	27	43.0
1B1PC-12-10	16	-10	15.9	5/8	G 3/4	99	68	26	32	35.0
1B1PC-12-12	20	-12	19.0	3/4	G 3/4	117	82	30	32	35.0
1B1PC-16-16	25	-16	25.4	1	G 1	120	85	43	41	28.0
1B1PC-20-16	25	-16	25.4	1	G 1 1/4	116	81	34	50	21.0

Fittings
1B2PC – 1U0PC

2030T-##CON



1B2PC – BSP female swivel 60° cone 90° elbow

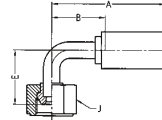

MATERIAL Galvanised steel with transparent Cr(VI)-free plating.
Other materials available on request.

PTFE / FEP

Part No. #	DN size mm inch				Connection type	A mm	B mm	E mm	J mm	Max. WP MPa
					Thread size 					
1B2PC-4-04	6	-04	6.4	1/4	G 1/4	59	30	30	17	63.0
1B2PC-6-05	8	-05	7.9	5/16	G 3/8	59	30	28	22	55.0
1B2PC-6-06	10	-06	9.5	3/8	G 3/8	60	30	30	22	55.0
1B2PC-8-06	10	-06	9.5	3/8	G 1/2	60	30	31	27	43.0
1B2PC-8-08	12	-08	12.7	1/2	G 1/2	74	42	38	27	43.0
1B2PC-12-10	16	-10	15.9	5/8	G 3/4	84	53	50	32	35.0
1B2PC-12-12	20	-12	19.0	3/4	G 3/4	100	65	60	32	35.0
1B2PC-20-16	25	-16	25.4	1	G 1 1/4	100	65	70	50	21.0

1U0PC – BSP female swivel (ballnose) BSP swivel nut

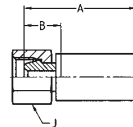

MATERIAL Galvanised steel with transparent Cr(VI)-free plating.
Other materials available on request.

Part No. #	DN size mm inch				Connection type	A mm	B mm	J mm	Max. WP MPa
					Thread size 				
1U0PC-4-04	6	-04	6.4	1/4	G 1/4	45	17	17	63.0
1U0PC-6-05	8	-05	7.9	5/16	G 3/8	45	17	19	55.0
1U0PC-6-06	10	-06	9.5	3/8	G 3/8	48	19	22	55.0
1U0PC-8-06	10	-06	9.5	3/8	G 1/2	48	19	27	43.0
1U0PC-8-08	12	-08	12.7	1/2	G 1/2	53	21	27	43.0
1U0PC-12-10	16	-10	15.9	5/8	G 3/4	50	19	32	35.0
1U0PC-12-12	20	-12	19.0	3/4	G 3/4	56	21	32	35.0
1U0PC-16-12	20	-12	19.0	3/4	G 1	56	22	41	25.0
1U0PC-16-16	25	-16	25.4	1	G 1	57	22	41	25.0
1U0PC-20-16	25	-16	25.4	1	G 1 1/4	58	24	50	21.0



2030T-##CON



Fittings
1D9PC – 101PC

1D9PC – BSP male DIN 3852 Form A

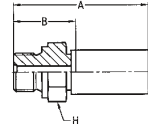

MATERIAL Galvanised steel with transparent Cr(VI)-free plating.
Other materials available on request.

Part No. #	DN size				Connection type Thread size	A mm	B mm	H mm	Max. WP MPa
	mm	inch	mm	inch					
1D9PC-4-04	6	-04	6.4	1/4	G 1/4	57	29	19	63.0
1D9PC-6-05	8	-05	7.9	5/16	G 3/8	58	29	22	55.0
1D9PC-6-06	10	-06	9.5	3/8	G 3/8	60	30	22	55.0
1D9PC-8-06	10	-06	9.5	3/8	G 1/2	62	33	27	43.0
1D9PC-8-08	12	-08	12.7	1/2	G 1/2	64	33	27	43.0
1D9PC-12-10	16	-10	15.9	5/8	G 3/4	66	35	32	35.0
1D9PC-12-12	20	-12	19.0	3/4	G 3/4	72	37	32	35.0
1D9PC-16-12	20	-12	19.0	3/4	G 1	74	39	41	28.0
1D9PC-20-16	25	-16	25.4	1	G 1 1/4	76	41	50	21.0

PTFE / FEP

101PC – National Pipe Tapered (NPT) male

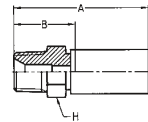

MATERIAL Galvanised steel with transparent Cr(VI)-free plating.
Other materials available on request.

Part No. #	DN size				Connection type Thread size	A mm	B mm	H mm	Max. WP MPa
	mm	inch	mm	inch					
101PC-4-04	6	-04	6.4	1/4	1/4 - 18NPTF	55	27	14	34.5
101PC-6-04	6	-04	6.4	1/4	3/8 - 18NPTF	57	29	19	27.5
101PC-6-05	8	-05	7.9	5/16	3/8 - 18NPTF	57	29	19	27.5
101PC-4-06	10	-06	9.5	3/8	1/4 - 18NPTF	57	28	14	34.5
101PC-6-06	10	-06	9.5	3/8	3/8 - 18NPTF	59	30	19	27.5
101PC-8-06	10	-06	9.5	3/8	1/2 - 14NPTF	64	35	22	24.0
101PC-6-08	12	-08	12.7	1/2	3/8 - 18NPTF	61	30	19	27.5
101PC-8-08	12	-08	12.7	1/2	1/2 - 14NPTF	66	35	22	24.0
101PC-12-10	16	-10	15.9	5/8	3/4 - 14NPTF	66	35	27	21.0
101PC-12-12	20	-12	19.0	3/4	3/4 - 14NPTF	70	35	27	21.0
101PC-16-16	25	-16	25.4	1	1 - 11 1/2NPTF	77	42	36	17.0



Fittings
103PC – 106PC

2030T-##CON



103PC – SAE (JIC) 37° male

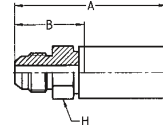

MATERIAL Galvanised steel with transparent Cr(VI)-free plating.
Other materials available on request.

PTFE / FEP

Part No. #	DN size				Connection type Thread size	A mm	B mm	H mm	Max. WP MPa
	mm	inch	mm	inch					
103PC-5-04	6	-04	6.4	1/4	1/2 - 20UNF	57	29	14	41.0
103PC-6-04	6	-04	6.4	1/4	9/16 - 18UNF	57	29	17	34.5
103PC-6-05	8	-05	7.9	5/16	9/16 - 18UNF	57	29	17	34.5
103PC-8-06	10	-06	9.5	3/8	3/4 - 16UNF	62	33	22	34.5
103PC-10-08	12	-08	12.7	1/2	7/8 - 14UNF	70	38	24	34.5
103PC-12-10	16	-10	15.9	5/8	1 1/16 - 12UNF	71	40	30	34.5
103PC-16-12	20	-12	19.0	3/4	1 5/16 - 12UNF	76	41	36	27.5
103PC-20-16	25	-16	25.4	1	1 5/8 - 12UNF	78	43	46	20.0

106PC – SAE (JIC) 37° female swivel UNF swivel nut

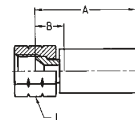

MATERIAL Galvanised steel with transparent Cr(VI)-free plating.
Other materials available on request.

Part No. #	DN size				Connection type Thread size	A mm	B mm	J mm	Max. WP MPa
	mm	inch	mm	inch					
106PC-4-04	6	-04	6.4	1/4	7/16 - 20UNF	43	15	17	41.0
106PC-5-04	6	-04	6.4	1/4	1/2 - 20UNF	43	15	19	41.0
106PC-6-05	8	-05	7.9	5/16	9/16 - 18UNF	45	17	19	34.5
106PC-6-06	10	-06	9.5	3/8	9/16 - 18UNF	47	18	19	34.5
106PC-8-06	10	-06	9.5	3/8	3/4 - 16UNF	48	19	24	34.5
106PC-10-08	12	-08	12.7	1/2	7/8 - 20UNF	49	18	27	34.5
106PC-12-10	16	-10	15.9	5/8	1 1/16 - 12UNF	50	19	32	34.5
106PC-16-12	20	-12	19.0	3/4	1 5/16 - 12UNF	56	22	41	27.5
106PC-20-16	25	-16	25.4	1	1 5/8 - 12UNF	56	22	50	20.0



2030T-##CON



Fittings
107PC – 137PC

107PC – NPSM female swivel

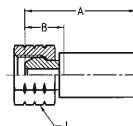

MATERIAL Galvanised steel with transparent Cr(VI)-free plating.
For fittings as mentioned above, but with stainless steel nipple (AISI 303), please add **C2W** to the Part No. Example: 107PC-4-04 **C2W**.
Other materials available on request.

Part No. #	DN size			mm	inch	Connection type		A mm	B mm	J mm	Max. WP MPa
	mm	mm	inch			Thread size	mm				
107PC-4-03	5	-03	4.8	3/16		1/4 - 18NPSM		44	19	17	34.5
107PC-2-03	5	-03	4.8	3/16		1/8 - 27NPSM		47	21	17	34.5
107PC-4-04	6	-04	6.4	1/4		1/4 - 18NPSM		47	19	19	34.5
107PC-6-05	8	-05	7.9	5/16		3/8 - 18NPSM		48	20	22	27.5
107PC-6-06	10	-06	9.5	3/8		3/8 - 18NPSM		50	21	22	27.5
107PC-8-08	12	-08	12.7	1/2		1/2 - 14NPSM		50	19	27	24.0
107PC-12-10	16	-10	15.9	5/8		3/4 - 14NPSM		53	22	32	21.0
107PC-12-12	20	-12	19.0	3/4		3/4 - 14NPSM		59	24	32	21.0

PTFE / FEP

137PC – SAE (JIC) 37° female swivel 45° elbow – UNF swivel nut

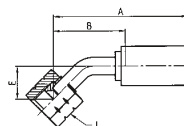

MATERIAL Galvanised steel with transparent Cr(VI)-free plating.
Other materials available on request.

Part No. #	DN size			mm	inch	Connection type		A mm	B mm	E mm	J mm	Max. WP MPa
	mm	mm	inch			Thread size	mm					
137PC-5-04	6	-04	6.4	1/4		1/2 - 20UNF		70	41	21	19	41.0
137PC-6-05	8	-05	7.9	5/16		9/16 - 18UNF		67	38	16	19	34.5
137PC-10-08	12	-08	12.7	1/2		7/8 - 14UNF		81	49	19	27	34.5
137PC-12-10	16	-10	15.9	5/8		1 1/16 - 12UNF		96	65	27	32	34.5
137PC-16-12	20	-12	19.0	3/4		1 5/16 - 12UNF		114	79	32	41	27.5
137PC-20-16	25	-16	25.4	1		1 5/8 - 12UNF		113	78	36	50	20.0

Fittings
139PC

2030T-##CON



139PC – SAE (JIC) 37° female swivel 90° elbow – UNF swivel nut

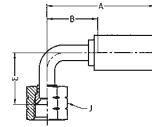

MATERIAL Galvanised steel with transparent Cr(VI)-free plating.
Other materials available on request.

PTFE / FEP

Part No. #	DN size				Connection type Thread size	A mm	B mm	E mm	J mm	Max. WP MPa
	mm	inch	mm	inch						
139PC-5-04	6	-04	6.4	1/4	1/2 - 20 UNF	59	30	31	19	41.0
139PC-6-05	8	-05	7.9	5/16	9/16 - 18 UNF	59	30	28	19	34.5
139PC-8-06	10	-06	9.5	3/8	3/4 - 16 UNF	60	30	31	24	34.5
139PC-10-08	12	-08	12.7	1/2	7/8 - 14 UNF	74	42	39	27	34.5
139PC-12-10	16	-10	15.9	5/8	1 1/16 - 12 UNF	84	53	52	32	34.5
139PC-16-12	20	-12	19.0	3/4	1 5/16 - 12 UNF	100	65	62	41	27.5
139PC-20-16	25	-16	25.4	1	1 5/8 - 12 UNF	100	65	73	50	20.0

1C3YX – Metric female swivel 24°/60°

Light series – Metric swivel nut

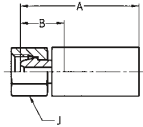

MATERIAL Galvanised steel with transparent Cr(VI)-free plating.
 For fittings as mentioned above, but with stainless steel nipple (AISI 303), please add **C2W** to the Part No. Example: 1C3YX-6-03 **C2W**.
 Other materials available on request.

Part No. #	DN size				Connection type	A	B	J	Max. WP MPa
	mm	inch			Thread size	mm	mm	mm	
1C3YX-6-03	5	-03	4.8	3/16	M12x1.5	43	18	14	25.0
1C3YX-8-03	5	-03	4.8	3/16	M14x1.5	43	18	17	25.0
1C3YX-10-03	5	-03	4.8	3/16	M16x1.5	43	18	19	25.0
1C3YX-8-04	6	-04	6.4	1/4	M14x1.5	46	18	17	25.0
1C3YX-10-04	6	-04	6.4	1/4	M16x1.5	46	18	19	25.0
1C3YX-10-05	8	-05	7.9	5/16	M16x1.5	46	18	19	25.0
1C3YX-10-06	10	-06	9.5	3/8	M16x1.5	49	20	22	25.0
1C3YX-12-06	10	-06	9.5	3/8	M18x1.5	48	19	22	25.0
1C3YX-12-08	12	-08	12.7	1/2	M18x1.5	52	20	24	25.0
1C3YX-15-08	12	-08	12.7	1/2	M22x1.5	51	20	27	25.0
1C3YX-18-08	12	-08	12.7	1/2	M26x1.5	52	21	32	25.0
1C3YX-18-10	16	-10	15.9	5/8	M26x1.5	51	20	32	16.0
1C3YX-18-12	20	-12	19.0	3/4	M26x1.5	57	22	32	16.0
1C3YX-22-12	20	-12	19.0	3/4	M30x2	57	23	36	16.0
1C3YX-28-16	25	-16	25.4	1	M36x2	59	25	41	10.0

PTFE / FEP

Fittings
1CAYX – 1C9YX

2030T • 2033T



1CAYX – Metric female swivel 24° with O-ring

Light series – Metric swivel nut – ISO 12151-2

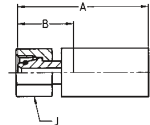

MATERIAL Galvanised steel with transparent Cr(VI)-free plating.
Other materials available on request.

PTFE / FEP

Part No. #	DN size				Connection type Thread size	A mm	B mm	J mm	Max. WP MPa
	mm	inch	mm	inch					
1CAYX-6-03	5	-03	4.8	3/16	M12x1.5	45	20	14	31.5
1CAYX-8-04	6	-04	6.4	1/4	M14x1.5	50	23	17	42.5
1CAYX-10-04	6	-04	6.4	1/4	M16x1.5	50	22	19	40.0
1CAYX-10-05	8	-05	7.9	5/16	M16x1.5	50	22	19	40.0
1CAYX-12-06	10	-06	9.5	3/8	M18x1.5	50	23	22	35.0
1CAYX-15-08	12	-08	12.7	1/2	M22x1.5	59	28	27	31.5
1CAYX-18-10	16	-10	15.9	5/8	M26x1.5	56	25	32	31.5
1CAYX-22-12	20	-12	19.0	3/4	M30x2	62	27	36	28.0
1CAYX-28-16	25	-16	25.4	1	M36x2	64	29	41	21.0

1C9YX – Metric female swivel 24° with O-ring

Heavy series – Metric swivel nut – ISO 12151-2

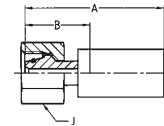

MATERIAL Galvanised steel with transparent Cr(VI)-free plating.
Other materials available on request.

Part No. #	DN size				Connection type		A mm	B mm	J mm	Max. WP MPa
	mm	inch	mm	inch	Thread size	Tube OD mm				
1C9YX-8-03	5	-03	4.8	3/16	M16x1.5	8	47	22	19	63.0
1C9YX-8-04	6	-04	6.4	1/4	M16x1.5	8	51	24	19	63.0
1C9YX-10-04	6	-04	6.4	1/4	M18x1.5	10	54	27	22	63.0
1C9YX-12-05	8	-05	7.9	5/16	M20x1.5	12	56	28	24	63.0
1C9YX-14-06	10	-06	9.5	3/8	M22x1.5	14	57	30	27	63.0
1C9YX-16-08	12	-08	12.7	1/2	M24x1.5	16	65	34	30	42.0
1C9YX-20-10	16	-10	15.9	5/8	M30x2	20	68	37	36	42.0
1C9YX-25-12	20	-12	19.0	3/4	M36x2	25	77	42	46	42.0
1C9YX-30-16	25	-16	25.4	1	M42x2	30	79	45	50	42.0



2030T • 2033T

Fittings
1D0YX – 1D2YX

1D0YX – Metric male 24°

Light series – ISO 12151-2

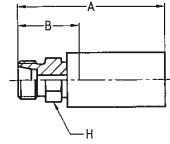

MATERIAL Galvanised steel with transparent Cr(VI)-free plating.
Other materials available on request.

Part No. #	DN size				Connection type Thread size	A mm	B mm	H mm	Max. WP MPa
	mm	inch	mm	inch					
1D0YX-6-03	5	-03	4.8	3/16	M12x1.5	48	23	12	25.0
1D0YX-8-04	6	-04	6.4	1/4	M14x1.5	50	23	14	42.5
1D0YX-10-05	8	-05	7.9	5/16	M16x1.5	54	26	17	40.0
1D0YX-12-06	10	-06	9.5	3/8	M18x1.5	54	27	19	35.0
1D0YX-15-08	12	-08	12.7	1/2	M22x1.5	59	28	22	31.0
1D0YX-18-10	16	-10	15.9	5/8	M26x1.5	59	28	27	28.0
1D0YX-22-12	20	-12	19.0	3/4	M30x2	67	32	30	28.0
1D0YX-28-16	25	-16	25.4	1	M36x2	67	32	36	21.0

PTFE / FEP

1D2YX – Metric male 24°

Heavy series – ISO 12151-2

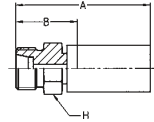

MATERIAL Galvanised steel with transparent Cr(VI)-free plating.
Other materials available on request.

Part No. #	DN size				Connection type		A mm	B mm	H mm	Max. WP MPa
	mm	inch	mm	inch	Thread size	Tube OD mm				
1D2YX-8-03	5	-03	4.8	3/16	M16x1.5	8	50	25	17	63.0
1D2YX-10-04	6	-04	6.4	1/4	M18x1.5	10	54	27	19	63.0
1D2YX-12-05	8	-05	7.9	5/16	M20x1.5	12	55	27	22	63.0
1D2YX-14-06	10	-06	9.5	3/8	M22x1.5	14	57	30	22	63.0
1D2YX-16-08	12	-08	12.7	1/2	M24x1.5	16	61	30	24	42.0
1D2YX-20-10	16	-10	15.9	5/8	M30x2	20	65	34	30	42.0
1D2YX-25-12	20	-12	19.0	3/4	M36x2	25	71	36	36	42.0
1D2YX-30-16	25	-16	25.4	1	M42x2	30	73	38	46	42.0



Fittings
11DYX – 192YX

2030T • 2033T



11DYX – Metric standpipe

Light series

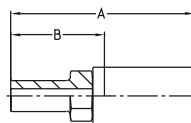

MATERIAL Galvanised steel with transparent Cr(VI)-free plating.
Other materials available on request.

PTFE / FEP

Part No. #	DN	size	mm	inch	Tube OD mm	A mm	B mm	Max. WP MPa
11DYX-6-03	5	-03	4.8	3/16	6	55	27	25.0
11DYX-6-04	6	-04	6.4	1/4	6	58	30	25.0
11DYX-8-04	6	-04	6.4	1/4	8	57	30	25.0
11DYX-10-05	8	-05	7.9	5/16	10	59	31	25.0
11DYX-10-06	10	-06	9.5	3/8	10	77	32	25.0
11DYX-12-06	10	-06	9.5	3/8	12	79	32	25.0
11DYX-15-08	12	-08	12.7	1/2	15	65	34	25.0
11DYX-18-10	16	-10	15.9	5/8	18	66	35	16.0
11DYX-22-12	20	-12	19.0	3/4	22	72	37	16.0
11DYX-28-16	25	-16	25.4	1	28	74	39	10.0

192YX – BSP female swivel 60° cone

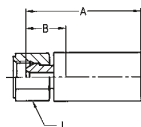

MATERIAL Galvanised steel with transparent Cr(VI)-free plating.
Other materials available on request.

Part No. #	DN	size	mm	inch	Connection type	A mm	B mm	J mm	Max. WP MPa
					Thread size				
192YX-4-03	5	-03	4.8	3/16	G 1/4	42	16	17	63.0
192YX-4-04	6	-04	6.3	1/4	G 1/4	44	17	17	63.0
192YX-6-05	8	-05	7.9	3/16	G 3/8	45	17	19	55.0
192YX-6-06	10	-06	9.5	3/8	G 3/8	46	19	22	55.0
192YX-8-06	10	-06	9.5	3/8	G 1/2	46	19	27	43.0
192YX-8-08	12	-08	12.7	1/2	G 1/2	52	21	27	43.0
192YX-12-10	16	-10	15.9	5/8	G 3/4	50	19	32	35.0
192YX-12-12	20	-12	19.0	3/4	G 3/4	56	21	32	35.0
192YX-16-12	20	-12	19.0	3/4	G 1	56	22	41	28.0
192YX-16-16	25	-16	25.4	1	G 1	57	22	41	28.0
192YX-20-16	25	-16	25.4	1	G 1 1/4	58	24	50	25.0

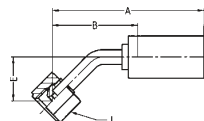
**1B1YX – BSP female swivel 60° cone
 45° elbow**

MATERIAL Galvanised steel with transparent Cr(VI)-free plating.
 Other materials available on request.

Part No. #	DN size				Connection type Thread size	A mm	B mm	E mm	J mm	Max. WP MPa
	mm	inch	mm	inch						
1B1YX-4-03	5	-03	4.8	3/16	G 1/4	58	32	17	17	63.0
1B1YX-4-04	6	-04	6.4	1/4	G 1/4	69	41	21	17	63.0
1B1YX-6-05	8	-05	7.9	5/16	G 3/8	68	39	17	22	55.0
1B1YX-6-06	10	-06	9.5	3/8	G 3/8	64	36	14	22	55.0
1B1YX-8-06	10	-06	9.5	3/8	G 1/2	65	37	15	27	43.0
1B1YX-8-08	12	-08	12.7	1/2	G 1/2	86	54	18	27	43.0
1B1YX-12-10	16	-10	15.9	5/8	G 3/4	99	68	26	32	35.0
1B1YX-12-12	20	-12	19.0	3/4	G 3/4	117	82	30	32	35.0
1B1YX-16-16	25	-16	25.4	1	G 1	120	85	43	41	28.0
1B1YX-20-16	25	-16	25.4	1	G 1 1/4	116	81	34	50	25.0

PTFE / FEP

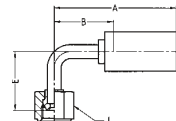
**1B2YX – BSP female swivel 60° cone
 90° elbow**

MATERIAL Galvanised steel with transparent Cr(VI)-free plating.
 Other materials available on request.

Part No. #	DN size				Connection type Thread size	A mm	B mm	E mm	J mm	Max. WP MPa
	mm	inch	mm	inch						
1B2YX-4-03	5	-03	4.8	3/16	G 1/4	48	22	24	17	63.0
1B2YX-4-04	6	-04	6.4	1/4	G 1/4	58	30	30	17	63.0
1B2YX-6-05	8	-05	7.9	5/16	G 3/8	59	30	28	22	55.0
1B2YX-6-06	10	-06	9.5	3/8	G 3/8	58	30	30	22	55.0
1B2YX-8-06	10	-06	9.5	3/8	G 1/2	58	30	31	27	43.0
1B2YX-8-08	12	-08	12.7	1/2	G 1/2	74	42	38	27	43.0
1B2YX-12-10	16	-10	15.9	5/8	G 3/4	84	53	50	32	35.0
1B2YX-12-12	20	-12	19.0	3/4	G 3/4	100	65	60	32	35.0
1B2YX-16-16	25	-16	25.4	1	G 1	100	65	69	41	28.0
1B2YX-20-16	25	-16	25.4	1	G 1 1/4	100	65	70	50	25.0

Fittings
101YX – 103YX

2030T • 2033T



101YX – National Pipe Tapered (NPT) male

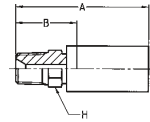

MATERIAL Galvanised steel with transparent Cr(VI)-free plating.
Other materials available on request.

PTFE / FEP

Part No. #	DN size			Connection type Thread size	A mm	B mm	H mm	Max. WP MPa
	mm	inch	inch					
101YX-2-03	5	-03	4,8	3/16	48	23	12	34,5
101YX-4-03	5	-03	4,8	3/16	52	27	14	34,5
101YX-4-04	6	-04	6,4	1/4	54	27	14	34,5
101YX-6-04	6	-04	6,4	1/4	56	29	19	27,5
101YX-6-05	8	-05	7,9	5/16	57	29	19	27,5
101YX-4-06	10	-06	9,5	3/8	55	28	14	34,5
101YX-6-06	10	-06	9,5	3/8	57	30	19	27,5
101YX-6-08	12	-08	12,7	1/2	61	30	19	27,5
101YX-8-08	12	-08	12,7	1/2	66	35	22	24,0
101YX-12-10	16	-10	15,9	5/8	66	35	27	21,0
101YX-12-12	20	-12	19,0	3/4	70	35	27	21,0
101YX-16-16	25	-16	25,4	1	78	42	36	17,0

103YX – SAE (JIC) 37° male

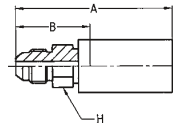

MATERIAL Galvanised steel with transparent Cr(VI)-free plating.
Other materials available on request.

Part No. #	DN size			Connection type Thread size	A mm	B mm	H mm	Max. WP MPa
	mm	inch	inch					
103YX-4-03	5	-03	4,8	3/16	52	27	14	41,0
103YX-5-04	6	-04	6,4	1/4	56	29	14	41,0
103YX-6-05	8	-05	7,9	5/16	57	29	17	34,5
103YX-8-06	10	-06	9,5	3/8	60	33	22	34,5
103YX-10-08	12	-08	12,7	1/2	70	38	24	34,5
103YX-12-10	16	-10	15,9	5/8	71	40	30	34,5
103YX-16-12	20	-12	19,0	3/4	76	41	36	27,5
103YX-20-16	25	-16	25,4	1	78	43	46	20,0



2030T • 2033T

 Fittings
1B4YX – 1U0YX

1B4YX – BSP female swivel 60° cone 90° compact elbow

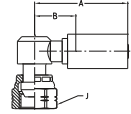

MATERIAL Galvanised steel with transparent Cr(VI)-free plating.
Other materials available on request.

Part No. #	DN size				Connection type Thread size 	A mm	B mm	J mm	Max. WP MPa
	mm	inch	mm	inch					
1B4YX-4-04	6	-04	6.3	1/4	G 1/4	46	19	19	63.0
1B4YX-6-05	8	-05	7.9	3/16	G 3/8	51	23	22	55.0
1B4YX-6-06	10	-06	9.5	3/8	G 3/8	51	24	22	55.0
1B4YX-8-08	12	-08	12.7	1/2	G 1/2	57	26	27	43.0

PTFE / FEP

1U0YX – BSP female swivel (ballnose) BSP swivel nut

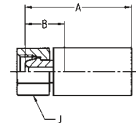

MATERIAL Galvanised steel with transparent Cr(VI)-free plating.
For fittings as mentioned above, but with stainless steel nipple
(AISI 303), please add **C2W** to the Part No. Example: 1U0YX-4-03 **C2W**.
Other materials available on request.

Part No. #	DN size				Connection type Thread size 	A mm	B mm	J mm	Max. WP MPa
	mm	inch	mm	inch					
1U0YX-2-03	5	-03	4.8	3/16	G 1/8	43	18	17	41.0
1U0YX-4-03	5	-03	4.8	3/16	G 1/4	42	16	17	63.0
1U0YX-4-04	6	-04	6.4	1/4	G 1/4	45	17	17	63.0
1U0YX-6-03	5	-03	4.8	3/16	G 3/8	45	17	17	55.0
1U0YX-6-04	6	-04	6.4	1/4	G 3/8	45	17	17	55.0
1U0YX-6-05	8	-05	7.9	5/16	G 3/8	45	17	19	55.0
1U0YX-6-06	10	-06	9.5	3/8	G 3/8	48	19	22	55.0
1U0YX-8-06	10	-06	9.5	3/8	G 1/2	48	19	27	43.0
1U0YX-8-08	12	-08	12.7	1/2	G 1/2	53	21	27	43.0
1U0YX-10-08	12	-08	12.7	1/2	G 5/8	51	20	27	35.0
1U0YX-12-10	16	-10	15.9	5/8	G 3/4	50	19	32	35.0
1U0YX-12-12	20	-12	19.0	3/4	G 3/4	56	21	32	35.0
1U0YX-16-12	20	-12	19.0	3/4	G 1	56	22	41	28.0
1U0YX-16-16	25	-16	25.4	1	G 1	57	22	41	28.0
1U0YX-20-16	25	-16	25.4	1	G 1 1/4	58	24	50	21.0



Fittings
1D9YX

2030T • 2033T



1D9YX – BSP male DIN 3852 Form A

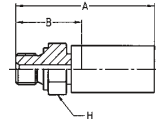

MATERIAL Galvanised steel with transparent Cr(VI)-free plating.
Other materials available on request.

PTFE / FEP

Part No. #	DN size			Connection type Thread size	A mm	B mm	H mm	Max. WP MPa
	mm	inch	inch					
1D9YX-2-03	5	-03	4.8	3/16	48	22	14	55.0
1D9YX-4-03	5	-03	4.8	3/16	54	29	19	63.0
1D9YX-4-04	6	-04	6.4	1/4	58	29	19	63.0
1D9YX-6-05	8	-05	7.9	5/16	58	29	22	55.0
1D9YX-4-06	10	-06	9.5	3/8	57	30	19	63.0
1D9YX-6-06	10	-06	9.5	3/8	58	30	22	55.0
1D9YX-8-06	10	-06	9.5	3/8	60	33	27	43.0
1D9YX-8-08	12	-08	12.7	1/2	64	33	27	43.0
1D9YX-12-10	16	-10	15.9	5/8	66	35	32	35.0
1D9YX-12-12	20	-12	19.0	3/4	72	37	32	35.0
1D9YX-16-12	20	-12	19.0	3/4	74	39	41	28.0
1D9YX-20-16	25	-16	25.4	1	76	41	50	21.0



2030T • 2033T

 Fittings
106YX – 107YX

106YX – SAE (JIC) 37° female swivel UNF swivel nut

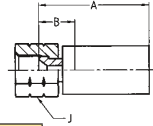

MATERIAL Galvanised steel with transparent Cr(VI)-free plating.
Other materials available on request.

Part No. #	DN size				Connection type Thread size 	A mm	B mm	J mm 	Max. WP MPa
	mm	inch	mm	inch					
106YX-4-03	5	-03	4.8	3/16	7/16 - 20UNF	40	15	17	41.0
106YX-5-04	6	-04	6.4	1/4	1/2 - 20UNF	42	15	19	41.0
106YX-6-05	8	-05	7.9	5/16	9/16 - 18UNF	45	17	19	34.5
106YX-6-06	10	-06	9.5	3/8	9/16 - 18UNF	47	18	19	34.5
106YX-8-06	10	-06	9.5	3/8	3/4 - 16UNF	46	19	24	34.5
106YX-10-08	12	-08	12.7	1/2	7/8 - 14UNF	49	18	27	34.5
106YX-12-10	16	-10	15.9	5/8	1 1/16 - 12UNF	50	19	32	34.5
106YX-16-12	20	-12	19.0	3/4	1 5/16 - 12UNF	56	22	41	27.5
106YX-20-16	25	-16	25.4	1	1 5/8 - 12UNF	56	22	50	20.0

PTFE / FEP

107YX – NPSM female swivel

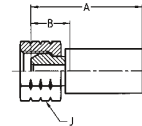

MATERIAL Galvanised steel with transparent Cr(VI)-free plating.
For fittings as mentioned above, but with stainless steel nipple
(AISI 303), please add **C2W** to the Part No. Example: 107YX-4-04 **C2W**.
Other materials available on request.

Part No. #	DN size				Connection type Thread size 	A mm	B mm	J mm 	Max. WP MPa
	mm	inch	mm	inch					
107YX-4-03	5	-03	4.8	3/16	1/4 - 18NPSM	44	19	17	34.5
107YX-2-03	5	-03	4.8	3/16	1/8 - 27NPSM	47	21	17	34.5
107YX-4-04	6	-04	6.4	1/4	1/4 - 18NPSM	47	19	19	34.5
107YX-6-05	8	-05	7.9	5/16	3/8 - 18NPSM	48	20	22	27.5
107YX-6-06	10	-06	9.5	3/8	3/8 - 18NPSM	50	21	22	27.5
107YX-8-08	12	-08	12.7	1/2	1/2 - 14NPSM	51	19	27	24.0
107YX-12-10	16	-10	15.9	5/8	3/4 - 14NPSM	53	22	32	21.0
107YX-12-12	20	-12	19.0	3/4	3/4 - 14NPSM	59	24	32	21.0



Fittings
137YX – 139YX

2030T • 2033T



137YX – SAE (JIC) 37° female swivel 45° elbow – UNF swivel nut

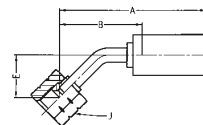

MATERIAL Galvanised steel with transparent Cr(VI)-free plating.
Other materials available on request.

PTFE / FEP

Part No. #	DN size			Connection type Thread size	A mm	B mm	E mm	J mm	Max. WP MPa
	mm	inch	inch						
137YX-4-03	5	-03	4.8	3/16	57	31	16	17	41.0
137YX-5-04	6	-04	6.4	1/4	69	41	21	19	41.0
137YX-6-05	8	-05	7.9	5/16	67	38	16	19	34.5
137YX-8-06	10	-06	9.5	3/8	65	37	15	24	34.5
137YX-10-08	12	-08	12.7	1/2	81	49	19	27	34.5
137YX-12-10	16	-10	15.9	5/8	96	65	27	32	34.5
137YX-16-12	20	-12	19.0	3/4	114	79	32	41	27.5
137YX-20-16	25	-16	25.4	1	113	78	36	50	20.0

139YX – SAE (JIC) 37° female swivel 90° elbow – UNF swivel nut

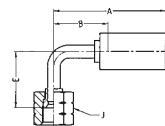

MATERIAL Galvanised steel with transparent Cr(VI)-free plating.
Other materials available on request.

Part No. #	DN size			Connection type Thread size	A mm	B mm	E mm	J mm	Max. WP MPa
	mm	inch	inch						
139YX-4-03	5	-03	4.8	3/16	48	22	24	17	41.0
139YX-5-04	6	-04	6.4	1/4	58	30	31	19	41.0
139YX-6-05	8	-05	7.9	5/16	59	30	28	19	34.5
139YX-8-06	10	-06	9.5	3/8	58	30	31	24	34.5
139YX-10-08	12	-08	12.7	1/2	74	42	39	27	34.5
139YX-12-10	16	-10	15.9	5/8	84	53	52	32	34.5
139YX-16-12	20	-12	19.0	3/4	100	65	62	41	27.5
139YX-20-16	25	-16	25.4	1	100	65	73	50	20.0

Chapter D**Hose and Fittings for Alternative Fuels**

Introduction	D-2
SCR hose		
SCR	– Parflex SCR Hose Assemblies.....	D-4
CNG hose		
5CNG	– Compressed natural gas dispense hose	D-5
LPG hose		
8LPG	– Liquefied propane gas and natural gas hose	D-6
Fittings		
PX-LPG series	D-7
CG series	D-12

Introduction

Parker thermoplastic hoses help to achieve tighter emission standards. To support future emission levels we have designed a wide range of hoses for alternative fuels, like compressed natural gas (CNG) or liquified propane gas (LPG).

The alternative fuel hoses can be used as fuel transfer lines onboard, as well as refueling lines on dispensing equipment.

Selective catalytic reduction systems help to reduce NOx emission level of diesel engines. Parker designed a range of heated and non-heated SCR hoses for DEF/Adblue® transfer.

Application



- Fuel and media transfer on board of trucks, mobile vehicles, busses and cars
- Fuel transfer lines on stationary equipment, like compressors or gensets
- Dispensing lines for refueling equipment used on workshop equipment and public gas stations

Features

- Working pressures up to 34.5 Mpa for CNG dispensing lines
- Conductive hose materials available
- Approvals according to ECE R67 & R110, CSA, AS/NZS 1869
- Flame retardant cover, abrasion guards and heatshield possible
- Preformed hoses on request

**Benefits**

- High design factor (4:1)
- Large scale field experience for all hoses
- Wide range of products for both refueling and onboard use
- Increased productivity and high quality assembly with preformed Polyflex lines
- High performance materials
- Longer lifetime
- Less leakages



Hose and Fittings for Alternative Fuels
Parflex SCR Hose Assemblies

Parflex SCR Hose Assemblies

Electrically Heated



MAIN FEATURES

- Consistent thaw - more reliable than coolant heated lines.
- Multiple options available to fit every application.
- Protective Overmolding
 - Additional protection for water ingress and damage of electrical components
 - Bolsters fitting strength and impact resistance
- Corrugated heat shield offers abrasion resistance.

APPLICATIONS

Heating and conveying DEF (Diesel Exhaust Fluid) throughout the SCR system on commercial vehicles

CONSTRUCTION

Core tube : Polyamid in 4 and 6mm / EPDM in 4 / 5.5 and 7.5mm
Pressure reinforcement : Fabric

Cover : Thermoplastic elastomeric
Colour : Black

TEMPERATURE RANGE

Suction/return lines: -40° to 70°C
 Pressure lines: -40° to 130°C

Alternative fuels

Configurator for SCR Hose Assemblies

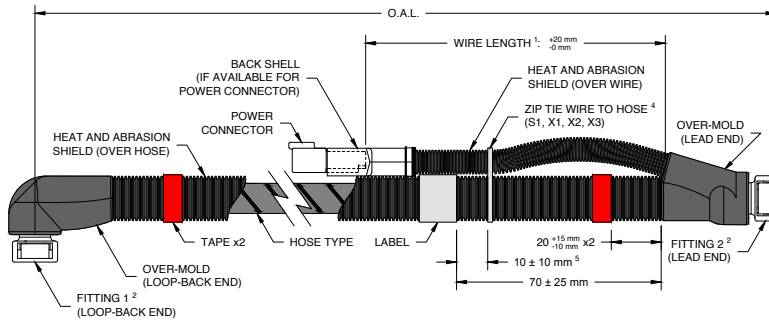

HOSE FAMILY	HOSE TYPE	O.A.L. CODE	FITTING 1 ²	FITTING 2 ²	POWER CONNECTOR	VOLTAGE	WIRE LENGTH ¹	SPECIAL REQUIREMENT
SCR	P2	100	B	A	FA	1	15	X1

NOTES

- Please contact PFDE to define your custom layout and to create a dedicated part number.
- For the available options please refer to the SCR Specification Sheet.
- Please find further information at www.scrhose.com



5CNG – Compressed natural gas hose

According to NFPA 52, AGA 1-93 and AGA/CGA,
 ANSI Standards 4.2/12.52,
 Approved according to CSA / ECE R110

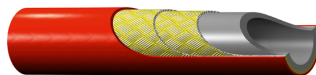

MAIN FEATURES

- High flexibility, compact construction
- Strong polyurethane cover for high wear and tear resistance
- Working pressure 34.5 MPa
- Also available as twinline or multiline hose
- Customized preforming available (see Bulletin 5200-Preformed)
- Electrically conductive

APPLICATIONS

- Dispense hose for natural gas and other gases
- Fixed applications such as refuelling hoses for natural gas fuelling stations, compressors, chemical plants or gas processing installations
- Mobile applications in vehicles

CONSTRUCTION

Core tube : Electrically conductive polymer
Pressure reinforcement : Two or more braided layers of high tensile synthetic fibre

Cover : Polyurethane, pinpricked
Colour : Red, other colours available on request

TEMPERATURE RANGE

-40°C up to +82°C

Alternative fuels

Part No. #	DN size			mm	Max. working pressure		Min. burst pressure		Min. bend radius	Weight	Fittings	
	mm	inch	mm		MPa / psi	MPa / psi	mm	kg/m				
5CNG-4	6	-04	6.4	1/4	14.0	34.5	5,000	138.0	20,000	51	0.11	CG*
5CNG-6	10	-06	9.9	3/8	16.0	34.5	5,000	138.0	20,000	76	0.13	CG*
5CNG-8	12	-08	12.7	1/2	22.7	34.5	5,000	138.0	20,000	102	0.31	CG*
5CNG-12	20	-12	19.3	3/4	29.2	34.5	5,000	138.0	20,000	191	0.36	CG*
5CNG-16	25	-16	26.0	1	40.0	34.5	5,000	138.0	20,000	254	0.53	CG*

*: Only available on request

NOTES

- Not for use in paint spray applications
- For refuelling systems additionally hose guards and warning tag must be ordered
- Twinline constructions for return lines available
- Factory made assemblies only

Hose and Fittings for Alternative Fuels
8LPG

8LPG – Liquefied propane gas and natural gas hose

Certified acc. to ECE R 67 class 1,
ECE R110 and AS/NZS 1869



MAIN FEATURES

- Compact construction, high flexibility
- Working pressure 3.0 MPa
- Highly resistant polymer core tube
- Strong polymer cover for high wear and tear resistance, weatherproof, UV- and ozone-resistant
- Customized preforming available (see Bulletin 5200-Preformed)

APPLICATIONS

LPG and CNG system for cars, trucks, busses and forklift trucks

CONSTRUCTION

Core tube : Polyamide
Pressure reinforcement : One layer of high tensile synthetic fibre

Cover : Polyamide, pinpricked; opt. flame resist. cover Type -FR(*)
Colour : Black, other colours available on request

TEMPERATURE RANGE

-25°C up to +100°C (short time 125°C)

Alternative fuels

Part No. #	DN size				mm	Max. working pressure		Min. burst pressure		Min. bend radius	Weight	Fittings
	mm	inch	mm	inch		MPa	psi	MPa	psi			
8LPG-3	5	-03	4.8	3/16	8.0	3.0	435	15.0	2,175	50	0.033	PX-LPG
8LPG-4	6	-04	6.3	1/4	9.8	3.0	435	15.0	2,175	75	0.043	PX-LPG
8LPG-5	8	-05	7.9	5/16	12.2	3.0	435	15.0	2,175	90	0.067	PX-LPG
8LPG-6	10	-06	9.5	3/8	13.7	3.0	435	15.0	2,175	100	0.075	PX-LPG
8LPG-3-FR*	5	-03	4.8	3/16	9.5	3.0	435	15.0	2,175	50	0.058	PX-LPG
8LPG-4-FR*	6	-04	6.3	1/4	11.5	3.0	435	15.0	2,175	75	0.071	PX-LPG
8LPG-5-FR*	8	-05	7.9	5/16	13.8	3.0	435	15.0	2,175	90	0.085	PX-LPG
8LPG-6-FR*	10	-06	9.5	3/8	15.3	3.0	435	15.0	2,175	100	0.090	PX-LPG

*Improved mechanical and chemical protection through flame resistant 2nd outer cover

NOTES

- Factory made assemblies only



Fittings
149PX – 1C3PX

LPG fittings certified acc. to ECE R 67

149PX – Banjo union DIN 7642

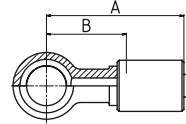

MATERIAL Nipple: Galvanised steel with transparent Cr(VI)-free plating.
Shell: brass. Other materials available on request.

Part No. #	DN size				Connection type			Max. WP MPa	
	mm	inch	Thread size	Tube OD mm	A mm	B mm			
149PX-10-03-LPG	5	-03	4.8	3/16	M10x1.5	10	35.0	20.7	3.0
149PX-10-04-LPG	6	-04	6.3	1/4	M10x1.5	10	35.0	20.7	3.0
149PX-12-04-LPG	6	-04	6.3	1/4	M12x1.5	10	36.5	21.7	3.0
149PX-10-05-LPG	8	-05	7.9	5/16	M10x1.5	10	41.0	22.3	3.0

Metric banjo bolt M10x1 DIN 7643 and 2 gasket rings (copper) included.
Wrench size for banjo bolt: 14 mm.

Alternative fuels

1C3PX – Metric female swivel 24°/60° Light series – Metric swivel nut

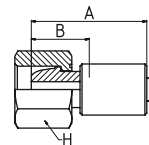

MATERIAL Nipple: Galvanised steel with transparent Cr(VI)-free plating.
Shell: brass. Other materials available on request.

Part No. #	DN size				Connection type			Max. WP MPa		
	mm	inch	Thread size	Tube OD mm	A mm	B mm	H mm			
1C3PX-6-03-LPG	5	-03	4.8	3/16	M12x1.5	8	30.3	15.5	17	3.0
1C3PX-8-03-LPG	5	-03	4.8	3/16	M14x1.5	8	30.0	15.0	17	3.0
1C3PX-8-04-LPG	6	-04	6.3	1/4	M14x1.5	8	30.0	15.0	17	3.0
1C3PX-8-05-LPG	8	-05	7.9	5/16	M14x1.5	8	35.4	16.7	17	3.0



Fittings
1U0PX – 17APX

8LPG



1U0PX – BSP female swivel (ballnose) BSP swivel nut

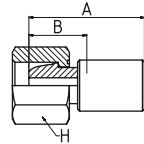

MATERIAL Nipple: Galvanised steel with transparent Cr(VI)-free plating.
Shell: brass. Other materials available on request.

Part No. #	DN size				Connection type		A mm	B mm	H mm	Max. WP MPa
	mm	inch	Thread size	Tube OD inch						
1U0PX-4-03-LPG	5	-03	4.8	3/16	G1/4	1/4	30.0	15.0	17	3.0
1U0PX-4-04-LPG	6	-04	6.3	1/4	G1/4	1/4	30.0	15.0	17	3.0
1U0PX-4-05-LPG	8	-05	7.9	5/16	G1/4	1/4	35.4	16.7	17	3.0

Alternative fuels

17APX – LPG 30° male swivel

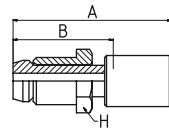

MATERIAL Nipple: Galvanised steel with transparent Cr(VI)-free plating.
Shell: brass. Other materials available on request.

Part No. #	DN size				Connection type		A mm	B mm	H mm	Max. WP MPa
	mm	inch	Thread size	Tube OD mm/inch						
17APX-6-03-LPG	5	-03	4.8	3/16	M10x1	8	42.3	28	17	3.0
17APX-8-04-LPG	6	-04	6.3	1/4	M12x1	8	45.3	31	17	3.0
17APX-4-03S-LPG	5	-03	4.8	3/16	7/16-20 UNF	1/4"	42.3	28	17	3.0
17APX-8-04S-LPG	6	-04	6.3	1/4	7/16-20 UNF	1/4"	45.3	31	17	3.0

D



Fittings
108PX – 129PX

**108PX – SAE (JIC) 45° female swivel
UNF swivel nut**

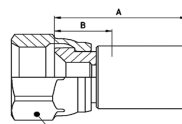

MATERIAL Nipple: Galvanised steel with transparent Cr(VI)-free plating.
Shell: brass. Other materials available on request.

Part No. #	DN size				Connection type Thread size 	A mm	B mm	H mm	Max. WP MPa
	mm	inch	mm	inch					
108PX-8-06-LPG	10	-06	9.5	3/8	3/4-16 UNF	33.6	14.6	22	3.0

Alternative fuels

129PX – Female inverted swivel straight

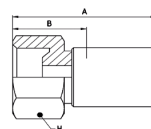

MATERIAL Nipple: Galvanised steel with transparent Cr(VI)-free plating.
Shell: brass. Other materials available on request.

Part No. #	DN size				Connection type Thread size 	A mm	B mm	H mm	Max. WP MPa
	mm	inch	mm	inch					
129PX-8-06-LPG	10	-06	9.5	3/8	3/4-1 UNF	39.0	20.0	22	3.0



Fittings
128PX – 11DPX



128PX – SAE (JIC) 45° male swivel UNF male swivel

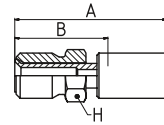

MATERIAL Nipple: Galvanised steel with transparent Cr(VI)-free plating.
Shell: brass. Other materials available on request.

Part No. #	DN size				Connection type		A mm	B mm	H mm	Max. WP MPa
	mm	inch	Thread size	Tube OD inch						
128PX-4-03-LPG	5	-03	4.8	3/16	7/16-20 UNF	1/4	37	23	14	3.0

Alternative fuels

11DPX – Metric standpipe Light series

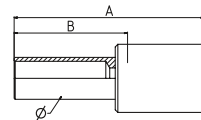

MATERIAL Nipple: Galvanised steel with transparent Cr(VI)-free plating.
Shell: brass. Other materials available on request.

Part No. #	DN size				Connection type		A mm	B mm	Ø mm	Max. WP MPa
	mm	inch	Thread size	Tube OD mm						
11DPX-8-04-LPG	6	-04	6.3	1/4	–	8	36.3	22	8	3.0

D



Fittings
1PHPX

1PHPX – LPG quick connector

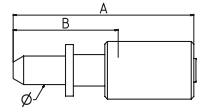

MATERIAL Nipple: Galvanised steel with transparent Cr(VI)-free plating.
Shell: brass. Other materials available on request.

Part No.	DN size				Connection type					Max. WP MPa
	mm	inch	Thread size	Tube OD mm	A mm	B mm	Ø mm			
#										
1PHPX-5.5-03S-LPG	5	-03	4.8	3/16	-	5.5	34.5	21	5.5	3.0

Other fittings available on request.

Alternative fuels

Fittings
101CG – 106CG



101CG – National Pipe Tapered (NPT) male

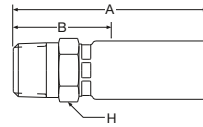

MATERIAL Galvanised steel with transparent Cr(VI)-free plating.
Other materials available on request.

Alternative fuels

Part No. #	DN size				Connection type		A mm	B mm	H inch	Max. WP MPa
	mm	inch	Thread size	Tube OD inch						
101CG-2-3	5	-03	4.8	3/16	1/8 - 27 NPTF	1/8	49.4	25.0	9/16	82.7
101CG-4-3	5	-03	4.8	3/16	1/4 - 18 NPTF	1/4	53.9	30.0	11/16	82.7
101CG-4-4	6	-04	6.4	1/4	1/4 - 18 NPTF	1/4	58.8	30.0	11/16	82.7
101CG-6-6	10	-06	9.5	3/8	3/8 - 18 NPTF	3/8	67.6	33.0	3/4	69.0
101CG-8-8	12	-08	12.7	1/2	1/2 - 14 NPTF	1/2	78.6	39.0	15/16	69.0
101CG-12-12	20	-12	19.0	3/4	3/4 - 14 NPTF	3/4	99.4	43.0	1 1/4	51.7
101CG-16-16	25	-16	25.4	1	1 - 11 1/2 NPTF	1	120.9	51.0	1 3/4	44.8

106CG – SAE (JIC) 37° female swivel UNF swivel nut

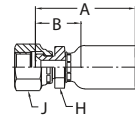

MATERIAL Galvanised steel with transparent Cr(VI)-free plating.
Other materials available on request.

Part No. #	DN size				Connection type		A mm	B mm	H inch	J inch	Max. WP MPa
	mm	inch	Thread size	Tube OD inch							
106CG-4-3	5	-03	4.8	3/16	7/16 - 20 UNF	1/4	56.7	33.0	9/16	9/16	41.4
106CG-4-4	6	-04	6.4	1/4	7/16 - 20 UNF	1/4	60.0	31.0	5/8	9/16	41.4
106CG-6-6	10	-06	9.5	3/8	9/16 - 18 UNF	3/8	68.6	34.0	11/16	11/16	34.5
106CG-8-8	12	-08	12.7	1/2	3/4 - 16 UNF	1/2	78.1	38.0	7/8	7/8	34.5
106CG-12-12	20	-12	19.0	3/4	1 1/16 - 12 UNF	3/4	105.9	46.0	1 1/4	1 5/16	34.5
106CG-16-16	25	-16	25.4	1	1 5/16 - 12 UNF	1	125.3	56.0	1 3/4	1 5/8	27.6

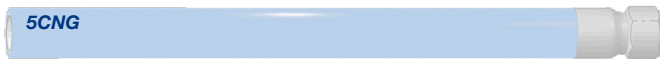
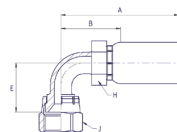
D
5CNG

 Fittings
139CG – 1JCCG
**139CG – SAE (JIC) 37° female swivel
 90° elbow – UNF swivel nut**

MATERIAL Galvanised steel with transparent Cr(VI)-free plating.
 Other materials available on request.

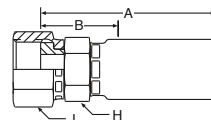
Part No. #	DN size				Connection type		A mm	B mm	E mm	H inch	J inch	Max. WP MPa
	mm	inch	Thread size	Tube OD inch								
139CG-4-4	6	-04	6.4	1/4	7/16 - 20 UNF	1/4	63.7	35.0	17.3	5/8	9/16	41.4
139CG-6-6	10	-06	9.5	3/8	9/16 - 18 UNF	3/8	73.2	38.0	21.6	3/4	11/16	34.5

Alternative fuels

**1JCCG – O-Lok® ORFS swivel nut
 Short version – UNF swivel nut – ISO 12151-1**

MATERIAL Galvanised steel with transparent Cr(VI)-free plating.
 Other materials available on request.

Part No. #	DN size				Connection type		A mm	B mm	H inch	J inch	Max. WP MPa
	mm	inch	Thread size	Tube OD inch							
1JCCG-4-4	6	-04	6.4	1/4	9/16 - 18 UNF	1/4	53.2	25.0	5/8	11/16	63.0
1JCCG-6-6	10	-06	9.5	3/8	11/16 - 16 UNF	3/8	62.7	28.0	11/16	13/16	63.0
1JCCG-8-8	12	-08	12.7	1/2	13/16 - 16 UNF	1/2	69.9	30.0	7/8	15/16	63.0
1JCCG-12-12	20	-12	19.0	3/4	1 - 14 UNF	3/4	97.9	38.0	1 1/4	1 3/8	41.4
1JCCG-16-16	25	-16	25.4	1	1 7/16 - 12 UNF	1	118.3	48.0	1 3/4	1 5/8	41.4

Fittings
1J7CG – 1J9CG



1J7CG – O-Lok® ORFS swivel nut

45° elbow – UNF swivel nut – ISO 12151-1

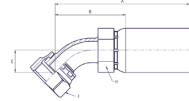

MATERIAL Galvanised steel with transparent Cr(VI)-free plating.
Other materials available on request.

Alternative fuels

Part No. #	DN size			mm		inch		Connection type		Thread size	Tube OD inch	A mm	B mm	E mm	H inch	J inch	Max. WP MPa
	mm	inch	mm	inch	mm	inch	mm	inch									
1J7CG-6-6	10	-06	9.5	3/8	11/16 - 16 UNF	3/8	75.6	41.0	10.9	3/4	13/16	63.0					
1J7CG-8-8	12	-08	12.7	1/2	13/16 - 16 UNF	1/2	88.7	49.0	15.0	7/8	15/16	63.0					
1J7CG-12-12	20	-12	19.0	3/4	1 - 14 UNF	3/4	114.5	56.0	20.5	1 1/8	1 3/8	41.4					

1J9CG – O-Lok® ORFS swivel nut

90° elbow – UNF swivel nut – ISO 12151-1

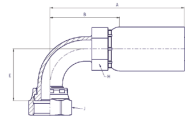

MATERIAL Galvanised steel with transparent Cr(VI)-free plating.
Other materials available on request.

Part No. #	DN size			mm		inch		Connection type		Thread size	Tube OD inch	A mm	B mm	E mm	H inch	J inch	Max. WP MPa
	mm	inch	mm	inch	mm	inch	mm	inch									
1J9CG-4-4	6	-04	6.4	1/4	9/16 - 18 UNF	1/4	67.8	39.0	21.1	5/8	11/16	63.0					
1J9CG-6-6	10	-06	9.5	3/8	11/16 - 16 UNF	3/8	72.1	37.0	23.1	3/4	13/16	63.0					
1J9CG-12-12	20	-12	19.0	3/4	1 - 14 UNF	3/4	112.3	54.0	48.0	1 1/8	1 3/8	41.4					
1J9CG-16-16	25	-16	25.4	1	1 7/16 - 12 UNF	1	147.2	76.0	58.4	1 3/4	1 5/8	41.4					

Chapter E***Hose and Fittings for Hydraulic and Industrial Applications***

Introduction	E-2
Part 1 – Small bore hose/mini-hydraulic hose	E-4
Part 2 – Medium pressure hose.....	E-7
Part 3 – High pressure hose.....	E-14
Part 4 – Paint spray hose	E-27
Part 5 – Gas hose	E-33
Part 6 – Hose fittings	E-41

Introduction

The Parker thermoplastic hose portfolio for hydraulic and industrial applications offers an excellent solution for the individual industry requirements.

Advanced materials and production technologies are applied to fulfill demanding market requirements such as reducing weight, long lasting hoses against aggressive media and environmental influence. The hose range covers mini-hydraulic hose types starting with 2 mm as well as high, working pressure hose up to 63 MPa .

In addition Parkers offers not only hose but also customized solutions such as multiline hoses, preformed hoses and hose bundles.

For hose with working pressures of 70 MPa and higher please refer to catalog "Thermoplastic Hoses for Ultra High Pressure".

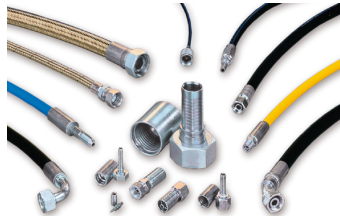

Application



- Industrial equipment such as
 - Machine tools
 - Wind turbines
 - Metal plants
- Transportation
- Mobile Offroad machines such as
 - Construction Equipment
 - Material Handling
 - Agriculture
- Paint spray equipment
- Gas handling & transfer

Features

- Extremely low weight
- Excellent resistance against aggressive media
- Mini hydraulic hose starting from 2 mm ID
- Working pressures up to 63 Mpa
- Very good resistance against aggressive environmental influences such as UV, Ozone, Seawater
- Excellent flexibility
- Electrical non-conductive versions
- Temperature range from -57 °C up to +120 °C
- Small hose outside diameter
- Small bend radius



Hydraulic / Industrial

Benefits

- Weight reduction / optimization
- Safe and long lasting hose installations
- Fast and easy assembly
- Optimized overall machine design with less space available in compact equipment
- Overall cost and weight reduction
- Excellent abrasion and chemical resistance



Part 1 – Small bore hose/mini-hydraulic hose

- 2010H** – Small bore hose/mini-hydraulic hose up to 21 MPa.....E-5
- 2020N** – Small bore hose/mini-hydraulic hose up to 63 MPa.....E-6

2010H – Small bore hose/mini-hydraulic hose

MAIN FEATURES

- Small dimensions
- Small bend radii

APPLICATIONS

- Medium pressure services, when **very small hose outer diameters** are required
- Versatile usage in mini-hydraulic and gas applications
- **Lubricating systems**
- **Measuring / diagnosis systems**

CONSTRUCTION

Core tube : Polyester elastomer
Pressure reinforcement : One braided layer of high tensile synthetic fibre

Cover : Polyurethane pinpricked
Colour : black

TEMPERATURE RANGE

-40°C up to +100°C for petroleum or synthetic hydraulic fluids.

Part No. #	DN size				mm	Max. working pressure MPa / psi	Min. burst pressure MPa / psi		Min. bend radius mm	Weight kg/m	Fittings	
	mm	inch	mm	inch			MPa	psi				
2010H-025V00	4	-025	4	5/32	8.3	21.0	3,045	84.0	12,180	35	0.052	EX

NOTES -

2020N – Small bore hose/mini-hydraulic hose (high pressure)

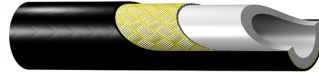

MAIN FEATURES

- Small dimensions
- Small bend radii
- Working pressures up to 63 MPa

APPLICATIONS

- High pressure services, when **very small hose outer diameters** are required
- Versatile usage in mini-hydraulic and gas applications
- **Measuring / diagnosis systems**

CONSTRUCTION

Core tube : Polyamide
Pressure reinforcement : One braided layer of high tensile synthetic fibre

Cover : Polyamide, pinpricked
Colour : black

TEMPERATURE RANGE

-40°C up to +100°C for petroleum or synthetic hydraulic fluids.

Hydraulic / Industrial

Part No. #	DN	size	mm	inch	mm	Max. working pressure MPa / psi		Min. burst pressure MPa / psi		Min. bend radius mm	Weight kg/m	Fittings
2020N-012V30	2	-012	2	5/64	4.9	50.0	7,250	200.0	29,000	20	0.016	EX
2020N-016V30	2,5	-016	2.5	3/32	5.9	40.0	5,800	160.0	23,200	20	0.016	EX
2020N-02V30	3	-02	2.9	1/8	6.0	40.0	5,800	160.0	23,200	30	0.023	EX
2020N-025V30	4	-025	4	5/32	8.1	44.0	6,380	176.0	25,520	40	0.042	EX
2020N-012V50	2	-012	2	5/64	4.9	63.0	9,135	200.0	29,000	20	0.016	EX

NOTES

- V50: Design factor reduced for diagnostic applications.
- 2020N-02V30 and 2020N-025V30 with DNV approval for hydraulic systems.

Part 2 – Medium pressure hose

550H	– Standard hydraulic hose	E-8
540N	– Medium pressure hose for aggressive fluids	E-9
560TJ	– ToughJACKET™ Hose	E-10
518C	– Medium pressure hose, electrically non-conductive	E-11
53DM	– Low temperature hose – constant working pressure.....	E-12
55LT	– Low temperature hose	E-13

Hose and Fittings for Hydraulic and Industrial Applications
550H

550H – Standard hydraulic hose

Performance exceeds SAE 100 R7 /
ISO 3949 Type R7 / DIN EN 855 Type R7

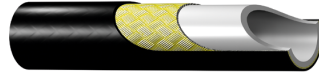

MAIN FEATURES

- High abrasion resistance
- Small bend radii
- Low weight
- High flexibility

APPLICATIONS

Medium pressure service for general industrial and mobile hydraulic applications such as

- Construction and agricultural machinery
- Material conveying systems/lifting devices
- Machine tools

CONSTRUCTION

Core tube : Polyester elastomer

Pressure reinforcement : One braided layer of high tensile synthetic fibre

Cover : Polyurethane, pinpricked

Colour : black

TEMPERATURE RANGE

-40°C up to +100°C for petroleum, max. 57°C for synthetic hydraulic fluids and water-based hydraulic fluids.

Part No. #	DN	size		mm	Max. working pressure		Min. burst pressure		Min. bend radius	Weight	Fittings	
		mm	inch		MPa	psi	MPa	psi				kg/m
550H-3	5	-03	4.8	3/16	10.7	22.5	3,250	90.0	13,000	19	0.08	56
550H-4	6	-04	6.3	1/4	12.6	21.0	3,000	83.0	12,000	32	0.10	56
550H-5	8	-05	7.9	5/16	14.3	17.5	2,500	69.0	10,000	44	0.13	56
550H-6	10	-06	9.5	3/8	16.3	15.5	2,250	62.0	9,000	51	0.14	56
550H-8	12	-08	12.7	1/2	20.3	14.0	2,000	56.0	8,000	76	0.21	56
550H-10	16	-10	15.9	5/8	24.5	10.0	1,500	40.0	6,000	102	0.30	56
550H-12	20	-12	19.1	3/4	27.4	8.5	1,250	34.5	5,000	127	0.31	56
550H-16	25	-16	25.4	1	33.3	7.0	1,000	27.5	4,000	203	0.40	56

NOTES

Also available as twinline or multilane hose, see page XVI.

540N – Medium pressure hose

Performance exceeds SAE 100 R7 /
ISO 3949 Type R7 / DIN EN 855 Type R7



MAIN FEATURES

- High abrasion resistance
- Small bend radii
- Low weight
- **Excellent chemical resistance due to polyamide core tube**

APPLICATIONS

Medium pressure service for general industrial and mobile hydraulic applications, especially when an improved chemical resistance is required with some hydraulic/chemical fluids.

CONSTRUCTION

Core tube : Polyamide
Pressure reinforcement : One braided layer of high tensile synthetic fibre

Cover : Polyurethane, pinpricked
Colour : black

TEMPERATURE RANGE

-40°C up to +100°C

Part No. #	DN size			mm	mm	Max. working pressure		Min. burst pressure		Min. bend radius	Weight	Fittings
	mm	inch	mm			MPa / psi	MPa / psi	kg/m				
540N-2	3	-02	3.2	1/8	8.4	21.0	3,000	83.0	12,000	13	0.05	56
540N-3	5	-03	4.8	3/16	10.7	21.0	3,000	83.0	12,000	19	0.08	56
540N-4	6	-04	6.3	1/4	12.6	19.0	2,750	76.0	11,000	38	0.10	56
540N-5	8	-05	7.9	5/16	14.6	17.5	2,500	69.0	10,000	44	0.12	56
540N-6	10	-06	9.5	3/8	16.4	15.5	2,250	62.0	9,000	51	0.14	56
540N-8	12	-08	12.7	1/2	20.1	14.0	2,000	56.0	8,000	76	0.21	56
540N-12	20	-12	19.1	3/4	26.5	8.5	1,250	34.5	5,000	152	0.25	56

NOTES

Also available as twinline or multilines hose, see page XVI.

Hose and Fittings for Hydraulic and Industrial Applications
560TJ – ToughJACKET™ Hose

560TJ – ToughJACKET™ Hose

Performance exceeds
SAE 100 R1AT / DIN EN 853-1SN



- MAIN FEATURES**
- High abrasion resistance
 - Small bend radii
 - **Steel wire pressure reinforcement**

APPLICATIONS Medium pressure service for general industrial and mobile hydraulic applications.

CONSTRUCTION Core tube : Polyester elastomer
 Pressure reinforcement : One braided layer of high tensile steel wire

Cover : Polyurethane
 Colour : black

TEMPERATURE RANGE -40°C up to +121°C for petroleum, max. 57°C for synthetic hydraulic fluids and water-based hydraulic fluids.

Part No. #	DN size			mm	Max. working pressure		Min. burst pressure		Min. bend radius	Weight	Fittings	
	mm	inch	mm		MPa / psi	MPa / psi	mm	kg/m				
560TJ-3	5	-03	5	3/16	9.9	25.0	3,625	100.0	14,503	19	0.11	56
560TJ-4	6	-04	6	1/4	11.9	22.4	3,250	90.0	13,053	38	0.14	56
560TJ-5	8	-05	8	5/16	13.4	20.6	3,000	86.0	12,473	44	0.16	56
560TJ-6	10	-06	10	3/8	15.5	19.0	2,750	75.8	11,000	51	0.21	56
560TJ-8	12	-08	13	1/2	19.0	17.2	2,500	69.0	10,000	76	0.29	56
560TJ-10	16	-10	16	5/8	23.6	13.7	2,000	55.2	8,000	102	0.47	56
560TJ-12	20	-12	19	3/4	26.4	12.0	1,750	48.3	7,000	108	0.42	56

NOTES Also available as twinline or multilane hose, see page XVI.

518C – Medium pressure hose

Electrically non-conductive –

Performance exceeds SAE 100 R7 /

ISO 3949 Type R7 / DIN EN 855 Type R7

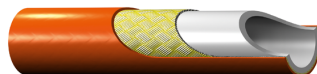

MAIN FEATURES

- Electrically non-conductive
- High abrasion resistance
- Small bend radii
- Low weight

APPLICATIONS

Medium pressure service for general industrial and mobile hydraulic applications, when **electrically non-conductive** lines are required, e.g.:

- Working platforms for high-voltage line repair
- Aluminium melting furnaces

CONSTRUCTION

Core tube : Polyester elastomer, except -2: polyamide

Pressure reinforcement : One braided layer of high tensile synthetic fibre

Cover : Polyurethane

Colour : orange

TEMPERATURE RANGE

-40°C up to +100°C for petroleum, max. 57°C for synthetic hydraulic fluids and water-based hydraulic fluids.

Part No. #	DN	size			mm	Max. working pressure		Min. burst pressure		Min. bend radius	Weight	Fittings
		mm	inch	mm		MPa / psi	MPa / psi	mm	kg/m			
518C-2	3	-02	3.2	1/8	8.4	17.5	2,500	69.0	10,000	13	0.05	56
518C-3	5	-03	4.8	3/16	10.7	22.5	3,250	90.0	13,000	19	0.07	56
518C-4	6	-04	6.3	1/4	11.7	20.7	3,000	83.0	12,000	38	0.08	56
518C-5	8	-05	7.9	5/16	14.3	17.5	2,500	69.0	10,000	44	0.11	56
518C-6	10	-06	9.5	3/8	16.0	15.5	2,250	62.0	9,000	51	0.14	56
518C-8	12	-08	12.7	1/2	20.4	15.5	2,250	62.0	9,000	76	0.22	56
518C-10	16	-10	15.9	5/8	24.9	10.5	1,500	42.0	6,000	102	0.30	56
518C-12	20	-12	19.1	3/4	27.4	8.5	1,250	34.5	5,000	152	0.31	56
518C-16	25	-16	25.4	1	33.5	7.0	1,000	27.5	4,000	203	0.40	56

NOTES

- Field attachable fittings available on request.
- Electrically non-conductive acc. to SAE J517 (less than 50 µA leakage under 250,000 Volts per meter).

Hose and Fittings for Hydraulic and Industrial Applications
53DM

53DM – Low temperature hose

Same working pressure for all sizes

Performance exceeds SAE 100 R18 / ISO 3949 Type R18



MAIN FEATURES

- Working pressure 21 MPa for all sizes
- Perfect solution for low temperature applications with dynamic movements
- High abrasion resistance
- Small bend radii
- Very low weight

APPLICATIONS

Medium pressure service for general industrial and mobile hydraulic applications, especially for systems **working at very low temperatures**, e.g.:

- Fork lifts in cold storage houses,
- Construction and agricultural machinery operating in climatic regions with lower temperatures.

CONSTRUCTION

Core tube : Polyester elastomer

Pressure reinforcement : One or two braided layers of high tensile synthetic fibre

Cover : Special polyester, pinpricked

Colour : black

TEMPERATURE RANGE

-57°C up to +100°C for petroleum, max. 57°C for synthetic hydraulic fluids and water-based hydraulic fluids.

Part No. #	DN	size	mm	inch	mm	Max. working pressure MPa / psi		Min. burst pressure MPa / psi		Min. bend radius mm	Weight kg/m	Fittings
53DM-6	10	-06	10.0	3/8	17.0	21.0	3,000	84.0	12,000	51	0.16	56
53DM-8	12	-08	12.5	1/2	21.0	21.0	3,000	84.0	12,000	89	0.26	56
53DM-10	16	-10	16.0	5/8	26.0	21.0	3,000	84.0	12,000	102	0.33	56

NOTES

Also available as twinline or multiline hose, see page XVI.

55LT – Low temperature hose

Performance exceeds SAE 100 R7 /
ISO 3949 Type R7 / DIN EN 855 Type R7



MAIN FEATURES

- Ideal for low temperature applications
- High abrasion resistance
- Small bend radii
- Low weight

APPLICATIONS

Medium pressure service for general industrial and mobile hydraulic applications, especially for systems **working at very low temperatures**, e.g.:

- Fork lifts in cold storage houses,
- Construction and agricultural machinery operating in climatic regions with lower temperatures.

CONSTRUCTION

Core tube : Polyester elastomer, except -02: polyamide
Pressure reinforcement : Two braided layers of high tensile synthetic fibre

Cover : Special polyester, pinpricked
Colour : black

TEMPERATURE RANGE

-57°C up to +100°C for petroleum, max. 57°C for synthetic hydraulic fluids and water-based hydraulic fluids.

Part No. #	DN	size	mm	inch	mm	Max. working pressure MPa / psi		Min. burst pressure MPa / psi		Min. bend radius mm	Weight kg/m	Fittings
55LT-2	3	-02	3.2	1/8	8.6	21.0	3,000	79.0	11,500	13	0.05	56
55LT-3	5	-03	4.8	3/16	10.9	22.5	3,250	90.0	13,000	19	0.08	56
55LT-4	6	-04	6.3	1/4	13.0	21.0	3,000	83.0	12,000	32	0.10	56
55LT-5	8	-05	7.9	5/16	14.3	17.5	2,500	69.0	10,000	44	0.13	56
55LT-6	10	-06	9.5	3/8	16.3	15.5	2,250	62.0	9,000	51	0.14	56
55LT-8	12	-08	12.7	1/2	20.3	14.0	2,000	56.0	8,000	76	0.21	56

NOTES

Also available as twinline or multiline hose, see page XVI.

Part 3 – High pressure hose

2040N	– Multi purpose hose	E-15
2040H	– Standard hydraulic hose	E-16
520N	– Standard hydraulic hose	E-17
528N	– Electrically non-conductive hose	E-18
580N	– Standard hydraulic hose	E-19
588N	– Electrically non-conductive hose	E-20
590TJ	– ToughJACKET™ Hose	E-21
594TJ	– ToughJACKET™ Hose	E-22
575X	– High pressure hose, low volumetric expansion	E-23
2370N	– Multi purpose hose	E-24
2245N	– High pressure hose	E-25

2040N – Multi purpose hose

Performance exceeds DIN EN 853-1SN,
DNV approved

MAIN FEATURES

- Excellent chemical resistance due to polyamide core tube
- Excellent abrasion resistance
- Small bend radii
- Steel wire pressure reinforcement

APPLICATIONS

High pressure service for general industrial and mobile hydraulic applications, especially when an **improved chemical resistance** is required with some hydraulic/chemical fluids. Usable for a **wide variety of fluids** due to the polyamide core tube. The polyamide cover resists aggressive fluids such as **refrigerants** in machine tools or when used in oil tanks.

CONSTRUCTION

Core tube : Polyamide
Pressure reinforcement : One braided layer of high tensile steel wire

Cover : V00: polyurethane
Colour : black

TEMPERATURE RANGE

-40°C up to +100°C for petroleum or synthetic hydraulic fluids.

Part No. #	DN size			mm	Max. working pressure MPa / psi	Min. burst pressure MPa / psi		Min. bend radius mm	Weight kg/m	Fittings		
	mm	inch	mm			MPa	psi					
2040N-02V00	3	-02	3.2	1/8	7.0	35.0	5,075	140.0	20,300	30	0.07	PX
2040N-03V00	5	-03	4.7	3/16	9.8	34.0	4,930	136.0	19,720	30	0.11	56/PX
2040N-04V00	6	-04	6.3	1/4	11.9	31.0	4,495	124.0	17,980	40	0.16	56/PX
2040N-05V00	8	-05	8.2	5/16	14.0	25.0	3,625	100.0	14,500	50	0.21	56/PX
2040N-06V00	10	-06	9.7	3/8	15.9	24.0	3,480	96.0	13,920	60	0.24	56/PX
2040N-08V00	12	-08	12.8	1/2	19.3	18.5	2,680	74.0	10,730	75	0.29	56/PX
2040N-10V00	16	-10	16.0	5/8	23.5	14.0	2,030	56.0	8,120	110	0.39	PX
2040N-12V00	20	-12	19.4	3/4	26.7	12.5	1,810	50.0	7,250	170	0.50	PX
2040N-16V00	25	-16	25.0	1	33.5	10.0	1,450	40.0	5,800	230	0.60	PX

NOTES

- 2040N with DNV approval for hydraulic systems.
- For pinpricked hose please add "-P", e.g. **2040N-02V00-P**.
- In version V00 also available as twinline or multiline hose, see page XVI.

Hose and Fittings for Hydraulic and Industrial Applications
2040H

2040H – Standard hydraulic hose

Performance exceeds DIN EN 853-1SN,
DNV approved



MAIN FEATURES

- Excellent abrasion resistance
- Small bend radii
- Steel wire pressure reinforcement
- **Excellent flexibility**

APPLICATIONS

High pressure service for general industrial and mobile hydraulic applications.

CONSTRUCTION

Core tube : Polyester elastomer
Pressure reinforcement : One braided layer of high tensile steel wire

Cover : Polyurethane
Colour : black

TEMPERATURE RANGE

-40°C up to +100°C for petroleum, max. 57°C for synthetic hydraulic fluids and water-based hydraulic fluids.

Part No. #	DN size			mm	Max. working pressure		Min. burst pressure		Min. bend radius	Weight	Fittings	
	mm	inch	mm		MPa / psi	MPa / psi	kg/m					
2040H-03V10	5	-03	4.7	3/16	9.8	34.0	4,930	136.0	19,720	30	0.12	56/PX
2040H-04V10	6	-04	6.3	1/4	11.9	31.0	4,495	124.0	17,980	40	0.17	56/PX
2040H-05V10	8	-05	8.2	5/16	14.0	25.0	3,625	100.0	14,500	50	0.21	56/PX
2040H-06V10	10	-06	9.7	3/8	15.9	24.0	3,480	96.0	13,920	60	0.26	56/PX
2040H-08V10	12	-08	12.8	1/2	19.3	18.5	2,680	74.0	10,730	75	0.31	56/PX
2040H-10V10	16	-10	16.0	5/8	23.5	14.0	2,030	56.0	8,120	110	0.43	PX
2040H-12V10	20	-12	19.4	3/4	26.7	12.5	1,810	50.0	7,250	170	0.53	PX
2040H-16V10	25	-16	25.0	1	33.5	10.0	1,450	40.0	5,800	230	0.72	PX

NOTES

- 2040H with DNV approval for hydraulic systems.
- Also available as twinline or multiline hose, see page XVI.

520N – Standard hydraulic hose

Performance exceeds SAE 100 R8 /
ISO 3949 Type R8 / DIN EN 855 Type R8



MAIN FEATURES

- Very small hose outer diameters
- Excellent abrasion resistance
- Small bend radii
- Low weight
- Excellent chemical resistance due to polyamide core tube

APPLICATIONS

High pressure service for general industrial and mobile hydraulic applications as well as with gases. Usable for a wide variety of fluids due to the polyamide core tube.

Version with white cover: **saltwater-proof, additionally improved UV resistance**, and therefore perfectly suited for boats and yachts.

CONSTRUCTION

Core tube : Polyamide
Pressure reinforcement : One braided layer of high tensile aramide fibre

Cover : Polyurethane, pinpricked
Colour : black

TEMPERATURE RANGE

-40°C up to +100°C for petroleum or synthetic hydraulic fluids.

Part No. #	DN	size	mm	inch	mm	Max. working pressure MPa / psi	Min. burst pressure MPa / psi	Min. bend radius mm	Weight kg/m	Fittings		
520N-3	5	-03	4.8	3/16	10.6	34.5	5,000	138.0	20,000	38	0.07	56
520N-4	6	-04	6.3	1/4	12.7	34.5	5,000	138.0	20,000	51	0.10	56
520N-5	8	-05	7.9	5/16	14.5	31.0	4,500	124.0	18,000	64	0.12	56
520N-6	10	-06	9.5	3/8	16.1	27.5	4,000	110.0	16,000	64	0.13	56
520N-8	12	-08	12.7	1/2	20.4	24.0	3,500	96.0	14,000	102	0.20	56

NOTES

- Also available as twinline or multiline hose, see page XVI.
- Not recommended for forklift boom applications.

Hose and Fittings for Hydraulic and Industrial Applications
528N

528N – Electrically non-conductive hose

Performance exceeds SAE 100 R8 /
ISO 3949 Type R8 / DIN EN 855 Type R8

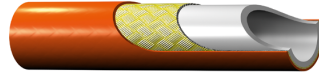

MAIN FEATURES

- Electrically non-conductive
- Very small hose outer diameters
- Excellent abrasion resistance
- Small bend radii
- Low weight
- Excellent chemical resistance due to polyamide core tube

APPLICATIONS

High pressure service for general industrial and mobile hydraulic applications, where a non-conductive hose is required.







CONSTRUCTION

Core tube : Polyamide
Pressure reinforcement : One braided layer of high tensile aramide fibre

Cover : Polyurethane, not pinpricked
Colour : orange

TEMPERATURE RANGE

-40°C up to +100°C for petroleum or synthetic hydraulic fluids.

Part No.	DN	size	mm	inch	mm	Max. working pressure MPa / psi		Min. burst pressure MPa / psi		Min. bend radius mm	Weight kg/m	Fittings
#												
528N-3	5	-03	4.8	3/16	10.6	34.5	5,000	138.0	20,000	38	0.07	56
528N-4	6	-04	6.3	1/4	12.7	34.5	5,000	138.0	20,000	51	0.10	56
528N-5	8	-05	7.9	5/16	14.5	31.0	4,500	124.0	18,000	64	0.12	56
528N-6	10	-06	9.5	3/8	16.1	27.5	4,000	110.0	16,000	64	0.13	56
528N-8	12	-08	12.7	1/2	20.4	24.0	3,500	96.0	14,000	102	0.20	56

NOTES

- Electrically non-conductive acc. to SAE J517 (less than 50 µA leakage under 250,000 Volts per meter).
- Not recommended for forklift boom applications.

580N – Standard hydraulic hose

Performance exceeds SAE 100 R8 /
ISO 3949 Type R8 / DIN EN 855 Type R8



MAIN FEATURES

- Excellent abrasion resistance
- Small bend radii
- Low weight
- Excellent chemical resistance due to polyamide core tube

APPLICATIONS

High pressure service for general industrial and mobile hydraulic applications as well as with gases. Usable for a wide variety of fluids due to the polyamide core tube.

CONSTRUCTION

Core tube : Polyamide
Pressure reinforcement : Multiple braided layers of high tensile synthetic fibre

Cover : Polyurethane, pinpricked
Colour : black

TEMPERATURE RANGE

-40°C up to +100°C for petroleum or synthetic hydraulic fluids.

Part No. #	DN size		mm		mm	Max. working pressure MPa / psi		Min. burst pressure MPa / psi		Min. bend radius mm	Weight kg/m	Fittings
	mm	inch	mm	inch		MPa	psi	MPa	psi			
580N-8	12	-08	12.5	1/2	23.0	24.0	3,500	96.0	14,000	102	0.31	56
580N-10	16	-10	15.9	5/8	24.9	19.0	2,750	76.0	11,000	152	0.32	56
580N-12	20	-12	19.1	3/4	29.5	15.5	2,250	62.0	9,000	203	0.35	56
580N-16	25	-16	25.4	1	37.6	14.0	2,000	56.0	8,000	254	0.56	56

NOTES

Also available as twinline or multiliner hose, see page XVI.

Hose and Fittings for Hydraulic and Industrial Applications
588N

588N – Electrically non-conductive hose

Performance exceeds SAE 100 R8 /
ISO 3949 Type R8 / DIN EN 855 Type R8

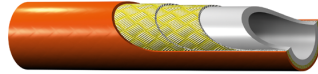

MAIN FEATURES

- Electrically non-conductive
- Very small hose outer diameters
- Excellent abrasion resistance
- Small bend radii
- Low weight
- Excellent chemical resistance due to polyamide core tube

APPLICATIONS

High pressure service for general industrial and mobile hydraulic applications, where a non-conductive hose is required.

CONSTRUCTION

Core tube : Polyamide
Pressure reinforcement : Two braided layers of high tensile synthetic fibre

Cover : Polyurethane
Colour : orange

TEMPERATURE RANGE

-40°C up to +100°C for petroleum or synthetic hydraulic fluids.

Part No. #	DN	size		mm	Max. working pressure		Min. burst pressure		Min. bend radius	Weight	Fittings	
		mm	inch		MPa	psi	MPa	psi				kg/m
588N-8	12	-08	12.7	1/2	23.0	24.0	3,500	96.0	14,000	102	0.31	56
588N-10	16	-10	15.9	5/8	24.9	19.0	2,750	76.0	11,000	152	0.32	56
588N-12	20	-12	19.1	3/4	29.5	15.5	2,250	62.0	9,000	203	0.35	56
588N-16	25	-16	25.4	1	37.6	14.0	2,000	56.0	8,000	254	0.56	56

NOTES

Electrically non-conductive acc. to SAE J517 (less than 50 µA leakage under 250,000 Volts per meter).

590TJ – ToughJACKET™ Hose

Performance exceeds SAE 100 R2

MAIN FEATURES

- Excellent abrasion resistance
- **Small bend radii**
- Special pressure reinforcement construction made of steel wire/textile fibre
- **Excellent flexibility**
- **Low weight**

APPLICATIONS

High pressure service for general industrial and mobile hydraulic applications. **Especially suited for telescoping booms of telehandlers and loading cranes** – frequently used as twinline hose.

CONSTRUCTION

Core tube : Polyester elastomer
Pressure reinforcement : High tensile wire, or a combination of wire and aramide fibre
Cover : Polyurethane
Colour : black

TEMPERATURE RANGE

-40°C up to +121°C for petroleum, max. 57°C for synthetic hydraulic fluids and water-based hydraulic fluids.

Part No. #	DN	size	mm	inch	mm	Max. working pressure MPa / psi	Min. burst pressure MPa / psi	Min. bend radius mm	Weight kg/m	Fittings		
590TJ-4	6	-04	6.3	1/4	12.5	34.5	5,000	140.0	20.305	44	0.20	56
590TJ-6	10	-06	10.0	3/8	16.3	27.6	4,000	112.0	16.244	57	0.29	56
590TJ-8	12	-08	12.5	1/2	19.3	24.1	3,500	96.5	14.213	82	0.36	56
590TJ-12	20	-12	19.0	3/4	28.0	17.2	2,500	68.9	10.000	120	0.58	43/48*
590TJ-16	25	-16	25.0	1	36.0	13.8	2,000	56.0	8.122	150	1.06	43/48*

*: For details please review HPDE fitting product range in CAT4400

NOTES

Also available as twinline or multilines hose, see page XVI.

Hose and Fittings for Hydraulic and Industrial Applications
594TJ

594TJ – ToughJACKET™ Hose

Performance exceeds SAE 100 R19



MAIN FEATURES

- Excellent abrasion resistance
- **Small bend radii**
- Special pressure reinforcement construction made of steel wire/textile fibre
- **Excellent flexibility**
- **Low weight**

APPLICATIONS

High pressure service for general industrial and mobile hydraulic applications. **Especially suited for telescoping booms of telehandlers and loading cranes** – frequently used as twinline hose.

CONSTRUCTION

Core tube : Copolyester
Pressure reinforcement : High tensile wire

Cover : Polyurethane
Colour : black

TEMPERATURE RANGE

-40°C up to +100°C for petroleum based hydraulic oils, max. 57°C for synthetic hydraulic fluids and water-based hydraulic fluids.

Part No.	DN	size	mm	inch	mm	Max. working pressure MPa / psi		Min. burst pressure MPa / psi		Min. bend radius mm	Weight kg/m	Fittings *
#												
594TJ-8	12	-08	13.0	1/2	21.5	28.0	4,061	112.0	16.244	90	0.58	46/43
594TJ-10	16	-10	16.0	5/8	26.4	28.0	4,061	112.0	16.244	100	0.58	48/43

*For details please review HPDE fitting product range in CAT4400

NOTES

Also available as twinline or multilines hose, see page XVI.

575X – High pressure hose

Low volumetric expansion

Same working pressure for all sizes



MAIN FEATURES

- Same working pressure of 34.5 MPa for all sizes
- Excellent abrasion resistance
- Small bend radii and very small outer diameters
- **Very low weight**
- Excellent chemical resistance due to polyamide core tube
- **Low volumetric expansion**

APPLICATIONS

High pressure service for general industrial and mobile hydraulic applications.

CONSTRUCTION

Core tube : Polyamide







Pressure reinforcement : One or two braided layers of high tensile aramide fibre

Cover : Polyurethane; 575XN-8: Polyamide

Colour : black

TEMPERATURE RANGE

-40°C up to +100°C for petroleum or synthetic hydraulic fluids.

Part No.	DN	size	mm	inch	mm	Max. working pressure MPa / psi	Min. burst pressure MPa / psi	Min. bend radius mm	Weight kg/m	Fittings		
#												
575X-3	5	-03	4.8	3/16	10.8	34.5	5,000	138.0	20,000	38	0.07	CG
575X-4	6	-04	6.3	1/4	12.8	34.5	5,000	138.0	20,000	51	0.10	CG
575X-6	10	-06	9.5	3/8	16.3	34.5	5,000	138.0	20,000	76	0.13	CG
575XN-8	12	-08	12.7	1/2	20.6	34.5	5,000	138.0	20,000	102	0.21	CG
575X-12	20	-12	19.1	3/4	29.2	34.5	5,000	138.0	20,000	203	0.36	CG
575X-16	25	-16	25.4	1	40.3	34.5	5,000	138.0	20,000	254	0.70	CG

NOTES

-

Hose and Fittings for Hydraulic and Industrial Applications
2370N

2370N – Multi purpose hose

Performance exceeds DIN EN 853-2SN

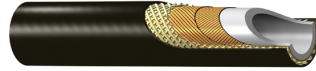

MAIN FEATURES

- Working pressures up to 46.5 MPa
- Excellent chemical resistance due to polyamide core tube

APPLICATIONS

High pressure service for general industrial and mobile hydraulic applications as well as with gases. Usable for a wide variety of fluids due to the polyamide core tube.

CONSTRUCTION

Core tube : Polyamide
Pressure reinforcement : Two spiral layers of high tensile steel wire, two open spiral layers of high tensile synthetic fibre
Cover : Polyurethane
Colour : black; other colours on request

TEMPERATURE RANGE

-40°C up to +100°C (short term +120°C) for petroleum or synthetic hydraulic fluids.

Part No. #	DN	size		mm	Max. working pressure		Min. burst pressure		Min. bend radius	Weight	Fittings	
		mm	inch		MPa / psi	MPa / psi	kg/m					
2370N-04V10	6	-04	6.3	1/4	12.4	46.5	6,740	186.0	26,970	70	0.19	NX
2370N-05V10	8	-05	8.2	5/16	14.3	44.0	6,380	176.0	25,520	100	0.25	NX
2370N-06V10	10	-06	9.8	3/8	16.4	42.0	6,090	168.0	24,360	120	0.33	9X
2370N-08V10	12	-08	12.8	1/2	20.0	35.0	5,075	140.0	20,300	150	0.42	9X

NOTES

- Also available as twinline or multiline hose, see page XVI.
- For pinpricked hose please add "-P", e.g. **2370N-04V10-P**.

2245N – High pressure hose

Performance exceeds SAE100R9

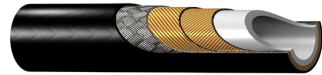
MAIN FEATURES

- High working pressures for large sizes
- Excellent chemical resistance due to polyamide core tube

APPLICATIONS

High pressure service for general industrial and mobile hydraulic applications as well as with gases. Usable for a wide variety of fluids due to the polyamide core tube.

CONSTRUCTION

Core tube : Polyamide
Pressure reinforcement : Two spiral layers of high tensile steel wire, one braided layer of steel wire
Cover : Polyurethane; -10 and above: polyamide
Colour : black

TEMPERATURE RANGE

-40°C up to +100°C (short term +120°C) for petroleum or synthetic hydraulic fluids.

Part No. #	DN size				mm	Max. working pressure MPa / psi	Min. burst pressure		Min. bend radius mm	Weight kg/m	Fittings	
	mm	inch	mm	inch			MPa	psi				
2245N-04V00	6	-04	6.3	1/4	12.5	45.0	6,525	180.0	26,100	70	0.25	NX
2245N-05V00	8	-05	8.2	5/16	14.3	40.0	5,800	160.0	23,200	100	0.32	NX
2245N-06V00	10	-06	9.7	3/8	17.0	37.5	5,435	150.0	21,750	120	0.42	NX
2245N-08V00	12	-08	12.8	1/2	20.7	35.0	5,075	140.0	20,300	165	0.52	9X
2245N-10V30	16	-10	16.0	5/8	24.5	33.0	4,785	132.0	19,140	200	0.72	NX
2245N-12V30	20	-12	19.6	3/4	28.5	30.0	4,350	120.0	17,400	240	0.92	NX
2245N-16V30	25	-16	25.0	1	34.0	27.5	3,985	110.0	15,950	280	1.15	NX

NOTES

- 2245N with DNV approval for hydraulic systems.
- For pinpricked hose please add "-P", e.g. **2245N-04V00-P**.

Part 4 – Paint spray hose

Airless paint spray applications – General statements.....	E-28
2040N – Medium pressure hose	E-29
2370N – High pressure hose	E-30
2030T – PTFE hose.....	E-31
2033T – PTFE hose.....	E-32

Airless paint spray applications – General statements

Hose assembly

Hoses for airless paint spray applications require a specific assembly procedure. It is imperative to have assembly training by Parker on the individual product.

The hose assembly must be silicone-free as silicone interferes with the paint spray quality. This requirement includes all the components and the testing media.

For each hose type specific Parker hose assembly and testing instructions have to be applied.

Conductivity

The hose assemblies must be conductive in order to dissipate the electrostatic charge. The conductivity of the hose assembly must be ensured and proven (100% testing) according to the Parker specification.

2040N – Medium pressure hose

Performance exceeds DIN EN 853-1SN,
DNV approved

MAIN FEATURES

- Working pressures up to 35 MPa
- Excellent chemical resistance due to polyamide core tube
- Excellent abrasion resistance

APPLICATIONS

Medium pressure paint spray applications.

CONSTRUCTION

Core tube : Polyamide
Pressure reinforcement : One braided layer of high tensile steel wire

Cover : Polyurethane
Colour : black

TEMPERATURE RANGE

-40°C up to +100°C

Part No. #	DN size				mm	Max. working pressure MPa / psi	Min. burst pressure MPa / psi		Min. bend radius mm	Weight kg/m	Fittings	
	mm	inch	mm	inch			MPa	psi				
2040N-02V00	3	-02	3.2	1/8	7.0	35.0	5,075	140.0	20,300	30	0.07	PX
2040N-03V00	5	-03	4.7	3/16	9.8	34.0	4,930	136.0	19,720	30	0.11	56/PX
2040N-04V00	6	-04	6.3	1/4	11.9	31.0	4,495	124.0	17,980	40	0.16	56/PX
2040N-05V00	8	-05	8.2	5/16	14.0	25.0	3,625	100.0	14,500	50	0.21	56/PX
2040N-06V00	10	-06	9.7	3/8	15.9	24.0	3,480	96.0	13,920	60	0.24	56/PX
2040N-08V00	12	-08	12.8	1/2	19.3	18.5	2,680	74.0	10,730	75	0.29	56/PX
2040N-10V00	16	-10	16.0	5/8	23.5	14.0	2,030	56.0	8,120	110	0.39	PX
2040N-12V00	20	-12	19.4	3/4	26.7	12.5	1,810	50.0	7,250	170	0.50	PX
2040N-16V00	25	-16	25.0	1	33.5	10.0	1,450	40.0	5,800	230	0.60	PX

NOTES

Sizes -03, -04, and -06 also available with blue cover; please change Part No. to:
 2040N-03V02, 2040N-04V02, or 2040N-06V02

Hose and Fittings for Hydraulic and Industrial Applications
2370N

2370N – High pressure hose

Performance exceeds DIN EN 853-2SN

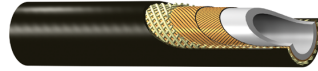

MAIN FEATURES

- Working pressures up to 46.5 MPa
- Excellent chemical resistance due to polyamide core tube
- Excellent abrasion resistance

APPLICATIONS













High pressure paint spray applications.

CONSTRUCTION

Core tube : Polyamide
Pressure reinforcement : Two spiral layers of high tensile steel wire,
 two open spiral layers of synthetic fibre
Cover : Polyurethane
Colour : black

TEMPERATURE RANGE

-40°C up to +100°C

Part No.	DN	size	mm	inch	mm	Max. working pressure MPa / psi		Min. burst pressure MPa / psi		Min. bend radius mm	Weight kg/m	Fittings
#												
2370N-04V10	6	-04	6.3	1/4	12.4	46.5	6,740	186.0	26,970	70	0.19	NX
2370N-05V10	8	-05	8.2	5/16	14.3	44.0	6,380	176.0	25,520	100	0.25	NX
2370N-06V10	10	-06	9.8	3/8	16.4	42.0	6,090	168.0	24,360	120	0.33	9X
2370N-08V10	12	-08	12.8	1/2	20.0	35.0	5,075	140.0	20,300	150	0.42	9X

NOTES

Sizes -04 and -06 also available with blue cover; please change Part No. to:
2370N-04V02 or 2370N-06V02

2030T – PTFE hose

MAIN FEATURES

- Working pressures up to 27.5 MPa
- Excellent chemical resistance
- Suitable for high temperatures

APPLICATIONS

Medium pressure paint spray applications.

CONSTRUCTION

Core tube : Polytetrafluoroethylene
Pressure reinforcement : One braided layer of steel wire

Cover : –
Colour : –

TEMPERATURE RANGE

–50°C up to +150°C continuous temperature
 +230°C at working pressures up to 2 MPa

Part No. #	DN	size	mm	inch	mm	Max. working pressure MPa / psi	Min. burst pressure MPa / psi	Min. bend radius mm	Weight kg/m	Fittings		
2030T-03V70	5	-03	4.7	3/16	7.8	27.5	3,985	110.0	15,950	50	0.09	YX
2030T-04V70	6	-04	6.3	1/4	9.5	24.0	3,480	96.0	13,920	75	0.13	YX
2030T-05V70	8	-05	8.2	5/16	11.5	20.0	2,900	80.0	11,600	100	0.17	YX
2030T-06V70	10	-06	9.7	3/8	13.0	17.5	2,535	70.0	10,150	120	0.19	YX
2030T-08V70	12	-08	12.8	1/2	16.7	15.0	2,175	60.0	8,700	135	0.29	YX
2030T-10V70	16	-10	16.0	5/8	20.0	12.5	1,810	50.0	7,250	160	0.34	YX
2030T-12V70	20	-12	19.4	3/4	23.5	10.0	1,450	40.0	5,800	200	0.41	YX
2030T-16V70	25	-16	25.0	1	29.0	8.0	1,160	32.0	4,640	250	0.51	YX

NOTES –

Hose and Fittings for Hydraulic and Industrial Applications
2033T

2033T – PTFE hose



MAIN FEATURES

- Improved working pressures due to two braided layers of steel wire
- Suitable for high temperatures
- Excellent chemical resistance

APPLICATIONS

Medium pressure paint spray applications.

CONSTRUCTION

Core tube : Polytetrafluoroethylene
Pressure reinforcement : Two braided layers of steel wire

Cover : –

Colour : –

TEMPERATURE RANGE

-50°C up to +150°C continuous temperature
+230°C at working pressures up to 2 MPa

Part No. #	DN	size		mm	mm	Max. working pressure		Min. burst pressure		Min. bend radius	Weight	Fittings
		mm	inch			MPa / psi	MPa / psi	kg/m				
2033T-04V70	6	-04	6.3	1/4	11.0	27.5	3,985	110.0	15,950	75	0.23	PX
2033T-05V70	8	-05	8.2	5/16	13.2	25.0	3,625	100.0	14,500	100	0.26	PX
2033T-06V70	10	-06	9.7	3/8	15.0	22.5	3,260	90.0	13,050	120	0.34	PX
2033T-08V70	12	-08	12.8	1/2	18.6	20.0	2,900	80.0	11,600	135	0.47	PX
2033T-10V70	16	-10	16.0	5/8	21.5	17.5	2,535	70.0	10,150	160	0.53	YX
2033T-12V70	20	-12	19.4	3/4	25.5	15.0	2,175	60.0	8,700	200	0.69	YX
2033T-16V70	25	-16	25.0	1	31.0	11.0	1,595	44.0	6,380	250	0.81	YX

NOTES –

Part 5 – Gas hose

Introduction	E-34
Thermoplastic hose for applications with industrial gases	E-35
Thermoplastic hose types with specific approvals	E-37
- 527BA – Breathing air refill hose	E-38
- 5CNG – Compressed natural gas dispense hose	E-39
- 8LPG – Hose for mobile applications in vehicles	E-40

Gas hose applications – General statements

Hose selection for industrial gases

Parker thermoplastic hoses are perfectly suited for applications with industrial gases and are being used in the field for many years.

When selecting hoses for industrial gases, attention should be paid to the following three criteria:

1. Chemical resistance

Due to the high-grade core tube materials Parker thermoplastic hoses are chemically resistant to most of the industrial gases, such as acetylene, propane, butane, methane, natural gas, CNG, carbon dioxide, nitrogen and inert gases (see chemical resistance table, page A-10).

2. Permeation

Parker thermoplastic hoses have relatively low permeation rates, thus minimising the loss of gases. This leads to an optimisation of operational costs, and gas enrichments in the surroundings caused by permeation are minimised.

3. Perforation

It is mandatory for gas applications to use perforated (pinpricked) hoses in order to avoid bubble formation in the hose cover.

For further information please refer to our Engineering Standard PFDE-ES01, which is available on request at Parker Polymer Hose Division Europe.

Thermoplastic hose for applications with industrial gases

Based on the technical requirements noted in the introduction some hose types are particularly suited for gas applications. These hose types can be classified as follows:

- 1) **Hoses with textile fibre reinforcement** – these have pinpricked covers by default:

540N	5CNG
520N	8LPG
2010N	
2020N	

- 2) **Hoses with steel wire reinforcement** – these have to be pinpricked especially for gas applications:

2040N
 2370N
 2245N

- 3) **Hoses with core tubes made from fluoropolymer** – these are especially suited for aggressive fluids and/or higher temperatures:

2030T
 2033T
 939
 2246F

Please use the following table to select the desired hose type by size and working pressure.

Hose and Fittings for Hydraulic and Industrial Applications

Gas hose

		Working pressure (MPa)																Fitting series	pg
Nom. size	DN	2	2.5	3	4	5	6	8	10	12	16	20	25	32	40	50			
	size	-012	-016	-02	-025	-03	-04	-05	-06	-08	-10	-12	-16	-20	-24	-32			
	mm*	2.0	2.4	3.2	4.0	4.8	6.4	7.9	9.5	12.7	15.9	19.0	25.4	31.8	38.1	50.8			
	inch	5/64	3/32	1/8	5/32	3/16	1/4	5/16	3/8	1/2	5/8	3/4	1	1 1/4	1 1/2	2			
Hoses with textile fibre reinforcement																			
540N				21.0		21.0	19.0	17.5	15.5	14.0	8.5						56	E-9	
520N						34.5	34.5	31.0	27.5	24.0							56	E-17	
2020N (V30)	47.5	40.0	40.0	44.0													EX	E-6	
5CNG						34.5	34.5		34.5	34.5		34.5	34.5				CG	E-39	
8LPG						3.0	3.0	3.0	3.0								PX-LPG	E-40	
Hoses with steel wire reinforcement																			
2040N (V00)				35.0		34.0	31.0	25.0	24.0	18.5	14.0	12.5	10.0				56/PX	E-29	
2370N							46.5	44.0	42.0	35.0							9X/NX	E-30	
2245N							45.0	40.0	37.5	35.0	33.0	30.0	27.5				NX	E-25	
Hoses with core tubes made from fluoropolymer																			
2030T						27.5	24.0	20.0	17.5	15.0	12.5	10.0	8.0				YX	C-4	
2033T							27.5	25.0	22.5	20.0	17.5	15.0	11.0				PX/YX	C-6	
939/939B									10.3	9.5	6.9	7.5	6.9	6.9	5.0	1.7	93N	C-10	
2246F							41.5	37.5	34.0	32.5	30.0	26.5	21.0				NX	C-12	

*: Exact value may vary, please check hose spec

For gas applications temperature limitations must be considered. For most of the gases the above Parker hose types are suitable for temperatures up to 50°C. For higher temperatures please contact Parker Polymer Hose Division Europe.

For hose applications with gases legal and actuarial regulations must be observed. The specification of the chemical resistance does not replace approval of certain bodies or for specific applications.

The user has to assume full responsibility for hose selection, testing of the application and the environmental conditions, and release for the individual application.

Please refer also to the standards, approvals and certificates when selecting hoses (see page A-15).

Thermoplastic hose types with specific approvals

Some hose types and sizes have approvals for specific gas applications. Please refer to the following overview:

Application	Approval	Hose type	Page
Natural gas, CNG	AGA/CSA approved acc. to ANSI 4,2/12,52	5CNG	D-5, E-39
	ECE R110	5CNG-8	D-5, E-39
LPG	ECE R67 ECE R110 AZ/NZS 1869	8LPG (-3, -4, -5, -6)	D-7, E-40

Hose and Fittings for Hydraulic and Industrial Applications
527BA

527BA – Breathing air refill hose

Compliant with CGA G7.1-1997 “Grade E Breathing Air Standards”



MAIN FEATURES

- Compliant with to CGA G7.1-1997 “Grade E Breathing Air Standards”
- Excellent abrasion resistance
- Same working pressure of 48.3 MPa for all sizes

APPLICATIONS

- Integrated containment fill stations
- Mobile and stationary systems with or without cascade controls
- Mobile Trailer/Truck Systems
- Portable SCBA Fill









CONSTRUCTION

Core tube : Nylon
Pressure reinforcement : High tensile aramide fibre

Cover : Polyurethane, pinpricked
Colour : blue

TEMPERATURE RANGE

-40°C up to +82°C

Part No.	DN	size	mm	inch	mm	Max. working pressure MPa / psi	Min. burst pressure MPa / psi	Min. bend radius mm	Weight kg/m	Fittings		
#												
527BA-3	5	-03	4.8	3/16	10.9	48.3	7,000	193,2	28,000	38	0.07	CG
527BA-4	6	-04	6.4	1/4	13.2	48.3	7,000	193,2	28,000	51	0.11	CG

NOTE

- Perforated cover
- Not for use as part of a SCBA systems
- This hose is not for use between a pressure reducing regulator and breathing mask
- For fitting attachment lubricate only with water or non-toxic lubricant. Do not assemble with petroleum or hydrocarbon based lubricants. Do not flush with solvents of any kind
- This hose does not contain a conductive element; therefore, it should not be used with explosive gases such as pure oxygen and hydrogen
- Hose is compliant with CGA Grade E Breathing Air Standards, however air quality is dependent upon all system components

5CNG – Compressed natural gas hose

According to NFPA 52, AGA 1-93 and AGA/CGA,
 ANSI Standards 4.2/12.52,
 Approved according to CSA / ECE R110

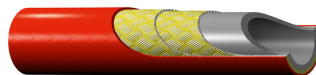

MAIN FEATURES

- High flexibility, compact construction
- Strong polyurethane cover for high wear and tear resistance
- Working pressure 34.5 MPa
- Also available as twinline or multiline hose
- Customized preforming available (see Bulletin 5200-Preformed)
- Electrically conductive

APPLICATIONS

- Dispense hose for natural gas and other gases
- Fixed applications such as refuelling hoses for natural gas fuelling stations, compressors, chemical plants or gas processing installations
- Mobile applications in vehicles

CONSTRUCTION

- Core tube** : Electrically conductive polymer
Pressure reinforcement : Two or more braided layers of high tensile synthetic fibre
- Cover** : Polyurethane, pinpricked
Colour : Red, other colours available on request

TEMPERATURE RANGE

-40°C up to +82°C

Part No. #	DN size			mm	Max. working pressure		Min. burst pressure		Min. bend radius	Weight	Fittings	
	mm	inch	mm		MPa / psi	MPa / psi	mm	kg/m				
5CNG-4	6	-04	6.4	1/4	14.0	34.5	5,000	138.0	20,000	51	0.11	CG*
5CNG-6	10	-06	9.9	3/8	16.3	34.5	5,000	138.0	20,000	76	0.13	CG*
5CNG-8	12	-08	12.7	1/2	22.7	34.5	5,000	138.0	20,000	102	0.31	CG*
5CNG-12	20	-12	19.3	3/4	29.2	34.5	5,000	138.0	20,000	191	0.36	CG*
5CNG-16	25	-16	26.0	1	40.4	34.5	5,000	138.0	20,000	254	0.53	CG*

*: Only available on request

NOTES

- Not for use in paint spray applications
- For refuelling systems additionally hose guards and warning tag must be ordered
- Twinline constructions for return lines available
- Factory made assemblies only

Hose and Fittings for Hydraulic and Industrial Applications
8LPG

8LPG – Liquefied propane gas and natural gas hose

Certified acc. to ECE R 67 class 1,
 ECE R110 and AS/NZS 1869



MAIN FEATURES

- Compact construction, high flexibility
- Working pressure 3.0 MPa
- Highly resistant polymer core tube
- Strong polymer cover for high wear and tear resistance, weatherproof, UV- and ozone-resistant
- Customized preforming available (see Bulletin 5200-Preformed)

APPLICATIONS

LPG and CNG system for cars, trucks, busses and forklift trucks

Hydraulic / Industrial

CONSTRUCTION

Core tube : Polyamide
Pressure reinforcement : One layer of high tensile synthetic fibre

Cover : Polyamide, pinpricked; opt. flame resist. cover Type -FR(*)
Colour : Black, other colours available on request

TEMPERATURE RANGE

-25°C up to +100°C (short time 125°C)

Part No. #	DN size				mm	Max. working pressure		Min. burst pressure		Min. bend radius	Weight	Fittings
	mm	inch	mm	inch		MPa	psi	MPa	psi			
8LPG-3	5	-03	4.8	3/16	8.0	3.0	435	15.0	2,175	50	0.033	PX-LPG
8LPG-4	6	-04	6.3	1/4	9.8	3.0	435	15.0	2,175	75	0.043	PX-LPG
8LPG-5	8	-05	7.9	5/16	12.2	3.0	435	15.0	2,175	90	0.067	PX-LPG
8LPG-6	10	-06	9.5	3/8	13.7	3.0	435	15.0	2,175	100	0.075	PX-LPG
8LPG-3-FR*	5	-03	4.8	3/16	9.5	3.0	435	15.0	2,175	50	0.058	PX-LPG
8LPG-4-FR*	6	-04	6.3	1/4	11.5	3.0	435	15.0	2,175	75	0.071	PX-LPG
8LPG-5-FR*	8	-05	7.9	5/16	13.8	3.0	435	15.0	2,175	90	0.085	PX-LPG
8LPG-6-FR*	10	-06	9.5	3/8	15.3	3.0	435	15.0	2,175	100	0.090	PX-LPG

*Improved mechanical and chemical protection through flame resistant 2nd outer cover

NOTES

- Factory made assemblies only

Table of contents**Part 6 – Hose Fittings**

56 series	E-42
9X series	E-56
CG series	E-60
EX series	E-63
NX series	E-70
PX series	E-76

Hose Fittings
1CA56

518C • 520N/528N • 53DM • 540N • 550H • 55LT •
560TJ • 580N/588N • 590TJ • 53DM • 2040N • 2040H

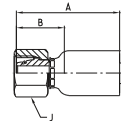

1CA56 – Metric female swivel 24° with O-ring

Light series – Metric swivel nut – ISO 12151-2

MATERIAL Galvanised steel with transparent Cr(VI)-free plating.
Other materials available on request.

Part No. #	DN size				Connection type		A mm	B mm	J mm	Max. WP MPa
	mm	inch	Thread size	Tube OD mm						
1CA56-6-3	5	-03	4.8	3/16	M12x1.5	6	39.6	21.9	14	31.5
1CA56-6-4	6	-04	6.4	1/4	M12x1.5	6	48.0	24.0	14	31.5
1CA56-8-4	6	-04	6.4	1/4	M14x1.5	8	47.1	22.6	17	42.5
1CA56-10-4	6	-04	6.4	1/4	M16x1.5	10	46.6	22.1	19	40.0
1CA56-12-4	6	-04	6.4	1/4	M18x1.5	12	46.6	22.1	22	35.0
1CA56-10-5	8	-05	7.9	5/16	M16x1.5	10	47.9	22.1	19	40.0
1CA56-12-5	8	-05	7.9	5/16	M18x1.5	12	47.9	22.1	22	35.0
1CA56-10-6	10	-06	9.5	3/8	M16x1.5	10	47.6	22.4	19	40.0
1CA56-12-6	10	-06	9.5	3/8	M18x1.5	12	47.6	22.4	22	35.0
1CA56-15-6	10	-06	9.5	3/8	M22x1.5	15	48.1	22.9	27	31.5
1CA56-15-8	12	-08	12.7	1/2	M22x1.5	15	53.3	24.9	27	31.5
1CA56-18-8	12	-08	12.7	1/2	M26x1.5	18	53.3	24.9	32	31.5
1CA56-18-10	16	-10	15.9	5/8	M26x1.5	18	59.6	26.3	32	31.5
1CA56-18-12	20	-12	19.0	3/4	M26x1.5	18	59.6	25.7	32	31.5
1CA56-22-12	20	-12	19.0	3/4	M30x2	22	57.6	29.2	36	28.0
1CA56-28-16	25	-16	25.4	1	M36x2	28	77.4	29.3	41	21.0

Hose fittings

1518C • 520N/528N • 53DM • 540N • 550H • 55LT •
560TJ • 580N/588N • 590TJ • 53DM • 2040N • 2040H

Hose Fittings
1CE56 – 1CF56

1CE56 – Metric female swivel 24° with O-ring

45° elbow – Light series – Metric swivel nut – ISO 12151-2

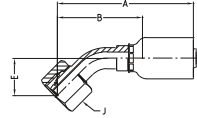

MATERIAL Galvanised steel with transparent Cr(VI)-free plating.
Other materials available on request.

Part No. #	DN	size		Connection type		Tube OD mm	A mm	B mm	E mm	J mm	Max. WP MPa
		mm	inch	Thread size	mm						
1CE56-6-3	5	-03	4.8	3/16	M12x1.5	6	57.0	39.5	16.0	14	31.5
1CE56-8-4	6	-04	6.4	1/4	M14x1.5	8	62.0	38.0	16.0	17	42.5
1CE56-10-4	6	-04	6.4	1/4	M16x1.5	10	62.0	38.0	16.0	19	40.0
1CE56-10-5	8	-05	7.9	5/16	M16x1.5	10	72.0	46.0	15.0	19	40.0
1CE56-10-6	10	-06	9.5	3/8	M16x1.5	10	75.0	49.8	19.7	19	40.0
1CE56-12-6	10	-06	9.5	3/8	M18x1.5	12	73.0	48.0	19.0	22	35.0
1CE56-15-8	12	-08	12.7	1/2	M22x1.5	15	78.3	49.9	22.0	27	31.5
1CE56-18-12	20	-12	19.0	3/4	M26x1.5	18	101.0	67.0	27.0	32	31.5
1CE56-22-12	20	-12	19.0	3/4	M30x2	22	100.0	66.0	26.0	36	28.0
1CE56-28-16	25	-16	25.4	1	M36x2	28	133.5	85.4	33.0	41	21.0

1CF56 – Metric female swivel 24° with O-ring

90° elbow – Light series – Metric swivel nut – ISO 12151-2

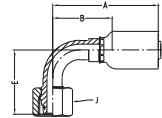

MATERIAL Galvanised steel with transparent Cr(VI)-free plating.
Other materials available on request.

Part No. #	DN	size		Connection type		Tube OD mm	A mm	B mm	E mm	J mm	Max. WP MPa
		mm	inch	Thread size	mm						
1CF56-6-3	5	-03	4.8	3/16	M12x1.5	6	48.0	30.3	30.0	14	31.5
1CF56-6-4	6	-04	6.4	1/4	M12x1.5	6	53.0	29.0	33.2	14	31.5
1CF56-8-4	6	-04	6.4	1/4	M14x1.5	8	55.0	30.0	28.5	17	42.5
1CF56-10-4	6	-04	6.4	1/4	M16x1.5	10	55.0	31.0	29.0	19	40.0
1CF56-10-5	8	-05	7.9	5/16	M16x1.5	10	66.0	40.0	29.0	19	40.0
1CF56-12-5	8	-05	7.9	5/16	M18x1.5	12	65.0	40.0	30.0	22	35.0
1CF56-10-6	10	-06	9.5	3/8	M16x1.5	10	64.1	38.9	37.0	19	40.0
1CF56-12-6	10	-06	9.5	3/8	M18x1.5	12	63.0	38.0	35.0	22	35.0
1CF56-15-8	12	-08	12.7	1/2	M22x1.5	15	68.0	39.6	42.6	27	31.5
1CF56-18-10	16	-10	15.9	5/8	M26x1.5	18	87.7	45.4	51.5	32	31.5
1CF56-22-12	20	-12	19.0	3/4	M30x2	22	91.6	57.7	55.0	36	28.0
1CF56-28-16	25	-16	25.4	1	M36x2	28	122.0	74.0	71.0	41	21.0

Hose Fittings
1D056 – 1C356

518C • 520N/528N • 53DM • 540N • 550H • 55LT •
560TJ • 580N/588N • 590TJ • 53DM • 2040N • 2040H

1D056 – Metric male 24°

Light series – ISO 12151-2

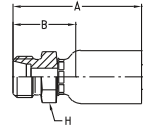

MATERIAL Galvanised steel with transparent Cr(VI)-free plating.
Other materials available on request.

Part No. #	DN size			mm		inch		Connection type		A mm	B mm	H mm	Max. WP MPa
	size	mm	inch	Thread size	Tube OD mm								
1D056-6-3	5	-03	4.8	3/16	M12x1.5	6	41.0	23.0	12	25.0			
1D056-8-4	6	-04	6.4	1/4	M14x1.5	8	46.9	22.4	14	42.5			
1D056-10-5	8	-05	7.9	5/16	M16x1.5	10	49.8	24.0	17	40.0			
1D056-12-5	8	-05	7.9	5/16	M18x1.5	12	51.7	25.9	19	35.0			
1D056-10-6	10	-06	9.5	3/8	M16x1.5	10	49.5	24.3	17	40.0			
1D056-12-6	10	-06	9.5	3/8	M18x1.5	12	49.5	24.3	19	35.0			
1D056-15-6	10	-06	9.5	3/8	M22x1.5	15	51.7	26.5	22	31.5			
1D056-15-8	12	-08	12.7	1/2	M22x1.5	15	54.9	26.6	22	31.5			
1D056-18-10	16	-10	15.9	5/8	M26x1.5	18	63.6	30.3	27	31.5			
1D056-22-12	20	-12	19.0	3/4	M30x2	22	67.6	33.7	30	28.0			
1D056-28-16	25	-16	25.4	1	M36x2	28	81.9	33.8	36	21.0			

Hose fittings

1C356 – Metric female swivel 24°/60°

Light series – Metric swivel nut

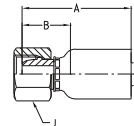

MATERIAL Galvanised steel with transparent Cr(VI)-free plating.
Other materials available on request.

Part No. #	DN size			mm		inch		Connection type		A mm	B mm	J mm	Max. WP MPa
	size	mm	inch	Thread size	Tube OD mm								
1C356-6-3	5	-03	4.8	3/16	M12x1.5	6	37.4	19.7	14	25.0			
1C356-8-4	6	-04	6.4	1/4	M14x1.5	8	44.1	19.6	17	25.0			
1C356-10-4	6	-04	6.4	1/4	M16x1.5	10	45.0	20.0	19	25.0			
1C356-10-5	8	-05	7.9	5/16	M16x1.5	10	46.1	20.3	19	25.0			
1C356-12-5	8	-05	7.9	5/16	M18x1.5	12	47.0	12.1	22	25.0			
1C356-10-6	10	-06	9.5	3/8	M16x1.5	10	45.8	20.6	19	25.0			
1C356-12-6	10	-06	9.5	3/8	M18x1.5	12	46.6	21.4	22	25.0			
1C356-15-8	12	-08	12.7	1/2	M22x1.5	15	49.6	21.2	27	25.0			
1C356-18-12	20	-12	19.0	3/4	M26x1.5	18	57.6	23.7	32	16.0			
1C356-22-12	20	-12	19.0	3/4	M30x2	22	60.4	26.5	36	16.0			

518C • 520N/528N • 53DM • 540N • 550H • 55LT •
560TJ • 580N/588N • 590TJ • 53DM • 2040N • 2040H



Hose Fittings
1C456 – 1C556

1C456 – Metric female swivel 24°/60° 45° elbow – Light series – Metric swivel nut

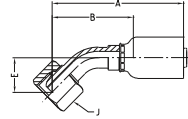

MATERIAL Galvanised steel with transparent Cr(VI)-free plating.
Other materials available on request.

Part No. #	DN	size		Connection type		Tube OD mm	A mm	B mm	E mm	J mm	Max. WP MPa
		mm	inch	Thread size	mm						
1C456-6-3	5	-03	4.8	3/16	M12x1.5	6	57.0	40.0	16	14	25.0
1C456-8-4	6	-04	6.4	1/4	M14x1.5	8	60.0	35.8	14	17	25.0
1C456-10-5	8	-05	7.9	5/16	M16x1.5	10	62.0	37.0	15	19	25.0
1C456-12-6	10	-06	9.5	3/8	M18x1.5	12	72.5	47.0	18	22	25.0
1C456-15-8	12	-08	12.7	1/2	M22x1.5	15	76.1	47.7	19	27	25.0

1C556 – Metric female swivel 24°/60° 90° elbow – Light series – Metric swivel nut

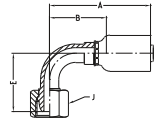

MATERIAL Galvanised steel with transparent Cr(VI)-free plating.
Other materials available on request.

Part No. #	DN	size		Connection type		Tube OD mm	A mm	B mm	E mm	J mm	Max. WP MPa
		mm	inch	Thread size	mm						
1C556-6-3	5	-03	4.8	3/16	M12x1.5	6	48.0	30.3	30.0	14	25.0
1C556-8-4	6	-04	6.4	1/4	M14x1.5	8	53.0	28.0	26.0	17	25.0
1C556-10-4	6	-04	6.4	1/4	M16x1.5	10	53.0	28.0	27.0	19	25.0
1C556-10-5	8	-05	7.9	5/16	M18x1.5	10	66.0	40.0	33.0	19	25.0
1C556-10-6	10	-06	9.5	3/8	M16x1.5	10	63.0	38.0	33.3	19	25.0
1C556-12-6	10	-06	9.5	3/8	M18x1.5	12	63.0	38.0	34.0	22	25.0
1C556-15-8	12	-08	12.7	1/2	M22x1.5	15	96.8	68.4	39.0	27	25.0

Hose Fittings
1C956 – 10C56

518C • 520N/528N • 53DM • 540N • 550H • 55LT •
560TJ • 580N/588N • 590TJ • 53DM • 2040N • 2040H



1C956 – Metric female swivel 24° with O-ring

Heavy series – Metric swivel nut – ISO 12151-2

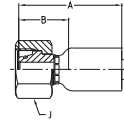

MATERIAL Galvanised steel with transparent Cr(VI)-free plating.
Other materials available on request.

Part No. #	DN size				Connection type		A mm	B mm	J mm	Max. WP MPa
	mm	inch	Thread size	Tube OD mm						
1C956-8-3	5	-03	4.8	3/16	M16x1.5	8	40.5	22.8	19	63.0
1C956-8-4	6	-04	6.4	1/4	M16x1.5	8	48.0	23.0	19	63.0
1C956-10-4	6	-04	6.4	1/4	M18x1.5	10	47.5	23.0	22	63.0
1C956-12-4	6	-04	6.4	1/4	M20x1.5	12	48.4	23.9	24	63.0
1C956-10-5	8	-05	7.9	5/16	M18x1.5	10	48.8	23.0	22	63.0
1C956-12-5	8	-05	7.9	5/16	M20x1.5	12	49.7	23.9	24	63.0
1C956-12-6	10	-06	9.5	3/8	M20x1.5	12	49.4	24.2	24	63.0
1C956-14-6	10	-06	9.5	3/8	M22x1.5	14	49.3	24.1	27	63.0
1C956-16-8	12	-08	12.7	1/2	M24x1.5	16	55.7	27.3	30	42.0
1C956-25-12	20	-12	19.0	3/4	M36x2	25	66.0	32.1	46	42.0

Hose fittings

10C56 – Metric female swivel 24° with O-ring

45° elbow – Heavy series – Metric swivel nut – ISO 12151-2

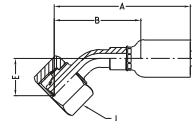

MATERIAL Galvanised steel with transparent Cr(VI)-free plating.
Other materials available on request.

Part No. #	DN size				Connection type		A mm	B mm	E mm	J mm	Max. WP MPa
	mm	inch	Thread size	Tube OD mm							
10C56-8-3	5	-03	4.8	3/16	M16x1.5	8	59.0	41.0	18.0	19	63.0
10C56-10-4	6	-04	6.4	1/4	M18x1.5	10	63.8	39.3	17.0	22	63.0
10C56-12-5	8	-05	7.9	5/16	M20x1.5	12	98.7	42.9	17.2	24	63.0
10C56-12-6	10	-06	9.5	3/8	M20x1.5	12	74.6	49.4	20.0	24	63.0
10C56-16-8	12	-08	12.7	1/2	M24x1.5	16	79.5	51.0	23.0	30	42.0

518C • 520N/528N • 53DM • 540N • 550H • 55LT •
560TJ • 580N/588N • 590TJ • 53DM • 2040N • 2040H



Hose Fittings
11C56 – 1D256

11C56 – Metric female swivel 24° with O-ring 90° elbow – Heavy series – Metric swivel nut – ISO 12151-2

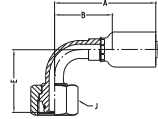

MATERIAL Galvanised steel with transparent Cr(VI)-free plating.
Other materials available on request.

Part No. #	DN				Connection type		A mm	B mm	E mm	J mm	Max. WP MPa
	size	mm	inch	Thread size	Tube OD mm						
11C56-8-3	5	-03	4.8	3/16	M16x1.5	8	48	30.3	28.5	19	63.0
11C56-10-4	6	-04	6.4	1/4	M18x1.5	10	53	29.0	22.0	22	63.0
11C56-12-5	8	-05	7.9	5/16	M20x1.5	12	65	39.0	31.0	24	63.0
11C56-12-6	10	-06	9.5	3/8	M20x1.5	12	63	38.0	37.0	24	63.0
11C56-16-8	12	-08	12.7	1/2	M24x1.5	16	68	39.6	45.0	30	42.0

1D256 – Metric male 24° Heavy series – ISO 12151-2

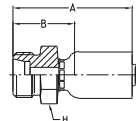

MATERIAL Galvanised steel with transparent Cr(VI)-free plating.
Other materials available on request.

Part No. #	DN				Connection type		A mm	B mm	H mm	Max. WP MPa
	size	mm	inch	Thread size	Tube OD mm					
1D256-8-3	5	-03	4.8	3/16	M16x1.5	8	42.4	24.7	17	63.0
1D256-10-4	6	-04	6.4	1/4	M18x1.5	10	51.5	27.0	19	63.0
1D256-10-5	8	-05	7.9	5/16	M18x1.5	10	52.8	27.0	19	63.0
1D256-12-5	8	-05	7.9	5/16	M20x1.5	12	52.8	27.0	22	63.0
1D256-12-6	10	-06	9.5	3/8	M20x1.5	12	52.6	27.4	22	63.0
1D256-14-6	10	-06	9.5	3/8	M22x1.5	14	56.4	31.2	22	63.0
1D256-16-6	10	-06	9.5	3/8	M24x1.5	16	56.4	31.2	24	42.0
1D256-16-8	12	-08	12.7	1/2	M24x1.5	16	59.7	31.3	24	42.0
1D256-20-12	20	-12	19.0	3/4	M30x2	20	72.1	38.2	30	42.0

Hose fittings

Hose Fittings
1C656 – 14956

518C • 520N/528N • 53DM • 540N • 550H • 55LT •
560TJ • 580N/588N • 590TJ • 53DM • 2040N • 2040H



1C656 – Metric female swivel 24°/60°

Heavy series – Metric swivel nut

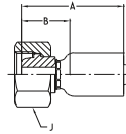

MATERIAL Galvanised steel with transparent Cr(VI)-free plating.
Other materials available on request.

Part No. #	DN size				Connection type		A mm	B mm	J mm	Max. WP MPa
	mm	inch	Thread size	Tube OD mm						
1C656-8-3	5	-03	4.8	3/16	M16x1.5	8	38.1	20.4	19	63.0
1C656-10-4	6	-04	6.4	1/4	M18x1.5	10	46.6	22.1	22	63.0
1C656-12-5	8	-05	7.9	5/16	M20x1.5	12	49.6	23.8	24	63.0
1C656-12-6	10	-06	9.5	3/8	M20x1.5	12	49.3	24.1	24	63.0
1C656-14-6	10	-06	9.5	3/8	M22x1.5	14	48.6	23.4	27	63.0
1C656-16-8	12	-08	12.7	1/2	M24x1.5	16	53.3	24.9	30	40.0
1C656-20-12	20	-12	19.0	3/4	M30x2	20	61.0	37.0	36	40.0

Hose fittings

14956 – Banjo union

DIN 7642

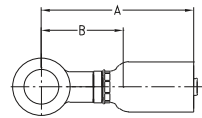

MATERIAL Galvanised steel with transparent Cr(VI)-free plating.
Other materials available on request.

Part No. #	DN size				Tube OD mm	A mm	B mm	Max. WP MPa
mm	inch	Thread size	Tube OD mm					
14956-14-3	5	-03	4.8	3/16	14	48.5	30.8	20.0
14956-12-4	6	-04	6.4	1/4	12	52.5	28.0	20.0
14956-14-4	6	-04	6.4	1/4	14	56.0	32.0	20.0
14956-12-5	8	-05	7.9	5/16	12	54.0	29.0	20.0
14956-14-5	8	-05	7.9	5/16	14	56.3	30.5	20.0
14956-17-6	10	-06	9.5	3/8	17	54.5	29.3	20.0

518C • 520N/528N • 53DM • 540N • 550H • 55LT •
560TJ • 580N/588N • 590TJ • 53DM • 2040N • 2040H



Hose Fittings
19256 – 1B156

19256 – BSP female swivel 60° cone

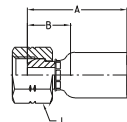

MATERIAL Galvanised steel with transparent Cr(VI)-free plating.
Other materials available on request.

Part No. #	DN size			mm		inch		Connection type		A mm	B mm	J mm	Max. WP MPa
	size	mm	inch	Thread size	Tube OD inch	mm	inch	Thread size	Tube OD inch				
19256-4-3	5	-03	4.8	3/16	G1/4	1/4	34.8	17.1	19	63.0			
19256-4-4	6	-04	6.4	1/4	G1/4	1/4	41.8	17.3	19	63.0			
19256-6-4	6	-04	6.4	1/4	G3/8	3/8	44.9	20.4	22	55.0			
19256-4-5	8	-05	7.9	5/16	G1/4	1/4	47.1	21.3	19	63.0			
19256-6-5	8	-05	7.9	5/16	G3/8	3/8	46.2	20.4	22	55.0			
19256-6-6	10	-06	9.5	3/8	G3/8	3/8	45.9	20.7	22	55.0			
19256-8-6	10	-06	9.5	3/8	G1/2	1/2	48.0	22.8	27	43.0			
19256-8-8	12	-08	12.7	1/2	G1/2	1/2	51.2	22.8	27	43.0			
19256-12-12	20	-12	19.0	3/4	G3/4	3/4	60.3	26.4	32	35.0			
19256-16-16	25	-16	25.4	1	G1	1	73.6	25.5	41	28.0			

1B156 – BSP female swivel 60° cone 45° elbow

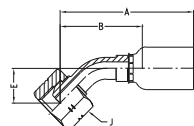

MATERIAL Galvanised steel with transparent Cr(VI)-free plating.
Other materials available on request.

Part No. #	DN size			mm		inch		Connection type		A mm	B mm	E mm	J mm	Max. WP MPa
	size	mm	inch	Thread size	Tube OD inch	mm	inch	Thread size	Tube OD inch					
1B156-4-3	5	-03	4.8	3/16	G1/4	1/4	57	39.3	15.5	19	63.0			
1B156-4-4	6	-04	6.4	1/4	G1/4	1/4	62	38.0	15.0	19	63.0			
1B156-6-5	8	-05	7.9	5/16	G3/8	3/8	65	39.0	17.0	22	55.0			
1B156-6-6	10	-06	9.5	3/8	G3/8	3/8	67	42.0	17.0	22	55.0			
1B156-8-8	12	-08	12.7	1/2	G1/2	1/2	77	48.0	20.0	27	43.0			

Hose Fittings
1B256 – 1B156

518C • 520N/528N • 53DM • 540N • 550H • 55LT •
560TJ • 580N/588N • 590TJ • 53DM • 2040N • 2040H

1B256 – BSP female swivel 60° cone 90° elbow

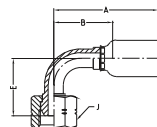

MATERIAL Galvanised steel with transparent Cr(VI)-free plating.
Other materials available on request.

Part No. #	DN size				Connection type		A mm	B mm	E mm	J mm	Max. WP MPa
	mm	inch	Thread size	Tube OD inch							
1B256-4-3	5	-03	4.8	3/16	G1/4	1/4	48.0	30.3	28.0	19	63.0
1B256-4-4	6	-04	6.4	1/4	G1/4	1/4	53.0	29.0	28.0	19	63.0
1B256-6-5	8	-05	7.9	5/16	G3/8	3/8	55.0	30.0	30.4	22	55.0
1B256-6-6	10	-06	9.5	3/8	G3/8	3/8	66.0	41.0	33.0	22	55.0
1B256-8-8	12	-08	12.7	1/2	G1/2	1/2	70.1	41.7	40.5	27	43.0
1B256-12-12	20	-12	19.0	3/4	G3/4	3/4	92.5	58.0	52.2	32	35.0
1B256-16-16	25	-16	25.4	1	G1	1	125.0	77.0	68.5	41	28.0

Hose fittings

518C • 520N/528N • 53DM • 540N • 550H • 55LT •
560TJ • 580N/588N • 590TJ • 53DM • 2040N • 2040H



Hose Fittings
1D956 – 10156

1D956 – BSP male DIN 3852 Form A

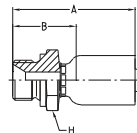

MATERIAL Galvanised steel with transparent Cr(VI)-free plating.
Other materials available on request.

Part No. #	DN size		mm		inch		Connection type		A mm	B mm	H mm	Max. WP MPa
	mm	inch	mm	inch	Thread size	Tube OD inch						
1D956-4-3	5	-03	4.8	3/16	G1/4	1/4	44.4	26.7	19	63.0		
1D956-4-4	6	-04	6.4	1/4	G1/4	1/4	51.5	27.0	19	63.0		
1D956-6-5	8	-05	7.9	5/16	G3/8	3/8	53.0	27.2	22	55.0		
1D956-6-6	10	-06	9.5	3/8	G3/8	3/8	52.9	27.7	22	55.0		
1D956-8-8	12	-08	12.7	1/2	G1/2	1/2	60.0	31.6	27	43.0		
1D956-12-12	20	-12	19.0	3/4	G3/4	3/4	75.1	41.2	32	35.0		
1D956-16-16	25	-16	25.4	1	G1	1	90.5	42.4	41	28.0		

10156 – National Pipe Tapered (NPT) male

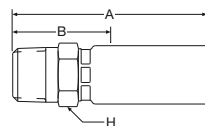

MATERIAL Galvanised steel with transparent Cr(VI)-free plating.
Other materials available on request.

Part No. #	DN size		mm		inch		Connection type		A mm	B mm	H mm	Max. WP MPa
	mm	inch	mm	inch	Thread size	Tube OD inch						
10156-2-2	3	-02	3.2	1/8	1/8 - 27NPTF	1/8	35	18.0	13	34.5		
10156-2-3-SM	5	-03	4.8	3/16	1/8 - 27 NPTF	1/8	40.4	22.7	14	83.0		
10156-4-3-SM	5	-03	4.8	3/16	1/4 - 18 NPTF	1/4	44.9	27.2	17	34.5		
10156-4-4-SM	6	-04	6.4	1/4	1/4 - 18 NPTF	1/4	52.0	27.5	17	34.5		
10156-4-5-SM	8	-05	7.9	5/16	1/4 - 18 NPTF	1/4	53.5	27.3	17	34.5		
10156-4-6-SM	10	-06	9.5	3/8	1/4 - 18 NPTF	1/4	55.0	27.8	17	34.5		
10156-6-6-SM	10	-06	9.5	3/8	3/8 - 18 NPTF	3/8	55.0	29.8	19	27.5		
10156-8-8-SM	12	-08	12.7	1/2	1/2 - 14 NPTF	1/2	63.0	34.6	24	24.0		
10156-12-12-SM	20	-12	19.0	3/4	3/4 - 14 NPTF	3/4	75.4	41.5	32	21.0		
10156-16-16-SM	25	-16	25.4	1	1 - 11 1/2 NPTF	1	93.6	45.5	41	17.0		

Hose fittings

Hose Fittings
10356 – 10656

518C • 520N/528N • 53DM • 540N • 550H • 55LT •
560TJ • 580N/588N • 590TJ • 53DM • 2040N • 2040H

10356 – SAE (JIC) 37° male

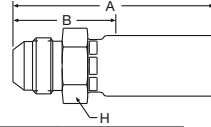

MATERIAL Galvanised steel with transparent Cr(VI)-free plating.
Other materials available on request.

Part No. #	DN		size		mm		inch		Connection type		A mm	B mm	H mm	Max. WP MPa
	size	mm	mm	inch	Thread size	Tube OD inch	Thread size	Tube OD inch						
10356-4-4-SM	6	-04	6.4	1/4	7/16 - 20 UNF	1/4	51.3	26.8	14	41.0				
10356-5-5-SM	8	-05	7.9	5/16	1/2 - 20 UNF	5/16	52.5	26.7	14	41.0				
10356-6-5-SM	8	-05	7.9	5/16	9/16 - 18 UNF	3/8	54.8	29.0	19	34.5				
10356-6-6-SM	10	-06	9.5	3/8	9/16 - 18 UNF	3/8	54.6	29.4	19	34.5				
10356-8-6-SM	10	-06	9.5	3/8	3/4 - 16 UNF	1/2	57.2	37.0	22	34.5				
10356-8-8-SM	12	-08	12.7	1/2	3/4 - 16 UNF	1/2	60.5	32.1	22	34.5				

10656 – SAE (JIC) 37° female swivel UNF swivel nut

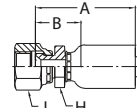

MATERIAL Galvanised steel with transparent Cr(VI)-free plating.
Other materials available on request.

Part No. #	DN		size		mm		inch		Connection type		A mm	B mm	H mm	J mm	Max. WP MPa
	size	mm	mm	inch	Thread size	Tube OD inch	Thread size	Tube OD inch							
10656-4-2	3	-02	3.2	1/8	7/16 - 20UNF	1/4	33	16.0	13	17	41.0				
10656-4-3-SM	5	-03	4.8	3/16	7/16 - 20 UNF	1/4	45.2	27.5	12	17	41.0				
10656-4-4-SM	6	-04	6.4	1/4	7/16 - 20 UNF	1/4	52.0	27.5	14	17	41.0				
10656-5-4-SM	6	-04	6.4	1/4	1/2 - 20 UNF	5/16	53.7	29.2	14	17	41.0				
10656-6-4-SM	6	-04	6.4	1/4	9/16 - 18 UNF	3/8	54.2	29.7	14	19	34.5				
10656-5-5-SM	8	-05	7.9	5/16	1/2 - 20 UNF	5/16	56.0	20.3	14	17	41.0				
10656-6-5-SM	8	-05	7.9	5/16	9/16 - 18 UNF	3/8	56.6	30.8	14	19	34.5				
10656-6-6-SM	10	-06	9.5	3/8	9/16 - 18 UNF	3/8	56.3	31.2	17	19	34.5				
10656-8-6-SM	10	-06	9.5	3/8	3/4 - 16 UNF	1/2	60.2	35.0	19	22	34.5				
10656-8-8-SM	12	-08	12.7	1/2	3/4 - 16 UNF	1/2	64.4	36.0	22	22	34.5				
10656-10-8-SM	12	-08	12.7	1/2	7/8 - 14 UNF	5/8	67.1	38.8	22	27	34.5				
10656-12-12-SM	20	-12	19.0	3/4	1 1/16-12 UNF	3/4	77.8	43.9	27	32	34.5				
10656-16-16-SM	25	-16	25.4	1	1 5/16 - 12 UNF	1	97.0	48.9	32	41	27.5				

Hose fittings

518C • 520N/528N • 53DM • 540N • 550H • 55LT •
560TJ • 580N/588N • 590TJ • 53DM • 2040N • 2040H

Hose Fittings
13756 – 13956

13756 – SAE (JIC) 37° female swivel 45° elbow – UNF swivel nut

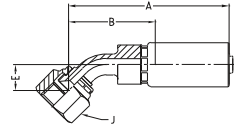

MATERIAL Galvanised steel with transparent Cr(VI)-free plating.
Other materials available on request.

Part No. #	DN			Connection type		Tube OD inch	A mm	B mm	E mm	J mm	Max. WP MPa
	size	mm	inch	Thread size	Thread size						
13756-4-3-SM	5	-03	4.8	3/16	7/16 - 20 UNF	1/4"	55.4	37.7	10	17	41.0
13756-4-4-SM	6	-04	6.4	1/4	7/16 - 20 UNF	1/4"	55.8	31.3	10	17	41.0
13756-6-6-SM	10	-06	9.5	3/8	9/16 - 18 UNF	3/8"	65.0	40.1	11	19	34.5
13756-8-8-SM	12	-08	12.7	1/2	3/4 - 16 UNF	1/2"	69.2	40.8	15	22	34.5
13756-16-16-SM	25	-16	25.4	1	1 5/16 - 12 UNF	1"	120.0	72.0	24	41	27.5

13956 – SAE (JIC) 37° female swivel 90° elbow – UNF swivel nut

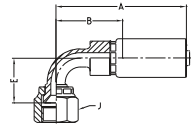

MATERIAL Galvanised steel with transparent Cr(VI)-free plating.
Other materials available on request.

Part No. #	DN			Connection type		Tube OD inch	A mm	B mm	E mm	J mm	Max. WP MPa
	size	mm	inch	Thread size	Thread size						
13956-4-3-SM	5	-03	4.8	3/16	7/16 - 20 UNF	1/4	44.4	26.7	21	17	41.0
13956-4-4-SM	6	-04	6.4	1/4	7/16 - 20 UNF	1/4	51.0	26.5	21	17	41.0
13956-6-4-SM	6	-04	6.4	1/4	9/16 - 18 UNF	3/8	51.0	26.5	23	19	34.5
13956-6-6-SM	10	-06	9.5	3/8	9/16 - 18 UNF	3/8	56.0	30.7	23	19	34.5
13956-8-6-SM	10	-06	9.5	3/8	3/4 - 16 UNF	1/2	65.0	39.5	29	22	34.5
13956-8-8-SM	12	-08	12.7	1/2	3/4 - 16 UNF	1/2	63.0	34.6	29	22	34.5
13956-10-8-SM	12	-08	12.7	1/2	7/8 - 14 UNF	5/8	71.0	42.0	32	27	34.5
13956-16-16-SM	25	-16	25.4	1	1 5/16 - 12 UNF	1	110.8	63.0	56	41	27.5

Hose Fittings
1JC56 – 1J756

518C • 520N/528N • 53DM • 540N • 550H • 55LT •
560TJ • 580N/588N • 590TJ • 53DM • 2040N • 2040H



1JC56 – O-Lok® ORFS swivel nut

Short version – UNF swivel nut – ISO 12151-1

MATERIAL Galvanised steel with transparent Cr(VI)-free plating.
Other materials available on request.

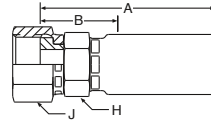

Part No. #	DN size			Connection type		Tube OD inch	A mm	B mm	H mm	J mm	Max. WP MPa
	mm	inch	Thread size	Thread size							
1JC56-4-3-SM	5	-03	4.8	3/16	9/16 - 18 UNF	1/4	39.0	21.3	14	17	41.0
1JC56-4-4-SM	6	-04	6.4	1/4	9/16 - 18 UNF	1/4	46.6	22.1	14	17	41.0
1JC56-6-4-SM	6	-04	6.4	1/4	11/16 - 16 UNF	3/8	50.0	25.0	17	22	41.0
1JC56-6-5-SM	8	-05	7.9	5/16	11/16 - 16 UNF	3/8	51.1	25.3	17	22	41.0
1JC56-6-6-SM	10	-06	9.5	3/8	11/16 - 16 UNF	3/8	50.8	25.6	17	22	41.0
1JC56-8-6-SM	10	-06	9.5	3/8	13/16 - 16 UNF	1/2	53.1	27.9	22	24	41.0
1JC56-8-8-SM	12	-08	12.7	1/2	13/16 - 16 UNF	1/2	54.2	25.8	22	24	41.0
1JC56-10-8-SM	12	-08	12.7	1/2	1 - 14 UNF	5/8	58.5	30.1	27	30	41.0
1JC56-16-16-SM	25	-16	25.4	1	1 7/16 - 12 UNF	1	81.6	34.0	32	41	41.0

Hose fittings

1J756 – O-Lok® ORFS swivel nut

45° elbow – UNF swivel nut – ISO 12151-1

MATERIAL Galvanised steel with transparent Cr(VI)-free plating.
Other materials available on request.

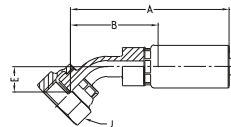

Part No. #	DN size			Connection type		Tube OD inch	A mm	B mm	E mm	J mm	Max. WP MPa
	mm	inch	Thread size	Thread size							
1J756-4-3-SM	5	-03	4.8	3/16	9/16 - 18 UNF	1/4	50.9	33.2	10	17	41.0
1J756-4-4-SM	6	-04	6.4	1/4	9/16 - 18 UNF	1/4	56.4	31.9	10	17	41.0
1J756-6-6-SM	10	-06	9.5	3/8	11/16 - 16 UNF	3/8	59.3	34.1	11	22	41.0
1J756-8-8-SM	12	-08	12.7	1/2	13/16 - 16 UNF	1/2	69.2	40.8	15	24	41.0

518C • 520N/528N • 53DM • 540N • 550H • 55LT •
560TJ • 580N/588N • 590TJ • 53DM • 2040N • 2040H



Hose Fittings
1J956 – 1J056

1J956 – O-Lok® ORFS swivel nut

90° elbow – UNF swivel nut – ISO 12151-1

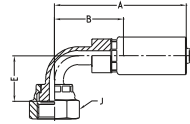

MATERIAL Galvanised steel with transparent Cr(VI)-free plating.
Other materials available on request.

Part No. #	DN size			mm		inch		Connection type		A mm	B mm	E mm	J mm	Max. WP MPa
	size	mm	inch	Thread size	Tube OD inch									
1J956-4-3-SM	5	-03	4.8	3/16	9/16 - 18 UNF	1/4	46.0	28.3	21	17	41.0			
1J956-4-4-SM	6	-04	6.4	1/4	9/16 - 18 UNF	1/4	54.0	26.5	21	17	41.0			
1J956-6-4-SM	6	-04	6.4	1/4	11/16 - 16 UNF	3/8	54.5	30.0	23	22	41.0			
1J956-6-5-SM	8	-05	7.9	5/16	11/16 - 16 UNF	3/8	57.8	32.0	23	22	41.0			
1J956-6-6-SM	10	-06	9.5	3/8	11/16 - 16 UNF	3/8	56.3	31.1	23	22	41.0			
1J956-8-8-SM	12	-08	12.7	1/2	13/16 - 16 UNF	1/2	63.0	34.6	29	24	41.0			
1J956-10-8-SM	12	-08	12.7	1/2	1 - 14 UNF	5/8	71.0	42.0	32	30	41.0			
1J956-12-12-SM	20	-12	19.0	3/4	1 3/16 - 12 UNF	3/4	99.0	65.0	48	36	41.0			
1J956-16-16-SM	25	-16	25.4	1	1 7/16 - 12 UNF	1	110.8	63.0	56	41	41.0			

1J056 – O-Lok® ORFS male

ISO 12151-1

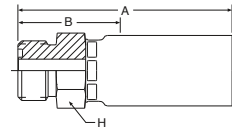

MATERIAL Galvanised steel with transparent Cr(VI)-free plating.
Other materials available on request.

Part No. #	DN size			mm		inch		Connection type		A mm	B mm	H mm	Max. WP MPa
	size	mm	inch	Thread size	Tube OD inch								
1J056-4-4-SM	6	-04	6.4	1/4	9/16 - 18 UNF	1/4	42.9	24.7	17	41.0			
1J056-6-6-SM	10	-06	9.5	3/8	11/16 - 16 UNF	3/8	52.3	28.1	19	41.0			
1J056-8-6-SM	10	-06	9.5	3/8	13/16 - 16 UNF	1/2	54.6	29.4	22	41.0			
1J056-8-8-SM	12	-08	12.7	1/2	13/16 - 16 UNF	1/2	55.4	27.0	22	41.0			

Hose fittings

Hose Fittings
1C39X – 1C99X

2370N



1C39X – Metric female swivel 24°/60°

Light series – Metric swivel nut

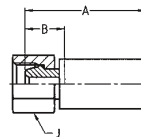

MATERIAL Galvanised steel with transparent Cr(VI)-free plating.
Other materials available on request.

Part No. #	DN size				Connection type		A mm	B mm	J mm	Max. WP MPa
	mm	inch	Thread size	Tube OD mm						
1C39X-12-06	10	-06	9.5	3/8	M18x1.5	12	48	19	22	25.0
1C39X-15-08	12	-08	12.7	1/2	M22x1.5	15	51	20	27	25.0

Hose fittings

1C99X – Metric female swivel 24° with O-ring

Heavy series – Metric swivel nut – ISO 12151-2

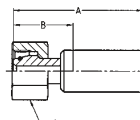

MATERIAL Galvanised steel with transparent Cr(VI)-free plating.
Other materials available on request.

Part No. #	DN size				Connection type		A mm	B mm	J mm	Max. WP MPa
	mm	inch	Thread size	Tube OD mm						
1C99X-12-06	10	-06	9.5	3/8	M20x1.5	12	63	29	24	63.0
1C99X-14-06	10	-06	9.5	3/8	M22x1.5	14	71	30	27	63.0
1C99X-16-08	12	-08	12.7	1/2	M24x1.5	16	78	35	30	42.0

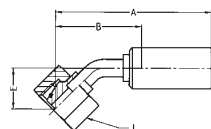
 Hose Fittings
10C9X – 11C9X
10C9X – Metric female swivel 24° with O-ring
 45° elbow – Heavy series – Metric swivel nut – ISO 12151-2

MATERIAL Galvanised steel with transparent Cr(VI)-free plating.
 Other materials available on request.

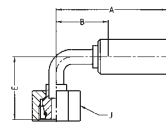
Part No. #	DN size				Connection type		A mm	B mm	E mm	J mm	Max. WP MPa
	mm	inch	Thread size	Tube OD mm							
10C9X-14-06	10	-06	9.5	3/8	M22x1.5	14	81	40	19	27	63.0
10C9X-16-08	12	-08	12.7	1/2	M24x1.5	16	96	53	23	30	42.0

11C9X – Metric female swivel 24° with O-ring
 90° elbow – Heavy series – Metric swivel nut – ISO 12151-2

MATERIAL Galvanised steel with transparent Cr(VI)-free plating.
 Other materials available on request.

Part No. #	DN size				Connection type		A mm	B mm	E mm	J mm	Max. WP MPa
	mm	inch	Thread size	Tube OD mm							
11C9X-12-06	10	6	9.5	3/8	M20x1.5	12	75	30	36	24	63.0
11C9X-14-06	10	-06	9.5	3/8	M22x1.5	14	71	30	36	27	63.0
11C9X-16-08	12	-08	12.7	1/2	M24x1.5	16	85	42	44	30	42.0

Hose fittings

Hose Fittings
1D29X – 1929X



1D29X – Metric male 24°

Heavy series – ISO 12151-2

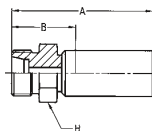

MATERIAL Galvanised steel with transparent Cr(VI)-free plating.
Other materials available on request.

Part No. #	DN size				Connection type		A mm	B mm	H mm	Max. WP MPa
	mm	inch	Thread size	Tube OD mm						
1D29X-14-06	10	-06	9.5	3/8	M22x1.5	14	71	31	22	63.0
1D29X-16-08	12	-08	12.7	1/2	M24x1.5	16	74	31	24	42.0

Hose fittings

1929X – BSP female swivel 60° cone

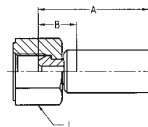

MATERIAL Galvanised steel with transparent Cr(VI)-free plating.
Other materials available on request.

Part No. #	DN size				Connection type		A mm	B mm	J mm	Max. WP MPa
	mm	inch	Thread size	Tube OD mm						
1929X-6-06	10	-06	9.5	3/8	G 3/8	59	19	22	55.0	
1929X-8-08	12	-08	12.7	1/2	G 1/2	63	20	27	43.0	

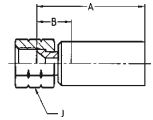
 Hose Fittings
1069X
**1069X – SAE (JIC) 37° female swivel
 UNF swivel nut**

MATERIAL Galvanised steel with transparent Cr(VI)-free plating.
 Other materials available on request.

Part No. #	DN size			Connection type Thread size	A mm	B mm	J mm	Max. WP MPa
	mm	inch	inch					
1069X-6-06	10	-06	9.5	3/8	59	18	22	34.5
1069X-8-06	10	-06	9.5	3/8	59	19	24	34.5
1069X-10-08	12	-08	12.7	1/2	62	19	27	34.5

Hose Fittings
101CG – 106CG

575X • 5CNG • 526BA



101CG – National Pipe Tapered (NPT) male

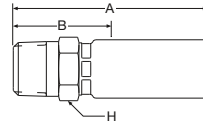

MATERIAL Galvanised steel with transparent Cr(VI)-free plating.
Other materials available on request.

Part No. #	DN size				Connection type		A mm	B mm	H inch	Max. WP MPa
	mm	inch	Thread size	Tube OD inch						
101CG-2-3	5	-03	4.8	3/16	1/8 - 27 NPTF	1/8	49.4	25.0	9/16	82.7
101CG-4-3	5	-03	4.8	3/16	1/4 - 18 NPTF	1/4	53.9	30.0	11/16	82.7
101CG-4-4	6	-04	6.4	1/4	1/4 - 18 NPTF	1/4	58.8	30.0	11/16	82.7
101CG-6-6	10	-06	9.5	3/8	3/8 - 18 NPTF	3/8	67.6	33.0	3/4	69.0
101CG-8-8	12	-08	12.7	1/2	1/2 - 14 NPTF	1/2	78.6	39.0	15/16	69.0
101CG-12-12	20	-12	19.0	3/4	3/4 - 14 NPTF	3/4	99.4	43.0	1 1/4	51.7
101CG-16-16	25	-16	25.4	1	1 - 11 1/2 NPTF	1	120.9	51.0	1 3/4	44.8

Hose fittings

106CG – SAE (JIC) 37° female swivel UNF swivel nut

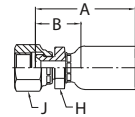

MATERIAL Galvanised steel with transparent Cr(VI)-free plating.
Other materials available on request.

Part No. #	DN size				Connection type		A mm	B mm	H inch	J inch	Max. WP MPa
	mm	inch	Thread size	Tube OD inch							
106CG-4-3	5	-03	4.8	3/16	7/16 - 20 UNF	1/4	56.7	33.0	9/16	9/16	41.4
106CG-4-4	6	-04	6.4	1/4	7/16 - 20 UNF	1/4	60.0	31.0	5/8	9/16	41.4
106CG-6-6	10	-06	9.5	3/8	9/16 - 18 UNF	3/8	68.6	34.0	11/16	11/16	34.5
106CG-8-8	12	-08	12.7	1/2	3/4 - 16 UNF	1/2	78.1	38.0	7/8	7/8	34.5
106CG-12-12	20	-12	19.0	3/4	1 1/16-12 UNF	3/4	105.9	46.0	1 1/4	1 5/16	34.5
106CG-16-16	25	-16	25.4	1	1 5/16 - 12 UNF	1	125.3	56.0	1 3/4	1 5/8	27.6

575X • 5CNG • 526BA

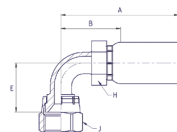
 Hose Fittings
139CG – 1JCCG
139CG – SAE (JIC) 37° female swivel
 90° elbow – UNF swivel nut

MATERIAL Galvanised steel with transparent Cr(VI)-free plating.
 Other materials available on request.

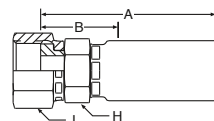
Part No. #	DN size				Connection type		A mm	B mm	E mm	H inch	J inch	Max. WP MPa
	mm	inch	Thread size	Tube OD inch								
139CG-4-4	6	-04	6.4	1/4	7/16 - 20 UNF	1/4	63.7	35.0	17.3	5/8	9/16	41.4
139CG-6-6	10	-06	9.5	3/8	9/16 - 18 UNF	3/8	73.2	38.0	21.6	3/4	11/16	34.5

1JCCG – O-Lok® ORFS swivel nut
 Short version – UNF swivel nut – ISO 12151-1

MATERIAL Galvanised steel with transparent Cr(VI)-free plating.
 Other materials available on request.

Part No. #	DN size				Connection type		A mm	B mm	H inch	J inch	Max. WP MPa
	mm	inch	Thread size	Tube OD inch							
1JCCG-4-4	6	-04	6.4	1/4	9/16 - 18 UNF	1/4	53.2	25.0	5/8	11/16	63.0
1JCCG-6-6	10	-06	9.5	3/8	11/16 - 16 UNF	3/8	62.7	28.0	11/16	13/16	63.0
1JCCG-8-8	12	-08	12.7	1/2	13/16 - 16 UNF	1/2	69.9	30.0	7/8	15/16	63.0
1JCCG-12-12	20	-12	19.0	3/4	1 - 14 UNF	3/4	97.9	38.0	1 1/4	1 3/8	41.4
1JCCG-16-16	25	-16	25.4	1	1 7/16 - 12 UNF	1	118.3	48.0	1 3/4	1 5/8	41.4

Hose fittings

Hose Fittings
1J7CG – 1J9CG

575X • 5CNG • 526BA



1J7CG – O-Lok® ORFS swivel nut

45° elbow – UNF swivel nut – ISO 12151-1

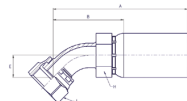

MATERIAL Galvanised steel with transparent Cr(VI)-free plating.
Other materials available on request.

Part No. #	DN size				Connection type		A mm	B mm	E mm	H inch	J inch	Max. WP MPa
	mm	inch	Thread size	Tube OD inch								
1J7CG-6-6	10	-06	9.5	3/8	11/16 - 16 UNF	3/8	75.6	41.0	10.9	3/4	13/16	63.0
1J7CG-8-8	12	-08	12.7	1/2	13/16 - 16 UNF	1/2	88.7	49.0	15.0	7/8	15/16	63.0
1J7CG-12-12	20	-12	19.0	3/4	1 - 14 UNF	3/4	114.5	56.0	20.5	1 1/8	1 3/8	41.4

Hose fittings

1J9CG – O-Lok® ORFS swivel nut

90° elbow – UNF swivel nut – ISO 12151-1

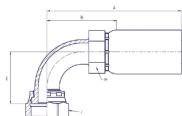

MATERIAL Galvanised steel with transparent Cr(VI)-free plating.
Other materials available on request.

Part No. #	DN size				Connection type		A mm	B mm	E mm	H inch	J inch	Max. WP MPa
	mm	inch	Thread size	Tube OD inch								
1J9CG-4-4	6	-04	6.4	1/4	9/16 - 18 UNF	1/4	67.8	39.0	21.1	5/8	11/16	63.0
1J9CG-6-6	10	-06	9.5	3/8	11/16 - 16 UNF	3/8	72.1	37.0	23.1	3/4	13/16	63.0
1J9CG-12-12	20	-12	19.0	3/4	1 - 14 UNF	3/4	112.3	54.0	48.0	1 1/8	1 3/8	41.4
1J9CG-16-16	25	-16	25.4	1	1 7/16 - 12 UNF	1	147.2	76.0	58.4	1 3/4	1 5/8	41.4

1CAEX – Metric female swivel 24° with O-ring

Light series – Metric swivel nut – ISO 12151-2

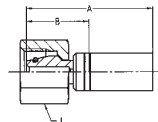

MATERIAL Galvanised steel with transparent Cr(VI)-free plating.
Other materials available on request.

Part No. #	DN size				Connection type		A mm	B mm	J mm	Max. WP MPa
	mm	inch	mm	inch	Thread size	Tube OD mm				
1CAEX-6-012	2	-012	2.0	5/64	M12x1.5	6	32	21	14	31.5
1CAEX-8-012	2	-012	2.0	5/64	M14x1.5	8	37	26	17	42.5
1CAEX-6-016	2.5	-016	2.5	3/32	M12x1.5	6	28	18	14	31.5
1CAEX-6-025	4	-025	4.0	5/32	M12x1.5	6	42	20	14	31.5
1CAEX-8-025	4	-025	4.0	5/32	M14x1.5	8	48	24	17	42.5

1C9EX – Metric female swivel 24° with O-ring

Heavy series – Metric swivel nut – ISO 12151-2

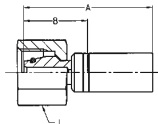

MATERIAL Galvanised steel with transparent Cr(VI)-free plating.
Other materials available on request.

Part No. #	DN size				Connection type		A mm	B mm	J mm	Max. WP MPa
	mm	inch	mm	inch	Thread size	Tube OD mm				
1C9EX-6-012	2	-012	2.0	5/64	M14x1.5	6	32	21	17	63.0
1C9EX-8-012	2	-012	2.0	5/64	M16x1.5	8	37	26	19	63.0
1C9EX-8-02	3	-02	3.2	1/8	M16x1.5	8	32	22	19	63.0
1C9EX-8-025	4	-025	4.0	5/32	M16x1.5	8	45	22	19	63.0

Hose Fittings
11DEX – 13DEX

2010H • 2020N



11DEX – Metric standpipe

Light series

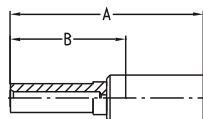

MATERIAL Galvanised steel with transparent Cr(VI)-free plating.
Other materials available on request.

Part No. #	DN	size	mm	inch	Tube OD mm	A mm	B mm	Max. WP MPa
11DEX-4-012	2	-012	2.0	5/64	4	37	26	25.0
11DEX-4-025	4	-025	4.0	5/32	4	52	30	25.0
11DEX-6-025	4	-025	4.0	5/32	6	54	32	25.0

NOTE: Not recommended for new constructions. Please refer to end connections C3 or CA.

Hose fittings

13DEX – Metric standpipe

Heavy series

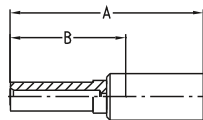

MATERIAL Galvanised steel with transparent Cr(VI)-free plating.
Other materials available on request.

Part No. #	DN	size	mm	inch	Tube OD mm	A mm	B mm	Max. WP MPa
13DEX-6-012	2	-012	2.0	5/64	6	37	26	63.0
13DEX-8-012	2	-012	2.0	5/64	8	37	26	63.0
13DEX-8-025	4	-025	4.0	5/32	8	56	34	63.0

NOTE: Not recommended for new constructions. Please refer to end connections C9.

E

2010H • 2020N

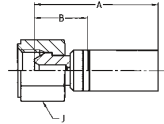
 Hose Fittings
192EX – 1D9EX
192EX – BSP female swivel 60° cone

MATERIAL Galvanised steel with transparent Cr(VI)-free plating.
 Other materials available on request.

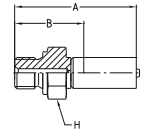
Part No. #	DN size				Connection type Thread size	A mm	B mm	J mm	Max. WP MPa
	mm	inch	mm	inch					
192EX-4-025	4	-025	4.0	5/32	G 1/4	39	17	17	63.0

**1D9EX – BSP male
 DIN 3852 Form A**

MATERIAL Galvanised steel with transparent Cr(VI)-free plating.
 Other materials available on request.

Part No. #	DN size				Connection type Thread size	A mm	B mm	H mm	Max. WP MPa
	mm	inch	mm	inch					
1D9EX-4-012	2	-012	2.0	5/64	G 1/4	40	29	19	63.0

Hose fittings

Hose Fittings
1BPEX – 101EX

2010H • 2020N



1BPEX – BSP female

Rigid

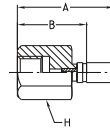

MATERIAL Galvanised steel with transparent Cr(VI)-free plating.
Other materials available on request.

Part No. #	DN size				Connection type Thread size	A mm	B mm	H mm	Max. WP MPa
	mm	inch	mm	inch					
1BPEX-4-012	2	-012	2.0	5/64	G 1/4	39	28	19	34.5

Hose fittings

101EX – National Pipe Tapered (NPT) male

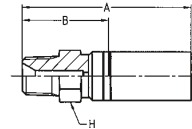

MATERIAL Galvanised steel with transparent Cr(VI)-free plating.
Other materials available on request.

Part No. #	DN size				Connection type Thread size	A mm	B mm	H mm	Max. WP MPa
	mm	inch	mm	inch					
101EX-2-012	2	-012	2.0	5/65	1/8 - 27NPTF	32	22	12	34.5
101EX-4-012	2	-012	2.0	5/64	1/4 - 18NPTF	39	28	14	34.5
101EX-2-025	4	-025	4.0	5/32	1/8 - 27NPTF	46	24	12	34.5
101EX-4-025	4	-025	4.0	5/32	1/4 - 18NPTF	50	28	14	34.5

2010H • 2020N

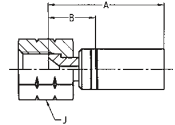
 Hose Fittings
106EX – 1JCEX
**106EX – SAE (JIC) 37° female swivel
 UNF swivel nut**

MATERIAL Galvanised steel with transparent Cr(VI)-free plating.
 Other materials available on request.

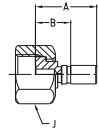
Part No. #	DN size				Connection type		A mm	B mm	J mm	Max. WP MPa
	mm	inch	Thread size	Thread size						
106EX-3-012	2	-012	2.0	5/64	3/8 - 24UNF	23	12	14	41.0	
106EX-4-012	2	-012	2.0	5/64	7/16 - 20UNF	25	14	17	41.0	
106EX-4-025	4	-025	4.0	5/32	7/16 - 20UNF	40	18	17	41.0	

**1JCEX – O-Lok® ORFS swivel nut
 Short version – UNF swivel nut – ISO 12151-1**

MATERIAL Galvanised steel with transparent Cr(VI)-free plating.
 Other materials available on request.

Part No. #	DN size				Connection type		A mm	B mm	J mm	Max. WP MPa
	mm	inch	Thread size	Tube OD inch						
1JCEX-4-012	2	-012	2.0	5/64	9/16 - 18 UNF	1/4	28	17	14	41.0
1JCEX-6-012	2	-012	2.0	5/64	11/16 - 16 UNF	3/8	26	15	22	41.0

Hose fittings

Hose Fittings
149EX – 1R8EX



149EX – Banjo union

DIN 7642

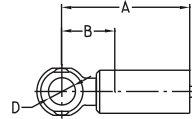

MATERIAL Galvanised steel with transparent Cr(VI)-free plating.
Other materials available on request.

Part No.	DN	size	mm	inch	Tube OD	A	B	Max. WP
#						mm	mm	MPa
149EX-8-02	3	-02	3.2	1/8	8	23	13	20.0
149EX-10-025	4	-025	4.0	5/32	10	44	22	20.0

Hose fittings

1R8EX – Quick connect fitting with metric swivel nut

Knurled

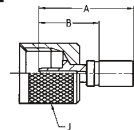

MATERIAL Galvanised steel with transparent Cr(VI)-free plating.
Other materials available on request.

Part No.	DN	size	mm	inch	Connection type	A	B	Max. WP
#					Thread size	mm	mm	MPa
1R8EX-11-012	2	-012	2.0	5/64	M16x2	30	19	63.0
1R8EX-11-02	3	-02	3.2	1/8	M16x2	30	20	63.0

E

2010H • 2020N



Hose Fittings
1YPEX – 1YREX

1YPEX – Quick connect fitting with clip

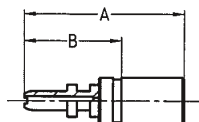

MATERIAL Galvanised steel with transparent Cr(VI)-free plating.
Other materials available on request.

Part No. Fitting #	Part No. Clip #	DN size mm inch	Connection type Thread size	A mm	B mm	Max. WP MPa
1YPEX-3-012	HG-DN2	02 -12 2.0 5/64	-	28	17	63.0

1YREX – Quick connect fitting with metric swivel nut

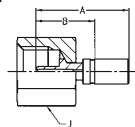

MATERIAL Galvanised steel with transparent Cr(VI)-free plating.
Other materials available on request.

Part No. #	DN size mm inch	Connection type Thread size	A mm	B mm	J mm	Max. WP MPa
1YREX-10-012	2 -012 2.0 5/64	M16x1.5	30	19	19	63.0
1YREX-11-012	2 -012 2.0 5/64	M16x2	30	19	19	63.0

Hose fittings

Hose Fittings
1C3NX – 1C6NX

2370N • 2245N • 2380F • 2246F



1C3NX – Metric female swivel 24°/60°

Light series – Metric swivel nut

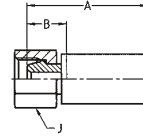

MATERIAL Galvanised steel with transparent Cr(VI)-free plating.
For fittings as mentioned above, but with stainless steel nipple (AISI 303), please add **C2W** to the Part No. Example: 1C3NX-8-04 **C2W**.
Other materials available on request.

Part No. #	DN size				Connection type		A mm	B mm	J mm	Max. WP MPa
	mm	inch	Thread size	Tube OD mm						
1C3NX-8-04	6	-04	6.4	1/4	M14x1.5	8	46	18	17	25.0
1C3NX-10-04	6	-04	6.4	1/4	M16x1.5	10	46	18	19	25.0
1C3NX-10-05	8	-05	7.9	5/16	M16x1.5	10	46	18	19	25.0
1C3NX-10-06	10	-06	9.5	3/8	M16x1.5	10	49	20	22	25.0
1C3NX-12-06	10	-06	9.5	3/8	M18x1.5	12	48	19	22	25.0
1C3NX-12-08	12	-08	12.7	1/2	M18x1.5	12	52	20	24	25.0
1C3NX-15-08	12	-08	12.7	1/2	M22x1.5	15	51	20	27	25.0
1C3NX-18-10	16	-10	15.9	5/8	M26x1.5	18	76	24	32	25.0

Hose fittings

1C6NX – Metric female swivel 24°/60°

Heavy series – Metric swivel nut

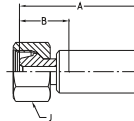

MATERIAL Galvanised steel with transparent Cr(VI)-free plating.
Other materials available on request.

Part No. #	DN size				Connection type		A mm	B mm	J mm	Max. WP MPa
	mm	inch	Thread size	Tube OD mm						
1C6NX-8-04	6	-04	6.4	1/4	M16x1.5	8	58	26	19	63.0
1C6NX-10-04	6	-04	6.4	1/4	M18x1.5	10	59	27	22	63.0
1C6NX-12-05	8	-05	7.9	5/16	M20x1.5	12	58	24	24	63.0
1C6NX-14-06	10	-06	9.5	3/8	M22x1.5	14	64	24	27	63.0
1C6NX-16-08	12	-08	12.7	1/2	M24x1.5	16	67	24	30	40.0
1C6NX-20-10	16	-10	15.9	5/8	M30x2	20	79	27	36	40.0
1C6NX-25-12	20	-12	19.0	3/4	M36x2	25	81	30	46	40.0
1C6NX-30-16	25	-16	25.4	1	M42x2	30	82	31	50	25.0

1C9NX – Metric female swivel 24° with O-ring

Heavy series – Metric swivel nut – ISO 12151-2

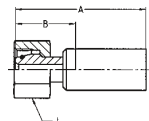

MATERIAL Galvanised steel with transparent Cr(VI)-free plating.
Other materials available on request.

Part No. #	DN size			Connection type		Tube OD mm	A mm	B mm	J mm	Max. WP MPa
	mm	inch	Thread size	mm	inch					
1C9NX-8-04	6	-04	6.4	1/4	M16x1.5	8	60	28	19	63.0
1C9NX-10-04	6	-04	6.4	1/4	M18x1.5	10	65	33	22	63.0
1C9NX-12-05	8	-05	7.9	5/16	M20x1.5	12	63	29	24	63.0
1C9NX-12-06	10	-06	9.5	3/8	M18x1.5	12	69	28	24	63.0
1C9NX-14-06	10	-06	9.5	3/8	M22x1.5	14	71	30	27	63.0
1C9NX-16-08	12	-08	12.7	1/2	M24x1.5	16	78	35	30	42.0
1C9NX-20-10	16	-10	15.9	5/8	M30x2	20	91	40	36	42.0
1C9NX-25-12	20	-12	19.0	3/4	M36x2	25	96	45	46	42.0
1C9NX-30-16	25	-16	25.4	1	M42x2	30	98	47	50	42.0
1C9NX-38-20	32	-20	31.8	1 1/4	M52x2	38	113	52	60	42.0

10CNX – Metric female swivel 24° with O-ring

45° elbow – Heavy series – Metric swivel nut – ISO 12151-2

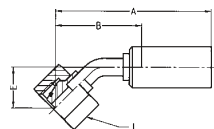

MATERIAL Galvanised steel with transparent Cr(VI)-free plating.
Other materials available on request.

Part No. #	DN size			Connection type		Tube OD mm	A mm	B mm	E mm	J mm	Max. WP MPa
	mm	inch	Thread size	mm	inch						
10CNX-10-04	6	-04	6.4	1/4	M18x1.5	10	82	50	24	22	63.0
10CNX-12-05	8	-05	7.9	5/16	M20x1.5	12	76	42	20	24	63.0
10CNX-12-06	10	-06	9.5	3/8	M20x1.5	12	81	40	19	24	63.0
10CNX-14-06	10	-06	9.5	3/8	M22x1.5	14	81	40	19	27	63.0
10CNX-16-08	12	-08	12.7	1/2	M24x1.5	16	96	53	23	30	42.0
10CNX-20-10	16	-10	15.9	5/8	M30x2	20	120	68	30	36	42.0
10CNX-25-12	20	-12	19.0	3/4	M36x2	25	137	85	37	46	42.0
10CNX-30-16	25	-16	25.4	1	M42x2	30	136	85	43	50	42.0

Hose fittings

Hose Fittings
11CNX – 1D2NX

2370N • 2245N • 2380F • 2246F



11CNX – Metric female swivel 24° with O-ring 90° elbow – Heavy series – Metric swivel nut – ISO 12151-2

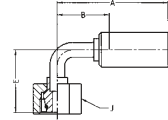

MATERIAL Galvanised steel with transparent Cr(VI)-free plating.
Other materials available on request.

Part No. #	DN size				Connection type		A mm	B mm	E mm	J mm	Max. WP MPa
	mm	inch	Thread size	Tube OD mm							
11CNX-10-04	6	-04	6.4	1/4	M18x1.5	10	66	34	36	22	63.0
11CNX-12-05	8	-05	7.9	5/16	M20x1.5	12	64	30	36	24	63.0
11CNX-14-06	10	-06	9.5	3/8	M22x1.5	14	71	30	36	27	63.0
11CNX-16-08	12	-08	12.7	1/2	M24x1.5	16	85	42	44	30	42.0
11CNX-20-10	16	-10	15.9	5/8	M30x2	20	105	53	61	36	42.0
11CNX-25-12	20	-12	19.0	3/4	M36x2	25	117	65	62	46	42.0
11CNX-30-16	25	-16	25.4	1	M42x2	30	116	65	76	50	42.0

Hose fittings

1D2NX – Metric male 24° Heavy series – ISO 12151-2

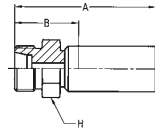

MATERIAL Galvanised steel with transparent Cr(VI)-free plating.
Other materials available on request.

Part No. #	DN size				Connection type		A mm	B mm	H mm	Max. WP MPa
	mm	inch	Thread size	Tube OD mm						
1D2NX-10-04	6	-04	6.4	1/4	M18x1.5	10	65	33	19	63.0
1D2NX-12-05	8	-05	7.9	5/16	M20x1.5	12	62	28	22	63.0
1D2NX-14-06	10	-06	9.5	3/8	M22x1.5	14	71	31	22	63.0
1D2NX-16-08	12	-08	12.7	1/2	M24x1.5	16	74	31	24	42.0
1D2NX-20-10	16	-10	15.9	5/8	M30x2	20	88	37	30	42.0
1D2NX-25-12	20	-12	19.0	3/4	M36x2	25	90	39	36	42.0
1D2NX-30-16	25	-16	25.4	1	M42x2	30	92	41	46	42.0

192NX – BSP female swivel 60° cone

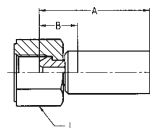

MATERIAL Galvanised steel with transparent Cr(VI)-free plating.
 Other materials available on request.

Part No. #	DN size				Connection type Thread size	A mm	B mm	J mm	Max. WP MPa
	mm	inch	mm	inch					
192NX-4-04	6	-04	6.4	1/4	G 1/4	56	25	19	63.0
192NX-6-05	8	-05	7.9	5/16	G 3/8	52	18	22	55.0
192NX-6-06	10	-06	9.5	3/8	G 3/8	59	19	22	55.0
192NX-8-06	10	-06	9.5	3/8	G 1/2	60	20	27	43.0
192NX-8-08	12	-08	12.7	1/2	G 1/2	63	20	27	43.0
192NX-12-10	16	-10	15.9	5/8	G 3/4	73	22	32	37.5
192NX-12-12	20	-12	19.0	3/4	G 3/4	77	26	32	37.5
192NX-16-12	20	-12	19.0	3/4	G 1	77	26	41	28.0
192NX-16-16	25	-16	25.4	1	G 1	88	27	41	28.0
192NX-20-16	25	-16	25.4	1	G 1 1/4	77	26	50	25.0

1U0NX – BSP female swivel (ballnose) BSP swivel nut

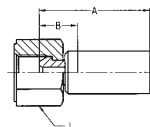

MATERIAL Galvanised steel with transparent Cr(VI)-free plating.
 For fittings as mentioned above, but with stainless steel nipple
 (AISI 303), please add **C2W** to the Part No. Example: 1U0NX-8-08 **C2W**.
 Other materials available on request.

Part No. #	DN size				Connection type Thread size	A mm	B mm	J mm	Max. WP MPa
	mm	inch	mm	inch					
1U0NX-4-04	6	-04	6.4	1/4	G 1/4	58	27	19	63.0
1U0NX-6-04	6	-04	6.4	1/4	G 3/8	58	27	27	55.0
1U0NX-6-05	8	-05	7.9	5/16	G 3/8	59	19	19	55.0
1U0NX-6-06	10	-06	9.5	3/8	G 3/8	61	20	22	55.0
1U0NX-8-06	10	-06	9.5	3/8	G 1/2	61	20	27	43.0
1U0NX-8-08	12	-08	12.7	1/2	G1/2	61	22	27	43.0
1U0NX-12-10	16	-10	15.9	5/8	G 3/4	75	23	32	37.5
1U0NX-12-12	20	-12	19.0	3/4	G 3/4	78	23	32	37.5
1U0NX-16-12	20	-12	19.0	3/4	G 1	78	23	41	28.0

Hose fittings

Hose Fittings
101NX – 103NX

2370N • 2245N • 2380F • 2246F



101NX – National Pipe Tapered (NPT) male

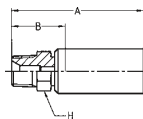

MATERIAL Galvanised steel with transparent Cr(VI)-free plating.
Other materials available on request.

Part No. #	DN	size		inch	Connection type	A mm	B mm	H mm	Max. WP MPa
		mm	inch		Thread size				
101NX-4-04	6	-04	6.4	1/4	1/4 - 18NPTF	65	33	14	34.5
101NX-6-05	8	-05	7.9	5/16	3/8 - 18NPTF	64	30	19	27.5
101NX-6-06	10	-06	9.5	3/8	3/8 - 18NPTF	71	31	19	27.5
101NX-8-06	10	-06	9.5	3/8	1/2 - 14NPTF	76	36	22	24.0
101NX-8-08	12	-08	12.7	1/2	1/2 - 14NPTF	79	37	22	24.0
101NX-12-10	16	-10	15.9	5/8	3/4 - 14NPTF	89	38	27	21.0
101NX-12-12	20	-12	19.0	3/4	3/4 - 14NPTF	91	40	27	21.0
101NX-16-12	20	-12	19.0	3/4	1 - 11 1/2NPTF	96	45	36	17.0
101NX-16-16	25	-16	25.4	1	1 - 11 1/2NPTF	96	45	36	17.0

Hose fittings

103NX – SAE (JIC) 37° male

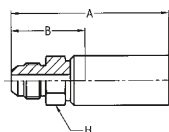

MATERIAL Galvanised steel with transparent Cr(VI)-free plating.
Other materials available on request.

Part No. #	DN	size		inch	Connection type	A mm	B mm	H mm	Max. WP MPa
		mm	inch		Thread size				
103NX-5-04	6	-04	6.4	1/4	1/2 - 20UNF	67	35	14	41.0
103NX-6-05	8	-05	7.9	5/16	9/16 - 18UNF	64	30	17	34.5
103NX-8-06	10	-06	9.5	3/8	3/4 - 16UNF	74	34	22	34.5
103NX-10-08	12	-08	12.7	1/2	7/8 - 14UNF	83	40	24	34.5
103NX-12-10	16	-10	15.9	5/8	1 1/16 - 12UNF	94	43	30	34.5
103NX-16-12	20	-12	19.0	3/4	1 5/16 - 12UNF	95	44	36	27.5
103NX-20-16	25	-16	25.4	1	1 5/8 - 12UNF	97	46	46	20.0
103NX-24-20	32	-20	31.8	1 1/4	1 7/8 - 12UNF	110	49	50	17.0

106NX – SAE (JIC) 37° female swivel UNF swivel nut

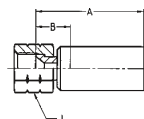

MATERIAL Galvanised steel with transparent Cr(VI)-free plating.
Other materials available on request.

Part No. #	DN size				Connection type Thread size	A mm	B mm	J mm	Max. WP MPa
	mm	inch	mm	inch					
106NX-4-04	6	-04	6.4	1/4	7/16 - 20UNF	58	25	19	41.0
106NX-5-04	6	-04	6.4	1/4	1/2 - 20UNF	55	23	19	41.0
106NX-6-05	8	-05	7.9	5/16	9/16 - 18UNF	50	16	19	34.5
106NX-6-06	10	-06	9.5	3/8	9/16 - 18UNF	59	18	22	34.5
106NX-8-06	10	-06	9.5	3/8	3/4 - 16UNF	59	19	24	34.5
106NX-8-08	12	-08	12.7	1/2	3/4 - 16UNF	64	21	27	34.5
106NX-10-08	12	-08	12.7	1/2	7/8 - 14UNF	62	19	27	34.5
106NX-10-10	16	-10	15.9	5/8	7/8 - 14UNF	73	22	27	34.5
106NX-12-10	16	-10	15.9	5/8	1 1/16 - 12UNF	73	22	32	34.5
106NX-12-12	20	-12	19.0	3/4	1 1/16 - 12UNF	79	28	36	34.5
106NX-16-12	20	-12	19.0	3/4	1 5/16 - 12UNF	75	24	41	27.5
106NX-16-16	25	-16	25.4	1	1 5/16 - 12UNF	77	26	41	27.5
106NX-20-16	25	-16	25.4	1	1 5/8 - 12UNF	75	24	50	20.0

107NX – NPSM female swivel

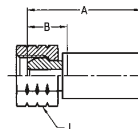

MATERIAL Galvanised steel with transparent Cr(VI)-free plating.
For fittings as mentioned above, but with stainless steel nipple (AISI 303), please add **C2W** to the Part No. Example: 107NX-4-04 **C2W**.
Other materials available on request.

Part No. #	DN size				Connection type Thread size	A mm	B mm	J mm	Max. WP MPa
	mm	inch	mm	inch					
107NX-4-04	6	-04	6.4	1/4	1/4 - 18NPSM	47	19	19	34.5
107NX-6-05	8	-05	7.9	5/16	3/8 - 18NPSM	48	20	22	27.5
107NX-6-06	10	-06	9.5	3/8	3/8 - 18NPSM	50	21	22	27.5
107NX-8-08	12	-08	12.7	1/2	1/2 - 14NPSM	50	19	27	24.0
107NX-12-10	16	-10	15.9	5/8	3/4 - 14NPSM	53	22	32	21.0
107NX-12-12	20	-12	19.0	3/4	3/4 - 14NPSM	59	24	32	21.0

Hose Fittings
1C3PX

2040N • 2040H • 2033T



1C3PX – Metric female swivel 24°/60°

Light series – Metric swivel nut

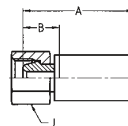

MATERIAL Galvanised steel with transparent Cr(VI)-free plating.
For fittings as mentioned above, but with stainless steel nipple (AISI 303), please add **C2W** to the Part No. Example: 1C3PX-6-03 **C2W**.
Other materials available on request.

Part No. #	DN size				Connection type		A mm	B mm	J mm	Max. WP MPa
	mm	inch	Thread size	Tube OD mm						
1C3PX-6-02	3	-02	3.2	1/8	M12x1.5	6	32	16	14	25.0
1C3PX-8-02	3	-02	3.2	1/8	M14x1.5	8	36	19	17	25.0
1C3PX-6-03	5	-03	4.8	3/16	M12x1.5	6	43	18	14	25.0
1C3PX-8-03	5	-03	4.8	3/16	M14x1.5	8	43	18	17	25.0
1C3PX-10-03	5	-03	4.8	3/16	M16x1.5	10	43	18	19	25.0
1C3PX-8-04	6	-04	6.4	1/4	M14x1.5	8	46	18	17	25.0
1C3PX-10-04	6	-04	6.4	1/4	M16x1.5	10	46	18	19	25.0
1C3PX-10-05	8	-05	7.9	5/16	M16x1.5	10	46	18	19	25.0
1C3PX-10-06	10	-06	9.5	3/8	M16x1.5	10	49	20	22	25.0
1C3PX-12-06	10	-06	9.5	3/8	M18x1.5	12	48	19	22	25.0
1C3PX-12-08	12	-08	12.7	1/2	M18x1.5	12	52	20	24	25.0
1C3PX-15-08	12	-08	12.7	1/2	M22x1.5	15	51	20	27	25.0

Hose fittings

2040N • 2040H • 2033T

 Hose Fittings
1CAPX

1CAPX – Metric female swivel 24° with O-ring

Light series – Metric swivel nut – ISO 12151-2

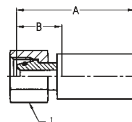

MATERIAL Galvanised steel with transparent Cr(VI)-free plating.
 Other materials available on request.

Part No. #	DN size				Connection type		A mm	B mm	J mm	Max. WP MPa
	mm	inch	mm	inch	Thread size	Tube OD mm				
1CAPX-6-03	5	-03	4.8	3/16	M12x1.5	6	45	20	14	31.5
1CAPX-8-03	5	-03	4.8	3/16	M14x1.5	8	50	25	17	42.5
1CAPX-6-04	6	-04	6.4	1/4	M12x1.5	6	48	20	17	31.5
1CAPX-8-04	6	-04	6.4	1/4	M14x1.5	8	51	23	17	42.5
1CAPX-10-04	6	-04	6.4	1/4	M16x1.5	10	50	22	19	40.0
1CAPX-10-05	8	-05	7.9	5/16	M16x1.5	10	50	22	19	40.0
1CAPX-12-05	8	-05	7.9	5/16	M18x1.5	12	50	22	22	35.0
1CAPX-10-06	10	-06	9.5	3/8	M16x1.5	10	51	22	22	40.0
1CAPX-12-06	10	-06	9.5	3/8	M18x1.5	12	52	23	22	35.0
1CAPX-15-08	12	-08	12.7	1/2	M22x1.5	15	59	28	27	31.5
1CAPX-18-08	12	-08	12.7	1/2	M26x1.5	18	57	26	32	31.5
1CAPX-18-10	16	-10	15.9	5/8	M26x1.5	18	56	25	32	31.5
1CAPX-22-12	20	-12	19.0	3/4	M30x2	22	62	27	36	28.0
1CAPX-28-16	25	-16	25.4	1	M36x2	28	64	29	41	21.0

Hose fittings

Hose Fittings
1C9PX

2040N • 2040H • 2033T



1C9PX – Metric female swivel 24° with O-ring

Heavy series – Metric swivel nut – ISO 12151-2

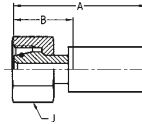

MATERIAL Galvanised steel with transparent Cr(VI)-free plating.
Other materials available on request.

Part No. #	DN size				Connection type		A mm	B mm	J mm	Max. WP MPa
	mm	inch	Thread size	Tube OD mm						
1C9PX-6-03	5	-03	4.8	3/16	M14x1.5	6	46	21	17	63.0
1C9PX-8-03	5	-03	4.8	3/16	M16x1.5	8	47	22	19	63.0
1C9PX-8-04	6	-04	6.4	1/4	M16x1.5	8	52	24	19	63.0
1C9PX-10-04	6	-04	6.4	1/4	M18x1.5	10	55	27	22	63.0
1C9PX-12-05	8	-05	7.9	5/16	M20x1.5	12	56	28	24	63.0
1C9PX-12-06	10	-06	9.5	3/8	M20x1.5	12	54	25	24	63.0
1C9PX-14-06	10	-06	9.5	3/8	M22x1.5	14	59	30	27	63.0
1C9PX-16-08	12	-08	12.7	1/2	M24x1.5	16	65	34	30	42.0
1C9PX-20-10	16	-10	15.9	5/8	M30x2	20	68	37	36	42.0
1C9PX-25-12	20	-12	19.0	3/4	M36x2	25	77	42	46	42.0
1C9PX-30-16	25	-16	25.4	1	M42x2	30	79	45	50	42.0

Hose fittings

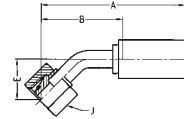
1CEPX – Metric female swivel 24° with O-ring
 45° elbow – Light series – Metric swivel nut – ISO 12151-2

MATERIAL Galvanised steel with transparent Cr(VI)-free plating.
 Other materials available on request.

Part No. #	DN size				Connection type		A mm	B mm	E mm	J mm	Max. WP MPa
	mm	inch	Thread size	Tube OD mm							
1CEPX-6-03	5	-03	4.8	3/16	M12x1.5	6	58	32	17	14	31.5
1CEPX-6-04	6	-04	6.4	1/4	M12x1.5	6	72	43	23	17	31.5
1CEPX-8-04	6	-04	6.4	1/4	M14x1.5	8	72	43	23	17	42.5
1CEPX-10-05	8	-05	7.9	5/16	M16x1.5	10	72	43	20	19	40.0
1CEPX-10-06	10	-06	9.5	3/8	M16x1.5	10	70	40	18	19	40.0
1CEPX-12-06	10	-06	9.5	3/8	M18x1.5	12	70	40	18	22	35.0
1CEPX-15-08	12	-08	12.7	1/2	M22x1.5	15	83	51	21	27	31.5
1CEPX-18-10	16	-10	15.9	5/8	M26x1.5	18	96	65	27	32	31.5
1CEPX-22-12	20	-12	19.0	3/4	M30x2	22	114	79	32	36	28.0
1CEPX-28-16	25	-16	25.4	1	M36x2	28	112	77	35	41	21.0

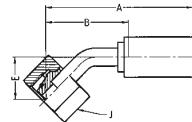
10CPX – Metric female swivel 24° with O-ring
 45° elbow – Heavy series – Metric swivel nut – ISO 12151-2

MATERIAL Galvanised steel with transparent Cr(VI)-free plating.
 Other materials available on request.

Part No. #	DN size				Connection type		A mm	B mm	E mm	J mm	Max. WP MPa
	mm	inch	Thread size	Tube OD mm							
10CPX-8-03	5	-03	4.8	3/16	M16x1.5	8	61	35	20	19	63.0
10CPX-10-04	6	-04	6.4	1/4	M18x1.5	10	74	45	24	22	63.0
10CPX-12-05	8	-05	7.9	5/16	M20x1.5	12	71	42	20	24	63.0
10CPX-14-06	10	-06	9.5	3/8	M22x1.5	14	70	40	19	27	63.0
10CPX-16-08	12	-08	12.7	1/2	M24x1.5	16	85	53	23	30	42.0
10CPX-20-10	16	-10	15.9	5/8	M30x2	20	99	68	29	36	42.0

Hose Fittings
1CFPX – 11CPX

2040N • 2040H • 2033T



1CFPX – Metric female swivel 24° with O-ring 90° elbow – Light series – Metric swivel nut – ISO 12151-2

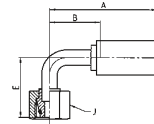

MATERIAL Galvanised steel with transparent Cr(VI)-free plating.
Other materials available on request.

Part No. #	DN size			Connection type		Tube OD mm	A mm	B mm	E mm	J mm	Max. WP MPa
	mm	inch	Thread size	Thread size							
1CFPX-6-03	5	-03	4.8	3/16	M12x1.5	6	48	22	26	14	31.5
1CFPX-6-04	6	-04	6.4	3/8	M12x1.5	6	59	30	33	17	31.5
1CFPX-8-04	6	-04	6.4	1/4	M14x1.5	8	59	30	33	17	42.5
1CFPX-10-05	8	-05	7.9	5/16	M16x1.5	10	59	30	33	19	40.0
1CFPX-10-06	10	-06	9.5	3/8	M16x1.5	10	60	30	35	19	40.0
1CFPX-12-06	10	-06	9.5	3/8	M18x1.5	12	60	30	35	22	35.0
1CFPX-15-08	12	-08	12.7	1/2	M22x1.5	15	74	42	42	27	31.5
1CFPX-18-10	16	-10	15.9	5/8	M26x1.5	18	84	53	52	32	31.5
1CFPX-22-12	20	-12	19.0	3/4	M30x2	22	100	65	62	36	28.0
1CFPX-28-16	25	-16	25.4	1	M36x2	28	100	65	72	41	21.0

Hose fittings

11CPX – Metric female swivel 24° with O-ring 90° elbow – Heavy series – Metric swivel nut – ISO 12151-2

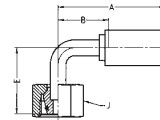

MATERIAL Galvanised steel with transparent Cr(VI)-free plating.
Other materials available on request.

Part No. #	DN size			Connection type		Tube OD mm	A mm	B mm	E mm	J mm	Max. WP MPa
	mm	inch	Thread size	Thread size							
11CPX-8-03	5	-03	4.8	3/16	M16x1.5	8	48	22	28	19	63.0
11CPX-6-04	6	-04	6.4	1/4	M14x1.5	6	59	30	29	17	63.0
11CPX-10-04	6	-04	6.4	1/4	M18x1.5	10	59	30	36	22	63.0
11CPX-12-05	8	-05	7.9	5/16	M20x1.5	12	59	30	36	24	63.0
11CPX-14-06	10	-06	9.5	3/8	M22x1.5	14	60	30	36	27	63.0
11CPX-16-08	12	-08	12.7	1/2	M24x1.5	16	74	42	44	30	42.0
11CPX-20-10	16	-10	15.9	5/8	M30x2	20	84	53	61	36	42.0

2040N • 2040H • 2033T

 Hose Fittings
1D0PX – 1D2PX

1D0PX – Metric male 24°

Light series – ISO 12151-2

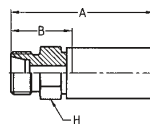
MATERIAL Galvanised steel with transparent Cr(VI)-free plating.
 Other materials available on request.

Part No. #	DN size				Connection type		A mm	B mm	H mm	Max. WP MPa
	mm	inch	Thread size	Tube OD mm						
1D0PX-6-03	5	-03	4.8	3/16	M12x1.5	6	48	23	12	25.0
1D0PX-6-04	6	-04	6.4	1/4	M12x1.5	6	51	23	14	25.0
1D0PX-8-04	6	-04	6.4	1/4	M14x1.5	8	51	23	14	42.5
1D0PX-10-05	8	-05	7.9	5/16	M16x1.5	10	54	26	17	40.0
1D0PX-12-05	8	-05	7.9	5/16	M18x1.5	12	54	26	19	35.0
1D0PX-12-06	10	-06	9.5	3/8	M18x1.5	12	56	27	19	40.0
1D0PX-15-06	10	-06	9.5	3/8	M22x1.5	15	57	28	22	31.0
1D0PX-15-08	12	-08	12.7	1/2	M22x1.5	15	59	28	22	31.0
1D0PX-18-10	16	-10	15.9	5/8	M26x1.5	18	59	28	27	28.0
1D0PX-22-12	20	-12	19.0	3/4	M30x2	22	67	32	30	28.0
1D0PX-28-16	25	-16	25.4	1	M36x2	28	67	32	36	21.0

1D2PX – Metric male 24°

Heavy series – ISO 12151-2

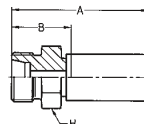
MATERIAL Galvanised steel with transparent Cr(VI)-free plating.
 Other materials available on request.

Part No. #	DN size				Connection type		A mm	B mm	H mm	Max. WP MPa
	mm	inch	Thread size	Tube OD mm						
1D2PX-8-03	5	-03	4.8	3/16	M16x1.5	8	50	25	17	63.0
1D2PX-10-04	6	-04	6.4	1/4	M18x1.5	10	55	27	19	63.0
1D2PX-12-05	8	-05	7.9	5/16	M20x1.5	12	55	27	22	63.0
1D2PX-14-06	10	-06	9.5	3/8	M22x1.5	14	59	30	22	63.0
1D2PX-16-08	12	-08	12.7	1/2	M24x1.5	16	61	30	24	42.0
1D2PX-20-10	16	-10	15.9	5/8	M30x2	20	65	34	30	42.0
1D2PX-25-12	20	-12	19.0	3/4	M36x2	25	71	36	36	42.0
1D2PX-30-16	25	-16	25.4	1	M42x2	30	73	38	46	42.0

Hose fittings

Hose Fittings
11DPX

2040N • 2040H • 2033T



11DPX – Metric standpipe Light series

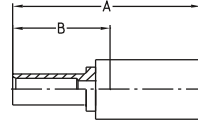

MATERIAL Galvanised steel with transparent Cr(VI)-free plating.
Other materials available on request.

Part No. #	DN	size	mm	inch	Tube OD mm	A mm	B mm	Max. WP MPa
11DPX-6-03	5	-03	4.8	3/16	6	55	27	25.0
11DPX-8-04	6	-04	6.4	1/4	8	58	30	25.0
11DPX-10-05	8	-05	7.9	5/16	10	59	31	25.0
11DPX-10-06	10	-06	9.5	3/8	10	79	32	25.0
11DPX-12-06	10	-06	9.5	3/8	12	79	32	25.0
11DPX-15-08	12	-08	12.7	1/2	15	65	34	25.0
11DPX-18-10	16	-10	15.9	5/8	18	66	35	16.0
11DPX-22-12	20	-12	19.0	3/4	22	72	37	16.0
11DPX-28-16	25	-16	25.4	1	28	74	39	10.0

NOTE: Not recommended for new constructions. Please refer to end connections C3 or CA.

Hose fittings

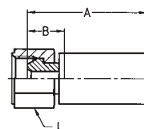
192PX – BSP female swivel 60° cone

MATERIAL Galvanised steel with transparent Cr(VI)-free plating.
 Other materials available on request.

Part No. #	DN size				Connection type Thread size	A mm	B mm	J mm	Max. WP MPa
	mm	inch	mm	inch					
192PX-2-02	3	-02	3.2	1/8	G 1/8	26	11	12	55.0
192PX-4-02	3	-02	3.2	1/8	G 1/4	34	17	17	63.0
192PX-2-03	5	-03	4.8	3/16	G 1/8	41	16	17	55.0
192PX-4-03	5	-03	4.8	3/16	G 1/4	42	16	17	63.0
192PX-4-04	6	-04	6.4	1/4	G 1/4	45	17	17	63.0
192PX-6-05	8	-05	7.9	5/16	G 3/8	45	17	19	55.0
192PX-6-06	10	-06	9.5	3/8	G 3/8	48	19	22	55.0
192PX-8-06	10	-06	9.5	3/8	G 1/2	48	19	27	43.0
192PX-8-08	12	-08	12.7	1/2	G1/2	53	21	27	43.0
192PX-12-10	16	-10	15.9	5/8	G 3/4	50	19	32	35.0
192PX-12-12	20	-12	19.0	3/4	G 3/4	56	21	32	35.0
192PX-16-12	20	-12	19.0	3/4	G 1	56	22	41	28.0
192PX-16-16	25	-16	25.4	1	G 1	57	22	41	28.0
192PX-20-16	25	-16	25.4	1	G 1 1/4	58	24	50	21.0

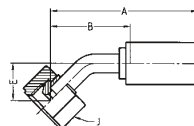
**1B1PX – BSP female swivel 60° cone
 45° elbow**

MATERIAL Galvanised steel with transparent Cr(VI)-free plating.
 Other materials available on request.

Part No. #	DN size				Connection type Thread size	A mm	B mm	E mm	J mm	Max. WP MPa
	mm	inch	mm	inch						
1B1PX-4-03	5	-03	4.8	3/16	G 1/4	58	32	17	17	63.0
1B1PX-4-04	6	-04	6.4	1/4	G 1/4	70	41	21	17	63.0
1B1PX-6-05	8	-05	7.9	5/16	G 3/8	68	39	17	22	55.0
1B1PX-6-06	10	-06	9.5	3/8	G 3/8	66	36	14	22	55.0
1B1PX-8-06	10	-06	9.5	3/8	G 1/2	67	37	15	27	43.0
1B1PX-8-08	12	-08	12.7	1/2	G 1/2	86	54	18	27	43.0
1B1PX-12-10	16	-10	15.9	5/8	G 3/4	99	68	26	32	35.0
1B1PX-12-12	20	-12	19.0	3/4	G 3/4	117	82	30	32	35.0
1B1PX-16-16	25	-16	25.4	1	G 1	120	85	43	41	28.0
1B1PX-20-16	25	-16	25.4	1	G 1 1/4	116	81	34	50	21.0

Hose Fittings
1B2PX – 1B4PX

2040N • 2040H • 2033T



1B2PX – BSP female swivel 60° cone 90° elbow

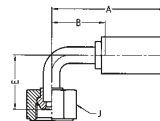

MATERIAL Galvanised steel with transparent Cr(VI)-free plating.
Other materials available on request.

Part No. #	DN size mm inch				Connection type	A	B	E	J	Max. WP
					Thread size	mm	mm	mm	mm	MPa
1B2PX-4-03	5	-03	4.8	3/16	G 1/4	48	22	24	17	63.0
1B2PX-4-04	6	-04	6.4	1/4	G 1/4	59	30	30	17	63.0
1B2PX-6-05	8	-05	7.9	5/16	G 3/8	59	30	28	22	55.0
1B2PX-6-06	10	-06	9.5	3/8	G 3/8	60	30	30	22	55.0
1B2PX-8-06	10	-06	9.5	3/8	G 1/2	60	30	31	27	43.0
1B2PX-8-08	12	-08	12.7	1/2	G 1/2	74	42	38	27	43.0
1B2PX-12-10	16	-10	15.9	5/8	G 3/4	84	53	50	32	35.0
1B2PX-12-12	20	-12	19.0	3/4	G 3/4	100	65	60	32	35.0
1B2PX-20-16	25	-16	25.4	1	G 1 1/4	100	65	70	50	21.0

Hose fittings

1B4PX – BSP female swivel 60° cone 90° compact elbow

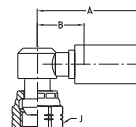

MATERIAL Galvanised steel with transparent Cr(VI)-free plating.
Other materials available on request.

Part No. #	DN size mm inch				Connection type	A	B	J	Max. WP
					Thread size	mm	mm	mm	MPa
1B4PX-4-04	6	-04	6.4	1/4	G 1/4	45	17	17	63.0

2040N • 2040H • 2033T



 Hose Fittings
1U0PX

1U0PX – BSP female swivel (ballnose)

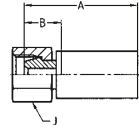
BSP swivel nut



MATERIAL Galvanised steel with transparent Cr(VI)-free plating.
 For fittings as mentioned above, but with stainless steel nipple (AISI 303), please add **C2W** to the Part No. Example: 1U0PX-4-04 **C2W**.
 Other materials available on request.

Part No. #	DN size				Connection type Thread size 	A mm	B mm	J mm	Max. WP MPa
	mm	inch							
1U0PX-4-02	3	-02	3.2	1/8	G 1/4	35	19	17	63.0
1U0PX-4-03	5	-03	4.8	3/16	G 1/4	42	16	17	63.0
1U0PX-4-04	6	-04	6.4	1/4	G 1/4	45	17	17	63.0
1U0PX-6-03	5	-03	4.8	3/16	G 3/8	43	18	19	55.0
1U0PX-6-04	6	-04	6.4	1/4	G 3/8	47	18	19	55.0
1U0PX-6-05	8	-05	7.9	5/16	G 3/8	45	17	19	55.0
1U0PX-6-06	10	-06	9.5	3/8	G 3/8	48	19	22	55.0
1U0PX-8-06	10	-06	9.5	3/8	G 1/2	48	19	27	43.0
1U0PX-8-08	12	-08	12.7	1/2	G 1/2	53	21	27	43.0
1U0PX-12-10	16	-10	15.9	5/8	G 3/4	50	19	32	35.0
1U0PX-12-12	20	-12	19.0	3/4	G 3/4	56	21	32	35.0
1U0PX-16-12	20	-12	19.0	3/4	G 1	56	22	41	25.0
1U0PX-16-16	25	-16	25.4	1	G 1	57	22	41	25.0
1U0PX-20-16	25	-16	25.4	1	G 1 1/4	58	24	50	21.0

Hose Fittings
1D9PX

2040N • 2040H • 2033T



1D9PX – BSP male DIN 3852 Form A

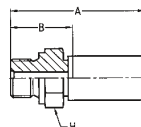

MATERIAL Galvanised steel with transparent Cr(VI)-free plating.
Other materials available on request.

Part No. #	DN size			Connection type Thread size	A mm	B mm	J mm	Max. WP MPa
	mm	inch	inch					
1D9PX-2-02	3	-02	3.2	1/8	38	21	14	55.0
1D9PX-2-03	5	-03	4.8	3/16	48	22	14	55.0
1D9PX-4-03	5	-03	4.8	3/16	54	29	19	63.0
1D9PX-4-04	6	-04	6.4	1/4	57	29	19	63.0
1D9PX-6-05	8	-05	7.9	5/16	58	29	22	55.0
1D9PX-6-06	10	-06	9.5	3/8	60	30	22	55.0
1D9PX-8-06	10	-06	9.5	3/8	62	33	27	43.0
1D9PX-8-08	12	-08	12.7	1/2	64	33	27	43.0
1D9PX-12-10	16	-10	15.9	5/8	66	35	32	35.0
1D9PX-12-12	20	-12	19.0	3/4	72	37	32	35.0
1D9PX-16-12	20	-12	19.0	3/4	74	39	41	28.0
1D9PX-20-16	25	-16	25.4	1	76	41	50	21.0

Hose fittings

2040N • 2040H • 2033T

 Hose Fittings
191PX – 101PX

191PX – BSPT male taper pipe

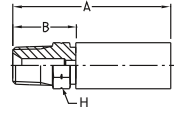

MATERIAL BF: Brass
 C: Stainless steel (AISI 316 Ti)

Part No. #	DN size				Connection type		A mm	B mm	H mm	Max. WP MPa
	mm	inch	Thread size	Tube OD mm						
191PX-4-04BF	6	-04	6.4	1/4	R1/4	4	55	27	14	27
191PX-4-04C	6	-04	6.4	1/4	R1/4	4	55	27	14	43.0

NOTE: Only for CO₂ applications.

101PX – National Pipe Tapered (NPT) male

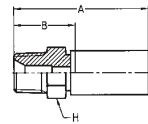

MATERIAL Galvanised steel with transparent Cr(VI)-free plating.
 Other materials available on request.

Part No. #	DN size				Connection type Thread size	A mm	B mm	H mm	Max. WP MPa
	mm	inch	Thread size	Tube OD mm					
101PX-2-03	5	-03	4.8	3/16	1/8 - 27NPTF	48	23	12	34.5
101PX-4-03	5	-03	4.8	3/16	1/4 - 18NPTF	52	27	14	34.5
101PX-4-04	6	-04	6.4	1/4	1/4 - 18NPTF	55	27	14	34.5
101PX-6-04	6	-04	6.4	1/4	3/8 - 18NPTF	57	29	19	27.5
101PX-6-05	8	-05	7.9	5/16	3/8 - 18NPTF	57	29	19	27.5
101PX-4-06	10	-06	9.5	3/8	1/4 - 18NPTF	57	28	14	34.5
101PX-6-06	10	-06	9.5	3/8	3/8 - 18NPTF	59	30	19	27.5
101PX-8-06	10	-06	9.5	3/8	1/2 - 14NPTF	64	35	22	24.0
101PX-6-08	12	-08	12.7	1/2	3/8 - 18NPTF	61	30	19	27.5
101PX-8-08	12	-08	12.7	1/2	1/2 - 14NPTF	66	35	22	24.0
101PX-12-10	16	-10	15.9	5/8	3/4 - 14NPTF	66	35	27	21.0
101PX-12-12	20	-12	19.0	3/4	3/4 - 14NPTF	70	35	27	21.0
101PX-16-16	25	-16	25.4	1	1 - 11 1/2NPTF	77	42	36	17.0

Hose Fittings
103PX – 106PX

2040N • 2040H • 2033T



103PX – SAE (JIC) 37° male

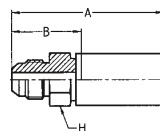

MATERIAL Galvanised steel with transparent Cr(VI)-free plating.
Other materials available on request.

Part No. #	DN size				Connection type Thread size	A mm	B mm	H mm	Max. WP MPa
	mm	inch	mm	inch					
103PX-4-03	5	-03	4.8	3/16	7/16 - 20UNF	52	27	14	41.0
103PX-5-04	6	-04	6.4	1/4	1/2 - 20UNF	57	29	14	41.0
103PX-6-04	6	-04	6.4	1/4	9/16 - 18UNF	57	29	17	34.5
103PX-6-05	8	-05	7.9	5/16	9/16 - 18UNF	57	29	17	34.5
103PX-8-06	10	-06	9.5	3/8	3/4 - 16UNF	62	33	22	34.5
103PX-10-08	12	-08	12.7	1/2	7/8 - 14UNF	70	38	24	34.5
103PX-12-10	16	-10	15.9	5/8	1 1/16 - 12UNF	71	40	30	34.5
103PX-16-12	20	-12	19.0	3/4	1 5/16 - 12UNF	76	41	36	27.5
103PX-20-16	25	-16	25.4	1	1 5/8 - 12UNF	78	43	46	20.0

Hose fittings

106PX – SAE (JIC) 37° female swivel UNF swivel nut

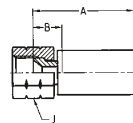

MATERIAL Galvanised steel with transparent Cr(VI)-free plating.
Other materials available on request.

Part No. #	DN size				Connection type Thread size	A mm	B mm	J mm	Max. WP MPa
	mm	inch	mm	inch					
106PX-4-02	3	-02	3.2	1/8	7/16 - 20UNF	29	13	17	41.0
106PX-4-03	5	-03	4.8	3/16	7/16 - 20UNF	40	15	17	41.0
106PX-4-04	6	-04	6.4	1/4	7/16 - 20UNF	43	15	17	41.0
106PX-5-04	6	-04	6.4	1/4	1/2 - 20UNF	43	15	19	41.0
106PX-6-04	6	-04	6.4	1/4	9/16 - 18UNF	45	17	19	34.5
106PX-6-05	8	-05	7.9	5/16	9/16 - 18UNF	45	17	19	34.5
106PX-6-06	10	-06	9.5	3/8	9/16 - 18UNF	47	18	19	34.5
106PX-8-06	10	-06	9.5	3/8	3/4 - 16UNF	48	19	24	34.5
106PX-10-08	12	-08	12.7	1/2	7/8 - 14UNF	49	18	27	34.5
106PX-12-10	16	-10	15.9	5/8	1 1/16 - 12UNF	50	19	32	34.5
106PX-16-12	20	-12	19.0	3/4	1 5/16 - 12UNF	56	22	41	27.5
106PX-20-16	25	-16	25.4	1	1 5/8 - 12UNF	56	22	50	20.0



107PX – NPSM female swivel

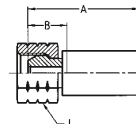

MATERIAL Galvanised steel with transparent Cr(VI)-free plating.
 For fittings as mentioned above, but with stainless steel nipple (AISI 303), please add **C2W** to the Part No. Example: 107PX-4-04 **C2W**.
 Other materials available on request.

Part No. #	DN size mm inch				Connection type	A mm	B mm	J mm	Max. WP MPa
					Thread size 				
107PX-4-02	3	-02	3.2	1/8	1/4 - 18NPSM	36	20	17	34.5
107PX-4-03	5	-03	4.8	3/16	1/4 - 18NPSM	44	19	17	34.5
107PX-2-03	5	-03	4.8	3/16	1/8 - 27NPSM	47	21	17	34.5
107PX-4-04	6	-04	6.4	1/4	1/4 - 18NPSM	47	19	19	34.5
107PX-6-05	8	-05	7.9	5/16	3/8 - 18NPSM	48	20	22	27.5
107PX-6-06	10	-06	9.5	3/8	3/8 - 18NPSM	50	21	22	27.5
107PX-8-08	12	-08	12.7	1/2	1/2 - 14NPSM	50	19	27	24.0
107PX-12-10	16	-10	15.9	5/8	3/4 - 14NPSM	53	22	32	21.0
107PX-12-12	20	-12	19.0	3/4	3/4 - 14NPSM	59	24	32	21.0

137PX – SAE (JIC) 37° female swivel 45° elbow – UNF swivel nut

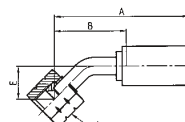

MATERIAL Galvanised steel with transparent Cr(VI)-free plating.
 Other materials available on request.

Part No. #	DN size mm inch				Connection type	A mm	B mm	E mm	J mm	Max. WP MPa
					Thread size 					
137PX-4-03	5	-03	4.8	3/16	7/16 - 20UNF	57	31	16	17	41.0
137PX-5-04	6	-04	6.4	1/4	1/2 - 20UNF	70	41	21	19	41.0
137PX-6-05	8	-05	7.9	5/16	9/16 - 18UNF	67	38	16	19	34.5
137PX-8-06	10	-06	9.5	3/8	3/4 - 16UNF	67	37	15	24	34.5
137PX-10-08	12	-08	12.7	1/2	7/8 - 14UNF	81	49	19	27	34.5
137PX-12-10	16	-10	15.9	5/8	1 1/16 - 12UNF	96	65	27	32	34.5
137PX-16-12	20	-12	19.0	3/4	1 5/16 - 12UNF	114	79	32	41	27.5
137PX-20-16	25	-16	25.4	1	1 5/8 - 12UNF	113	78	36	50	20.0

Hose fittings

Hose Fittings
139PX – 1JCPX

2040N • 2040H • 2033T



139PX – SAE (JIC) 37° female swivel 90° elbow – UNF swivel nut

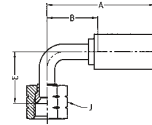

MATERIAL Galvanised steel with transparent Cr(VI)-free plating.
Other materials available on request.

Part No. #	DN size			Connection type Thread size	A mm	B mm	E mm	J mm	Max. WP MPa
	mm	inch	inch						
139PX-4-03	5	-03	4.8	3/16	48	22	24	17	41.0
139PX-5-04	6	-04	6.4	1/4	59	30	31	19	41.0
139PX-6-05	8	-05	7.9	5/16	59	30	28	19	34.5
139PX-8-06	10	-06	9.5	3/8	60	30	31	24	34.5
139PX-10-08	12	-08	12.7	1/2	74	42	39	27	34.5
139PX-12-10	16	-10	15.9	5/8	84	53	52	32	34.5
139PX-16-12	20	-12	19.0	3/4	100	65	62	41	27.5
139PX-20-16	25	-16	25.4	1	100	65	73	50	20.0

Hose fittings

1JCPX – O-Lok® ORFS swivel nut Short version – UNF swivel nut – ISO 12151-1

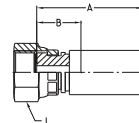

MATERIAL Galvanised steel with transparent Cr(VI)-free plating.
Other materials available on request.

Part No. #	DN size			Connection type Thread size	Tube OD inch	A mm	B mm	J mm	Max. WP MPa	
	mm	inch	inch							
1JCPX-4-03	5	-03	4.8	3/16	9/16 - 18 UNF	1/4	41	16	17	41.0
1JCPX-4-04	6	-04	6.4	1/4	9/16 - 18 UNF	1/4	44	16	17	41.0
1JCPX-6-06	10	-06	9.5	3/8	11/16 - 16 UNF	3/8	47	18	22	41.0
1JCPX-8-06	10	-06	9.5	3/8	13/16 - 16 UNF	1/2	49	19	24	41.0
1JCPX-8-08	12	-08	12.7	1/2	13/16 - 16 UNF	1/2	51	19	24	41.0
1JCPX-12-12	20	-12	19.0	3/4	1 3/16 - 12 UNF	3/4	59	24	36	41.0

2040N • 2040H • 2033T

 Hose Fittings
1JSPX – 1J7PX

1JSPX – O-Lok® ORFS swivel nut

Long version – UNF swivel nut – ISO 12151-1

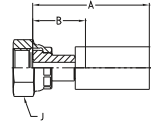

MATERIAL Galvanised steel with transparent Cr(VI)-free plating.
 Other materials available on request.

Part No. #	DN size				Connection type		A mm	B mm	J mm	Max. WP MPa
	mm	inch	Thread size	Tube OD inch						
1JSPX-8-06	10	-06	9.5	3/8	13/16 - 16 UNF	1/2	52	22	24	41.0

1J7PX – O-Lok® ORFS swivel nut

45° elbow – UNF swivel nut – ISO 12151-1

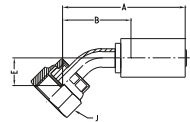

MATERIAL Galvanised steel with transparent Cr(VI)-free plating.
 Other materials available on request.

Part No. #	DN size				Connection type		A mm	B mm	E mm	J mm	Max. WP MPa
	mm	inch	Thread size	Tube OD inch							
1J7PX-4-04	6	-04	6.4	1/4	9/16 - 18 UNF	1/4	64	35	15	17	41.0
1J7PX-6-06	10	-06	9.5	3/8	11/16 - 16 UNF	3/8	67	37	17	22	41.0
1J7PX-8-08	12	-08	12.7	1/2	13/16 - 16 UNF	1/2	74	42	17	24	41.0

Hose fittings

Hose Fittings
1J9PX – 1GAPX

2040N • 2040H • 2033T



1J9PX – O-Lok® ORFS swivel nut

90° elbow – UNF swivel nut – ISO 12151-1

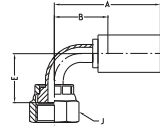

MATERIAL Galvanised steel with transparent Cr(VI)-free plating.
Other materials available on request.

Part No. #	DN size				Connection type		A mm	B mm	E mm	J mm	Max. WP MPa
	mm	inch	Thread size	Tube OD inch							
1J9PX-4-03	5	-03	4.8	3/16	9/16 - 18 UNF	1/4	48	22	23	17	41.0
1J9PX-4-04	6	-04	6.4	1/4	9/16 - 18 UNF	1/4	59	30	29	17	41.0
1J9PX-6-04	6	-04	6.4	1/4	11/16 - 16 UNF	3/8	59	30	29	22	41.0
1J9PX-6-06	10	-06	9.5	3/8	11/16 - 16 UNF	3/8	60	30	27	22	41.0
1J9PX-8-06	10	-06	9.5	3/8	13/16 - 16 UNF	1/2	60	30	27	24	41.0
1J9PX-8-08	12	-08	12.7	1/2	13/16 - 16 UNF	1/2	74	42	32	24	41.0

Hose fittings

1GAPX – Female gas joint

according to NEN 176

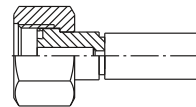

MATERIAL BF: Brass
C: Stainless steel (AISI 316 Ti)

Part No. #	DN size				Connection type		A mm	B mm	J mm	Max. WP MPa
	mm	inch	Thread size	Tube OD mm						
1GAPX-8-04BF	6	-04	6.4	1/4	W21.8 x 1/14	8	57	28	30	27
1GAPX-8-04C	6	-04	6.4	1/4	W21.8 x 1/14	8	57	28	30	27
1GAPX-12-04BF	6	-04	6.4	1/4	W24.32 x 1/14	12	57	28	32	27
1GAPX-12-04C	6	-04	6.4	1/4	W24.32 x 1/14	12	57	28	32	27

NOTE: Only for CO₂ applications.

 Hose Fittings
1GAPX

1GAPX – Female gas joint

according to ISO/NFE 29650

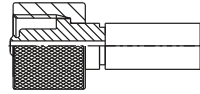

MATERIAL BF2: Brass
 CS: Stainless steel (AISI 316 Ti)

Part No. #	DN size				Connection type						
	mm	inch	Thread size		Tube OD mm	A mm	B mm	J mm	Max. WP MPa		
1GAPX-8-04BF2	6	-04	6.4	1/4	21.7 x 1.814	8	66	38	30	27	
1GAPX-8-04CS	6	-04	6.4	1/4	21.7 x 1.814	8	66	38	30	43	

NOTE: Only for CO₂ applications.

Chapter F**Accessories**

Introduction	F-2
Spiral Guard™	F-4
Fire protection sleeves	F-5
Banjo bolt	F-6
Copper ring	F-7
Tape.....	F-8

Introduction

Parker does offer a broad range of accessories for its unique hose products program. A major focus is to protect the hose assemblies where ever necessary. The bundling of multiple hoses is an additional benefit. For this puposes Parker offers a variety of options such as SpiralGuard™, steel spring guards and fire protection sleeves.



Application



- Hose protection in regards to abrasion, damage or fire
- Hose bundling

Applications:

- Construction machinery
- Material handling equipment
- Mining

Features

- Abrasion and damage resistance
- Crush resistance
- Flexibility and strength
- Exceptionally smooth facing and rounded edges

**Benefits**

- Hose protection from abrasion and damage in rough application surroundings
- Fire protection
- Prevention from getting caught on rough surfaces



Accessories

Spiral Guard™

Spiral Guard™

Features:

- High-strength, resilient Spiral Guard protects hose and cable with superior anti-crush performance.
- Exceptionally smooth facing and rounded edges prevent Spiral Guard from getting caught on rough surfaces, as sleeves often can
- No cutting of hose cover or injuries of staff
- Made of High Density Polyethylene
- O.D. sizes from 12 to over 150 mm
- Can be used to wrap multiple hose bundles
- Temperature range -100 °C up to +100 °C

Variations:

- PSG: Standard, e.g. PSG-20
- PSG-FRAS: MSHA approved, Flame Retardant Anti Static, e.g. PSG-FRAS-20
- “Glow in the dark” version: on request



Accessories



Part No.	Hose OD range (mm)	Carton quantity (m)	1-wire braid size	2-wire braid size	Multispiral size
PSG-12	10 - 13	20	—	—	—
PSG-16 or PSG-FRAS-16	12 - 17	20	1/4"	1/4"	—
PSG-20 or PSG-FRAS-20	16 - 22	20	3/8"	1/4", 3/8"	3/8"
PSG-25 or PSG-FRAS-25	22 - 28	20	1/2", 5/8"	1/2", 5/8"	1/2", 5/8"
PSG-32 or PSG-FRAS-32	27 - 33	20	3/4"	5/8" 3/4"	3/4"
PSG-40 or PSG-FRAS-40	33 - 42	20	1"	1"	1"
PSG-50 or PSG-FRAS-50	42 - 55	20	1-1/4", 1-1/2"	1-1/4"	1-1/4"
PSG-63 or PSG-FRAS-63	52 - 65	20	2"	1-1/2"	1-1/2"
PSG-75 or PSG-FRAS-75	65 - 80	10	—	2"	2"
PSG-90 or PSG-FRAS-90	80 - 150	10	—	—	—
PSG-110 or PSG-FRAS-110	150 - above	10	—	—	—

Fire protection sleeves

The firesleeve is constructed of a uniform single braid of glass fibre with a special fire-proof outside coating.

Used to protect hoses from heat, flying sparks, glowing metal scales etc.

Hose clamps for mounting required.

Part No. #	ID min mm 	OD max mm 
FS-F-10	14.7	24.6
FS-F-11	16.5	26.1
FS-F-12	18.0	27.6
FS-F-14	21.3	30.9
FS-F-16	24.4	35.0
FS-F-18	27.4	38.1
FS-F-20	30.7	40.3
FS-F-22	34.0	44.4
FS-F-24	37.1	48.2
FS-F-28	43.4	52.3
FS-F-32	49.8	58.9
FS-F-38	59.4	69.5
FS-F-40	62.5	70.8
FS-F-48	75.2	86.3
FS-F-60	94.2	105.4



Accessories

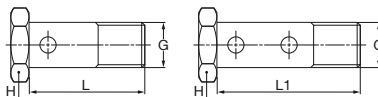

Banjo bolt

Banjo bolt



AM / AR – Banjo bolt – metric/imperial DIN 7643

Material: steel, galvanised, chromium(VI) free plated

Part No. single #	Part No. double #	ID banjo mm	G thread size metric/imperial 	L single mm	L1 double mm	H mm 
AM-03	A2M3	8	M8x1	17	26	12
AM-04	A2M4	10	M10x1	19	30	14
AR-04		10	1/8	19		14
AM-06	A2M6	12	M12x1.5	26	38	17
AM-08	A2M8	14	M14x1.5	26	41	19
AR-08		14	1/4	26		19
AR-08C		14	1/4	26		19
AM-10	A2M10	16	M16x1.5	28	46	22
AR-10		17	3/8	29		22
AM-13		18	M18x1.5	32		24
AM-16		22	M22x1.5	40		27
AR-16		22	1/2	40		27
AM-20		26	M26x1.5	45		32

Copper ring for banjo bolt (Form A DIN 7603)

Part No. single #	ID banjo mm	G thread size metric/imperial 
853009-8	8	M8x1
853009-10	10	M10x1
853009-10	10	1/8
853009-12	12	M12x1.5
853009-14	14	M14x1.5
853009-14	14	1/4
853009-16	16	M16x1.5
853009-17	17	3/8
853009-18	18	M18x1.5
853009-22	22	M22x1.5
853009-21	22	1/2
853009-26	26	M26x1.5

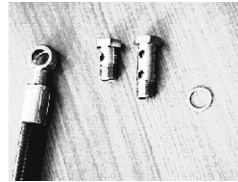
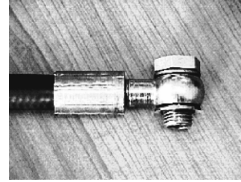

Accessories

Tape

Tape

For fixing the pressure reinforcement

Part No. #	Type	Description
8.204	Tape	for regular thermoplastic hoses with wire reinforcement at normal temperatures
8.207	Glass silk tape	for PTFE hoses where high temperatures are applied
Tape-FV	Tape	fibre reinforced tape

Chapter G

Technical Information

Introduction	G-2
Crimpsource Online	G-4
Measure and cut hose to length	G-7
Assembly instruction – KarryKrimp® 1 / KarryKrimp® 2	G-8
Assembly procedures – Push-Lok® self-grip hose.....	G-9
Twinline and multiline hose separation instructions.....	G-10
Determining the hose length for over-the-sheaf applications.....	G-11
Selection, installation, and maintenance.....	G-12
Installation standards	G-14
Installation tips	G-16
Unit Conversion Table	G-17
Parker safety guide	G-18

Introduction

This section shows all relevant technical information, crimping and assembly instructions as well as hose and fitting selection instructions.

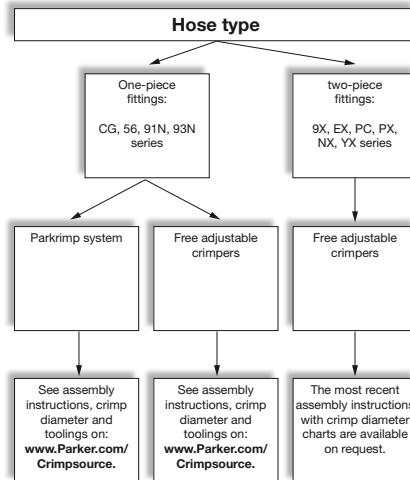

Application



- Assembly systems overview
- Assembly procedures
- Multiline separation instructions
- Hose length determination
- Installation standards and tips

Features

- Quick selection of optimal assembly system and fittings
- Illustrated, easy-to-understand handling instructions
- Application related practical tips

**Benefits**

- Guidance how to handle products efficiently and safe
- Secure assembly process
- Extend hose lifetime with proper preparation and handling



Technical Information
Your crimp source online keeps you always up-to-date

Your crimp source online keeps you always up-to-date

Crimpsource Online



Crimpsource online is your tool for a fast, easy and exact assembly of hose products in Europe.

Find the correct crimp specification on the push of a button.

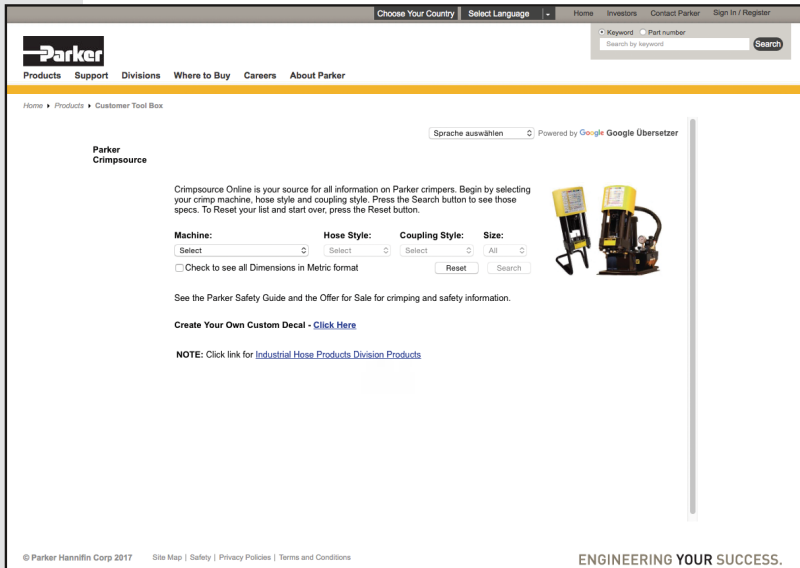

The screenshot shows the Parker Crimpsource Online website. At the top, there are navigation links for 'Choose Your Country', 'Select Language', 'Home', 'Investors', 'Contact Parker', and 'Sign In / Register'. A search bar is located in the top right corner with options for 'Keyword' and 'Part number'. The main navigation menu includes 'Products', 'Support', 'Divisions', 'Where to Buy', 'Careers', and 'About Parker'. The page content features the Parker logo and 'Crimpsource' heading. Below this, there is a Google Translate widget. The main text explains that Crimpsource Online is a tool for finding crimp specifications based on machine, hose style, coupling style, and size. It includes a search form with dropdown menus for 'Machine', 'Hose Style', 'Coupling Style', and 'Size', along with a 'Reset' button and a 'Search' button. There is also a 'Check to see all Dimensions in Metric format' checkbox. A small image of a crimping machine is shown on the right. At the bottom of the page, there is a copyright notice for Parker Hannifin Corp 2017 and the slogan 'ENGINEERING YOUR SUCCESS.'

Technical information



Hose Assembly and Crimping

How To Use Crimpsource

Data

1



The most up-to-date information for crimping is located at www.parker.com/crimpsource. Not only is it accurate, but it is easy.

NOTE: If the hose does not come up, then you cannot crimp that hose on the machine you selected. If the fitting you choose doesn't come up, then that series is not available for that hose. Same with size.

Make your Selections

2

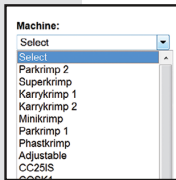

Choose the correct machine.

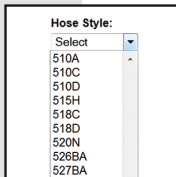

Choose the hose you are crimping.

NOTE: If the hose does not come up, then the crimper chosen does not work with the selected hose.

Make your Selections

3

Coupling Style:

Select

- 55
- 56
- 56H
- 57
- 58
- 81
- 91
- 91N
- 92
- 93N

Choose the fitting style.

Size:

All

- 3
- 4
- 5
- 6
- 8
- 12

All

Choose the fittings size. Once you have selected values from each field, hit the search button.
NOTE: If the chosen fitting/size doesn't come up, the series/size is not available for that hose.

Review the Results

4

[Home](#) [Print](#)

Hose Style: **540N** Coupling Style: **56** Crimper: **Minikrimp** Hose Description: **Meets or exceeds SAE 100R7**

Size	Die	Die Ring	Crimp Diameter	Crimp Length	Hose Insertion	Drawing
Parker Parflex Crimp Dies						
-8	80C-P08	 82C-R01	0.850	FULL	1-1/8	PKFull

Comments

- PFD: Crimp diameter is measured four places, 45 degrees apart, at the top, then middle and bottom of the crimp.
- PFD: Crimp diameter tolerance on all Parkrimp Crimpers is $\pm 0.010"$ ($\pm 0.25\text{mm}$) unless otherwise specified. Crimp length tolerance is $\pm 0.030"$ ($\pm 0.76\text{mm}$).
- PFD: Align measurement caliper or micrometer on the center of crimp impressions avoiding the crimp ribs.
- PFD: Crimp diameter tolerance on all Adjustable Crimpers is $\pm 0.005"$ ($\pm 0.13\text{mm}$). Crimp length tolerance is $\pm 0.030"$ ($\pm 0.76\text{mm}$).
- PFD: Reference Parker Fluid Connector Group (FCG) Safety Bulletin 4400 -B.1 (www.parker.com/safety)
- PFD: Pertains to steel & stainless steel fittings. Refer to Parflex Catalog 4660 for hose assembly instructions. (www.parker.com/parflex).
- PFD: Crimp acceptance is based on the center measurement average with a maximum taper of $0.010"$ (0.25 mm) between the top and bottom crimp averages.

PKFull

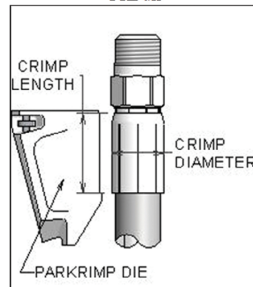

Technical information



Measure and cut hose to length

How to measure and cut hose to length



Verify if type and size of the hose printed on the layline do match the work order.

NOTE

When calculating hose length, take into consideration the change in hose length (expansion/contraction) that may occur during pressurisation.

Using a flexible or rigid measuring tape, measure the length of hose required as follows:

- a. Verify required length of hose assembly with fittings.
- b. Subtract "Cutoff Allowance" of each fitting from hose assembly length. (Refer to Hose Fittings Tables for proper cutoff allowances)
= dimension "B"

Example:

Hose assembly length with fittings =	500 mm
Fitting Cutoff Allowance (1B256-6-6)	41 mm
Fitting Cutoff Allowance (10356-8-6-SM)	37 mm
Total Cutoff Allowance	78 mm
500 mm – 78 mm	= 422 mm
Length of hose required	= 422 mm



Secure hose in some type of fixture to ensure straightness.



Measure and mark hose.

CAUTION

Do not use abrasive wheels to cut hose.

Abrasive wheels will damage core tube.

Release pressure by opening the shut-off valve ⑤ and remove finished assembly. Check crimp diameter.

Assembly instruction – KarryKrimp® 1 / KarryKrimp® 2

Fittings 56 and CG series

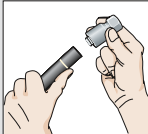

1. Mark the hose insertion depth acc. crimpable with a marker and push hose into fitting until the mark on the hose is even with the end of the shell. If necessary simply wet the fitting end with a drop of hoze oil. Do not lubricate if using spiral hose.

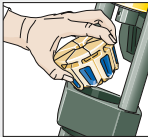

2. Pull pin and drop hinged die-train in place. Pay attention to die segment location.

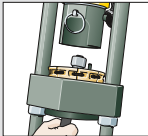

3. Insert fitting into the dies. Release, fitting will self position.



3. (a) Position the fitting on the die step.



4. Place die ring on top of the dies.

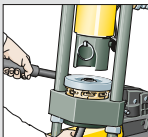

5. Position cylinder and replace pin. Pump until die ring contacts base plate.

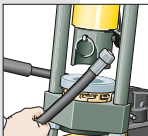

6. Release pressure
– remove finished assembly.

Assembly procedure – Push-Lok® self-grip hose

Assembly

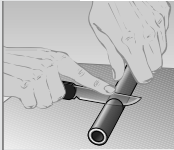

Cut hose perpendicularly with a sharp knife. If necessary, lubricate fitting end with water or soap and water solution (5% liquid soap + 95% water) for ease of assembly.

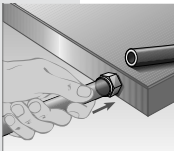

Insert fitting into hose and push with steady force until fitting is completely in hose. Grip hose approximately 2.5 cm from end. As an alternative, use the Parker 611050G assembly tool.

CAUTION

Push-Lok® fittings will provide an effective grip only when the Push-Lok® hose is pushed fully onto the insert, where the cropped end of the hose should be fully concealed by the plastic collar. Lubricate fitting end with water, soap, or a Push-Lok® assembly oil.

Disassembly

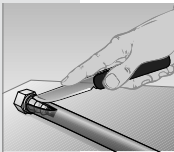

Cut the hose longitudinally along a line at approximately a 20° angle from the centre line of the hose. Make sure not to nick the barbs of the fitting.

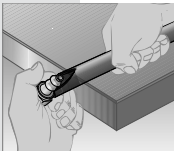

Pull fitting out of hose.

CAUTION

Before reusing the fitting, check fitting for damages. Damaged fittings result in leakage.

Push-Lok® assembly tool



For easy assembly of Parker self-gripping hose.

Overall length:

approx. 320 mm

Weight:

approx. 2.2 kg

Part No.

611050G

Twinline and multiline hose separation instructions

Separation

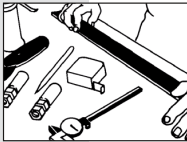

Position twinline or multiline hose assembly so that it lies flat on work surface without tendency to twist or turn.

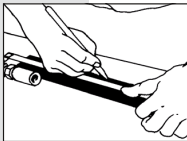

Measure and mark the length where the hoses are to be separated.



Lightly lubricate the area between the hoses to be separated with oil. The function of the oil is to reduce the friction of the knife blade.

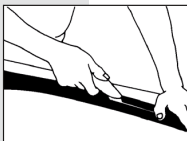

Press the multiline hose assembly firmly and flat against the work surface so that it does not move. Draw the knife toward you with constant light to moderate pressure and repeat cutting until hoses are separated.

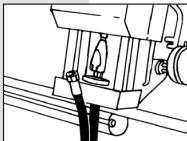

The separation length must be sufficiently long to avoid the risk of kinking the hoses during the crimping operation.

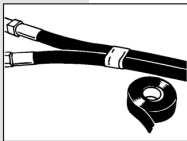

Depending on the requirements of the installation it is suggested that a nylon lashing strap or tape be applied at the termination of the separated length to provide protection against tearing of the hose covers.

NOTE

It is important that the knife blade be perpendicular to the hose during this procedure, so that the blade cuts only the material connecting the hoses. EXTREME CARE MUST BE TAKEN TO AVOID CUTTING THROUGH THE COVER OF THE HOSES AND THEREBY EXPOSING THE REINFORCEMENT.

Thermoplastic hose

Determining the hose length for over-the-sheaf applications

The exact cut-off length for an optimum over-the-sheaf assembly depends on the particular mechanical arrangement of the machine. A method for finding an approximate starting point is as follows:

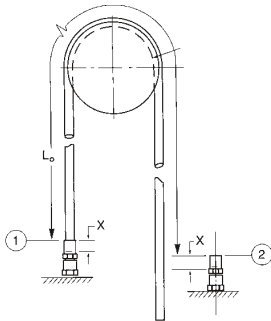

1. Assemble hose with one coupling, as shown in diagram.
2. Measure hose length from point 1 to point 2 with taut hose ($L_0 =$ length)

3. Calculate the hose length:
 Calculate hose cut-off or free length L_f :

$$L_f = 0.985 L_0 + 2x$$

Where L_f includes coupling insert allowance on both ends. The coupling insertion allowance (x) may be taken from the fitting tables as well as from the related drawing (difference measurement A-B) or from direct measuring on the coupling. A 1.5% stretch allowance is provided in this formula.

4. Couple the remaining hose end and assemble on the machine.

Definition of nominal length

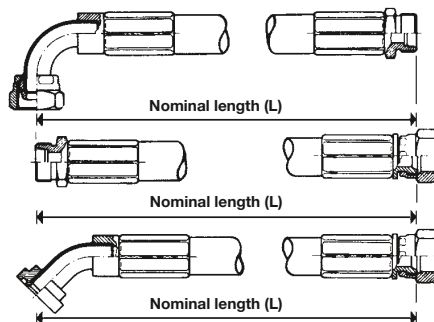

Selection, installation, and maintenance of **polyflex/Parflex** hose and hose assemblies

Hose and hose assemblies have a finite life span and many factors can reduce this time. This recommended practice should be read by designers and users of hose to assist them in the proper selection of hose. These guidelines, while not exhaustive, will assist the user in maintaining hydraulic and pneumatic systems.

READ THE PARKER SAFETY GUIDE CONTAINED IN THIS CATALOGUE IN ITS ENTIRETY!

Part 1 - How to select hose

- **Pressure** - Maximum operating pressure of the hose must be greater than or equal to the system pressure. Pressure surges or system “spikes” in excess of the maximum operating pressure will shorten hose life and must be avoided.
- **Temperature** - Ambient and fluid temperatures must not exceed the hose/fittings rated design temperature. Also the rated ambient temperature of the fluid inside the hose must not be exceeded. Attempt to route hose or shield hose from high temperature sources.
- **Size** - Adequately size hose and fittings to avoid damaging hose with excessive turbulence, or heat build-up, while maintaining proper flow and pressure. (Refer to fluid velocity nomogram.)
- **Fluid Resistance** - Refer to Chemical Resistance Guide in this catalogue for use of fluids with various materials. If unsure of an application, contact Parker Polymer Hose Division Europe.
- **Environment** - Conditions such as ozone, UV light, harsh chemicals, salt water, and other airborne contaminants can degrade hose and shorten its life.
- **Length** - Hose length changes with pressure. This, along with equipment movement, must be considered in the system design.
- **Proper couplings** - Always follow manufacturers specifications and do not mix components of different manufacturers.
- **Mechanical loads** - Conditions such as tensile and side loads, vibration, excessive flexing, and twist will reduce hose life. Use swivel fittings and adaptors to avoid hose twisting. Test the hose if the application is potentially problematic or unusual.

Part 2 – Installation and maintenance

- **Inspect components** - Check hose for cover cracks, blisters, cleanliness, kinks, cracks or core tube obstructions or other defects. Examine fittings for poor threads, obstructions, cracks, rust. Do not use hose or fittings if these problems exist.
- **Assemble per instructions contained in this catalogue.**
- **Do not exceed specified minimum bend radius** - Use stress relievers to prevent sharp bends at the hose and fitting juncture. These can be spring guards or other stress relieving members.
- **After installation, eliminate air entrapped in system, pressurise to maximum operating pressure, and check for leaks and proper system function.**
- **After installation, periodically (frequency depends on severity of application and potential risk) inspect the system for the following:**
 1. Blistered, degraded, or loose hose covers.
 2. Stiff, cracked, or charred hose.
 3. Cuts or abrasion of hose. Look for exposed reinforcement.
 4. Leaks in hose or fittings.
 5. Damaged or corroded fittings.
 6. Excessive build up of dirt, grease, oils, etc.
 7. Defective or broken accessories (clamping devices, kink guards)
 8. Kinks in hoses.

Upon discovery of any of these items, replace it.
DO NOT IGNORE IT!
- **Retest the system after all maintenance procedures.**
- **Establish replacement schedules based on previous service life, or when failures could result in damage, personal injury, excessive or unacceptable downtime.**

Installation standards

Hose installation tips

Establish hose size (ID) and style based upon flow rate (l/min), pressure drop, and chemical resistance with liquid or gaseous fluid. Other significant factors to be considered in hose selection and installation are the following:

Burst pressure and working pressure

The specified burst pressure for each hose style and dash size are for unaged hoses tested at normal laboratory temperature in accordance with SAE J343 specification for normal service and technically ideal installations. The maximum recommended working pressure is 1/4 of the minimum rated burst pressure, except as otherwise specifically stated in those product specifications. For more severe service, a higher rated working pressure hose may have to be selected.

Operating temperature

The temperature range for satisfactory service (maximum hose life) depends to a great extent upon the fluid being conveyed. Use of a hose above maximum specified temperature ratings will shorten hose life due, but not limited, to oxidation, chemical degradation and loss of compression within the coupling.

Pressure effects

Pressure surges and system shocks (spikes) are common in hydraulic systems. The normal 1:4 design factor should reflect these transient pressures. Where these surges and shocks are considered severe or hazardous, the design factor should be increased. When hose is under pressure, it may change in length by as much as +2/ -4%. Installation should compensate for shortening by providing an appropriate amount of slack and for lengthening by allowing space for this growth to be absorbed.

Bend radius

The minimum bend radii listed in this catalogue are valid at rated working pressures and indicated service temperatures. Service life of a hose may be shortened if the minimum radius is exceeded or if the hose is flexed continuously in use.

Ambient temperature

Exceedingly high or low ambient temperatures will affect the materials from which the hose is constructed and will negatively influence hose life. When at all possible, the hose should be routed in such a manner as to protect it from heat sources. In extreme cold applications, the equipment should be designed with remote relief valves to allow circulation and warming of the oil before hose articulation is attempted.

Abrasion

Abrasion occurs in numerous forms. Among the more common are the typical rubbing or chafing, with the second being very high frequency, low amplitude friction. This type of abrasion results from pump pressure pulses depending on the pump characteristics. It can also be caused by equipment vibration or resonance. Abrasion may occur when two hose lines cross or when a hose line rubs or bears against a fixed point. Abrasion resistance is also a function of temperature and attack of the cover material by aggressive chemicals.

Protective sleeving can ward off premature hose failure resulting from abrasion.

Routing and clamping

Maximum efforts should be made to route hose so it flexes in a single plane. Routing hoses in flexure through compound bends results in torsion. When this is unavoidable, the torsion should be distributed over the maximum hose length possible. Wire reinforced hoses suffer the most rapid and severe loss of service life when applied in torsion. Extremely tight and improperly located clamps focus this torsion over short distances.

Analysis of the hose function is required before the proper clamping techniques can be selected. In some applications, hoses must be contained to stay out of harm's way and at the same time be free to come and go with equipment articulation. Other applications may require restrictive clamping, in which case a protective material should be used around the hose to provide the grasp without deformation of the hose by the clamp.

Technical Information

Installation tips

Installation tips

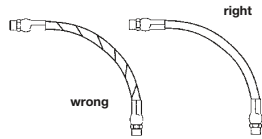

Hose is weakened when installed in twisted position. Also, pressure pulses in twisted hose tend to fatigue wire and loosen fitting connections. Design so that machine motion produces bending rather than torsion.

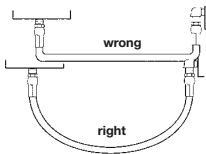

Hose should exit coupling in a straight position rather than side loaded. The minimum bend radius must not be exceeded to avoid kinking of hose and flow restriction.

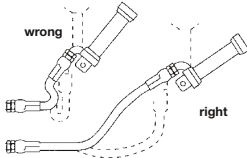

When hose assembly is installed in a flexing application, remember that metal hose fittings are not part of the flexible portion.

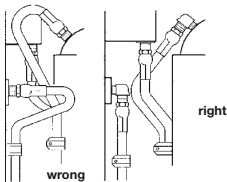

Use elbows or adaptors as necessary to eliminate excess hose length and to ensure neater installation and easier maintenance.

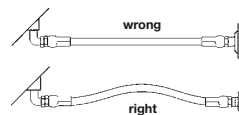

Free hose length allowance:
Pressure can change hose in length by as much as $\pm 2\%$. This must be considered when cutting hose to appropriate length.

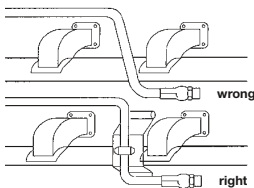

Avoid installing hose assemblies close to heat sources. However, if this should be required, insulate hose.

Technical information

Unit Conversion Table

Physical value	Unit	Abbreviation	Conversion Unit	Factor
Length	1 inch	in	mm	25.4
	1 millimetre	mm	in	0.03934
	1 foot	ft	m	0.3048
	1 metre	m	ft	3.28084
Surface	1 square inch	sq in	cm ²	6.4516
	1 square centimetre	cm ²	sq in	0.1550
Cubic content	1 gallon (UK)	gal	l	4.54596
	1 litre	l	gal (UK)	0.219976
	1 gallon (US)	gal	l	3.78533
	1 litre	l	gal (US)	0.264177
Weight	1 pound	lb	kg	0.453592
	1 kilogramme	kg	lb	2.204622
Pressure	1 pound per square inch	psi	bar	0.06895
	1 bar	bar	psi	14.5035
	1 pound per square inch	psi	MPa	0.006895
	1 mega pascal	MPa	psi	145.035
	1 kilo pascal	kPa	bar	0.01
	1 bar	bar	kPa	100
	1 mega pascal	MPa	bar	10
Velocity	1 foot per second	ft/s	m/s	0.3048
	1 metre per second	m/s	ft/s	3.28084
Flow rate	1 gallon per minute (UK)	gal/min.	l/min.	4.54596
	1 litre per minute	l/min.	gal/min. (UK)	0.219976
	1 gallon per minute (US)	gal/min.	l/min.	3.78533
	1 litre per minute	l/min.	gal/min. (US)	0.264178
Temperature	Fahrenheit	F	°C	$\frac{5}{9}(F-32)$
	Celsius	°C	F	$\frac{9}{5}C+32$

Technical Information
Parker Safety Guide

Parker Safety Guide for Selecting and Using Hose, Tubing, Fittings and Related Accessories
 Parker Publication No. 4400-B.1 / Revised: September, 2015



WARNING

Failure or improper selection or improper use of hose, tubing, fittings, assemblies, valves, connectors, conductors or related accessories ("Products") can cause death, personal injury and property damage. Possible consequences of failure or improper selection or improper use of these Products include but are not limited to:

- Fittings thrown off at high speed.
- High velocity fluid discharge.
- Explosion or burning of the conveyed fluid.
- Electrocutation from high voltage electric powerlines.
- Contact with suddenly moving or falling objects that are controlled by the conveyed fluid.
- Injections by high-pressure fluid discharge.
- Dangerously whipping Hose.
- Tube or pipe burst.
- Weld joint fracture.
- Contact with conveyed fluids that may be hot, cold, toxic or otherwise injurious.
- Sparking or explosion caused by static electricity buildup or other sources of electricity.
- Sparking or explosion while spraying paint or flammable liquids.
- Injuries resulting from inhalation, ingestion or exposure to fluids.

Before selecting or using any of these Products, it is important that you read and follow the instructions below. No product from any division in Fluid Connector Group is approved for in-flight aerospace applications. For hoses and fittings used in in-flight aerospace applications, please contact Parker Aerospace Group

1.0 GENERAL INSTRUCTIONS

Scope: This safety guide provides instructions for selecting and using (including assembling, installing, and maintaining) these Products. For convenience, all rubber and/or thermoplastic products commonly called "hose" or "tubing" are called "Hose" in this safety guide. Metallic tube or pipe are called "tube". All assemblies made with Hose are called "Hose Assemblies". All assemblies made with Tube are called "Tube Assemblies". All products commonly called "fittings", "couplings" or "adapters" are called "Fittings". Valves are fluid system components that control the passage of fluid. Related accessories are ancillary devices that enhance or monitor performance including crimping, flaring, flanging, presetting, bending, cutting, deburring, swaging machines, sensors, tags, lockout handles, spring guards and associated tooling. This safety guide is a supplement to and is to be used with the specific Parker publications for the specific Hose, Fittings and Related Accessories that are being considered for use. Parker publications are available at www.parker.com. SAE J1273 (www.sae.org) and ISO 17165-2 (www.ansi.org) also provide recommended practices for hydraulic Hose Assemblies, and should be followed.

1.1 Fail-Safe: Hose, Hose Assemblies, Tube, Tube Assemblies and Fittings can and do fail without warning for many reasons. Design all systems and equipment in a fail-safe mode, so that failure of the Hose, Hose Assembly, Tube, Tube Assembly or Fitting will not endanger persons or property.

1.2 Distribution: Provide a copy of this safety guide to each person responsible for selecting or using Hose, Tube and Fitting products. Do not select or use Parker Hose, Tube or Fittings without thoroughly reading and understanding this safety guide as well as the specific Parker publications for the Products.

1.3 User Responsibility: Due to the wide variety of operating conditions and applications for Hose, Tube and Fittings, Parker does not represent or warrant that any particular Hose, Tube or Fitting is suitable for any specific end use system. This safety guide does not analyze all technical parameters that must be considered in selecting a product. The user, through its own analysis and testing, is solely responsible for:

- Making the final selection of the Products.
- Assuring that the user's requirements are met and that the application presents no health or safety hazards.
- Following the safety guide for Related Accessories and being trained to operate Related Accessories.
- Providing all appropriate health and safety warnings on the equipment on which the Products are used.
- Assuring compliance with all applicable government and industry standards.

1.4 Additional Questions: Call the appropriate Parker technical service department if you have any questions or require any additional information. See the Parker publication for the Products being considered or used, or call 1-800-CPARKER, or go to www.parker.com,

telephone numbers of the appropriate technical service department.

2.0 HOSE, TUBE AND FITTINGS SELECTION INSTRUCTIONS

2.1 Electrical Conductivity: Certain applications require that the Hose be nonconductive to prevent electrical current flow. Other applications require the Hose and the Fittings and the Hose/Fitting interface to be sufficiently conductive to drain off static electricity. Extreme care must be exercised when selecting Hose, Tube and Fittings for these or any other applications in which electrical conductivity or nonconductivity is a factor. The electrical conductivity or nonconductivity of Hose, Tube and Fittings is dependent upon many factors and may be susceptible to change. These factors include but are not limited to the various materials used to make the Hose and the Fittings, Fitting finish (some Fitting finishes are electrically conductive while others are nonconductive), manufacturing methods (including moisture control), how the Fittings contact the Hose, age and amount of deterioration or damage or other changes, moisture content of the Hose at any particular time, and other factors. The following are considerations for electrically nonconductive and conductive Hose. For other applications consult the individual catalog pages and the appropriate industry or regulatory standards for proper selection.

2.1.1 Electrically Nonconductive Hose: Certain applications require that the Hose be nonconductive to prevent electrical current flow or to maintain electrical isolation. For applications that require Hose to be electrically nonconductive, including but not limited to applications near high voltage electric lines, only special nonconductive Hose can be used. The manufacturer of the equipment in which the nonconductive Hose is to be used must be consulted to be certain that the Hose, Tube and Fittings that are selected are proper for the application. Do not use any Parker Hose or Fittings for any such application requiring nonconductive Hose, including but not limited to applications near high voltage electric lines or dense magnetic fields, unless (i) the application is expressly approved in the Parker technical publication for the product, (ii) the Hose is marked "nonconductive", and (iii) the manufacturer of the equipment on which the Hose is to be used specifically approves the particular Parker Hose, Tube and Fittings for such use.

2.1.2 Electrically Conductive Hose: Parker manufactures special Hose for certain applications that require electrically conductive Hose. Parker manufactures special Hose for conveying paint in airless paint spraying applications. This Hose is labeled "Electrically Conductive Airless Paint Spray Hose" on its layline and packaging. This Hose must be properly connected to the appropriate Parker Fittings and properly grounded in order to dissipate dangerous static charge buildup, which occurs in all airless paint spraying applications. Do not use any other Hose for airless paint spraying, even if electrically conductive. Use of any other Hose or failure to properly connect the Hose can cause a fire or an explosion resulting in death, personal injury, and property damage. All hoses that convey fuels must be grounded. Parker manufactures a special Hose for certain compressed natural gas ("CNG")

Technical information



applications where static electricity buildup may occur. Parker CNG Hose assemblies comply with the requirements of ANSI/AS NGV 4.2; CSA 12.52, "Hoses for Natural Gas Vehicles and Dispensing Systems" (www.ansi.org). This Hose is labeled "Electrically Conductive for CNG Use" on its layline and packaging. This Hose must be properly connected to the appropriate Parker Fittings and properly grounded in order to dissipate dangerous static charge buildup, which occurs in, for example, high velocity CNG dispensing or transfer. Do not use any other Hose for CNG applications where static charge buildup may occur, even if electrically conductive. Use of other Hoses in CNG applications or failure to properly connect or ground this Hose can cause a fire or an explosion resulting in death, personal injury, and property damage. Care must also be taken to protect against CNG permeation through the Hose wall. See section 2.6, Permeation, for more information. Parker CNG Hose is intended for dispenser and vehicle use within the specified temperature range. Parker CNG Hose should not be used in confined spaces or unventilated areas or areas exceeding the specified temperature range. Final assemblies must be tested for leaks. CNG Hose Assemblies should be tested on a monthly basis for conductivity per ANSI/AS NGV 4.2; CSA 12.52. Parker manufactures special Hose for aerospace in-flight applications. Aerospace in-flight applications employing Hose to transmit fuel, lubricating fluids and hydraulic fluids require a special Hose with a conductive inner tube. This Hose for in-flight applications is available only from Parker's Stratoflex Products Division. Do not use any other Parker Hose for in-flight applications, even if electrically conductive. Use of other Hoses for in-flight applications or failure to properly connect or ground this Hose can cause a fire or an explosion resulting in death, personal injury and property damage. These Hose assemblies for in-flight applications must meet all applicable aerospace industry, aircraft engine and aircraft requirements.

2.2 Pressure: Hose, Tube and Fitting selection must be made so that the published maximum working pressure of the Hose, Tube and Fittings are equal to or greater than the maximum system pressure. The maximum working pressure of a Hose, or Tube Assembly is the lower of the respective published maximum working pressures of the Hose, Tube and the Fittings used. Surge pressures or peak transient pressures in the system must be below the published maximum working pressure for the Hose, Tube and Fitting. Surge pressures and peak pressures can usually only be determined by sensitive electrical instrumentation that measures and indicates pressures at millisecond intervals. Mechanical pressure gauges indicate only average pressures and cannot be used to determine surge pressures or peak transient pressures. Published burst pressure ratings for Hose is for manufacturing test purposes only and is no indication that the Product can be used in applications at the burst pressure or otherwise above the published maximum recommended working pressure.

2.3 Suction: Hoses used for suction applications must be selected to insure that the Hose will withstand the vacuum and pressure of the system. Improperly selected Hose may collapse in suction application.

2.4 Temperature: Be certain that fluid and ambient temperatures, both steady and transient, do not exceed the limitations of the Hose, Tube, Fitting and Seals. Temperatures below and above the recommended limit can degrade Hose, Tube, Fittings and Seals to a point where a failure may occur and release fluid. Tube and Fittings performances are normally degraded at elevated temperature. Material compatibility can also change at temperatures outside of the rated range. Properly insulate and protect the Hose Assembly when routing near hot objects (e.g. manifolds). Do not use any Hose in any application where failure of the Hose could result in the conveyed fluids (or vapors or mist from the conveyed fluids) contacting any open flame, molten metal, or other potential fire ignition source that could cause burning or explosion of the conveyed fluids or vapors.

2.5 Fluid Compatibility: Hose, and Tube Assembly selection must assure compatibility of the Hose tube, cover, reinforcement, Tube, Plating and Seals with the fluid media used. See the fluid compatibility chart in the Parker publication for the product being considered or used. This information is offered only as a guide. Actual service life can only be determined by the end user by testing under all extreme conditions and other analysis. Hose, and Tube that is chemically compatible with a particular fluid must be assembled using Fittings and adapters containing likewise compatible seals. Flange or flare processes can change Tube material properties that may not be compatible with certain requirements such as NACE.

2.6 Permeation: Permeation (that is, seepage through the Hose or Seal) will occur from inside the Hose or Fitting to outside when Hose or Fitting is used with gases, liquid and gas fuels, and refrigerants (including but not limited to such materials as helium, diesel fuel, gasoline,

natural gas, or LPG). This permeation may result in high concentrations of vapors which are potentially flammable, explosive, or toxic, and in loss of fluid. Dangerous explosions, fires, and other hazards can result when using the wrong Hose for such applications. The system designer must take into account the fact that this permeation will take place and must not use Hose or Fitting if this permeation could be hazardous. The system designer must take into account all legal, government, insurance, or any other special regulations which govern the use of fuels and refrigerants. Never use a Hose or Fitting even though the fluid compatibility is acceptable without considering the potential hazardous effects that can result from permeation through the Hose or Tube Assembly. Permeation of moisture from outside the Hose or Fitting to inside the Hose or Fitting will also occur in Hose or Tube assemblies, regardless of internal pressure. If this moisture permeation would have detrimental effects (particularly, but not limited to refrigeration and air conditioning systems), incorporation of sufficient drying capacity in the system or other appropriate system safeguards should be selected and used. The sudden pressure release of highly pressurized gas could also result in Explosive Decompression failure of permeated Seals and Hoses.

2.7 Size: Transmission of power by means of pressurized fluid varies with pressure and rate of flow. The size of the components must be adequate to keep pressure losses to a minimum and avoid damage due to heat generation or excessive fluid velocity.

2.8 Routing: Attention must be given to optimum routing to minimize inherent problems (kinking or flow restriction due to Hose collapse, twisting of the Hose, proximity to hot objects or heat sources). For additional routing recommendations see SAE J1273 and ISO 17165-2. Hose Assemblies have a finite life and should be installed in a manner that allows for ease of inspection and future replacement. Hose because of its relative short life, should not be used in residential and commercial buildings inside of inaccessible walls or floors, unless specifically allowed in the product literature. Always review all product literature for proper installation and routing instructions.

2.9 Environment: Care must be taken to insure that the Hose, Tube and Fittings are either compatible with or protected from the environment (that is, surrounding conditions) to which they are exposed. Environmental conditions including but not limited to ultraviolet radiation, sunlight, heat, ozone, moisture, water, salt water, chemicals and air pollutants can cause degradation and premature failure.

2.10 Mechanical Loads: External forces can significantly reduce Hose, Tube and Fitting life or cause failure. Mechanical loads which must be considered include excessive flexing, twist, kinking, tensile or side loads, bend radius, and vibration. Use of swivel type Fittings or adapters may be required to insure no twist is put into the Hose. Use of proper Hose or Tube clamps may also be required to reduce external mechanical loads. Unusual applications may require special testing prior to Hose selection.

2.11 Physical Damage: Care must be taken to protect Hose from wear, snagging, kinking, bending smaller than minimum bend radius and cutting, any of which can cause premature Hose failure. Any Hose that has been kinked or bent to a radius smaller than the minimum bend radius, and any Hose that has been cut or is cracked or is otherwise damaged should be removed and discarded. Fittings with damages such as scratches on sealing surfaces and deformation should be replaced.

2.12 Proper End Fitting: See instructions 3.2 through 3.5. These recommendations may be substantiated by testing to industry standards such as SAE J517 for hydraulic applications, or MIL-A-5070, AS1339, or AS3517 for Hoses from Parker's Stratoflex Products Division for aerospace applications.

2.13 Length: When determining the proper Hose or Tube length of an assembly, be aware of Hose length change due to pressure. Tube length change due to thermal expansion or contraction, and Hose or Tube and machine tolerances and movement must be considered. When routing short hose assemblies, it is recommended that the minimum free hose length is always used. Consult the hose manufacturer for their minimum free hose length recommendations. Hose assemblies should be installed in such a way that any motion or flexing occurs within the same plane.

2.14 Specifications and Standards: When selecting Hose, Tube and Fittings, government, industry, and Parker specifications and recommendations must be reviewed and followed as applicable.

2.15 Hose Cleanliness: Hose and Tube components may vary in cleanliness levels. Care must be taken to insure that the Hose and Tube Assembly selected has an adequate level of cleanliness for the application.

Technical Information

Parker Safety Guide

2.16 Fire Resistant Fluids: Some fire resistant fluids that are to be conveyed by Hose or Tube require use of the same type of Hose or Tube as used with petroleum base fluids. Some such fluids require a special Hose, Tube, Fitting and Seal, while a few fluids will not work with any Hose at all. See instructions 2.5 and 1.5. The wrong Hose, Tube, Fitting or Seal may fail after a very short service. In addition, all liquids but pure water may burn fiercely under certain conditions, and even pure water leakage may be hazardous.

2.17 Radiant Heat: Hose and Seals can be heated to destruction without contact by such nearby items as hot manifolds or molten metal. The same heat source may then initiate a fire. This can occur despite the presence of cool air around the Hose or Seal. Performance of Tube and Fitting subjected to the heat could be degraded.

2.18 Welding or Brazing: When using a torch or arc welder in close proximity to hydraulic lines, the hydraulic lines should be removed or shielded with appropriate fire resistant materials. Flame or weld spatter could burn through the Hose or Seal and possibly ignite escaping fluid resulting in a catastrophic failure. Heating of plated parts, including Hose Fittings and adapters, above 450°F (232°C) such as during welding, brazing or soldering may emit deadly gases. Any elastomer seal on fittings shall be removed prior to welding or brazing, any metallic surfaces shall be protected after brazing or welding when necessary. Welding and brazing filler material shall be compatible with the Tube and Fitting that are joined.

2.19 Atomic Radiation: Atomic radiation affects all materials used in Hose and Tube assemblies. Since the long-term effects may be unknown, do not expose Hose or Tube assemblies to atomic radiation. Nuclear applications may require special Tube and Fittings.

2.20 Aerospace Applications: The only Hose, Tube and Fittings that may be used for in-flight aerospace applications are those available from Parker's Stratoflex Products Division. Do not use any other Hose or Fittings for in-flight applications. Do not use any Hose or Fittings from Parker's Stratoflex Products Division with any other Hose or Fittings, unless expressly approved in writing by the engineering manager or chief engineer of Stratoflex Products Division and verified by the user's own testing and inspection to aerospace industry standards.

2.21 Unlocking Couplings: Ball locking couplings or other Fittings with quick disconnect ability can unintentionally disconnect if they are dragged over obstructions, or if the sleeve or other disconnect member, is bumped or moved enough to cause disconnect. Threaded Fittings should be considered where there is a potential for accidental uncoupling.

3.0 HOSE AND FITTINGS ASSEMBLY AND INSTALLATION INSTRUCTIONS

3.1 Component Inspection: Prior to assembly, a careful examination of the Hose and Fittings must be performed. All components must be checked for correct style, size, catalog number, and length. The Hose must be examined for cleanliness, obstructions, blisters, cover looseness, kinks, cracks, cuts or any other visible defects. Inspect the Fitting and sealing surfaces for burrs, nicks, corrosion or other imperfections. Do NOT use any component that displays any signs of nonconformance.

3.2 Hose and Fitting Assembly: Do not assemble a Parker Fitting on a Parker Hose that is not specifically listed by Parker for that Fitting, unless authorized in writing by the engineering manager or chief engineer of the appropriate Parker division. Do not assemble a Parker Fitting on another manufacturer's Hose or a Parker Hose on another manufacturer's Fitting unless (i) the engineering manager or chief engineer of the appropriate Parker division approves the Assembly in writing or that combination is expressly approved in the appropriate Parker literature for the specific Parker product, and

(ii) the user verifies the Assembly and the application through analysis and testing. For Parker Hose that does not specify a Parker Fitting, the user is solely responsible for the selection of the proper Fitting and Hose Assembly procedures. See instruction 1.4. To prevent the possibility of problems such as leakage at the Fitting or system contamination, it is important to completely remove all debris from the cutting operation before installation of the Fittings. The Parker published instructions must be followed for assembling the Fittings on the Hose. These instructions are provided in the Parker Fitting catalog for the specific Parker Fitting being used, or by calling 1-800-CPARKER, or at www.parker.com.

3.3 Related Accessories: Do not crimp or swage any Parker Hose or Fitting with anything but the listed swage or crimp machine and dies in accordance with Parker published instructions. Do not crimp

or swage another manufacturer's Fitting with a Parker crimp or swage die unless authorized in writing by the engineering manager or chief engineer of the appropriate Parker division.

3.4 Parts: Do not use any Parker Fitting part (including but not limited to socket, shell, nipple, or insert) except with the correct Parker mating parts, in accordance with Parker published instructions, unless authorized in writing by the engineering manager or chief engineer of the appropriate Parker division.

3.5 Field Attachable/Permanent: Do not reuse any field attachable Hose Fitting that has blown or pulled off a Hose. Do not reuse a Parker permanent Hose Fitting (crimped or swaged) or any part thereof. Complete Hose Assemblies may only be reused after proper inspection under section 4.0. Do not assemble Fittings to any previously used hydraulic Hose that was in service, for use in a fluid power application.

3.6 Pre-Installation Inspection: Prior to installation, a careful examination of the Hose Assembly must be performed. Inspect the Hose Assembly for any damage or defects. Do NOT use any Hose Assembly that displays any signs of nonconformance.

3.7 Minimum Bend Radius: Installation of a Hose at less than the minimum listed bend radius may significantly reduce the Hose life. Particular attention must be given to preclude sharp bending at the Hose to Fitting juncture. Any bending during installation at less than the minimum bend radius must be avoided. If any Hose is kinked during installation, the Hose must be discarded.

3.8 Twist Angle and Orientation: Hose Assembly installation must be such that relative motion of machine components does not produce twisting.

3.9 Securement: In many applications, it may be necessary to restrain, protect, or guide the Hose to protect it from damage by unnecessary flexing, pressure surges, and contact with other mechanical components. Care must be taken to insure such restraints do not introduce additional stress or wear points.

3.10 Proper Connection of Ports: Proper physical installation of the Hose Assembly requires a correctly installed port connection insuring that no twist or torque is transferred to the Hose when the Fittings are being tightened or otherwise during use.

3.11 External Damage: Proper installation is not complete without insuring that tensile loads, side loads, kinking, flattening, potential abrasion, thread damage or damage to sealing surfaces are corrected or eliminated. See instruction 2.10.

3.12 System Checkout: All air entrapment must be eliminated and the system pressurized to the maximum system pressure (at or below the Hose maximum working pressure) and checked for proper function and freedom from leaks. Personnel must stay out of potential hazardous areas while testing and using.

3.13 Routing: The Hose Assembly should be routed in such a manner so if a failure does occur, the escaping media will not cause personal injury or property damage. In addition, if fluid media comes in contact with hot surfaces, open flame or sparks, a fire or explosion may occur. See section 2.4.

3.14 Ground Fault Equipment Protection Devices (GFEPDs): WARNING! Fire and Shock Hazard. To minimize the danger of fire if the heating cable of a Multitube bundle is damaged or improperly installed, use a Ground Fault Equipment Protection Device. Electrical fault currents may be insufficient to trip a conventional circuit breaker. For ground fault protection, the IEEE 515: (www.ansi.org) standard for heating cables recommends the use of GFEPDs with a nominal 30 milliampere trip level for "tripping systems in classified areas, those areas requiring a high degree of maintenance, or which may be exposed to physical abuse or corrosive atmospheres".

4.0 TUBE AND FITTINGS ASSEMBLY AND INSTALLATION INSTRUCTIONS

4.1 Component Inspection: Prior to assembly, a careful examination of the Tube and Fittings must be performed. All components must be checked for correct style, size, material, seal, and length. Inspect the Fitting and sealing surfaces for burrs, nicks, corrosion, missing seal or other imperfections. Do NOT use any component that displays any signs of nonconformance.

4.2 Tube and Fitting Assembly: Do not assemble a Parker Fitting with a Tube that is not specifically listed by Parker for that Fitting, unless authorized in writing by the engineering manager or chief engineer of the appropriate Parker division. The Tube must meet the requirements specified to the Fitting. The Parker published instructions must be followed for assembling the Fittings to a Tube. These instructions



are provided in the Parker Fitting catalog for the specific Parker Fitting being used, or by calling 1-800-OPARKER, or at www.parker.com.

4.3 Related Accessories: Do not preset or flange Parker Fitting components using another manufacturer's equipment or procedures unless authorized in writing by the engineering manager or chief engineer of the appropriate Parker division. Tube, Fitting component and tooling must be checked for correct style, size and material. Operation and maintenance of Related Accessories must be in accordance with the operation manual for the designated Accessory.

4.4 Securement: In many applications, it may be necessary to restrain, protect, or guide the Tube to protect it from damage by unnecessary flexing, pressure surges, vibration, and contact with other mechanical components. Care must be taken to insure such restraints do not introduce additional stress or wear points.

4.5 Proper Connection of Ports: Proper physical installation of the Tube Assembly requires a correctly installed port connection insuring that no torque is transferred to the Tube when the Fittings are being tightened or otherwise during use.

4.6 External Damage: Proper installation is not complete without insuring that tensile loads, side loads, flattening, potential abrasion, thread damage or damage to sealing surfaces are corrected or eliminated. See instruction 2.10.

4.7 System Checkout: All air entrapment must be eliminated and the system pressurized to the maximum system pressure (at or below the Tube Assembly maximum working pressure) and checked for proper function and freedom from leaks. Personnel must stay out of potential hazardous areas while testing and using.

Routing: The Tube Assembly should be routed in such a manner so if a failure does occur, the escaping media will not cause personal injury or property damage. In addition, if fluid media comes in contact with hot surfaces, open flame or sparks, a fire or explosion may occur. See section 2.4.

5.0 HOSE AND FITTING MAINTENANCE AND REPLACEMENT INSTRUCTIONS

5.1 Even with proper selection and installation, Hose life may be significantly reduced without a continuing maintenance program. The severity of the application, risk potential from a possible Hose failure, and experience with any Hose failures in the application or in similar applications should determine the frequency of the inspection and the replacement for the Products so that Products are replaced before any failure occurs. Certain products require maintenance and inspection per industry requirements. Failure to adhere to these requirements may lead to premature failure. A maintenance program must be established and followed by the user and, at minimum, must include instructions 5.2 through 5.7.

5.2 Visual Inspection Hose/Fitting: Any of the following conditions require immediate shut down and replacement of the Hose Assembly:

- Fitting slippage on Hose;
- Damaged, cracked, cut or abraded cover (any reinforcement exposed);
- Hard, stiff, heat cracked, or charred Hose;
- Cracked, damaged, or badly corroded Fittings;
- Leaks at Fitting or in Hose;
- Kinked, crushed, flattened or twisted Hose; and
- Blistered, soft, degraded, or loose cover.

5.3 Visual Inspection All Other: The following items must be tightened, repaired, corrected or replaced as required:

- Leaking port conditions;
- Excess dirt buildup;
- Worn clamps, guards or shields; and
- System fluid level, fluid type, and any air entrapment.

5.4 Functional Test: Operate the system at maximum operating pressure and check for possible malfunctions and leaks. Personnel must avoid potential hazardous areas while testing and using the system. See section 2.2.

5.5 Replacement Intervals: Hose assemblies and elastomeric seals used on Hose Fittings and adapters will eventually age, harden, wear and deteriorate under thermal cycling and compression set. Hose Assemblies and elastomeric seals should be inspected and replaced at specific replacement intervals, based on previous service life, government or industry recommendations, or when failures could result in unacceptable downtime, damage, or injury risk. See section 1.2. Hose and Fittings may be subjected to internal mechanical and/or chemical wear from the conveying fluid and may fail without warning. The user must determine the product life under such circumstances by testing. Also see section 2.5.

5.6 Hose Inspection and Failure: Hydraulic power is accomplished by utilizing high pressure fluids to transfer energy and do work. Hoses, Fittings and Hose Assemblies all contribute to this by transmitting fluids at high pressures. Fluids under pressure can be dangerous and potentially lethal and, therefore, extreme caution must be exercised when working with fluids under pressure and handling the Hoses transporting the fluids. From time to time, Hose Assemblies will fail if they are not replaced at proper time intervals. Usually these failures are the result of some form of misapplication, abuse, wear or failure to perform proper maintenance. When Hoses fail, generally the high pressure fluids inside escape in a stream which may or may not be visible to the user. Under no circumstances should the user attempt to locate the leak by "feeling" with their hands or any other part of their body. High pressure fluids can and will penetrate the skin and cause severe tissue damage and possibly loss of limb. Even seemingly minor hydraulic fluid injection injuries must be treated immediately by a physician with knowledge of the tissue damaging properties of hydraulic fluid.

If a Hose failure occurs, immediately shut down the equipment and leave the area until pressure has been completely released from the Hose Assembly. Simply shutting down the hydraulic pump may or may not eliminate the pressure in the Hose Assembly. Many times check valves, etc., are employed in a system and can cause pressure to remain in a Hose Assembly even when pumps or equipment are not operating. Tiny holes in the Hose, commonly known as pinholes, can eject small, dangerously powerful but hard to see streams of hydraulic fluid. It may take several minutes or even hours for the pressure to be relieved so that the Hose Assembly may be examined safely. Once the pressure has been reduced to zero, the Hose Assembly may be taken off the equipment and examined. It must always be replaced if a failure has occurred. Never attempt to patch or repair a Hose Assembly that has failed. Consult the nearest Parker distributor or the appropriate Parker division for Hose Assembly replacement information. Never touch or examine a failed Hose Assembly unless it is obvious that the Hose no longer contains fluid under pressure. The high pressure fluid is extremely dangerous and can cause serious and potentially fatal injury.

5.7 Elastomeric seals: Elastomeric seals will eventually age, harden, wear and deteriorate under thermal cycling and compression set. Elastomeric seals should be inspected and replaced.

5.8 Refrigerant gases: Special care should be taken when working with refrigeration systems. Sudden escape of refrigerant gases can cause blindness if the escaping gases contact the eye and can cause freezing or other severe injuries if it contacts any other portion of the body.

5.9 Compressed natural gas (CNG): Parker CNG Hose Assemblies should be tested after installation and before use, and at least on a monthly basis per instructions provided on the Hose Assembly tag. The recommended procedure is to pressurize the Hose and check for leaks and to visually inspect the Hose for damage and to perform an electrical resistance test.

Caution: Matches, candles, open flame or other sources of ignition shall not be used for Hose inspection. Leak check solutions should be rinsed off after use.

6.0 HOSE STORAGE

6.1 Age Control: Hoses and Hose Assemblies must be stored in a manner that facilitates age control and first-in and first-out usage based on manufacturing date of the Hose and Hose Assemblies. Unless otherwise specified by the manufacturer or defined by local laws and regulations:

6.1.1 The shelf life of rubber hose in bulk form or hose made from two or more materials is 28 quarters (7 years) from the date of manufacture, with an extension of 12 quarters (3 years), if stored in accordance with ISO 22303;

6.1.2 The shelf life of thermoplastic and polytetrafluoroethylene hose is considered to be unlimited;

6.1.3 Hose assemblies that pass visual inspection and proof test shall not be stored for longer than 2 years.

6.1.4 Storage: Stored Hose and Hose Assemblies must not be subjected to damage that could reduce their expected service life and must be placed in a cool, dark and dry area with the ends capped. Stored Hose and Hose Assemblies must not be exposed to temperature extremes, ozone, oils, corrosive liquids or fumes, solvents, high humidity, rodents, insects, ultraviolet light, electromagnetic fields or radioactive materials.

Chapter H

Index of Part Numbers

Part No.	Page	Part No.	Page	Part No.	Page
10156-12-12-SM	E-51	101NX-6-06	E-74	103NX-10-08	E-74
10156-16-16-SM	E-51	101NX-8-06	E-74	103NX-12-10	E-74
10156-2-2	E-51	101NX-8-08	E-74	103NX-16-12	E-74
10156-2-3-SM	E-51	101PC-12-10	C-37	103NX-20-16	E-74
10156-4-3-SM	E-51	101PC-12-12	C-37	103NX-24-20	E-74
10156-4-4-SM	E-51	101PC-16-16	C-37	103NX-5-04	E-74
10156-4-5-SM	E-51	101PC-4-04	C-37	103NX-6-05	E-74
10156-4-6-SM	E-51	101PC-4-06	C-37	103NX-8-06	E-74
10156-6-6-SM	E-51	101PC-6-04	C-37	103PC-10-08	C-38
10156-8-8-SM	E-51	101PC-6-05	C-37	103PC-12-10	C-38
10191N-12-12	C-18	101PC-6-06	C-37	103PC-16-12	C-38
10191N-16-16	C-18	101PC-6-08	C-37	103PC-20-16	C-38
10191N-2-4	C-18	101PC-8-06	C-37	103PC-5-04	C-38
10191N-4-4	C-18	101PC-8-08	C-37	103PC-6-04	C-38
10191N-4-5	C-18	101PX-12-10	E-87	103PC-6-05	C-38
10191N-4-6	C-18	101PX-12-12	E-87	103PC-8-06	C-38
10191N-4-8	C-18	101PX-16-16	E-87	103PX-10-08	E-88
10191N-6-6	C-18	101PX-2-03	E-87	103PX-12-10	E-88
10191N-6-8	C-18	101PX-4-03	E-87	103PX-16-12	E-88
10191N-8-10	C-18	101PX-4-04	E-87	103PX-20-16	E-88
10191N-8-12	C-18	101PX-4-06	E-87	103PX-4-03	E-88
10191N-8-8	C-18	101PX-6-04	E-87	103PX-5-04	E-88
10193N-12-12	C-27	101PX-6-05	E-87	103PX-6-04	E-88
10193N-16-16	C-27	101PX-6-06	E-87	103PX-6-05	E-88
10193N-20-20	C-27	101PX-6-08	E-87	103PX-8-06	E-88
10193N-24-24	C-27	101PX-8-06	E-87	103YX-10-08	C-46
10193N-32-32	C-27	101PX-8-08	E-87	103YX-12-10	C-46
10193N-8-8	C-27	101YX-12-10	C-46	103YX-16-12	C-46
101CG-12-12	D-12, E-60	101YX-12-12	C-46	103YX-20-16	C-46
101CG-16-16	D-12, E-60	101YX-16-16	C-46	103YX-4-03	C-46
101CG-2-3	D-12, E-60	101YX-2-03	C-46	103YX-5-04	C-46
101CG-4-3	D-12, E-60	101YX-4-03	C-46	103YX-6-05	C-46
101CG-4-4	D-12, E-60	101YX-4-04	C-46	103YX-8-06	C-46
101CG-6-6	D-12, E-60	101YX-4-06	C-46	10656-10-8-SM	E-52
101CG-8-8	D-12, E-60	101YX-6-04	C-46	10656-12-12-SM	E-52
101EX-2-012	E-66	101YX-6-05	C-46	10656-16-16-SM	E-52
101EX-2-025	E-66	101YX-6-06	C-46	10656-4-2	E-52
101EX-4-012	E-66	101YX-6-08	C-46	10656-4-3-SM	E-52
101EX-4-025	E-66	101YX-8-08	C-46	10656-4-4-SM	E-52
101NX-12-10	E-74	10356-4-4-SM	E-52	10656-5-4-SM	E-52
101NX-12-12	E-74	10356-5-5-SM	E-52	10656-5-5-SM	E-52
101NX-16-12	E-74	10356-6-5-SM	E-52	10656-6-4-SM	E-52
101NX-16-16	E-74	10356-6-6-SM	E-52	10656-6-5-SM	E-52
101NX-4-04	E-74	10356-8-6-SM	E-52	10656-6-6-SM	E-52
101NX-6-05	E-74	10356-8-8-SM	E-52	10656-8-6-SM	E-52

Index of Part Numbers

Part No.	Page	Part No.	Page	Part No.	Page
10656-8-8-SM	E-52	106PX-16-12	E-88	107YX-4-03	C-49
10691N-10-10	C-19	106PX-20-16	E-88	107YX-4-04	C-49
10691N-12-12	C-19	106PX-4-02	E-88	107YX-6-05	C-49
10691N-16-16	C-19	106PX-4-03	E-88	107YX-6-06	C-49
10691N-4-4	C-19	106PX-4-04	E-88	107YX-8-08	C-49
10691N-5-5	C-19	106PX-5-04	E-88	10891N-12-12	C-21
10691N-6-6	C-19	106PX-6-04	E-88	10891N-6-6	C-21
10691N-8-8	C-19	106PX-6-05	E-88	108PX-8-06-LPG	D-9
10693N-10-10	C-27	106PX-6-06	E-88	10C56-10-4	E-46
10693N-12-12	C-27	106PX-8-06	E-88	10C56-12-5	E-46
10693N-16-16	C-27	106YX-10-08	C-49	10C56-12-6	E-46
10693N-20-20	C-27	106YX-12-10	C-49	10C56-16-8	E-46
10693N-24-24	C-27	106YX-16-12	C-49	10C56-8-3	E-46
10693N-32-32	C-27	106YX-20-16	C-49	10C9X-14-06	E-57
10693N-8-8	C-27	106YX-4-03	C-49	10C9X-16-08	E-57
1069X-10-08	E-59	106YX-5-04	C-49	10CNX-10-04	E-71
1069X-6-06	E-59	106YX-6-05	C-49	10CNX-12-05	E-71
1069X-8-06	E-59	106YX-6-06	C-49	10CNX-12-06	E-71
106CG-12-12	D-12, E-60	106YX-8-06	C-49	10CNX-14-06	E-71
106CG-16-16	D-12, E-60	10791N-12-12	C-19	10CNX-16-08	E-71
106CG-4-3	D-12, E-60	10791N-16-16	C-19	10CNX-20-10	E-71
106CG-4-4	D-12, E-60	10791N-4-4	C-19	10CNX-25-12	E-71
106CG-6-6	D-12, E-60	10791N-6-6	C-19	10CNX-30-16	E-71
106CG-8-8	D-12, E-60	10791N-8-8	C-19	10CPC-10-04	C-32
106EX-3-012	E-67	107NX-12-10	E-75	10CPC-12-05	C-32
106EX-4-012	E-67	107NX-12-12	E-75	10CPC-14-06	C-32
106EX-4-025	E-67	107NX-4-04	E-75	10CPC-16-08	C-32
106NX-10-08	E-75	107NX-6-05	E-75	10CPC-20-10	C-32
106NX-10-10	E-75	107NX-6-06	E-75	10CPX-10-04	E-79
106NX-12-10	E-75	107NX-8-08	E-75	10CPX-12-05	E-79
106NX-12-12	E-75	107PC-12-10	C-39	10CPX-14-06	E-79
106NX-16-12	E-75	107PC-12-12	C-39	10CPX-16-08	E-79
106NX-16-16	E-75	107PC-2-03	C-39	10CPX-20-10	E-79
106NX-20-16	E-75	107PC-4-03	C-39	10CPX-8-03	E-79
106NX-5-04	E-75	107PC-4-04	C-39	11C56-10-4	E-47
106NX-6-05	E-75	107PC-6-05	C-39	11C56-12-5	E-47
106NX-6-06	E-75	107PC-6-06	C-39	11C56-12-6	E-47
106NX-8-06	E-75	107PC-8-08	C-39	11C56-16-8	E-47
106NX-8-08	E-75	107PX-12-10	E-89	11C56-8-3	E-47
106PC-10-08	C-38	107PX-12-12	E-89	11C9X-12-06	E-57
106PC-12-10	C-38	107PX-2-03	E-89	11C9X-14-06	E-57
106PC-16-12	C-38	107PX-4-02	E-89	11C9X-16-08	E-57
106PC-20-16	C-38	107PX-4-03	E-89	11CNX-10-04	E-72
106PC-4-04	C-38	107PX-4-04	E-89	11CNX-12-05	E-72
106PC-5-04	C-38	107PX-6-05	E-89	11CNX-14-06	E-72
106PC-6-05	C-38	107PX-6-06	E-89	11CNX-16-08	E-72
106PC-6-06	C-38	107PX-8-08	E-89	11CNX-20-10	E-72
106PC-8-06	C-38	107YX-12-10	C-49	11CNX-25-12	E-72
106PX-10-08	E-88	107YX-12-12	C-49	11CNX-30-16	E-72
106PX-12-10	E-88	107YX-2-03	C-49	11CPC-10-04	C-33

Index



Part No.	Page	Part No.	Page	Part No.	Page
11CPC-12-05	C-33	13956-4-3-SM	E-53	17791N-12-12	C-21
11CPC-14-06	C-33	13956-4-4-SM	E-53	17791N-6-6	C-21
11CPC-16-08	C-33	13956-6-4-SM	E-53	17991N-12-12	C-22
11CPC-20-10	C-33	13956-6-6-SM	E-53	17991N-6-6	C-22
11CPC-6-04	C-33	13956-8-6-SM	E-53	17APX-4-03S-LPG	D-8
11CPX-10-04	E-80	13956-8-8-SM	E-53	17APX-6-03-LPG	D-8
11CPX-12-05	E-80	13991N-10-10	C-20	17APX-8-04-LPG	D-8
11CPX-14-06	E-80	13991N-12-12	C-20	17APX-8-04S-LPG	D-8
11CPX-16-08	E-80	13991N-16-16	C-20	191PX-4-04BF	E-87
11CPX-20-10	E-80	13991N-4-4	C-20	191PX-4-04C	E-87
11CPX-6-04	E-80	13991N-5-5	C-20	19256-12-12	E-49
11CPX-8-03	E-80	13991N-6-6	C-20	19256-16-16	E-49
128PX-4-03-LPG	D-10	13991N-8-8	C-20	19256-4-3	E-49
129PX-8-06-LPG	D-9	139CG	D-13, E-61	19256-4-4	E-49
13756-16-16-SM	E-53	139CG-4-4	D-13, E-61	19256-4-5	E-49
13756-4-3-SM	E-53	139PC-10-08	C-40	19256-6-4	E-49
13756-4-4-SM	E-53	139PC-12-10	C-40	19256-6-5	E-49
13756-6-6-SM	E-53	139PC-16-12	C-40	19256-6-6	E-49
13756-8-8-SM	E-53	139PC-20-16	C-40	19256-8-6	E-49
13791N-10-10	C-20	139PC-5-04	C-40	19256-8-8	E-49
13791N-12-12	C-20	139PC-6-05	C-40	19291N-12-12-RD	C-17
13791N-16-16	C-20	139PC-8-06	C-40	19291N-12-16-RD	C-17
13791N-4-4	C-20	139PX-10-08	E-90	19291N-4-4-RD	C-17
13791N-5-5	C-20	139PX-12-10	E-90	19291N-4-5-RD	C-17
13791N-6-6	C-20	139PX-16-12	E-90	19291N-6-6-RD	C-17
13791N-8-8	C-20	139PX-20-16	E-90	19291N-6-8-RD	C-17
137PC-10-08	C-39	139PX-4-03	E-90	19291N-8-10-RD	C-17
137PC-12-10	C-39	139PX-5-04	E-90	1929X-6-06	E-58
137PC-16-12	C-39	139PX-6-05	E-90	1929X-8-08	E-58
137PC-20-16	C-39	139PX-8-06	E-90	192EX-4-025	E-65
137PC-5-04	C-39	139YX-10-08	C-50	192NX-12-10	E-73
137PC-6-05	C-39	139YX-12-10	C-50	192NX-12-12	E-73
137PX-10-08	E-89	139YX-16-12	C-50	192NX-16-12	E-73
137PX-12-10	E-89	139YX-20-16	C-50	192NX-16-16	E-73
137PX-16-12	E-89	139YX-4-03	C-50	192NX-20-16	E-73
137PX-20-16	E-89	139YX-5-04	C-50	192NX-4-04	E-73
137PX-4-03	E-89	139YX-6-05	C-50	192NX-6-05	E-73
137PX-5-04	E-89	139YX-8-06	C-50	192NX-6-06	E-73
137PX-6-05	E-89	14956-12-4	E-48	192NX-8-06	E-73
137PX-8-06	E-89	14956-12-5	E-48	192NX-8-08	E-73
137YX-10-08	C-50	14956-14-3	E-48	192PC-12-10	C-35
137YX-12-10	C-50	14956-14-4	E-48	192PC-12-12	C-35
137YX-16-12	C-50	14956-14-5	E-48	192PC-16-12	C-35
137YX-20-16	C-50	14956-17-6	E-48	192PC-16-16	C-35
137YX-4-03	C-50	149EX-10-025	E-68	192PC-20-16	C-35
137YX-5-04	C-50	149EX-8-02	E-68	192PC-4-04	C-35
137YX-6-05	C-50	149PX-10-03-LPG	D-7	192PC-6-05	C-35
137YX-8-06	C-50	149PX-10-04-LPG	D-7	192PC-6-06	C-35
13956-10-8-SM	E-53	149PX-10-05-LPG	D-7	192PC-8-06	C-35
13956-16-16-SM	E-53	149PX-12-04-LPG	D-7	192PC-8-08	C-35

Index of Part Numbers

Part No.	Page	Part No.	Page	Part No.	Page
192PX-12-10	E-83	1B1PX-4-04	E-83	1B4YX-4-04	C-47
192PX-12-12	E-83	1B1PX-6-05	E-83	1B4YX-6-05	C-47
192PX-16-12	E-83	1B1PX-6-06	E-83	1B4YX-6-06	C-47
192PX-16-16	E-83	1B1PX-8-06	E-83	1B4YX-8-08	C-47
192PX-2-02	E-83	1B1PX-8-08	E-83	1BPEx-4-012	E-66
192PX-2-03	E-83	1B1YX-12-10	C-45	1C356-10-4	E-44
192PX-20-16	E-83	1B1YX-12-12	C-45	1C356-10-5	E-44
192PX-4-02	E-83	1B1YX-16-16	C-45	1C356-10-6	E-44
192PX-4-03	E-83	1B1YX-20-16	C-45	1C356-12-5	E-44
192PX-4-04	E-83	1B1YX-4-03	C-45	1C356-12-6	E-44
192PX-6-05	E-83	1B1YX-4-04	C-45	1C356-15-8	E-44
192PX-6-06	E-83	1B1YX-6-05	C-45	1C356-18-12	E-44
192PX-8-06	E-83	1B1YX-6-06	C-45	1C356-22-12	E-44
192PX-8-08	E-83	1B1YX-8-06	C-45	1C356-6-3	E-44
192YX-12-10	C-44	1B1YX-8-08	C-45	1C356-8-4	E-44
192YX-12-12	C-44	1B256-12-12	E-50	1C391N-10-6-RD	C-13
192YX-16-12	C-44	1B256-16-16	E-50	1C391N-10-8-RD	C-13
192YX-16-16	C-44	1B256-4-3	E-50	1C391N-12-10-RD	C-13
192YX-20-16	C-44	1B256-4-4	E-50	1C391N-12-8-RD	C-13
192YX-4-03	C-44	1B256-6-5	E-50	1C391N-15-10-RD	C-13
192YX-4-04	C-44	1B256-6-6	E-50	1C391N-18-10-RD	C-13
192YX-6-05	C-44	1B256-8-8	E-50	1C391N-18-12-RD	C-13
192YX-6-06	C-44	1B2PC-12-10	C-36	1C391N-22-16-RD	C-13
192YX-8-06	C-44	1B2PC-12-12	C-36	1C391N-6-4-RD	C-13
192YX-8-08	C-44	1B2PC-20-16	C-36	1C391N-6-5-RD	C-13
1AL91N-12-12C	C-24	1B2PC-4-04	C-36	1C391N-8-5-RD	C-13
1AL91N-16-16C	C-24	1B2PC-6-05	C-36	1C391N-8-6-RD	C-13
1AL91N-4-4C	C-24	1B2PC-6-06	C-36	1C39X-12-06	E-56
1AL91N-4-5C	C-24	1B2PC-8-06	C-36	1C39X-15-08	E-56
1AL91N-6-6C	C-24	1B2PC-8-08	C-36	1C3NX-10-04	E-70
1AL91N-8-8C	C-24	1B2PX-12-10	E-84	1C3NX-10-05	E-70
1B156-4-3	E-49	1B2PX-12-12	E-84	1C3NX-10-06	E-70
1B156-4-4	E-49	1B2PX-20-16	E-84	1C3NX-12-06	E-70
1B156-6-5	E-49	1B2PX-4-03	E-84	1C3NX-12-08	E-70
1B156-6-6	E-49	1B2PX-4-04	E-84	1C3NX-15-08	E-70
1B156-8-8	E-49	1B2PX-6-05	E-84	1C3NX-18-10	E-70
1B1PC-12-10	C-35	1B2PX-6-06	E-84	1C3NX-8-04	E-70
1B1PC-12-12	C-35	1B2PX-8-06	E-84	1C3PC-10-04	C-30
1B1PC-16-16	C-35	1B2PX-8-08	E-84	1C3PC-10-05	C-30
1B1PC-20-16	C-35	1B2YX-12-10	C-45	1C3PC-10-06	C-30
1B1PC-4-04	C-35	1B2YX-12-12	C-45	1C3PC-12-06	C-30
1B1PC-6-05	C-35	1B2YX-16-16	C-45	1C3PC-12-08	C-30
1B1PC-6-06	C-35	1B2YX-20-16	C-45	1C3PC-15-08	C-30
1B1PC-8-06	C-35	1B2YX-4-03	C-45	1C3PC-8-04	C-30
1B1PC-8-08	C-35	1B2YX-4-04	C-45	1C3PX-10-03	E-76
1B1PX-12-10	E-83	1B2YX-6-05	C-45	1C3PX-10-04	E-76
1B1PX-12-12	E-83	1B2YX-6-06	C-45	1C3PX-10-05	E-76
1B1PX-16-16	E-83	1B2YX-8-06	C-45	1C3PX-10-06	E-76
1B1PX-20-16	E-83	1B2YX-8-08	C-45	1C3PX-12-06	E-76
1B1PX-4-03	E-83	1B4PX-4-04	E-84	1C3PX-12-08	E-76

Index



Part No.	Page	Part No.	Page	Part No.	Page
1C3PX-15-08.....	E-76	1C6NX-30-16	E-70	1C9YX-20-10.....	C-42
1C3PX-6-02.....	E-76	1C6NX-8-04	E-70	1C9YX-25-12.....	C-42
1C3PX-6-03.....	E-76	1C956-10-4.....	E-46	1C9YX-30-16.....	C-42
1C3PX-6-03-LPG	D-7	1C956-10-5.....	E-46	1C9YX-8-03.....	C-42
1C3PX-8-02.....	E-76	1C956-12-4.....	E-46	1C9YX-8-04.....	C-42
1C3PX-8-03.....	E-76	1C956-12-5.....	E-46	1CA56-10-4.....	E-42
1C3PX-8-03-LPG	D-7	1C956-12-6.....	E-46	1CA56-10-5.....	E-42
1C3PX-8-04.....	E-76	1C956-14-6.....	E-46	1CA56-10-6.....	E-42
1C3PX-8-04-LPG	D-7	1C956-16-8.....	E-46	1CA56-12-4.....	E-42
1C3PX-8-05-LPG	D-7	1C956-25-12.....	E-46	1CA56-12-5.....	E-42
1C3YX-10-03.....	C-41	1C956-8-3.....	E-46	1CA56-12-6.....	E-42
1C3YX-10-04.....	C-41	1C956-8-4.....	E-46	1CA56-15-6.....	E-42
1C3YX-10-05.....	C-41	1C99X-12-06.....	E-56	1CA56-15-8.....	E-42
1C3YX-10-06.....	C-41	1C99X-14-06.....	E-56	1CA56-18-10.....	E-42
1C3YX-12-06.....	C-41	1C99X-16-08.....	E-56	1CA56-18-12.....	E-42
1C3YX-12-08.....	C-41	1C9EX-6-012.....	E-63	1CA56-18-8.....	E-42
1C3YX-15-08.....	C-41	1C9EX-8-012.....	E-63	1CA56-22-12.....	E-42
1C3YX-18-08.....	C-41	1C9EX-8-02.....	E-63	1CA56-28-16.....	E-42
1C3YX-18-10.....	C-41	1C9EX-8-025.....	E-63	1CA56-6-3.....	E-42
1C3YX-18-12.....	C-41	1C9NX-10-04.....	E-71	1CA56-6-4.....	E-42
1C3YX-22-12.....	C-41	1C9NX-12-05.....	E-71	1CA56-8-4.....	E-42
1C3YX-28-16.....	C-41	1C9NX-12-06.....	E-71	1CAEX-6-012.....	E-63
1C3YX-6-03.....	C-41	1C9NX-14-06.....	E-71	1CAEX-6-016.....	E-63
1C3YX-8-03.....	C-41	1C9NX-16-08.....	E-71	1CAEX-6-025.....	E-63
1C3YX-8-04.....	C-41	1C9NX-20-10.....	E-71	1CAEX-8-012.....	E-63
1C456-10-5.....	E-45	1C9NX-25-12.....	E-71	1CAEX-8-025.....	E-63
1C456-12-6.....	E-45	1C9NX-30-16.....	E-71	1CAPC-10-04.....	C-30
1C456-15-8.....	E-45	1C9NX-38-20.....	E-71	1CAPC-10-05.....	C-30
1C456-6-3.....	E-45	1C9NX-8-04.....	E-71	1CAPC-10-06.....	C-30
1C456-8-4.....	E-45	1C9PC-10-04.....	C-31	1CAPC-12-05.....	C-30
1C556-10-4.....	E-45	1C9PC-12-05.....	C-31	1CAPC-12-06.....	C-30
1C556-10-5.....	E-45	1C9PC-12-06.....	C-31	1CAPC-15-08.....	C-30
1C556-10-6.....	E-45	1C9PC-14-06.....	C-31	1CAPC-18-10.....	C-30
1C556-12-6.....	E-45	1C9PC-16-08.....	C-31	1CAPC-22-12.....	C-30
1C556-15-8.....	E-45	1C9PC-20-10.....	C-31	1CAPC-28-16.....	C-30
1C556-6-3.....	E-45	1C9PX-10-04.....	E-78	1CAPC-6-04.....	C-30
1C556-8-4.....	E-45	1C9PX-12-05.....	E-78	1CAPC-8-04.....	C-30
1C656-10-4.....	E-48	1C9PX-12-06.....	E-78	1CAPX-10-04.....	E-77
1C656-12-5.....	E-48	1C9PX-14-06.....	E-78	1CAPX-10-05.....	E-77
1C656-12-6.....	E-48	1C9PX-16-08.....	E-78	1CAPX-10-06.....	E-77
1C656-14-6.....	E-48	1C9PX-20-10.....	E-78	1CAPX-12-05.....	E-77
1C656-16-8.....	E-48	1C9PX-25-12.....	E-78	1CAPX-12-06.....	E-77
1C656-20-12.....	E-48	1C9PX-30-16.....	E-78	1CAPX-15-08.....	E-77
1C656-8-3.....	E-48	1C9PX-6-03.....	E-78	1CAPX-18-08.....	E-77
1C6NX-10-04.....	E-70	1C9PX-8-03.....	E-78	1CAPX-18-10.....	E-77
1C6NX-12-05.....	E-70	1C9PX-8-04.....	E-78	1CAPX-22-12.....	E-77
1C6NX-14-06.....	E-70	1C9YX-10-04.....	C-42	1CAPX-28-16.....	E-77
1C6NX-16-08.....	E-70	1C9YX-12-05.....	C-42	1CAPX-6-03.....	E-77
1C6NX-20-10.....	E-70	1C9YX-14-06.....	C-42	1CAPX-6-04.....	E-77
1C6NX-25-12.....	E-70	1C9YX-16-08.....	C-42	1CAPX-8-03.....	E-77

Index of Part Numbers

Part No.	Page	Part No.	Page	Part No.	Page
1CAPX-8-04	E-77	1CF56-8-4	E-43	1D0PX-12-05	E-81
1CAYX-10-04	C-42	1CFPC-10-05	C-32	1D0PX-12-06	E-81
1CAYX-10-05	C-42	1CFPC-10-06	C-32	1D0PX-15-06	E-81
1CAYX-12-06	C-42	1CFPC-12-06	C-32	1D0PX-15-08	E-81
1CAYX-15-08	C-42	1CFPC-15-08	C-32	1D0PX-18-10	E-81
1CAYX-18-10	C-42	1CFPC-18-10	C-32	1D0PX-22-12	E-81
1CAYX-22-12	C-42	1CFPC-22-12	C-32	1D0PX-28-16	E-81
1CAYX-28-16	C-42	1CFPC-6-04	C-32	1D0PX-6-03	E-81
1CAYX-6-03	C-42	1CFPC-8-04	C-32	1D0PX-6-04	E-81
1CAYX-8-04	C-42	1CFPC-10-05	E-80	1D0PX-8-04	E-81
1CE56-10-4	E-43	1CFPX-10-06	E-80	1D0YX-10-05	C-43
1CE56-10-5	E-43	1CFPX-12-06	E-80	1D0YX-12-06	C-43
1CE56-10-6	E-43	1CFPX-15-08	E-80	1D0YX-15-08	C-43
1CE56-12-6	E-43	1CFPX-18-10	E-80	1D0YX-18-10	C-43
1CE56-15-8	E-43	1CFPX-22-12	E-80	1D0YX-22-12	C-43
1CE56-18-12	E-43	1CFPX-28-16	E-80	1D0YX-28-16	C-43
1CE56-22-12	E-43	1CFPX-6-03	E-80	1D0YX-6-03	C-43
1CE56-28-16	E-43	1CFPX-6-04	E-80	1D0YX-8-04	C-43
1CE56-6-3	E-43	1CFPX-8-04	E-80	1D256-10-4	E-47
1CE56-8-4	E-43	1D056-10-5	E-44	1D256-10-5	E-47
1CEPC-10-05	C-31	1D056-10-6	E-44	1D256-12-5	E-47
1CEPC-10-06	C-31	1D056-12-5	E-44	1D256-12-6	E-47
1CEPC-12-06	C-31	1D056-12-6	E-44	1D256-14-6	E-47
1CEPC-15-08	C-31	1D056-15-6	E-44	1D256-16-6	E-47
1CEPC-18-10	C-31	1D056-15-8	E-44	1D256-16-8	E-47
1CEPC-22-12	C-31	1D056-18-10	E-44	1D256-20-12	E-47
1CEPC-28-16	C-31	1D056-22-12	E-44	1D256-8-3	E-47
1CEPC-6-04	C-31	1D056-28-16	E-44	1D29X-14-06	E-58
1CEPC-8-04	C-31	1D056-6-3	E-44	1D29X-16-08	E-58
1CEPX-10-05	E-79	1D056-8-4	E-44	1D2NX-10-04	E-72
1CEPX-10-06	E-79	1D091N-10-6	C-14	1D2NX-12-05	E-72
1CEPX-12-06	E-79	1D091N-10-8	C-14	1D2NX-14-06	E-72
1CEPX-15-08	E-79	1D091N-12-10	C-14	1D2NX-16-08	E-72
1CEPX-18-10	E-79	1D091N-12-8	C-14	1D2NX-20-10	E-72
1CEPX-22-12	E-79	1D091N-15-10	C-14	1D2NX-25-12	E-72
1CEPX-28-16	E-79	1D091N-18-12	C-14	1D2NX-30-16	E-72
1CEPX-6-03	E-79	1D091N-22-16	C-14	1D2PC-10-04	C-34
1CEPX-6-04	E-79	1D091N-6-4	C-14	1D2PC-12-05	C-34
1CEPX-8-04	E-79	1D091N-8-5	C-14	1D2PC-14-06	C-34
1CF56-10-4	E-43	1D091N-8-6	C-14	1D2PC-16-08	C-34
1CF56-10-5	E-43	1DOPC-10-05	C-33	1D2PC-20-10	C-34
1CF56-10-6	E-43	1DOPC-12-06	C-33	1D2PC-25-12	C-34
1CF56-12-5	E-43	1DOPC-15-06	C-33	1D2PC-30-16	C-34
1CF56-12-6	E-43	1DOPC-15-08	C-33	1D2PX-10-04	E-81
1CF56-15-8	E-43	1DOPC-18-10	C-33	1D2PX-12-05	E-81
1CF56-18-10	E-43	1DOPC-22-12	C-33	1D2PX-14-06	E-81
1CF56-22-12	E-43	1DOPC-28-16	C-33	1D2PX-16-08	E-81
1CF56-28-16	E-43	1DOPC-6-04	C-33	1D2PX-20-10	E-81
1CF56-6-3	E-43	1DOPC-8-04	C-33	1D2PX-25-12	E-81
1CF56-6-4	E-43	1DOPX-10-05	E-81	1D2PX-30-16	E-81

Index



Part No.	Page	Part No.	Page	Part No.	Page
1D2PX-8-03.....	E-81	1D9YX-4-03.....	C-48	1J991N-12-12.....	C-23
1D2YX-10-04.....	C-43	1D9YX-4-04.....	C-48	1J991N-16-16.....	C-23
1D2YX-12-05.....	C-43	1D9YX-4-06.....	C-48	1J991N-4-4.....	C-23
1D2YX-14-06.....	C-43	1D9YX-6-05.....	C-48	1J991N-6-6.....	C-23
1D2YX-16-08.....	C-43	1D9YX-6-06.....	C-48	1J991N-8-8.....	C-23
1D2YX-20-10.....	C-43	1D9YX-8-06.....	C-48	1J993N-20-20.....	C-29
1D2YX-25-12.....	C-43	1D9YX-8-08.....	C-48	1J9CG-12-12.....	D-14, E-62
1D2YX-30-16.....	C-43	1GAPX-12-04BF.....	E-92	1J9CG-16-16.....	D-14, E-62
1D2YX-8-03.....	C-43	1GAPX-12-04C.....	E-92	1J9CG-4-4.....	D-14, E-62
1D956-12-12.....	E-51	1GAPX-8-04BF.....	E-92	1J9CG-6-6.....	D-14, E-62
1D956-16-16.....	E-51	1GAPX-8-04BF2.....	E-93	1J9PX-4-03.....	E-92
1D956-4-3.....	E-51	1GAPX-8-04C.....	E-92	1J9PX-4-04.....	E-92
1D956-4-4.....	E-51	1GAPX-8-04CS.....	E-93	1J9PX-6-04.....	E-92
1D956-6-5.....	E-51	1J056-4-4-SM.....	E-55	1J9PX-6-06.....	E-92
1D956-6-6.....	E-51	1J056-6-6-SM.....	E-55	1J9PX-8-06.....	E-92
1D956-8-8.....	E-51	1J056-8-6-SM.....	E-55	1J9PX-8-08.....	E-92
1D991N-12-12.....	C-17	1J056-8-8-SM.....	E-55	1JC56-10-8-SM.....	E-54
1D991N-12-16.....	C-17	1J191N-16-16.....	C-24	1JC56-16-16-SM.....	E-54
1D991N-4-4.....	C-17	1J191N-4-4.....	C-24	1JC56-4-3-SM.....	E-54
1D991N-4-5.....	C-17	1J191N-6-5.....	C-24	1JC56-4-4-SM.....	E-54
1D991N-6-6.....	C-17	1J191N-6-6.....	C-24	1JC56-6-4-SM.....	E-54
1D991N-6-8.....	C-17	1J191N-8-8.....	C-24	1JC56-6-5-SM.....	E-54
1D991N-8-10.....	C-17	1J756-4-3-SM.....	E-54	1JC56-6-6-SM.....	E-54
1D9EX-4-012.....	E-65	1J756-4-4-SM.....	E-54	1JC56-8-6-SM.....	E-54
1D9PC-12-10.....	C-37	1J756-6-6-SM.....	E-54	1JC56-8-8-SM.....	E-54
1D9PC-12-12.....	C-37	1J756-8-8-SM.....	E-54	1JC91N-10-10.....	C-22
1D9PC-16-12.....	C-37	1J791N-10-10.....	C-23	1JC91N-12-10.....	C-22
1D9PC-20-16.....	C-37	1J791N-12-12.....	C-23	1JC91N-12-12.....	C-22
1D9PC-4-04.....	C-37	1J791N-16-16.....	C-23	1JC91N-16-16.....	C-22
1D9PC-6-05.....	C-37	1J791N-4-4.....	C-23	1JC91N-20-16.....	C-22
1D9PC-6-06.....	C-37	1J791N-4-6.....	C-23	1JC91N-4-4.....	C-22
1D9PC-8-06.....	C-37	1J791N-6-6.....	C-23	1JC91N-6-6.....	C-22
1D9PC-8-08.....	C-37	1J791N-8-8.....	C-23	1JC91N-8-8.....	C-22
1D9PX-12-10.....	E-86	1J793N-20-20.....	C-28	1JC93N-16-16.....	C-28
1D9PX-12-12.....	E-86	1J7CG-12-12.....	D-14, E-62	1JC93N-20-20.....	C-28
1D9PX-16-12.....	E-86	1J7CG-6-6.....	D-14, E-62	1JCCG-12-12.....	D-13, E-61
1D9PX-2-02.....	E-86	1J7CG-8-8.....	D-14, E-62	1JCCG-16-16.....	D-13, E-61
1D9PX-2-03.....	E-86	1J7PX-4-04.....	E-91	1JCCG-4-4.....	D-13, E-61
1D9PX-20-16.....	E-86	1J7PX-6-06.....	E-91	1JCCG-6-6.....	D-13, E-61
1D9PX-4-03.....	E-86	1J7PX-8-08.....	E-91	1JCCG-8-8.....	D-13, E-61
1D9PX-4-04.....	E-86	1J956-10-8-SM.....	E-55	1JCEX-4-012.....	E-67
1D9PX-6-05.....	E-86	1J956-12-12-SM.....	E-55	1JCEX-6-012.....	E-67
1D9PX-6-06.....	E-86	1J956-16-16-SM.....	E-55	1JCPX-12-12.....	E-90
1D9PX-8-06.....	E-86	1J956-4-3-SM.....	E-55	1JCPX-4-03.....	E-90
1D9PX-8-08.....	E-86	1J956-4-4-SM.....	E-55	1JCPX-4-04.....	E-90
1D9YX-12-10.....	C-48	1J956-6-4-SM.....	E-55	1JCPX-6-06.....	E-90
1D9YX-12-12.....	C-48	1J956-6-5-SM.....	E-55	1JCPX-8-06.....	E-90
1D9YX-16-12.....	C-48	1J956-6-6-SM.....	E-55	1JCPX-8-08.....	E-90
1D9YX-2-03.....	C-48	1J956-8-8-SM.....	E-55	1JSPX-8-06.....	E-91
1D9YX-20-16.....	C-48	1J991N-10-10.....	C-23	1P691N-4-4C.....	C-25

Index of Part Numbers

Part No.	Page	Part No.	Page	Part No.	Page
1P691N-6-6C	C-25	1U0YX-12-12.....	C-47	2040H-04V10	E-16
1P691N-8-8C	C-25	1U0YX-16-12.....	C-47	2040H-05V10	E-16
1PHPX-5.5-03S-LPG.....	D-11	1U0YX-16-16.....	C-47	2040H-06V10	E-16
1Q191N-4-4C	C-25	1U0YX-2-03.....	C-47	2040H-08V10	E-16
1Q191N-8-8C	C-25	1U0YX-20-16.....	C-47	2040H-10V10	E-16
1R8EX-11-012.....	E-68	1U0YX-4-03.....	C-47	2040H-12V10	E-16
1R8EX-11-02.....	E-68	1U0YX-4-04.....	C-47	2040H-16V10	E-16
1TU91N-12-12C.....	C-26	1U0YX-6-03.....	C-47	2040N-02V00	E-15, E-29
1TU91N-16-16C.....	C-26	1U0YX-6-04.....	C-47	2040N-03V00	E-15, E-29
1TU91N-4-4C.....	C-26	1U0YX-6-05.....	C-47	2040N-04V00	E-15, E-29
1TU91N-6-6C.....	C-26	1U0YX-6-06.....	C-47	2040N-05V00	E-15, E-29
1TU91N-8-8C.....	C-26	1U0YX-8-06.....	C-47	2040N-06V00	E-15, E-29
1U0NX-12-10	E-73	1U0YX-8-08.....	C-47	2040N-08V00	E-15, E-29
1U0NX-12-12	E-73	1YPEX-3-012.....	E-69	2040N-10V00	E-15, E-29
1U0NX-16-12	E-73	1YREX-10-012.....	E-69	2040N-12V00	E-15, E-29
1U0NX-4-04	E-73	1YREX-11-012.....	E-69	2040N-16V00	E-15, E-29
1U0NX-6-04	E-73	1YW91N-10-6C.....	C-26	2245N-04V00	E-25
1U0NX-6-05	E-73	1YW91N-12-8C.....	C-26	2245N-05V00	E-25
1U0NX-6-06	E-73	1YW91N-6-4C.....	C-26	2245N-06V00	E-25
1U0NX-8-06	E-73	1YW91N-8-4C.....	C-26	2245N-08V00	E-25
1U0NX-8-08	E-73	2010H-025V00	E-5	2245N-10V30	E-25
1U0PC-12-10	C-36	2020N-012V30	E-6	2245N-12V30	E-25
1U0PC-12-12	C-36	2020N-012V50	E-6	2245N-16V30	E-25
1U0PC-16-12	C-36	2020N-016V30	E-6	2246F-04V70	C-12
1U0PC-16-16	C-36	2020N-025V30	E-6	2246F-05V70	C-12
1U0PC-20-16	C-36	2020N-02V30	E-6	2246F-06V70	C-12
1U0PC-4-04	C-36	2030T-03V70	C-4, E-31	2246F-08V70	C-12
1U0PC-6-05	C-36	2030T-04CON.....	C-5	2246F-10V70	C-12
1U0PC-6-06	C-36	2030T-04V70	C-4, E-31	2246F-12V70	C-12
1U0PC-8-06	C-36	2030T-05CON.....	C-5	2246F-16V70	C-12
1U0PC-8-08	C-36	2030T-05V70	C-4, E-31	2370N-04V10	E-24, E-30
1U0PC-12-10.....	E-85	2030T-06CON.....	C-5	2370N-05V10	E-24, E-30
1U0PX-12-12.....	E-85	2030T-06V70	C-4, E-31	2370N-06V10	E-24, E-30
1U0PX-16-12.....	E-85	2030T-08CON.....	C-5	2370N-08V10	E-24, E-30
1U0PX-16-16.....	E-85	2030T-08V70	C-4, E-31	2380F-04V07	C-11
1U0PX-20-16.....	E-85	2030T-10CON.....	C-5	2380F-05V07	C-11
1U0PX-4-02	E-85	2030T-10V70	C-4, E-31	2380F-06V07	C-11
1U0PX-4-03.....	E-85	2030T-12CON.....	C-5	2380F-08V07	C-11
1U0PX-4-03-LPG	D-8	2030T-12V70	C-4, E-31	2380F-10V07	C-11
1U0PX-4-04	E-85	2030T-16CON.....	C-5	2380F-12V07	C-11
1U0PX-4-04-LPG	D-8	2030T-16V70	C-4, E-31	2380F-16V07	C-11
1U0PX-4-05-LPG	D-8	2030T-20CON.....	C-5	5CNG-4	D-5, E-39
1U0PX-6-03	E-85	2033T-04V70	C-6, E-32	5CNG-6	D-5, E-39
1U0PX-6-04	E-85	2033T-05V70	C-7, E-32	5CNG-8	D-5, E-39
1U0PX-6-05	E-85	2033T-06V70	C-7, E-32	5CNG-12	D-5, E-39
1U0PX-6-06	E-85	2033T-08V70	C-7, E-32	5CNG-16	D-5, E-39
1U0PX-8-06	E-85	2033T-10V70	C-7, E-32	518C-2	E-11
1U0PX-8-08	E-85	2033T-12V70	C-7, E-32	518C-3	E-11
1U0YX-10-08.....	C-47	2033T-16V70	C-7, E-32	518C-4	E-11
1U0YX-12-10.....	C-47	2040H-03V10	E-16	518C-5	E-11

Index



Part No.	Page	Part No.	Page	Part No.	Page
518C-6.....	E-11	588N-10.....	E-20	919-4	C-7
518C-8.....	E-11	588N-12.....	E-20	919-5	C-7
518C-10.....	E-11	588N-16.....	E-20	919-6	C-7
518C-12.....	E-11	590TJ-4	E-21	919-8	C-7
518C-16.....	E-11	590TJ-6	E-21	919-10.....	C-7
520N-3.....	E-17	590TJ-8	E-21	919-12.....	C-7
520N-4.....	E-17	590TJ-12.....	E-21	919-16.....	C-7
520N-5.....	E-17	590TJ-16.....	E-21	919U-4.....	C-8
520N-6.....	E-17	594TJ-8	E-22	919U-6.....	C-8
520N-8.....	E-17	594TJ-10.....	E-22	919U-8.....	C-8
527BA-3	E-38	53DM-6	E-12	919U-12.....	C-8
527BA-4	E-38	53DM-8	E-12	919U-16.....	C-8
528N-3.....	E-18	53DM-10.....	E-12	929/929B-4	C-9
528N-4.....	E-18	55LT-2.....	E-13	929/929B-6	C-9
528N-5.....	E-18	55LT-3.....	E-13	929/929B-8	C-9
528N-6.....	E-18	55LT-4.....	E-13	929B-12.....	C-9
528N-8.....	E-18	55LT-5.....	E-13	929B-16.....	C-9
540N-2.....	E-9	55LT-6.....	E-13	939/939B-6	C-10
540N-3.....	E-9	55LT-8.....	E-13	939/939B-8	C-10
540N-4.....	E-9	8.204.....	F-8	939/939B-10	C-10
540N-5.....	E-9	8.207.....	F-8	939/939B-12	C-10
540N-6.....	E-9	8LPG-3	D-6, E-40	939/939B-16	C-10
540N-8.....	E-9	8LPG-3-FR	D-6, E-40	939/939B-20	C-10
540N-12.....	E-9	8LPG-4	D-6, E-40	939/939B-24	C-10
550H-3.....	E-8	8LPG-4-FR	D-6, E-40	939/939B-32	C-10
550H-4.....	E-8	8LPG-5	D-6, E-40	A2M3	F-6
550H-5.....	E-8	8LPG-5-FR	D-6, E-40	A2M4	F-6
550H-6.....	E-8	8LPG-6	D-6, E-40	A2M6	F-6
550H-8.....	E-8	8LPG-6-FR	D-6, E-40	A2M8	F-6
550H-10.....	E-8	830M-4-xxx-RL	B-4	A2M10.....	F-6
550H-12.....	E-8	830M-6-xxx-RL	B-4	AM-03.....	F-6
550H-16.....	E-8	830M-8-xxx-RL	B-4	AM-04.....	F-6
560TJ-3	E-10	830M-10-xxx-RL	B-4	AM-06.....	F-6
560TJ-4	E-10	830M-12-xxx-RL	B-4	AM-08.....	F-6
560TJ-5	E-10	838M-4-RL	B-5	AM-10.....	F-6
560TJ-6	E-10	838M-6-RL	B-5	AM-13.....	F-6
560TJ-8	E-10	838M-8-RL	B-5	AM-16.....	F-6
560TJ-10.....	E-10	838M-10-RL	B-5	AM-20.....	F-6
560TJ-12.....	E-10	838M-12-RL	B-5	AR-04	F-6
575X-3.....	E-23	853009-8	F-7	AR-08	F-6
575X-4.....	E-23	853009-10	F-7	AR-08C	F-6
575X-6.....	E-23	853009-12	F-7	AR-10	F-6
575X-12.....	E-23	853009-14	F-7	AR-16	F-6
575X-16.....	E-23	853009-16	F-7	FS-F-10.....	F-5
575XN-8	E-23	853009-17	F-7	FS-F-11.....	F-5
580N-8.....	E-19	853009-18	F-7	FS-F-12.....	F-5
580N-10.....	E-19	853009-21	F-7	FS-F-14.....	F-5
580N-12.....	E-19	853009-22	F-7	FS-F-16.....	F-5
580N-16.....	E-19	853009-26	F-7	FS-F-18.....	F-5
588N-8.....	E-20	94C-001-PFD	G-7	FS-F-20.....	F-5

Index of Part Numbers

Part No.	Page	Part No.	Page	Part No.	Page
FS-F-22	F-5	PSG-20.....	F-4	PSG-FRAS-20	F-4
FS-F-24	F-5	PSG-25.....	F-4	PSG-FRAS-25	F-4
FS-F-28	F-5	PSG-32.....	F-4	PSG-FRAS-32	F-4
FS-F-32	F-5	PSG-40.....	F-4	PSG-FRAS-40	F-4
FS-F-38	F-5	PSG-50.....	F-4	PSG-FRAS-50	F-4
FS-F-40	F-5	PSG-63.....	F-4	PSG-FRAS-63	F-4
FS-F-48	F-5	PSG-75.....	F-4	PSG-FRAS-75	F-4
FS-F-60	F-5	PSG-90.....	F-4	PSG-FRAS-90	F-4
PSG-12.....	F-4	PSG-110.....	F-4	PSG-FRAS-110	F-4
PSG-16.....	F-4	PSG-FRAS-16	F-4	Tape-FV	F-8

For Your Safety!

Hose assemblies are used to transmit various kinds of fluids at considerable pressures. The critical zone of a hose assembly is the connection between flexible hose and rigid fitting (crimping area). Only the use of original **polyflex** components (hose, fittings and tooling) and full compliance with the **polyflex** assembly instructions can guarantee safety and conformity with standards.

When making and testing hose assemblies in connection with the respective field of application the guidelines and technical regulations as well as protection and hazard prevention rulings must be adhered to.

You as the manufacturer of **polyflex** hose assemblies are obliged to mark the hose assemblies according to the regulations.

Non-compliance with these rules can lead to the failure of a hose assembly and the loss of warranty.



At Parker, we're guided by a relentless drive to help our customers become more productive and achieve higher levels of profitability by engineering the best systems for their requirements. It means looking at customer applications from many angles to find new ways to create value. Whatever the motion and control technology need, Parker has the experience, breadth of product and global reach to consistently deliver. No company knows more about motion and control technology than Parker. For further info call 00800 27 27 5374

Parker's Motion & Control Technologies



Aerospace

Key Markets

Aftermarket services
Commercial transports
Engines
General & business aviation
Helicopters
Launch vehicles
Military aircraft
Missiles
Power generation
Regional transports
Unmanned aerial vehicles

Key Products

Control systems & actuation products
Engine systems & components
Fluid conveyance systems & components
Fluid melting, delivery & atomization devices
Fuel systems & components
Fuel tank inerting systems
Hydraulic systems & components
Thermal management
Wheels & brakes



Climate Control

Key Markets

Agriculture
Air conditioning
Construction Machinery
Food & beverage
Industrial machinery
Life sciences
Oil & gas
Precision cooling
Process
Refrigeration
Transportation

Key Products

Accumulators
Advanced actuators
CO₂ controls
Electronic controllers
Filter driers
Hand shut off valves
Heat exchangers
Hose & fittings
Pressure regulating valves
Refrigerant distributors
Safety relief valves
Smart pumps
Thermostatic expansion valves



Electromechanical

Key Markets

Aerospace
Factory automation
Life science & medical
Machine tools
Packaging machinery
Paper machinery
Plastics machinery & converting
Primary metals
Semiconductor & electronics
Textile
Wire & cable

Key Products

AC/DC drives & systems
Electric actuators, gantry robots & 300s
Electrohydraulic actuation systems
Electromechanical actuation systems
Human machine interface
Linear motors
Stepper motors, servo motors, drives & controls
Structural extrusions



Filtration

Key Markets

Aerospace
Food & beverage
Industrial plant & equipment
Life sciences
Marine
Mobile equipment
Oil & gas
Power generation & renewable energy
Process
Transportation
Water Purification

Key Products

Analytical gas generators
Compressed air filters & dryers
Engine air, coolant, fuel & oil filtration systems
Fluid condition monitoring systems
Hydraulic & lubrication filters
Hydrogen, nitrogen & zero air generators
Instrumentation filters
Membrane & fiber filters
Microfiltration
Sterile air filtration
Water desalination & purification filters & systems



Fluid & Gas Handling

Key Markets

Aerial lift
Agriculture
Bulk chemical handling
Construction machinery
Food & beverage
Fuel & gas delivery
Industrial machinery
Life sciences
Marine
Mining
Mobile
Oil & gas
Renewable energy
Soleroind valves
Transportation

Key Products

Check valves
Connectors for low pressure
Fluid conveyance
Deep sea umbilicals
Diagnostic equipment
Hose couplings
Industrial hose
Mooring systems & power cables
PTFE hose & tubing
Quick couplings
Rubber & thermoplastic hose
Tube fittings & adapters
Tubing & plastic fittings



Hydraulics

Key Markets

Aerial lift
Agriculture
Alternative energy
Construction machinery
Forestry
Industrial machinery
Machine tools
Marine
Material handling
Mining
Oil & gas
Power generation
Refuse vehicles
Renewable energy
Truck hydraulics
Turf equipment

Key Products

Accumulators
Cartridge valves
Electrohydraulic actuators
Human machine interfaces
Hybrid drives
Hydraulic cylinders
Hydraulic motors & pumps
Hydraulic systems
Hydraulic valves & controls
Hydrostatic steering
Integrated hydraulic circuits
Power take-offs
Power units
Relay actuators
Sensors



Pneumatics

Key Markets

Aerospace
Conveyor & material handling
Factory automation
Life science & medical
Machine tools
Packaging machinery
Transportation & automotive

Key Products

Air preparation
Brass fittings & valves
Manifolds
Pneumatic accessories
Pneumatic actuators & grippers
Pneumatic valves & controls
Quick disconnects
Rotary actuators
Rubber & thermoplastic hose & couplings
Structural extrusions
Thermoplastic tubing & fittings
Vacuum generators, cups & sensors



Process Control

Key Markets

Alternative fuels
Biopharmaceuticals
Chemical & refining
Food & beverage
Marine & shipbuilding
Medical & dental
Microelectronics
Nuclear Power
Offshore oil exploration
Oil & gas
Pharmaceutical
Power generation
Pulp & paper
Steel
Waste/wastewater

Key Products

Analytical Instruments
Analytical sample conditioning products & systems
Chemical injection fittings & valves
Fluoropolymer chemical delivery fittings, valves & pumps
High purity gas delivery fittings, valves, regulators & digital flow controllers
Industrial mass flow meters/controllers
Permanent no-weld tube fittings
Precision industrial regulators & flow controllers
Process control double block & bleed
Process control fittings, valves, regulators & manifold valves



Sealing & Shielding

Key Markets

Aerospace
Chemical processing
Consumer
Fluid power
General industrial
Information technology
Life sciences
Microelectronics
Military
Oil & gas
Power generation
Renewable energy
Telecommunications
Transportation

Key Products

Dynamic seals
Elastomeric o-rings
Electro-medical instrument design & assembly
Ball seating
Etched & precision-cut, fabricated elastomeric seals
High temperature metal seals
Homogeneous & inserted elastomeric shapes
Medical device fabrication & assembly
Misc & plastic retained composite seals
Shielded optical windows
Silicone tubing & extrusions
Thermal management
Vibration dampening

ENGINEERING YOUR SUCCESS.

Parker Worldwide

Europe, Middle East, Africa

AE – United Arab Emirates, Dubai

Tel: +971 4 8127100
parker.me@parker.com

AT – Austria, St. Florian

Tel: +43 (0)7224 66201
parker.austria@parker.com

AZ – Azerbaijan, Baku

Tel: +994 50 2233 458
parker.azerbaijan@parker.com

BE/NL/LU – Benelux, Hendrik Ido Ambacht

Tel: +31 (0)541 585 000
parker.nl@parker.com

BG – Bulgaria, Sofia

Tel: +359 2 980 1344
parker.bulgaria@parker.com

BY – Belarus, Minsk

Tel: +48 (0)22 573 24 00
parker.poland@parker.com

CH – Switzerland, Etoy

Tel: +41 (0)21 821 87 00
parker.switzerland@parker.com

CZ – Czech Republic, Klecany

Tel: +420 284 083 111
parker.czechrepublic@parker.com

DE – Germany, Kaarst

Tel: +49 (0)2131 4016 0
parker.germany@parker.com

DK – Denmark, Ballerup

Tel: +45 43 56 04 00
parker.denmark@parker.com

ES – Spain, Madrid

Tel: +34 902 330 001
parker.spain@parker.com

FI – Finland, Vantaa

Tel: +358 (0)20 753 2500
parker.finland@parker.com

FR – France, Contamine s/Arve

Tel: +33 (0)4 50 25 80 25
parker.france@parker.com

GR – Greece, Piraeus

Tel: +30 210 933 6450
parker.greece@parker.com

HU – Hungary, Budaörs

Tel: +36 23 885 470
parker.hungary@parker.com

IE – Ireland, Dublin

Tel: +353 (0)1 466 6370
parker.ireland@parker.com

IL – Israel

Tel: +39 02 45 19 21
parker.israel@parker.com

IT – Italy, Corsico (MI)

Tel: +39 02 45 19 21
parker.italy@parker.com

KZ – Kazakhstan, Almaty

Tel: +7 7273 561 000
parker.easteurope@parker.com

NO – Norway, Asker

Tel: +47 66 75 34 00
parker.norway@parker.com

PL – Poland, Warsaw

Tel: +48 (0)22 573 24 00
parker.poland@parker.com

PT – Portugal

Tel: +351 22 999 7360
parker.portugal@parker.com

RO – Romania, Bucharest

Tel: +40 21 252 1382
parker.romania@parker.com

RU – Russia, Moscow

Tel: +7 495 645-2156
parker.russia@parker.com

SE – Sweden, Spånga

Tel: +46 (0)8 59 79 50 00
parker.sweden@parker.com

SK – Slovakia, Banská Bystrica

Tel: +421 484 162 252
parker.slovakia@parker.com

SL – Slovenia, Novo Mesto

Tel: +386 7 337 6650
parker.slovenia@parker.com

TR – Turkey, Istanbul

Tel: +90 216 4997081
parker.turkey@parker.com

UA – Ukraine, Kiev

Tel: +48 (0)22 573 24 00
parker.poland@parker.com

UK – United Kingdom, Warwick

Tel: +44 (0)1926 317 878
parker.uk@parker.com

ZA – South Africa, Kempton Park

Tel: +27 (0)11 961 0700
parker.southafrica@parker.com

North America

CA – Canada, Milton, Ontario

Tel: +1 905 693 3000

US – USA, Cleveland

Tel: +1 216 896 3000

Asia Pacific

AU – Australia, Castle Hill

Tel: +61 (0)2-9634 7777

CN – China, Shanghai

Tel: +86 21 2899 5000

HK – Hong Kong

Tel: +852 2428 8008

IN – India, Mumbai

Tel: +91 22 6513 7081-85

JP – Japan, Tokyo

Tel: +81 (0)3 6408 3901

KR – South Korea, Seoul

Tel: +82 2 559 0400

MY – Malaysia, Shah Alam

Tel: +60 3 7849 0800

NZ – New Zealand, Mt Wellington

Tel: +64 9 574 1744

SG – Singapore

Tel: +65 6887 6300

TH – Thailand, Bangkok

Tel: +662 186 7000

TW – Taiwan, Taipei

Tel: +886 2 2298 8987

South America

AR – Argentina, Buenos Aires

Tel: +54 3327 44 4129

BR – Brazil, Sao Jose dos Campos

Tel: +55 800 727 5374

CL – Chile, Santiago

Tel: +56 2 623 1216

MX – Mexico, Toluca

Tel: +52 72 2275 4200

