

---

# ISOMAX DX ISO VALVE SERIES

**WARNING — USER RESPONSIBILITY****FAILURE OR IMPROPER SELECTION OR IMPROPER USE OF THE PRODUCTS DESCRIBED HEREIN OR RELATED ITEMS CAN CAUSE DEATH, PERSONAL INJURY AND PROPERTY DAMAGE.**

- This document and other information from Parker-Hannifin Corporation, its subsidiaries and authorized distributors provide product or system options for further investigation by users having technical expertise.
- The user, through its own analysis and testing, is solely responsible for making the final selection of the system and components and assuring that all performance, endurance, maintenance, safety and warning requirements of the application are met. The user must analyze all aspects of the application, follow applicable industry standards, and follow the information concerning the product in the current product catalog and in any other materials provided from Parker or its subsidiaries or authorized distributors.
- To the extent that Parker or its subsidiaries or authorized distributors provide component or system options based upon data or specifications provided by the user, the user is responsible for determining that such data and specifications are suitable and sufficient for all applications and reasonably foreseeable uses of the components or systems.

**Offer of Sale**

Please contact your Parker representation for a detailed "Offer of Sale".

## Table of Contents

ISO Specifications.....	4
General Applications .....	6
Flow Characteristics .....	8
Material Specification and Characteristics.....	9
Order chart.....	10
ISOMAX - ISO 15407-1 - Sizes 02 & 01.....	10
Order chart.....	12
ISOMAX - ISO 5599-1 - Sizes 1, 2 & 3 .....	12
15 mm N.C. Solenoid Operator.....	16
Subbases & Manifolds.....	20
Bottom ported manifold AND End plate.....	21
Order chart.....	24
Dimensions .....	26



If you have questions about the products contained in this catalog, or their applications, please contact:  
**Parker Hannifin EMEA Sàrl European Headquarters**  
[parker.com/msgc](http://parker.com/msgc)

# ISO SPECIFICATIONS

## Individual connection

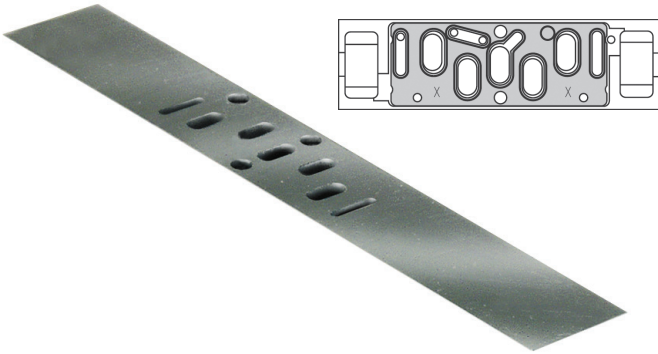

**15407-1** (VDMA 24563)  ISO 15407-1

**External electrical connection subbase valves**  
 The ISO Standard 15407-1 specifies an interface pattern for a common subbase valve consisting of pressure passages 1, 3, 5, 2 & 4 and pilot passages 12 & 14. The width of the pattern and location of the 4 bolt holes are also specified. There are no specifications for the type of external electrical connection used to control the valve.  
**Size:** 02 01

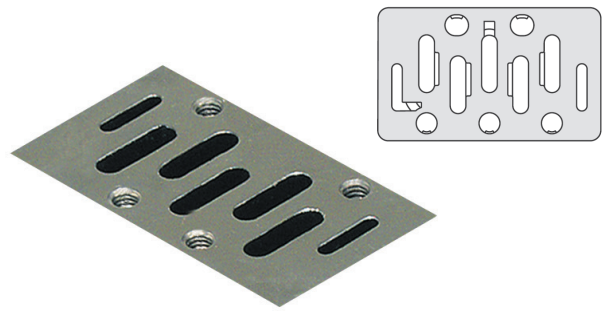

**5599-1**  ISO 5599-1

**External electrical connection subbase valves**  
 The ISO Standard 5599-1 specifies an interface pattern for a common subbase valve consisting of pressure passages 1, 3, 5, 2 & 4 and pilot passages 12 & 14. The width of the pattern and location of the 4 bolt holes are also specified. There are no specifications for the type of external electrical connection used to control the valve.  
**Size:** 1 2 3

## Plug-in connection

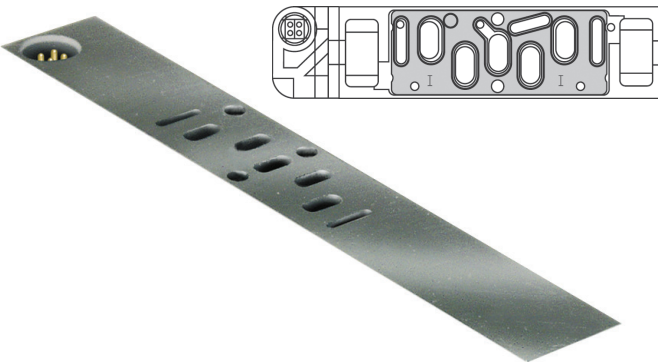

**15407-2**  ISO 15407-2

**Body-to-base plug-in subbase valves**  
 Same as 15407-1 for pneumatic pressure passages, 15407-2 standard also specifies a plug-in electrical connection.  
**Size:** 02 01

- Pin 1 = 14 solenoid
- Pin 2 = 12 solenoid
- Pin 3 = Ground +
- Pin 4 = Common -

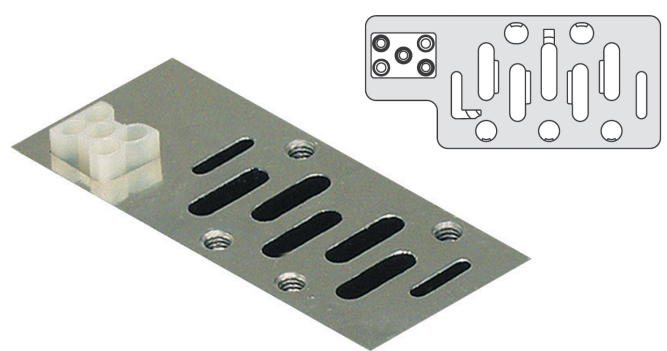
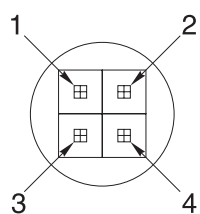

**5599-2**  ISO 5599-2

**Body-to-base plug-in subbase valves**  
 Same as 5599-1 for pneumatic pressure passages, 5599-2 standard also specifies a plug-in electrical connection.  
**Size:** 1 2 3

- 1 = 12 solenoid
- 2 = 14 solenoid
- 3 = 12 solenoid
- 4 = 14 solenoid
- 5 = Ground

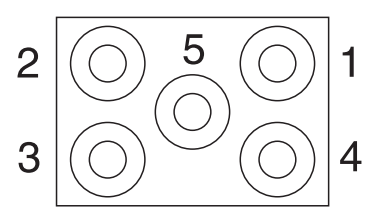

# ISO SPECIFICATIONS

## CNOMO and VDMA Standards

### CNOMO 06-05-01

The solenoid pilot interface often used with ISO 5599-1 valves is the CNOMO interface. The CNOMO interface specifies the pressure and actuator port, and the screw holes for the mounting of this solenoid pilot. It is commonly used in European automotive plants, and its usage is becoming more prevalent for industrial ISO 5599-1 valves.

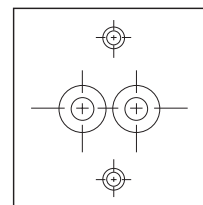

### VDMA 24345

The VDMA 24345 is a standard for Manifolds and Subbase specifying a common base mounting footprint in addition to ISO 5599-1 Interface standard. (VDMA is a German organisation - Verband Deutscher Maschinen und Anlagen-Bauer - which is translated to Federation of German Machine and Unit Builders.)

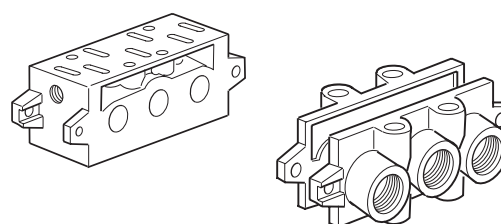

## Choice of components for air supply to cylinders

In the chart below can you find the suitable valves, tubes etc. for each cylinder size. If you have a tube length over 2 m, choose one tube size larger than in the chart.

Following data is valid:

Supply pressure: min 7,0 bar

Regulator pressure setting: 6,0 bar

Pipe length between air treatment unit and valve: max 1 m

Pipe length between valve and cylinder : max 2 m

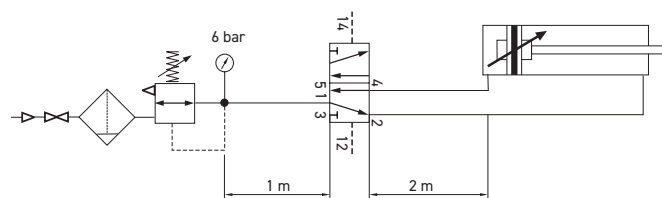

Cylinder bore	<Ø20	Ø20-32	Ø40-50	Ø63	Ø80	Ø100	Ø125	Ø160	Ø200
Cylinder port	M5	G1/8	G1/4	G3/8	G3/8	G1/2	G1/2	G3/4	G3/4
Tubing Ext/Int	4/2.7	6/4	8/6	10/7	10/7	12/9	14/11	18/15	20/18
					12/9	14/11			
Size 02	G1/8	G1/8	G1/8	G1/8					
Size 01	G1/4	G1/4	G1/4	G1/4	G1/4				
Size 1	G1/4	G1/4	G1/4	G1/4	G1/4	G1/4			
Size 2			G3/8	G3/8	G3/8	G3/8	G3/8		
Size 3				G1/2	G1/2	G1/2	G1/2	G1/2	G1/2

  Cylinder speed < 0,5 m/s

  Cylinder speed < 1 m/s

  Cylinder speed > 1 m/s

# GENERAL APPLICATIONS

## Market Application

- Automotive Handling
- Packaging
- Manufacturing
- General application

## Ceramic technology

All ISOMAX products use high-tech ceramic switching technology :

### Excellent reliability :

Long life in excess of 100 million operations\*.  
Operates with lubricated or non lubricated air.  
Low sensitivity to air quality changes ;  
switching without seal.  
Stiction free.

### High performances :

Slide valve concept allows high flow / size ratio and short response time due to short slide stroke and low friction.

### Size 02 & Size 01

Solenoid exhaust pilot

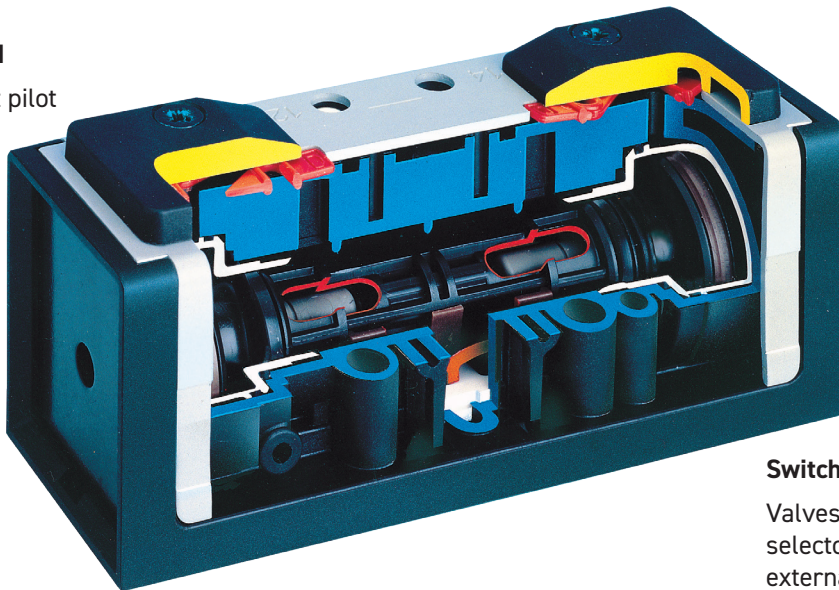

### Switchable selector

Valves fitted with switchable selector to give internal or external pilot supply

### Stable long lasting performances

Low friction switching : minimum wear of the valve member/seal assembly.

### Ceramic plate

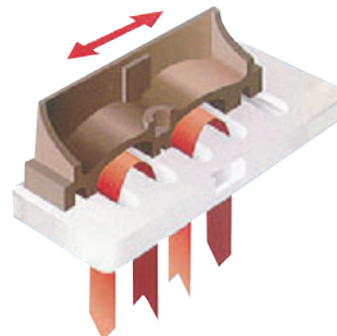

## Rust and corrosion resistant body

With the valve body in polyamide reinforced fiberglass and the casting in anodised aluminium, the Isomax range presents a comprehensive modern design to suit most industrial environments.

## Central M12 connection or M12 coil

All sizes of ISO 5599-1 are supplied with central M12 integrated connector, a M12 bridge cable or with a 30 x 30mm coil having M12 interface.

## External supply selection

In order to use actuator with low pressure, it is possible to connect an external pressure on port 14 to supply both solenoids. Selection is easily made by reversing the gasket under the operator.

## High reliability

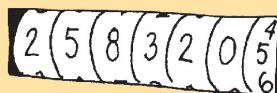

Valves easily comply with the requirements for the component reliability in accordance with EU Machinery Directive standards EN292-2 and EN983.

## Maintenance

Spares are not required for the main valve or spool but solenoid operators can be replaced if required.

## Manual Override

Solenoids are available with locking or non-locking manual overrides so that valves can be operated when the electrical supply is turned off.

## Solenoid valves, CNOMO interface, 15mm solenoid

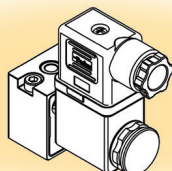

The standard valve is fitted with a 30mm solenoid having DIN 43650 Industrial form A connector for sizes 1, 2 and 3 15mm solenoid for sizes 01 and 02.

## Low noise level

Size 01 and 02 valves fitted with the 15mm solenoid option use captured pilot exhaust which is channelled through the valve body and exhausts to atmosphere through channel 12

## High electrical encapsulation class

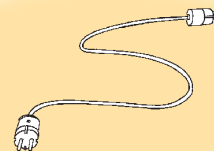

The solenoid valves are protected to IP65 with the standard cable plug. Available with DIN A or M12 connection.

## Wide choice of solenoid connectors/ cable plugs

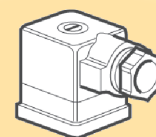

Solenoid connectors are available with or without LED and rectifier and may be selected fitted pre-wired with flying leads.

## Valves having ATEX approval

ATEX approved options are available for use in explosive atmospheres. Consult our Technical Sales Department for further information.

## Bottom or side ported manifold

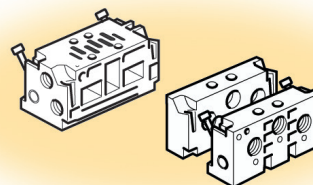

Manifolds with common ducts for ports 1,3 and 5, outlet port 2 and 4, and supply port for 12 and 14 are available side or bottom ported. Those manifolds are common for Isomax and Isys ISO.

## Subbase installation VDMA

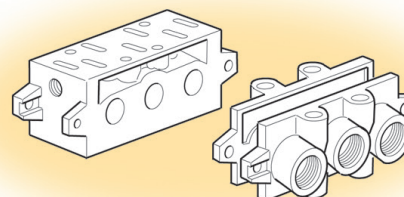

A large range of subbase, VDMA or not VDMA, bottom or side ported.

# FLOW CHARACTERISTICS

Flow capacities in accordance with ISO6358, for 5/2 function. 5/3 function are around 10 to 20% less.

## Technical Data ISOMAX Size 02

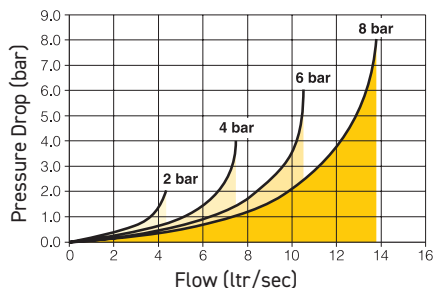

Operating pressure.	
5/2 Spring return	4,0 - 10 bar
5/2 Differential	3,0 - 10 bar
5/2 Double solenoid or pneumatic	2,0 - 10 bar
5/3 Double solenoid or pneumatic	4,0 - 10 bar
Working temperature.	-100C to + 600C
Flow (acc. to ISO 6358)	c = 1,5 NI/s x bar b = 0,25 Qn = 6,3 l/s Qmax = 10,6 l/s

## Technical Data ISOMAX Size 01

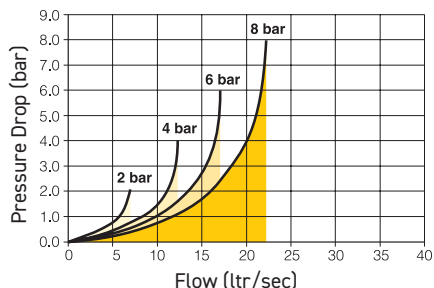

Operating pressure.	
5/2 Spring return	4,0 - 10 bar
5/2 Differential	3,0 - 10 bar
5/2 Double solenoid or pneumatic	2,0 - 10 bar
5/3 Double solenoid or pneumatic	4,0 - 10 bar
Working temperature.	-100C to + 600C
Flow (acc. to ISO 6358)	c = 2,5 NI/s x bar b = 0,25 Qn = 9,8 l/s Qmax = 17,1 l/s

## Technical Data ISOMAX Size 1

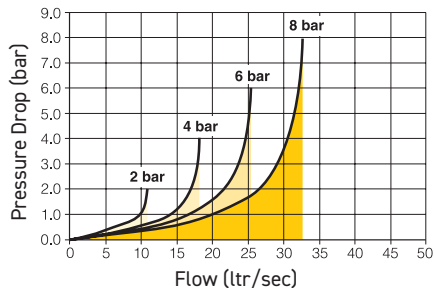

Operating pressure.	
5/2 Spring return	3,0 - 10 bar
5/2 Differential	2,0 - 10 bar
5/2 Double solenoid	1,0 - 10 bar
5/3 Double solenoid	3,5 - 10 bar
Pneumatic version	12 bar
Working temperature.	-100C to + 600C
Flow (acc. to ISO 6358)	c = 3,8 NI/s x bar b = 0,35 Qn = 17,2 l/s Qmax = 25,5 l/s

## Technical Data ISOMAX Size 2

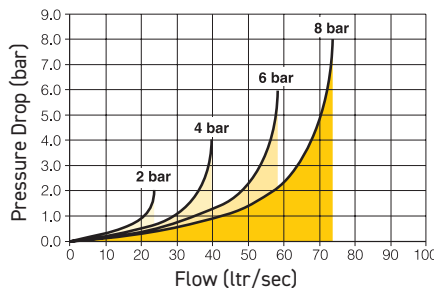

Operating pressure.	
5/2 Spring return	2,5 - 10 bar
5/2 Differential	2,0 - 10 bar
5/2 Double solenoid	1,0 - 10 bar
5/3 Double solenoid	3,0 - 10 bar
Pneumatic version	12 bar
Working temperature.	-100C to + 600C
Flow (acc. to ISO 6358)	c = 8,2 NI/s x bar b = 0,35 Qn = 38,3 l/s Qmax = 58,7 l/s

## Technical Data ISOMAX Size 3

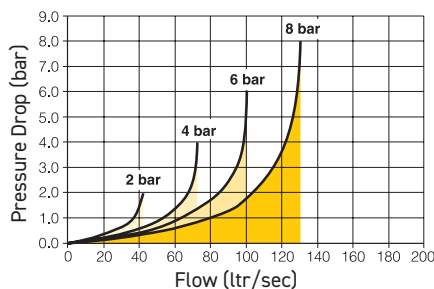

Operating pressure.	
5/2 Spring return	2,5 - 10 bar
5/2 Differential	2,0 - 10 bar
5/2 Double solenoid	1,0 - 10 bar
5/3 Double solenoid	3,0 - 10 bar
Pneumatic version	12 bar
Working temperature.	-100C to + 600C
Flow (acc. to ISO 6358)	c = 14,5 NI/s x bar b = 0,35 Qn = 64,0 l/s Qmax = 101,0 l/s

# MATERIAL SPECIFICATION AND CHARACTERISTICS

## Material Specification

Valve member - seat :	Self lubricating acetal - ceramic
Body :	Polyamide reinforced fibreglass
Casing - End plates :	Anodised aluminium - Painted zinc - Plated steel
Valve plate :	Zamak
Seals :	Nitrile
Springs :	Stainless steel
Screws :	Zinc plated steel
Top cover - Seal :	Polyamide reinforced fiberglass - Polyester

## Technical Characteristics

Fluid :	Air or inert gas filtered 40u class 5 according to ISO 8573-1 Dry class 4 according to ISO 8573-1 non-lubricated, or lubricated
Storage temperature :	-200 to + 700
Vibration :	2g - from 2 to 150 Hz according to IEC 68-2-6
Shock :	15g - 11ms according to IEC 68-2-7

## Changeover time (ms) at 6 bar - Actua. / Return

Valve Function	Solenoid Operated Valves					Pneumatic Operated Valves				
	02	01	1	2	3	02	01	1	2	3
	15/25	25/35	40/55	60/105	85/160	15/25	25/35	30/45	50/95	80/160
	15/30	20/40	30/70	55/110	80/180	15/30	20/40	25/60	45/100	70/170
	12/12	15/15	25/25	30/30	40/40	12/12	14/14	20/20	25/25	35/35
	20/60	20/60	30/95	40/190	55/330	20/50	20/50	20/80	30/170	45/330
	20/60	20/60	25/70	40/140	60/270	20/50	20/50	20/65	30/140	50/270
			25/65	40/150				20/60	25/140	

# ORDER CHART

## ISOMAX - ISO 15407-1 - Sizes 02 & 01

### Pneumatic remote pilot or 15 mm DIN C solenoid valve operated



For Electro-Pneumatic pilot valve only  
Solenoid valve operator definition

**DX** **01** - **6** **21** - **95** **1** **M** **S**

Size	
02	Size 02 : 18 mm
01	Size 01 : 26 mm

Pilot	
4	Pneumatic
6	Electro-Pneumatic

Valve type function	
Internal pilot supply / Capture exhaust 12	
06	5/2 double solenoid
56	5/2 double solenoid, 14 prioritised
21	5/2 single solenoid, spring return
51	5/2 single solenoid, differential return
11	5/3 double solenoid vented centre
16	5/3 double solenoid closed centre
External pilot 14 supply / Capture exhaust 12	
05	5/2 double solenoid
59	5/2 double solenoid, 14 prioritised
23	5/2 single solenoid, spring return
54	5/2 single solenoid, differential return
09	5/3 double solenoid vented centre
19	5/3 double solenoid closed centre

Connector	
Blank	Without any
C	Standard connector No cable
S	Connector with LED and protection - No cable
S3	Connector with LED and protection - 3 m cable
S5	Connector with LED and protection - 5 m cable

Voltage	
L	12 Vdc
M	12 Vdc
N	12 Vdc
C	24 Vac - 50 Hz
D	48 Vac - 50/60 Hz
J	110 Vac - 50/60 Hz
A	230 VAC - 50/60 Hz

Manual override	
0	Without any
1	Flush non locking
2	Flush non locking (extended 15 mm)
3	Flush locking
5	Flush locking (extended 15 mm)

Operator	
For pneumatic pilot valve	
60	Remote pneumatic pilot operated
For electro-pneumatic pilot valve	
60	Without 15 mm solenoid valve operator*
95	15 mm solenoid valve operator - DIN 43650 Form C

\* 15 mm solenoid valve operator to be ordered separately

Shaded part numbers constituted with shaded voltage code are available from stock.

Shaded part numbers constituted by unshaded voltage code are available on request but are subject to a minimum order quantity. Otherwise, select « Blank » as voltage code and order coil separately.

# ISO 15407-1 Sizes 02 & 01

## Pneumatic remote pilot operated

Without valve spool manual override

	Symbol	Description	Size	Weight (g)	Order code
		5/2 Air pilot - Spring return	02 - 18 mm	90	DX02-421-60
			01 - 26mm	130	DX01-421-60
		5/2 Air pilot - Differential	02 - 18 mm	90	DX02-451-60
			01 - 26mm	130	DX01-451-60
		5/2 Double air pilot	02 - 18 mm	90	DX02-406-60
			01 - 26mm	130	DX01-406-60
		5/3 Closed Centre	02 - 18 mm	90	DX02-416-60
			01 - 26mm	130	DX01-416-60
		5/3 Vented Center	02 - 18 mm	90	DX02-411-60
			01 - 26mm	130	DX01-411-60

## 15 mm DIN C / 24 Vdc / 1,2 W solenoid valve operator

	Symbol	Description	Size	Weight (g)	Order code
		5/2 Single solenoid - Spring return	02 - 18 mm	130	DX02-621-951M
			01 - 26mm	170	DX01-621-951M
		5/2 Single solenoid - Differential	02 - 18 mm	130	DX02-651-951M
			01 - 26mm	170	DX01-651-951M
		5/2 Double solenoid	02 - 18 mm	130	DX02-606-951M
			01 - 26mm	170	DX01-606-951M
		5/3 Closed Centre	02 - 18 mm	130	DX02-616-951M
			01 - 26mm	170	DX01-616-951M
		5/3 Vented Center	02 - 18 mm	160	DX02-611-951M
			01 - 26mm	170	DX01-611-951M

Solenoid connectors & cable plugs to be ordered separately. See solenoid section

## Without 15 mm DIN C solenoid valve operator

	Symbol	Description	Size	Weight (g)	Order code
		5/2 Single solenoid - Spring return	02 - 18 mm	130	DX02-621-60
			01 - 26mm	170	DX01-621-60
		5/2 Single solenoid - Differential	02 - 18 mm	130	DX02-651-60
			01 - 26mm	170	DX01-651-60
		5/2 Double solenoid	02 - 18 mm	130	DX02-606-60
			01 - 26mm	170	DX01-606-60
		5/3 Closed Centre	02 - 18 mm	130	DX02-616-60
			01 - 26mm	170	DX01-616-60
		5/3 Vented Center	02 - 18 mm	160	DX02-611-60
			01 - 26mm	170	DX01-611-60

15mm solenoid valve operator, solenoid connectors & cable plug to be ordered separately. See solenoid section

# ORDER CHART

## ISOMAX - ISO 5599-1 - Sizes 1, 2 & 3

### Pneumatic remote pilot or CNOMO operator - DIN or M12 connection



For Electro-Pneumatic pilot valve only  
Solenoid valve operator definition

**DX** **1** - **6** **51** - **B** **L** **49**

Size	
1	Size 1
2	Size 2
3	Size 3

Pilot	
4	Pneumatic
6	Electro-Pneumatic

Valve type function	
Internal pilot supply	
06	5/2 double solenoid
56	5/2 double solenoid, 14 prioritised
21	5/2 single solenoid, spring return
51	5/2 single solenoid, differential return
11	5/3 double solenoid vented centre
13	5/3 double solenoid pressurised center *
16	5/3 double solenoid closed centre
External pilot 14 supply / Capture exhaust 12	
05	5/2 double solenoid
59	5/2 double solenoid, 14 prioritised
23	5/2 single solenoid, spring return
54	5/2 single solenoid, differential return
09	5/3 double solenoid vented centre
14	5/3 double solenoid pressurised center *
19	5/3 double solenoid closed centre

\*) Variant not available for Size 3

Voltage	
Blank	Operator only (without coil)
M12 connector	
19	24 Vdc
DIN connector	
45	12 Vdc
49	24 Vdc
40	12 Vac - 50/60 Hz
42	24 Vac - 50/60 Hz
53	110 Vac - 50Hz / 120 Vac - 60Hz
57	230 Vac - 50/60 Hz

Solenoid enclosure	
CNOMO 30 x 30 Operator for Low Power Coil	
L	Operator with coil
N	Operator only without coil
M12 connector	
A	One connector per distributor
C	One built-in connector per coil

Manual override	
On Pneumatic Valves or Electric Valves without operator	
60	Without direct spool override
70	With direct spool override
On electric operator *	
A	Without any
B	Non locking - Flush - Metal
C	Locking - Flush - Plastic

\* Without direct valve spool manual override



Shaded part numbers constituted with shaded voltage code are available from stock.

Shaded part numbers constituted by unshaded voltage code are available on request but are subject to a minimum order quantity. Otherwise, select « Blank » as voltage code and order coil separately.

# ISO 5599-1 Sizes 1, 2 & 3

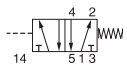
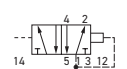
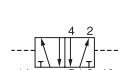

## Pneumatic remote pilot operated

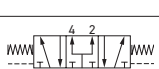
With direct valve spool manual override

Symbol	Description	Size	Weight (g)	Order code
	5/2 Air pilot - Spring return	1 - 43 mm	350	DX1-421-70
		2 - 56 mm	600	DX2-421-70
		3 - 71 mm	1100	DX3-421-70
	5/2 Air pilot - Differential	1 - 43 mm	350	DX1-451-70
		2 - 56 mm	600	DX2-451-70
		3 - 71 mm	1100	DX3-451-70
	5/2 Double air pilot	1 - 43 mm	350	DX1-406-70
		2 - 56 mm	600	DX2-406-70
		3 - 71 mm	1100	DX3-406-70
	5/3 Closed Centre	1 - 43 mm	350	DX1-416-70
		2 - 56 mm	600	DX2-416-70
		3 - 71 mm	1100	DX3-416-70
	5/3 Vented Center	1 - 43 mm	350	DX1-411-70
		2 - 56 mm	600	DX2-411-70
		3 - 71 mm	1100	DX3-411-70
	5/3 Pressurised Center	1 - 43 mm	350	DX1-413-70
		2 - 56 mm	600	DX2-413-70

## Pneumatic remote pilot operated

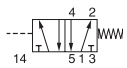
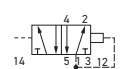
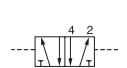

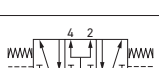
Without direct valve spool manual override

Symbol	Description	Size	Weight (g)	Order code
	5/2 Air pilot - Spring return	1 - 43 mm	350	DX1-421-60
		2 - 56 mm	600	DX2-421-60
		3 - 71 mm	1100	DX3-421-60
	5/2 Air pilot - Differential	1 - 43 mm	350	DX1-451-60
		2 - 56 mm	600	DX2-451-60
		3 - 71 mm	1100	DX3-451-60
	5/2 Double air pilot	1 - 43 mm	350	DX1-406-60
		2 - 56 mm	600	DX2-406-60
		3 - 71 mm	1100	DX3-406-60
	5/3 Closed Centre	1 - 43 mm	350	DX1-416-60
		2 - 56 mm	600	DX2-416-60
		3 - 71 mm	1100	DX3-416-60
	5/3 Vented Center	1 - 43 mm	350	DX1-411-60
		2 - 56 mm	600	DX2-411-60
		3 - 71 mm	1100	DX3-411-60
	5/3 Pressurised Center	1 - 43 mm	350	DX1-413-60
		2 - 56 mm	600	DX2-413-60

## ISO 5599-1 Sizes 1, 2 & 3

### CNOMO operator with 30 x 30 DIN Form A / 24 Vdc / 2,7 W solenoid



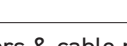

With non locking manual override on solenoid valve operator - Without direct valve spool manual override

Symbol	Description	Size	Weight (g)	Order code
	5/2 Single solenoid - Spring return	1 - 43 mm	500	DX1-621-BL49
		2 - 56 mm	750	DX2-621-BL49
		3 - 71 mm	1250	DX3-621-BL49
	5/2 Single solenoid - Differential	1 - 43 mm	500	DX1-651-BL49
		2 - 56 mm	750	DX2-651-BL49
		3 - 71 mm	1250	DX3-651-BL49
	5/2 Double solenoid	1 - 43 mm	650	DX1-606-BL49
		2 - 56 mm	900	DX2-606-BL49
		3 - 71 mm	1400	DX3-606-BL49
	5/3 Closed Center	1 - 43 mm	560	DX1-616-BL49
		2 - 56 mm	900	DX2-616-BL49
		3 - 71 mm	1400	DX3-616-BL49
	5/3 Vented Center	1 - 43 mm	650	DX1-611-BL49
		2 - 56 mm	900	DX2-611-BL49
		3 - 71 mm	1400	DX3-611-BL49
	5/3 Pressurised Center	1 - 43 mm	650	DX1-613-BL49
		2 - 56 mm	900	DX2-613-BL49

Solenoid connectors & cable plug to be ordered separately. See solenoid section

### CNOMO operator without coil

With non locking manual override on solenoid valve operator - Without direct valve spool manual override

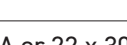

Symbol	Description	Size	Weight (g)	Order code
	5/2 Single solenoid - Spring return	1 - 43 mm	400	DX1-621-BN
		2 - 56 mm	650	DX2-621-BN
		3 - 71 mm	1150	DX3-621-BN
	5/2 Single solenoid - Differential	1 - 43 mm	400	DX1-651-BN
		2 - 56 mm	650	DX2-651-BN
		3 - 71 mm	1150	DX3-651-BN
	5/2 Double solenoid	1 - 43 mm	550	DX1-606-BN
		2 - 56 mm	800	DX2-606-BN
		3 - 71 mm	1300	DX3-606-BN
	5/3 Closed Center	1 - 43 mm	550	DX1-616-BN
		2 - 56 mm	800	DX2-616-BN
		3 - 71 mm	1300	DX3-616-BN
	5/3 Vented Center	1 - 43 mm	550	DX1-611-BN
		2 - 56 mm	800	DX2-611-BN
		3 - 71 mm	1300	DX3-611-BN
	5/3 Pressurised Center	1 - 43 mm	550	DX1-613-BN
		2 - 56 mm	800	DX2-613-BN

30 x 30 DIN Form A or 22 x 30 DIN Form B coil & coil connectors to be ordered separately. See solenoid section

# ISO 5599-1 Sizes 1, 2 & 3

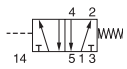
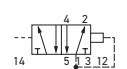
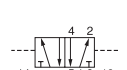

## Valve alone without operator

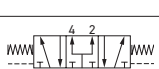
With direct valve spool manual override

Symbol	Description	Size	Weight (g)	Order code
	5/2 Single solenoid - Spring return	1 - 43 mm	350	DX1-621-70
		2 - 56 mm	600	DX2-621-70
		3 - 71 mm	1100	DX3-621-70
	5/2 Single pilot - Differential	1 - 43 mm	350	DX1-651-70
		2 - 56 mm	600	DX2-651-70
		3 - 71 mm	1100	DX3-651-70
	5/2 Double pilot	1 - 43 mm	350	DX1-606-70
		2 - 56 mm	600	DX2-606-70
		3 - 71 mm	1100	DX3-606-70
	5/3 Closed Center	1 - 43 mm	350	DX1-616-70
		2 - 56 mm	600	DX2-616-70
		3 - 71 mm	1100	DX3-616-70
	5/3 Vented Center	1 - 43 mm	350	DX1-611-70
		2 - 56 mm	600	DX2-611-70
		3 - 71 mm	1100	DX3-611-70
	5/3 Pressurised Center	1 - 43 mm	350	DX1-613-70
		2 - 56 mm	600	DX2-613-70

## Valve alone without operator

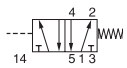
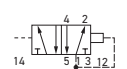
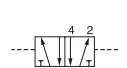
Without direct valve spool manual override

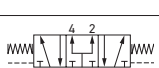
Symbol	Description	Size	Weight (g)	Order code
	5/2 Single solenoid - Spring return	1 - 43 mm	350	DX1-621-60
		2 - 56 mm	600	DX2-621-60
		3 - 71 mm	1100	DX3-621-60
	5/2 Single solenoid - Differential	1 - 43 mm	350	DX1-651-60
		2 - 56 mm	600	DX2-651-60
		3 - 71 mm	1100	DX3-651-60
	5/2 Double solenoid	1 - 43 mm	350	DX1-606-60
		2 - 56 mm	600	DX2-606-60
		3 - 71 mm	1100	DX3-606-60
	5/3 Closed Center	1 - 43 mm	350	DX1-616-60
		2 - 56 mm	600	DX2-616-60
		3 - 71 mm	1100	DX3-616-60
	5/3 Vented Center	1 - 43 mm	350	DX1-611-60
		2 - 56 mm	600	DX2-611-60
		3 - 71 mm	1100	DX3-611-60
	5/3 Pressurised Center	1 - 43 mm	350	DX1-613-60
		2 - 56 mm	600	DX2-613-60

# 15 MM N.C. SOLENOID OPERATOR

## DIN Form C for ISOMAX 15407-1 Sizes 02 & 01

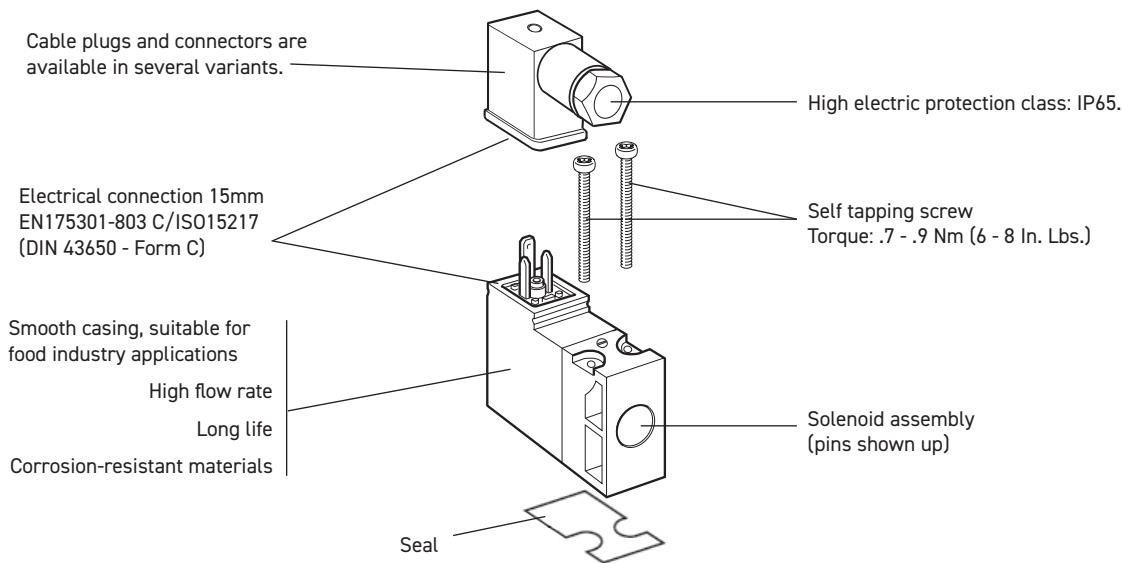

### Technical data

	NC, Standard	NC, Food1)	NC, Mobile2)
Working pressure	0 to 10 bar	0 to 10 bar	0 to 10 bar
Working temperature	-15 °C to +60 °C	-15 °C to +60 °C	-40 °C to +70 °C
Orifice	1,0 mm	1,0 mm	1,0 mm
Flow Qmax	33 NI/min	33 NI/min	22 NI/min
Power, hold	DC 1,2 W / AC 1,6 VA *	DC 1,2 W / AC 1,6 VA *	DC 1,4 W
Power, surge	DC 1,2 W / AC 3,5 VA *	DC 1,2 W / AC 3,5 VA *	DC 1,4 W
Connection time	100%	100%	100%
Voltage tolerance	+10%/-15%	+10%/-15%	+25%/-30%
Electric connection:	Form C/ISO15217		
Port pattern:	To future CNOMO standard		
Protection:	IP 65		
Approval:	Some valves are UL 429 recognised and marked with the following symbol 		
Working media:	All neutral media, such as compressed air, water, hydraulic oil and many gases.		
1) Design:	Completely smooth exterior, suitable for food industry.		
2) Mobile standard	According to European standard EN 50 155.		

\* Power, hold for 230VAC 2.4VA  
Power, surge for 230VAC 5.5VA

### Transients

Interrupting the current through the solenoid coil produces momentary voltage peaks which, under unfavourable conditions, can amount to several hundred times the rated operating voltage. Normally, these transients do not cause problems, but to achieve the maximum life of relays in the circuit (and particularly of transistors, thyristors and integrated circuits) it is desirable to provide protection by means of voltage-dependent resistors (varistors). All cable plugs with a yellow LED also incorporate such protection.

### Service life

With compressed air at 6 bar, 20 °C and complying with the requirements for compressed air quality as set out in ISO8573-1 norm (class 4 for dry and class 5 for filtered air), the valves should have a life of at least 50 million cycles.

### Materials

#### Operator

Body, coil casing	Thermoplastic
Internal metal parts	Steel
Screws	Stainless steel
Bottom plug	Thermoplastic
Sealing materials	FPM (Viton™) and nitrile rubber

#### Cable head

Sheath	Thermoplastic
Retaining screw	Stainless steel, zinc-plated steel

## 15mm DIN Form C (8mm spacing) pilot solenoid valve

For use with 15mm pilot solenoid valve PVL-B2 body

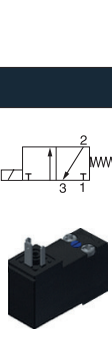
	Voltage	W (g)	Order code	Flush (Not Extended)		Extended	
				Blue Override, non locking	Yellow Override, Locking	Blue Override, non locking	Yellow Override, Locking
	12 Vdc	38	P2E-KV32B0	P2E-KV32B1	P2E-KV32B2	P2E-KV32B3	P2E-KV32B4
	24 Vdc	38	P2E-KV32C0	P2E-KV32C1	P2E-KV32C2	P2E-KV32C3	P2E-KV32C4
	48 Vdc	38	P2E-KV32D0	P2E-KV32D1	P2E-KV32D2	P2E-KV32D3	P2E-KV32D4
	24 Vac 50Hz	38	P2E-KV31C0	P2E-KV31C1	P2E-KV31C2	P2E-KV31C3	P2E-KV31C4
	48 Vac 50/60Hz	38	P2E-KV34D0	P2E-KV34D1	P2E-KV34D2	P2E-KV34D3	P2E-KV34D4
	115 Vac 50Hz	38	P2E-KV31F0	P2E-KV31F1	P2E-KV31F2	P2E-KV31F3	P2E-KV31F4
	120 Vac 60 Hz						
	230 Vac 50Hz	38	P2E-KV31J0	P2E-KV31J1	P2E-KV31J2	P2E-KV31J3	P2E-KV31J4
240 Vac 60 Hz							

## 15 mm N.C. Solenoid Operator - Mobile version

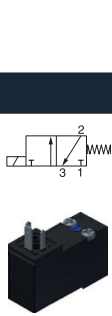
	Voltage	W (g)	Order code	Not Extended
				Blue Override non locking flush
	12 Vdc	38	P2E-MV35B0	P2E-MV35B1
	24 Vdc	38	P2E-MV35C0	P2E-MV35C1
	37.5 Vdc	38	P2E-MV35W0	P2E-MV35W1
	48 Vdc	38	P2E-MV35D0	P2E-MV35D1
	72 Vdc	38	P2E-MV35T0	P2E-MV35T1
	78 Vdc	38	P2E-MV35Y0	P2E-MV35Y1
	96 Vdc	38	P2E-MV35V0	P2E-MV35V1
	110 Vdc	38	P2E-MV35E0	P2E-MV35E1

### Suppressor and LED indicators

For 8 mm solenoid pin spacing -

For mounting between the solenoid valve and the cable plug

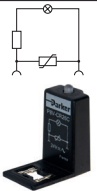
Description	Electrical voltage	W (g)	Order code
	24 VAC/DC	3	P8V-CR26C
	115 VAC 50 Hz	3	P8V-CR24F
	120 VAC 60 Hz		
	230 VAC 50 Hz	3	P8V-CR24J
	240 VAC 60 Hz		

Mounting screws included with the solenoid valve operator

## 15 mm N.C. Solenoid Operator - Food Industry version

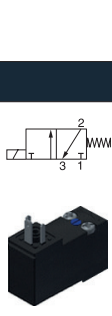
	Voltage	W (g)	Order code	Flush (Not Extended)		Extended	
				Blue Override, non locking	Yellow Override, Locking	Blue Override, non locking	Yellow Override, Locking
	24 Vdc	38	P2E-QV32C0	P2E-QV32C1	P2E-QV32C2	P2E-QV32C3	P2E-QV32C4
	48 Vdc	38	P2E-QV32D0	P2E-QV32D1	P2E-QV32D2		
	24 Vac 50 Hz	38	P2E-QV31C0	P2E-QV31C1	P2E-QV31C2	P2E-QV31C3	P2E-QV31C4
	48 Vac 50/60Hz	38	P2E-QV34D0	P2E-QV34D1	P2E-QV34D2		
	115 Vac 50Hz/120 Vac 60Hz	38	P2E-QV31F0	P2E-QV31F1	P2E-QV31F2	P2E-QV31F3	P2E-QV31F4
	230 Vac 50Hz	38	P2E-QV31J0	P2E-QV31J1	P2E-QV31J2	P2E-QV31J3	P2E-QV31J4
	240 Vac 60Hz/						

Mounting screws included with the solenoid valve operator

## Solenoid Connectors 15 mm DIN Form C / ISO15217

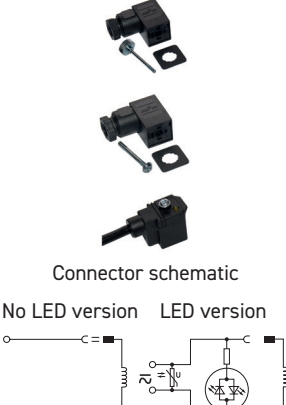
	Description	Characteristic	Visualisation	Cable length	W (g)	Order code
 <p>Connector schematic</p> <p>No LED version    LED version</p>	With large headed screw suitable for mounting in inaccessible or recess position	Standard IP65	No LED	No cable	20	P8C-C
			24 Vdc LED	No cable	20	P8C-C26C
			110 Vac LED	No cable	20	P8C-C21E
	With standard screw	Standard IP65	No LED	No cable	15	P8C-D
				2 meters	115	P8L-C2
				5 meters	240	P8L-C5
			24 Vdc/Vac LED	No cable	15	P8C-D26C
				2 meters	170	P8L-C226C
				5 meters	240	P8L-C526C
			110 Vac LED	No cable	115	P8L-CA26C
				2 meters	115	P8L-C221E
				5 meters	230	P8L-C521E

In accordance with the EU Machine Directive, EN 983, solenoid valves with manual override should have spring-return operating arms for safety.

## 3/2 N.C. CNOMO Operator for 30 x 30 DIN Form A or 22 x 30 DIN Form B coils

3/2 N.C. CNOMO Operator  
for 30 x 30 DIN Form A Coil  
Low Power

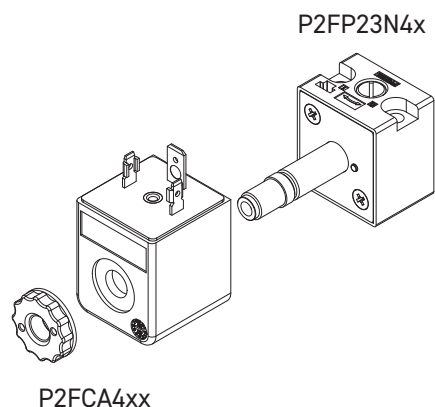

3/2 N.C. CNOMO Operator  
for 30 x 30 DIN Form A Coil  
High Power

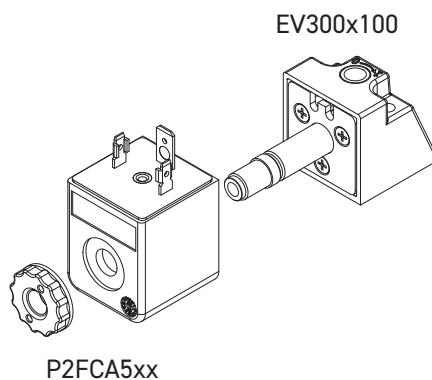

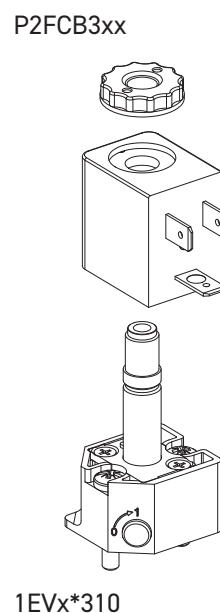

3/2 N.C. CNOMO Operator  
for 22 x 30 DIN Form B Coil  
Low Power



## Technical data - Solenoid operator & Coil combinations

		3/2 N.C. CNOMO Operators		
		30 x 30 DIN Form A Coil		22 x 30 DIN Form B Coil
		Low Power	High Power	Low Power
Working pressure		0 to 10 bar		
Ambient temperature		-10°C to 60°C (1)	-10°C to 60°C (1)	-25°C to 60°C (1)
Orifice		1.3/1.5mm	1.3/1.5mm	1.2/1.3mm
Nominal Flow Qn		0.84 dm <sup>3</sup> /s	0.84 dm <sup>3</sup> /s	0.7 dm <sup>3</sup> /s
Power	AC Voltages	2,5W	4,5W	3 W
	DC Voltages	3VA	5VA	50 Hz : 5 VA / 60 Hz : 4,2 VA
Voltage tolerance		+/- 10%		
Duty cycle		100%		
Insulation class		F		
Electric connection		DIN A		DIN B
Protection IP65		IP65		
Shock		According to IEC 68-2-6 (2G - from 2 to 150 Hz)		
Vibration		According to IEC 68 - 2 - 7 (15G - 11 m/s)		
Working media		All neutral media such as compressed air and inert gases		

### 3/2 N.C. CNOMO Operator - Without Coil

Description		Manual override	W (g)	Order code
	Solenoid operator for 30 x 30 DIN Form A Coil Dedicated to Low Power 2,5W / 3VA Coil	No manual override	65	P2FP23N4A
		Pulse non locking	65	P2FP23N4B
		Locking	65	P2FP23N4C
	Solenoid operator for 30 x 30 DIN Form A Coil Dedicated to High Power 4,5W / 5VA Coil	No manual override	65	EV3000100
		Pulse non locking	65	EV3001100
		Locking	65	EV3003100
	Solenoid operator for 22 x 30 DIN Form B Coil Dedicated to Low Power 2,5W / 4,5VA Coil	No manual override	65	1EV0*310
		Pulse non locking	65	1EV1*310
		Locking	65	1EV3*310



### 30 x 30 DIN Form A and 22 x 30 DIN Form B Coils for CNOMO Operator

	30 x 30 DIN Form A			22 x 30 DIN Form B		
	Voltage	W (g)	Order code	Order code	W (g)	Order code
	12 Vdc	105	P2FCA445	P2FCA545	93	P2FCB345
	24 Vdc	105	P2FCA449	P2FCA549	93	P2FCB349
	48 Vdc	105	P2FCA453	P2FCA551	93	P2FCB351
	12 Vac 50/60 Hz	105	P2FCA440	P2FCA540	93	P2FCB340
	24 Vac 50/60 Hz	105	P2FCA445	P2FCA545	93	P2FCB345
	48 Vac 50/60 Hz	105	P2FCA449	P2FCA549	93	P2FCB349
	110 Vac 50 Hz / 120 Vac 60 Hz	105	P2FCA453	P2FCA553	93	P2FCB353
	230 Vac 50 Hz / 240 Vac 60 Hz	105	P2FCA457	P2FCA557	93	P2FCB357

### Spare Solenoid Nuts

Description	Usage	W (g)	Order code
 Plastic knurled nut	For valve requiring Captured exhaust	5	P2FNPA
Diffuser plastic nut	For valve requiring Vented exhaust	5	P2FNDA

### 30 x 30 DIN Form A and 22 x 30 DIN Form B Solenoid Connectors

Description	Characteristic	Visualisation	Cable length	W (g)	Order code	
	30 x 30 DIN Form A connector With standard screw	Standard IP65	No LED	No cable	15	3EV290V10
			24 Vdc/Vac LED	No cable	30	3EV290V20-24
				5 meters	355	3EV290V20-24L5
			110 Vac LED	No cable	30	3EV290V20-110
				5 meters	470	3EV290V20-110L5
			230 Vac LED	No cable	30	3EV290V20-230
5 meters	350	3EV290V20-230L5				
 Connector schematic No LED version    LED version	22 x 30 DIN Form B connector With standard screw	Standard IP65	No LED	No cable	15	3EV10V10
			24 Vdc/Vac LED	No cable	20	3EV10V20-24
				5 meters	350	3EV10V20-24L5
			110 Vac LED	No cable	25	3EV10V20-110
				5 meters	355	3EV10V20-110L5
			230 Vac LED	No cable	25	3EV10V20-230
5 meters	360	3EV10V20-230L5				

### M12 Adaptor for 30 x 30 DIN Form A Coil

Description	Characteristics	Visualisation	Cable	W (g)	Order code
 M12 Connector for one coil	24 V AC/DC - 4A	LED	No cable	30	P8C-A626C
M12 Connector for two coils*	24 V AC/DC - 4A	LED	No cable	70	P8C-AM26C

\* : Not compatible with Size 3 Valves (DX3)

**Note:** Solenoid pilot operators are fitted to the ISO valve range. Order the above part numbers for spares.

The operators are supplied with mounting screws and interface 'O' rings.

**Coils and connectors must be ordered separately.**

# SUBBASES & MANIFOLDS

## ISO 15407-1

### Side ported individual subbase - ISO 15407-1 - Sizes 02 & 01

	Description	Size	Port Size	W (g)	Order code
	<b>Individual Subbase</b> Can be used for External pilot supply or Single or Double pneumatic remote pilot	02 - 18 mm	1/8 BSPP	70	PL02-01-70
			1/8 NPT	70	PL02-01-80
		01 - 26 mm	1/4 BSPP	120	PL01-02-70
			1/4 NPT	120	PL01-02-80

### Front ported manifold & End plate - ISO 15407-1 - Sizes 02 & 01

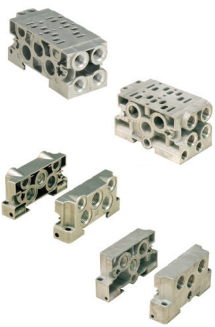
	Description	Size	Port Size	W (g)	Order code
	<b>Two position manifold base</b> Can be used for External pilot supply Cannot be used for remote pilot	02 - 18 mm	1/8 BSPP	140	PJLP02-201-70
			1/8 NPT	140	PJLP02-201-80
		01 - 26 mm	1/4 BSPP	700	PJLP01-202-70
			1/4 NPT	700	PJLP01-202-80
	<b>Two position manifold base</b> Can be used for External pilot supply using #14 or Single or Double pneumatic remote pilot	01 - 26 mm	1/4 BSPP	730	PJL01-202-70
			1/4 NPT	730	PJL01-202-80
	<b>End plate kit</b>	02 - 18 mm	1/4 BSPP	150	PEJ02-02-70
			1/4 NPT	150	PEJ02-02-80
01 - 26 mm		3/8 BSPP	520	PEJ01-03-70	
		3/8 NPT	520	PEJ01-03-80	

### Accessories

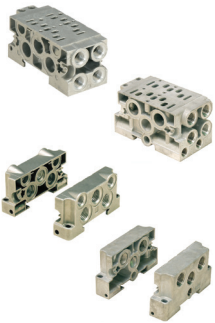
	Description	Size	W (g)	Order code	
	<b>Blanking plate</b>	02 - 18 mm	40	DX02BLK	
		01 - 26 mm	50	DX01BLK	
	<b>Blanking plug</b>	02 - 18 mm	10	D02BD0	
		01 - 26 mm	20	D01BD0	
	<b>Front Ported Manifold</b> Assembling Kit Including 10 Bolts, 10 Washers & 10 Nuts	02 - 18 mm & 01 - 26 mm		120	DX02M2MB

# BOTTOM PORTED MANIFOLD AND END PLATE

## ISO 15407-1 - Sizes 02 & 01

Description		Size	Port Size	Weight (g)	Order code		
	<b>Two valve position manifold</b>	Int. pilot supply	02 - 18 mm	1/8 BSPP	200	P2V-AM511PB	
			01 - 26 mm	1/4 BSPP	400	P2V-BM512PB	
		Including seal, fitting screws and plugs.	Ext. pilot supply	02 - 18 mm	1/8 BSPP	200	P2V-AM511NB
				01 - 26 mm	1/4 BSPP	400	P2V-BM512NB
	<b>Side ported</b>	Left end plate Including seal and fitting screws	02 - 18 mm	1/4 BSPP	180	P2V-AM512GS	
			01 - 26 mm	3/8 BSPP	210	P2V-BM513GS	
		Right end plate	02 - 18 mm	1/4 BSPP	180	P2V-AM512HS	
			01 - 26 mm	3/8 BSPP	210	P2V-BM513HS	
	<b>Top ported</b>	Left end plate Including seal and fitting screws	02 - 18 mm	1/4 BSPP	180	P2V-AM512GT	
			01 - 26 mm	3/8 BSPP	210	P2V-BM513GT	
		Right end plate	02 - 18 mm	1/4 BSPP	180	P2V-AM512HT	
			01 - 26 mm	3/8 BSPP	210	P2V-BM513HT	
	<b>Bottom ported</b>	Left end plate Including seal and fitting screws	02 - 18 mm	1/4 BSPP	180	P2V-AM512GB	
			01 - 26 mm	3/8 BSPP	220	P2V-BM513GB	
		Right end plate	02 - 18 mm	1/4 BSPP	180	P2V-AM512HB	
			01 - 26 mm	3/8 BSPP	220	P2V-BM513HB	
<b>End cover</b>	Left end plate Including seal and fitting screws	02 - 18 mm		190	P2V-AM500G0		
		01 - 26 mm		240	P2V-BM500G0		
	Right end plate	02 - 18 mm		190	P2V-AM500H0		
		01 - 26 mm		240	P2V-BM500H0		
<b>Size manifolds adaptor plate</b>		01 to 02		330	P2V-AM500BE		
<b>Plug</b>	Left end plate	02 - 18 mm		4	P2V-AK0P		
		01 - 26 mm		10	P2V-BK0P		

# SUBBASES & MANIFOLDS

## ISO 5599-1

### VDMA Side Ported Subbases

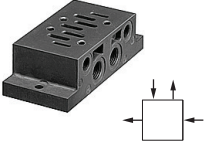
	Description	Size	Port Size	Weight (g)	Order code
	<b>Subbases VDMA</b> Side port according to VDMA	1 - 43mm	G1/4	160	P2N-VS512SD
		2 - 56mm	G3/8	280	P2N-WS513SD
		3 - 71mm	G1/2	350	P2N-YS514SD

### VDMA Bottom Ported Manifold

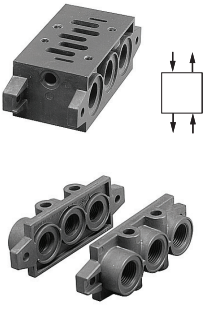
	Description	Size	Port Size	Weight (g)	Order code
	<b>VDMA Form C</b> Bottom port according to VDMA	1 - 43mm	G1/4	240	P2N-VM512MB
		2 - 56mm	G3/8	360	P2N-WM513MB
		3 - 71mm	G1/2	700	P2N-YM514MB
	<b>VDMA Transition plate</b> Size 1 to Size 3 <b>Kit includes:</b> Transition plate only	1 to 3	G1/4		P2N-VM500AK
	<b>VDMA Form D - End plate</b> According to VDMA	1 - 43mm	G3/8	210	P2N-VM513ES
		2 - 56mm	G1/2	360	P2N-WM514ES
		3 - 71mm	G1	680	P2N-YM518ES
	<b>VDMA Isolation - Main galley</b> According to VDMA <b>Kit includes:</b> (1) Isolator plug.	1 - 43mm			P2N-VK0P
		2 - 56mm			P2N-WK0P
		3 - 71mm			P2N-YK0P

### Accessories

	Description	Size	Port Size	Weight (g)	Order code
	<b>Blanking plate</b> <b>Kit includes:</b> (1) Blanking plate, (1) Gasket and (4) Mounting bolts	1 - 43mm	G1/4	100	P2N-AA5B
		2 - 56mm	G3/8	150	P2N-BA5B
		3 - 71mm	G1/2	200	P2N-CA5B



## Side ported subbases

	Description	Size	Port Size	Weight (g)	Order code BSP	Order code NPT
	<b>Single subbase</b> 1 3 5 2 4 ports & 12 14	1 - 43mm	G1/4	160	PL1-1/4-70	PL1-1/4-80
			G3/8	160	PL1-3/8-70	
		2 - 56mm	G3/8	280	PL2-3/8-70	PL2-3/8-80
			G1/2		P2N-HS514SS	
		3 - 71mm	G1/2		PL3-1/2-70	PL3-1/2-80
	G3/4		P2N-JS516SD			

## Bottom ported subbases

	Description	Size	Port Size	Weight (g)	Order code BSP	Order code NPT
	<b>Single subbase</b> 1 3 5 2 4 ports & 12 14	1 - 43mm	G1/4	370	PL1-1/4-70	PD1-1/4-80
		2 - 56mm	G3/8	590	PL2-3/8-70	PD2-3/8-80
		3 - 71mm	G1/2	590	PL3-1/2-70	

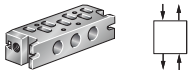
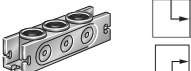
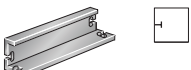
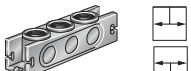
## Size 1 bottom ported manifold

	Description	Size	Port Size	Weight (g)	Order code
	<b>Single subbase</b> 1 3 5 2 4 ports & 12 14	1 - 43mm	G1/4	20	P2N-AM512MB
	<b>Single subbase</b> 1 3 5 2 4 ports & 12 14	1 - 43mm	G3/8	150	P2N-AM513GT
	<b>Single subbase</b> 1 3 5 2 4 ports & 12 14	1 - 43mm	no	6	P2N-AM500J
	<b>Single subbase</b> 1 3 5 2 4 ports & 12 14	1 - 43mm	G3/8	140	P2N-AM513BT
	<b>Single subbase</b> 1 3 5 2 4 ports & 12 14	1 - 43mm		070	P2N-AK0P

## Sizes 1 & 2 side ported manifold

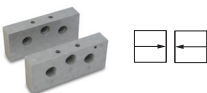
	Description	Size	Port Size	Weight (g)	Order code
	<b>Manifold</b> Manifold with side port	1 - 43mm	G1/4	240	P2N-EM512MD
		2 - 56mm	G3/8	210	P2N-FM513MD
	<b>End</b> Side ported connecting kit for above manifold with side ports	1 - 43mm	G3/8	360	P2N-EM513ES
		2 - 56mm	G1/2	290	P2N-FM514ES

# ORDER CHART

## Sandwich regulator for Plug-in or not Plug-in ISO 15407 (Sizes 02 & 01) and 5599 (Sizes 1, 2 & 3)



Function Description see below

**PS40** **37** **1** **6** **6** **CP**

ISO Size	
<b>ISO 15407</b>	
PS56	Size 02 (HB - 18 mm)
PS55	Size 01 (HA - 26 mm)
<b>ISO 5599</b>	
PS40	Size 1 (H1 - 43 mm)
PS41	Size 2 (H2 - 56 mm)
PS42	Size 3 (H3 - 71 mm)

ISO Version	
P	For ISO 15407
CP	For ISO 5599

Connecting version	
37	ISO-1 : For Non Plug-in Valve
38	ISO-2 : For Plug-in Valve

Port 4	Port 2
<b>Port Regulator / Gauge*</b>	
0	Line By-Pass Plate**
1	0-2 Bar - without gauge
2	0-4 Bar - without gauge
3	0-8 Bar - without gauge
4	0-2 Bar - with gauge
5	0-4 Bar - with gauge
6	0-8 Bar - with gauge

Regulator function	
1	Common Pressure Regulator
2	Independent Pressure Regulator

\* For Common Pressure Regulator Option, Regulator Gauge callout must be the same number for both port #4 and Port #2 (Example: 166)

\*\* For H1, H2 & H3 only. Pressure Line By-Pass Option can only be used with Independent Pressure Regulators

### Pressure Regulators functions

#### Common port regulation

Provides adjustable regulated air pressure to the valves #1 port which gives the same regulated pressure to both the #2 and #4 port of the manifold or subbase. The regulator is always on the 14 end of the valve.

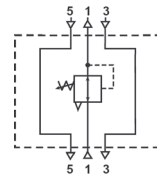

Part number code 1 X X

#### Independent port regulation

##### Single Port Regulator

Provides regulated pressure to both ports. Pressure regulation can occur out of the #2 or #4 port of the valve. Full line pressure would be provided with a pass plate.



Regulation on port #4

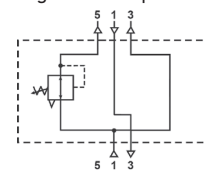

Part number code 2 X 0

Regulation on port #2

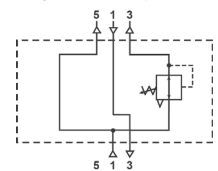

Part number code 2 0 Y

##### Dual Port Regulator

When using an independent Pressure Sandwich Regulator, the cylinder outlet ports are reversed. The 12 end energizes the #2 port. The 3-position CE and PC functions are also reversed.



Regulation on both ports #4 & #2

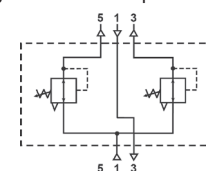

Part number code 2 X Y

## Sandwich regulator with Gauge

	ISO Size	Regulator function	Pressure		w (g)	Order code ISO-1 Non Plug-in	Order code ISO-2 Plug-in
			On port 4 and / or port 2				
	02 - 18 mm	Common	0 to 4 bar		PS5637155P	PS5638155P	
			0 to 8 bar		PS5637166P	PS5638166P	
		Independent	0 to 4 bar		PS5637255P	PS5638255P	
			0 to 8 bar		PS5637266P	PS5638266P	
	01 - 26 mm	Common	0 to 4 bar		PS5537155P	PS5538155P	
			0 to 8 bar		PS5537166P	PS5538166P	
Independent	0 to 4 bar		PS5537255P	PS5538255P			
	0 to 8 bar		PS5537266P	PS5538266P			
	1 - 43 mm	Common	0 to 4 bar		PS4037155CP	PS4038155CP	
			0 to 8 bar		PS4037166CP	PS4038166CP	
		Independent	0 to 4 bar		PS4037255CP	PS4038255CP	
			0 to 8 bar		PS4037266CP	PS4038266CP	
	2 - 56 mm	Common	0 to 4 bar		PS4137155CP	PS4138155CP	
			0 to 8 bar		PS4137166CP	PS4138166CP	
		Independent	0 to 4 bar		PS4137255CP	PS4138255CP	
			0 to 8 bar		PS4137266CP	PS4138266CP	
	3 - 71 mm	Common	0 to 4 bar		PS4237155CP	PS4238155CP	
			0 to 8 bar		PS4237166CP	PS4238166CP	
		Independent	0 to 4 bar		PS4237255CP	PS4238255CP	
			0 to 8 bar		PS4237266CP	PS4238266CP	

## Sandwich regulator with Gauge

### Ordering Components

- Manifold or Subbase Kit required.
- Sandwich Regulator Kit configured for Internal Pilot as standard.
- Order valve as External Pilot.

### Internal Pilot Configuration

Pressure in Base Port 1 feeds regulator configured for Internal Pilot which feeds valve configured for External Pilot.

### External Pilot Configuration - H1, H2, H3



An External Pilot pressure in port 12 or 14 of the base feeds through the Sandwich Regulator 12 or 14 galley directly to the 12/14 pilot of the valve.

This configuration takes an External Pilot from the 12 port of the base and passes it through the regulator to feed the 12 galley of the valve

## Sandwich Regulator Accessories

	Description	Pressure range	w (g)	Order code
	Gauge kit Including: Gauge 1/8" female to 1/8" female coupling 1/8" male to 1/8" male long nipple	0 to 8 bar		PS5651160P

## Sandwich Flow Control

	ISO Size	w (g)	Order code ISO-1 Non Plug-in	Order code ISO-2 Plug-in
	02 - 18 mm	180	PS5635P	PS5642P
	01 - 26 mm	240	PS5535P	PS5542P
	1 - 43 mm	340	PS4035CP	PS4042CP
	2 - 56 mm	520	PS4135CP	PS4142CP
	3 - 71 mm	1180	PS4235CP	PS4242CP

### Note:

- Both adjustment screws are located on the same 12 end of the unit
- Sandwich Flow Control mounts with its own studs, which means the valve uses standard bolts for mounting
- Sandwich Flow Control is not to be used as a shut off device and is not bubble tight when needles are fully turned down

# DIMENSIONS

## 15 mm DIN Form C solenoid operators and connectors

**P2E Operator**

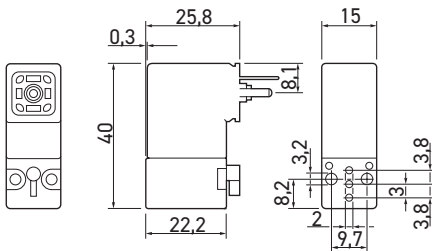

**Connector with standard screw**

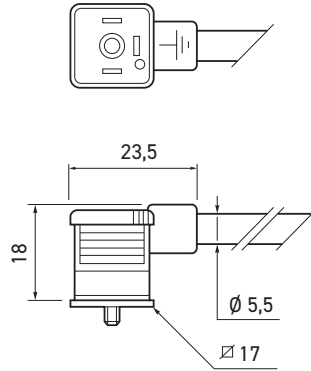

**Connector with large headed screw**

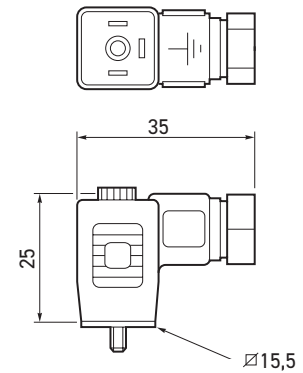

## CNOMO 22 x 30 solenoid operators and connectors

**P2F Operator**

with 30 x 30 DIN form A coil

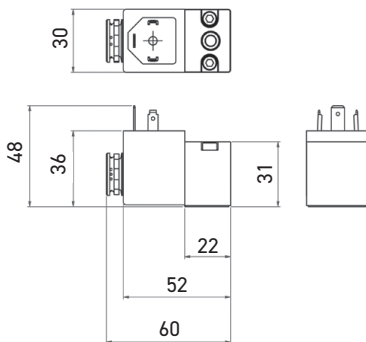

**EV30 Operator**

with 30 x 30 DIN form A coil

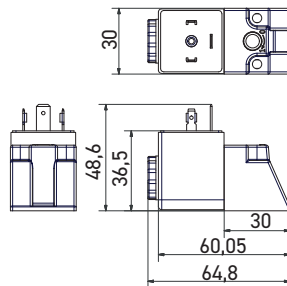

**30 x 30 DIN form A connector**

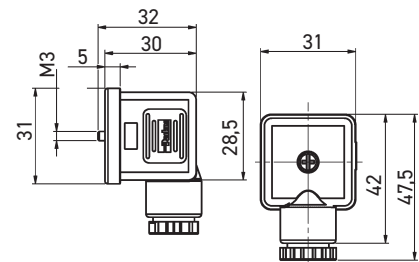

**EV310 Operator with 22 x 30 DIN form B coil**

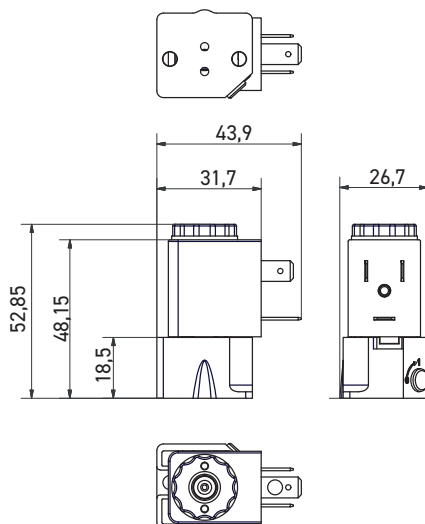

**22 x 30 DIN form B connector**

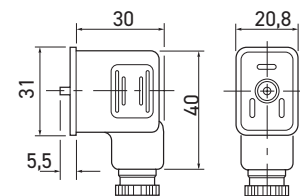

# DIMENSIONS

## ISOMAX - ISO 15407-1 - Sizes 02 & 01

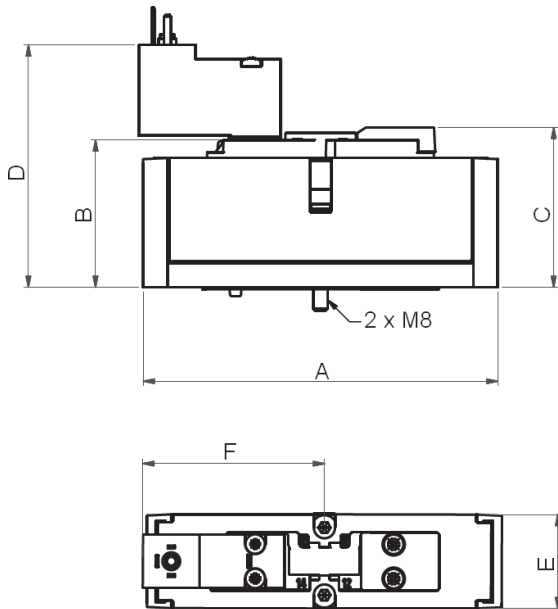

	A	B	C	D	E	F
<b>ISOMAX 02</b>	80	41	44,5	67,8	18	51,2
<b>ISOMAX 01</b>	100	42	45,5	68,8	26	51,2

## ISOMAX - ISO 5599-1 - Sizes 1, 2 & 3

With P2F operator

With EV30 operator

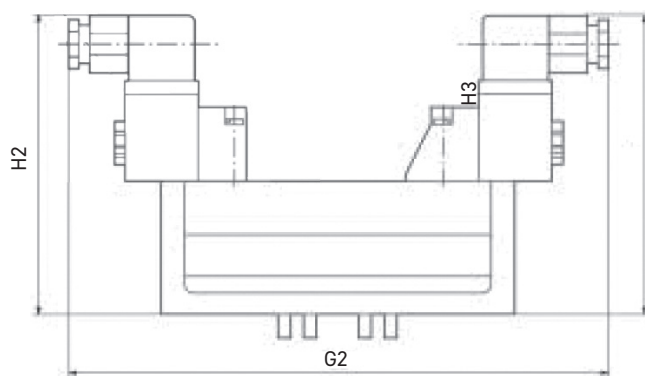

With EV310 operator

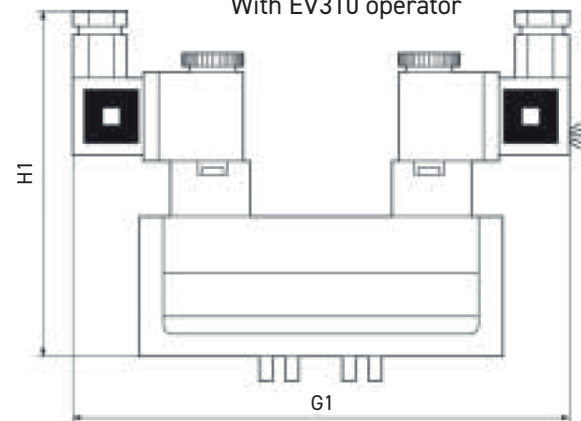

Pneumatically actuated

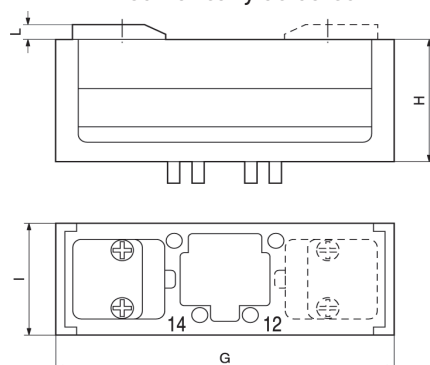

	G	G1	G2	H	H1	H2	I	L
<b>Size 1</b>	120	164	202,5	47	115	119	42	5
<b>Size 2</b>	140	179,5	218	58,5	126,5	130	54	5
<b>Size 3</b>	170	198	235,5	71	139	142,5	68	5

# DIMENSIONS

## Side ported individual subbase - ISO 15407-1 - Sizes 02 & 01

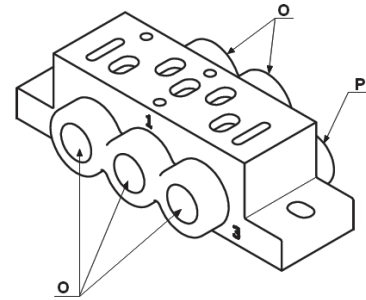
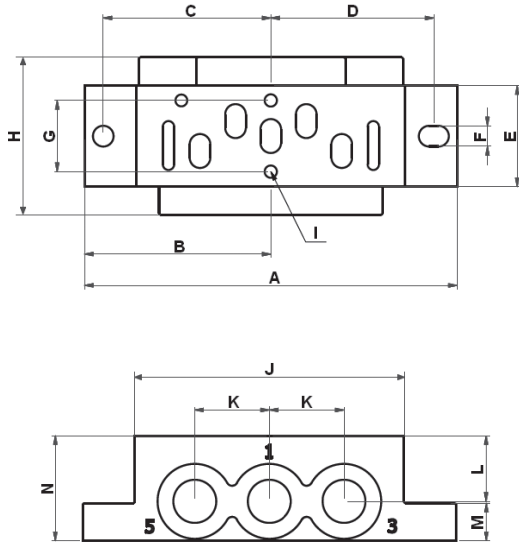

		Size	A	B	C	D	E	F	G	H	I	J	K	L	M	N	O	P
<b>PL02-01-70</b>	<b>BSPP</b>	02	80	40	35	33.75	19	5.5	12.5	27	M8	50	16	14	8	22.5	1/8	1/8
<b>PL02-01-80</b>	<b>NPT</b>	02	80	40	35	33.75	19	5.5	12.5	27	M8	50	16	14	8	22.5	1/8	1/8
<b>PL01-02-70</b>	<b>BSPP</b>	01	100	50	45	43.75	27	5.5	19	42,5	M8	72	20	17,5	10	28	1/4	1/8
<b>PL01-02-80</b>	<b>NPT</b>	01	100	50	45	43.75	27	5.5	19	42,5	M8	72	20	17,5	10	28	1/4	1/8

## Front ported manifold & End plate - ISO 15407-1 - Sizes 02 & 01

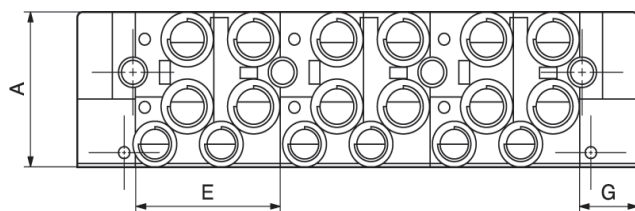

		Size	A	B	C	D	E	F	G	H
<b>PJLP02-201-70</b>	<b>BSPP</b>	02	38,5	80	-	-	38	-	-	-
<b>PJLP02-201-80</b>	<b>NPT</b>	02	38,5	80	-	-	38	-	-	-
<b>PJLP01-202-70</b>	<b>BSPP</b>	01	55	100	-	-	54	-	-	-
<b>PJLP01-202-80</b>	<b>NPT</b>	01	55	100	-	-	54	-	-	-
<b>PJL01-202-70</b>	<b>BSPP</b>	01	55	100	-	-	54	-	-	-
<b>PJL01-202-80</b>	<b>NPT</b>	01	55	100	-	-	54	-	-	-
<b>PEJ02-02-70</b>	<b>BSPP</b>	02	38,5	80	12	Ø4,2	-	14	18	70
<b>PEJ02-02-80</b>	<b>NPT</b>	02	38,5	80	12	Ø4,2	-	14	18	70
<b>PEJ01-03-70</b>	<b>BSPP</b>	01	55	100	24	Ø5,5	-	17	22	90
<b>PEJ01-03-80</b>	<b>NPT</b>	01	55	100	24	Ø5,5	-	17	22	90

PJLP01-201-70  
PJLP01-202-70

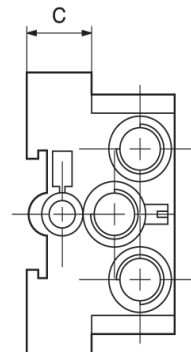
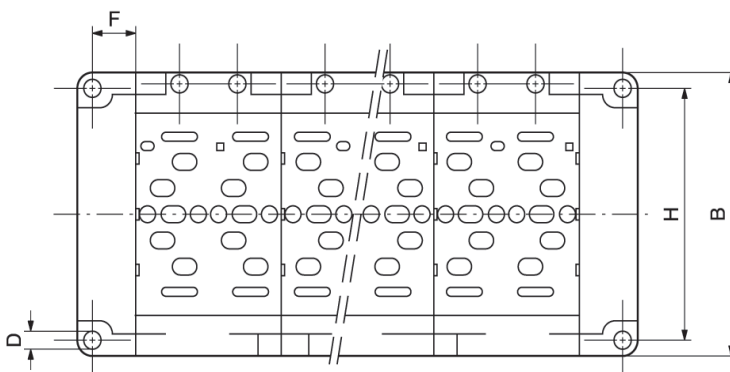

# DIMENSIONS

## Bottom ported manifold - ISO 15407-1 - Sizes 02 & 01

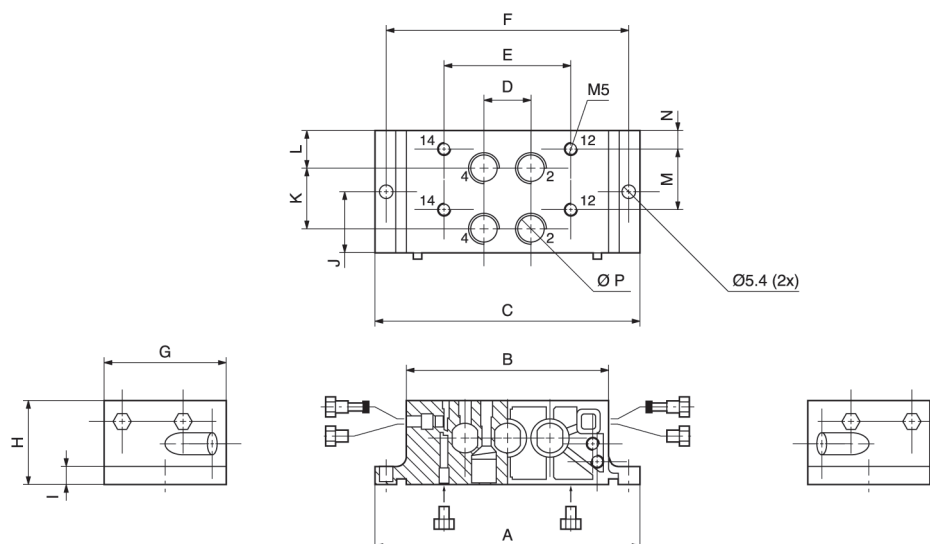

	Size	A	B	C	D	E	F	G	H	I	J	K	L	M	N	P
<b>P2V-AM511PB</b>	02	102	74	74,6	16	43	92	38	26	7	19	19	11	19	5	G1/8
<b>P2V-BM512PB</b>	01	118	90	90,6	21	56,5	108	54	37	8	27	27	16,5	27	8	G1/4

## Bottom ported End plate - ISO 15407-1 - Sizes 02 & 01

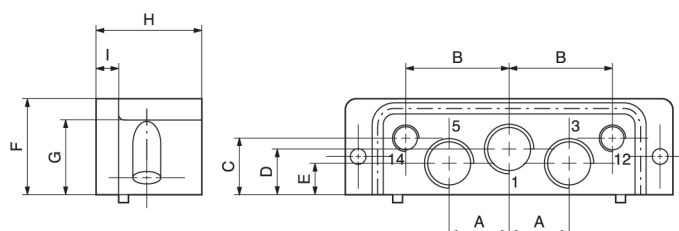

	Size	Port size 1,2,3	Port size 12, 14	A	B	C	D	E	F	G	H	I
<b>P2V-AM512XX and P2V-AM512XX</b>	02	G1/4	G1/8	17	29	21	18,5	9,5	35,5	28	33	7
<b>P2V-BM513XX and P2V-BM513XX</b>	01	G3/8	G1/8	21,5	37	20	16	11	34,5	28	38	8

## Transfer plate size 01 to size 02 for above bottom ported manifold

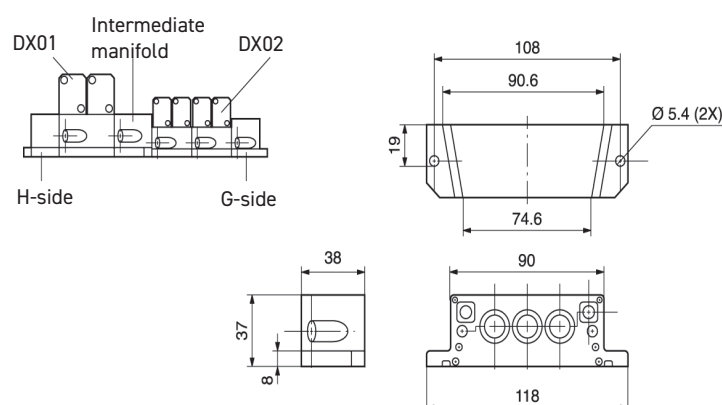

# DIMENSIONS

## ISO 5599-1 Subbase & Manifolds

### VDMA Side Ported Subbases

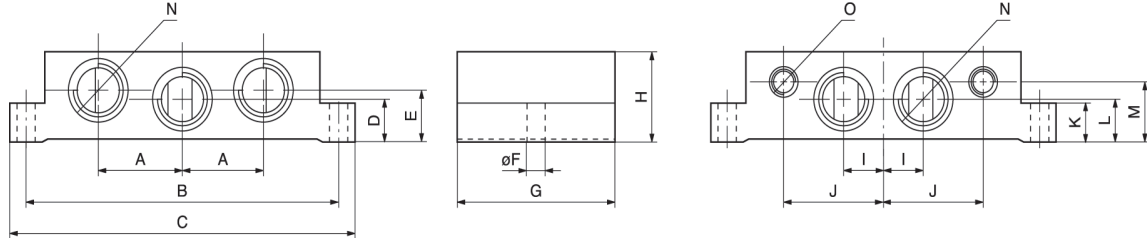

Order code	ISO Size	Port Size	A	B	C	D	E	F	G	H	I	J	K	L	M	N	O
<b>P2N-VS512SD</b>	1	G1/4	21,5	98	110	11	20	5,5	48	32	12	29	10	11	23	G1/4	G1/8
<b>P2N-WS513SD</b>	2	G3/8	28	112	124	14	26	6,6	56	40	15	37	13	14	30	G3/8	G1/8
<b>P2N-YS514SD</b>	3	G1/2	34	136	149	17	17	6,6	71	32	16	45	18	17	22	G1/2	G1/8

### VDMA Bottom Ported Manifold

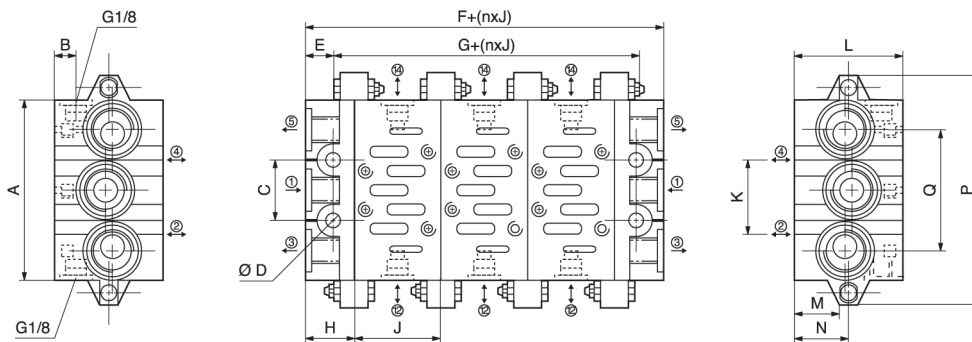

Order code	ISO Size	Port 1, 3, 5	Port 2, 4	A	B	C	D	E	F	G	H	J	K	L	M	N	O	P
<b>P2N-VM512MB</b>	1	G3/8	G1/4	85	8,5	28	7	11	44	22	22	43	26	46	21	24	56	110
<b>P2N-WM513MB</b>	2	G1/2	G3/8	100	9	35	9	13	52	26	26	56	30	47	22	24	68	135
<b>P2N-YM514MB</b>	3	G1	G1/2	140	10	52	12	15	60	30	30	71	38	56	31	34	104	190

### Side ported subbases

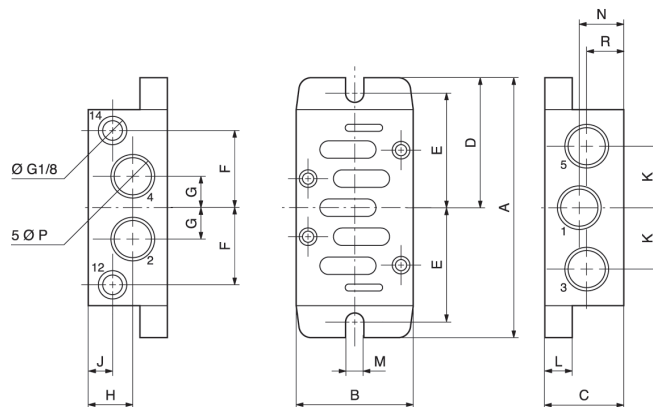

Order code	ISO Size	ØP	A	B	C	D	E	F	G	H	J	K	L	M	N	R
<b>PL1-1/4-70</b>	1	G1/4	110	46	29	55	49	30	11	17,75	17,75	22	6	5,5	17,75	17,75
<b>PL2-3/8-70</b>	2	G3/8	124	56	37	62	55	37	14,5	22,5	14	28	6	5,5	22,5	14,5
<b>P2N-JS516SD</b>	3	G3/4	149	71	60	74,5	68	45	21	33	10	40	18	6,6	37,5	22,5

# DIMENSIONS

## Bottom ported subbases

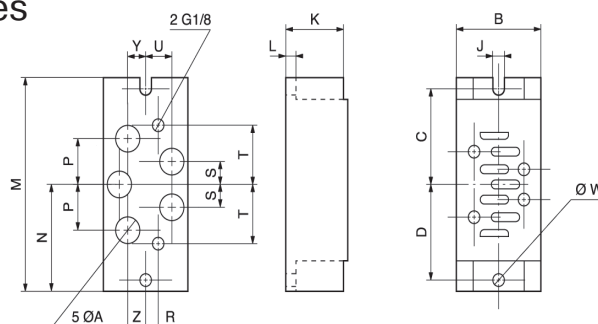

Order code	ISO Size	A	B	C	D	J	K	L	M	N	P	R	S	T	U	W	Y	Z
<b>PD1-1/4-70</b>	1	G1/4	46	49	49	5,5	29	6	110	55	22	10	11	30	10	5,5	10	10
<b>PD2-3/8-70</b>	2	G3/8	56	55	55	5,5	37	6	124	62	29	10	14,5	37	12,5	5,5	12,5	12,5
<b>PD3-1/2-70</b>	3	G1/2	77	68	68	6,6	32	18	149	74,5	34	10	17	45	17	6,5	17	17

## Size 1 bottom ported manifold

### Manifold P2N-AM512MB

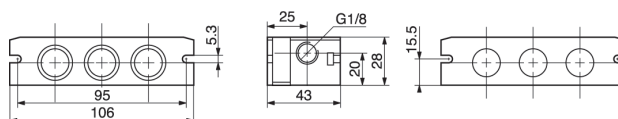

### Connecting block P2N-AM513GT

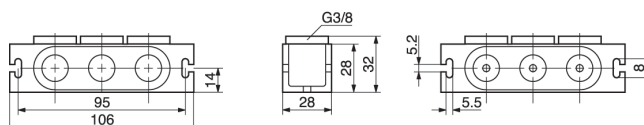

### End piece P2N-AM500J

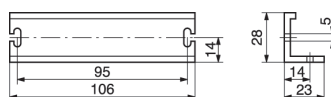

### Intermediate supply P2N-AM513BT

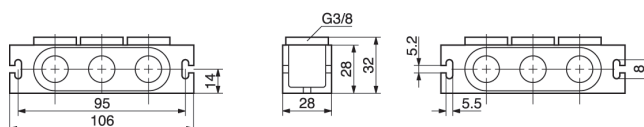

## Sizes 1 & 2 side ported manifold

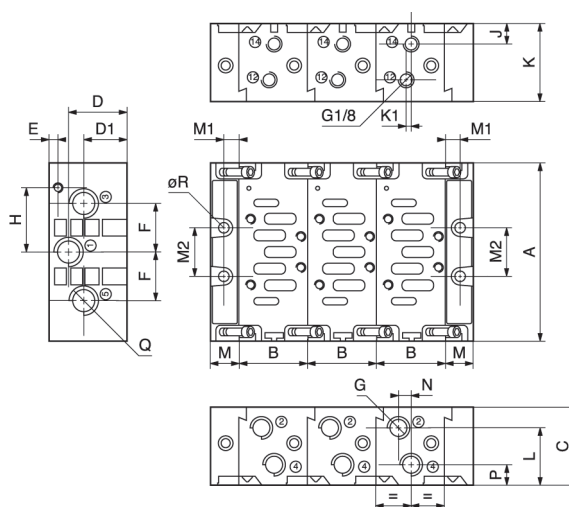

Order code	A	B	C	D	D1	E	F	G	H	J	K	K1	L	M	M1	M2	N	P	Q	R
<b>P2N-EM . . .</b>	110	43	48	35,5	26,5	5,5	28	G1/4	36	15,5	35	3	32	20	11	28	12	12,5	G3/8	6
<b>P2N-FM . . .</b>	129	56	60	44,5	35,5	6	34,5	G3/8	45	16	41,5	3	41	24	13	35	12,5	16	G1/2	8

# DIMENSIONS

## Sandwich Regulator with Gauge

### HA / HB Series

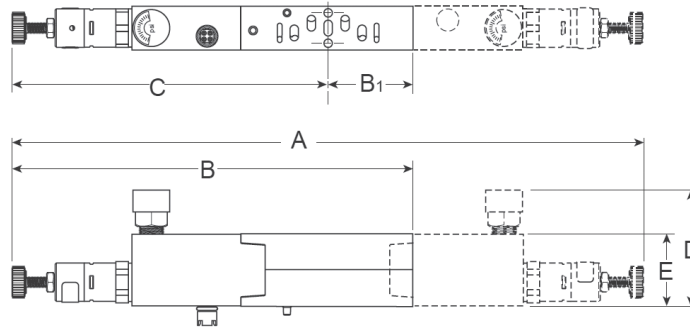

	A	B	B1	C	D	E
<b>HB</b>	261	156	26	130	66	30
<b>HA</b>	254	163	36	127	69	30

### H1 Series

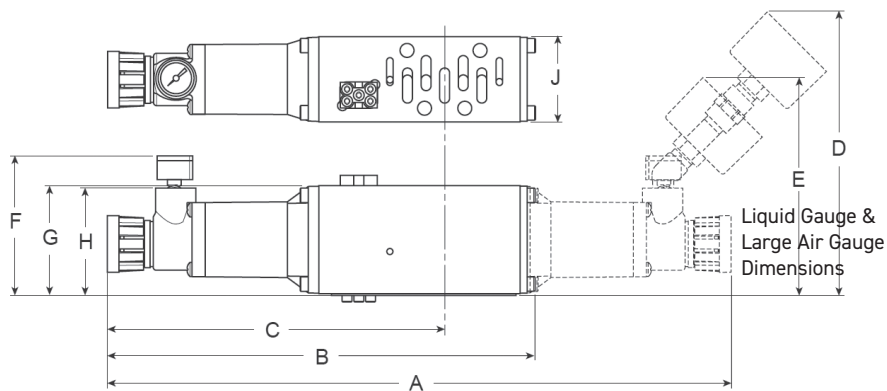

	A	B	C	D	E	F	G	H	J
<b>H1</b>	301	207	163	138	108	72	53	52	41

### H2 / H3 Series

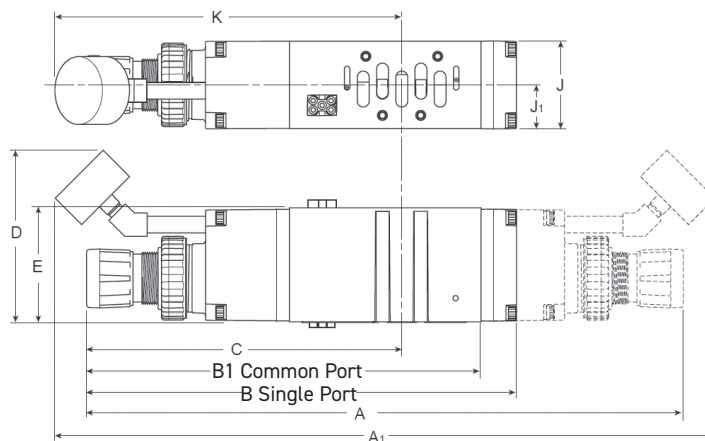

	A	A1	B	B1	C	D	E	J	J1	K
<b>H2</b>	372	411	268	250	196	107	71	55	27	216
<b>H3</b>	398	436	293	271	213	107	75	64	32	231

# DIMENSIONS

## Sandwich Flow Control

### HA Series

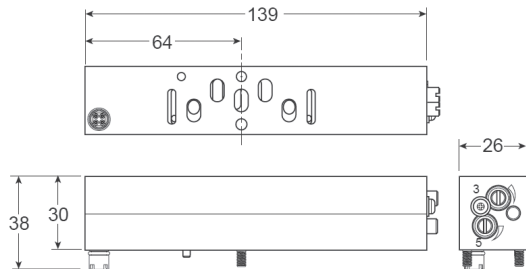

### HB Series

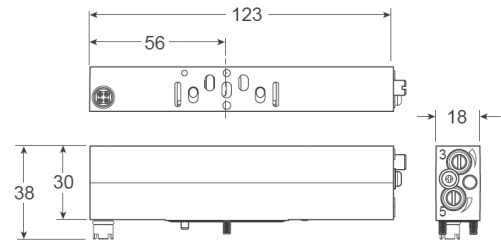

### H1 Series

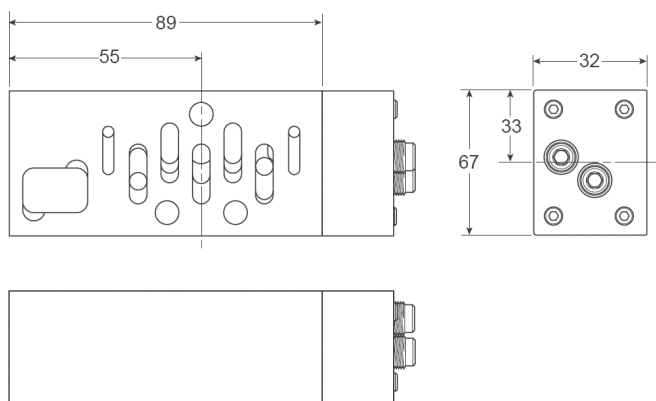

### H2 Series

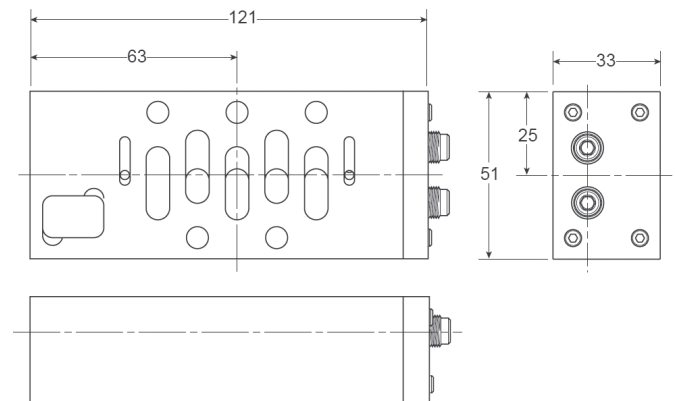

### H3 Series

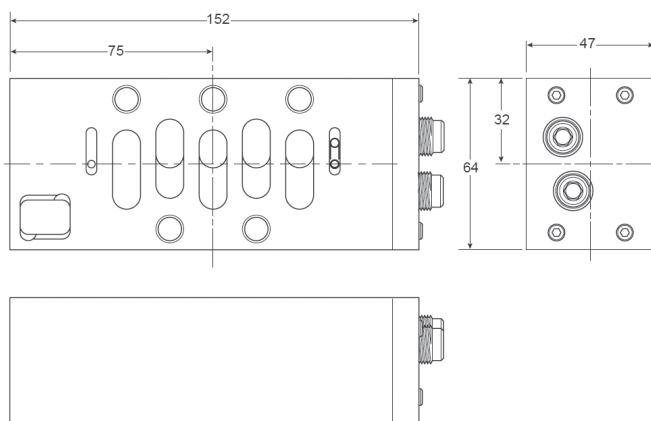





Parker Hannifin Corporation  
**Parker Hannifin EMEA Sàrl**  
European Headquarters  
La Tuilière 6 Etoy  
Switzerland CH-1163  
[www.parker.com](http://www.parker.com)

PDE2568TCUK

June 2025

Your Local Authorized Parker Distributor

© 2025 Parker Hannifin Corporation

