

Helical Hydraulic Rotary Actuators

L30 Series Service & Repair Manual



ENGINEERING YOUR SUCCESS.

Table of Contents

Introduction	
Table of Contents	2
Product Introduction	3
General Safety Guidelines	4
Product Identification	4
Theory of Operation	5
<hr/>	
Tools	
Tools Required	6
Spare Parts - Tech Support.....	7
<hr/>	
Drawings	
Assembly Drawings.....	8
Exploded Views	9
Parts List.....	10
<hr/>	
Disassembly	
Before Disassembly	19
Disassembly.....	19
Inspection	18
<hr/>	
Assembly	
Seal and Wear Guide Installation	25
Assembly	29
<hr/>	
Post Assembly	
Greasing Thrust Washers	32
Testing the Actuator	32
Installation and Bleeding	33
Troubleshooting Guide	34
Offer of Sale	35

Product Introduction

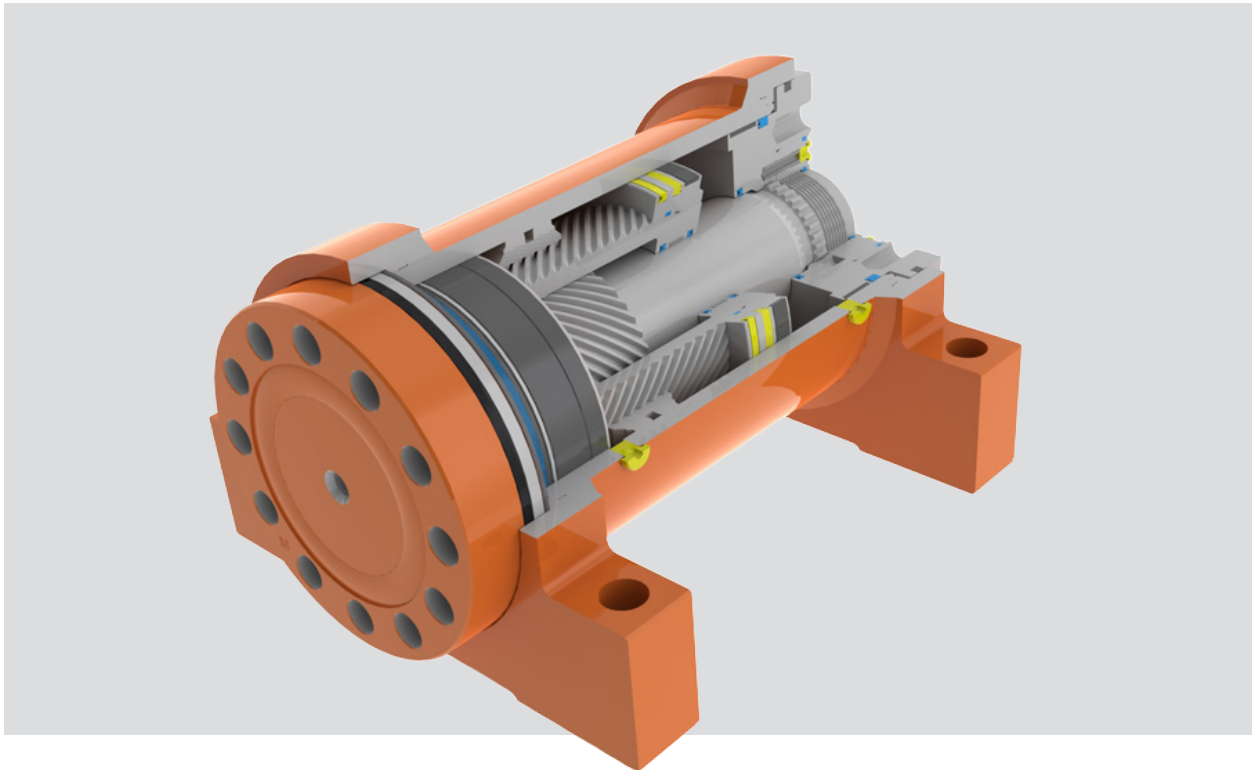

For over 50 years, Parker Hannifin Corporation has been recognized for innovation in design of hydraulic rotary actuators and construction equipment attachments. Helac products are known for their tremendous torque output, compact configurations, exceptional load bearing capabilities, and rugged, reliable performance. Over 1,000 mobile, industrial, construction and mining machinery manufacturers around the world depend on Helac actuators to perform such functions as rotation, positioning, manipulation, vehicle steering and indexing.

The L30 Series is available in several different sizes. All L30 Series actuators incorporate the same internal design, though they vary in size depending on model.

General Safety Guidelines



Many L30 actuator applications have several pinch points with the potential for severe injuries. Use extreme caution and remain clear of all rotating components when bleeding the hydraulic system and whenever the machine is in operation.

After rebuilding or repairing an actuator, it is necessary to bleed all air from the actuator as well as the hydraulic system of the machine.

Product Identification

Each Helac actuator is individually serial numbered. The serial number is a six digit number and must be provided before parts and/or service issues can be addressed.

The serial number can be found on the Identification (ID) Tag that is affixed to all actuators. The tag is a thin, silver colored, plastic label with a self-adhesive backing. Information is imprinted in black. The tag is located on the housing tube of the actuator. In some cases, the ID tag may be painted over by the OEM (Original Equipment Manufacturer).

Additionally, the serial number of the actuator is stamped onto the housing tube. It may be necessary to remove paint to expose the serial number.

Stamped Serial Number

Identification (ID) Tag



Theory of Operation

The L30 Series rotary actuator is a simple mechanism that uses Helac's sliding spline technology which converts linear piston motion into powerful shaft rotation. Each actuator is composed of a housing with an integral ring gear (1) and only two moving parts: the central shaft (2) with an integrated bearing and mounting flange, and the annular piston sleeve (3).

Helical spline teeth machined on the shaft engage matching splines on the inside diameter of the piston. The outside diameter of the piston carries a second set of splines, of opposite hand, which engage the matching splines of the housing's ring gear.

As hydraulic pressure is applied, the piston is displaced axially within the housing - similar to the operation of a hydraulic cylinder - while simultaneously, the splines cause the shaft to rotate. When the control valve is closed, oil is trapped inside the housing, preventing piston movement and locking the shaft firmly in position.

The shaft is supported radially by the large upper radial bearing and the lower radial bearing (see drawings on pages 8 and 9). Axially, the shaft is separated from the housing by the upper and lower thrust washers. The end cap is adjusted for axial clearance and locked in position by set screws, pins or locking collar.

The L30 Series is available in several different sizes. All L30 Series actuators incorporate the same internal design, though they vary in size depending on model.

Many actuators are equipped with a factory installed counterbalance valve, which performs four major functions.

- Protects the actuator in the event of overload
- Enables the actuator to hold position without drifting when external loads are applied
- Reduces hydraulic backlash by pressuring the hydraulic fluid
- Provides a constant controlled rate of rotation in over-center load conditions

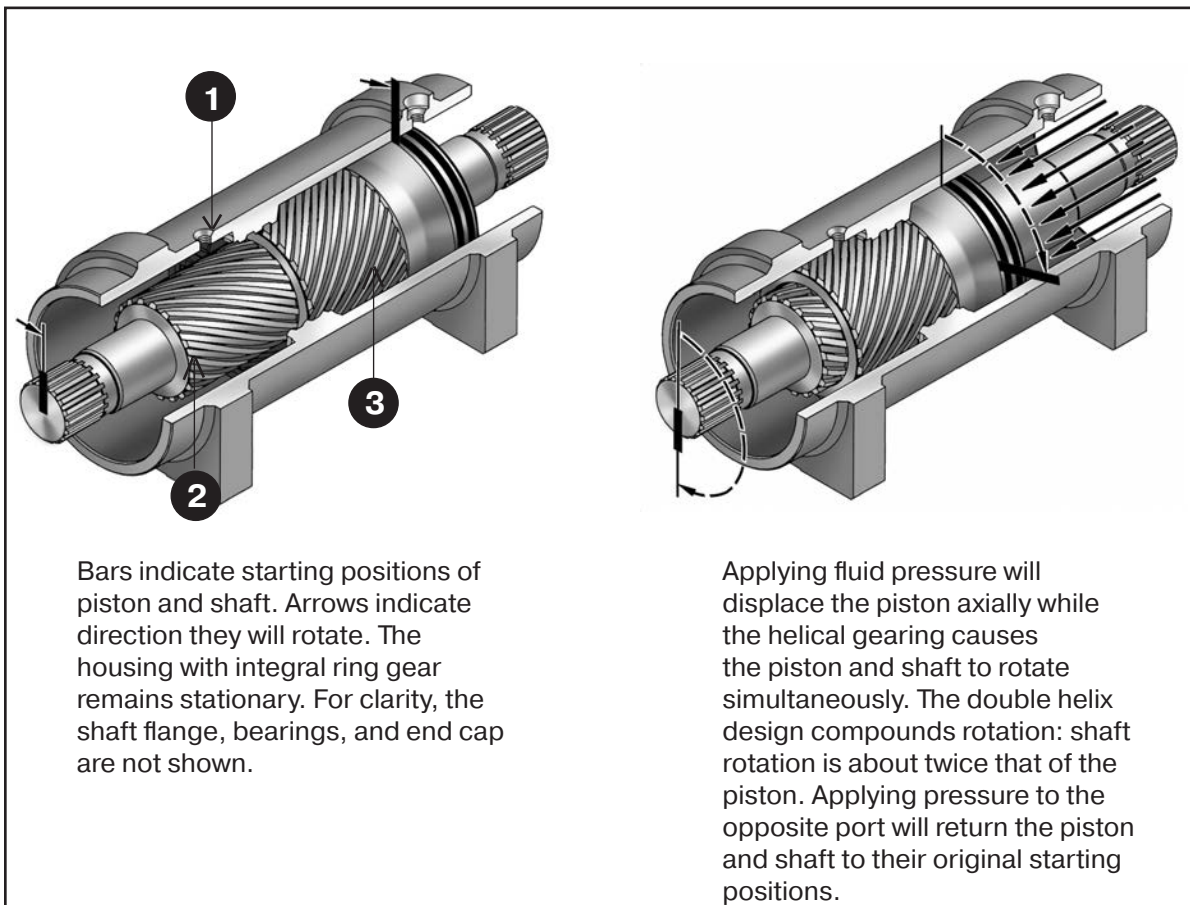

Tools Required



Several basic tools are required for the disassembly and reassembly of the actuator. The tools and their intended functions are outlined below:

- 1. PIPE VISE**
- 2. BOLTS**
- 3. PRY BAR**
- 4. SCREWS**
- 5. FLASHLIGHT**
Helps in locating and examining timing marks, component failure and overall condition.
- 6. HEX WRENCH SET**
Removal and replacement of port plugs and set screws
- 7. TORQUE TOOL**
- 8. TORQUE WRENCHES**
- 9. ASSORTED SCREWS**
- 10. PLASTIC MANDREL**
Removal and installation of piston sleeve
- 11. FELT MARKER**
Highlights timing marks and outlines troubled areas. Permanent ink is recommended.
- 12. SAFETY GLASSES**
- 13. SEAL TOOLS**

14. RUBBER Mallet

Removal and installation of shaft and piston sleeve assembly.

MAKING A SEAL TOOL

The seal tool is merely a customized standard flat head screwdriver.

- 1. Heat the flat end with a torch until it glows.
- 2. Secure the heated end of the screwdriver in a vise and bend the heated end to a slight radius.
- 3. Round off all sharp edges of the heated to a polished finish. The tool may be modified slightly to your own personal preference.



CAUTION

To avoid injury:
Be careful when
handling the
screwdriver when hot.

Spare Parts

Spare parts must be ordered through the vehicle/machine OEM. Seals and bearings are available as complete kits only! In order to obtain the correct parts, it is essential to provide the serial number of the actuator

to be repaired, see Product Identification section on page 4. To identify spare parts required, refer to the Assembly Drawing on page 9 and Parts List on page 10.

Technical Support

Technical support is available from Parker Hannifin Corporation Monday through Friday 7 am to 4 pm Pacific Standard Time by calling 800-327-2589. If possible, please have the serial number of the actuator available. (The serial number is stamped into the housing of the actuator-see page 4).

L30 Assembly Drawing

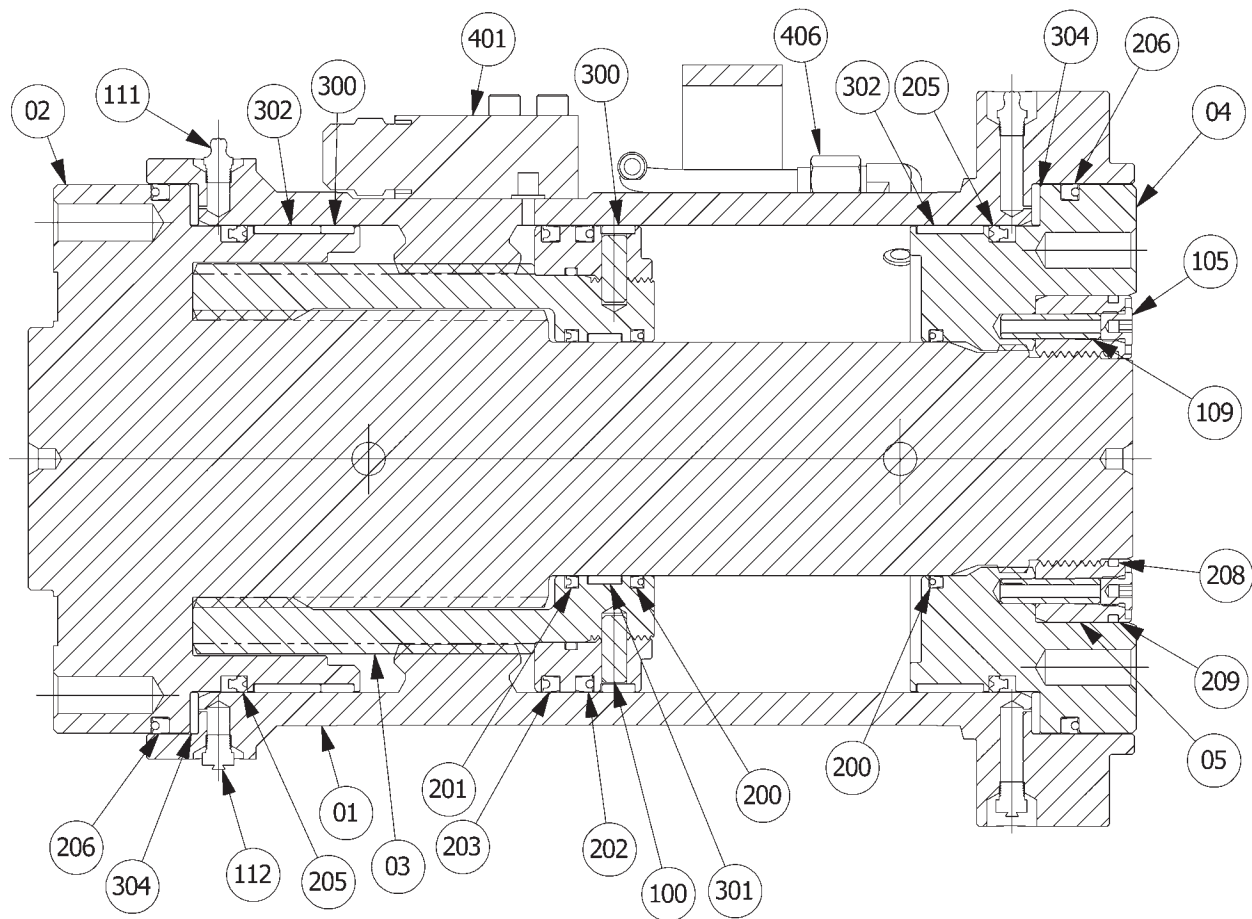

L30 Exploded View

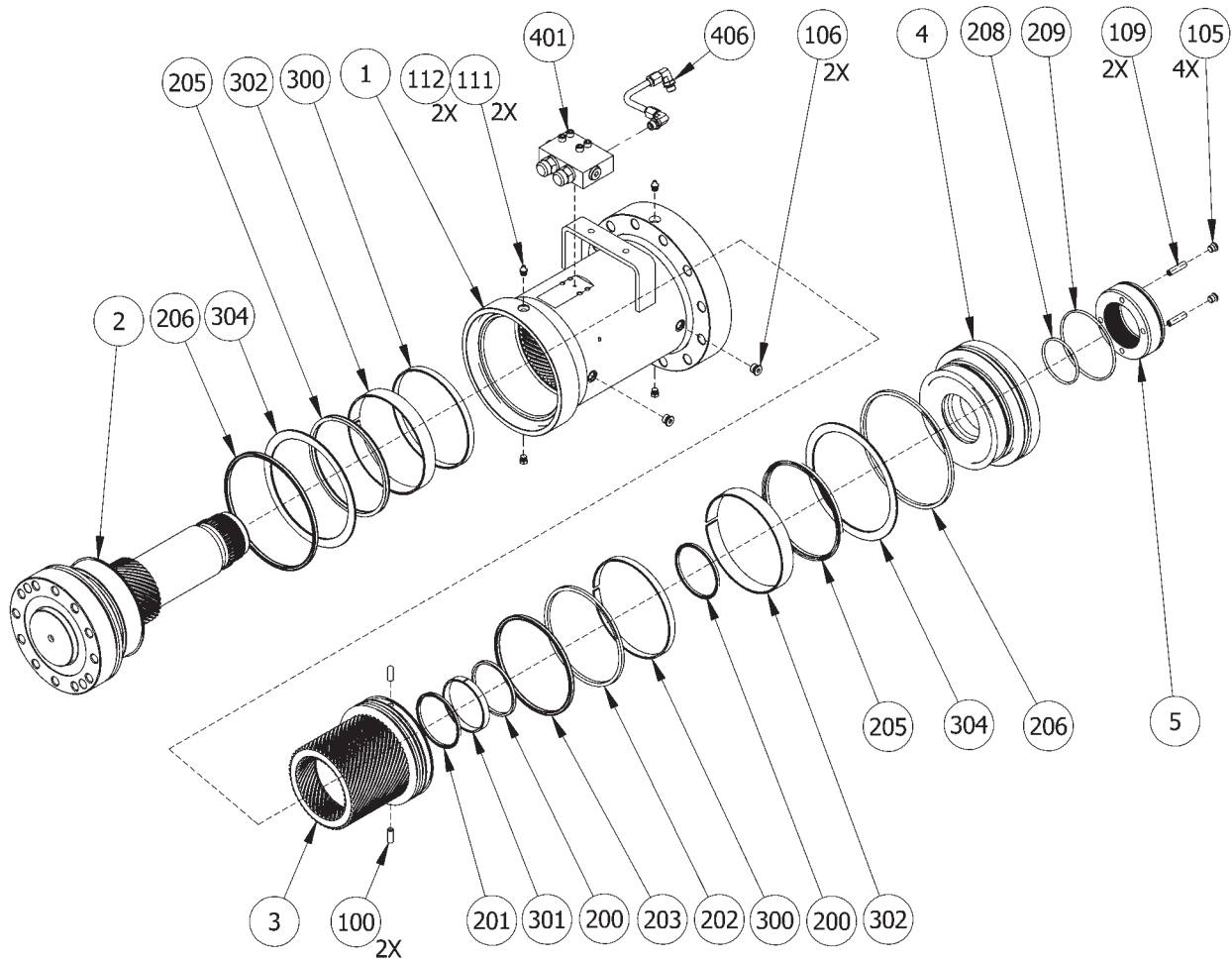

Parts List - L30-17

Parts listed are standard components per the catalog. Parker-Helac has and does make special designs for OEM's that may differ. Model codes beginning with L30-17-S, L30-17-ES or L30-17-MS could use different parts.

Parts

Part Number	Item #	Description	Qty
Consult Factory	01	Housing	1
29225	02	Shaft "E" 180° (SAE bolt circle)	1
29974	02	Shaft "M" 180° (Metric bolt circle)	1
29235	02	Shaft "E" 360° (SAE bolt circle)	1
29975	02	Shaft "M" 360° (Metric bolt circle)	1
27393	03	Piston Sleeve 180°	1
29241	03	Piston Sleeve 360°	1
29224	04	End Cap, S1 (no bolt circle)	1
29232	04	End Cap, S2 "E" (SAE bolt circle)	1
29978	04	End Cap, S2 "M" (Metric bolt circle)	1
29206	05	Lock Ring	1
29220		Hardware Kit: SAE Port Plugs (includes item 105, 106, 106.1, 109, 111, 112)	
	113	Set Screw (Socket head; 3/8"-16 x .375", Cup, Grade 8)	2
	105	Port plug, Socket Hex Head (SAE-2)	4
	106	Port Plug, Socket Hex Head (SAE-4)	6
	109	Pull-out dowel pin .25" x .75" long	1
	111	Grease Fitting (Balcrank, 5000 Lincoln, 1/8-27 NPT)	2
	112	**Grease Relief Valve (50500, 1/8-27 NPT, Alemite 400-650 PSI)	2
29220-4		Hardware Kit: BSPP Port Plugs (includes item 105, 106, 106.1, 109, 111, 112)	
	113	Set Screw (Socket head; 3/8"-16 x .375", Cup, Grade 8)	2
	105	Port plug SAE-2	4
	106	Port Plug, Hex Head (BSPP G 1/4)	4
	109	Pull-out dowel pin .25" x .75" long, tapped #8-32	1
	111	Grease Fitting (Balcrank, 5000 Lincoln, 1/8-27 NPT)	2
	112	Grease Relief Valve (50500, 1/8-27 NPT, Alemite 400-650 PSI)	2
29920	401	Counterbalance Valve Kit: 2 x SAE-4 Ports (includes valve, mounting screws and o-rings) Top of valve stamped 29919	
		CB Valve	1
		Socket head cap screw; 5/16"-18 x 1.50" ASTM A574	3
		Port plug: SAE-4 Hollow hex, o-ring	2

Parts in kits not sold individually

Seal and bearing kits can be ordered online at <http://www.parker.com/helac>

Part Number	Item #	Description	Qty
S28411-3		Counterbalance Valve Kit: 2 x SAE-6 Ports (includes valve, mounting screws and o-rings) Top of valve stamped 28411-03	
		CB Valve	1
		Socket head cap screw; 5/16"-18 x 1.50" ASTM A574	4
		Port plug: SAE-6 Hollow hex, o-ring	2
28215-3	401	Standard Counterbalance Valve Kit: 2 x BSPP G3/8 Ports (includes valve, mounting screws and o-rings) Top of valve stamped 28215-03	
		CB Valve	1
		Socket head cap screw; 5/16"-18 x 1.50" ASTM A574	4
		Port plug: BSPP G3/8	2
	406	Hydraulic tube assembly (made locally)	1

Note: Parker Hannifin supplies many different counterbalance and motion control valves specific to an OEM application. If the valve you have is not one of the part numbers listed, contact the OEM of the equipment installed on to purchase the correct valve.

Part Number	Item #	Description	Qty
29218-H		Seal Kit - Standard (Includes items below)	
	200	Cup - Seal	1
	201	Cup - Seal (energizer removed)	1
	202	T-Seal	1
	204	O-Ring	1
	205	Cup Seal	2
	206	Cup Seal	2
	207	Back-up Ring	1
	208	O-Ring	1
	209	O-Ring	1
S29219		Bearing Kit 180° (Includes item below)	
	301	Wear Guide	1
	302	Wear Guide	1
	303	Wear Guide	1
	304	Thrust Washer	2
S29247		Bearing Kit 360° (Includes item below)	
	301	Wear Guide	1
	302	Wear Guide	2
	303	Wear Guide	1
	304	Wear Guide	2

Parts in kits not sold individually



Parts List

Parts List - L30-25

Parts listed are standard components per the catalog. Parker-Helac has and does make special designs for OEM's that may differ. Model codes beginning with L30-25-S, L30-25-ES or L30-25-MS could use different parts.

Parts

Part Number	Item #	Description	Qty
Consult Factory	01	Housing	1
28990	02	Shaft "E" 180° (SAE bolt circle)	1
31549	02	Shaft "M" 180° (Metric bolt circle)	1
29028	02	Shaft "E" 360° (SAE bolt circle)	1
31548	02	Shaft "M" 360° (Metric bolt circle)	1
29007	03	Piston Sleeve 180°	1
29027	03	Piston Sleeve 360°	1
29008	04	End Cap, S1 (no bolt circle)	1
29023	04	End Cap, S2 "E" (SAE bolt circle)	1
31550	04	End Cap, S2 "M" (Metric bolt circle)	1
29005	05	Lock Ring	1
29017		Hardware Kit; SAE Port Plugs (includes item 105, 106, 106.1, 109, 111, 112)	
	113	Set Screw (Socket head; 1/2"-13 x .50", Cup, Grade 8)	2
	105	Port plug, Socket Hex Head (SAE-2)	4
	106	Port Plug, Socket Hex Head (SAE-4)	4
	109	Pull-out dowel pin .25" x 1.0" long	1
	111	Grease Fitting (Balcrank, 5000 Lincoln, 1/8-27 NPT)	2
	112	**Grease Relief Valve (50500, 1/8-27 NPT, Alemite 400-650 PSI)	2
29017-5		Hardware Kit: BSPP Port Plugs (includes item 105, 106, 106.1, 109, 111, 112)	
	105	Port plug SAE-2	4
	106	Port Plug, Hex Head (BSPP G 1/4)	4
	109	Pull-out dowel pin .25" x 1.0" long, tapped #8-32	1
	111	Grease Fitting (Balcrank, 5000 Lincoln, 1/8-27 NPT)	2
	112	Grease Relief Valve (50500, 1/8-27 NPT, Alemite 400-650 PSI)	2
29017-6		Hardware Kit: BSPP G1/8 Port Plugs (includes item 105, 106, 106.1, 109, 111, 112)	
	105	Port plug SAE-2	4
	106	Port Plug, Hex Head (BSPP G 1/8)	4
	109	Pull-out dowel pin .25" x 1.0" long, tapped #8-32	1
	111	Grease Fitting (Balcrank, 5000 Lincoln, 1/8-27 NPT)	2
	112	**Grease Relief Valve (50500, 1/8-27 NPT, Alemite 400-650 PSI)	2

Parts in kits not sold individually

Part Number	Item #	Description	Qty
29920	401	Counterbalance Valve Kit: 2 x SAE-4 Ports (includes valve, mounting screws and o-rings) Top of valve stamped 29919	
		CB Valve	1
		Socket head cap screw; 1/4"-20 x 1.50" ASTM A574	3
		Port plug: SAE-4 Hollow hex, o-ring	2
S27357	401	Standard Counterbalance Valve Kit: 2 x BSPP G3/8 Ports (includes valve, mounting screws and o-rings) Top of valve stamped 28215-03	
		CB Valve	1
		Socket head cap screw; 1/4"-20 x 1.50" ASTM A574	3
		Port plug: SAE-4 Hollow hex, o-ring	2
	406	Hydraulic tube assembly (made locally)	1

Note: Parker Hannifin supplies many different counterbalance and motion control valves specific to an OEM application. If the valve you have is not one of the part numbers listed, contact the OEM of the equipment installed on to purchase the correct valve.

Part Number	Item #	Description	Qty
29015-H		Seal Kit - Standard (Includes items below)	
	200	Cup - Seal	2
	201	Cup - Seal (energizer removed)	1
	202	T-Seal	1
	205	Cup Seal	2
	206	Cup Seal	2
	208	O-Ring	1
	209	O-Ring	1
29016-H		Bearing Kit 180° (Includes item below)	
	301	Wear Guide	1
	302	Wear Guide	1
	304	Thrust Washer	2
29088		Bearing Kit 360° (Includes item below)	
	301	Wear Guide	1
	302	Wear Guide	5
	304	Wear Guide	2

Parts in kits not sold individually

Seal and bearing kits can be ordered online at <http://www.parker.com/helac>



Parts List - L30-42

Parts listed are standard components per the catalog. Parker-Helac has and does make special designs for OEM's that may differ. Model codes beginning with L30-42-S, L30-42-ES or L30-42-MS could use different parts.

Parts

Part Number	Item #	Description	Qty
Consult Factory	01	Housing	1
29036	02	Shaft "E" 180° (SAE bolt circle)	1
29602	02	Shaft "M" 180° (Metric bolt circle)	1
29042	02	Shaft "E" 360° (SAE bolt circle)	1
29723	02	Shaft "M" 360° (Metric bolt circle)	1
29068	03	Piston Sleeve 180°	1
29069	03	Piston Sleeve 360°	1
29047	04	End Cap, S1 (no bolt circle)	1
29048	04	End Cap, S2 "E" (SAE bolt circle)	1
29603	04	End Cap, S2 "M" (Metric bolt circle)	1
29049	05	Lock Ring	1
29072		Hardware Kit: SAE Port Plugs (includes item 105, 106, 106.1, 109, 111, 112)	
	113	Set Screw (Socket head; 5/8"-11 x .625", Cup, Grade 8)	2
	105	Port plug, Socket Hex Head (SAE-4)	4
	106	Port Plug, Socket Hex Head (SAE-6)	4
	109	Pull-out dowel pin .375" x 1.25" long	1
	111	Grease Fitting (Balcrank, 5000 Lincoln, 1/8-27 NPT)	2
	112	**Grease Relief Valve (50500, 1/8-27 NPT, Alemite 400-650 PSI)	2
29072-3		Hardware Kit: BSPP Port Plugs (includes item 105, 106, 106.1, 109, 111, 112)	
	113	Set Screw (Socket head; 5/8"-11 x .625", Cup, Grade 8)	2
	105	Port plug SAE-4	4
	106	Port Plug, Hex Head (BSPP G 1/4)	2
	109	Pull-out dowel pin .375" x 1.25" long, tapped #10-32	1
	111	Grease Fitting (Balcrank, 5000 Lincoln, 1/8-27 NPT)	2
	112	Grease Relief Valve (50500, 1/8-27 NPT, Alemite 400-650 PSI)	2
28411-3	401	Counterbalance Valve Kit: 2 x SAE-6 Ports (includes valve, mounting screws and o-rings) Top of valve stamped 28411-03	
		CB Valve	1
		Socket head cap screw; 5/16"-18 x 1.50" ASTM A574	4
		Port plug: SAE-6 Hollow hex, o-ring	2

Parts in kits not sold individually

Part Number	Item #	Description	Qty
28215-3	401	Standard Counterbalance Valve Kit: 2 x BSPP G3/8 Ports (includes valve, mounting screws and o-rings) Top of valve stamped 28215-03	
		CB Valve	1
		Socket head cap screw; 5/16"-18 x 1.50" ASTM A574	4
		Port plug: BSPP G3/8	2
	406	Hydraulic tube assembly (made locally)	1

Note: Parker Hannifin supplies many different counterbalance and motion control valves specific to an OEM application. If the valve you have is not one of the part numbers listed, contact the OEM of the equipment installed on to purchase the correct valve.

Part Number	Item #	Description	Qty
29070-H		Seal Kit - Standard (Includes items below)	
	200	Cup - Seal	1
	201	Cup - Seal (energizer removed)	1
	202	T-Seal	1
	205	Cup Seal	2
	206	Cup Seal	2
	208	O-Ring	1
	209	O-Ring	1
	29071		Bearing Kit 180° (Includes item below)
301		Wear Guide	1
302		Wear Guide	2
303		Wear Guide	2
29073		Bearing Kit 360° (Includes item below)	
	301	Wear Guide	1
	302	Wear Guide	5
	304	Wear Guide	2

Parts in kits not sold individually

Seal and bearing kits can be ordered online at <http://www.parker.com/helac>

Parts List

Parts List - L30-65

Parts listed are standard components per the catalog. Parker-Helac has and does make special designs for OEM's that may differ. Model codes beginning with L30-65-S, L30-65-ES or L30-65-MS could use different parts.

Parts

Part Number	Item #	Description	Qty
Consult Factory	01	Housing	1
28194	02	Shaft "E" 180° (SAE bolt circle)	1
29708	02	Shaft "M" 180° (Metric bolt circle)	1
28542	02	Shaft "E" 360° (SAE bolt circle)	1
29709	02	Shaft "M" 360° (Metric bolt circle)	1
S28227 or 36905	03	Piston Sleeve 180°	1
S28305 or 36896	03	Piston Sleeve 360°	1
28229	04	End Cap, S1 (no bolt circle)	1
28538	04	End Cap, S2 "E" (SAE bolt circle)	1
29707	04	End Cap, S2 "M" (Metric bolt circle)	1
28231	05	Lock Ring	1
28232-3		Hardware Kit: SAE Port Plugs (includes item 100, 105, 106, 106.1, 109, 111, 112)	
	100	Piston dowel pin, .375" x 1.0" long, hardened	1
	113	Set Screw (Socket head; 5/8"-11 x .625", Cup, Grade 8)	2
	105	Port plug, Socket Hex Head (SAE-4)	4
	106	Port Plug, Socket Hex Head (SAE-6)	4
	109	Pull-out dowel pin .375" x 1.5" long	1
	111	Grease Fitting (Balcrank, 5000 Lincoln, 1/8-27 NPT)	2
28232-5		Hardware Kit: SAE Port Plugs (includes item 100, 105, 106, 106.1, 109, 111, 112)	
	100	Piston dowel pin, .375" x 1.0" long, hardened	1
	113	Set Screw (Socket head; 5/8"-11 x .625", Cup, Grade 8)	2
	105	Port plug, Socket Hex Head (SAE-4)	4
	106	Port Plug, Hex Head (BSPP G 1/4)	4
	109	Pull-out dowel pin .375" x 1.5" long, tapped #10-32	1
	111	Grease Fitting (Balcrank, 5000 Lincoln, 1/8-27 NPT)	2
112	Grease Relief Valve (50500, 1/8-27 NPT, Alemite 400-650 PSI)	2	

Parts in kits not sold individually

Seal and bearing kits can be ordered online at <http://www.parker.com/helac>

Part Number	Item #	Description	Qty
28411-3	401	Counterbalance Valve Kit: 2 x SAE-6 Ports (includes valve, mounting screws and o-rings) Top of valve stamped 28411-03	
		CB Valve	1
		Socket head cap screw; 5/16"-18 x 1.50" ASTM A574	4
28215-3	401	Standard Counterbalance Valve Kit: 2 x BSPP G3/8 Ports (includes valve, mounting screws and o-rings) Top of valve stamped 28215-03	
		CB Valve	1
		Socket head cap screw; 1/4"-20 x 1.50" ASTM A574	4
		Port plug: BSPP G3/8	2
	406	Hydraulic tube assembly (made locally)	1

Note: Parker Hannifin supplies many different counterbalance and motion control valves specific to an OEM application. If the valve you have is not one of the part numbers listed, contact the OEM of the equipment installed on to purchase the correct valve.

Part Number	Item #	Description	Qty
S28233		Seal Kit - Standard (Includes items below)	
	200	Cup - Seal	2
	201	Cup - Seal (energizer removed)	1
	202	T-Seal (used on one piece piston sleeve instead of item 202 & 203 cup seals)	1
	202	Cup - Seal	1
	203	Cup - Seal (energizer removed)	1
	205	Cup Seal	2
	206	Cup Seal	2
	208	O-Ring	1
	209	O-Ring	1
S28234		Bearing Kit 180° (Includes item below)	
	300	Wear Guide	2
	301	Wear Guide	1
	302	Wear Guide	2
	304	Thrust Washer	2
S28234-2		Bearing Kit 360° (Includes item below)	
	300	Wear Guide	1
	301	Wear Guide	1
	302	Wear Guide	5
	304	Thrust Washer	2

Parts in kits not sold individually



Parts List - L30-95

Parts listed are standard components per the catalog. Parker-Helac has and does make special designs for OEM's that may differ. Model codes beginning with L30-95-S, L30-95-ES or L30-95-MS could use different parts.

Parts

Part Number	Item #	Description	Qty
Consult Factory	01	Housing	1
28594	02	Shaft "E" 180° (SAE bolt circle)	1
29733	02	Shaft "M" 180° (Metric bolt circle)	1
28493	02	Shaft "E" 360° (SAE bolt circle)	1
29734	02	Shaft "M" 360° (Metric bolt circle)	1
S28599	03	Piston Sleeve 180°	1
S28500	03	Piston Sleeve 360°	1
28498	04	End Cap, S1 (no bolt circle)	1
28667	04	End Cap, S2 "E" (SAE bolt circle)	1
29732	04	End Cap, S2 "M" (Metric bolt circle)	1
28506	05	Lock Ring	1
28505		Hardware Kit: SAE Port Plugs (includes item 100, 105, 106, 106.1, 109, 111, 112)	
	100	Piston pull-out dowel pin, .375" x 1.0" long, hardened	1
	113	Set Screw (Socket head; 5/8"-11 x .625", Cup, Grade 8)	2
	105	Port plug, Socket Hex Head (SAE-4)	4
	106	Port Plug, Socket Hex Head (SAE-6)	4
	109	Pull-out dowel pin .375" x 1.75" long	1
	111	Grease Fitting (Balcrank, 5000 Lincoln, 1/8-27 NPT)	2
	112	**Grease Relief Valve (50500, 1/8-27 NPT, Alemite 400-650 PSI)	2
28505-4		Hardware Kit: BSPP G1/4 Port Plugs (includes item 100, 105, 106, 106.1, 109, 111, 112)	
	100	Piston dowel pin, .375" x 1.0" long, hardened	1
	113	Set Screw (Socket head; 5/8"-11 x .625", Cup, Grade 8)	2
	105	Port plug SAE-4	4
	106	Port Plug, Hex Head (BSPP G 1/4)	4
	109	Pull-out dowel pin .375" x 1.5" long, tapped #10-32	1
	111	Grease Fitting (Balcrank, 5000 Lincoln, 1/8-27 NPT)	2
28411-3	401	Counterbalance Valve Kit: 2 x SAE-6 Ports (includes valve, mounting screws and o-rings) Top of valve stamped 28411-03	
		CB Valve	1
		Socket head cap screw; 5/16"-18 x 1.50" ASTM A574	4
		Port plug: SAE-6 Hollow hex, o-ring	2

Parts in kits not sold individually

Part Number	Item #	Description	Qty
28215-3	401	Standard Counterbalance Valve Kit: 2 x BSPP G3/8 Ports (includes valve, mounting screws and o-rings) Top of valve stamped 28215-03	
		CB Valve	1
		Socket head cap screw; 5/16"-18 x 1.50" ASTM A574	4
		Port plug: BSPP G3/8	2
	406	Hydraulic tube assembly (made locally)	1

Note: Parker Hannifin supplies many different counterbalance and motion control valves specific to an OEM application. If the valve you have is not one of the part numbers listed, contact the OEM of the equipment installed on to purchase the correct valve.

Part Number	Item #	Description	Qty
S28503		Seal Kit - Standard (Includes items below)	
	200	Cup - Seal	2
	201	Cup - Seal (energizer removed)	1
	202	T-Seal (used on one piece piston sleeve instead of item 202 & 203 cup seals)	1
	202	Cup - Seal	1
	203	Cup - Seal (energizer removed)	1
	205	Cup Seal	2
	206	Cup Seal	2
	208	O-Ring	1
	209	O-Ring	1
	210	O-ring (for two piece piston sleeve)	1
	28628		Bearing Kit 180° (Includes item below)
300		Wear Guide	2
301		Wear Guide	1
302		Wear Guide	3
28504		Bearing Kit 360° (Includes item below)	
	300	Wear Guide	2
	301	Wear Guide	1
	302	Wear Guide	5
	304	Thrust Washer	2

Parts in kits not sold individually

Seal and bearing kits can be ordered online at <http://www.parker.com/helac>

Parts List

Parts List - L30-125

Parts listed are standard components per the catalog. Parker-Helac has and does make special designs for OEM's that may differ. Model codes beginning with L30-125-S, L30-125-ES or L30-125-MS could use different parts.

Parts

Part Number	Item #	Description	Qty
Consult Factory	01	Housing	1
28692	02	Shaft "E" 180° (SAE bolt circle)	1
29446	02	Shaft "M" 180° (Metric bolt circle)	1
28518	02	Shaft "E" 360° (SAE bolt circle)	1
29712	02	Shaft "M" 360° (Metric bolt circle)	1
S28697	03	Piston Sleeve 180°	1
S28385	03	Piston Sleeve 360°	1
28388	04	End Cap, S1 (no bolt circle)	1
28699	04	End Cap, S2 "E" (SAE bolt circle)	1
29445	04	End Cap, S2 "M" (Metric bolt circle)	1
28390	05	Lock Ring	1
S28522		Hardware Kit: SAE Port Plugs (includes item 100, 105, 106, 106.1, 109, 111, 112)	
	100	Piston dowel pin, .375" x 1.25" long, hardened	1
	113	Set Screw (Socket head; 5/8"-11 x .625", Cup, Grade 8)	2
	105	Port plug, Socket Hex Head (SAE-4)	4
	106	Port Plug, Socket Hex Head (SAE-8)	4
	109	Pull-out dowel pin .375" x 1.75" long	1
	111	Grease Fitting (Balcrank, 5000 Lincoln, 1/8-27 NPT)	2
29447-2		Hardware Kit: SAE Port Plugs (includes item 100, 105, 106, 106.1, 109, 111, 112)	
	100	Piston dowel pin, .375" x 1.25" long, hardened	1
	113	Set Screw (Socket head; 5/8"-11 x .625", Cup, Grade 8)	2
	105	Port plug, Socket Hex Head (SAE-4)	4
	106	Port Plug, Hex Head (BSPP G 1/2)	4
	109	Pull-out dowel pin .375" x 1.75" long, tapped #10-32	1
	111	Grease Fitting (Balcrank, 5000 Lincoln, 1/8-27 NPT)	2
112	Grease Relief Valve (50500, 1/8-27 NPT, Alemite 400-650 PSI)	2	

Parts in kits not sold individually

Seal and bearing kits can be ordered online at <http://www.parker.com/helac>

Part Number	Item #	Description	Qty
28411-3	401	Counterbalance Valve Kit: 2 x SAE-6 Ports (includes valve, mounting screws and o-rings) Top of valve stamped 28411-03	
		CB Valve	1
		Socket head cap screw; 5/16"-18 x 1.50" ASTM A574	4
28215-3	401	Standard Counterbalance Valve Kit: 2 x BSPP G3/8 Ports (includes valve, mounting screws and o-rings) Top of valve stamped 28215-03	
		CB Valve	1
		Socket head cap screw; 1/4"-20 x 1.50" ASTM A574	4
		Port plug: BSPP G3/8	2
	406	Hydraulic tube assembly (made locally)	1

Note: Parker Hannifin supplies many different counterbalance and motion control valves specific to an OEM application. If the valve you have is not one of the part numbers listed, contact the OEM of the equipment installed on to purchase the correct valve.

Part Number	Item #	Description	Qty
S28392		Seal Kit - Standard (Includes items below)	
	200	Cup - Seal	2
	201	Cup - Seal (energizer removed)	1
	202	T-Seal (used on one piece piston sleeve instead of item 202 & 203 cup seals)	1
	202	Cup - Seal	1
	203	Cup - Seal (energizer removed)	1
	205	Cup Seal	2
	206	Cup Seal	2
	208	O-Ring	1
	209	O-Ring	1
28701		Bearing Kit 180° (Includes item below)	
	300	Wear Guide	2
	301	Wear Guide	1
	302	Wear Guide	3
	304	Thrust Washer	2
S28393		Bearing Kit 360° (Includes item below)	
	300	Wear Guide	2
	301	Wear Guide	1
	302	Wear Guide	5
	304	Thrust Washer	2

Parts in kits not sold individually



Parts List - L30-165

Parts listed are standard components per the catalog. Parker-Helac has and does make special designs for OEM's that may differ. Model codes beginning with L30-165-S, L30-165-ES or L30-165-MS could use different parts.

Parts

Part Number	Item #	Description	Qty
Consult Factory	01	Housing	1
28740	02	Shaft "E" 180° (SAE bolt circle)	1
31937	02	Shaft "M" 180° (Metric bolt circle)	1
28761	02	Shaft "E" 360° (SAE bolt circle)	1
32164	02	Shaft "M" 360° (Metric bolt circle)	1
S28745	03	Piston Sleeve 180°	1
S28766	03	Piston Sleeve 360°	1
28748	04	End Cap, S1 (no bolt circle)	1
28755	04	End Cap, S2 "E" (SAE bolt circle)	1
31939	04	End Cap, S2 "M" (Metric bolt circle)	1
28750	05	Lock Ring	1
S28751		Hardware Kit: SAE Port Plugs (includes item 100, 105, 106, 106.1, 109, 111, 112)	
	100	Piston dowel pin, .375" x 1.25" long, hardened	1
	113	Set Screw (Socket head; 5/8"-11 x .625", Cup, Grade 8)	2
	105	Port plug, Socket Hex Head (SAE-4)	4
	106	Port Plug, Socket Hex Head (SAE-8)	4
	109	Pull-out dowel pin .375" x 1.75" long	1
	111	Grease Fitting (Balcrank, 5000 Lincoln, 1/8-27 NPT)	2
	112	**Grease Relief Valve (50500, 1/8-27 NPT, Alemite 400-650 PSI)	2
28751-5		Hardware Kit: BSPP G1/4 Port Plugs (includes item 100, 105, 106, 106.1, 109, 111, 112)	
	100	Piston dowel pin, .375" x 1.25" long, hardened	1
	113	Set Screw (Socket head; 5/8"-11 x .625", Cup, Grade 8)	2
	105	Port plug SAE-4	4
	106	Port Plug, Hex Head (BSPP G 3/8)	4
	109	Pull-out dowel pin .375" x 1.5" long, tapped #10-32	1
	111	Grease Fitting (Balcrank, 5000 Lincoln, 1/8-27 NPT)	2
28411-3		Counterbalance Valve Kit: 2 x SAE-6 Ports (includes valve, mounting screws and o-rings) Top of valve stamped 28411-03	
	401	CB Valve	1
		Socket head cap screw; 5/16"-18 x 1.50" ASTM A574	4
		Port plug: SAE-6 Hollow hex, o-ring	2

Parts in kits not sold individually

Part Number	Item #	Description	Qty
28215-3		Standard Counterbalance Valve Kit: 2 x BSPP G3/8 Ports (includes valve, mounting screws and o-rings) Top of valve stamped 28215-03	
	401	CB Valve	1
		Socket head cap screw; 5/16"-18 x 1.50" ASTM A574	4
		Port plug: BSPP G3/8	2
	406	Hydraulic tube assembly (made locally)	1

Note: Parker Hannifin supplies many different counterbalance and motion control valves specific to an OEM application. If the valve you have is not one of the part numbers listed, contact the OEM of the equipment installed on to purchase the correct valve.

Part Number	Item #	Description	Qty
28752		Seal Kit - Standard (Includes items below)	
	200	Cup - Seal	2
	201	Cup - Seal (energizer removed)	1
	202	Cup - Seal	1
	203	Cup - Seal (energizer removed)	1
	205	Cup Seal	2
	206	Cup Seal	2
	208	O-Ring	1
	209	O-Ring	1
	210	O-ring (for two piece piston sleeve)	1
28753		Bearing Kit 180° (Includes item below)	
	300	Wear Guide	2
	301	Wear Guide	1
	302	Wear Guide	3
28768		Bearing Kit 360° (Includes item below)	
	300	Wear Guide	2
	301	Wear Guide	1
	302	Wear Guide	5
	304	Thrust Washer	2

Parts in kits not sold individually

Seal and bearing kits can be ordered online at <http://www.parker.com/helac>

Parts List

Parts List - L30-215

Parts listed are standard components per the catalog. Parker-Helac has and does make special designs for OEM's that may differ. Model codes beginning with L30-215-S, L30-215-ES or L30-215-MS could use different parts.

Parts

Part Number	Item #	Description	Qty
Consult Factory	01	Housing	1
32465	02	Shaft "E" 180° (SAE bolt circle)	1
31547	02	Shaft "M" 180° (Metric bolt circle)	1
28783	02	Shaft "E" 360° (SAE bolt circle)	1
31503	02	Shaft "M" 360° (Metric bolt circle)	1
S28655	03	Piston Sleeve 180°	1
S28793	03	Piston Sleeve 360°	1
28776	04	End Cap, S1 (no bolt circle)	1
28660	04	End Cap, S2 "E" (SAE bolt circle)	1
31534	04	End Cap, S2 "M" (Metric bolt circle)	1
28662	05	Lock Ring	1
28665-1		Hardware Kit: SAE Port Plugs (includes item 100, 105, 106, 106.1, 109, 111, 112)	
964015	100	Piston dowel pin, .437" x 1.50" long, hardened	1
960155	113	Set Screw (Socket head; 5/8"-11 x .625", Cup, Grade 8)	2
977008	105	Port plug, Socket Hex Head (SAE-4)	4
977018	106	Port Plug, Socket Hex Head (SAE-8)	4
964050	109	Pull-out dowel pin .375" x 1.75" long	1
936002	111	Grease Fitting (Balcrank, 5000 Lincoln, 1/8-27 NPT)	2
938001	112	**Grease Relief Valve (50500, 1/8-27 NPT, Alemite 400-650 PSI)	2
32761-1		Hardware Kit: SAE Port Plugs (includes item 100, 105, 106, 106.1, 109, 111, 112)	
964015	100	Piston dowel pin, .437" x 1.50" long, hardened	1
960155	113	Set Screw (Socket head; 5/8"-11 x .625", Cup, Grade 8)	2
977008	105	Port plug, Socket Hex Head (SAE-4)	4
977023	106	Port Plug, Hex Head (BSPP G 3/8)	4
964050	109	Pull-out dowel pin .375" x 1.75" long, tapped #10-32	1
936002	111	Grease Fitting (Balcrank, 5000 Lincoln, 1/8-27 NPT)	2
938001	112	Grease Relief Valve (50500, 1/8-27 NPT, Alemite 400-650 PSI)	2

Parts in kits not sold individually

Seal and bearing kits can be ordered online at <http://www.parker.com/helac>

Part Number	Item #	Description	Qty
28411-3	401	Counterbalance Valve Kit: 2 x SAE-6 Ports (includes valve, mounting screws and o-rings) Top of valve stamped 28411-03	
		CB Valve	1
		Socket head cap screw; 5/16"-18 x 1.50" ASTM A574	4
		Port plug: SAE-6 Hollow hex, o-ring	2
28215-3	401	Standard Counterbalance Valve Kit: 2 x BSPP G3/8 Ports (includes valve, mounting screws and o-rings) Top of valve stamped 28215-03	
		CB Valve	1
		Socket head cap screw; 1/4"-20 x 1.50" ASTM A574	4
		Port plug: BSPP G3/8	2
	406	Hydraulic tube assembly (made locally)	1

Note: Parker Hannifin supplies many different counterbalance and motion control valves specific to an OEM application. If the valve you have is not one of the part numbers listed, contact the OEM of the equipment installed on to purchase the correct valve.

Part Number	Item #	Description	Qty
28663		Seal Kit - Standard (Includes items below)	
	200	Cup - Seal	2
	201	Cup - Seal (energizer removed)	1
	202	Cup - Seal	1
	203	Cup - Seal (energizer removed)	1
	205	Cup Seal	2
	206	Cup Seal	2
	208	O-Ring	1
	209	O-Ring	1
	210	O-ring (for two piece piston sleeve)	1
28664		Bearing Kit 180° (Includes item below)	
	300	Wear Guide	2
	301	Wear Guide	1
	302	Wear Guide	3
	304	Thrust Washer	2
28782		Bearing Kit 360° (Includes item below)	
	300	Wear Guide	2
	301	Wear Guide	1
	302	Wear Guide	5
	304	Thrust Washer	2

Parts in kits not sold individually



Parts List - L30-380

Parts listed are standard components per the catalog. Parker-Helac has and does make special designs for OEM's that may differ. Model codes beginning with L30-380-S, L30-380-ES or L30-380-MS could use different parts.

Parts

Part Number	Item #	Description	Qty
Consult Factory	01	Housing	1
28806	02	Shaft "E" 210° (SAE bolt circle)	1
29750	02	Shaft "M" 210° (Metric bolt circle)	1
S28810	03	Piston Sleeve 210°	1
28776	04	End Cap, S1 (no bolt circle)	1
28660	04	End Cap, S2 "E" (SAE bolt circle)	1
31534	04	End Cap, S2 "M" (Metric bolt circle)	1
28662	05	Lock Ring	1
28665-1		Hardware Kit: SAE Port Plugs (includes item 100, 105, 106, 106.1, 109, 111, 112)	
964015	100	Piston dowel pin, .437" x 1.50" long, hardened	1
960155	113	Set Screw (Socket head; 5/8"-11 x .625", Cup, Grade 8)	2
977008	105	Port plug, Socket Hex Head (SAE-4)	4
977018	106	Port Plug, Socket Hex Head (SAE-8)	4
964050	109	Pull-out dowel pin .375" x 1.75" long	1
936002	111	Grease Fitting (Balcrank, 5000 Lincoln, 1/8-27 NPT)	2
938001	112	**Grease Relief Valve (50500, 1/8-27 NPT, Alemite 400-650 PSI)	2
32761-1		Hardware Kit: SAE Port Plugs (includes item 100, 105, 106, 106.1, 109, 111, 112)	
964015	100	Piston dowel pin, .437" x 1.50" long, hardened	1
960155	113	Set Screw (Socket head; 5/8"-11 x .625", Cup, Grade 8)	2
977008	105	Port plug, Socket Hex Head (SAE-4)	4
977023	106	Port Plug, Hex Head (BSPP G 3/8)	4
964050	109	Pull-out dowel pin .375" x 1.75" long, tapped #10-32	1
936002	111	Grease Fitting (Balcrank, 5000 Lincoln, 1/8-27 NPT)	2
938001	112	Grease Relief Valve (50500, 1/8-27 NPT, Alemite 400-650 PSI)	2

Parts in kits not sold individually

Part Number	Item #	Description	Qty
28411-3	401	Counterbalance Valve Kit: 2 x SAE-6 Ports (includes valve, mounting screws and o-rings) Top of valve stamped 28411-03	
		CB Valve	1
		Socket head cap screw; 5/16"-18 x 1.50" ASTM A574	4
		Port plug: SAE-6 Hollow hex, o-ring	2
28215-3	401	Standard Counterbalance Valve Kit: 2 x BSPP G3/8 Ports (includes valve, mounting screws and o-rings) Top of valve stamped 28215-03	
		CB Valve	1
		Socket head cap screw; 1/4"-20 x 1.50" ASTM A574	4
		Port plug: BSPP G3/8	2
	406	Hydraulic tube assembly (made locally)	1

Note: Parker Hannifin supplies many different counterbalance and motion control valves specific to an OEM application. If the valve you have is not one of the part numbers listed, contact the OEM of the equipment installed on to purchase the correct valve.

Part Number	Item #	Description	Qty
28663		Seal Kit - Standard (Includes items below)	
	200	Cup - Seal	2
	201	Cup - Seal (energizer removed)	1
	202	Cup - Seal	1
	203	Cup - Seal (energizer removed)	1
	205	Cup Seal	2
	206	Cup Seal	2
	208	O-Ring	1
	209	O-Ring	1
	210	O-ring (for two piece piston sleeve)	1
28782		Bearing Kit 360° (Includes item below)	
	300	Wear Guide	2
	301	Wear Guide	1
	302	Wear Guide	5
	304	Thrust Washer	2

Parts in kits not sold individually

Seal and bearing kits can be ordered online at <http://www.parker.com/helac>



Disassembly

Disassembly



Before Disassembly

NOTICE

All numbers that appear in parenthesis () are referring to items on page 8 or 9.

Inspect the actuator for corrosion prior to disassembly. Severe corrosion can make it difficult to unthread and remove the lock nut (5) and end cap (4). If corrosion is evident, soak the effected areas with penetrating oil for several hours before disassembly. It is required prior to disassembly, that the shaft is rotated completely clockwise and that the valve block is removed, (See valve block drawing and parts list on page 10) and that the actuator is placed in a pipe vise.

Disassembly

Be sure actuator has been fully rotated, valve block removed, and actuator is firmly secured to the pipe vise.

1. Remove port plugs (106) and both grease relief and grease fittings (111 and 112) for ease of disassembly and assembly



There could be hydraulic pressure built up behind the port plugs, use caution when removing. Wear safety glasses at all times.

2. Drain the actuator of all oil into a suitable container.

3. Using a hex wrench, remove the 4 port plugs (105) from the locknut (5).

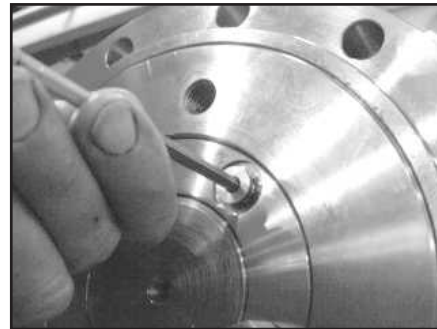

4. Thread a bolt into each pull-out dowel pin (109) located behind 2 of the port plugs (105) in the lock nut (5), pull straight out to remove.



5. Insert two adaptor fittings opposite each other into the lock nut (5). Place a pry bar between the adaptor fittings and turn counterclockwise to remove the lock nut (5) from the threaded end of the shaft (2).

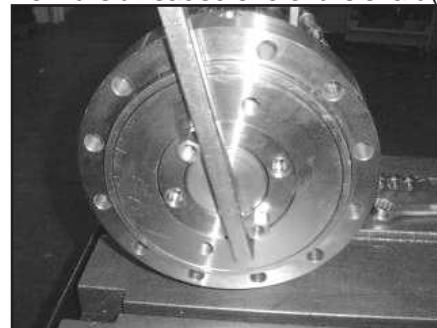

Disassembly

- Insert two threaded bolts opposite each other into the end cap (4). Pull straight out to remove end cap (4). See Photo Below

NOTICE

If needed, to break the seal friction, the end cap can be removed by first removing the shaft (see step 7) then tapping the inside of the end cap through the actuator housing and piston sleeve with a rubber mallet and plastic mandrel. Do not let end cap fall.

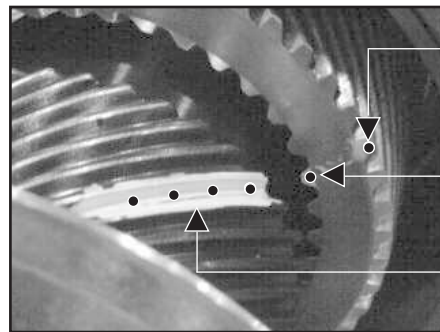
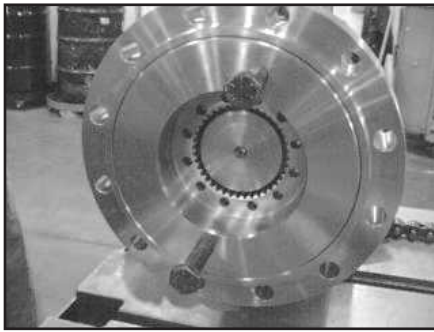
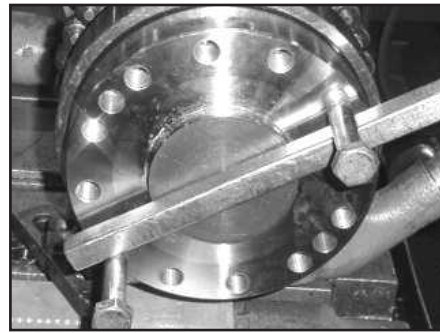

Piston Gear to Housing timing mark

Piston Gear to Shaft timing mark

Shaft gear to Piston timing marks

- Thread two bolts into the shaft (2) flange. Using a long pry bar turn the shaft (2) counterclockwise. It will start to rotate out of the housing. If it does not rotate out of the housing, use a plastic mandrel to tap the threaded end to break the hydraulic lock and start the shaft out of the housing. (**Do not rotate shaft out of gear engagement with the piston**). Look on the gear end of the piston sleeve (3) and locate the existing timing marks (center punches), make new timing marks if needed. Take a felt pen and clearly mark the gear engagement at the timing marks on both the piston and shaft. Upon reassembly the same gear engagement (timing) has to be achieved. Rotate the shaft out of the actuator. Support the weight of the shaft to prevent damage to the rod surface. See Photos to Right.

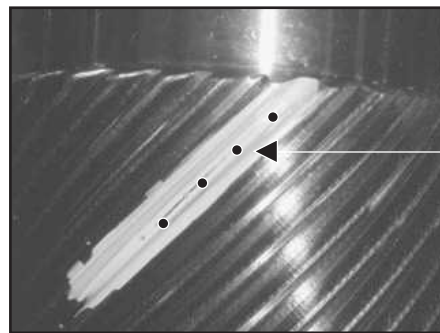

Shaft Gear to Piston timing marks

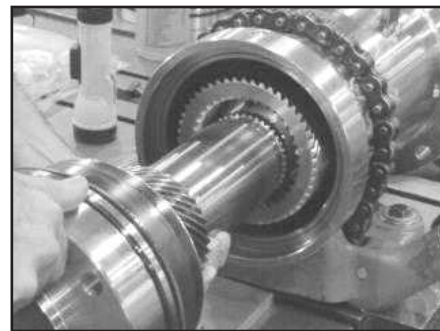

Disassembly

- Using a plastic mandrel and rubber mallet, drive the piston sleeve assembly towards the end cap end of the actuator. Stop when the gear end of the piston sleeve is flush with the Housing (1) ring gear.

NOTICE
To avoid damage to machined parts:
Carefully remove seals using removal tools with rounded edges.

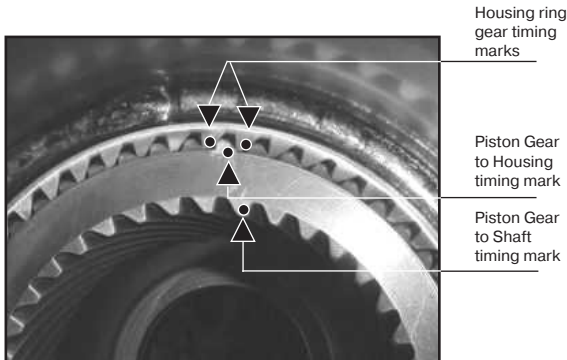

- Locate the timing marks on the piston sleeve assembly (3) and the housing (1) ring gear, clearly mark them with a felt pen (make new timing marks if none are found). Continue to drive the piston sleeve assembly out of the housing ring gear. Stop immediately after the gear teeth come out of engagement. Take a felt pen and put a mark on top of the piston and a corresponding mark on the thrust surface of the housing (see photo below). This mark will simplify assembly later. Remove the piston sleeve assembly from the housing. Do not allow the piston to

bind or jam in the housing bore. Support the weight of the piston to prevent damage to the housing bore.

- Remove the OD O-ring (209) from the locknut (5) using a pick or seal tool.



- Remove the ID O-ring (208) from the locknut (5) using a pick or seal tool.



- Remove the ID cup seal (200) from the end cap (4) using a pick or seal tool.

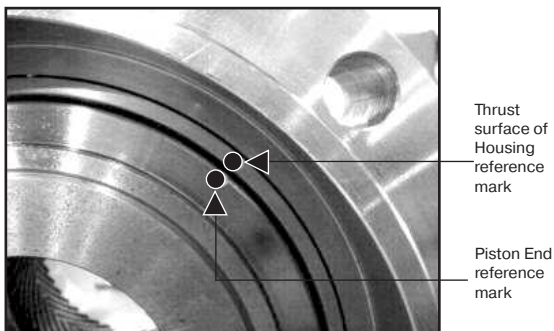

Disassembly

- 13.** Remove the wear guide (302) from the end cap (4).



- 16.** Remove the exclusion seal (206) from the end cap (4) using a seal tool.



- 14.** Remove the main pressure seal (205) from the end cap (4) using a seal tool.



- 17.** Remove the ID cup seal (200) from the piston sleeve assembly (3) using a seal tool.



- 15.** Remove the thrust washer (304) from the end cap (4).



- 18.** Remove the ID wear guide (301) from the piston sleeve assembly (3) using a pick tool.



Disassembly

- 19.** Remove the ID cup seal (201) from the piston sleeve assembly (3) using a small pick or seal tool.



- 22.** Remove the OD cup seal (203) from the piston sleeve assembly (3) using a small pick or seal tool.



- 20.** Remove the wear guide (300) from the piston sleeve assembly (3).



- 23.** Remove the wear guides (300 & 302) from the shaft (2).

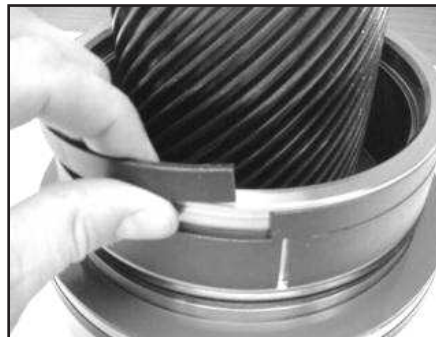

- 21.** Remove the OD cup seal (202) from the piston sleeve assembly (3) using a small pick or seal tool.



- 25.** Remove the main pressure seal (205) from the shaft (2) using a seal tool.



Disassembly

- 26.** Remove the thrust washer (304) from the shaft (2).



- 27.** Remove the exclusion seal (206) from the shaft (2) using a seal tool.



Seal and Wear Guide Installation

	⚠ WARNING
	Avoid personal injury and machinery damage: Read the Service and Repair Manual for proper installation, maintenance and repair procedures.

⚠ CAUTION
To avoid injury or damage to product: Secure product to slotted table or vise.

	⚠ CAUTION
	Spraying fluids. Contents under pressure. Wear approved eye protection. Use caution when removing port plugs and fittings.

NOTICE
To avoid contamination to machined parts: Make sure work area is clean.

Pre-Assembly

All actuators are timed according to OEM specifications at Helac's production facility. The timing ensures that the actuator will stop at the required position at the end of the rotation in either direction. Wrong timing can cause the actuator to over rotate resulting in interference and damage of equipment components. Rotation being too short can limit the operating range of the equipment. The proper gear engagement of shaft, piston and housing ensures the correct timing.

For repair personnel not familiar with the L30 actuator, it is recommended that a "dry run" without the seals installed but with the wear guides and thrust washer installed, be performed prior to final assembly. Proceed to assembly procedures starting on page 29, insure proper fit and timing of actuator, then disassemble and apply all seals and wear guides. For seal and wear guide orientation use the cut-away drawing on page 8 as a reference.

NOTICE
To avoid damage to machined parts: Carefully remove seals using removal tools with rounded edges.

NOTICE

Lubricate all seals and contact surfaces with hydraulic oil. Apply a thin layer of lubricating grease to the thrust washers.

Inspection

1. Clean all parts in a wash tank and dry with compressed air prior to inspecting.
2. Carefully inspect all critical areas: Seal grooves, wear guide grooves, thrust surfaces, shaft surfaces, housing bore and gear teeth for any surface finish abnormalities.

1. Using a seal tool install the OD O-ring (209) onto the locknut (5).



2. Install the ID O-ring (208) into the lock nut (5).



3. Install the ID cup seal (200) into the end cap (4).



Seal and Wear Guide Installation

4. Install the exclusion seal (206) onto the end cap (4) using a seal tool.



5. Lightly grease both sides of the thrust washer with Lithium grease (304) and install onto the end cap (4).



6. Install the main pressure seal (205) onto the end cap (4) using a seal tool.



7. Install the wear guide (302) onto the end cap (4).



8. Install the OD cup seal (203) with the energizer ring removed, onto the piston sleeve assembly (3) using a seal tool.



9. Install the OD cup seal (202) onto the piston sleeve assembly (3) using a seal tool.



*** NOTE: Several models use O.D. T-seal that comes without an energizer ring. Install the O.D. seal and two backup rings.**

Seal and Wear Guide Installation

- 10.** Install the wear guide (300) onto the piston sleeve assembly (3).



- 13.** Install the ID cup seal (200) into the piston sleeve assembly (3).

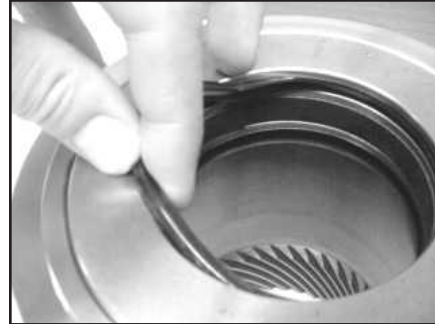

- 11.** Install the ID cup seal (201) with the energizer ring removed, into the piston sleeve assembly (3).



- 14.** Install the exclusion seal (206) onto the shaft (2).



- 12.** Install the ID wear guide (301) into the piston sleeve assembly (3).



- 15.** Lightly grease both sides of the thrust washer with Lithium grease (304) and install onto the shaft (2).



Seal and Wear Guide Installation

16. Install the main pressure seal (205) onto the shaft (2).



17. Install wear guides (300&302) onto the shaft (2).

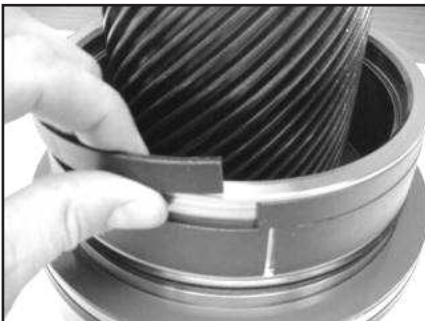

Assembly

Assembly



Assembly

1. Secure the actuator to a pipe vise, then carefully slide the piston sleeve assembly (3), gear teeth first, into the end cap end of the actuator. **(Be careful not to bind or jam the piston sleeve assembly in the housing)**. Stop when the end of the piston is flush with the thrust surface of the housing (1) and the two reference marks, made during disassembly line up. (The gear teeth of the piston sleeve assembly should be almost ready to engage the housing (1) ring gear teeth).

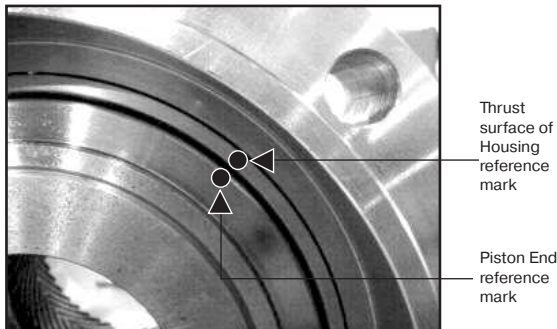

2. Confirm proper gear alignment from the shaft flange end, then use a rubber mallet and plastic mandrel to engage the piston sleeve assembly gear teeth and housing ring gear teeth. Drive piston in until the front of the piston sleeve is lined up with the housing ring gear (see photo below). Locate the timing marks on the piston sleeve gear teeth and the housing ring gear teeth. Both timing marks should be lined up. If not, disengage the piston from the ring gear and line up with the correct gear engagement.

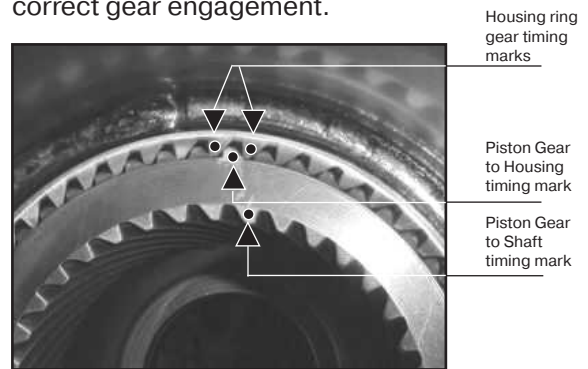

3. Using a rubber mallet and plastic mandrel, continue to drive piston sleeve assembly (3) towards the shaft flange end of actuator until the piston sleeve assembly is fully seated against the housing ring gear.



Assembly

4. Install the shaft (2) threaded end first into the piston sleeve assembly (3). The shaft (2) gear teeth timing mark and the piston sleeve assembly (3) gear teeth timing mark must be lined up.

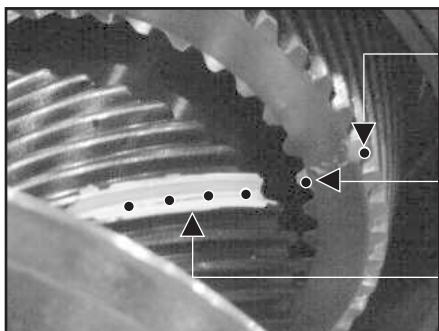
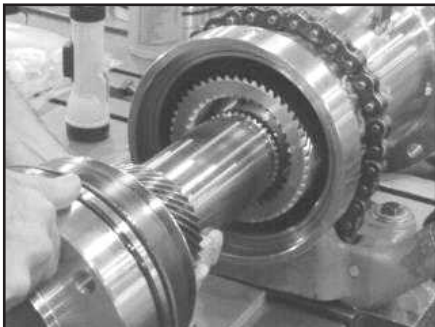

Piston Gear to Housing timing mark

Piston Gear to Shaft timing mark

Shaft gear to Piston timing marks

5. Install two bolts into the shaft (2) flange. Using a long pry bar turn the shaft (2) clockwise. Be sure both timing marks on the gear teeth are lined up. Rotate shaft (2) in until approximately 2 inches are still between the shaft flange and the housing.



6. Grease the end cap (4) splines with Lithium grease. Install two bolts in the end cap and slide end cap into the housing. Carefully tap the end cap (4) with a rubber mallet until the seals enter the housing and the end cap becomes flush with the housing.

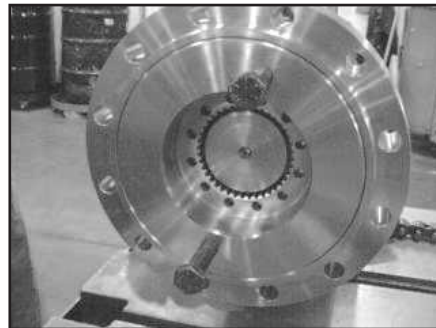

7. Using the pry bar turn the shaft (2) clockwise slowly to engage the shaft (2) splines and the end cap (4) splines. If needed, use the two bolts on the end cap to turn end cap for proper alignment of the splines. After engagement of splines, fully seat the shaft (2) clockwise into the housing.

NOTICE
To avoid damage to machined parts:
Carefully remove seals using removal tools with rounded edges.

Assembly

8. Grease the threads and contact surfaces of the end cap (4), shaft (2) and locknut (5). Thread the locknut (5) onto the threaded end of the shaft (2). Install two adaptor fittings opposite each other into the locknut (5). Using the pry bar, turn lock nut clockwise and tighten, per chart on page 24.

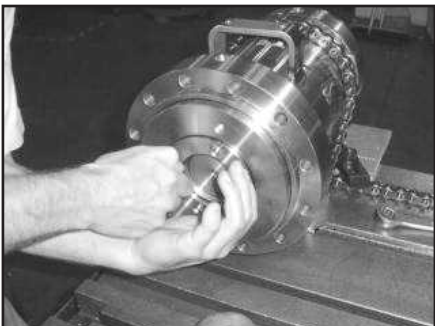

9. Rotate the locknut (5) counterclockwise just far enough to insert the 2 pull-out dowel pins (109) opposite each other.



10. Install and tighten the port plugs (105) into the locknut (5) using a hex wrench.



11. Install the valve block (if equipped), hydraulic lines, all port plugs and grease fittings onto the actuator.

L30 End Cap / Lock Nut Torque Chart

Model	Ft-Lbs	Nm
L30 – 25	200	271
L30 – 65	200	271
L30 – 95	250	339
L30 – 125	250	339

Greasing Thrust Washers

After the actuator is assembled but before it is put back into service, the thrust washers and exclusion seals must be packed with Lithium grease.



1. There are two male grease fittings (111) and two grease relief ports (112), one of each (111, 112) is located at both ends of the outer diameter of the housing (1). (See exploded view on page 8 for reference).

NOTICE If a hydraulic test bench is not available, the actuator can be rotated by hand, open the pressure ports and use a pry bar with cap screws inserted into the shaft flange to turn the shaft in the desired direction.

2. Insert the tip of the female grease nozzle onto the male grease fitting (111) and apply grease. Continue applying until grease flows from the relief port (112). Cycle the actuator five times and apply grease again. Repeat this process at the other end of the housing (1).

NOTICE Helac Corporation recommends a greasing schedule of every three months. Annually inspect and replace seals and bearings, if needed.

Testing the Actuator

	WARNING Avoid personal injury and machinery damage: Read the Service and Repair Manual for proper installation, maintenance and repair procedures.	CAUTION To avoid injury or damage to product: Secure product to slotted table or vise.
	CAUTION Spraying fluids. Contents under pressure. Wear approved eye protection. Use caution when removing port plugs and fittings.	NOTICE To avoid contamination to machined parts: Make sure work area is clean.
	CAUTION To avoid injury or damage to product: Pinch points may occur when testing, bleeding, installing and using actuator due to moving components.	

Testing the Actuator

If the equipment is available, the actuator should be tested on a hydraulic test bench. The breakaway pressure—the pressure at which the shaft begins to rotate—should be to 650 psi (45 bar) maximum. Cycle the actuator at least 25 times at 3000 psi (210 bar) pressure. After the 25 rotations, increase the pressure to 4500 psi (315 bar) to check for leaks and cracks. Perform the test again at the end of the rotation in the opposite direction.

Testing the Actuator for Internal Leakage

Plug the valve ports and connect the hydraulic lines to the housing ports. Bleed all air from the actuator (see *Installation and Bleeding Procedure* on page 26) Rotate the shaft to the end of rotation at 3000 psi (210 bar) and maintain pressure. Remove the hydraulic line from the non-pressurized side.

Continuous oil flow from the open housing port indicates internal leakage across the piston. Replace the line and rotate the shaft to the end of rotation in the opposite direction. Repeat the test procedure outlined above for the other port. If there is an internal leak, disassemble, inspect and repair.

Installation and Bleeding

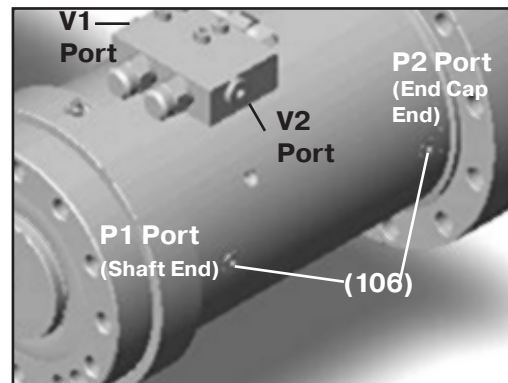
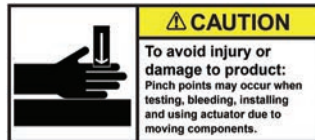
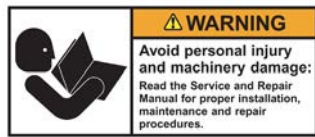

Installation and Bleeding

After installation of the actuator onto the equipment, it is important that all safety devices such as tie rods or safety cables be properly reattached. The actuator body is equipped with a pair of port plugs (106) which can be removed for bleeding.

For actuators with an optional valve block installed.

1. Connect the pressure lines to ports V1 and V2.
2. Connect a hydraulic line to port P1 routed either back to tank or to a 5 gallon container to collect the purged oil.
3. Apply pressure to port V2 until actuator has fully rotated to one side.
4. With port P1 still open, apply pressure to the primary port V1 allowing oil/air to be purged from the open port.
5. Install port P1 plug and attach purge line to port P2.
6. Apply pressure to port V1 until actuator has fully rotated in the opposite direction.
7. With port P2 still open, apply pressure to port V2 allowing oil/air to be purged from the open port.
8. Install port P2 plug.
9. All air should be purged from the actuator.

For actuator without optional valve block installed.

Air should be purged through the upper ports P1 and P2. With that in mind, apply pressure hoses to the lower ports P1 and P2.

1. Connect a hydraulic line to upper port P1 routed either back to tank or to a 5 gallon container to collect the purged oil.
2. Apply pressure to lower port P2 until actuator has fully rotated to one side.
3. With upper port P1 still open, apply pressure to the lower port P1 allowing oil/air to be purged from the open port.
4. Install upper port P1 plug and attach purge line to upper port P2.
5. Apply pressure to lower port P1 until actuator has fully rotated to the opposite side.
6. With upper port P2 still open, apply pressure to the lower port P2 allowing oil/air to be purged from the open port.
7. Install upper port P2 plug.
8. All air should be purged from the actuator.

Troubleshooting Guide

PROBLEM	SEE CAUSES AND SOLUTIONS BELOW
Shaft rotates slowly or not at all	1 - 6
Operation is erratic or not responsive	7
Shaft will not fully rotate	8, 9
Selected position cannot be maintained	3, 4, 7

CAUSE	SOLUTION
1. Insufficient torque output	Verify correct operating pressure. Do not exceed OEM's pressure specifications. Load may be above maximum capacity of the actuator.
2. Low rate of fluid flow	Inspect ports for obstructions and hydraulic lines for restrictions and leaks.
3. Control or counterbalance valve has internal leak	Disconnect hydraulic lines and bypass valve. Leave valve ports open and operate the actuator through housing ports (do not exceed OEM's operating pressure). The valve must be replaced if a steady flow of fluid is seen coming from the valve ports.
4. Piston and/or shaft seal leak	Remove the plug and the housing's valve ports. Operate the actuator through the housing ports. Conduct the internal leakage test as described in the Testing section on page 32 of this manual.
5. Corrosion build-up on the thrust surfaces	Re-build the actuator. Remove all rust then polish.*
6. Swollen seals and composite bearings caused by incompatible hydraulic fluid (Standard actuators only)	Re-build the actuator. Use fluid that is compatible with seals and bearings. Contact Helac Corporation for more information.
7. Air in actuator	Purge air from actuator. See bleeding procedures outlined on page 33.
8. Twisted or chipped gear teeth overload condition.	Check for gear binding. Actuator may not be able to be re-built and may need to be replaced.
9. Port fittings are obstructing the piston during stroke	Check thread length of port fittings. Fittings should not reach inside the housing bore.

* Replacement parts may be needed.

Catalog HY34- 1130 Offer of Sale

Helical, Hydraulic Rotary Actuators L30 Series Service & Repair Manual

The items described in this document and other documents and descriptions provided by Parker Hannifin Corporation, its subsidiaries and its authorized distributors ("Seller") are hereby offered for sale at prices to be established by Seller. This offer and its acceptance by any customer ("Buyer") shall be governed by all of the following Terms and Conditions. Buyer's order for any item described in its document, when communicated to Seller verbally, or in writing, shall constitute acceptance of this offer. All goods, services or work described will be referred to as "Products".

1. Terms. All sales of Products by Seller will be governed by, and are expressly conditioned upon Buyer's assent to, these Terms. These Terms are incorporated into any Quote provided by Seller to Buyer. Buyer's order for any Products whether communicated to Seller verbally, in writing, by electronic data interface or other electronic commerce, shall constitute acceptance of these Terms. Seller objects to any contrary or additional terms or conditions of Buyer. Reference in Seller's order acknowledgement to Buyer's purchase order or purchase order number shall in no way constitute an acceptance of any of Buyer's terms or conditions of purchase. Any Quote made by Seller to Buyer shall be considered a firm and definite offer and shall not be deemed to be otherwise despite any language on the face of the Quote. Seller reserves all rights to accept or reject any purported acceptance by Buyer to Seller's Quote if such purported acceptance attempts to vary the terms of the Quote. If Seller ships Products after Buyer issues an acceptance to the Quote, any additional or different terms proposed by Buyer will not become part of the parties' business relationship unless agreed to in a writing that is signed by an authorized representative of Seller, excluding email correspondence. If the transaction proceeds without such agreement on the part of Seller, the business relationship will be governed solely by these Terms and the specific terms in Seller's Quote.

2. Price; Payment. The Products set forth in the Quote are offered for sale at the prices indicated in the Quote. Unless otherwise specifically stated in the Quote, prices are valid for thirty (30) days and do not include any sales, use, or other taxes or duties. Seller reserves the right to modify prices for any reason and at any time by giving ten (10) days prior written notice. Unless otherwise specified by Seller, all prices are F.C.A. Seller's facility (INCOTERMS 2020). All sales are contingent upon credit approval and full payment for all purchases is due thirty (30) days from the date of invoice (or such date as may be specified in the Quote). Under any circumstances, Buyer may not withhold or suspend payment of any amounts due and payable as a deduction, set-off or recoupment of any amount, claim or dispute with Seller. Unpaid invoices beyond the specified payment date incur interest at the rate of 1.5% per month or the maximum allowable rate under applicable law. Seller reserves the right to require advance payment or provision of securities for first and subsequent deliveries if there is any doubt, in Seller's sole determination, regarding the Buyer's creditworthiness or for other business reasons. If the requested advance payment or securities are not provided to Seller's satisfaction, Seller reserves the right to suspend performance or reject the purchase order, in whole or in part, without prejudice to Seller's other rights or remedies, including the right to full compensation. Seller may revoke or shorten any payment periods previously granted in Seller's sole determination. The rights and remedies herein reserved to Seller are cumulative and in addition to any other or further rights and remedies available at law or in equity. No waiver by Seller of any breach by Buyer of any provision of these terms will constitute a waiver by Seller of any other breach of such provision.

3. Shipment; Delivery; Title and Risk of Loss. All delivery dates are approximate, and Seller is not responsible for damages or additional costs resulting from any delay. All deliveries are subject to our ability to procure materials from our suppliers. Regardless of the manner of shipment, delivery occurs and title and risk of loss or damage pass to Buyer, upon placement of the Products with the carrier at Seller's facility. Unless otherwise agreed prior to shipment and for domestic delivery locations only, Seller will select and arrange, at Buyer's sole expense, the carrier and means of delivery. When Seller selects and arranges the carrier and means of delivery, freight and insurance costs for shipment to the designated delivery location will be prepaid by Seller and added as a separate line item to the invoice. Buyer shall be responsible for any additional shipping charges incurred by Seller due to Buyer's acts or omissions. Buyer shall not return or repackage any Products without the prior written authorization from Seller, and any return shall be at the sole cost and expense of Buyer.

4. Warranty. The warranty for the Products is as follows: (i) Goods are warranted against defects in material or workmanship for a period of eighteen (18) months from the date of delivery or 2,000 hours of use, whichever occurs first; (ii) Services shall be performed in accordance with generally accepted practices and using the degree of care and skill that is ordinarily exercised and customary in the field to which the Services pertain and are warranted for a period of six (6) months from the date of completion of the Services; and (iii) Software is only warranted to perform in accordance with applicable specifications provided by Seller to Buyer for ninety (90) days from the date of delivery or, when downloaded by a Buyer or end-user, from the date of the initial download. All prices are based upon the exclusive limited warranty stated above, and upon the following disclaimer: **EXEMPTION CLAUSE; DISCLAIMER OF WARRANTY, CONDITIONS, REPRESENTATIONS: THIS WARRANTY IS THE SOLE AND ENTIRE WARRANTY, CONDITION, AND REPRESENTATION, PERTAINING TO PRODUCTS. SELLER DISCLAIMS ALL OTHER WARRANTIES, CONDITIONS, AND REPRESENTATIONS, WHETHER STATUTORY, EXPRESS OR IMPLIED, INCLUDING BUT NOT LIMITED TO THOSE RELATING TO DESIGN, NON-INFRINGEMENT, MERCHANTABILITY, AND FITNESS FOR A PARTICULAR PURPOSE. SELLER DOES NOT WARRANT THAT THE SOFTWARE IS ERROR-FREE OR FAULT-TOLERANT, OR THAT BUYER'S USE THEREOF WILL BE SECURE OR UNINTERRUPTED, UNLESS OTHERWISE AUTHORIZED IN WRITING BY SELLER, THE SOFTWARE SHALL NOT BE USED IN CONNECTION WITH HAZARDOUS OR HIGH-RISK ACTIVITIES OR ENVIRONMENTS. EXCEPT AS EXPRESSLY STATED HEREIN, ALL PRODUCTS ARE PROVIDED "AS IS".**

5. Claims; Commencement of Actions. Buyer shall promptly inspect all Products upon receipt. No claims for shortages will be allowed unless reported to Seller within ten (10) days of delivery. Buyer shall notify Seller of any alleged breach of warranty within thirty (30) days after the date the non-conformance is or should have been discovered by Buyer. Any claim or action against Seller based upon breach of contract or any other theory, including tort, negligence, or otherwise must be commenced within twelve (12) months from the date of the alleged breach or other alleged event, without regard to the date of discovery.

6. LIMITATION OF LIABILITY. IN THE EVENT OF A BREACH OF WARRANTY, SELLER WILL, AT ITS OPTION, REPAIR OR REPLACE THE NON-CONFORMING PRODUCTS, RE-PERFORM THE SERVICES, OR REFUND THE PURCHASE PRICE PAID WITHIN A REASONABLE PERIOD OF TIME. IN NO EVENT IS SELLER LIABLE FOR ANY SPECIAL, INDIRECT, INCIDENTAL OR CONSEQUENTIAL DAMAGES INCLUDING ANY LOSS OF REVENUE OR PROFITS, WHETHER BASED IN CONTRACT, TORT OR OTHER LEGAL THEORY. IN NO EVENT SHALL SELLER'S LIABILITY UNDER ANY CLAIM MADE BY BUYER EXCEED THE PURCHASE PRICE PAID FOR THE PRODUCTS.

7. Confidential Information. Buyer acknowledges and agrees that Confidential Information has been and will be received in confidence and will remain the property of Seller. Buyer further agrees that it will not use Seller's Confidential Information for any purpose other than for the benefit of Seller and shall return all such Confidential Information to Seller within thirty (30) days upon request.

8. Loss to Buyer's Property. Buyer's Property will be considered obsolete and may be destroyed by Seller after two (2) consecutive years have elapsed without Buyer ordering the Products manufactured using Buyer's Property. Also, Seller shall not be responsible for any loss or damage to Buyer's Property while it is in Seller's possession or control.

9. Special Tooling. Seller may impose a tooling charge for any Special Tooling. Special Tooling shall be and remain Seller's property. In no event will Buyer acquire any interest in the Special Tooling, even if such Special Tooling has been specially converted or adapted for manufacture of Goods for Buyer and notwithstanding any charges paid by Buyer. Unless otherwise agreed, Seller has the right to alter, discard or otherwise dispose of any Special Tooling or other property owned by Seller in its sole determination at any time.

10. Security Interest. To secure payment of all sums due from Buyer, Seller retains a security interest in all Products delivered to Buyer and, Buyer's acceptance of these Terms is deemed to be a Security Agreement under the Uniform Commercial Code. Buyer authorizes Seller as its attorney to execute and file on Buyer's behalf all documents Seller deems necessary to perfect Seller's security interest.

11. User Responsibility. Buyer, through its own analysis and testing, is solely responsible for making the final selection of the Products and assuring that all performance, endurance, maintenance, safety and warning requirements of the application of the Products are met. Buyer must analyze all aspects of the application and follow applicable industry standards, specifications, and any technical information provided with the Quote or the Products, such as Seller's instructions, guides and specifications. If Seller provides options of or for Products based upon data or specifications provided by Buyer, Buyer is responsible for determining that such data and specifications are suitable and sufficient for all applications and reasonably foreseeable uses of the Products. In the event Buyer is not the end-user of the Products, Buyer will ensure such end-user complies with this paragraph.

12. Use of Products, Indemnity by Buyer. Buyer shall comply with all instructions, guides and specifications provided by Seller with the Quote or the Products. If Buyer uses or resells the Products in any way prohibited by Seller's instructions, guides or specifications, or Buyer otherwise fails to comply with Seller's instructions, guides and specifications, Buyer acknowledges that any such use, resale, or non-compliance is at Buyer's sole risk. Further, Buyer shall indemnify, defend, and hold Seller harmless from any losses, claims, liabilities, damages, lawsuits, judgments and costs (including attorney fees and defense costs), whether for personal

injury, property damage, intellectual property infringement or any other claim, arising out of or in connection with: (a) improper selection, design, specification, application, or any misuse of Products; (b) any act or omission, negligent or otherwise, of Buyer; (c) Seller's use of Buyer's Property; (d) damage to the Products from an external cause, repair or attempted repair by anyone other than Seller, failure to follow instructions, guides and specifications provided by Seller, use with goods not provided by Seller, or opening, modifying, deconstructing, tampering with or repackaging the Products; or (e) Buyer's failure to comply with these Terms, including any legal or administrative proceedings, collection efforts, or other actions arising from or relating to such failure to comply. Seller shall not indemnify Buyer under any circumstance except as otherwise provided in these Terms.

13. Cancellations and Changes. Buyer may not cancel or modify, including but not limited to movement of delivery dates for the Products, any order for any reason except with Seller's written consent and upon terms that will indemnify, defend and hold Seller harmless against all direct, incidental and consequential loss or damage and any additional expense. Seller, at any time, may change terms, specifications, designs and availability of Products.

14. Assignment. Buyer may not assign its rights or obligations without the prior written consent of Seller.

15. Force Majeure. Seller is not liable for delay or failure to perform any of its obligations by reason of any events or circumstances beyond its reasonable control. Such circumstances include without limitation: accidents, labor disputes or stoppages, government acts or orders, acts of nature, pandemics, epidemics, other widespread illness, or public health emergency, cyber related disruptions, cyber-attacks, ransomware sabotage, delays or failures in delivery from carriers or suppliers, shortages of materials, sudden increases in the price of raw material or components, shutdowns or slowdowns affecting the supply of raw materials or components, or the transportation thereof, oil shortages or oil price increases, energy crisis, energy or fuel interruption, war (whether declared or not) or the serious threat of same, riots, rebellions, acts of terrorism, embargoes, fire or any reason whether similar to the foregoing or otherwise. Seller will resume performance as soon as practicable after the event of force majeure has been removed. All delivery dates affected by an event of force majeure shall be tolled for the duration of such event of force majeure and rescheduled for mutually agreed dates as soon as practicable after the event of force majeure ceases to exist. The right to allocate capacity is in the Seller's sole discretion. An event of force majeure shall not include financial distress, insolvency, bankruptcy, or other similar conditions affecting one of the parties, affiliates and/or sub-contractors. An event of force majeure in the meaning of these Terms means any circumstances beyond Seller's control that permanently or temporarily hinders performance, even where that circumstance was already foreseen. Buyer shall not be entitled to cancel any orders following its claim of an event of force majeure.

16. Waiver and Severability. Failure to enforce any provision of these Terms will not invalidate that provision; nor will any such failure prejudice either party's right to enforce that provision in the future. Invalidation of any provision of these Terms shall not invalidate any other provision herein and, the remaining provisions will remain in full force and effect.

17. Duration. Unless otherwise stated in the Quote, any agreement governed by or arising from these Terms shall: (a) be for an initial term of one (1) year; and (b) shall automatically renew for successive one-year terms unless terminated by Buyer with at least 180-days written notice to Seller or if Seller terminates the agreement pursuant to Section 19 of these Terms.

18. Termination. Seller may, without liability to Buyer, terminate any agreement governed by or arising from these Terms for any reason and at any time by giving Buyer thirty (30) days prior written notice. Seller may immediately terminate, in writing, if Buyer: (a) breaches any provision of these Terms, (b) becomes or is deemed insolvent, (c) appoints or has appointed a trustee, receiver or custodian for all or any part of Buyer's property, (d) files a petition for relief in bankruptcy on its own behalf, or one is filed against Buyer by a third party, (e) makes an assignment for the benefit of creditors; or (f) dissolves its business or liquidates all or a majority of its assets.

19. Ownership of Rights. Buyer agrees that (a) Seller (and/or its affiliates) owns or is the valid licensee of Seller's IP and (b) the furnishing of information, related documents or other materials by Seller to Buyer does not grant or transfer any ownership interest or license in or to Seller's IP to Buyer, unless expressly agreed in writing. Without limiting the foregoing, Seller retains ownership of all Software supplied to Buyer. In no event shall Buyer obtain any greater right in and to the Software than a right in a license limited to the use thereof and subject to compliance with any other terms provided with the Software. Buyer further agrees that it will not, directly or through intermediaries, reverse engineer, decompile, or disassemble any Software (including firmware) comprising or contained within a Product, except and only to the extent that such activity may be expressly permitted, either by applicable law or, in the case of open source software, the applicable open source license.

20. Indemnity for Infringement of Intellectual Property Rights. Seller is not liable for infringement of any Intellectual Property Rights except as provided in this Section. Seller will defend at its expense and will pay the cost of any settlement or damages awarded in an action brought against Buyer based on a third-party claim that one or more of the Products infringes the Intellectual Property Rights of a third party in the country of delivery of the Products by Seller to Buyer. Seller's obligation to defend and indemnify Buyer is contingent on Buyer notifying Seller within ten (10) days after Buyer becomes aware of any such claim, and Seller having sole control over the defense of the claim including all negotiations for settlement or compromise. If one or more Products is subject to such a claim, Seller may, at its sole expense and option, procure for Buyer the right to continue using the Products, replace or modify the Products to render them non-infringing, or offer to accept return of the Products and refund the purchase price less a reasonable allowance for depreciation. Seller has no obligation or liability for any claim of infringement: (i) arising from information provided by Buyer (including Seller's use of Buyer's Property); or (ii) directed to any Products for which the designs are specified in whole or part by Buyer; or (iii) resulting from the modification, combination or use in a system of any Products. The foregoing provisions of this Section constitute Seller's sole and exclusive liability and Buyer's sole and exclusive remedy for claims of infringement of Intellectual Property Rights.

21. Governing Law. These Terms, the terms of any Quote, and the sale and delivery of all Products are deemed to have taken place in, and shall be governed and construed in accordance with, the laws of the State of Ohio, as applicable to contracts executed and wholly performed therein and without regard to conflicts of laws principles. Buyer irrevocably agrees and consents to the exclusive jurisdiction and venue of the courts of Cuyahoga County, Ohio with respect to any dispute, controversy or claim arising out of or relating to the sale and delivery of the Products.

22. Entire Agreement. These Terms, along with the terms set forth in the Quote, forms the entire agreement between the Buyer and Seller and constitutes the final, complete and exclusive expression of the terms of sale and purchase. In the event of a conflict between any term set forth in the Quote and these Terms, the terms set forth in the Quote shall prevail. All prior or contemporaneous written or oral agreements or negotiations with respect to the subject matter shall have no effect. No modification to these Terms will be binding on Seller unless agreed to in a writing that is signed by an authorized representative of Seller, excluding email correspondence, "clickwrap" or other purported electronic assent to different or additional terms. Sections 2-25 of these Terms shall survive termination or cancellation of any agreement governed by or arising from these Terms.

23. No "Wrap" Agreements/No Authority to Bind. Seller's clicking any buttons or any similar action, such as clicking "I Agree" or "Confirm," to utilize Buyer's software or webpage for the placement of orders, is NOT an agreement to Buyer's Terms and Conditions. NO EMPLOYEE, AGENT OR REPRESENTATIVE OF SELLER HAS THE AUTHORITY TO BIND SELLER BY THE ACT OF CLICKING ANY BUTTON OR SIMILAR ACTION ON BUYER'S WEBSITE OR PORTAL.

24. Compliance with Laws. Buyer agrees to comply with all applicable laws, regulations, and industry and professional standards, including those of the United States of America, and the country or countries in which Buyer may operate, including without limitation the U.S. Foreign Corrupt Practices Act ("FCPA"), the U.S. Anti-Kickback Act ("Anti-Kickback Act"), U.S. and E.U. export control and sanctions laws ("Export Laws"), the U.S. Food Drug and Cosmetic Act ("FDCA"), and the rules and regulations promulgated by the U.S. Food and Drug Administration ("FDA"), each as currently amended. Buyer agrees to indemnify, defend, and hold harmless Seller from the consequences of any violation of such laws, regulations and standards by Buyer, its employees or agents. Buyer represents that it is familiar with all applicable provisions of the FCPA, the Anti-Kickback Act, Export Laws, the FDCA and the FDA and certifies that Buyer will adhere to the requirements thereof and not take any action that would make Seller violate such requirements. Buyer represents and agrees that Buyer will not make any payment or give anything of value, directly or indirectly, to any governmental official, foreign political party or official thereof, candidate for foreign political office, or commercial entity or person, for any improper purpose, including the purpose of influencing such person to purchase Products or otherwise benefit the business of Seller. Buyer further represents and agrees that it will not receive, use, service, transfer or ship any Products from Seller in a manner or for a purpose that violates Export Laws or would cause Seller to be in violation of Export Laws. Buyer agrees to promptly and reliably provide Seller all requested information or documents, including end-user statements and other written assurances, concerning Buyer's ongoing compliance with Export Law. (9/22)

Parker Hannifin Corporation
Cylinder and Accumulator Division
225 Battersby Avenue
Enumclaw, WA 98022 USA
phone (360) 825-1601
fax (360) 825-1603
www.parker.com/helac

