

1

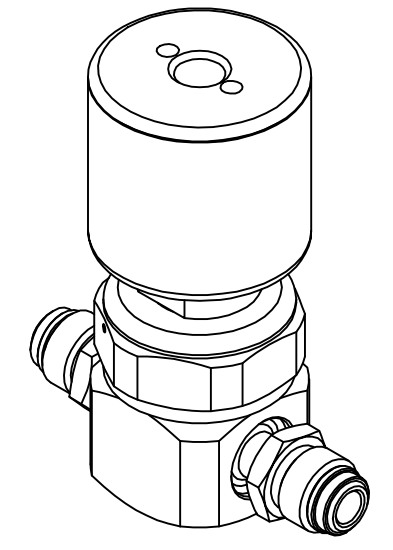

2

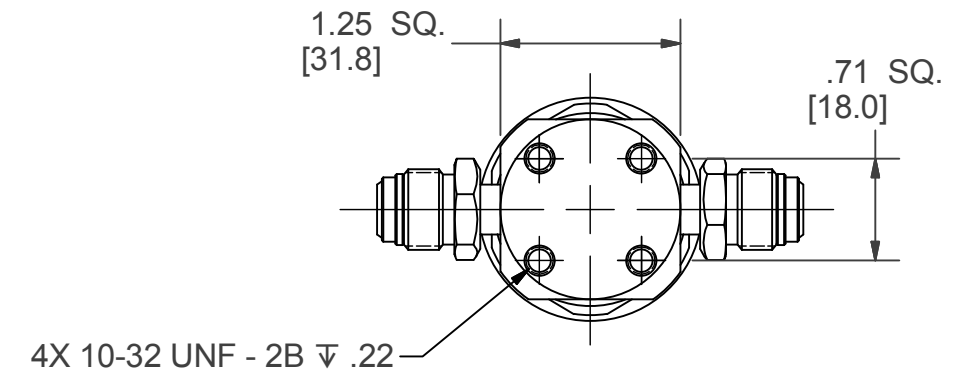
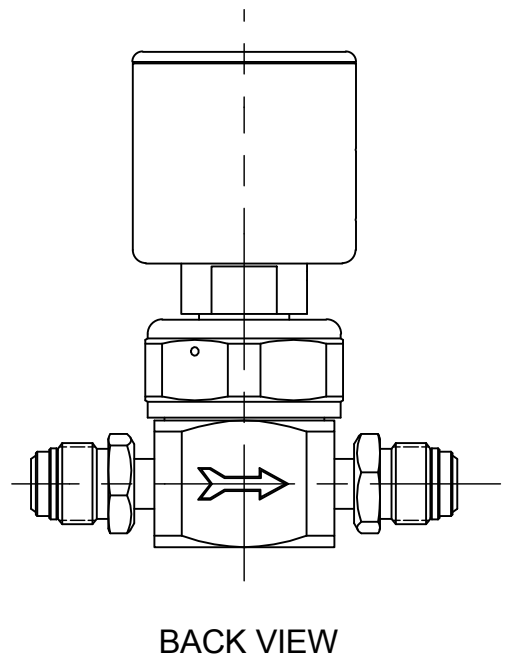
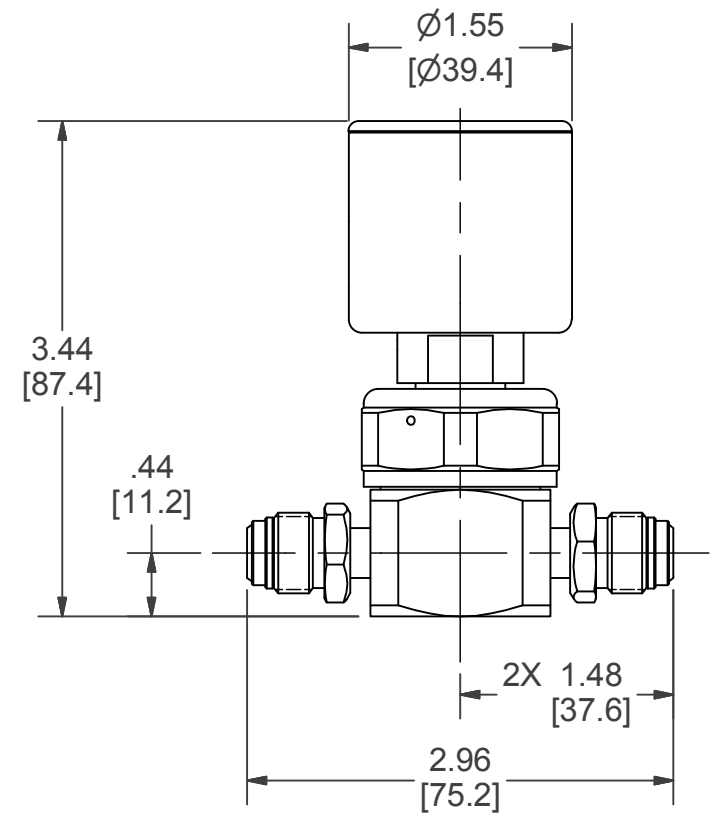
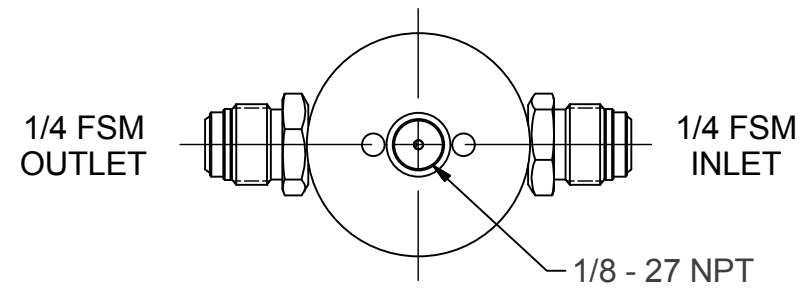

<b>SALES DRAWING</b>	
DESCRIPTION <b>955AOPLPNCFSMM</b>	
DATE:	1/29/2018
DRAWING NOT TO SCALE	SHEET 1 OF 1



DIMENSIONS ARE REF INCH [MM]  
DRAWING IS SUBJECT TO  
CHANGE WITHOUT NOTICE.

COPYRIGHT PARKER. YEAR OF  
COPYRIGHT IS FIRST YEAR  
INDICATED ON THIS DOCUMENT.  
ALL RIGHTS RESERVED.

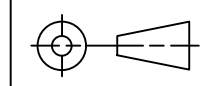

1



2

A



B

A



B