

REV	DESCRIPTION	BY	DATE
-	ECO-0394483	JB	3/23/2022

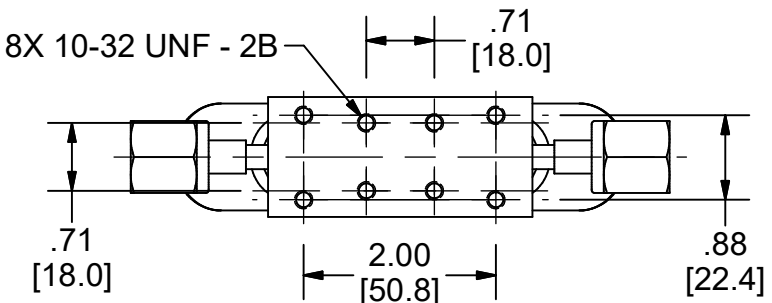
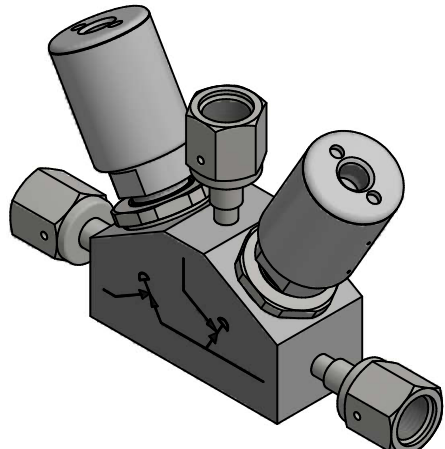
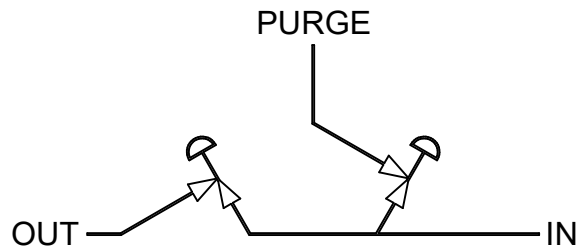
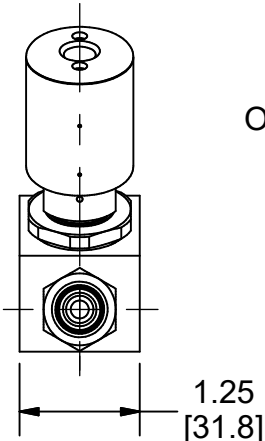
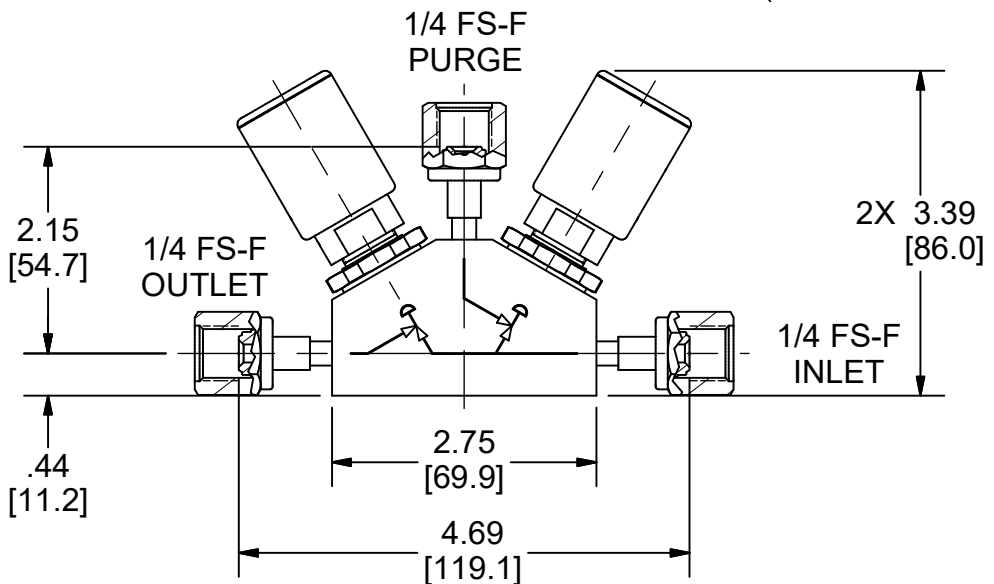
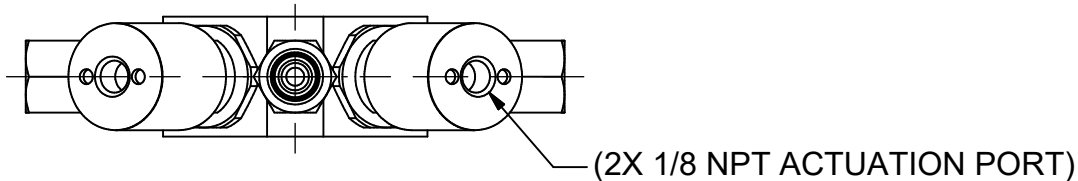

NOTES:

SEE 930Y SERIES LITERATURE, 25000133, FOR ALL MATERIALS OF CONSTRUCTION, OPERATING CONDITIONS, AND PERFORMANCE RATINGS.

DIMENSIONS ARE REF INCH [MM]



DRAWING IS SUBJECT TO CHANGE WITHOUT NOTICE.

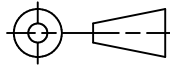

SALES DRAWING

THIS DOCUMENT CONTAINS INFORMATION THAT IS CONFIDENTIAL AND PROPRIETARY TO VERIFLO DIVISION OF PARKER HANNIFIN ("PARKER"). THIS DOCUMENT IS FURNISHED ON THE UNDERSTANDING THAT THE DOCUMENT AND THE INFORMATION IT CONTAINS WILL NOT BE COPIED OR DISCLOSED TO OTHERS EXCEPT WITH THE WRITTEN CONSENT OF PARKER. WILL NOT BE USED FOR ANY PURPOSE OTHER THAN CONDUCTING BUSINESS WITH PARKER, AND WILL BE RETURNED AND ALL FURTHER USE DISCONTINUED UPON REQUEST BY PARKER. COPYRIGHT PARKER. YEAR OF COPYRIGHT IS FIRST YEAR INDICATED ON THIS DOCUMENT. ALL RIGHTS RESERVED.

DESCRIPTION
930Y2NC/NCFSFFFA

This document and other information from Parker-Hannifin Corporation, its subsidiaries and authorized distributors provide product or system options for further investigation by users having technical expertise. The user, through its own analysis and testing, is solely responsible for making the final selection of the system and components and assuring that all performance, endurance, maintenance, safety and warning requirements of the application are met. The user must analyze all aspects of the application, follow applicable industry standards, and follow the information concerning the product in the current product catalog and in any other materials provided from Parker or its subsidiaries or authorized distributors. To the extent that Parker or its subsidiaries or authorized distributors provide component or system options based upon data or specifications provided by the user, the user is responsible for determining that such data and specifications are suitable and sufficient for all applications and reasonably foreseeable uses of the components or systems.

DRAWING NUMBER SD100084	REV. -
DRAWING NOT TO SCALE	SHEET 1 OF 1