

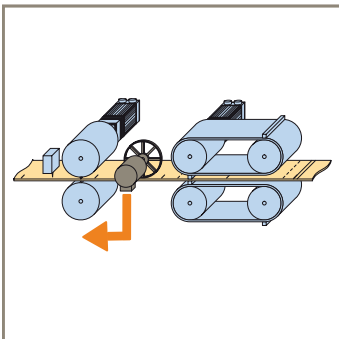

aerospace
 climate control
 electromechanical
 filtration
 fluid & gas handling
 hydraulics
 pneumatics
 process control
 sealing & shielding



Electromechanics made by Parker
Motion control



ENGINEERING YOUR SUCCESS.

Table of Contents

Parker Hannifin	3
Strong group of companies world-wide	3
Control technology from Parker Hannifin	4
Multi-axis motion control with C3 powerPLmC	6
Single axis motion control with Compax3 T30/T40	10
Advantages offered by international standards	12
IEC61131-3	12
Function modules based on PLCopen	12
CoDeSys	13
Safety technology	13
Machine automation with Parker products	14

Application examples

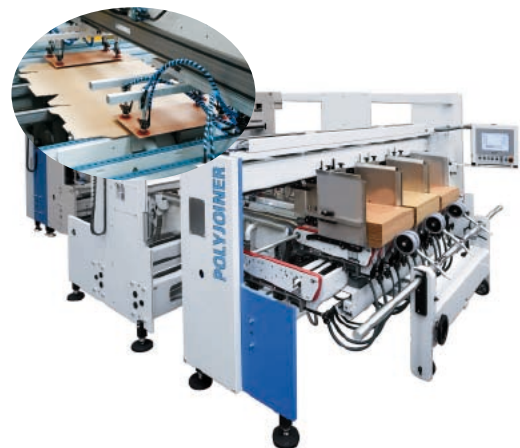
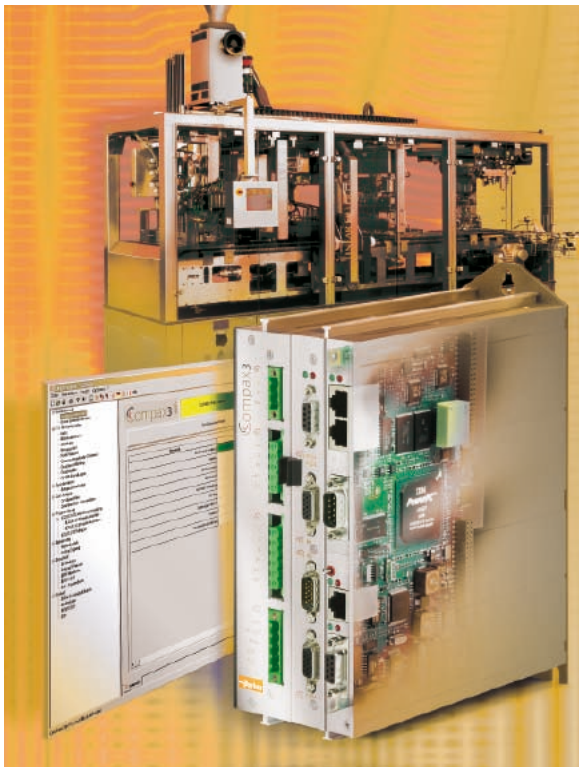

Parker Hannifin

Strong group of companies world-wide

Strong partners are needed in the automation industry. This applies above all for suppliers of high-quality control technology. High potential for development, worldwide sales and service as well as a globally organized company structure – this is what Parker guarantees. Approx. 60,000 employees in over 250 production sites realize a turnover of about \$10 Billion per year.

„Think global, act local“ is one of the basic principles of our group of companies. A variety of medium-sized companies form the pillars of the worldwide organization. This structure ensures a close relation to the local markets and, above all, to the customers. Come to one of the Parker group companies. We understand you. Parker Hannifin's international company structure enables us to provide excellent support around the world. This represents a basic success factor in times of increasing globalization, especially for manufacturers of complex automation systems.



Europe



- | | |
|---------------|----------------|
| Belgium | Poland |
| Denmark | Portugal |
| Germany | Austria |
| Great Britain | Romania |
| France | Sweden |
| Greece | Slovenia |
| Ireland | Spain |
| Iceland | Turkey |
| Italy | Czech Republic |
| Lithuania | Hungary |
| Moldavia | Cyprus |
| Netherlands | Switzerland |

Control technology from Parker Hannifin

Modern machines feature high flexibility and productivity. Automation solutions from Parker Hannifin offer the basis for the implementation of state-of-the-art

machine concepts. The consequent integration of international standards provides OEMs with the freedom to concentrate entirely on the technological process.

Motion control plays an increasingly central role in this development.

The Parker control technology comes up to your greatest expectations ...



Compax3H *powerPLmC-C1x*

Compax3S *powerPLmC-C1x*

- integrated -
into the Compax3 servo drive



C3 *powerPLmC-E20*

- standalone -
without servo drive

- Basis for the implementation of modular machine concepts
- Windows® based standard tools for programming, start-up and diagnostics
- Minimisation of the wiring overhead by reduction of the interface diversity
- Maximum functionality and flexibility
- Optimised space requirements due to minimised components and state-of-the-art installation concept
- Realisation of safe machine concepts
- Basis for the realisation of hybrid machine concepts – electromechanics, hydraulics and pneumatics

Technology controller with integrated motion PLC - Compax3 powerPLmC-C1x

Main fields of application

- More than two axes for motion automation
- High degree of system integration (e.g. via Ethernet)
- Integration of complex devices for machine visualisation and operation
- Connection to a wide number of digital and analog inputs
- Integration of pneumatic and hydraulic automation devices

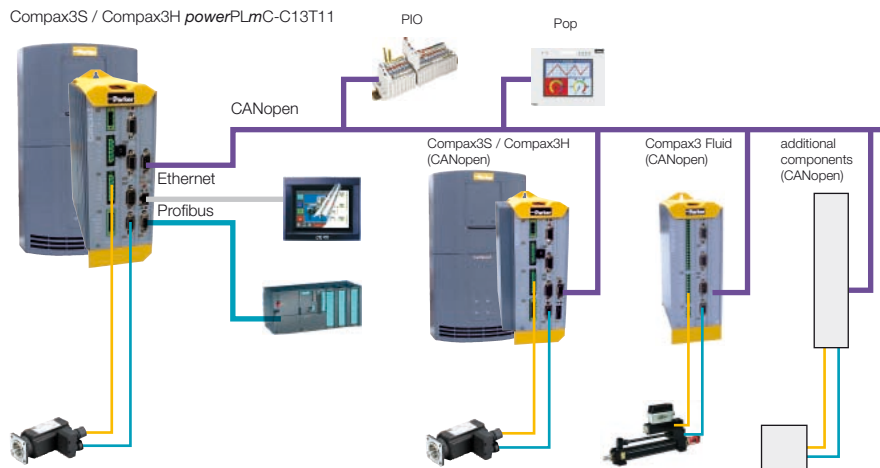

Motion PLC with technology functions - C3 powerPLmC-E20

Main fields of application

- Similar to Compax3 powerPLmC-C1x
- High proportion of PLC typical tasks
- Integration of additional automation components via a second CAN bus.
- Basis for the realisation of hybrid machine concepts – electromechanics, hydraulics and pneumatics

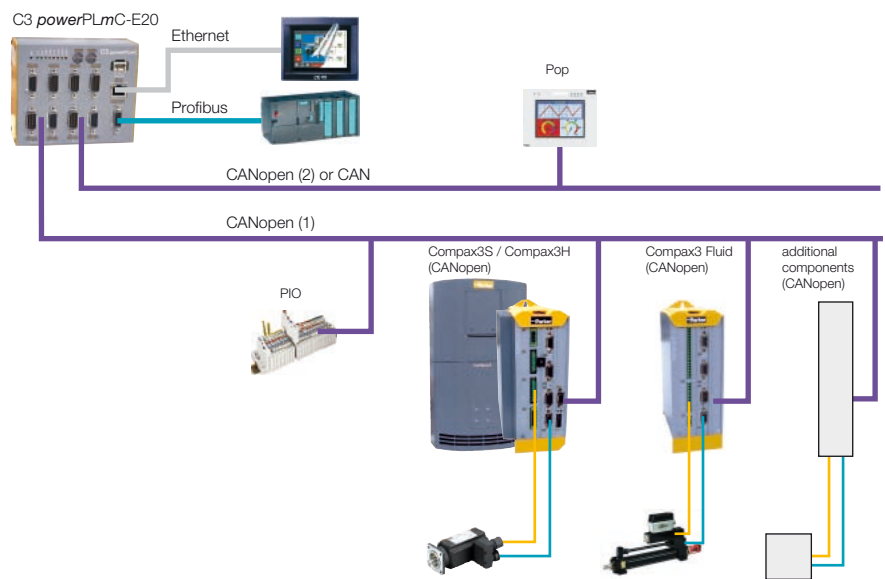

Technology controller - Compax3 T30 / T40

Main fields of application

- Machines or machine modules with one or two servo axes
- Applications requiring a high degree of flexibility with respect to sequence control
- Optional connection of upgrading devices for the operation and monitoring as well as external I/Os

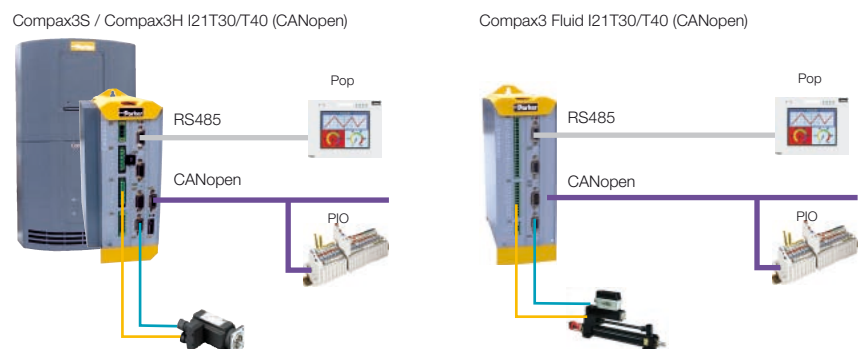

Multi-axis motion control with C3 powerPLmC

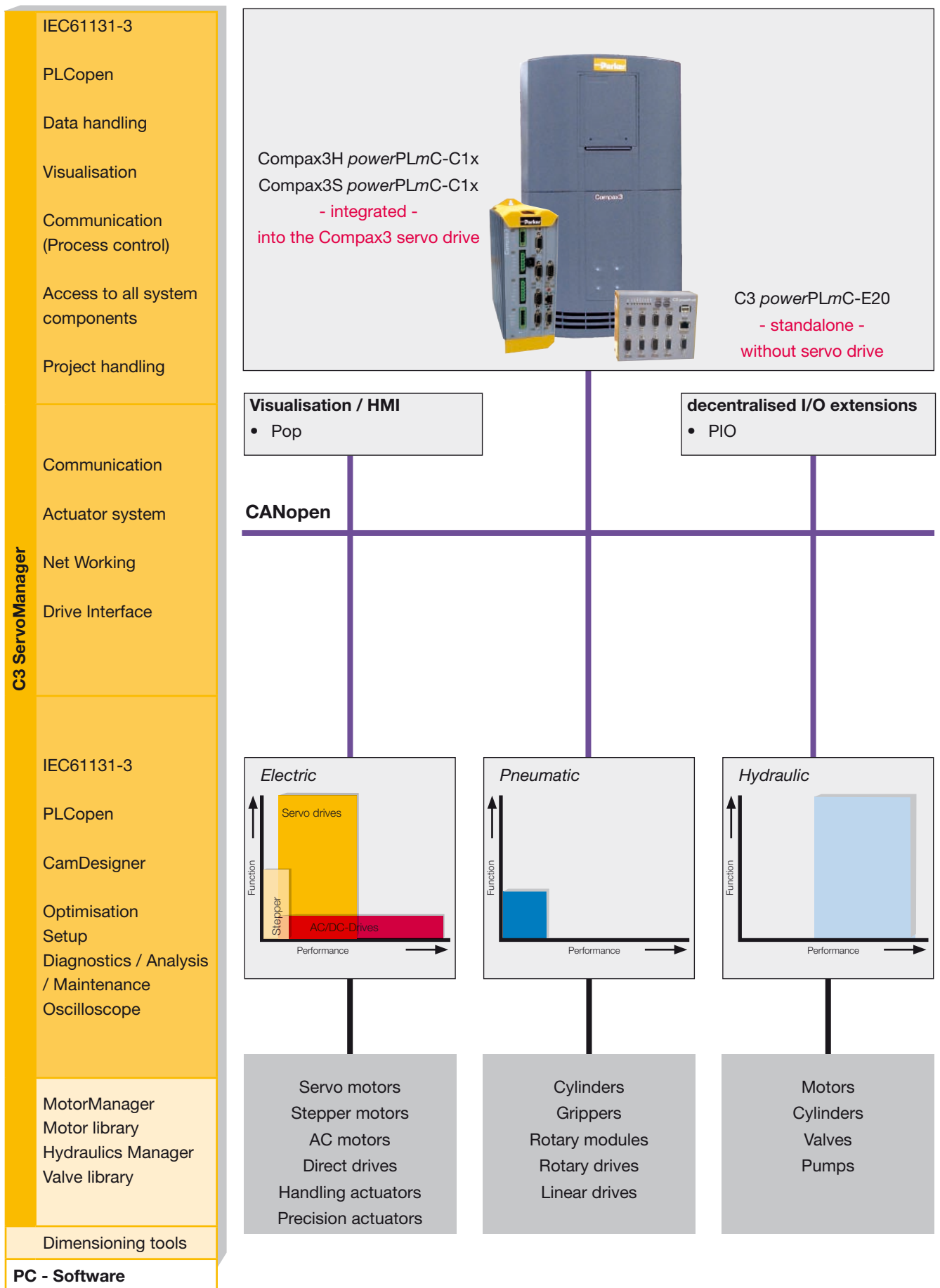

Compax3 powerPLmC-C1x integrated and C3 powerPLmC-E20 standalone

Compax3 powerPLmC is a control system for combined PLC, motion and visualization tasks. CANopen combines the bus components with the CANopen master „Compax3

powerPLmC“. The power range of commands based IEC61131-3 is available for control tasks. Programming via „CoDeSys“ high-power programming system via

Ethernet. The implementation of multi-axis motion tasks are supported by PLCopen function modules.

PLC-Logic + Motion Control + Visualisation = powerPLmC



Compax3 powerPLmC-C1x
- integrated -
into the Compax3 servo drive



C3 powerPLmC-E20
- standalone -
without servo drive

- 32 Bit - RISC - Processor:
 - <100µs für 1000 IL commands
- CANopen:
 - Multi-axis communication
- Drive Interface:
 - Simple integration of the servo axes
- Ethernet:
 - Programming interface,
 - Remote diagnostics via Internet/Intranet,
 - Process visualisation,
 - System integration
- Programmable according to IEC61131-3 / PLCopen
- CoDeSys development tool
- PLC functionality
 - 4 real-time task types: free running, cyclical, event-triggered (internal or external events)
 - Debugging, Single Step, Watch function, Log
- PLC extensions from Parker:
 - POP: Parker Operator Panel (MMI) - from the 4-line display to the colour touchscreen
 - PIO: Parker digital and analogue inputs/outputs - modular extensions

Additional features

Motion Control

- Ready-made PLCopen compliant Motion Control function modules allow users to create programs effectively
- Drive Interface
 - Integrating a servo axis without field-bus knowledge
 - shortest transmission times due to internal cache memory; only modified data is transmitted

PLC functionality

- Online program change
- Simulation, online trace, break-points
- Watchdog Timer
- Minimum IEC task time: 1ms

Project management

- Saving and archiving an entire project (source file) including symbols and comments to make service calls easier, because there is no need for any project data on the device itself.

- Creating and protecting user-specific libraries that can be reused as tested sections of programs
- Various user levels make it possible to lock sections of the program with passwords
- 5 IEC languages plus CFC can be selected
- Data import / export

File handling

- The servo drive can generate files (e.g. for error protocols, recipes, machine parameters)
- Files are available via the FTP server on a drive in C3 powerPLmC and can be downloaded onto a PC.
- Error messages can be assigned to an error string by means of the error number and then stored together with the time of day (from an integrated clock)

Networking control systems

- Multiple control systems can be networked together via Ethernet
- Exchanging information via network variables

Visualisation

- Integrated into the local programming system
 - Monitoring of machine or system states
 - Debugging
 - Diagnosis
- With integrated access to web server via standard browser
- OPC interface for integrating Windows-based visualisation programs such as InteractX, WinCC, Intouch, Protocol
- Remote diagnostics

Compax3 powerPLmC-C13 integrated

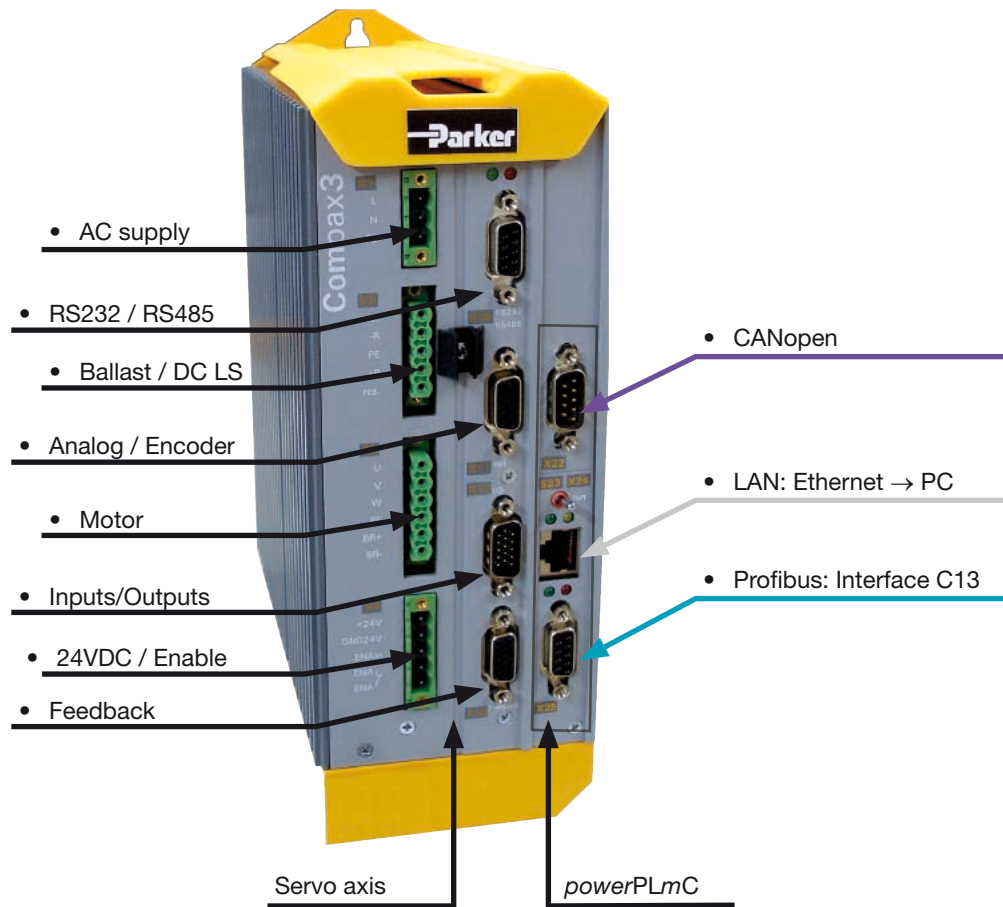

C3 powerPLmC-E20 standalone



Technical data



		Compax3 powerPLmC-C1x	C3powerPLmC-E20	Compax3 T30 / T40
General data	Platform	32Bit RISC Processor 200MHz		24Bit Signal processor
	Boot FLASH / Program memory FLASH	1 Mbyte / 4MBytes	64MB Compact Flash	
	Data memory SDRAM / Data memory non volatile	16MB / 32kB (Retain)		64kB / 18Byte (Retain)
	Real-time clock	Yes, buffered		No
	Operating system / supply	Real-time Multitasking / 24V DC		Singletasking
Control properties	Processing time	<100µs for 1000 IL lines		2ms for 1000 IL lines
	Real-time tasks	free-running cyclical Event-triggered, internal / external events		cyclical
	Minimum cycle time	typical 1ms		
	Online program change	Yes		No
	Watchdog timer	Yes		Yes
	Data exchange in distributed systems (network variables)	Yes		No
Programming and Debugging	Programming system	CoDeSyS		
	Programming languages	IL, KOP, FUP, ST, AS, CFC		
	Protocol	IEC61 131-3		
	Import PLC programs	Siemens Import		
	PLCopen - Motion Control modules	Yes		
	Debug, Single Step, Watch function	Yes		Yes (kein Single Step)
	Simulation, Online Trace	Yes		Yes
	Breakpoints	Yes (Source level debugging)		Yes
	Source Code Download	Yes		Yes
	Writing, reading, forcing variables	Yes		Yes (no forcing)
Program management	File System, FTP		No	
Programming interface	Fast Ethernet		RS232	
Visualisation	Locally in the programming system	Yes		No
	Web Server	Yes		No
	OPC Server	Yes		No
Interfaces	general	RS232/RS485	2x RS232 2x RS232/RS485	RS232/RS485
	Fieldbusses (standard)	CANopen Master Ethernet 10/100	2 x CANopen Master Ethernet 10/100	CANopen Master for the connection of PIOs (Input/output modules)
	Fieldbusses (optional)	Profibus DP Slave HEDA: Real-time data bus	Profibus DP Slave	HEDA: Real-time data bus
	Digital and analogue Inputs/Outputs Option	any	any (depending on the number of axes)	24 digital / 4 analogue
	Encoder output	Yes, up to 16384/rev	no	Yes, up to 16384/rev

Single axis motion control with Compax3 T30/T40

Compax3H I21T30 or I21T40

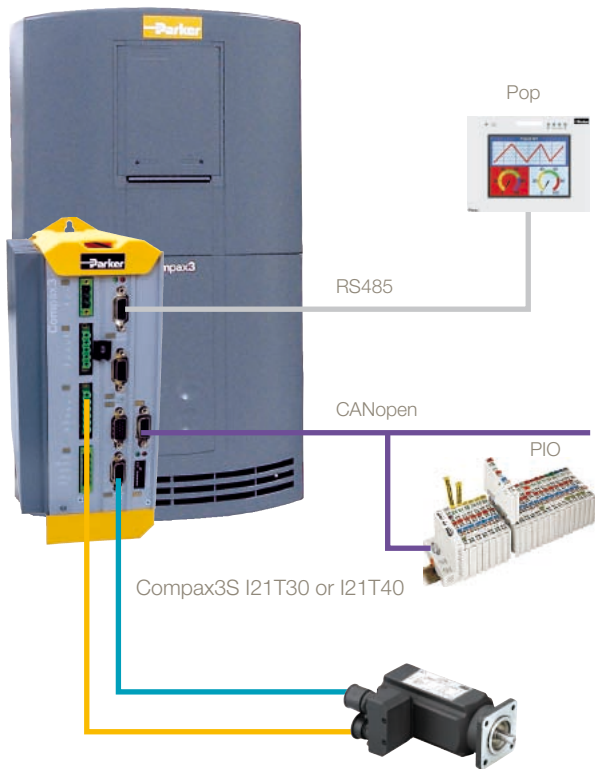

Compax3 Fluid I21T30/T40 (CANopen)

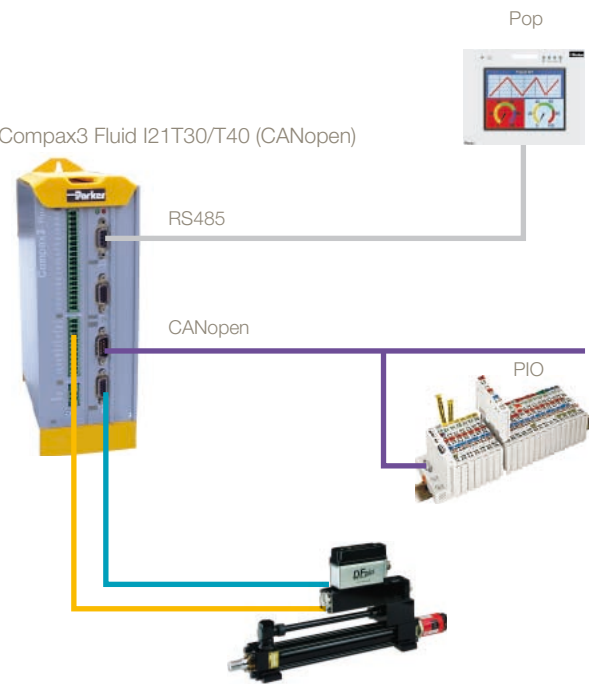

The Compax3 I21T30 servo drive

Function range T30

- Programmable based on IEC61131-3
- Programming system: CoDeSys
- Up to 5000 instructions
- 500 16bit variables / 150 32bit variables
- Recipe table with 288 variables
- 3x16-bit retain variables / 3x32-bit retain variables
- PLCOpen function modules:
 - Positioning: absolute, relative, additive, endless
 - Machine Zero / Homing Mode Settings
 - Stop, energizing the power stage, Quit
 - Position, device status, reading axis error
 - Electronic gearbox (MC_GearIn)
- IEC61131-3-standard modules:
 - Up to 8 timers (TON, TOF, TP)
 - Triggers (R_TRIG, F_TRIG)
 - Flip-flops (RS, SR)
 - Counters (CTU, CTD, CTUD)
- Device-specific function modules:
 - C3_Input: generates an input process image
 - C3_Output: generates an output process image
 - C3_ReadArray: access to recipe table
- Inputs/outputs:
 - 8 digital inputs (24V level)
 - 4 digital outputs (24V level)
 - 2 analog inputs (14bits)
 - Optional addition of 12 inputs/outputs

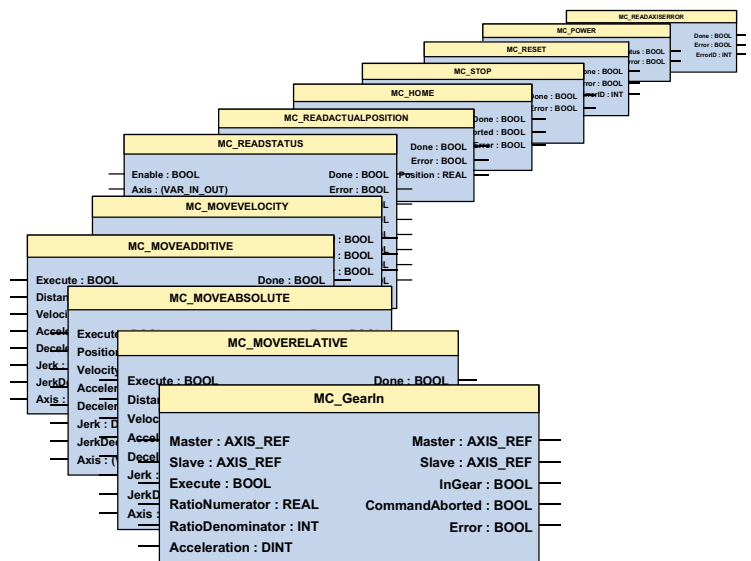

The Compax3 I21T40 servo drive

Complementary technology function T40:

Compax3 T40 is able to simulate mechanical cams and cam switching mechanisms electronically.

The T40 electronic cam was especially designed for:

- the packaging machine industry,
- all applications where a mechanical cam is to be replaced by a flexible, cyclic electronic solution

This helps to realize discontinuous material supply, flying knife and similar drive applications with distributed drive performance.

Compax3 T40 supports both real and virtual master movements. In addition, the user can switch to other cam profiles or cam segments on the fly. Programming is made in the well-

known IEC61131-3 environment.

With the aid of the cam function modules and the CamDesigner, cam applications can be easily implemented.

Function range T40

- T30 Technology Functions completely integrated and available
- Master position acquisition
- Mark synchronization
- 10 000 24 bit interpolation points
- Cam switching mechanism
- Coupling and decoupling functions
- Cam profiles
- Cam memory
- Cam creation with the CamDesigner

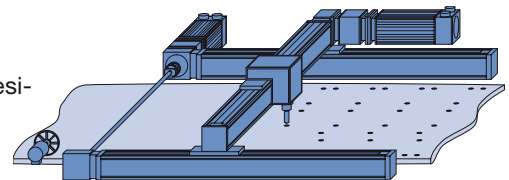
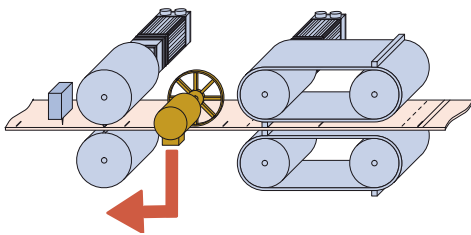

Device: C3	Current A_{RMS}		Mains voltage	Power
	I_{cont}	$I_{peak}(<5s)$		
S025V2	2.5	5.5	1 *	1.0
S063V2	6.3	12.6	230/240VAC	2.5
S100V2	10.0	20.0	3 *	4.0
S150V2	15.0	30.0	230/240VAC	6.0
S015V4	1.5	4.5		1.25
S038V4	3.8	9.0	3 *	3.1
S075V4	7.5	15.0	400/480VAC	6.2
S150V4	15.0	30.0		11.5
S300V4	30.0	60.0		25.0
H050V4	50	75		35
H090V4	90	135	3 *	70
H125V4	125	187.5	400/480VAC	91
H155V4	155	232.5		109

The Compax3 servo drive

Compax3 is an intelligent servo drive with a modular structure enabling it to be used in a wide range of industrial applications.

The use of industrial standards minimises development overheads for the user.

Technical data

- enclosed housing
- Direct mains operation
- Power range of 1kW ... 110kW
- Modular design for the implementation of individual requirements
- 8 digital inputs, 4 digital outputs
- RS232 / RS485 - interfaces
- 2 analogue inputs (+/-10V, 14 bits)
- 2 analogue outputs (+/-10V, 8 bits)
- Encoder input or output
- CE-conformity, UL, cUL
- Certified safety technology integrated (EN954-1 Cat.3)
- Position acquisition at the motor shaft via most of the available feedback systems
- Different fieldbusses
- HEDA real-time bus for inter-axis coupling

Software

- Fast and simple setup with the „Compax3 ServoManager“

Advantages offered by international standards

IEC61131-3

IEC61131-3 is the only company- and product independent programming language with world-wide support for industrial automation devices.

IEC61131-3 includes graphical and textual programming languages:

- Instruction list
- Structured text
- Ladder diagram
- Sequential function chart
- Function block diagram

```

0001 FUNCTION_BLOCK EXAMPLE
0002 (* Sinus und Cosinus einer Zahl berechnen *)
0003 VAR_INPUT
0004   r1 : REAL = 0.0;
0005 END_VAR
0006 VAR_OUTPUT
0007   sinus : REAL;
0008   cosinus : REAL = 9.8;
0009 END_VAR
0010
0011 (* Den Sinus einer Zahl berechnen und mit 1000 multiplizieren *)
0012 LD   r1
0013 SIN
0014 MUL  1000.0
0015 ET   sinus
0016 (* Den Cosinus einer Zahl berechnen und mit 1000 multiplizieren *)
0017 LD   r1
0018 COS
0019 MUL  1000.0
0020 ET   cosinus
0021
0022 (* Die Zahl weiterstehen *)
0023 LD   r1
0024 ADD  0.1
0025 ET   r1
0026

```

Program development in IL

- Integrated standards offer:
 - a trusted programming environment
 - standardized programming
- Integrated standards reduce:
 - the overhead of development
 - maintenance costs
 - software upkeep
 - training overhead
- Integrated standards increase:
 - productivity
 - software quality
 - concentration on core competence

Instruction list (IL):

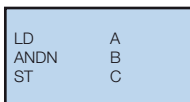

Structured text:

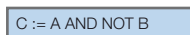

Contact plan:

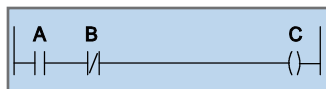

Function block:

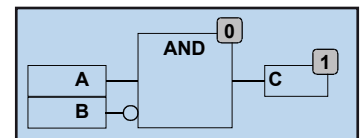

Function modules based on PLCopen

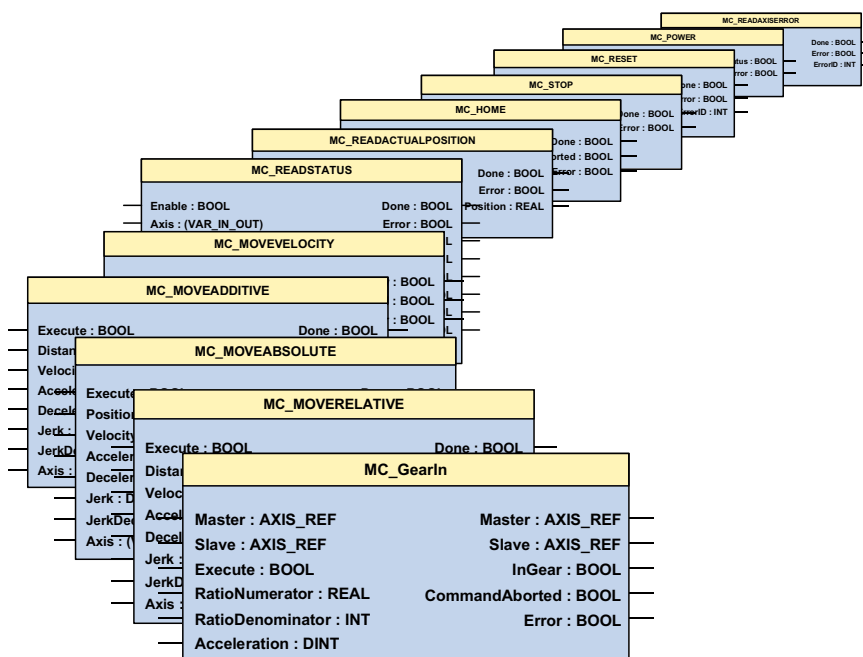

Function modules according to PLCopen

PLCopen is a product- and company-independent organization that plays a significant role in supporting the IEC61131-3 programming language. Its specific tasks also include defining basic processes relevant to motion. The PLCopen organization consists of both users and manufacturers of automation components. Parker Hannifin is an active member of the "Motion Control" task force. This represents a great advantage to users of Parker drive technology, since they are constantly able to profit directly from the latest developments in PLCopen.

CoDeSys

CoDeSys professional development tool

CoDeSys is a development environment for programming that saves a significant amount of time as applications are created.

- One of the most powerful development environments available, established world-wide
- Universal programming platform for various devices
- Complete offline simulation
- Visual elements
- Library management for user-defined applications
- Context-sensitive help wizard
- Data exchange between devices from different manufacturers
- Complete online functionality
- Sophisticated technological features

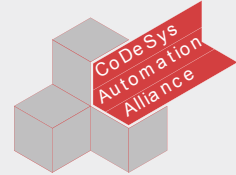

Visualisation with Compax3 powerPLmC and CoDeSys

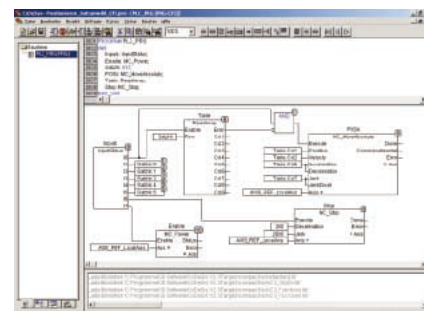

Program development in CFC

Safety technology

Principle circuit diagram

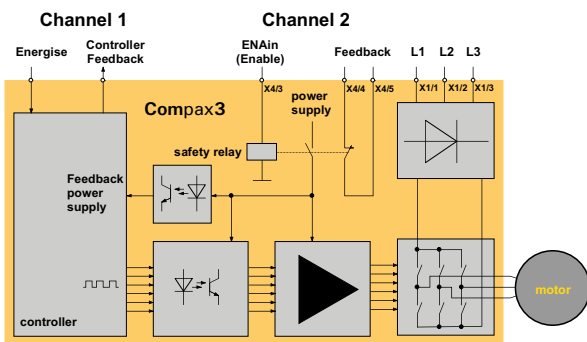

Principle:

To ensure safe protection against a motor starting up unexpectedly, the flow of current to the motor and thus to the power output stage must be prevented.

This is accomplished for Compax3 with two measures independent of each other (Channel 1 and 2), without disconnecting the drive from the power supply:

Channel 1:

Activation of the power output stage can be disabled in the Compax3 controller by means of a digital input or with a fieldbus interface (depending on the Compax3 device type) (deactivation of the energize input).

Channel 2:

The power supply for optocouplers and drivers of power output stage signals is disconnected by a safety relay activated by the enable input „ENAIN“ (X4/3) and equipped with force-directed contacts. This prevents control signals from being transferred to the power output stage.

Circuitry example for C3 powerPLmC - multi-axis application

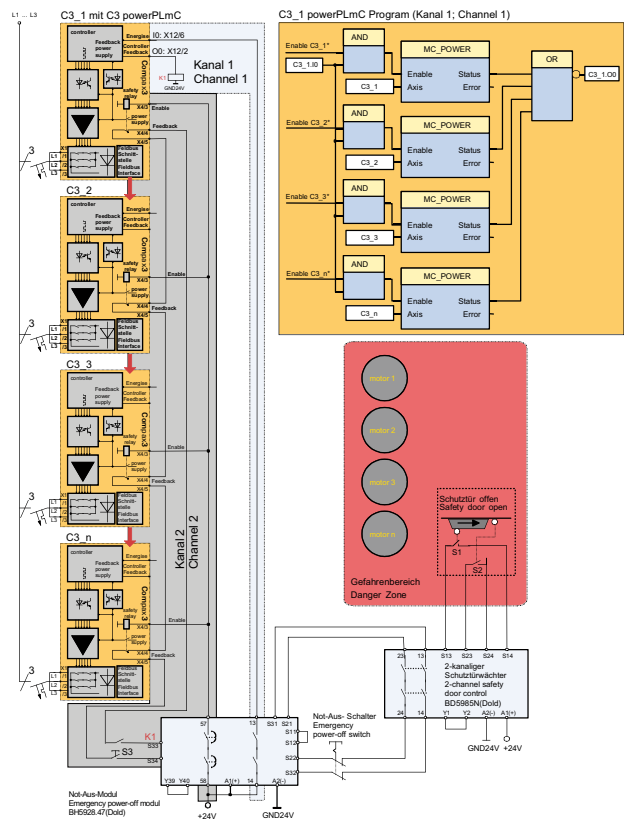

The „Safe Standstill“ safety function as defined by EN 954-1 Category 3 is possible if both channels are used.

Machine automation with Parker products

Visualisation/HMI

Pop: Parker Operator Panel - HMI

- Text / graphic displays
- different sizes
- RS232, RS485, Profibus, CAN-open, DeviceNET, Interbus S



PowerStation

- Graphic design elements
- Touchscreen monitors up to 18"



Decentralised I/O extensions

PIO: Parker Inputs/Outputs

- Digital and analogue inputs and outputs via fieldbus coupler.



Servo Drives

Compax3 ServoAxis

- Voltage supply: 1x/3x230VAC or 3x400/480VAC
- Power range: 1... 110kW
- 8 digital inputs / 4 digital outputs



SLVDN: Servo controller

- Voltage supply: 1/3x230VAC
- Power range: 0.5...15kW

ViX Servo drive

- Voltage supply: 24...80VDC
- Power range: 250/500W



Series 638

- Voltage supply: 1x/3x16...240VAC
- Nominal current: 1...6A
- 10 digital inputs / 3 digital outputs

AC/DC drives

AC890

- AC drive
- Voltage supply: 400...500VAC
- Power range: 0.75...90kW



Series 590P/591P

- DC drive
- Voltage supply: 3x110/230VAC, 3x220/500VAC, 3x500/600VAC
- 15...5400A

Series 690

- AC drive
- Voltage supply: 1x/3x230VAC, 3x380/460VAC, 3x460/500VAC
- Power range: 0.75...1000kW



Stepper drives

XL Stepper drive

- Voltage supply: 24...80VDC
- Nominal current: 1.8A, 3.5A, 5.6A



ViX Stepper drive

- Voltage supply: 24...80VDC
- Nominal current: 2.8A, 5.6A

Pneumatic drives

Moduflex

- Adaptable pneumatics with modular components.
- Protection class IP65 - IP67



Compax3 Fluid

- Voltage supply: 24VDC
- Servo quality in hydraulics
- programmable according to IEC61131-3
- Cam function

Actuators

Synchronous servo motors

- For highly dynamic machines and systems
- 0.2...90Nm



Precision actuators

- Linear motor tables
- Screw-driven tables
- Rotary tables
- 3 axis systems

Stepper motors

- 2 Phase hybrid stepper motors
- 0.45...5.4Nm
- NEMA 23/34/ 1-3 Stacks, NEMA 42, 2/3 Stacks

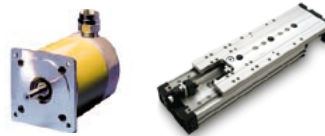

Components for pneumatic systems

- ISO/VDMA cylinders,
- Grippers
- Rotary modules
- Rotary drives
- Linear drives

Direct drives

- Kits and complete systems for linear and torque motors



Components for hydraulic systems

- Motors
- Cylinders
- Valves
- Pumps

Handling actuators

- Driven by toothed belt, screw or linear motor
- Horizontal or vertical actuators





Parker Hannifin GmbH & Co. KG
Electromechanical Automation
Robert-Bosch-Straße 22
D-77656 Offenburg, Germany
phone +49 (0)781 / 509-0
fax +49 (0)781 / 509-98176
sales.automation@parker.com
www.parker-automation.com