

CV	Check Valves
SH	Shuttle Valves
LM	Load/Motor Controls
FC	Flow Controls
PC	Pressure Controls
LE	Logic Elements
DC	Directional Controls
MV	Manual Valves
SV	Solenoid Valves
PV	Proportional Valves
CE	Coils & Electronics
CB	Cartridge Bodies
BC	Bodies & Cavities
TD	Technical Data

General Description

2 Way, Normally Open, Proportional Flow Regulator Valve. Pressure Compensated.
 For additional information see Technical Tips on pages PV1-PV5.

Features

- One piece cartridge housing ensures internal concentricity
- Coil: Waterproof, hermetically sealed, requires no O’Rings; Symmetrical coil can be reversed without affecting performance.
- Nonmagnetic spool and housing assembly
- Factory-adjusted low variation option (Model “L”) is available for applications where low variation of flow from valve to valve is essential at a given current.

Specifications

Rated Flow	20 9.5 LPM (2.5 GPM) Standard (‘SS’ Coil) 21 19 LPM (5 GPM) High Flow (‘SP’ Coil)
Maximum Input Pressure at Port 2	210 Bar (3000 PSI)
Minimum Pressure Differential	20 6.9 Bar (150 PSI) Standard 21 20.7 Bar (300 PSI) High Flow
Maximum Internal Leakage	570 cc (35 cu. in.) @ 210 Bar (3000 PSI)
Hysteresis @ 100 Hz PWM	<3%
Cracking Pressure	25% of Input Signal
Variation of Flow @ 35% of Rated Current	Standard Model Up To ±20% Of Rated Flow Model “L” ±7% Of Rated Flow
Cartridge Material	All parts steel. All operating parts hardened steel.
Operating Temp. Range/Seals	-34°C to +121°C (Nitrile) (-30°F to +250°F) -26°C to +204°C (Fluorocarbon) (-15°F to +400°F)
Fluid Compatibility/Viscosity	Mineral-based or synthetic with lubricating properties at viscosities of 45 to 2000 SSU (6 to 420 cSt)
Filtration	ISO-4406 18/16/13, SAE Class 4
Approx. Weight	0.08 kg (0.17 lbs.)
Cavity	C08-3 (See BC Section for more details)

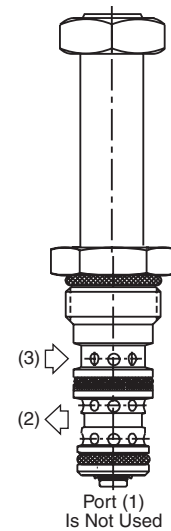
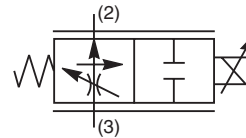

Performance Curves

▲ PWM Current Regulator Recommended

Flow vs. Input Current

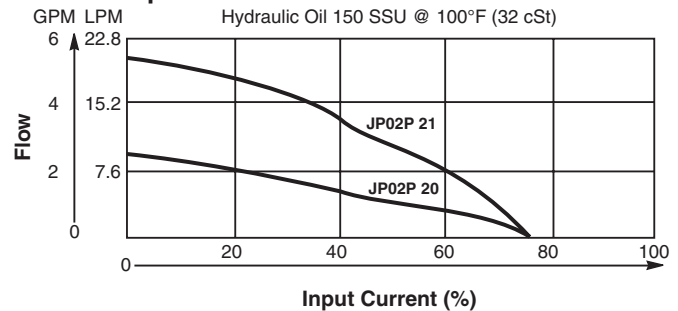

Flow Regulation (Measured 75% of Rated Current)

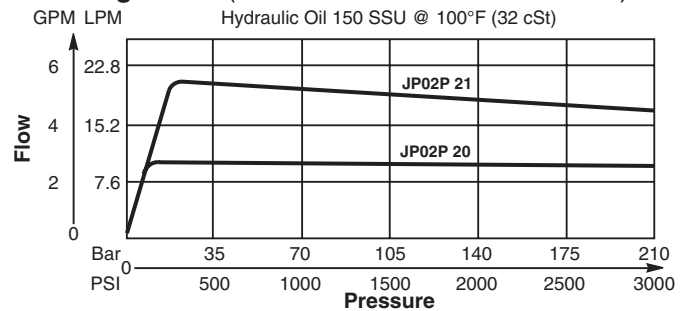

Pressure Drop vs. Flow

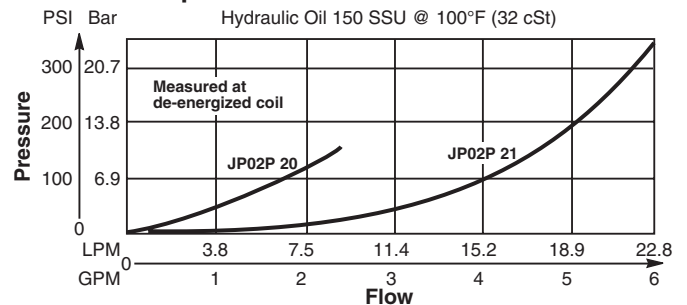

Dimensions Millimeters (Inches)

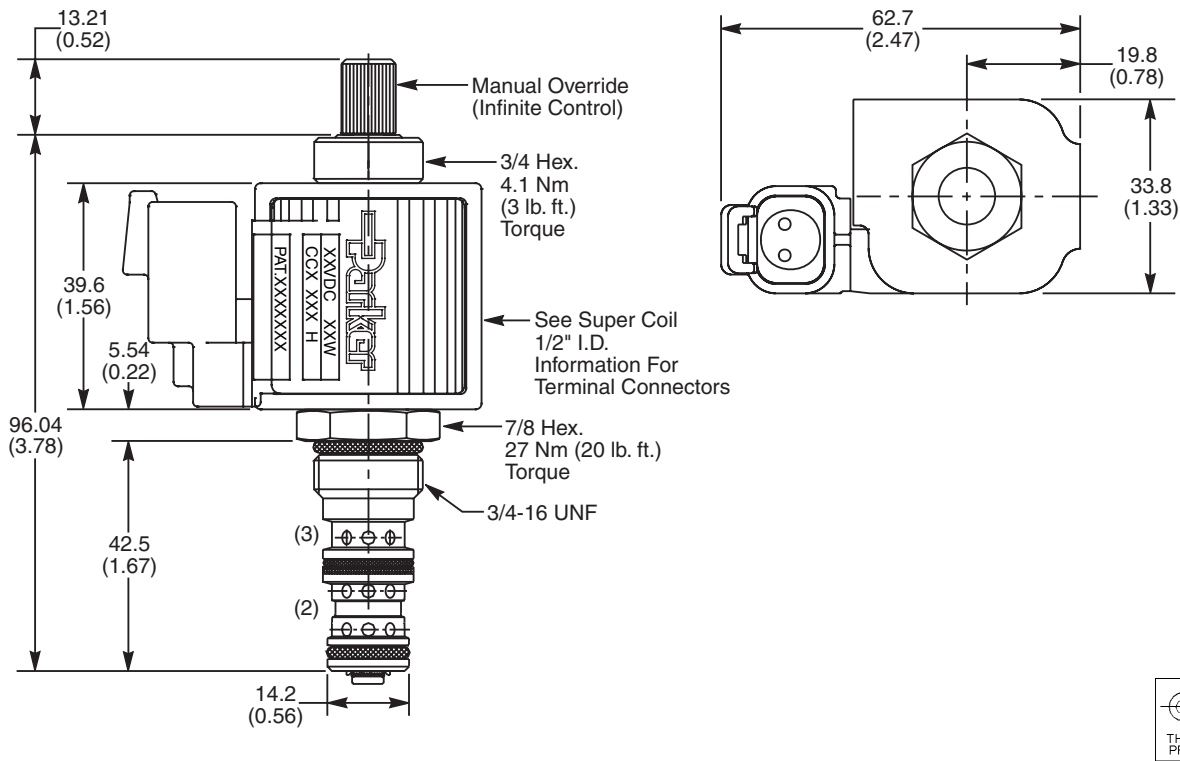

Ordering Information

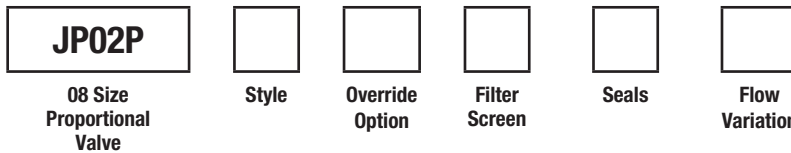

Highlighted represents preferred options that offer the shortest lead times. Other options may be available, but at extended lead times.

Coil(s) sold separately. Please see section CE of this catalog, 1/2" Super-Coil (CC series), for ordering information.

Code	Style (Maximum Regulated Flow)
20	Standard ('SS' Coil) 9.5 LPM (2.5 GPM)
21	High Flow ('SP' Coil) 19 LPM (5 GPM)

Code	Seals / Kit No.
N	Nitrile / Buna-N (SK30105N-1)
V	Fluorocarbon / (SK30105V-1)

Code	Override Option
0	Not Required
5	Infinite Control M.O.

Code	Flow Variation
Omit	Standard up to ±20% of Rated Flow
L	Low Variation (±7% of Rated Flow)

Code	Filter Screen
0	Not Available
1	60 Mesh Screen on Port 2

Order Bodies Separately
 See section BC



Code	Porting / Body Material
6T	SAE-6 / Steel (5000 PSI)
A6T	SAE-6 / Aluminium (3000 PSI)

- CV Check Valves
- SH Shuttle Valves
- LM Load/Motor Controls
- FC Flow Controls
- PC Pressure Controls
- LE Logic Elements
- DC Directional Controls
- MV Manual Valves
- SV Solenoid Valves
- PV Proportional Valves
- CE Coils & Electronics
- CB Cartrak Bodies
- BC Bodies & Cavities
- TD Technical Data