

Pressure Relief Functions

Pressure relief valve with cover with integrated pressure relief function

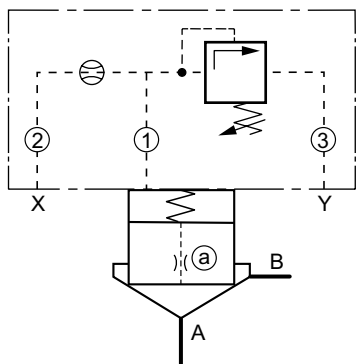

NG16 - NG32

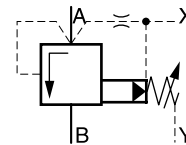

Description	Type		
	NG16	NG25	NG32
Cover incl. pressure valve ¹⁾	C016Fxxxxxxxxxx	C025Fxxxxxxxxxx	C032Fxxxxxxxxxx
Cover orifice ①	M5xØ1.0	M5xØ1.1	M6xØ1.2
Cover orifice ②	M4xØ0.8	M5xØ0.9	M6xØ1.0
Cover orifice ③	M5xØ99	M5xØ99	M6xØ99
Cartridge ²⁾	CP016C07S00X	CP025C07S00X	CP032C07S00X
Poppet orifice ①	1/16NPT x Ø0.9	1/16NPT x Ø1.1	1/16NPT x Ø1.2
Spring	1.6 bar, typ S		
Volume reduction	45036578	45036579	45036580
Bolt kit cover	BK414, 4x M8x40	BK391, 4x M12x50	BK415, 4x M16x55

8

¹⁾ Complete type see ordering code C*F.

²⁾ Complete type see ordering code CP*.

Shown orifice Ø and springs are recommendations.

xxØ00 = plug

xxØ99 = open

Examples pressure.INDD 18.10.22

Pressure relief valve with separate pilot

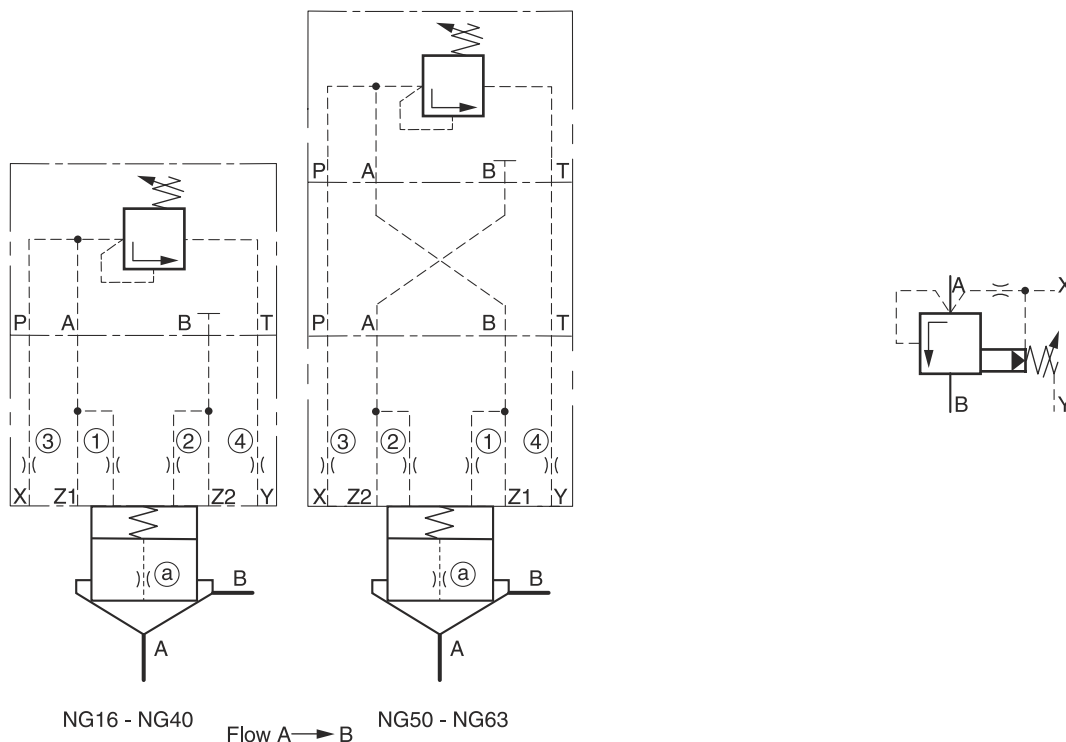

Adaptor plates see chapter 12

8

Description	Type					
	NG16	NG25	NG32	NG40	NG50	NG63
Pressure valve ¹⁾	R06Mxxx4x					
Adaptor plate ²⁾	without				PADA1007/A-B/B-A	
Cover ³⁾	C016CA*	C025CA*	C032CA*	C040CA*	C050CA*	C063CA*
Cover orifice ①	M5xØ1.1	M5xØ1.3	M5xØ1.4	M5xØ1.5	M6xØ1.6	M6xØ1.7
Cover orifice ②	M5xØ00				M6xØ00	
Cover orifice ③	M5xØ99	M6xØ99			M8xØ99	
Cover orifice ④	M5xØ1.3	M6xØ1.5	M6xØ1.7	M6xØ1.8	M8xØ2.0	M8xØ2.2
Cartridge ⁴⁾	CP016C07*	CP025C07*	CP032C07*	CP040C07*	CP050C07*	CP063C07*
Poppet orifice (a)	1/16NPT x Ø0.9	1/16NPT x Ø1.1	1/16NPT x Ø1.2	1/16NPT x Ø1.3	1/16NPT x Ø1.4	1/16NPT x Ø1.5
Spring	1.6 bar, type S					
Volume reduction	45036578	45036579	45036580	45036581	45036582	45036583
Bolt kit cover	BK414, 4x M8x40	BK391, 4x M12x50	BK415, 4x M16x55	BK416, 4x M20x70	BK417, 4x M20x75	BK418, 4x M30x100
Bolt kit pilot	BK443, 4x M5x45					

¹⁾ Complete type see pilot valves.
²⁾ Included O-rings and mounting bolts.
³⁾ Complete type see ordering code C*.
⁴⁾ Complete type see ordering code CP*.

Shown orifice Ø and springs are recommendations.
 xxØ00 = plug
 xxØ99 = open

Examples pressure.INDD 18.10.22

Pressure Relief Functions

Pressure relief valve with electrical vent function, normally open and cover with integrated pressure relief function

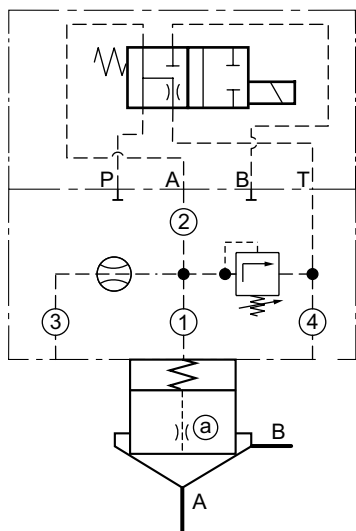

NG16 - NG32

Flow A → B

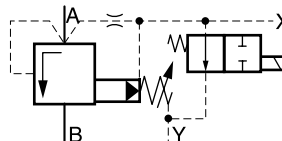

8

Description	Type		
	NG16	NG25	NG32
4/2 DC valve ¹⁾		D1VW104K*	
Cover incl. pressure valve ²⁾	C016Gxxxxxxxxxx	C025Gxxxxxxxxxx	C032Gxxxxxxxxxx
Cover orifice ①	M5xØ1.0	M5xØ1.1	M6xØ1.2
Cover orifice ②	M5xØ99	M5xØ99	M6xØ99
Cover orifice ③	M4xØ00	M5xØ00	M6xØ00
Cover orifice ④	M5xØ1.2	M5xØ1.3	M6xØ1.4
Cartridge ³⁾	CP016C07*	CP025C07*	CP032C07*
Poppet orifice ①a	1/16NPT x Ø0.8	1/16NPT x Ø0.8	1/16NPT x Ø1.0
Spring		1.6 bar, type S	
Volume reduction	45036578	45036579	45036580
Bolt kit cover	BK414, 4x M8x40	BK391, 4x M12x50	BK415, 4x M16x55
Bolt kit 4/2 DC valve		BK375, 4x M5x30	

¹⁾ Complete type see chapter "Directional Control Valves", series D1VW.

²⁾ Complete type see ordering code C*G.

³⁾ Complete type see ordering code CP*.

Shown orifice Ø and springs are recommendations.

xxØ00 = plug

xxØ99 = open

Examples pressure.INDD 18.10.22

Pressure relief valve with electrical vent function, normally open and pilot in sandwich design

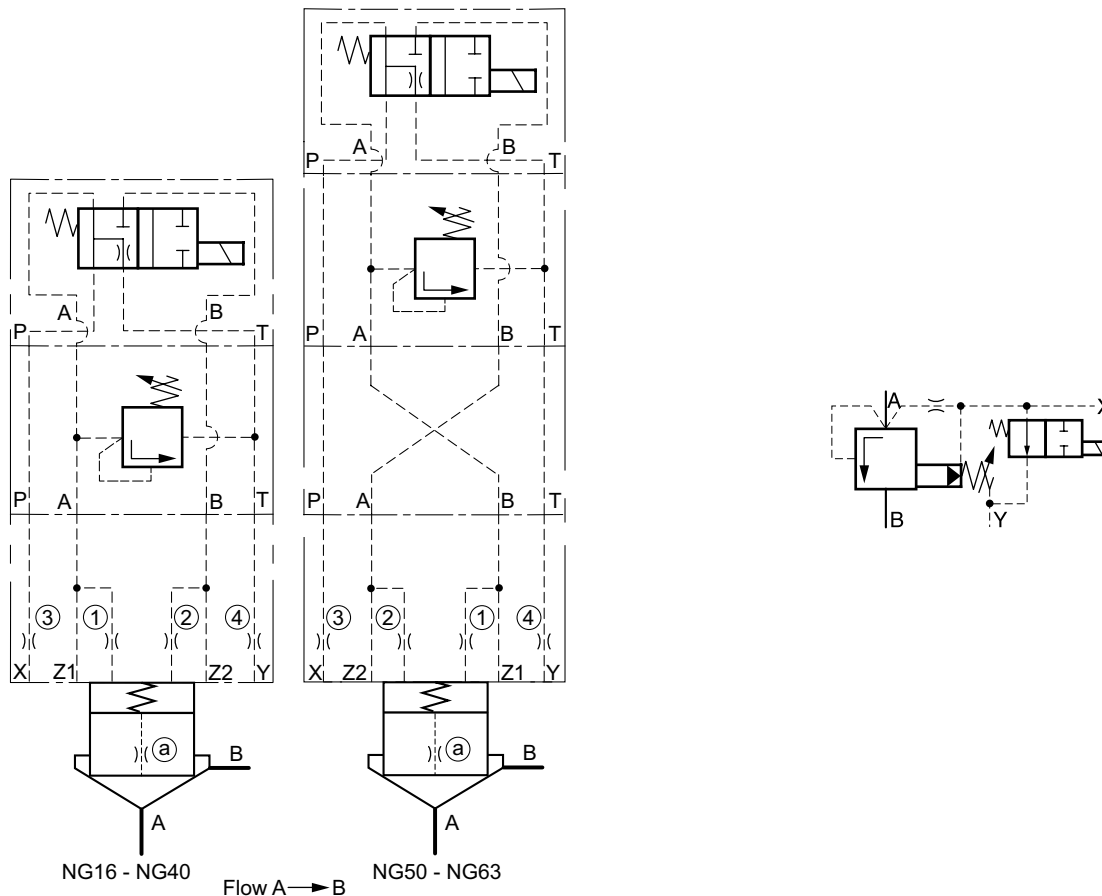

Adaptor plates see chapter 12



Description	Type					
	NG16	NG25	NG32	NG40	NG50	NG63
4/2 DC valve ¹⁾	D1VW104K*					
Pressure valve ²⁾	V-ZUDB1ATxZ07x					
Adaptor plate NG10-NG06 ³⁾	without			PADA1007/A-B/B-A		
Cover ⁴⁾	C016CA*	C025CA*	C032CA*	C040CA*	C050CA*	C063CA*
Cover orifice ①	M5xØ1.1	M5xØ1.3	M5xØ1.4	M5xØ1.5	M6xØ1.6	M6xØ1.7
Cover orifice ②	M5xØ00				M6xØ00	
Cover orifice ③	M5xØ99	M6xØ99		M8xØ99		
Cover orifice ④	M5xØ1.3	M6xØ1.5	M6xØ1.5	M6xØ1.8	M8xØ2.0	M8xØ2.2
Cartridge ⁵⁾	CP016C07*	CP025C07*	CP032C07*	CP040C07*	CP050C07*	CP063C07*
Poppet orifice (a)	1/16NPT x Ø0.9	1/16NPT x Ø1.1	1/16NPT x Ø1.2	1/16NPT x Ø1.3	1/16NPT x Ø1.4	1/16NPT x Ø1.5
Spring	1.6 bar, type S					
Volume reduction	45036578	45036579	45036580	45036581	45036582	45036583
Bolt kit cover	BK414, 4x M8x40	BK391, 4x M12x50	BK415, 4x M16x55	BK416, 4x M20x70	BK417, 4x M20x75	BK418, 4x M30x100
Bolt kit pilot	TK1482					

¹⁾ Complete type see chapter "Directional Control Valves", series D1VW.

²⁾ Complete types see pilot valves.

³⁾ Included O-rings and mounting bolts.

⁴⁾ Complete type see ordering code C*C.

⁵⁾ Complete type see ordering code CP*.

Shown orifice Ø and springs are recommendations.

xxØ00 = plug

xxØ99 = open

Pressure Relief Functions

Pressure relief valve with electrical vent function, normally closed and cover with integrated pressure relief function

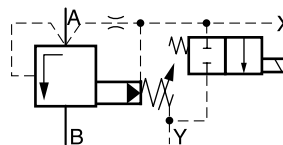
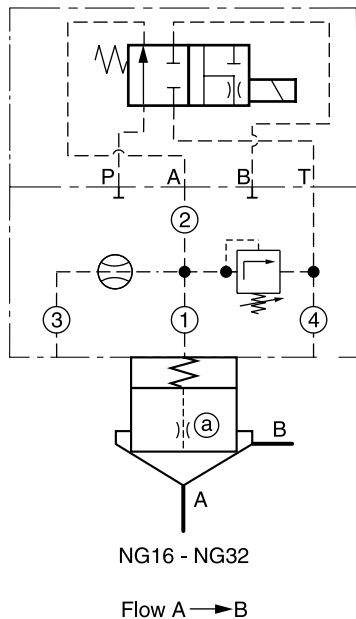

8

Description	Type		
	NG16	NG25	NG32
4/2 DC valve ¹⁾	D1VW105K*		
Cover incl. pressure valve ²⁾	C016Gxxxxxxxxxxx	C025Gxxxxxxxxxxx	C032Gxxxxxxxxxxx
Cover orifice ①	M5xØ1.0	M5xØ1.1	M6xØ1.4
Cover orifice ②	M5xØ99	M5xØ99	M6xØ99
Cover orifice ③	M4xØ00	M5xØ00	M6xØ00
Cover orifice ④	M5xØ1.2	M5xØ1.3	M6xØ1.4
Cartridge ³⁾	CP016C07*	CP025C07*	CP032C07*
Poppet orifice ①	1/16NPT x Ø0.8	1/16NPT x Ø0.8	1/16NPT x Ø1.0
Spring	1.6 bar, type S		
Volume reduction	45036578	45036579	45036580
Bolt kit cover	BK414, 4x M8x40	BK391, 4x M12x50	BK415, 4x M16x55
Bolt kit pilot	BK375, 4x M5x30		

¹⁾ Complete type see chapter "Directional Control Valves", series D1VW.

²⁾ Complete type see ordering code C*G.

³⁾ Complete type see ordering code CP*.

Shown orifice Ø and springs are recommendations.

xxØ00 = plug

xxØ99 = open

Examples pressure.INDD 18.10.22

Pressure relief valve with electrical vent function, normally closed and pilot in sandwich design

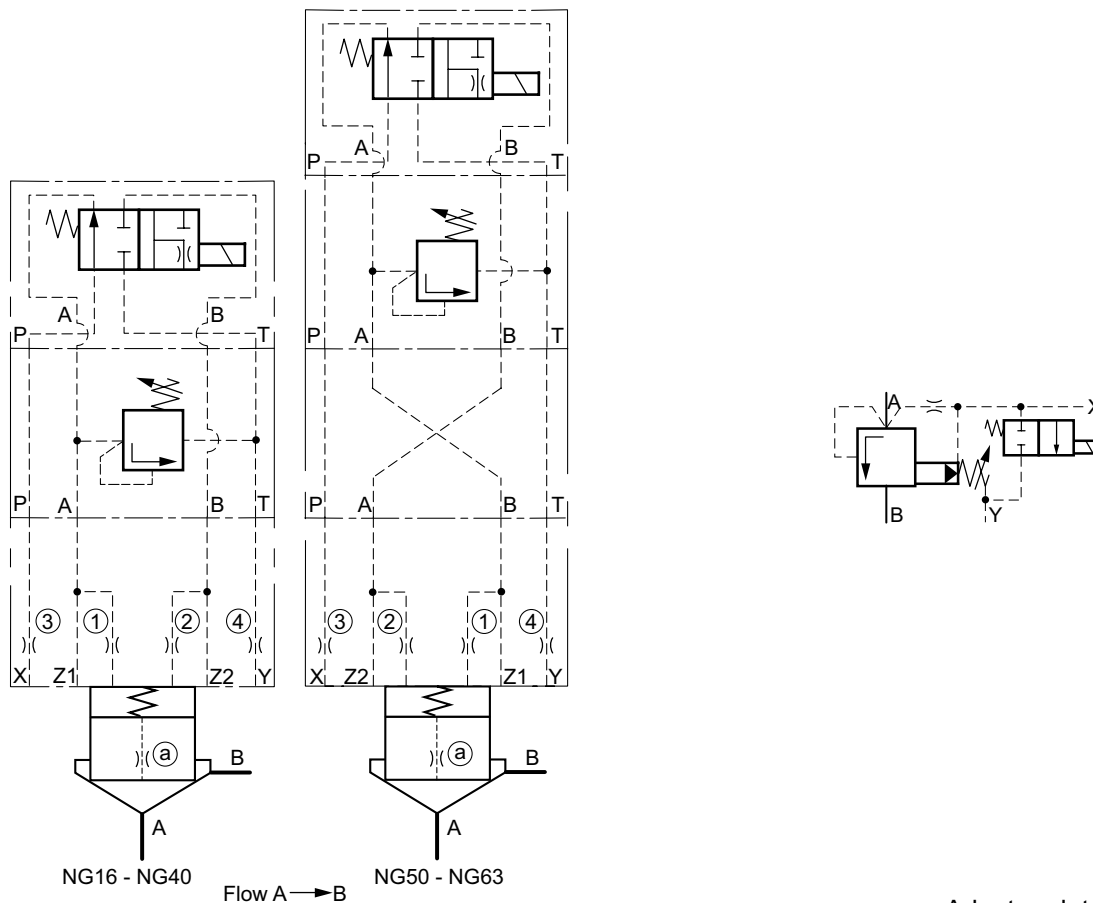

Adaptor plates see chapter 12

Description	Type					
	NG16	NG25	NG32	NG40	NG50	NG63
4/2 DC valve ¹⁾	D1VW105K*					
Pressure valve ²⁾	V-ZUDB1ATxZ07x					
Adaptor plate ³⁾	without				PADA1007/A-B/B-A	
Cover ⁴⁾	C016CA*	C025CA*	C032CA*	C040CA*	C050CA*	C063CA*
Cover orifice ①	M5xØ1.1	M5xØ1.3	M5xØ1.4	M5xØ1.5	M6xØ1.6	M6xØ1.7
Cover orifice ②	M5xØ00				M6xØ00	
Cover orifice ③	M5xØ99	M6xØ99			M8xØ99	
Cover orifice ④	M5xØ1.3	M6xØ1.5	M6xØ1.7	M6xØ1.8	M8xØ2.0	M8xØ2.2
Cartridge ⁵⁾	CP016C07*	CP025C07*	CP032C07*	CP040C07*	CP050C07*	CP063C07*
Poppet orifice (a)	1/16NPT x Ø0.9	1/16NPT x Ø1.1	1/16NPT x Ø1.2	1/16NPT x Ø1.3	1/16NPT x Ø1.4	1/16NPT x Ø1.5
Spring	1.6 bar, type S					
Volume reduction	45036578	45036579	45036580	45036581	45036582	45036583
Bolt kit cover	BK414, 4x M8x40	BK391, 4x M12x50	BK415, 4x M16x55	BK416, 4x M20x70	BK417, 4x M20x75	BK418, 4x M30x100
Bolt kit pilot	TK1482					

¹⁾ Complete type see chapter "Directional Control Valves", series D1VW.

²⁾ Complete types see pilot valves.

³⁾ Included O-rings and mounting bolts.

⁴⁾ Complete type see ordering code C*C.

⁵⁾ Complete type see ordering code CP*.

Shown orifice Ø and springs are recommendations.

xxØ00 = plug

xxØ99 = open

Proportional pressure relief valve

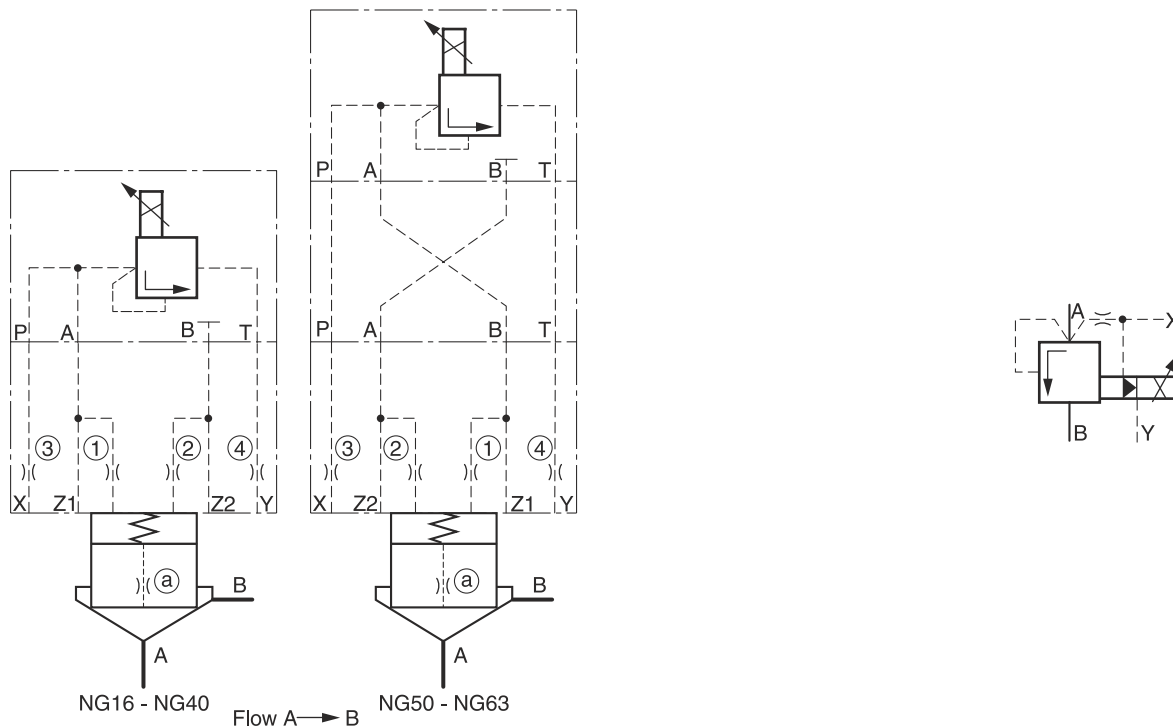

8

Adaptor plates see chapter 12

Description	Type					
	NG16	NG25	NG32	NG40	NG50	NG63
Prop. pressure valve ¹⁾	RE06MxW2V1KW					
Adaptor plate ²⁾	without				PADA1007/A-B/B-A	
Cover ³⁾	C016CA*	C025CA*	C032CA*	C040CA*	C050CA*	C063CA*
Cover orifice ①	M5xØ1.4	M5xØ1.4	M5xØ1.4	M5xØ1.4	M6xØ1.4	
Cover orifice ②	M5xØ00				M6xØ00	
Cover orifice ③	M5xØ99	M6xØ99			M8xØ99	
Cover orifice ④	M5xØ1.5	M6xØ1.5	M6xØ1.5	M6xØ1.5	M8xØ1.5	
Cartridge ⁴⁾	CP016C07*	CP025C07*	CP032C07*	CP040S07*	CP050S07*	CP063S07*
Poppet orifice (a)	1/16NPT x Ø1.3	1/16NPT x Ø1.3	1/16NPT x Ø1.3	1/16NPT x Ø1.3	1/16NPT x Ø1.3	
Spring	0.5 bar, type S					
Volume reduction	45036578	45036579	45036580	45036581	45036582	45036583
Bolt kit cover	BK414, 4x M8x40	BK391, 4x M12x50	BK415, 4x M16x55	BK416, 4x M20x70	BK417, 4x M20x75	BK418, 4x M30x100
Bolt kit pilot	BK375, 4x M5x30					

¹⁾ Complete type see chapter "Pressure Valves", series RE06M*W.
²⁾ Inclusive O-Rings and mounting bolts.
³⁾ Complete type see ordering code C*.
⁴⁾ Complete type see ordering code CP*.

Shown orifice Ø and springs are recommendations.
 xxØ00 = plug
 xxØ99 = open

Examples pressure.INDD 18.10.22

Proportional pressure relief valve with mechanical maximum pressure protection and cover with integrated pressure relief function

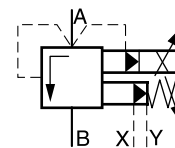
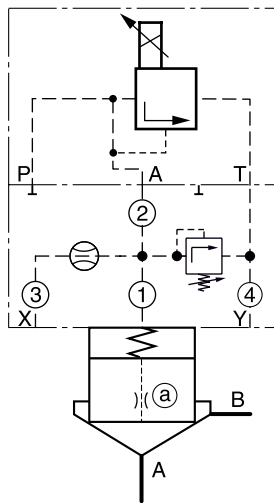

Flow A → B

Description	Type		
	NG16	NG25	NG32
Prop. pressure valve ¹⁾		RE06MxW2V1xW	
Cover incl. pressure valve ²⁾	C016Gxxxxxxxxxxx	C025Gxxxxxxxxxxx	C032Gxxxxxxxxxxx
Cover orifice ①	M5xØ1.4	M5xØ1.4	M6xØ1.4
Cover orifice ②	M5xØ99	M5xØ99	M6xØ99
Cover orifice ③	M4xØ99	M5xØ99	M6xØ99
Cover orifice ④	M5xØ1.5	M5xØ1.5	M6xØ1.5
Cartridge ³⁾	CP016C07*	CP025C07*	CP032C07*
Poppet orifice (a)	1/16NPT x Ø1.3	1/16NPT x Ø1.3	1/16NPT x Ø1.3
Spring		1.6 bar, type S	
Volume reduction	45036578	45036579	45036580
Bolt kit cover	BK414, 4x M8x40	BK391, 4x M12x50	BK415, 4x M16x55
Bolt kit pilot		BK375, 4x M5x30	

¹⁾ Complete type see chapter "Pressure Valves", series RE06M*W.
²⁾ Complete type see ordering code C*G.
³⁾ Complete type see ordering code CP*.

Shown orifice Ø and springs are recommendations.
 xxØ00 = plug
 xxØ99 = open

Proportional pressure relief valve with mechanical maximum pressure protection in sandwich design

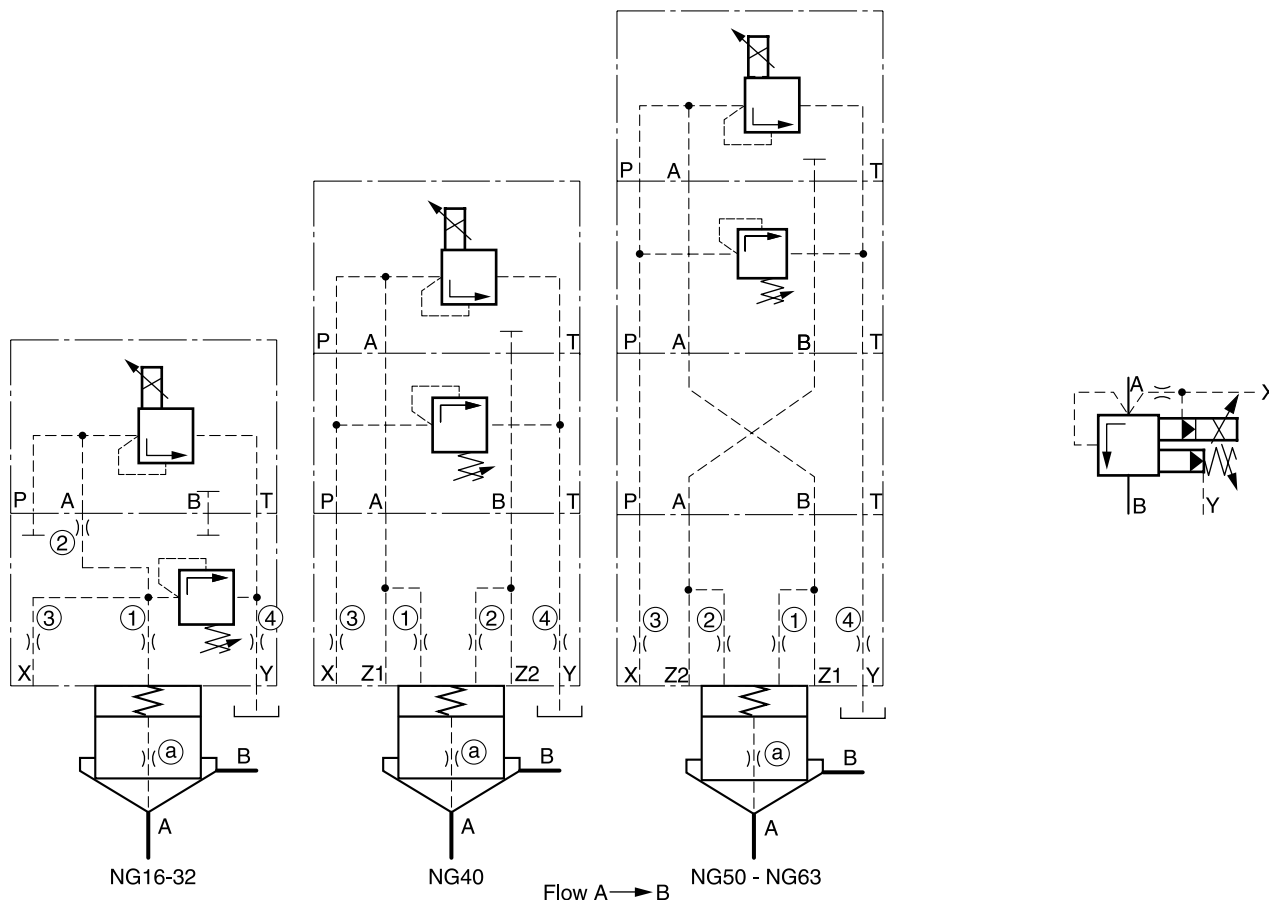

Adaptor plates see chapter 12

8

Description	Type					
	NG16	NG25	NG32	NG40	NG50	NG63
Prop. pressure valve ¹⁾	RE06MxW2V1KW					
Max. pressure valve ²⁾	ZUDB1PTxZ07x					
Adaptor plate NG10-NG06 ³⁾	without				PADA1007/A-B/B-A	
Cover ⁴⁾	C016CA*	C025CA*	C032CA*	C040CA*	C050CA*	C063CA*
Cover orifice ①	M5xØ1.4	M5xØ1.4		M5xØ1.4	M6xØ1.4	
Cover orifice ②	M5xØ99					M6xØ00
Cover orifice ③	M5xØ99	M6xØ99			M8xØ99	
Cover orifice ④	M5xØ1.5	M6xØ1.5		M6xØ1.5	M8xØ1.5	
Cartridge ⁵⁾	CP016C07*	CP025C07*	CP032C07*	CP040S07*	CP050S07*	CP063S07*
Poppet orifice ①	1/16NPT x Ø1.3	1/16NPT x Ø1.3	1/16NPT x Ø1.3	1/16NPT x Ø1.3	1/16NPT x Ø1.3	
Spring	1.6 bar, type S					
Volume reduction	45036578	45036579	45036580	45036581	45036582	45036583
Bolt kit cover	BK414, 4x M8x40	BK391, 4x M12x50	BK415, 4x M16x55	BK416, 4x M20x70	BK417, 4x M20x75	BK418, 4x M30x100
Bolt kit pilot	TK1482					

¹⁾ Complete type see chapter "Pressure Valves", series RE06M*W.

²⁾ Complete types see pilot valves.

³⁾ Included O-rings and mounting bolts.

⁴⁾ Complete type see ordering code C*C.

⁵⁾ Complete type see ordering code CP*.

Shown orifice Ø and springs are recommendations. xxØ00 = plug
 xxØ99 = open

Examples pressure.INDD 18.10.22

Unloading valve

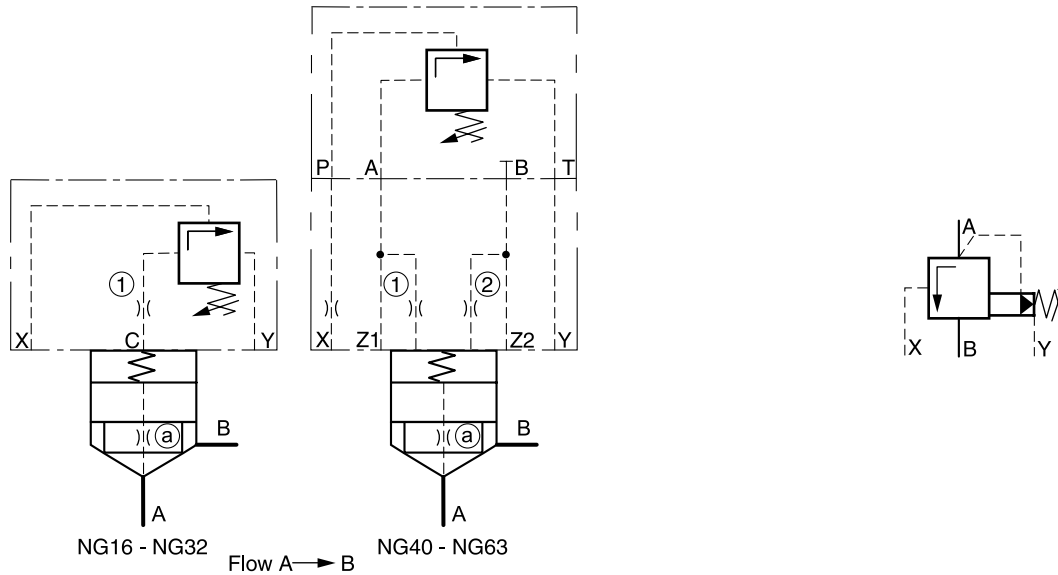

Adaptor plates see chapter 12

Description	Type					
	NG16	NG25	NG32	NG40	NG50	NG63
Unloading valve ¹⁾		-			UR06Mxxx4x	
Adaptor plate NG10-NG06 ²⁾	-	-	-	-	PADA1007/A-B/B-A	
Cover ³⁾	on request			C040CA*	C050CA*	C063CA*
Cover orifice ①	M5xØ1.4				M6xØ1.4	
Cover orifice ②	M5xØ00				M6xØ00	
Cartridge ⁴⁾	CP16C07*	CP25C07*	CP032C07*	CP040S07*	CP050S07*	CP063S07*
Poppet orifice (a)	1/16NPT x Ø1.2					
Spring	1.6 bar, type S					
Bolt kit cover	BK414, 4x M8x40	BK391, 4x M12x50	BK415, 4x M16x55	BK416, 4x M20x70	BK417, 4x M20x75	BK418, 4x M30x100
Bolt kit pilot	BK443, 4x M5x45					

¹⁾ Complete types see pilot valves.
²⁾ Included O-rings and mounting bolts.
³⁾ Complete type see ordering code C*C.
⁴⁾ Complete type see ordering code CP*.

Shown orifice Ø and springs are recommendations.
 xxØ00 = plug
 xxØ99 = open

Examples pressure.INDD 18.10.22

Unloading valve with electrical vent function, normally open

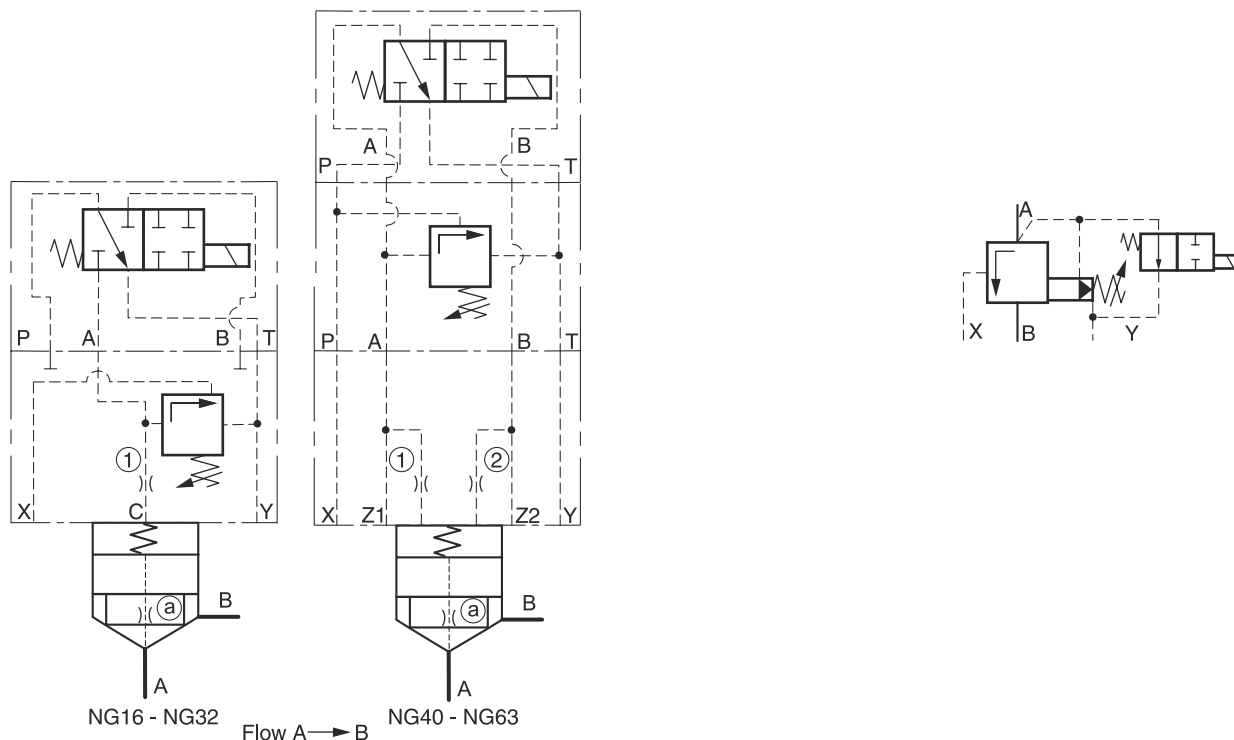

8

Adaptor plates see chapter 12

Description	Type					
	NG16	NG25	NG32	NG40	NG50	NG63
4/2 DC valve ¹⁾		-			D1VW076K*	
Pressure valve ²⁾	US06Mxxx4x					
Adaptor plate NG10-NG06 ³⁾	-	-	-	-	PADA1007/A-B/B-A	
Cover ⁴⁾	on request			C040CA*	C050CA*	C063CA*
Cover orifice ①	M5xØ1.4				M6xØ1.4	
Cover orifice ②	M5xØ00				M6xØ00	
Cartridge ⁵⁾	CP016C07*	CP025C07*	CP032C07*	CP040S07*	CP050S07*	CP063S07*
Poppet orifice ③	1/16NPT x Ø1.2					
Spring	1.6 bar, type S					
Bolt kit cover	BK414, 4x M8x40	BK391, 4x M12x50	BK415, 4x M16x55	BK416, 4x M20x70	BK417, 4x M20x75	BK418, 4x M30x100
Bolt kit pilot	BK401, 4x M5x75					

¹⁾ Complete type see chapter "Directional Control Valves", series D1VW.

²⁾ Complete types see pilot valves.

³⁾ Included O-rings and mounting bolts.

⁴⁾ Complete type see ordering code C*C.

⁵⁾ Complete type see ordering code CP*.

Shown orifice Ø and springs are recommendations.

xxØ00 = plug

xxØ99 = open

Examples pressure.INDD 18.10.22

Unloading valve with electrical vent function, normally closed

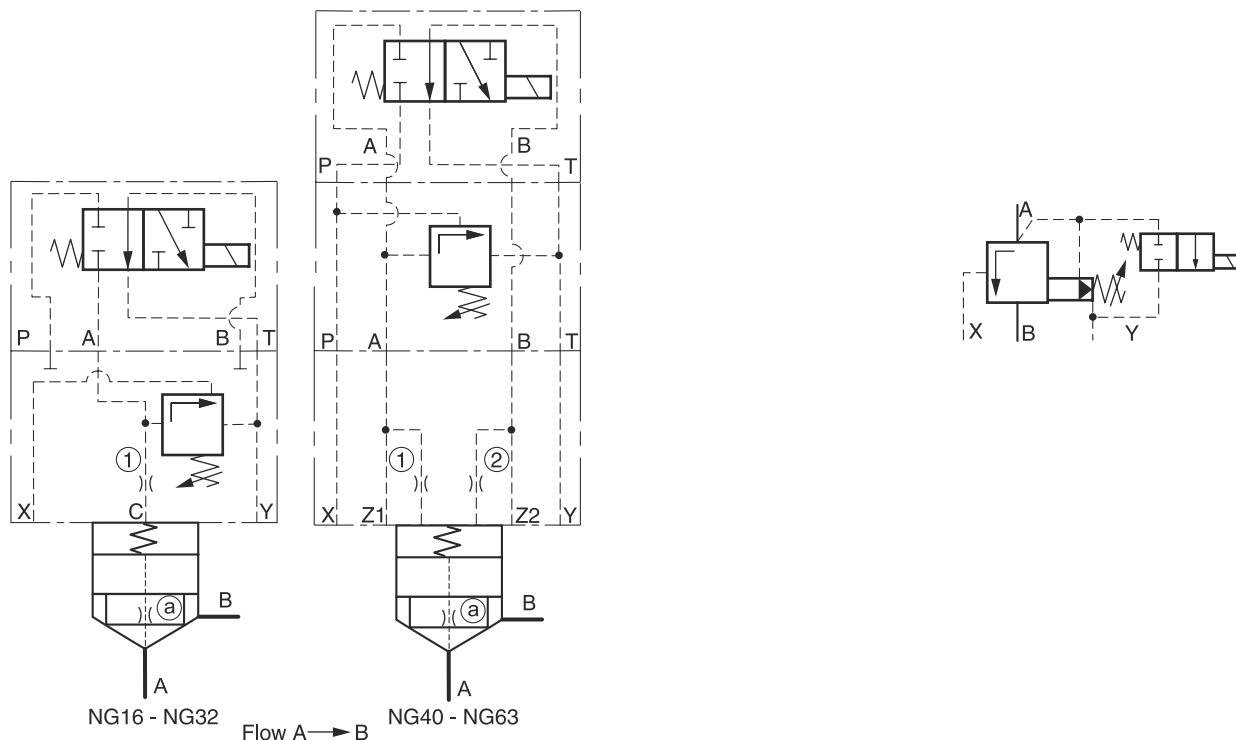

Adaptor plates see chapter 12

Description	Type					
	NG16	NG25	NG32	NG40	NG50	NG63
4/2 DC valve ¹⁾	D1VW078K*					
Pressure valve ²⁾	US06Mxxx4x					
Adaptor plate NG10-NG06 ³⁾	-	-	-	-	PADA1007/A-B/B-A	
Cover ⁴⁾	on request			C040CA*	C050CA*	C063CA*
Cover orifice ①	M5xØ1.4				M6xØ1.4	
Cover orifice ②	M5xØ00				M6xØ00	
Cartridge ⁵⁾	CP016C07*	CP025C07*	CP032C07*	CP040S07*	CP050S07*	CP063S07*
Poppet orifice (a)	1/16NPT x Ø1.2					
Spring	1.6 bar, type S					
Bolt kit cover	BK414, 4x M8x40	BK391, 4x M12x50	BK415, 4x M16x55	BK416, 4x M20x70	BK417, 4x M20x75	BK418, 4x M30x100
Bolt kit pilot	BK401, 4x M5x75					

¹⁾ Complete type see chapter "Directional Control Valves", series D1VW.
²⁾ Complete types see pilot valves.
³⁾ Included O-rings and mounting bolts.
⁴⁾ Complete type see ordering code C*C.
⁵⁾ Complete type see ordering code CP*.

Shown orifice Ø and springs are recommendations.
 xxØ00 = plug
 xxØ99 = open

Examples pressure.INDD 18.10.22

Pressure sequence valve

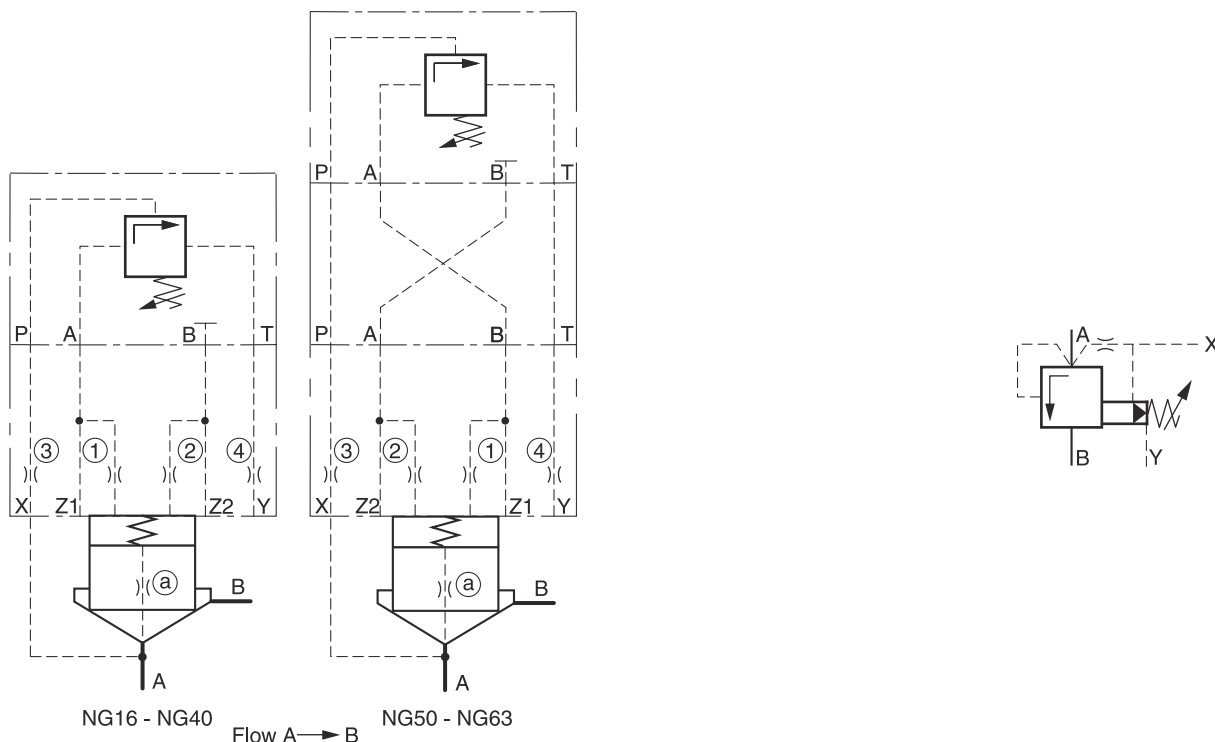

8

Adaptor plates see chapter 12

Description	Type					
	NG16	NG25	NG32	NG40	NG50	NG63
Press. sequ. valve ¹⁾	S06Mxxx4x					
Adaptor plate NG10-NG06 ²⁾	without				PADA1007/A-B/B-A	
Cover ³⁾	C016CA*	C025CA*	C032CA*	C040CA*	C050CA*	C063CA*
Cover orifice ①	M5xØ1.1	M5xØ1.3	M5xØ1.4	M5xØ1.5	M6xØ1.6	M6xØ1.7
Cover orifice ②	M5xØ00				M6xØ00	
Cover orifice ③	M5xØ0.9	M6xØ1.1	M6xØ1.2	M6xØ1.3	M8xØ1.4	M8xØ1.5
Cover orifice ④	M5xØ1.3	M6xØ1.5	M6xØ1.7	M6xØ1.8	M8xØ2.0	M8xØ2.2
Cartridge ⁴⁾	CE016C01*	CE025C01*	CE032C01*	CE040C01*	CE050C01*	CE063C01*
Poppet orifice ①	1/16NPT x Ø00					
Spring	1.6 bar, type S					
Bolt kit cover	BK414, 4x M8x40	BK391, 4x M12x50	BK415, 4x M16x55	BK416, 4x M20x70	BK417, 4x M20x75	BK418, 4x M30x100
Bolt kit pilot	BK443, 4x M5x45					

¹⁾ Complete types see pilot valves.
²⁾ Included O-rings and mounting bolts.
³⁾ Complete type see ordering code C*C.
⁴⁾ Complete type see ordering code CE*.

Shown orifice Ø and springs are recommendations.
 xxØ00 = closed bottom NG16 - NG50, plug NG63
 xxØ99 = open

Examples pressure.INDD 18.10.22

3-way compensator (in combination with proportional throttle valve)

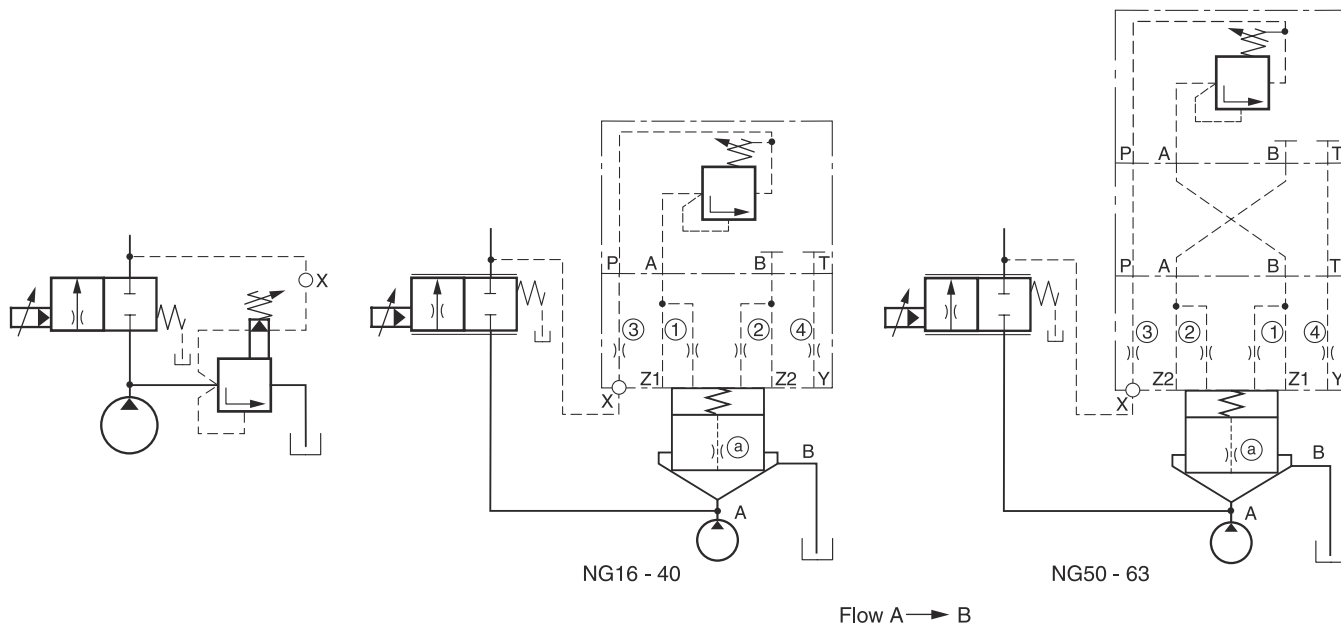

Adaptor plates see chapter 12

Description	Type					
	NG16	NG25	NG32	NG40	NG50	NG63
Preload valve ¹⁾	DSBA100xP07x					
Adaptor plate NG10-NG06 ²⁾	without			PADA1007/A-B/B-A		
Cover ³⁾	C016CA*	C025CA*	C032CA*	C040CA*	C050CA*	C063CA*
Cover orifice ①	M5xØ1.1	M5xØ1.3	M5xØ1.4	M5xØ1.5	M6xØ1.6	M6xØ1.7
Cover orifice ②	M5xØ00				M6xØ00	
Cover orifice ③	M5xØ99	M6xØ99			M8xØ99	
Cover orifice ④	M5xØ1.3	M6xØ1.5	M6xØ1.7	M6xØ1.8	M8xØ2.0	M8xØ2.2
Cartridge ⁴⁾	CE016C01*	CE025C01*	CE032C01*	CE040C01*	CE050C01*	CE063C01*
Poppet orifice ①	1/16NPT x Ø0.9	1/16NPT x Ø1.1	1/16NPT x Ø1.2	1/16NPT x Ø1.3	1/16NPT x Ø1.4	1/16NPT x Ø1.5
Spring	1.6 bar, type S					
Bolt kit cover	BK414, 4x M8x40	BK391, 4x M12x50	BK415, 4x M16x55	BK416, 4x M20x70	BK417, 4x M20x75	BK418, 4x M30x100
Bolt kit pilot	BK443, 4x M5x45					

¹⁾ Complete type see pilot valves.
²⁾ Included O-rings and mounting bolts.
³⁾ Complete type see ordering code C*.
⁴⁾ Complete type see ordering code CE*.

Shown orifice Ø and springs are recommendations.
 xxØ00 = closed bottom NG16 - NG50, plug NG63
 xxØ99 = open

3-way compensator with mechanical maximum pressure protection (in combination with proportional throttle valve)

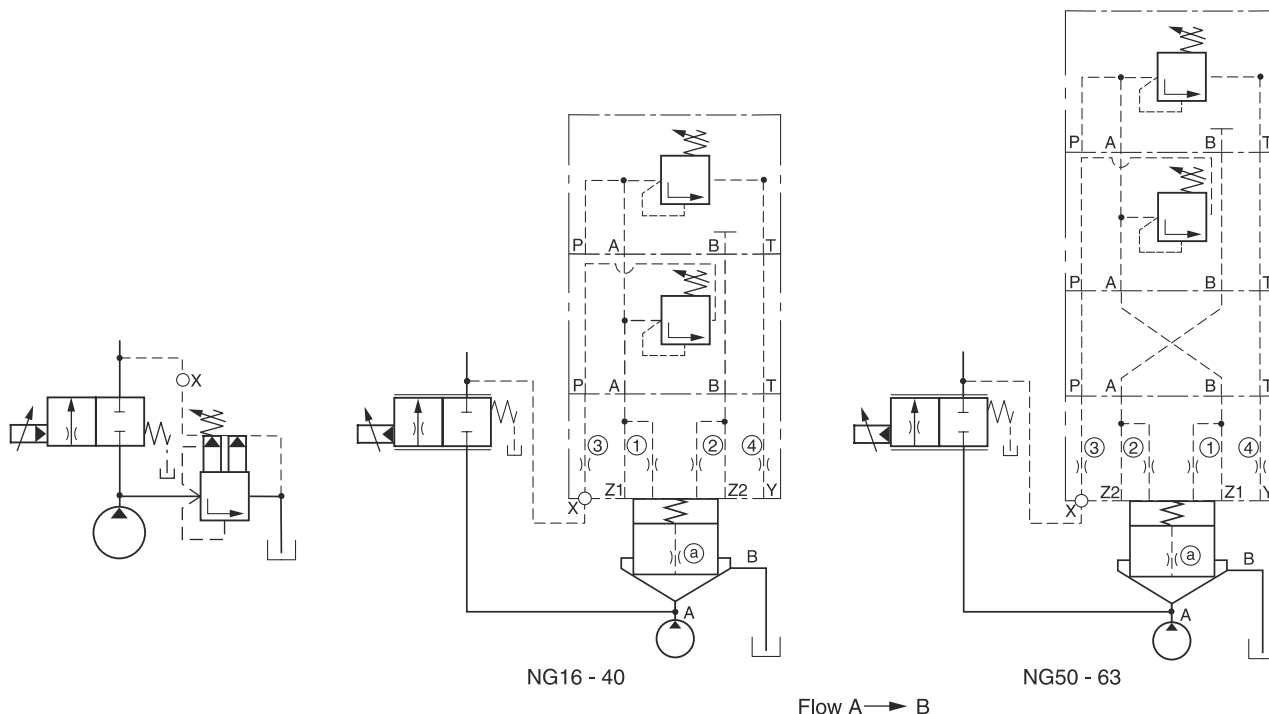

8

Adaptor plates see chapter 12

Description	Type					
	NG16	NG25	NG32	NG40	NG50	NG63
Pressure valve ¹⁾	R06Mxxx4x					
Preload valve ¹⁾	DSBA100xZ07x					
Adaptor plate NG10-NG06 ²⁾	without			PADA1007/A-B/B-A		
Cover ³⁾	C016CA*	C025CA*	C032CA*	C040CA*	C050CA*	C063CA*
Cover orifice ①	M5xØ1.1	M5xØ1.3	M5xØ1.4	M5xØ1.5	M6xØ1.6	M6xØ1.7
Cover orifice ②	M5xØ00				M6xØ00	
Cover orifice ③	M5xØ99	M6xØ99			M8xØ99	
Cover orifice ④	M5xØ1.3	M6xØ1.5	M6xØ1.7	M6xØ1.8	M8xØ2.0	M8xØ2.2
Cartridge ⁴⁾	CE016C01*	CE025C01*	CE032C01*	CE040C01*	CE050C01*	CE063C01*
Poppet orifice ①	1/16NPT x Ø0.9	1/16NPT x Ø1.1	1/16NPT x Ø1.2	1/16NPT x Ø1.3	1/16NPT x Ø1.4	1/16NPT x Ø1.5
Spring	1.6 bar, type S					
Bolt kit cover	BK414, 4x M8x40	BK391, 4x M12x50	BK415, 4x M16x55	BK416, 4x M20x70	BK417, 4x M20x75	BK418, 4x M30x100
Bolt kit pilot	TK1482					

¹⁾ Complete type see examples pilot valve.

²⁾ Included O-rings and mounting bolts.

³⁾ Complete type see ordering code C*.

⁴⁾ Complete type see ordering code CE*.

Shown orifice Ø and springs are recommendations.

xxØ00 = closed bottom NG16 - NG50, plug NG63

xxØ99 = open

3-way compensator with proportional pressure relief function (in combination with proportional throttle valve)

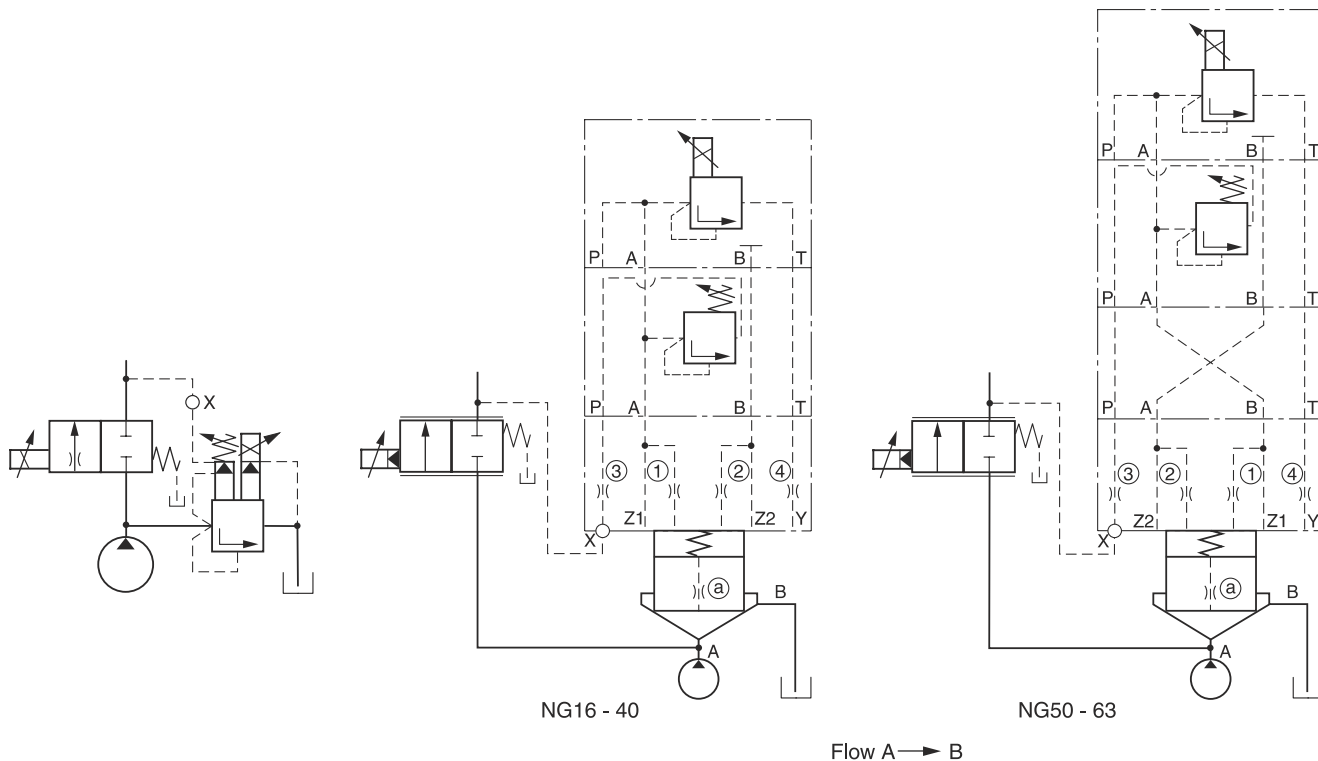

Adaptor plates see chapter 12



Description	Type					
	NG16	NG25	NG32	NG40	NG50	NG63
Prop. press. valve ¹⁾	RE06MxW2V1KW*					
Preload valve ²⁾	DSBA100xZ07x					
Adaptor plate NG10-NG06 ³⁾	without			PADA1007/A-B/B-A		
Cover ⁴⁾	C016CA*	C025CA*	C032CA*	C040CA*	C050CA*	C063CA*
Cover orifice ①	M5xØ1.1	M5xØ1.3	M5xØ1.4	M5xØ1.5	M6xØ1.6	M6xØ1.7
Cover orifice ②	M5xØ00					M6xØ00
Cover orifice ③	M5xØ99	M6xØ99			M8xØ99	
Cover orifice ④	M5xØ1.3	M6xØ1.5	M6xØ1.7	M6xØ1.8	M8xØ2.0	M8xØ2.2
Cartridge ⁵⁾	CE016C01*	CE025C01*	CE032C01*	CE040C01*	CE050C01*	CE063C01*
Poppet orifice (a)	1/16NPT x Ø0.9	1/16NPT x Ø1.1	1/16NPT x Ø1.2	1/16NPT x Ø1.3	1/16NPT x Ø1.4	1/16NPT x Ø1.5
Spring	1.6 bar, type S					
Volume reduction	45036578	45036579	45036580	45036581	45036582	45036583
Bolt kit cover	BK414, 4x M8x40	BK391, 4x M12x50	BK415, 4x M16x55	BK416, 4x M20x70	BK417, 4x M20x75	BK418, 4x M30x100
Bolt kit pilot	TK1482					

¹⁾ Complete type see chapter "Pressure Valves", series RE06M*W.
²⁾ Complete type see pilot valves.
³⁾ Included O-rings and mounting bolts.
⁴⁾ Complete type see ordering code C*C.
⁵⁾ Complete type see ordering code CE*.

Shown orifice Ø and springs are recommendations.
 xxØ00 = closed bottom NG16 - NG50, plug NG63
 xxØ99 = open

Pressure Compensator Functions

3-way compensator with mechanical max. pressure protection and electrical vent function, normally open (in combination with proportional throttle valve)

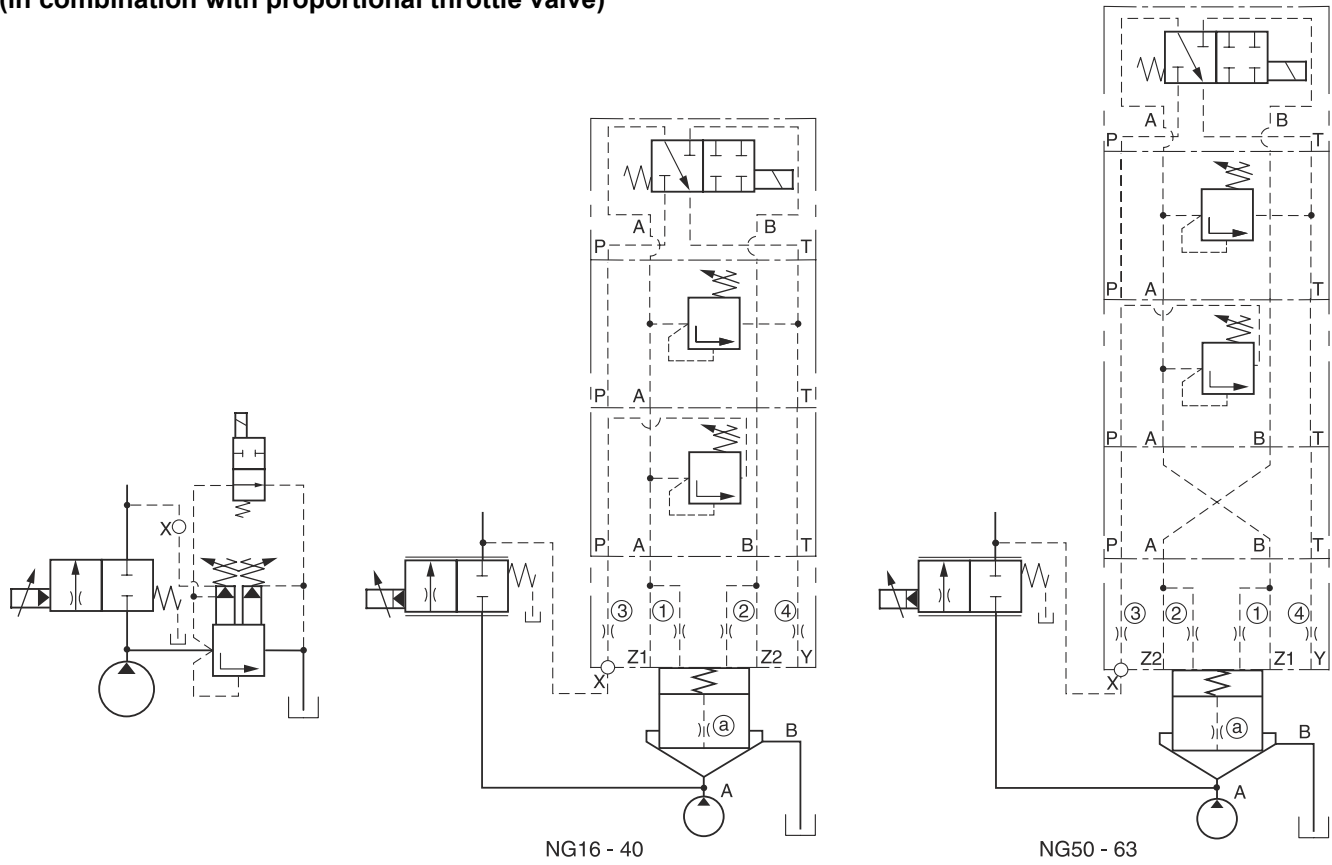

Flow A → B

Adaptor plates see chapter 12

8

Description	Type					
	NG16	NG25	NG32	NG40	NG50	NG63
4/2 DC valve ¹⁾	D1VW076K*					
Press. valve ²⁾	ZUDB1ATxZ07x					
Preload valve ²⁾	DSBA100xZ07x					
Adaptor plate NG10-NG06 ³⁾	without			PADA1007/A-B/B-A		
Cover ⁴⁾	C016CA*	C025CA*	C032CA*	C040CA*	C050CA*	C063CA*
Cover orifice ①	M5xØ1.1	M5xØ1.3	M5xØ1.4	M5xØ1.5	M6xØ1.6	M6xØ1.7
Cover orifice ②	M5xØ00					
Cover orifice ③	M5xØ99	M6xØ99			M8xØ99	
Cover orifice ④	M5xØ1.3	M6xØ1.5	M6xØ1.7	M6xØ1.8	M8xØ2.0	M8xØ2.2
Cartridge ⁵⁾	CE016C01*	CE025C01*	CE032C01*	CE040C01*	CE050C01*	CE063C01*
Poppet orifice ①	1/16NPT x Ø0.9	1/16NPT x Ø1.1	1/16NPT x Ø1.2	1/16NPT x Ø1.3	1/16NPT x Ø1.4	1/16NPT x Ø1.5
Spring	1.6 bar, type S					
Bolt kit cover	BK414, 4x M8x40	BK391, 4x M12x50	BK415, 4x M16x55	BK416, 4x M20x70	BK417, 4x M20x75	BK418, 4x M30x100
Bolt kit pilot	TK1473					

¹⁾ Complete type see chapter "Directional Control Valves", series D1VW.

²⁾ Complete type see pilot valves.

³⁾ Included O-rings and mounting bolts.

⁴⁾ Complete type see ordering code C*.

⁵⁾ Complete type see ordering code CE*.

Shown orifice Ø and springs are recommendations.
xxØ00 = closed bottom NG16 - NG50, plug NG63
xxØ99 = open

Examples pressure.INDD 18.10.22

3-way compensator with proportional pressure relief function and mechanical maximum pressure protection (in combination with proportional throttle valve)

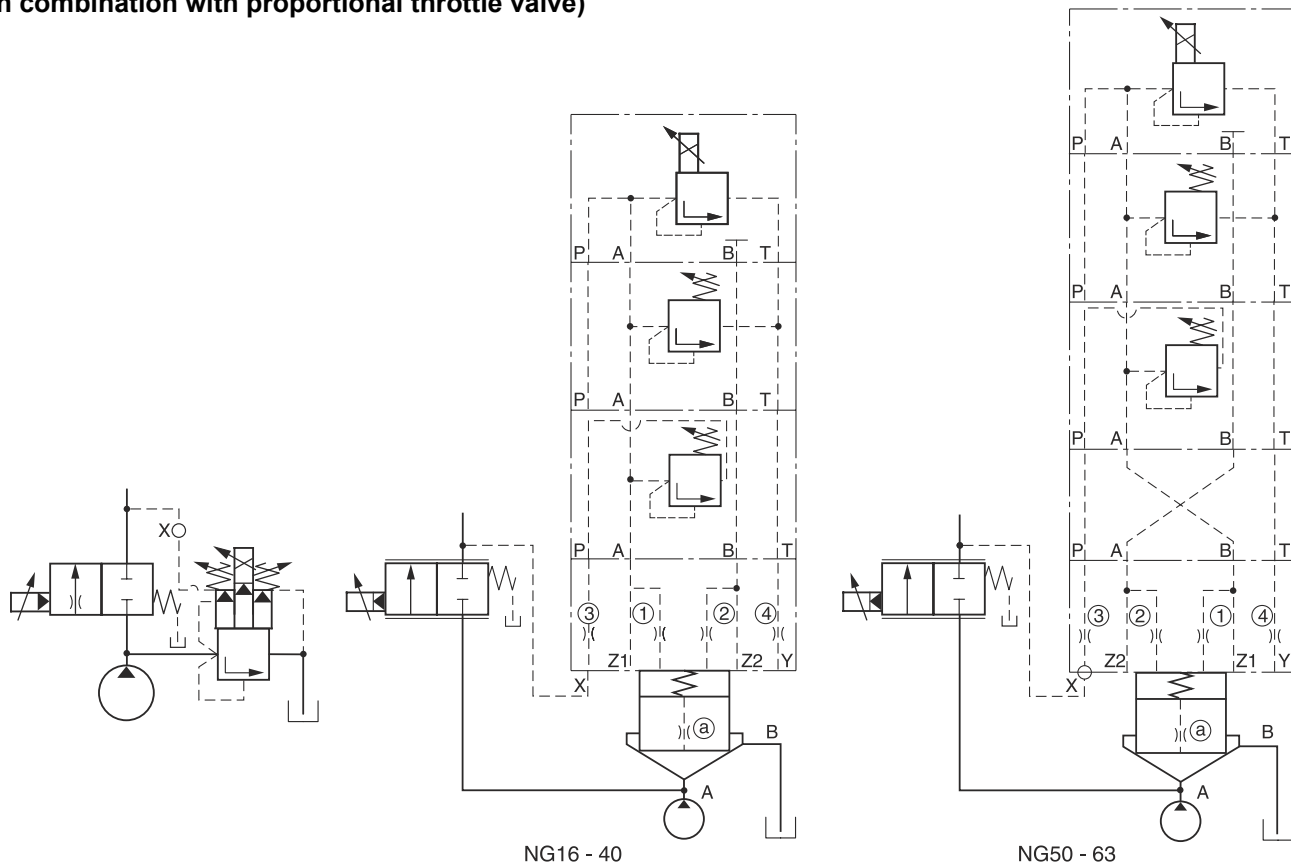

NG16 - 40

NG50 - 63

Flow A → B

Adaptor plates see chapter 12



Description	Type					
	NG16	NG25	NG32	NG40	NG50	NG63
Prop. press. valve ¹⁾	RE06MxW2V1KW*					
Press. valve ²⁾	ZUDB1ATxZ07x					
Preload valve ²⁾	DSBA100xZ07x					
Adaptor plate NG10-NG06 ³⁾	without			PADA1007/A-B/B-A		
Cover ⁴⁾	C016CA*	C025CA*	C032CA*	C040CA*	C050CA*	C063CA*
Cover orifice ①	M5xØ1.1	M5xØ1.3	M5xØ1.4	M5xØ1.5	M6xØ1.6	M6xØ1.7
Cover orifice ②	M5xØ00				M6xØ00	
Cover orifice ③	M5xØ99	M6xØ99			M8xØ99	
Cover orifice ④	M5xØ1.3	M6xØ1.5	M6xØ1.7	M6xØ1.8	M8xØ2.0	M8xØ2.2
Cartridge ⁵⁾	CE016C01*	CE025C01*	CE032C01*	CE040C01*	CE050C01*	CE063C01*
Poppet orifice ⑤	1/16NPT x Ø0.9	1/16NPT x Ø1.1	1/16NPT x Ø1.2	1/16NPT x Ø1.3	1/16NPT x Ø1.4	1/16NPT x Ø1.5
Spring	1.6 bar, type S					
Volume reduction	45036578	45036579	45036580	45036581	45036582	45036583
Bolt kit cover	BK414, 4x M8x40	BK391, 4x M12x50	BK415, 4x M16x55	BK416, 4x M20x70	BK417, 4x M20x75	BK418, 4x M30x100
Bolt kit pilot	TK1473					

¹⁾ Complete type see chapter "Pressure Valves", series RE06M*W.
²⁾ Complete type see pilot valves.
³⁾ Included O-rings and mounting bolts.
⁴⁾ Complete type see ordering code C*C.
⁵⁾ Complete type see ordering code CE*.

Shown orifice Ø and springs are recommendations.
 xxØ00 = closed bottom NG16 - NG50, plug NG63
 xxØ99 = open