

Characteristics / Ordering Code

Check valves of the series C1DB consist of a slip-in valve, that is designed for a compact manifold block installation.

Features

- Cavity and mounting pattern according to ISO 7368
- 4 different springs
- 8 sizes NG16 to NG100

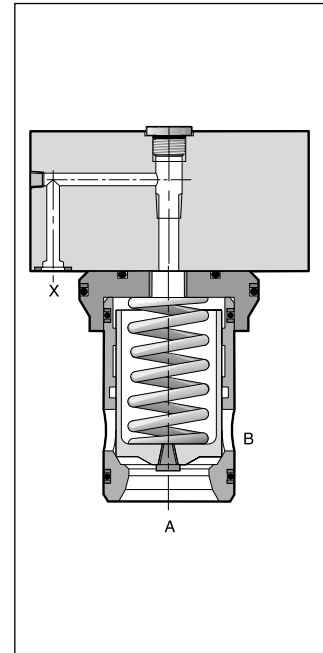
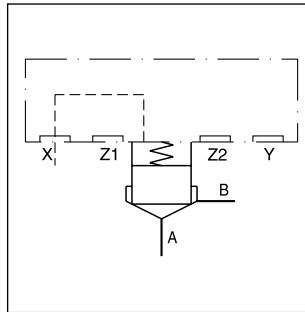
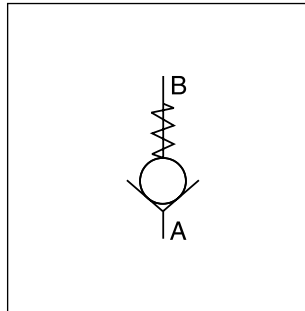

Ordering code

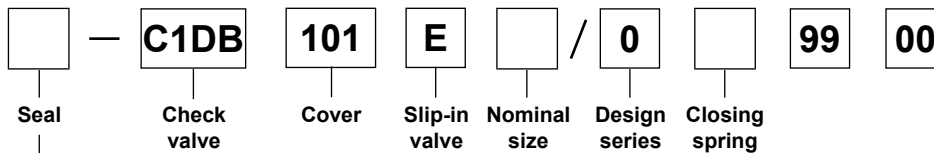

Code	Seal
omit	NBR
V	FPM

Code	Nominal size
16	NG16
25	NG25
32	NG32
40	NG40
50	NG50
63	NG63
80	NG80
100	NG100

Code	Spring
L	0.1 bar
N	0.5 bar
S	1.6 bar
T	2.5 bar
U	4.0 bar

Bold letters = Short-term availability

Replacement springs see spare and mounting parts

Technical data

General									
Design	2-way cartridge valve, according to ISO 7368								
Nominal size	NG16	NG25	NG32	NG40	NG50	NG63	NG80	NG100	
Actuation	hydraulic								
Mounting position	unrestricted								
Ambient temperature	[°C]	-20 ... +60							
MTTF _D value	[years]	150							
Weight	[kg]	1.2	2.5	3.9	7	11.4	21.8	45	74
Hydraulics									
Flow direction	See symbols								
Fluid	Hydraulic oil according to DIN 51524								
Fluid temperature	[°C]	-20...+70 (NBR: -25...+70)							
Viscosity,	permitted	20...400							
	recommended	30...80							
Filtration	ISO 4406 (1999); 18/16/13								
Nominal pressure	[bar]	350							
Flow	[l/min]	250	450	900	1300	1800	3600	5250	8000
Opening pressure, spring	[bar]	L = 0.1; N = 0.5; S = 1.6; T = 2.5; U = 4.0							

8

Performance curves

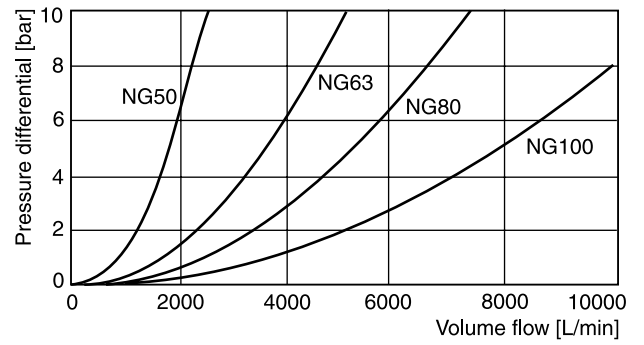
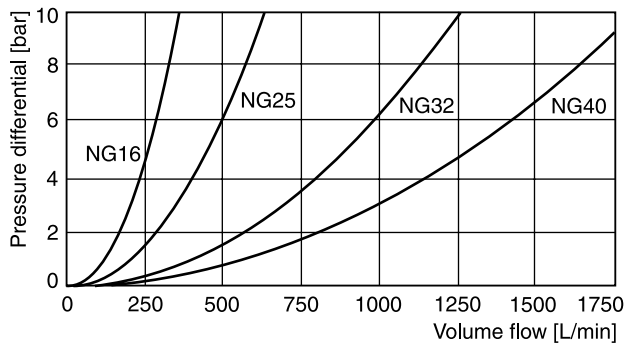

All characteristic curves measured with HLP46 at 50 °C.

Dimensions

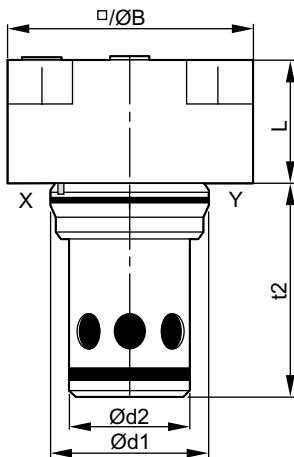

NG	L	B	d1	d2	t2
16	36	65	32	25	56
25	45	85	45	34	72
32	50	102	60	45	85
40	60	125	75	55	105
50	70	140	90	68	122
63	85	180	120	90	155
80	105	Ø 250	145	110	205
100	120	Ø 300	180	135	245



NG	Kit	ISO 4762-12.9	[Nm]	Kit		Orifice thread
				NBR	FPM	
16	BK441	4x M8x50	31.8	SK-CBE160	SK-CBE160V	1/16 NPT
25	BK391	4x M12x50	108	SK-CBE250	SK-CBE250V	1/16 NPT
32	BK415	4x M16x55	264	SK-CBE320	SK-CBE320V	1/16 NPT
40	BK416	4x M20x70	517	SK-CBE400	SK-CBE400V	1/8 NPT
50	BK417	4x M20x75	517	SK-CBE500	SK-CBE500V	1/8 NPT
63	BK418	4x M30x100	1775	SK-CBE630	SK-CBE630V	1/8 NPT
80	BK419	8x M24x120	890	SK-CBE800	SK-CBE800V	1/8 NPT
100	BK420	8x M30x140	1775	SK-CBE1000	SK-CBE1000V	1/8 NPT