

Pilot valve with pressure relief function R06M, sub-plate mounting NG06, see combination examples.
 MTTF_D value 150 years, flow rate maximum 5 l/min.

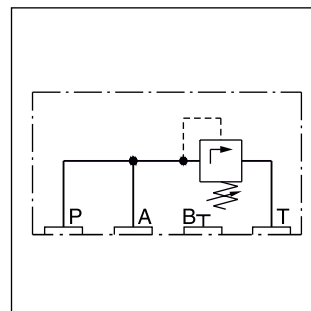

Ordering code

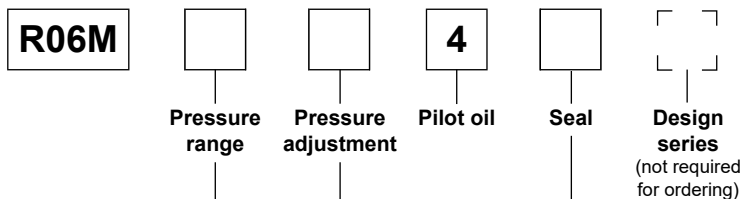

Code	Pressure range [bar]
10	105
17	175
21	210
25	250
35	350

Code	Seal
N	NBR
V	FPM

Code	Adjustment
S	Hand knob (standard)
A	Acorn nut with lead seal

Bold letters = Short-term availability

8

Dimensions

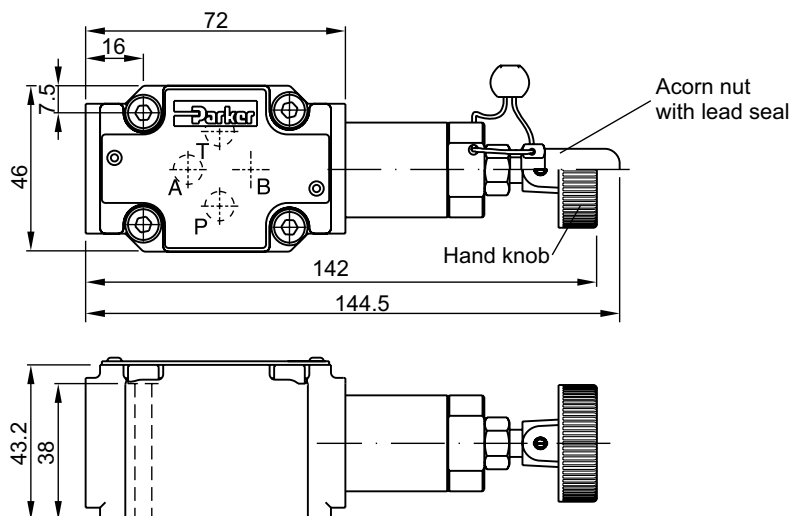

Pilot valve with pressure relief function RS06M, sandwich plate mounting NG06, see combination examples. MTTF_D value 150 years, flow rate maximum 5 l/min.

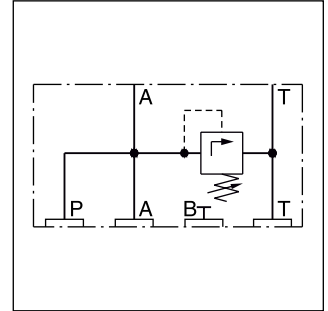

Ordering code

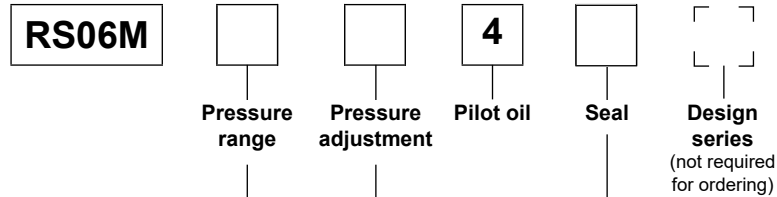

Code	Pressure range [bar]
10	105
17	175
21	210
25	250
35	350

Code	Seal
N	NBR
V	FPM

Code	Adjustment
S	Hand knob (standard)
A	Acorn nut with lead seal

Bold letters =
Short-term availability

8

Dimensions

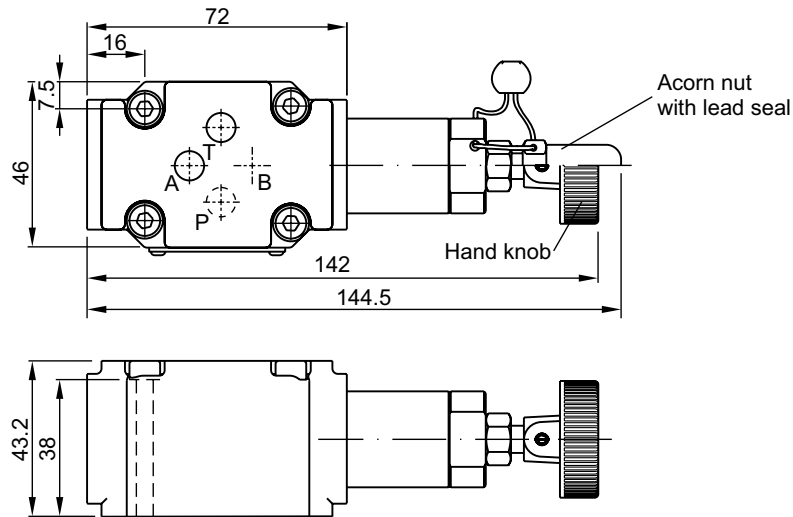

Pilot valve with proportional relief function RPDM2*, sandwich mounting NG06. MTTF_D value 150 years, flow rate maximum 5 l/min.

*For technical details see series RE06M*W.

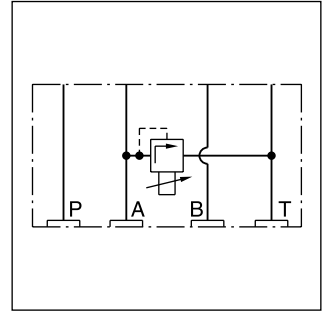

RPDM2AT

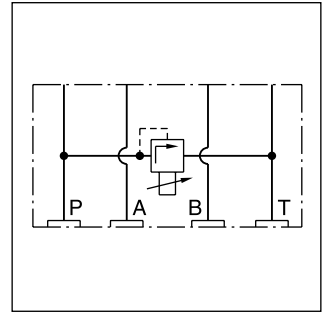

RPDM2PT

Ordering code

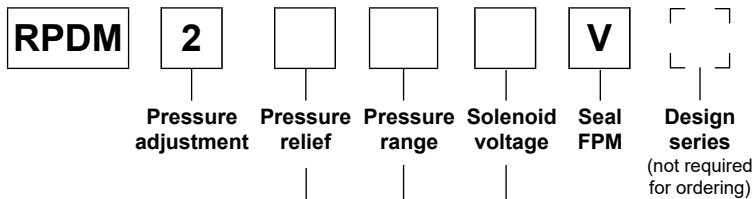

Code	Adjustment
AT	A to T
PT	P to T

Code	Solenoid voltage
K	12 V, 2.5 A
X	16 V, 1.3 A

Code	Pressure range [bar]
10	105
17	175
25	250
35	350

Bold letters = Short-term availability

Dimensions

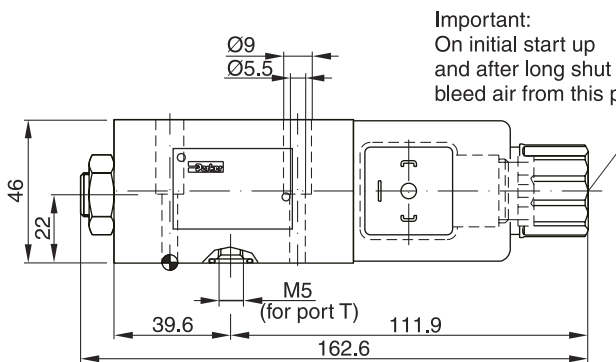

Important:
 On initial start up
 and after long shut down periods
 bleed air from this plug

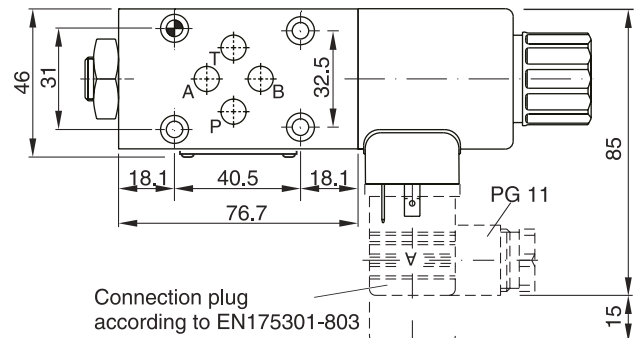

Connection plug according to EN175301-803

Sandwich valve with pressure relief function ZUDB, sandwich plate mounting NG06, see combination examples. MTTF_D value 150 years, flow rate maximum 5 l/min.

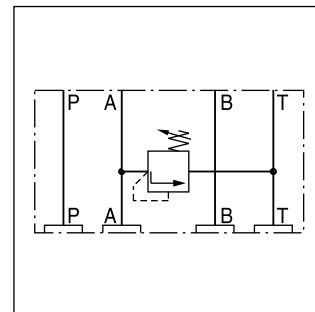

ZUDB1AT*

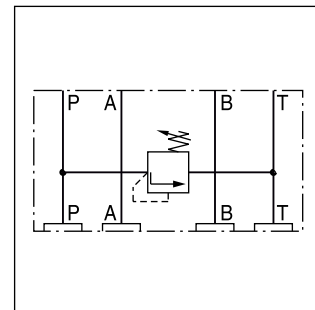

ZUDB1PT*

Ordering code

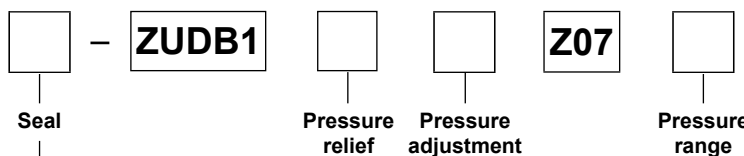

Code	Seal
omit	NBR
V	FPM

Code	Pressure relief
AT	A to T
PT	P to T

Code	Pressure range [bar]
B	70
E	175
G	250
K	350

Code	Adjustment
2	Hexagon screw with lock nut
61	Cylinder lock

**Bold letters =
Short-term availability**

Dimensions

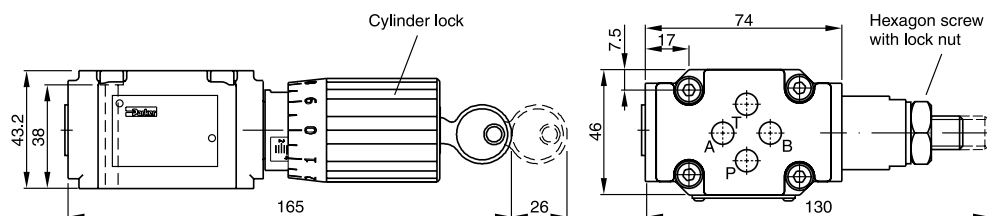

Pilot valve with preload function DSB*P*, subplate mounting NG06, see combination examples.
 MTTF_D value 150 years, flow rate maximum 5 l/min.

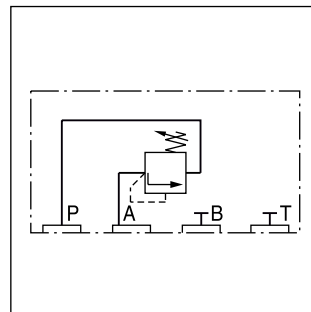
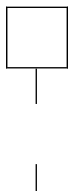

Ordering code

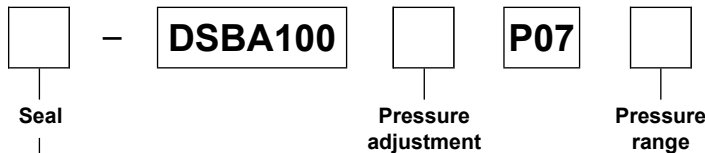

Code	Seal
omit	NBR
V	FPM

Code	Adjustment
2	Hexagon screw with lock nut
61	Cylinder lock

Code	Pressure range [bar]
B	70
E	175
G	250
K	350

8

**Bold letters =
 Short-term availability**

Dimensions

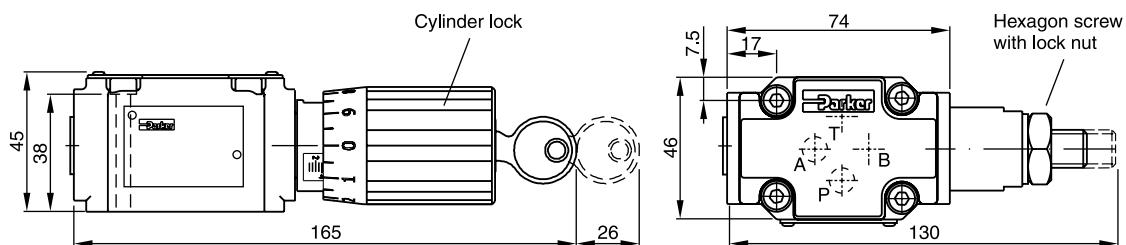

Pilot valve with preload function DSB*Z*, sandwich plate mounting NG06, see combination examples. MTTF_D value 150 years, flow rate maximum 5 l/min.

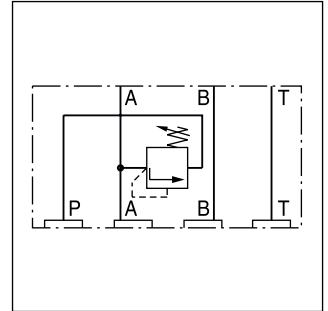

Ordering code

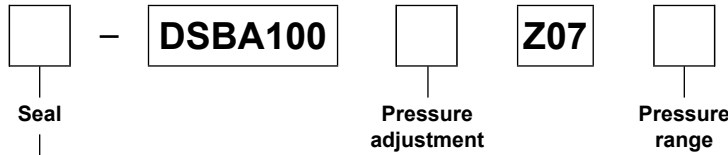

Code	Seal
omit	NBR
V	FPM

Code	Adjustment
2	Hexagon screw with lock nut
61	Cylinder lock

Code	Pressure range [bar]
B	70
E	175
G	250
K	350

Bold letters =
Short-term availability

8

Dimensions

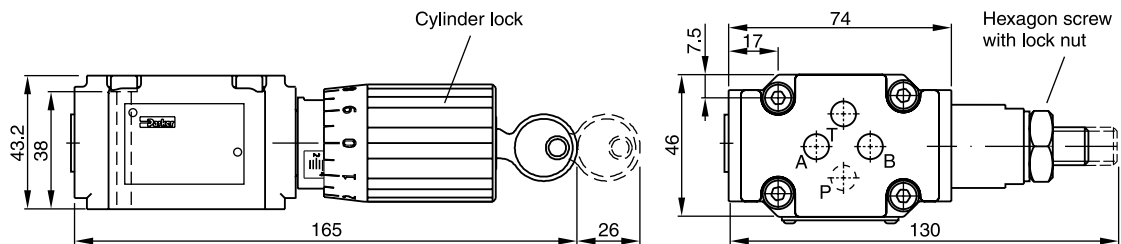

Pilot valve with unloading function UR06M, subplate mounting NG06, see combination examples. MTTF_D value 150 years, flow rate maximum 5 l/min.

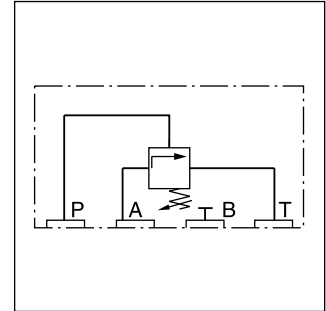

Ordering code

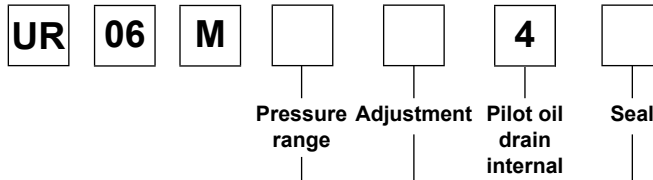

Code	Pressure range [bar]
07	70
17	175
25	250
35	350

Code	Seal
N	NBR
V	FPM

Code	Adjustment
S	Hand knob (standard)
A	Acorn nut with lead seal

8

**Bold letters =
 Short-term availability**

Dimensions

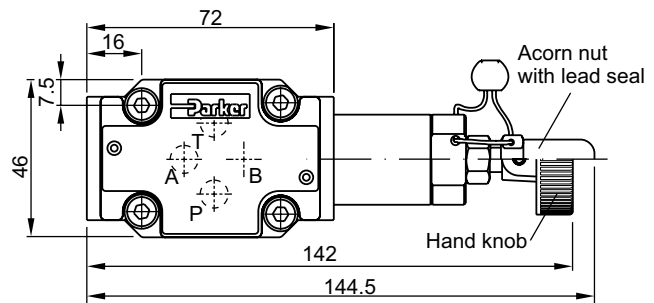
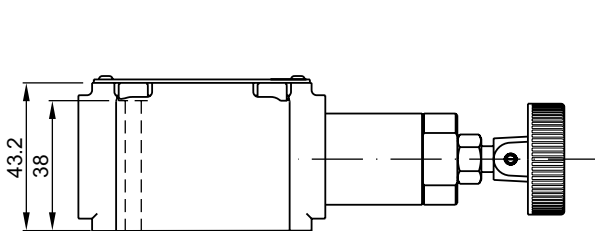

Pilot Valves

Pilot valve with unloading function US06M, sandwich plate NG06, see combination examples. MTTF_D value 150 years, flow rate maximum 5 l/min.

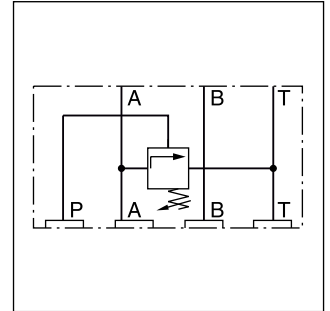

Ordering code

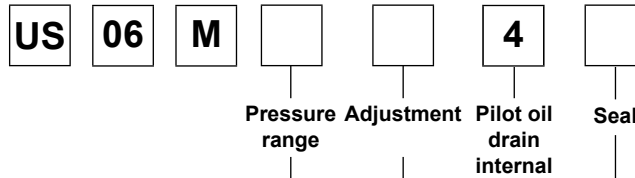

Code	Pressure range [bar]
07	70
17	175
25	250
35	350

Code	Seal
N	NBR
V	FPM

Code	Adjustment
S	Hand knob (standard)
A	Acorn nut with lead seal

Bold letters =
Short-term availability

8

Dimensions

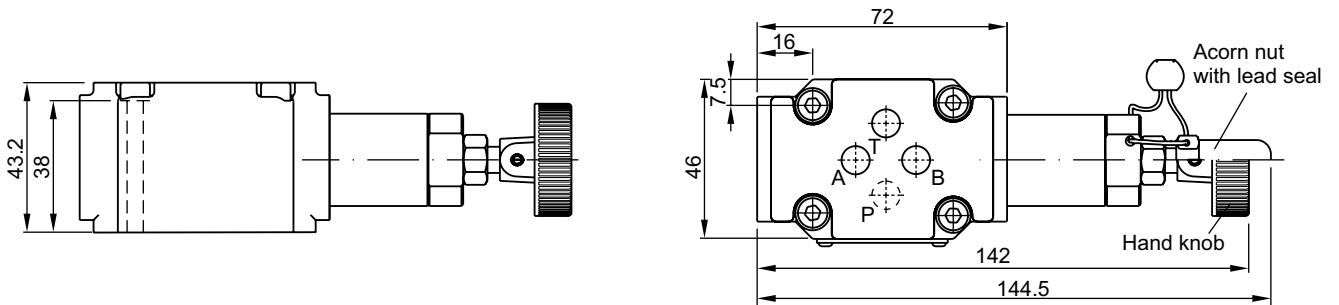

Pilot valve for pressure sequence function S06M,
 subplate mounting NG06, see combination examples.
 MTTF_D value 150 years, flow rate maximum 5 l/min.

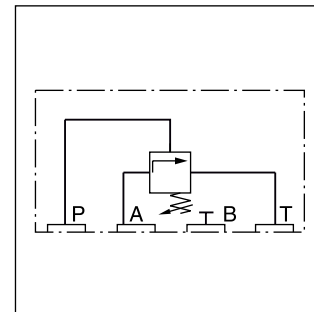

Ordering code

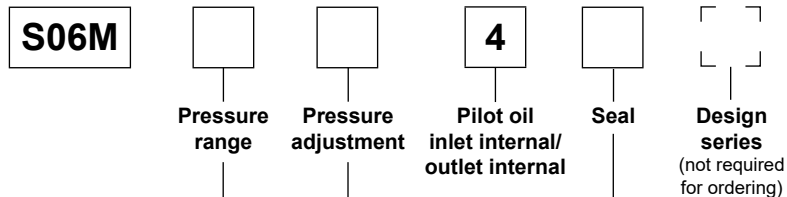

Code	Pressure range [bar]
07	70
17	175
25	250
35	350

Code	Seal
N	NBR
V	FPM

Code	Adjustment
S	Hand knob (standard)
A	Acorn nut with lead seal

8

Bold letters =
 Short-term availability

Dimensions

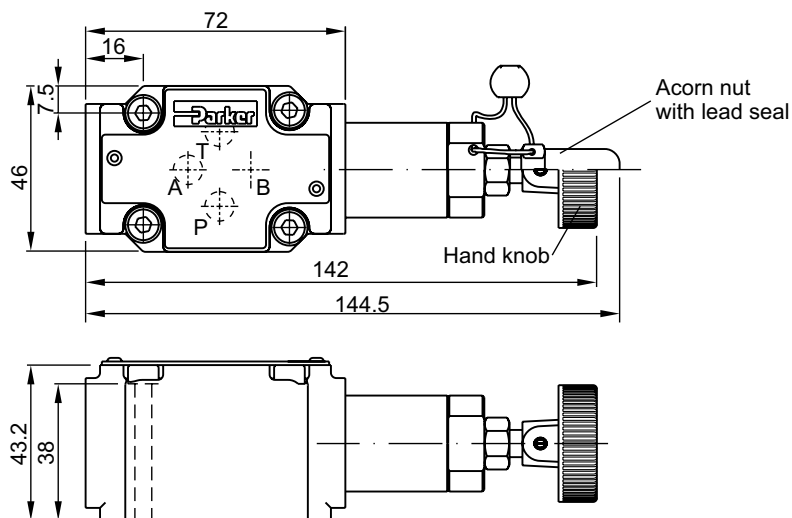

Pilot Valves

2-Way Slip-In Cartridge Valves Accessories

Check valve, hydraulically pilot operated NG06
with pilot control, for subplate mounting.
MTTF_D value 75 years, flow rate maximum 5 l/min.

Dimensions

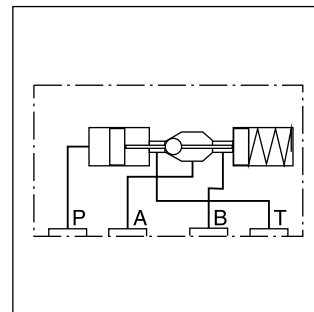
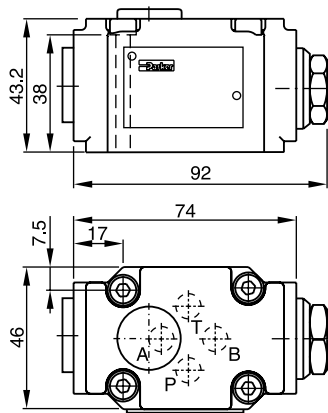

Ordering code

SVLA1006P07

Shuttle valve - sandwich plate mounting NG06
MTTF_D value 150 years, flow rate maximum 5 l/min.

Dimensions

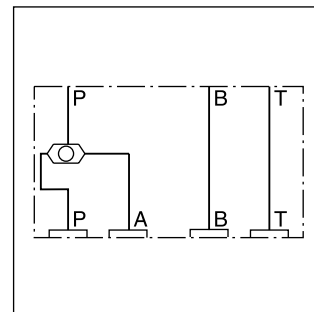
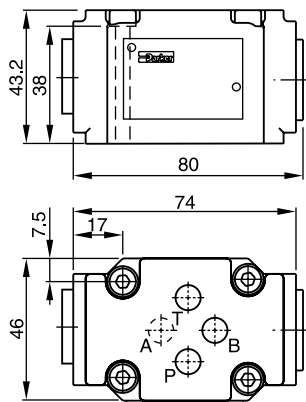

Ordering code

ZSRA1PP0Z07

Shuttle valve - sandwich plate mounting NG06
MTTF_D value 150 years, flow rate maximum 5 l/min.

Dimensions

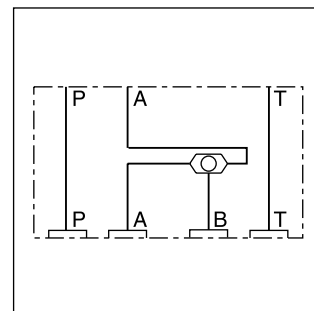
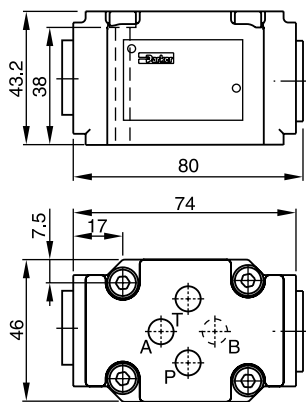

Ordering code

ZSRB1AA0Z07

Symbol	Type	Size	Hight
	PADA 1007-AA-BB	NG10-NG06	25
	PADA 1007/A-B/B-A	NG10-NG06	25
	H06-1044	NG06	30
	H06-1039	NG06	30
	H06-504	NG06	30
	H06-711	NG06	30
	H06-1274	NG06	30
	H06-1040	NG06	30

Attention: Details for cover-, sandwich- and adaptor plates see chapter 12.

**Bold letters =
 Short-term availability**

8

Symbol	Type	Size	Hight
	H06DO-1291	NG06	10
	H06DU-814	NG06	71.3
<p>All ports can be equipped with orifices or plugs (1/16NPT)</p>	CS06040N	NG06	40.3
<p>All ports can be equipped with orifices or plugs (1/16NPT)</p>	CS06082N	NG06	40.3
<p>All ports can be equipped with orifices or plugs (1/16NPT)</p>	CS06080N	NG06	40.3
	D51DC071D	NG06	26.3
	D51VP071C D51VP101D	NG06 NG10	26.3 26.9

Attention:

Details for cover-, sandwich- and adaptor plates see chapter 12.

**Bold letters =
Short-term availability**

Poppets, sleeves, spacer rings

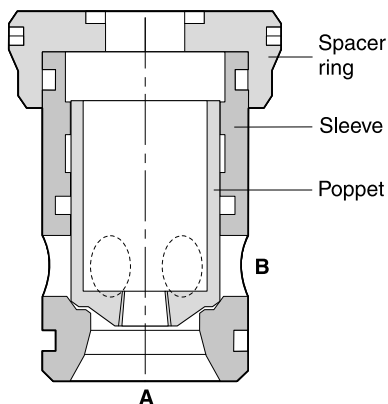

Size	16	25	32	40	50	63	80	100
Poppet 01	RK-45036369	RK-45036379	RK-45036392	RK-45036409	RK-45036421	RK-45036437	RK-35036449	RK-35036467
Poppet 04	RK-45036370	RK-45036380	RK-45036395	RK-45036406	RK-45036422	RK-45036436	RK-35036460	RK-35036468
Poppet 07	RK-35037531	RK-45036964	RK-45036965	RK-45036966	RK-45036967	RK-45036968	—	—
Poppet 08	RK-45036368	RK-45036381	RK-45036391	RK-45036408	RK-45036424	RK-45036438	RK-35036459	RK-35036469
CE-sleeve	RK-35038871	RK-35038872	RK-35038873	RK-35036403	RK-35036417	RK-25036432	RK-25036452	RK-25036470
CP-sleeve	RK-35039384	RK-35039385	RK-35039386	RK-35039387	RK-35039388	RK-35039389	—	—
Spacer ring	RK-35036364	RK-35036375	RK-45036393	RK-35036402	RK-35036416	RK-35036435	RK-25036453	RK-25036471

8

Springs, seals, fitting bolts

Size	16	25	32	40	50	63	80	100
Spring ¹⁾								
Type L; 0.1 bar	FK-CE016-L	FK-CE025-L	FK-CE032-L	FK-CE040-L	FK-CE050-L	FK-CE063-L	FK-CE080-L	FK-CE100-L
Type N; 0.5 bar	FK-CE016-N	FK-CE025-N	FK-CE032-N	FK-CE040-N	FK-CE050-N	FK-CE063-N	FK-CE080-N	FK-CE100-N
Type S; 1.6 bar	FK-CE016-S	FK-CE025-S	FK-CE032-S	FK-CE040-S	FK-CE050-S	FK-CE063-S	FK-CE080-S	FK-CE100-S
Type T; 2.5 bar	FK-CE016-T	FK-CE025-T	FK-CE032-T	FK-CE040-T	FK-CE050-T	FK-CE063-T	FK-CE080-T	FK-CE100-T
Type U; 4.0 bar	FK-CE016-U	FK-CE025-U	FK-CE032-U	FK-CE040-U	FK-CE050-U	FK-CE063-U	FK-CE080-U	FK-CE100-U
Seal kits								
FPM	SK-CBE160V	SK-CBE250V	SK-CBE320V	SK-CBE400V	SK-CBE500V	SK-CBE630V	SK-CBE800V	SK-CBE1000V
NBR	SK-CBE160	SK-CBE250	SK-CBE320	SK-CBE400	SK-CBE500	SK-CBE630	SK-CBE800	SK-CBE1000
Bolt kits								
(ISO 4762-12.9)	BK414 4x M8x40	BK391 4x M12x50	BK415 4x M16x55	BK416 4x M20x70	BK417 4x M20x75	BK418 4x M30x100	BK419 8x M24x120	BK509 8x M30x130
Recommended torque [Nm]	31.8	108	264	517	517	1775	890	1775

Ordering code example:

FK-CE016-U > 10 pcs., spring for NG16, type U

¹⁾ 1 spring kit contains 10 springs.

Diagram to choose the orifice Ø

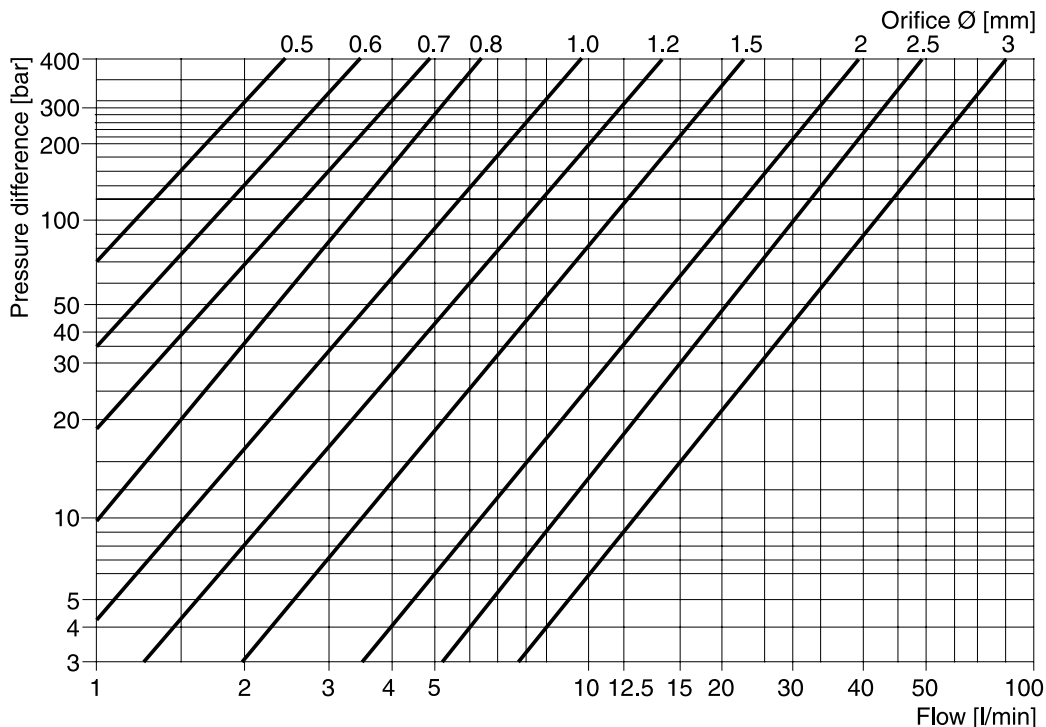

Values measured at a viscosity of 40 cST and a temperature of 50 °C.

Orifices

There are different orifices available to realize different opening / closing velocities.

The control volume of each nominal valve size can be found at the CE series.



Orifice kits, sorted by thread with different diameters

Orifice kit	Orifice kit, sorted by thread with different diameters, consisting of 2 pieces of each marked diameter												
Ø	0.0	0.8	0.9	1.0	1.1	1.2	1.3	1.5	1.8	2.0	2.2	2.5	3.0
DK-M4	•	•	•	•	•	•	•	•	–	•	–	–	–
DK-M5	•	•	•	•	•	•	•	•	–	•	–	–	–
DK-M6	•	•	•	•	•	•	•	•	–	•	–	–	–
DK-M8	•	–	–	•	–	•	–	•	•	•	•	•	–
DK-M10x1	•	–	–	•	–	•	–	•	•	•	–	•	•
DK-1/16NPT	•	•	•	•	•	•	•	•	–	•	–	–	–
DK-1/8NPT	•	–	–	•	–	•	–	•	•	•	–	•	•

Orifice kits, thread with one defined diameter 20 pcs per box

Orifice kits of one size:

Ordering Code Examples

DK-M4-08 > 20 pcs, orifice size 0.8 mm

DK-M5-10 > 20 pcs, orifice size 1.0 mm

DK-M8-12 > 20 pcs, orifice size 1.2 mm

Orifice gauge: Order no. DK-05-30