

**Characteristics / Ordering Code**

Manatrol 2-way flow control valves for pressure compensated regulation of the flow. As a consequence of pressure changes, the set value can vary by  $\pm 5\%$  within the tolerance range. Changes in viscosity and in temperature have the same effect and are to be observed.

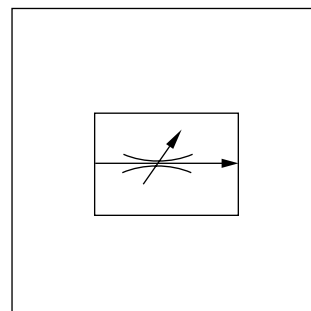

**Characteristic values**

Size	Max. press. [bar]	Flow control		Weight [kg]
		Q <sup>1)</sup> [l/min]	$\Delta p$ [bar]	
400	210	1 - 10	7	0.77
600	210	2 - 25	7	1.23
800	210	6 - 60	11	2.50
1200	210	10 - 100	11	3.18
1600	210	19 - 190	11	7.41

**Ordering code**

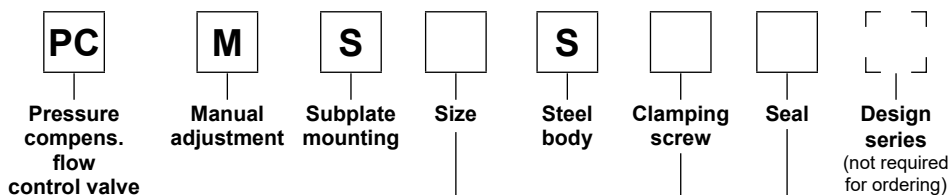

Code	Nominal size
400	400
<b>600</b>	<b>600</b>
<b>800</b>	<b>800</b>
1200	1200
1600	1600

Code	Seal
omit	<b>NBR</b>
V	FPM

Code	Clamping screw
omit	<b>Hexagon socket</b>
F	With knurled knob

**Bold letters = Short-term availability**

<sup>1)</sup> Min. and max. flow rate.

**Controlled flow vs. pressure drop**

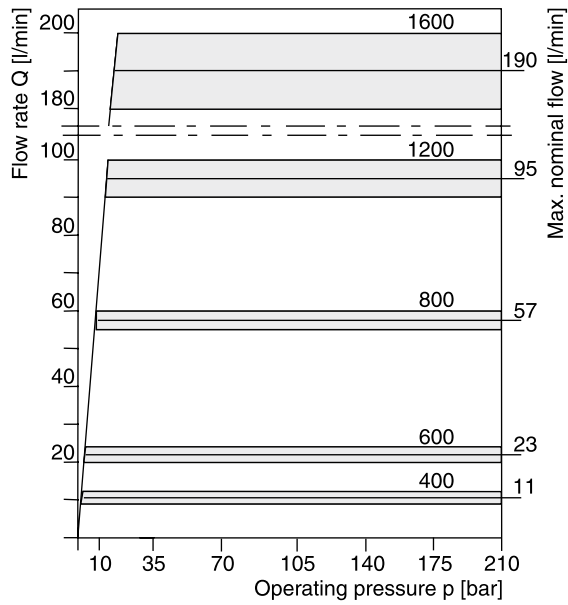

All characteristic curves measured with HLP46 at 50 °C.

**Reverse flow vs. pressure drop at minimum and maximum settings**

**Sizes 400, 600 and 1200**

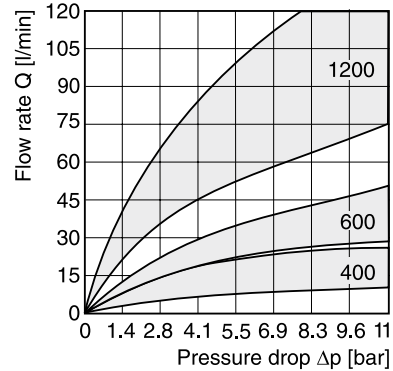

**Sizes 800 and 1600**

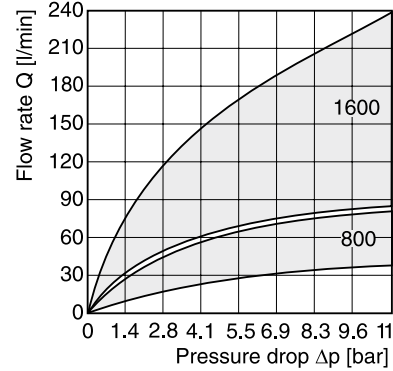

**Dimensions**

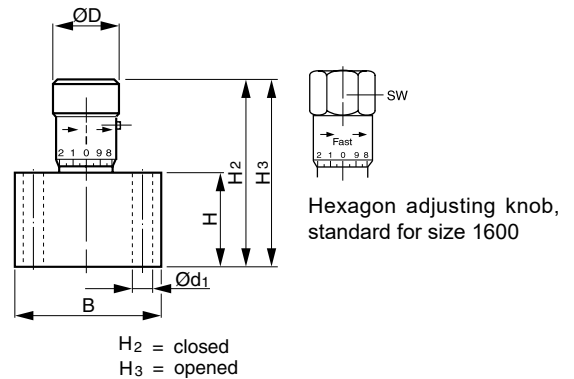
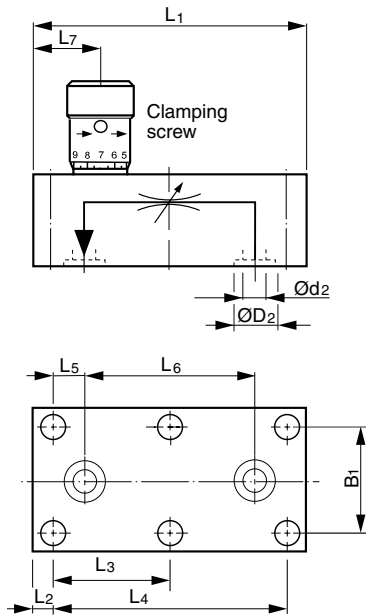

Size	L1	L2	L3	L4	L5	L6	L7	B	B1	H	H2	H3	Ød1	Ød2	ØD2	ØD	SW
400	85.9	6.4	–	72.8	9.3	54.2	21.3	44.5	33.3	28.4	57.7	62.7	6.8	7.1	13.3	20.6	–
600	101.6	6.4	–	88.9	10.4	68.0	25.4	50.8	38.1	31.8	67.8	73.4	7.0	8.6	16.0	25.4	–
800	117.3	6.4	–	104.9	12.7	79.5	44.5	57.2	44.4	44.5	95.0	102.6	7.0	11.9	19.1	30.0	–
1200	142.7	9.7	61.7	123.7	15.7	91.9	40.4	69.9	54.1	57.2	115.8	128.5	9.5	16.8	24.0	34.8	–
1600	171.5	12.7	73.2	146.1	19.1	107.9	49.3	76.2	60.4	69.9	158.2	175.3	9.5	22.4	32.0	–	47.5