

**Characteristics / Ordering Code**

The pressure relief valve series VS is a direct operated spool valve for subplate mounting. The connection and function is according to ISO 6264.

**Function**

- Spool type valve
- Subplate mounting according to ISO 6264
- 5 pressure stages
- 2 adjustment modes
- Gauge port

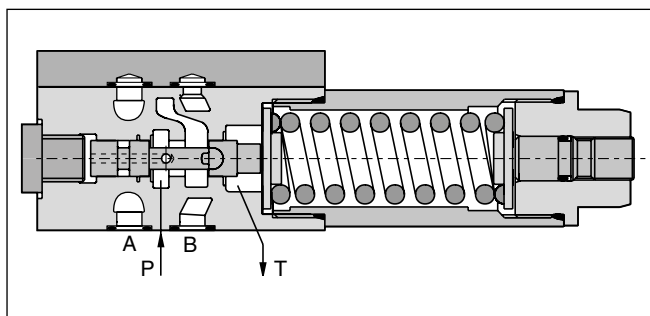
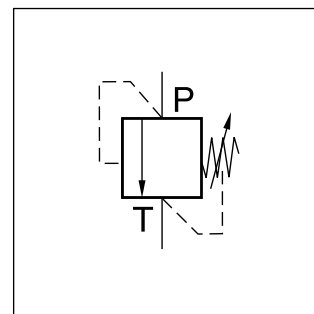

4

**Ordering code**

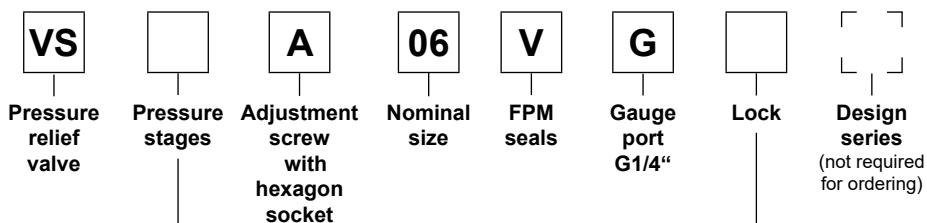

Code	Pressure stages
025	up to 25 bar
<b>064</b>	<b>up to 64 bar</b>
<b>160</b>	<b>up to 160 bar</b>
<b>210</b>	<b>up to 210 bar</b>
350	up to 350 bar

Code	Lock
<b>omit</b>	-
Z	Cylinder lock

**Bold letters = Short-term availability**

**Technical data**

General		
Design		Direct operated relief valve spool type
Nominal size		DIN NG06 / CETOP 03 / NFPA D03
Interface		Subplate mounting according to ISO 6264
Mounting position		unrestricted
Ambient temperature	[°C]	-20...+60
MTTF <sub>D</sub> value	[years]	150
Weight	[kg]	1.3
Hydraulic		
Max. operating pressure	[bar]	Port P 350, Port T depressurized
Pressure stages	[bar]	25, 64, 160, 210, 350
Nominal flow	[l/min]	25
Fluid		Hydraulic oil according to DIN 51524
Fluid temperature	[°C]	-20...+70
Viscosity permitted	[cSt] / [mm <sup>2</sup> /s]	20...400
Viscosity recommended	[cSt] / [mm <sup>2</sup> /s]	30...80
Filtration		ISO 4406; 18/16/13

**p/Q performance curves**

**Pressure stage 25 bar**

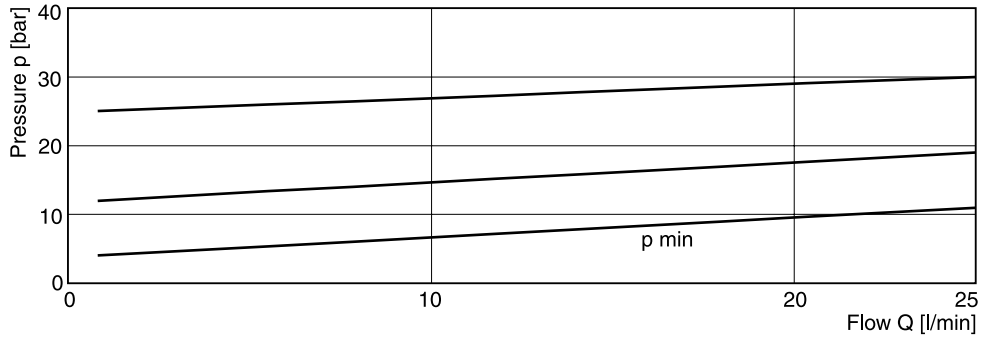

**Pressure stage 64 bar**

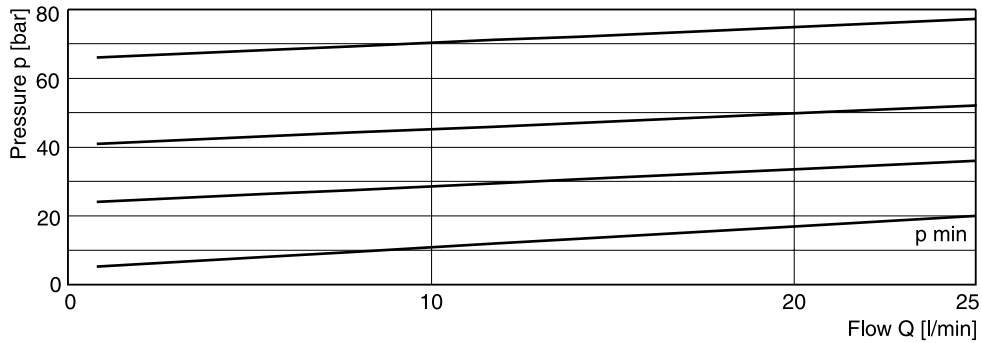



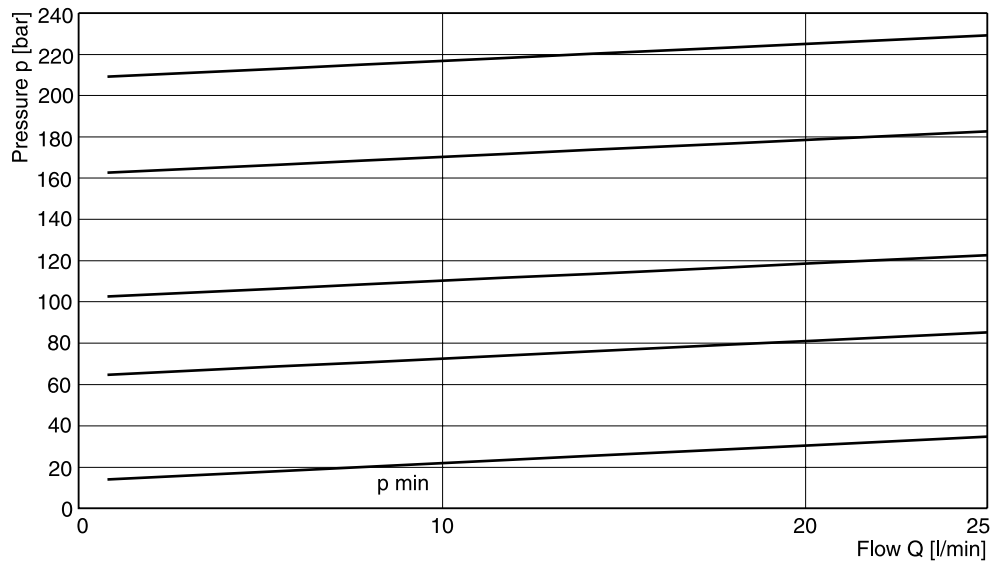

**Pressure stage 160, 210 and 350 bar**

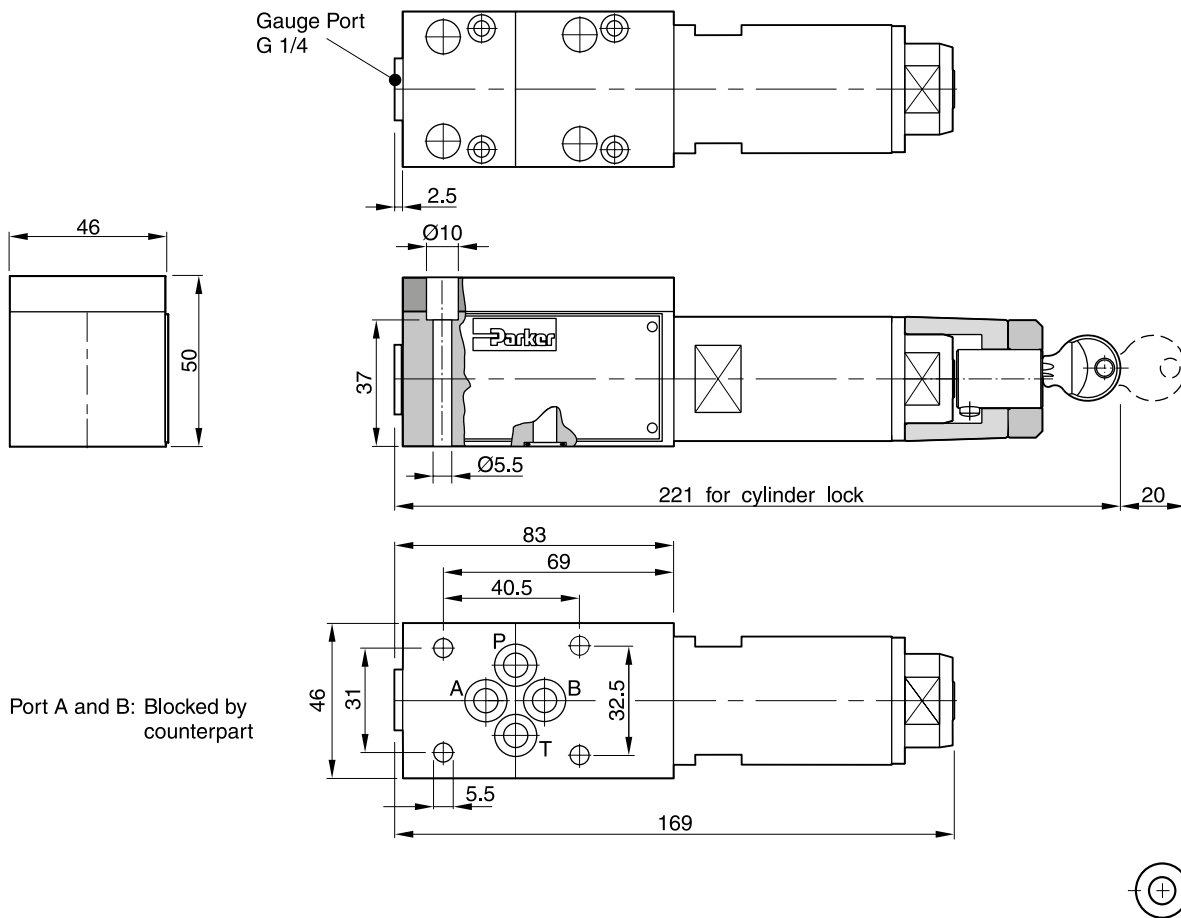

All characteristic curves measured with HLP46 at 50 °C.

**4**

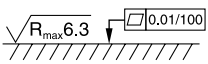

Surface finish	Bolt kit			 Kit FPM
	BK443	4x M5x45 ISO 4762-12.9	7.6 Nm ±15 %	SK-VB/VM/VS-A06V

**Mounting pattern ISO 6264, code 6264-03-04-\*-97**

