

# Installation IQAN-XS2

Publ.no: M5010017A  
Ed. A

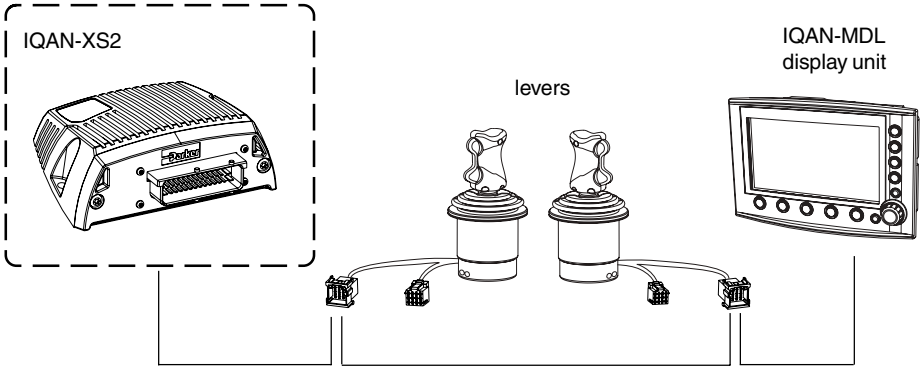

## CAN module addressing/terminating

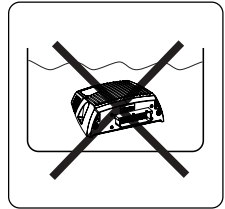
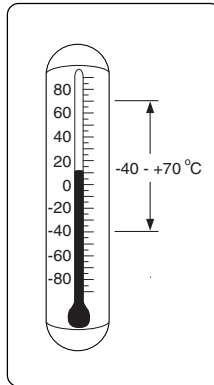
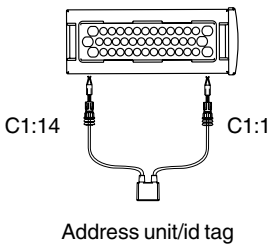

**CE**  
(89/336/EEC)

For further information see:  
HY17-8386-IB/UK Instructions IQAN-XS2



# Wiring diagram

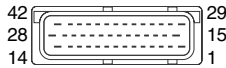
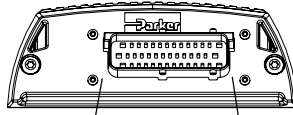

1	ADDR-H	15	-BAT	29	-VREF
2	DOUT-G	16	DIN-I	30	DIN-J
3	DOUT-H	17	DIN-K	31	DIN-L
4	DOUT-I	18	DIN-M	32	DIN-N
5	DOUT-J	19	DIN-O	33	DIN-P
6	DOUT-K	20	DIN-Q	34	DIN-R
7	DOUT-L	21	DIN-S	35	DIN-T
8	DOUT-A	22	DOUT-C	36	DOUT-E
9	DOUT-B	23	DOUT-D	37	DOUT-F
10	VIN-A/DIN-A	24	VIN-E/DIN-E	38	VIN-G/DIN-G
11	VIN-B/DIN-B	25	VIN-F/DIN-F	39	VIN-H/DIN-H
12	VIN-C/DIN-C	26	CAN2-H	40	CAN2-L
13	VIN-D/DIN-D	27	CAN-H	41	CAN-L
14	ADDR-L	28	+BAT(+12V, +24V)	42	+VREF

Mating connector kit: 5031 063

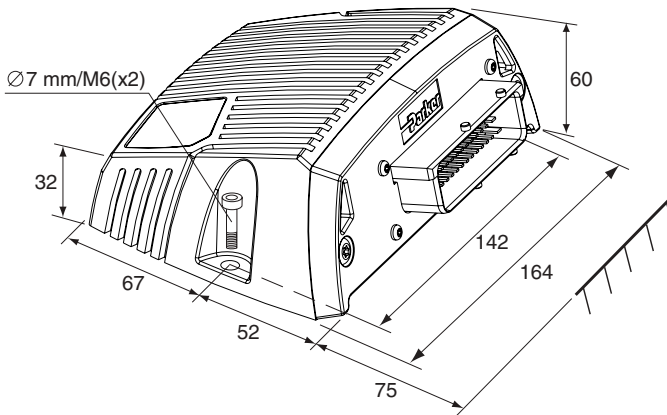

unit = mm