

# Installation IQAN-XA2

Publ.no: M5010033A  
Ed. A

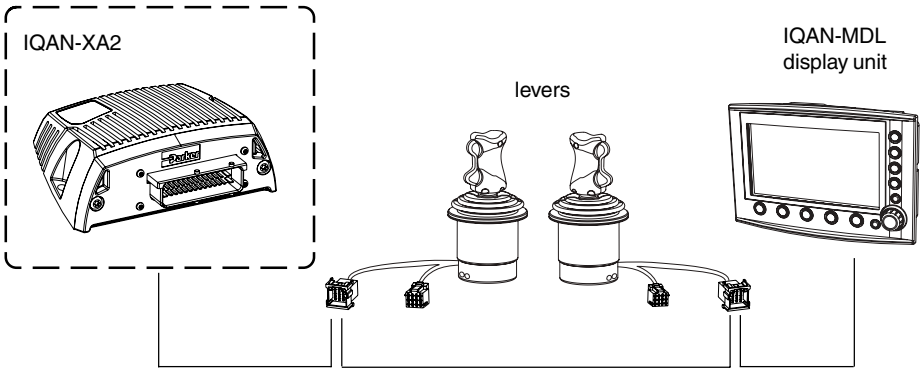

## CAN module addressing/terminating

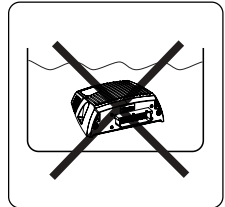
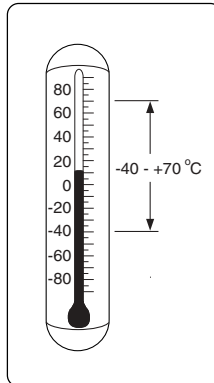
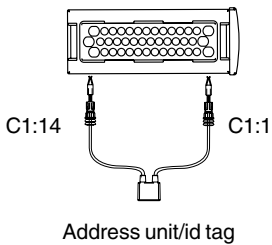

**CE**  
(89/336/EEC)

For further information see:  
HY17-8385-IB/UK Instructions IQAN-XA2



# Wiring diagram

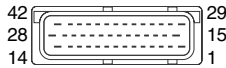
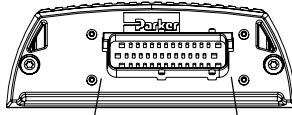

1	ADDR-H	15	-BAT	29	-VREF
2	COU-T-A/DOUT-G	16	CRET-A+/DIN-I	30	CRET-A-/DIN-J
3	COU-T-B/DOUT-H	17	CRET-B+/DIN-K	31	CRET-B-/DIN-L
4	COU-T-C/DOUT-I	18	CRET-C+/DIN-M	32	CRET-C-/DIN-N
5	COU-T-D/DOUT-J	19	CRET-D+/DIN-O	33	CRET-D-/DIN-P
6	COU-T-E/DOUT-K	20	CRET-E+/DIN-Q	34	CRET-E-/DIN-R
7	COU-T-F/DOUT-L	21	CRET-F+/DIN-S	35	CRET-F-/DIN-T
8	DOUT-A	22	DOUT-C	36	DOUT-E
9	DOUT-B	23	DOUT-D	37	DOUT-F
10	VIN-A/DIN-A	24	VIN-E/DIN-E/FIN-A DFIN-A+	38	VIN-G/DIN-G/FIN-B DFIN-B+
11	VIN-B/DIN-B	25	VIN-F/DIN-F/DFIN-A-	39	VIN-H/DIN-H/DFIN-B-
12	VIN-C/DIN-C	26	CAN2-H	40	CAN2-L
13	VIN-D/DIN-D	27	CAN-H	41	CAN-L
14	ADDR-L	28	+BAT(+12V, +24V)	42	+VREF

Mating connector kit: 5031 063

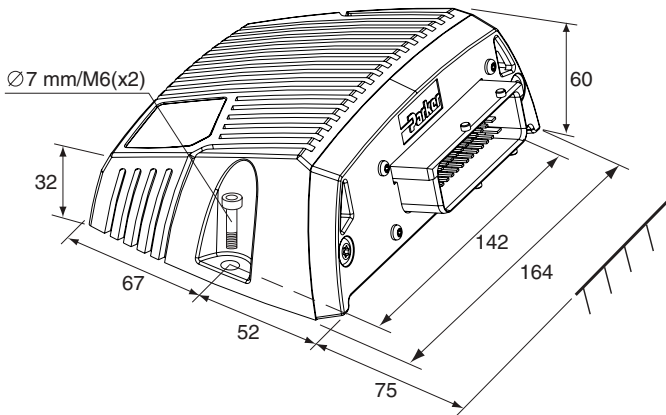

unit = mm