

Parflex Rapid Assembly Fitting System

Plug and Play with Quick Connect



ENGINEERING YOUR SUCCESS.

Parflex Rapid Assembly Fittings

Quick Connect Fittings For Thermoplastic Hose



This twinline 510D formed hose uses the 56 Series Rapid Assembly Fittings for sizes -4 and -6 that were developed for applications needing a quick connection.

The Parflex Rapid Assembly (RA) quick connect fittings offer plug and play convenience in a very compact, economical system. RA fittings, from Parker's Parflex division, consists of Parker 56 Series RA quick-connecting hose fittings, one adapter and any Parflex hose rated to 3,000 psi @ 212°F.

This system offers the advantages of reduced tools needed for equipment plumbing. Installation of the hose assembly does not require wrenches or routing orientation, thereby reducing plumbing time and improving productivity.

Since Parflex 56 RA fittings are not live swivels, care should be taken to insure that relative movement between the adapter and the hose fitting is eliminated. Sealing is achieved through the use of petroleum and synthetic hydraulic oil resistant elastomeric o-rings.

Challenge

Tight pilot line and joystick routings require significant installation time and can be a bottle neck in the assembly process. 100R1 rubber hose does not fit in the tight channels from the operator compartment to the valves. Several special tools are required to install the elbow adapter fittings at the build up stations and different sized wrenches are required on the assembly line.



Solution

Parflex 510D and 518D pilot lines, with Rapid Assembly fittings on the unit, eliminate elbow adapters at the build up station so all the adapters can be installed with nut runners. Routing hose becomes much easier because of the low profile hose O.D., very small minimum bend radius and low coefficient jacket. Connecting hose with the new fittings reduces installation time and eliminates the need for tools.

Rapid Assembly Fittings Create Savings

Money, Space & Freight

Parflex thermoplastic hoses, qualified with 56 Series Rapid Assembly Fittings feature a reduced O.D. and tighter bend radius that can transport the same flow capacity as hoses with larger outside diameters. Typically, Parflex 518D and 510D hose has at least an 1/8" smaller diameter than a standard 100R7 rubber hose. In addition, the Parflex hose is up to 5x lighter than comparable hoses.

Parflex thermoplastic hoses are exceptionally suited for routing through tight spaces while

maintaining flexibility. In fact, flexibility is one of the key features of these medium pressure hoses.

Compact hoses, (510D, 518D, 563TJ, 563LT), are often used in pilot lines or joy stick applications where multiple hoses are required to fit into a tight space. They can be formed during production to fit the specific application design.

Compact wire reinforced hoses, such as 563TJ/LT (100R17), can

also benefit from the use of a quick connect fitting in applications where multiple hoses are required to fit into a tight space. The smaller outside diameter of the hose and lower profile fittings contribute to space savings and reduced shipping costs. Not just the shipping costs from Parflex to you, but also from you to your customer.

One Fitting, One Adapter, One Hose

Product Features:

- Compact
- Light weight
- Quick connecting fittings
- No tools needed
- Improved assembly time
- Reduced system weight
- Easy routing
- Exceptional kink resistance
- Durable

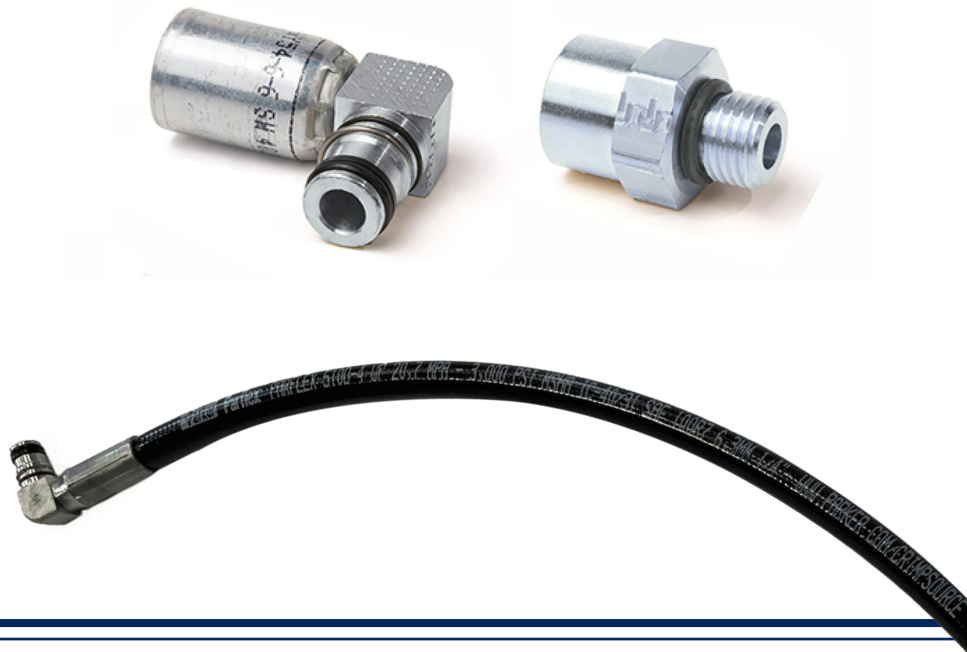

Watch the Video



Parflex Rapid Assembly Fittings

Hoses Available for the Plug and Play System

| PSI Thermoplastic Hose - SAE Working Pressures | | | | | | | | | | PSI Thermoplastic Hose Working Pressure | | | | | |
|--|-------------|-----|------|-----|------|-----|-----|-----|-----|---|-----------|------------------------|----------------|-------------------|--------------------------|
| | | 1/8 | 3/16 | 1/4 | 5/16 | 3/8 | 1/2 | 5/8 | 3/4 | 1 | | | | | |
| Dash Size | | -2 | -3 | -4 | -5 | -6 | -8 | -10 | -12 | -16 | Core Tube | Reinforcement Material | Cover Material | SAE Specification | Additional Specification |
| Hose | Description | psi | psi | psi | psi | psi | psi | psi | psi | psi | | | | | |

General Hydraulic

| | | | | | | | | | | | | | | | |
|-------|-----------------------------------|--|------|------|------|------|------|------|------|------|--------------|-------|-----|---------|---|
| 510D | General Hydraulic | | 3250 | 3000 | 2500 | 2250 | 2250 | 2250 | 1250 | 1000 | N H (-16) | Fiber | U | 100R7 | DNV, ISO 3949-R7-1 MSHA Compliant Cover |
| 560TJ | General Hydraulic TOUGHJACKET™ | | 3626 | 3263 | 3118 | 2750 | 2500 | 2000 | 1750 | | H | Wire | UTJ | 100R1AT | MSHA Compliant Cover |
| 563TJ | Constant Pressure TOUGHJACKET™ | | | 3045 | | 3045 | 3045 | 3045 | 3045 | 3045 | H | Wire | UTJ | 100R17 | MSHA Compliant Cover |

Non-Conductive

| | | | | | | | | | | | | | | | |
|------|-----------------------------|------|------|------|------|------|------|------|------|------|--------------|-------|---|-------|---|
| 518D | Non-conductive Hydraulic | 3000 | 3250 | 3000 | 2500 | 2250 | 2250 | 2250 | 1250 | 1000 | N H (-16) | Fiber | U | 100R7 | DNV, ISO 3949-R7-1 MSHA Compliant Cover |
|------|-----------------------------|------|------|------|------|------|------|------|------|------|--------------|-------|---|-------|---|

Low Temperature

| | | | | | | | | | | | | | | | |
|-------|---------------------------------|------|------|------|------|------|------|------|------|--|-------------|-------|---|--------|----------|
| 53DM | LT Hydraulic | 3045 | | 3045 | | 3045 | 3045 | 3045 | 3045 | | N (-2) H | Fiber | H | 100R18 | - |
| 538DM | LT Hydraulic, Non-Conductive | | | | | 3045 | | | | | H | Fiber | H | 100R18 | SAE J517 |
| 55LT | LT Hydraulic | 3000 | 3250 | 3000 | 2500 | 2250 | 2000 | | | | N | Fiber | H | 100R7 | - |
| 563LT | LT Constant Pressure | | | 3045 | | 3045 | 3045 | 3045 | 3045 | | H | Wire | U | 100R17 | - |

Hybrid

| | | | | | | | | | | | | | | | |
|-----|--------------------------------|--|--|------|------|------|------|--|--|--|---|------|---|--------|-------------------------|
| D6R | Constant Pressure Hydraulic | | | 3045 | 3045 | 3045 | 3045 | | | | H | Wire | R | 100R17 | MSHA Compliant Cover |
|-----|--------------------------------|--|--|------|------|------|------|--|--|--|---|------|---|--------|-------------------------|

Legend

F - Fiber

H - Copolyester

N - Nylon

U - Polyurethane

R - Smooth Synthetic Rubber

UTJ - TOUGHJACKET™ Polyurethane

Parflex Rapid Assembly Fittings

56 Series

1WU56 Male Rapid Assembly Straight

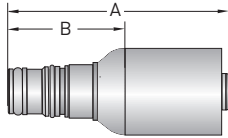

| Part Number | Stem O.D. | | Hose I.D. | | A | | Cutoff Allow. B | |
|-------------|-----------|----|-----------|----|------|----|-----------------|----|
| | inch | mm | inch | mm | inch | mm | inch | mm |
| 1WU56-4-4 | 1/4 | 6 | 1/4 | 6 | 2.18 | 55 | 1-1/8 | 29 |
| 1WU56-6-6 | 3/8 | 10 | 3/8 | 10 | 2.30 | 58 | 1-3/16 | 30 |

NOTE: Use with mating adapter PN 685RA.

Construction: Steel.
Nitrile O-ring.

1WW56 Male Rapid Assembly 45° Elbow

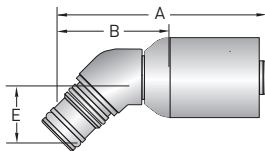

| Part Number | Stem O.D. | | Hose I.D. | | A | | Cutoff Allow. B | | E | |
|-------------|-----------|----|-----------|----|------|----|-----------------|----|------|----|
| | inch | mm | inch | mm | inch | mm | inch | mm | inch | mm |
| 1WW56-4-4 | 1/4 | 6 | 1/4 | 6 | 2.31 | 59 | 1-5/16 | 33 | 0.67 | 17 |
| 1WW56-6-6 | 3/8 | 10 | 3/8 | 10 | 2.35 | 60 | 1-3/8 | 35 | 0.67 | 17 |

NOTE: Use with mating adapter PN 685RA.

Construction: Steel.
Nitrile O-ring.

1WY56 Male Rapid Assembly 90° Elbow

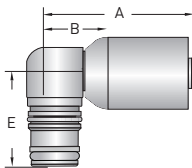

| Part Number | Stem O.D. | | Hose I.D. | | A | | Cutoff Allow. B | | E | |
|-------------|-----------|----|-----------|----|------|----|-----------------|----|------|----|
| | inch | mm | inch | mm | inch | mm | inch | mm | inch | mm |
| 1WY56-4-4 | 1/4 | 6 | 1/4 | 6 | 1.60 | 41 | 5/8 | 16 | 0.90 | 23 |
| 1WY56-6-6 | 3/8 | 10 | 3/8 | 10 | 1.66 | 42 | 5/8 | 16 | 1.01 | 26 |

NOTE: Use with mating adapter PN 685RA.

Construction: Steel.
Nitrile O-ring.

685RA Adapter Female Rapid Assembly - Male SAE Straight Thread ORB

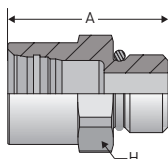







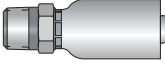
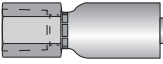
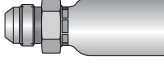
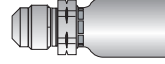
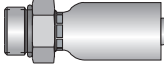
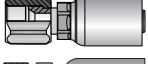

| Part Number | Stem O.D. | | Thread Size | A | | H Hex inch |
|-------------|-----------|----|-------------|------|----|------------|
| | inch | mm | | inch | mm | |
| 685RA-4-4 | 1/4 | 6 | 7/16-20 | 1.05 | 27 | 11/16 |
| 685RA-6-4 | 3/8 | 10 | 7/16-20 | 1.15 | 29 | 3/4 |
| 685RA-4-6 | 1/4 | 6 | 9/16-18 | 1.12 | 28 | 3/4 |
| 685RA-6-6 | 3/8 | 10 | 9/16-18 | 1.15 | 29 | 3/4 |

Construction: Steel.
Nitrile O-ring.

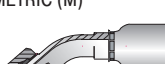
View standard 56 Series Fittings next page ►

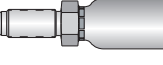
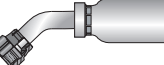
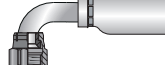
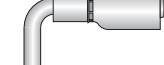
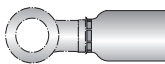
Parflex 56 Series Fittings

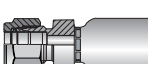
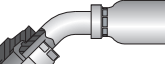
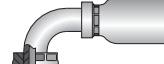
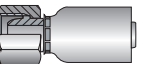
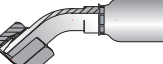
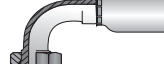
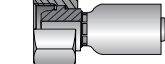
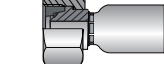
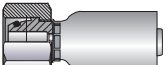
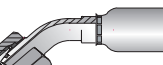
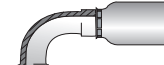
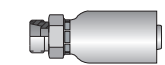
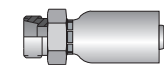
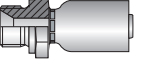
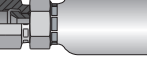
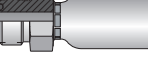
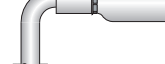
Permanent Crimp Fittings

| | | | | | | | | | | |
|------------------------|---|----------------------------|---|----------------------------------|---|------------------------------------|---|--|---|--|
| 56 Series Permanent | 101 | Male Taper Pipe Rigid | 102 | Female Taper Pipe Rigid | 103 | Male (JIC) 37° Rigid | 104 | Male SAE 45° Rigid | 105 | Male Str. Thread O-ring |
| |  | E-34 |  | E-34 |  | E-35 |  | E-35 |  | E-35 |
| | 106 | SAE (JIC) 37° Swivel | 107 | Female Pipe Swivel | 108 | Female SAE 45° Swivel | 10C | M FM Swivel 24° O-ring 45° Elb. Lt. | 11C | M FM Swivel 24° O-ring 90° Elb. Lt. |
| | *  | E-36 |  | E-36 |  | E-37 | METRIC (M)  | E-43 | METRIC (M)  | E-43 |
| | 113 | Male Pipe Swivel | 13E | Male (JIC) 37° Long | 137 | FM JIC 37° Swivel 45° Elbow | 139 | FM JIC 37° Swivel 90° Elbow | 141 | FM JIC 37° Swivel 90° Elbow-Lg |
| |  | E-37 |  | E-37 |  | E-38 |  | E-38 |  | E-39 |
| | 149 | Banjo Union | 192 | FM BSP Parallel Pipe Swivel Str. | 1AL | A-Lok® Compression | 1B1 | FM BSP Pipe Swivel 45° Elb. (60° Cone) | 1B2 | FM BSP Pipe Swivel 90° Elb. (60° Cone) |
| |  | E-39 | METRIC (M)  | E-43 |  | E-44 |  | E-44 |  | E-44 |
| | 1C3 | M FM Swivel Nut Light | 1C4 | M FM Swivel 45° Elbow Lt. | 1C5 | M FM Swivel 90° Elbow Lt. | 1C6 | M FM Swivel DIN 20078 HW w/o O-ring | 1C9 | M FM Swivel DIN 20078 HW O-ring |
| | METRIC (M)  | E-45 | METRIC (M)  | E-45 | METRIC (M)  | E-45 | METRIC (M)  | E-46 | METRIC (M)  | E-46 |
| | 1CA | M FM Swivel 24° Lt. O-ring | 1CE | M FM Swivel 24° O-ring 45° Elb. | 1CF | M FM Swivel 24° O-ring 90° Elb. | 1D0 | M Male Stud DIN 20078 Lt. | 1D2 | M Male Stud 24° Heavy |
| | METRIC (M)  | E-47 | METRIC (M)  | E-47 | METRIC (M)  | E-48 | METRIC (M)  | E-49 | METRIC (M)  | E-49 |
| | 1D9 | Male BSP - Str. (60° Cone) | 1FU | JIS/BSP 30° Flare Swivel Female | 1J0 | Male Seal-Lok™ Rigid Str. w/O-ring | 1J1 | Female Seal-Lok™ 90° Elbow Long | 1J2 | Female Seal-Lok™ 30° Elbow |
| |  | E-49 |  | E-48 |  | E-40 |  | E-40 |  | E-41 |

* **ToughShield™ Plus** ToughShield Plus, featuring Parker's Zinc Nickel Plating Standard, protects against corrosion, improving the performance of crimp hose fittings in harsh hydraulic environments, reducing both downtime and warranty costs.

Parflex 56 Series Fittings

Permanent Crimp Fittings

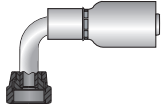
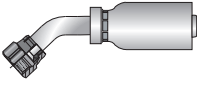
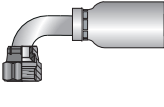
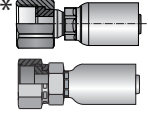
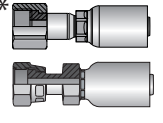
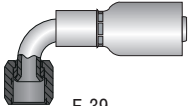
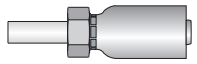
| | | | | | | | | | | |
|------------------------|---|---------------------------------------|---|-----------------------------------|--|---------------------------------------|---|------------------------------------|---|---------------------------|
| 56 Series Permanent | 1J5 | Female Seal-Lok™ Swivel 90° Elb. Med. | 1J7 | Female Seal-Lok™ Swivel 45° Elbow | 1J9 | Female Seal-Lok™ Swivel 90° Elb Short | 1JC | Female Seal-Lok™ Str. Swivel Short | 1JS | Female Seal-Lok™ Straight |
| |  | E-41 |  | E-42 |  | E-42 |  | E-40 |  | E-41 |
| | 1L9 | Female JIC 37° Swivel 90° Elb. Med. | 1TU | Universal Inch Tube Stub End | <p>* ToughShield™ Plus</p> <p>ToughShield Plus, featuring Parker's Zinc Nickel Plating Standard, protects against corrosion, improving the performance of crimp hose fittings in harsh hydraulic environments, reducing both downtime and warranty costs.</p> | | | | | |
| |  | E-39 |  | E-42 | | | | | | |

Permanent Rapid Assembly Fittings

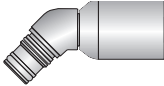
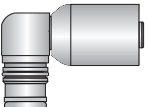
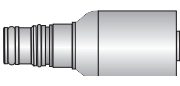
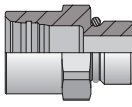
| | | | | | | | | |
|---|--|-------------------------------|--|-------------------------------|--|-------------------------------|--|-------------------------------------|
| 56 Series Permanent RAPID ASSEMBLY | 1WW | Male Rapid Assembly, 45° Elb. | 1WY | Male Rapid Assembly, 90° Elb. | 1WU | Male Rapid Assembly, Straight | 685RA | Female Rapid Assy. Adapter Male SAE |
| |  | E-50 |  | E-50 |  | E-50 |  | E-50 |



Parker Hannifin Corporation
Parflex Division
1300 North Freedom St.
Ravenna, OH 44266
phone (330) 296 2871
fax (330) 296 8433
www.parker.com/parflex

ENGINEERING YOUR SUCCESS.