

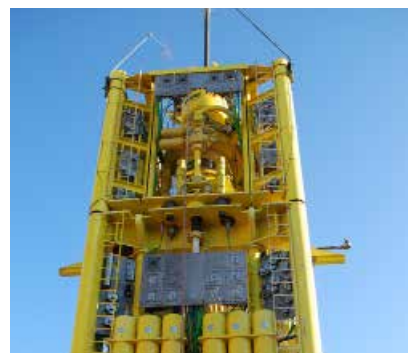

CAT 4900

Parflex Ultra High Pressure Thermoplastic
Hose, Fittings and Accessories 2022

Updated September 10, 2024



ENGINEERING YOUR SUCCESS.

Extra care is taken in the preparation of this literature but Parker is not responsible for any inadvertent typographical errors or omissions. Information subject to change without notice. The information in this catalog is only accurate as of the date of publication. For a more current information base, please consult the Parflex® Division web site at www.parker.com/pfd.



**FAILURE OR IMPROPER SELECTION OR IMPROPER USE OF THE PRODUCTS AND/OR SYSTEMS
DESCRIBED HEREIN OR RELATED ITEMS CAN CAUSE DEATH, PERSONAL INJURY AND PROPERTY DAMAGE.**

This document and other information from Parker Hannifin Corporation, its subsidiaries and authorized distributors provide product and/or system options for further investigation by users having technical expertise. It is important that you analyze all aspects of your application and review the information concerning the product or system in the current product catalog. Due to the variety of operating conditions and applications for these products or systems, the user, through its own analysis and testing, is solely responsible for making the final selection of the products and systems and assuring that all performance, safety and warning requirements of the application are met. The products described herein, including without limitation, product features, specifications, designs, availability and pricing, are subject to change by Parker Hannifin Corporation and its subsidiaries at any time without notice.

Offer of Sale

The items described in this document are hereby offered for sale by Parker Hannifin Corporation, its subsidiaries or its authorized distributors. This offer and its acceptance are governed by the provisions stated in the “Offer of Sale”.

©2023 Parker Hannifin Corporation, All Rights Reserved

Parflex Division

Around the World

As part of the Parker Fluid Connectors Group, the Parflex Division is responsible for the design and manufacture of hoses and tubing to handle extreme applications. Products include thermoplastic and ultra high pressure thermoplastic hoses, fluoropolymer hose, tubing and specialty hose and tubing products.

The Parflex Division is headquartered in Ravenna, Ohio, and the ultra high pressure hose unit is located in Stafford Texas. Parflex works closely with the Polyflex division, headquartered in Hüttenfeld, Germany. Polyflex manufactures many of the hoses in this catalog and they are used in a variety of different markets such as standard hydraulics, ultra high pressure applications, and oil & gas applications.



Ravenna, OH



Stafford, TX



Hüttenfeld

Other Catalogs with Thermoplastic Hoses

- USA



Catalog 4660 - US

- Europe

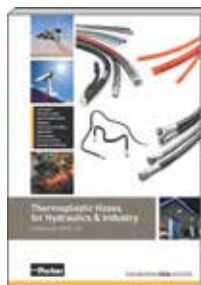

Catalog 4460-UK



Catalog 4462-UK



Catalog 4466-UK

Catalog Intro

Table Of Contents

How To Use The Catalog.....	3
Why Use Thermoplastic Hose.....	6
Division Overview	1

Hose & Fittings	A-01
Waterblast	A-13
Hydraulic	A-57
Oil & Gas	A-75
Adapters.....	B-01
Couplings	C-01
Accessories	D-01

Safety Guide	E-03
Offer of Sale	E-07
Index	E-09

How To Use The Catalog

Parflex UHP Hose

Overall structure of the Catalog:



For technical information please refer to the overview pages at the beginning of the individual chapters and sub-chapters



Highlighted tab shows the current chapter

Sub-chapters of product group

Hose data is colored blue

Fitting data is colored gray

Accessories data is colored orange

Why Use Thermoplastic Hose?

Features and Benefits

Abrasion

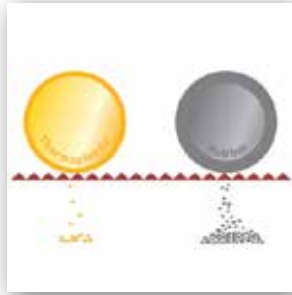

- Outer covers to withstand extreme wear
- Superior cut resistance and extended service life
- TOUGHJACKET covers offer 650x the resistance of standard rubber



Compact O.D.



- Space saving due to very small diameters
- More hoses can be installed in the same situation
- Quicker routing through tight spaces



Small I.D.



- Only thermoplastic materials allow small I.D.s down to below 2mm
- Space saving
- Technical solutions otherwise often not possible



Low Weight



- Major weight savings
- Energy savings as less mass needs to be moved
- Reduced operator fatigue from handling hoses



Why Use Thermoplastic Hose?

Features and Benefits

Customization/Prefforming



- Multiple colors
- Bundles
- Customer specific designs
- Preformed hoses maintain their full performance
- Formed hoses combine the advantages of bent metal pipe with the flexibility of hose
- Reduced weight, noise and vibration compared to bent metal pipe and rubber



Cleanliness



- Highly limited gas egression
- Reduced ingress ion reduces risk of media contamination



Permeation Resistance

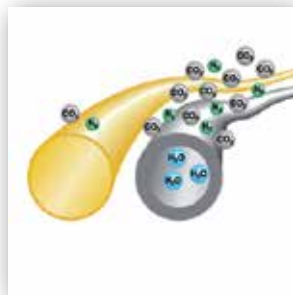

- Low gas permeation
- Reduced ingress ion reduces risk of media contamination

	CO ₂	H ₂ O Ingression	N ₂
Thermoplastic	1		0.07
Rubber	10	3.6	0.35



Customization



- Multiple colors
- Multiple lines
- Bundles
- Customer specific designs

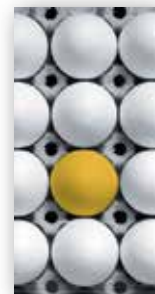

Why Use Thermoplastic Hose?

Features and Benefits

Long Lengths



- Continuous lengths up to 10,000+ feet
- Less joints & fittings reduces potential leak points and weight
- Easy winching and handling offer fast deployment of long length

Thermoplastic		3200m
Rubber	≤	60m



Highest Pressure



- Up to 4,000 bar working pressure
- Highest technical standards and production controls assure safety

Thermoplastic		4000m
Rubber		500 bar



Fast Response



- Fast response times over long lengths
- Faster valve actuation
- Reduced volumetric expansion



Wide Range of General Applications



- Standard hydraulics
- Mini hydraulics
- Industrial hydraulics
- Mobile hydraulics
- Chemical industry
- Process engineering
- Industrial gases
- Alternative fuels
- Automotive and truck industry
- Boats and yachts
- Pneumatics
- Wind power
- Life Science
- Media Transfer versus Hydraulics

Value Added Services

Parker Parflex offers value added services that compliment our production capabilities and product portfolio. These services are in place to meet the increasing customization and system criteria that our customers expect from a world-class supplier. The value added services and secondary services detailed below are typical of the products that we provide to our customers. If you have additional service needs that we have not detailed below, please contact us. We are happy to discuss all potential solutions for your requirements.

ParkerStore™



At Parker Hannifin, we're continually looking for ways to deliver more products, more efficiently. The Global ParkerStore™ network enables Parker to provide:

- Prompt, efficient, professional in-store services while you wait
- Expert local services and support
- A safe, friendly and convenient shopping environment
- A greater range of parts options so you get exactly what you're looking for

Customers trust ParkerStores to provide OEM and MRO customers with direct access to:

- Custom-made hydraulic hose assemblies and complementary products support customer applications to decrease downtime
- Expert technical support
- Professional, personalized services, including 24/7/365 support
- The convenience, comfort and amenities of a local service provider

Parker is committed to delivering customer service options to help you work smarter, faster, and better.

Need the latest? Go online. From complete product information on hose, to 3D-CAD models of our complete fitting line, you'll find everything you need at www.Parker.com/pfd

Parker Hose Doctor



- Parker HOSE DOCTORS®, a network of independently-owned, mobile service technicians, are built around the commitment to identify and replace hose assemblies wherever their customers need them
- Offers the fastest response times possible
- HOSE DOCTORS are an extension of the worldwide Parker distribution network, coupling their service commitment with Parker products – the highest quality hoses and fittings available in the market today

Value Added Services

Parker Store Container Service



- The ParkerStore container is a transportable workshop, providing on-site maintenance and product support for large construction projects such as roadworks, tunnels, railways, underground systems, etc
- Provides an on-site product and hose replacement service to assist in reducing downtime so your project stays on time and on budget

The Parker® Tracking System Enterprise (PTS)



PTS is designed to help customers reduce vehicle or asset down-time through increases in the speed, timing and accuracy of necessary repairs. PTS provides a unique 8 digit identification code and bar code printed on a durable label for each hose assembly.

PTS labels are specifically engineered to withstand harsh chemicals, temperatures, UV exposure and other challenging conditions.

- PTS captures, records and recalls unique hose assembly information – on demand
- Provides fast and accurate product identification to speed up replacement regardless of where the original assembly was made
- Assembly can be replaced with only the 8 digit PTS I.D. number/bar code eliminating the need to remove hoses prior to replacement and providing critical machine uptime
- Enables more conveniently scheduled repair
- PTS includes additional reporting tools to assist with continuous improvement and preventative maintenance initiatives

Tech Services, Breadman, Kitting



- Optimize the performance of your hydraulic and pneumatic circuits
- Parker Tech Services help you reduce your time, which saves on development costs
 - Parker's "3 year no-leak guarantee" enhances your reputation and lowers warranty costs
 - A more reliable operation lowers your customer's operating costs
 - More efficient performance and no-leak guarantee is environmentally beneficial
- Worldwide coverage ensures you can use the service and save costs wherever you are
- With the breadman system, the title for the goods usually transfers from the supplier to the customer upon delivery of the replenished inventory quantities.
- Kitting services reduce scrap and inventory complexity which lowers operating costs

Value Added Services

Crimpsource

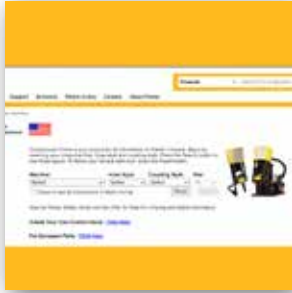

Find crimping instructions for all Parflex and Polyflex thermoplastic hoses. Please check regularly for updates

- www.parker.com/crimpsource
- Always up to date crimping instructions on hand

Hose
A

Waterblast

Hydraulic

Oil & Gas

Adapters
B

Quick Couplings
C

Accessories
D

Appendix
E





Hose

Waterblast

Hydraulic

Oil & Gas

Includes

High Pressure

TOUGH JACKET



Hose

Table Of Contents

Introduction

Hose Overview	A-3
Hose Sizing & Nomenclature	A-4
Hose "STAMPED" Form	A-4
Selection, Installation & Maintenance	A-5
Selection of Hose Diameter from Flow Rate	A-7
Pressure Drop - Determination of Pressure Drop	A-8
Gas Permeability of Plastics.....	A-9
General Chemical Resistance Table	A-10
Hose Pressure & Size Overview	
Waterblast Pressure & Size Overview.....	A-21
Hydraulic Pressure & Size Overview.....	A-60
Oil & Gas Pressure & Size Overview	A-78

Hose Sections

Waterblast	A-13
Hydraulic	A-57
Oil & Gas.....	A-75



Hose Overview

Parker Hannifin offers an extensive selection of system components for fluid technology. Parker products are available worldwide so no matter where you are working, our global network is available to serve you.

The Polyflex division, with headquarters located in Hüttenfeld, Germany and manufacturing division in Stafford, Texas, provides ultra high pressure thermoplastic hose. These hoses are used in a variety of different markets such as hydraulics, ultra high pressure applications, and on oil & gas equipment. As a market leader and, with a unique product range, we pride ourselves on being your extreme hose supplier and support team.

Ultra High Pressure Cleaning Hoses

Parker offers a large number of ultra high pressure hoses which are suitable for hydrostatic testing applications. With working pressures up to 60,000 psi and a size range spanning 1/8" I.D. up to 1-1/4" I.D., customers have hose options for test equipment and well installations in an extremely wide pressure range.

TOUGHJACKET™ Hose

TOUGHJACKET™ PVC-free water blast hose features a compact O.D. that's up to 25% smaller than PVC covered hoses, creating an ergonomic advantage for operators. They are light weight, have a small O.D. than comparable hoses and feature Colorgard™ safety liners to protect operators. TJ Hose also offers more flexibility and a longer service life for fewer change outs to lower operating costs.

- Industrial Cleaning
- Power Generation
- Chemical Refining
- Machine Tools
- Highway Maintenance
- Construction
- Marine

Available on:

- 2440N-08
- 2740D-03
- 2740D-05
- 2840D-03
- PFX30-05-TJ

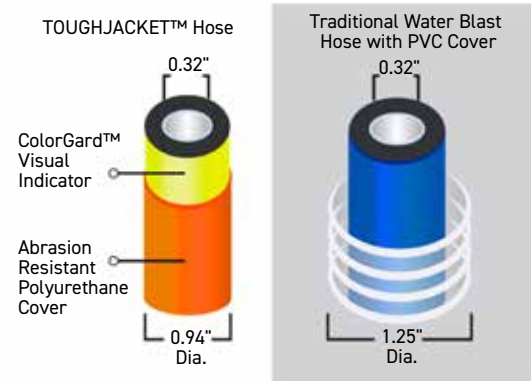

Hydraulic Hoses

High pressure hoses up to 18,560 psi (1,280 bar) are available in different configurations and colors for a wide range of applications.

Subsea

Parker Oil and Gas hoses continue to extend their reach and handle more pressures, both on subsea BOPs for hydraulic applications and when used as hot-lines. Today, continuous lengths are available up to 4,200m for MUX system applications.

BOP hose 2390N and suitable fittings are available as bulk hose and single components, allowing customers to crimp assemblies on-site with the Parker ParKrimp system.

- Hydraulic lines on Subsea BOPs
- Hose series 2022N is designed and qualified to meet ISO 13628-5 / API 17E specifications and is often used in umbilicals for hydraulic control or MEG / methanol injection
- HCR collapse resistant hose has a special internal core tube, allowing it to stay collapse resistant in depths up to 10,000 feet
- Hot lines from vessel or rig to subsea BOP
- General hydraulic applications



Black Eagle Oilfield Hoses

The Black Eagle family is a range of multi-spiral, wire reinforced hoses specifically designed for oil and gas applications in offshore and land operations.

- Cementing operations acc. to API 7K FSL
- Acidizing
- General Fluid and Gas Injection
- Mud Circulation

Hose Sizing & Nomenclature

Imperial and Metric

Imperial Size	Metric Size	DIN	Dash Size	
1/16	.062	1.6	2	-01
1/8	.125	3.2	3	-02
5/32	.156	4	4	-025
3/16	.188	4.8	5	-03
1/4	.250	6.4	6	-04
5/16	.310	7.9	8	-05
3/8	.375	9.5	10	-06
1/2	.375	12.7	13	-08
5/8	.625	15.9	16	-10
3/4	.500	19	20	-12
1	.750	25.4	25	-16
1-1/4	1.250	31.8	32	-20
1-1/2	1.500	38.1	40	-24
2	2.000	50.8	50	-32
3	3.000	76	78	-48



2448 N - 16 V91

Hose series Core tube material Hose I.D. in 1/16" Design variation



PFX 30 - 05 TJ

Hose series Pressure abbreviation ie. 3,000 psi Hose I.D. in 1/16" Design variation

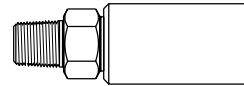

Manufacturing location Material

6 0 1 LX - 8 - 8 C

Connection code Parker fitting series Connection size thread/tube Hose inner diameter (Dash size)

Hose Stamped Form

Using the stamped for helps determine the correct hose for each application.

"STAMPED"

- **Size** - The appropriate inside and outside diameters and length of the hose should be determined
- **Temperature** - The ambient and/or maximum temperature of the material being conveyed
- **Application** - External conditions including abrasion, climate, heat, flexing, crushing, kinking, and degrees of bending
- **Media** - The composition of the substance being conveyed and chemical compatibility with the hose inner core and, if applicable, the outer cover
- **Pressure** - The maximum pressure of the system, including pressure spikes
- **Ends** - The appropriate end connection and attachment method for the application
- **Delivery** - Testing, quality, packaging, and delivery requirements

Selection, Installation & Maintenance

polyflex Hose and Hose Assemblies

Hoses and hose assemblies have a finite life span which can be affected by many factors. This recommended practice should be read by designers and users of hose to assist them in the proper selection of hose. These guidelines, while not exhaustive, will assist the user in maintaining hydraulic and pneumatic systems. Read the PARKER SAFETY GUIDE in its ENTIRETY (pg. E-3)

PART 1 - How to select hose

- **Pressure** - Maximum operating pressure of the hose must be greater than or equal to the system pressure. Pressure surges or system "spikes" in excess of the maximum operating pressure will shorten hose life and must be avoided.
- **Temperature** - Ambient and fluid temperatures must not exceed the hose/fittings rated design temperature. Attempt to route hose away from or shield hose from high temperature sources.
- **Size** - Adequately size hose and fittings to avoid damaging hose with excessive turbulence, or heat build-up, while maintaining proper flow and pressure. (Refer to fluid velocity nomogram on pg. A-7)
- **Fluid Compatibility** - Refer to Chemical Resistance Table on pg. A-10 for use of fluids with various materials. If unsure of an application, contact the factory. Additional care must be taken with gaseous applications. (Safety Guide pg. E-3)
- **Environment** - Conditions such as ozone, UV light, harsh chemicals, salt water, and other airborne contaminants can degrade hose and shorten its life.
- **Length** - Hose length changes with pressure. This, along with equipment movement, must be considered in the system design.
- **Proper couplings** - Always follow manufacturers' specifications and do not mix components of different manufacturers.
- **Mechanical loads** - Conditions such as tensile and side loads, vibration, excessive flexing, and twist will reduce hose life. Use swivel fittings and adaptors to avoid hose twisting. Test the hose if the application is potentially problematic or unusual.
- **Electrical conductivity** - Determine if the hose must be non-conductive to prevent electrical current flow or conductive to dissipate static electricity. Choose hose and fittings accordingly. (See Safety Guide for Electrical Conductivity issues.)

PART 2 - Installation & Maintenance

- **Inspect components** - Check hose for cover cracks, blisters, cleanliness, kinks, cracks or core tube obstructions or other defects. Examine fittings for poor threads, obstructions, cracks, rust. Do not use hose or fittings if these problems exist.
 - **Assemble per instructions** - Instructions are available for companies, trained and authorized by Polyflex.
 - Do not exceed specified minimum bend radius - Use stress relievers to prevent sharp bends at the hose and fitting juncture. These can be spring guards or other stress relieving members.
 - Ensure that hose bends rather than twists with equipment motion.
 - Use a torque wrench or the flats from finger tight method to properly install port connections.
 - **After installation** - Eliminate air entrapped in system, pressurize to maximum operating pressure, and check for leaks and proper system function.
 - Periodically (frequency depends on severity of application and potential risk) inspect the system for the following:
 1. Blistered, degraded, or loose hose covers
 2. Stiff, cracked, or charred hose
 3. Cuts or abrasion of hose (look for exposed reinforcement)
 4. Leaks in hose or fittings
 5. Damaged or corroded fittings
 6. Excessive build up of dirt, grease, oils, etc.
 7. Defective or broken accessories (clamping devices, kink guards)
 8. Kinks in hoses
- 
- Retest the system after all maintenance procedures.
 - Establish replacement schedules based on previous service life, or when failures could result in damage, personal injury, or excessive/unacceptable downtime.

Dash sizes are commonly used to designate hose I.D. and coupling sizes.

Common Hose Dash Sizes

Size		Dash number polyflex hose	Nominal DN Size
inch	mm		
3/32	2.0	-012	2
1/8	3.2	-2	3
5/32	4.0	-025 or 2A	4
3/16	4.8	-3	5
1/4	6.3	-4	6
5/16	7.9	-5	8
3/8	9.5	-6	10

Common Hose Dash Sizes

Size		Dash number polyflex hose	Nominal DN Size
inch	mm		
13/32	10.3	-6.5	—
1/2	12.7	-8	13
5/8	15.9	-10	16
3/4	19.1	-12	20
7/8	22.2	-14	—
1	25.4	-16	25
1-1/8	28.6	—	—

Common Hose Dash Sizes

Size		Dash number polyflex hose	Nominal DN Size
inch	mm		
1-1/4	31.8	-20	32
1-3/8	34.9	—	—
1-1/2	38.1	-24	40
1-13/16	46.0	—	—
2	50.8	-32	50

Selection, Installation & Maintenance

Right/Wrong

wrong

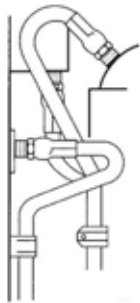
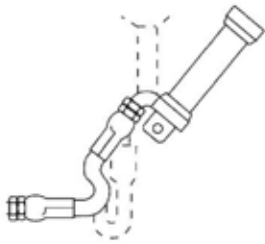
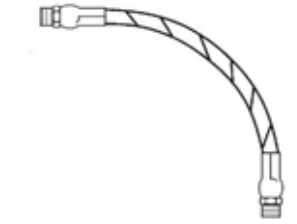
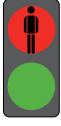

- Hose is weakened when installed in twisted position. Also, pressure pulses in twisted hose tend to fatigue wire and loosen fitting connections. Design so that the machine motion produces bending rather than torsion.

- Hose should exit coupling in a straight position rather than side loaded. The minimum bend radius must not be exceeded to avoid kinking of hose and flow restriction.

- When hose assembly is installed in a flexing applications, remember that metal hose fittings are not part of the flexible portion.

- Use elbow or adapters as necessary to eliminate excess hose length and to ensure neater installation and easier maintenance.

- Free hose length allowance:

Pressure can change hose in length by as much as $\pm 2\%$. This must be considered when cutting hose to appropriate length.

- Avoid installing hose assemblies close to heat sources. However, if this should be required, insulate hoses

right

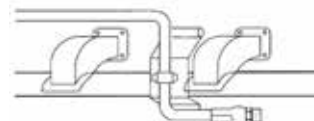
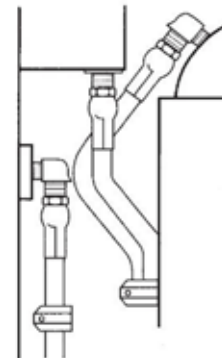
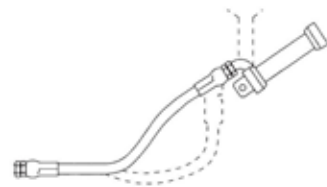
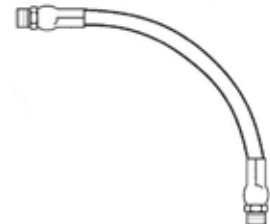

Selection of Hose Diameter from Flow Rate

From Flow Rate and Velocity

Flow capacities of Parker hose at recommended flow velocities The chart below is provided as an aid in the determination of the correct hose size.

Example

At 10 gallons per minute in the left-hand column and 25 feet per second in the right-hand column (the maximum recommended velocity range for pressure lines). Lay a straight line across these two points. The inside diameter shown in the center column is above -6 so we have to use -8 (1/2").

For suction hose, follow the same procedure except use recommended velocity range for suction lines in the right-hand column.

Where: Q = flow in gallons per minute (gal/min & l/min)
 V = velocity in feet per second (f/s & m/s)
 d = hose inside diameter (mm & dash size)

Fluid Velocity Nomogram For flow of liquids and gases

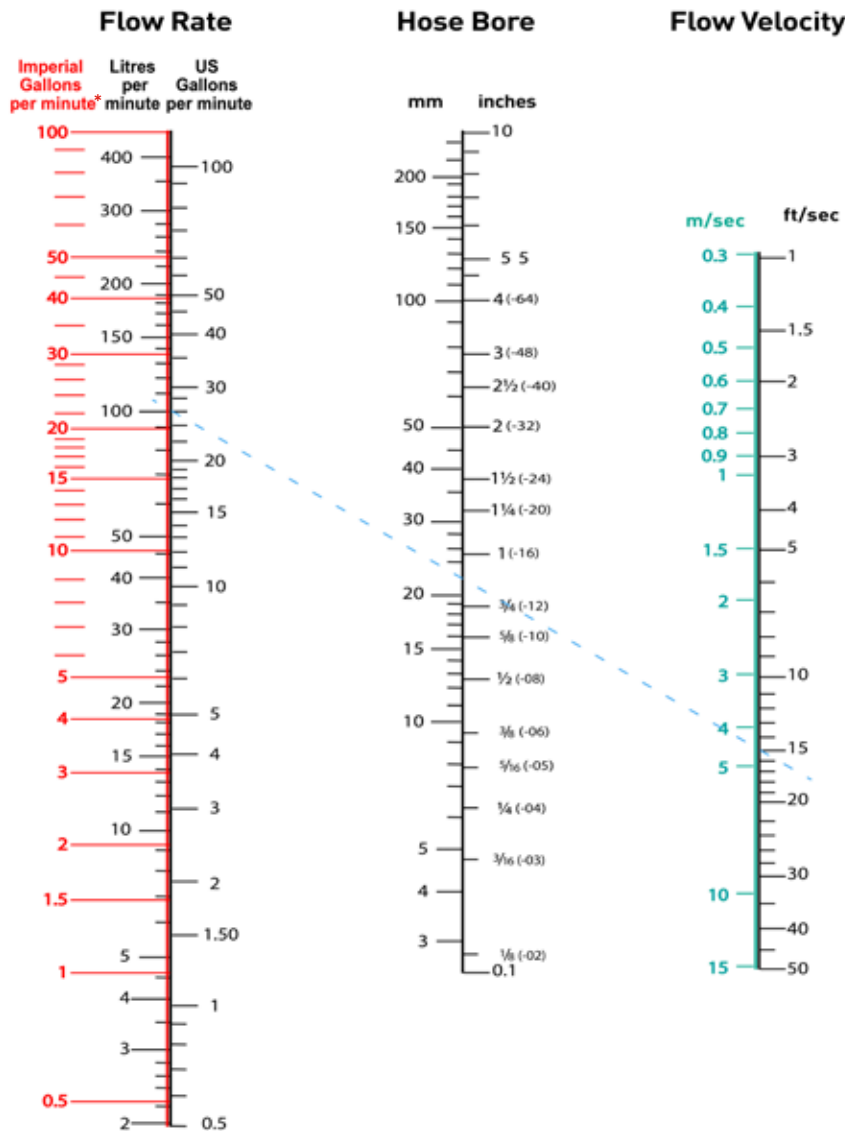

Pressure Drop - Determination of Pressure Drop

In the Line

Velocity

$$v = .409 \frac{Q}{d^2} = .509 \frac{W}{pd^2} = \frac{q}{.785d^2}$$

Reynold's Number

$$Re = 124 \frac{dvp}{\mu} = 6.31 \frac{W}{d\mu} = 378 \frac{qp}{d\mu}$$

Pressure Drop, Isothermal, Incompressible Flow (Liquids):

$$\Delta P = .001294 \frac{fLp v^2}{d} = .00000336 \frac{fLW^2}{pd^5} = .0121 \frac{fLq^2}{d^5}$$

Pressure Drop, Isothermal, Compressible, Long Lines (Gases and Vapors):

$$\frac{\Delta P}{P^1} = 1 - \sqrt{1 - \frac{fLp^1 v^{12}}{12g d P^1}}$$

Symbols and Units for Listed Formulas

- d** = Inside diameter of hose, inches
- f** = Friction coefficient, dimensionless
- g** = Gravitational constant, 32.2 ft./sec. 2
- P1** = Input pressure, psi
- ΔP** = Pressure difference, psi
- q** = Rate of flow at flowing condition, cu. ft./min.
- Q** = Rate of flow, gals/min.
- Re** = Reynolds number, dimensionless
- v** = Flow velocity, ft./sec.
- W** = Rate of flow, lbs./hr.
- p** = Weight density of fluid, lbs./cu. ft.
- μ** = Absolute (dynamic) viscosity, centipoises

Gas Permeability of Plastics

Permeability Coefficient

Permeability Coefficient

$$\frac{V}{A \times T \times p}$$

- Where: **V** volume of gas, in cm³, which diffuses through a 1mm thickness
A area across which the gas diffuses, in m²
T diffusion time, in days
p pressure difference across the plastic, in bar

Permeability Coefficients per DIN 53380

Material	Gas				
	N ₂	O ₂	CO ₂	H ₂	He
PTFE	50	150	1,500	—	3,500
PVDF	3	2	10	—	60
PA-6 XE 3289	1	4	10	100*	60*
PA-6 A 28 NZ	0.5	2	5	50*	30*
PA-12 L 2124	—	30	180	210	160
PA-12 P40 TL	—	—	105	—	—
PA-12 L 25W40	8	35	150	1,000*	500*
PA-12 L 2140	—	12	71	—	130
PA-11 P 40 TL	—	—	55	130	—
PA-11 POTL	2	20	65	65	—
POM H 2320	5	10	130	35	40
POM 150 SA	2	4	20	—	—
PEE 4055	150	—	3,000	—	1,400
PEE 5556	120	—	1,600	—	900
PEE 7246	—	—	—	—	300

* Calculated value. Diffusion constants based on normal room temperature. Actual behavior may vary considerably because of variations in processing the plastic.

General Chemical Resistance Table

Typical Waterblast and General Hydraulics

Rating Codes

Waterblast and General Hydraulics	
G	Good to excellent. Little or no swelling, tensile or surface changes. Preferred choice.
L	Marginal or conditional. Noticeable effects but not necessarily indicating lack of serviceability. Further testing suggested for specific application. Very long-term effects such as stiffening or potential for crazing should be evaluated.
P	Poor or unsatisfactory. Not recommended without extensive and realistic testing.
–	Indicates that this was not tested.

Materials for Hose Core Tubes

Material Code	
N	Polyamide
M	Coextruded tube with fluoropolymer inner liner
POM	Polyoxymethylene

Materials for Hose Cover

Material Code	
N	Polyamide
U/HF	Polyurethane

Notes on the Chemical Resistance Table

- (1) The fluid resistance tables are simplified rating tabulations based on immersion tests at 24°C. Higher temperatures tend to reduce ratings. Since final selection depends on pressure, fluid and ambient temperature and other factors not known to Parker Hannifin, no performance guarantee is expressed or implied. The indications do not imply any compliance with standards and regulations and do not refer to possible changes of color, taste or smell. For food and drinking water specially approved materials have to be used. For fluids not listed or for advice on particular applications, please consult Parker Hannifin GmbH, **polyflex** Division in Hüttenfeld, Germany.
- (2) Hose applications for these fluids must take into account legal and insurance regulations. The chemical resistance indicated does not express or imply approval by certain institutions.
- (3) Satisfactory at some concentrations and temperatures, unsatisfactory at others.
- (4) For gas applications, the cover should be pin-pricked and the pressure must not be released quickly. Special safety guard accessories are to be used to prevent damage or personal injury in the event of failure.
- (5) Chemical resistance does not imply low permeation rates. Please consult Parker Hannifin for a recommendation for your specific requirements.
- (6) The indication of chemical resistance does not imply any special food compatibility; it refers only to the chemical resistance of the material.
- (7) Chemical resistance does not imply acceptability for use in airless paintspray applications. These applications require a special, electrically conductive hose. Reference the Safety Guide, 2.1.2

General Chemical Resistance Table

Typical Waterblast and General Hydraulics

Typical Waterblast and General Hydraulics

Chemical	POM	N	U	M
Acetone	L	G	P	L
Acetylene	—	—	—	—
Air (4)	G	G	G	G
Ammonium Chloride	—	P	G	G
Ammonium Hydroxide	—	G	P	G
Anhydrous Ammonia	—	P	P	—
Aniline	—	P	P	G
Aromatic Hydrocarbons	—	G	L	—
Asphalt	—	G	G	L
Benzene	—	G	L	G
Butane (2) (4)	—	G	L	—
Calcium Chloride	—	—	G	G
Carbon Dioxide (4)	—	G	G	—
Carbon Monoxide (4)	—	—	G	—
Carbon Tetrachloride	—	G	P	G
Chlorinated Hydrocarbon Base Fluids	—	G	L	—
Chlorinated Petroleum Oil	—	G	L	—
Chlorinated Solvents	—	—	P	—
Chlorine, Gaseous, Dry	—	P	P	—
Chromic Acid	—	—	P	L
Citric Acid Solutions	—	G	L	G
Crude Petroleum Oil	G	G	G	—
Cyclohexan (2)	—	G	G	G
Diesel Fuel (2)	G	G	G	—
Diester Oils	—	G	P	—
Ethanol (6)	G	G	L	—
Ethers	P	G	P	G
Ethylene Glycol	G	G	L	G
Ethylene Oxide	—	G	L	—
Fatty Acids	—	G	—	G
Formaldehyde	—	L	P	G
Formic Acid J	—	P	P	G
Fuel Oil (2)	G	G	L	G
Gas (Oil) (2)	—	G	G	—
Gasoline	—	G	—	G
Glycerine	—	G	L	G
Glycols (to 135°F)	G	G	L	G
Grease (petroleum base)	G	G	G	—
Hexane (2)	—	G	G	G
Hydraulic Fluid (petroleum base)	G	G	G	L

Typical Waterblast and General Hydraulics

Chemical	POM	N	U	M
Hydraulic Fluid (phosphate ester base)	—	G	L	—
Hydraulic Fluid (water base)	—	G	G	—
Hydraulic Oil (petroleum base)	G	G	G	L
Hydrochloric Acid	—	L	P	G
Hydrofluoric Acid	—	P	P	G
Hydrolube (hydraulic fluid/water glycol base)	—	G	L	—
IRUS 902 (hydraulic fluid/water-oil emulsion)	—	G	G	—
Isooctane (2)	—	G	G	G
Kerosene (2)	—	G	L	G
Ketones	—	G	P	G
Lime (calcium oxide)	—	G	G	G
Lindol (hydraulic fluid/phosphate esters)	—	G	P	—
LP-Gas	—	—	—	—
Lubricating Oils (diester base)	—	G	P	—
Lubricating Oils (petroleum base)	G	G	G	G
Methane	—	—	—	—
Methanol	—	G	P	—
Methyl Alcohol (6)	G	G	P	—
Methyl Ethyl Ketone (MEK)	L	G	P	—
Methyl Ethyl Ketone Peroxide (MEKP)	—	L	P	—
Methyl Isobutyl Ketone (MIBK)	—	G	P	—
Methylen Chloride	P	L	P	—
Mineral Oil	G	G	G	—
Mineral Spirits	—	—	L	—
Motor Oils	—	G	G	—
Naphta	G	G	P	—
Natural Gas (4)	—	—	—	—
Nitric Acid	—	P	P	—
Nitrobenzene	—	G	P	—
Nitrogen, Gaseous (4) (5)	—	G	G	—
Nitrous Oxide	—	L	—	—
Oil (SAE)	G	G	G	—
Oxygen, Gaseous (4) (5) (6)	—	G	G	—
Pentane (2)	—	G	L	—
Perchloric Acid	—	P	P	—

Instructions and Rating Code - pg. A-10

(Cont.)

General Chemical Resistance Table

Typical Waterblast and General Hydraulics

Typical Waterblast and General Hydraulics

Chemical	POM	N	U	M
Petroleum Ether	—	—	—	
Petroleum Oils	—	G	G	
Phenols	—	P	P	
Phosphate Esters (above 135°F)	—	G	P	
Phosphate Esters (to 135°F)	—	G	P	
Propane (4) (5)	—	—	—	
Propylen Glycol	—	—	G	
Salt Water	—	—	—	G
Silicone Greases	—	G	G	—
Silicone Oils	—	G	G	—
Sodium Borate	—	G	G	G
Sodium Carbonate	—	—	—	—
Sodium Chloride Solutions	—	G	G	G
Sodium Hydroxide, 50%	—	P	P	G
Sodium Hypochloride	—	P	P	G
Steam	—	P	P	G
Straight Synthetic Oils (phosphate esters)	—	G	P	—
Sulphur Dioxide	—	L	L	G
Sulphur Hexafluoride Gas (4) (5)	—	G	G	—
Sulphuric Acid	—	P	P	—
Toluol, Toluene	G	G	L	G
Trichlorethylene	—	L	P	G
Ucon (hydraulic fluid/water glycol base)	—	G	L	—
Water (above 60°C) (6)	G	G	P	L
Water (to 60°C) (6)	—	G	G	G
Water Glycols (above 60°C)	—	L	P	—
Water Glycols (to 60°C)	—	G	L	—
Water in oil Emulsions (above 60°C)	—	L	P	—
Water in oil Emulsions (to 60°C)	G	G	L	—
Xylene	G	G	P	G
Zinc Chloride	—	G	G	G

Instructions and Rating Code - pg. A-10

Waterblast Hose



Waterblast Hose

Table Of Contents

Introduction

User Manual for Application of Hose Assemblies for High-Pressure Water Jet Machines	A-15
Fitting Configurations	A-20
Waterblast Hose Size & Pressure Overview	A-21

Hose Series

2240D-02	A-22	2440N-04	A-40
2240D-025	A-23	2440N-06	A-41
2240D-03	A-24	2440N-08	A-42
2240D-04	A-25	2440N-12	A-43
2245D-03	A-26	2440N-16	A-44
2248D-025	A-27	2448D-025	A-45
2248D-03	A-28	PFX-25-03	A-46
2248D-05	A-29	2640N-08	A-47
2380N-04	A-30	2640N-12	A-48
2380N-05	A-31	2648N-12	A-49
2388N-04	A-32	2648N-16	A-50
2388N-08	A-33	PFX30-03.....	A-51
2440D-02	A-34	PFX40-03.....	A-53
2440D-025	A-35	PFX25-05.....	A-52
2440D-03	A-36	PFX30-05.....	A-54
2440D-04	A-38	PFX38-05.....	A-54
2440D-05	A-39		

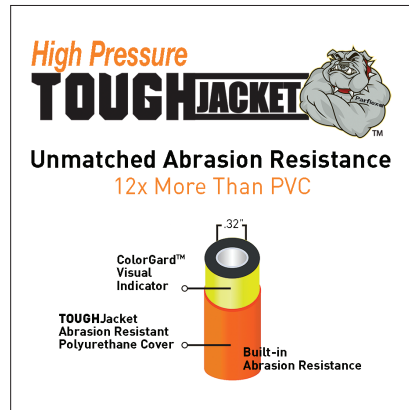

User Manual for the Application of Hose Assemblies for High-Pressure Water Jet Machines

This User Manual has been prepared according to the requirements of EN 1829-2: 2008 High-Pressure Water Jet machines – Safety Requirements – Part 2: Hoses, Hose Lines and Connectors. It contains instructions on the proper use of hose assemblies made by Parker Hannifin for high pressure water-jetting applications. Never use hose assemblies without thoroughly reading and understanding this User Manual. Any additional safety requirements issued by machine manufacturers, trade associations, ect. must be complied with. We recommend wearing protective clothing.

1. Hazard Notice

Hazards due to escaping media

- Media escaping at high pressure can cause personal injury and property damage.
- The escape of flammable media can cause fire.
- The escape of toxic media can cause intoxication if these are inhaled or ingested.

Hazards because of whipping hose assemblies

- If, after break of the hose assembly, the pressure is not immediately reduced to zero, the hose starts whipping, which may cause personal injury or property damage. Hazards due to change in length of the hose assembly.

Hazards due to change in length of the hose assembly

- In the event of a sudden pressure change in the hose assembly, its length may change by +-2%. This could lead to operators losing their foothold.

Hazards due to incorrect behavior of operator

- Hazards may arise from the use of unsuitable substances or components by the operator, especially if the application limits defined by the manufacturer are exceeded (e.g. too high pressure, too high tensile loads).

2. Description

Hose assemblies are made from high-pressure hose and the corresponding fittings by Parker Polyflex and the operators trained by certified distributors in compliance with Parker assembly instructions. Hoses are pressure tested after completion. Upon customer's request, the hose assemblies can be equipped with protective sleeves or other safety equipment such as Support Grips.

3. Marking

- The hose bears a factory marking specifying the manufacturer, the maximum working pressure, the part number, nominal size, batch number and the date of manufacture (quarter/year). The marking may include additional information.
- Protective sleeves have no marking as a standard.
- On its crimping shell or marking sleeve, the hose assembly bears a marking specifying the manufacturer, the maximum working pressure, the month and year of manufacture and the standard "EN 1829-2".

User Manual for the Application of Hose Assemblies for High-Pressure Water Jet Machines

4. Assembly and Installation, Proper Use

To ensure the proper function of hose assemblies and to prevent shortening their life by additional strain, the following instructions need to be followed:

- The maximum working pressure shall not be exceeded.
- The hose shall not be bent to less than its minimum bend radius.
- Do not kink or twist hose assemblies, especially when long hose assemblies are routed. Loops may form which can lead to kinks in the hose when pulled. Parker manufactures special fittings (Polyflex-Lok) which minimize this problem.
- Under pressure, any hose may become shorter or longer. Length change is approximately 2% unless otherwise noted.
- Before installing a hose assembly, make a visual inspection of the following:
 - The working pressure of the hose assembly corresponds to the pressure of the pump.
 - The hose cover does not show any damage.
 - The fittings do not show any signs of corrosion.
 - Threads and sealing faces are not damaged or dirty.
 - O-rings are available and not damaged.
- Make sure that the connecting thread of the fitting matches its counter-piece.
- Do not remove protective caps until immediately prior to assembly.
- When mounting the fitting, slightly grease the threads of the fitting and the adapter to prevent cold welding (seizing).

When putting the hose assembly into operation, slowly build up the pressure and check the assemblies for leaks.

Proper Use

- Operating Medium

Parker Flex Lance and Waterblast hose assemblies are designed for use with water. For information about use with other media, please contact your Parker distributor – Parker's range includes special hoses which are suitable for e.g. corrosive media.

- Temperature:

Many hose assemblies are designed for safe operation in temperatures up to 212°F (100°C) but not all. Please review the technical specifications for each hose when making your selection. If you wish to operate the hose assembly beyond the normal range, contact your Parker distributor. Parker's range also includes special hoses suitable for higher temperatures. If hose assemblies are operated at low temperatures, no problems should be expected with the hose assemblies themselves; however, measures should be taken to prevent the operating medium from freezing.

- Troubleshooting

Immediately eliminate any leakage on the connectors (refasten connectors, replace O-rings, if necessary, or rework the cone).



Caution: Prior to performing any work, always relieve the pressure – never work on hose assemblies while they are under pressure. Should the leakage occur in the hose (blisters in the hose cover, leaks at the relief holes of the fitting) put the hose assembly out of operation immediately.

Continued use of a leaky hose assembly exposes the operators to serious hazards.

- Special Types of Application

When used in tall buildings, hose assemblies have to be supported to prevent tensile stress. If hose assemblies are used under tensile stress, this will shorten their life. When using hose assemblies in potentially explosive atmospheres, it needs to be considered that Parker high-pressure hose assemblies are electrically conductive in general (from fitting to fitting). However, neither the protective sleeves nor the hose cover are electrically conductive.

5. Storage and Utilization Time of Hose Assemblies

Even if properly stored and operated at permissible loads, hose assemblies are subject to natural ageing. This limits their storage and utilization time. Improper storage, mechanical damage and excessive stress are the most frequent causes of failure. For the storage of hose assemblies, the following instructions shall be followed:

User Manual for the Application of Hose Assemblies for High-Pressure Water Jet Machines

5. Storage and Utilization Time of Hose Assemblies (cont.)

- Store the hose assemblies in a cool and dry place with low levels of dust.
- Do not expose the hose assemblies to direct sunlight or UV radiation.
- Protect the hose assemblies from heat sources.
- Do not use any ozone-generating luminaries (fluorescent sources of light, mercury vapor lamps) or electrical devices in the immediate vicinity of hose assemblies.
- Store hose assemblies stress-free and in a horizontal position.
- When storing hose assemblies in bundles, the hose shall not be bent to less than its minimum bend radius.
- Store fittings with protective caps to prevent damage to the thread.

The maximum storage time of bulk hose is 10 years and completed hose assemblies is up to 2 years. If possible, storage of hose assemblies should be avoided. The natural properties of the hose materials cause a loss of compression in the fitting, which may lead to premature leakage of the fitting.

Utilization Period and Replacement Intervals

Parker does not limit the utilization period of a hose assembly, however it should not exceed 6 years. Hose assemblies are used in a great variety of applications. For this reason Polyflex hoses are not guaranteed a specific useful life of the hose assembly in a particular application. The following guidelines may be useful:

- Parker Polyflex hose assemblies meet or exceed the requirements of DIN EN 1829-2. This standard prescribes that hose assemblies have to resist at least 20,000 cycles from zero to working pressure. This is relevant for industrial applications (e.g. cleaning of parts in the automotive industry) where hose assemblies are used on a permanent basis. In this case, no periodic pressure tests are required, but periodic visual inspections are recommended. The intervals for visual inspection and replacement must be determined by the manufacturer of the plant.
- In the construction industry (e.g. concrete refurbishment) and in flexible guns, hose assemblies are usually exposed to additional stress (e.g. tensile loads, mechanical damage) which may considerably reduce their useful life. Therefore, the tests according to Section 6 are mandatory.

6. Maintenance, Repair, Inspection, Period Pressure Tests

Prior to the first usage and at least every six months

- Check hose assemblies thoroughly to determine whether they can be safely used. This inspection should be done by a skilled person with professional training, experience and sufficient knowledge about hoses.
- Scope of tests: visual inspection of the hose assemblies. Check whether the working pressure of the hose assembly corresponds to the actual working pressure of the application and whether the hose assembly shows any visible damage.
- Visible damage may include:
 - Damage of the hose cover (e.g. abrasion, cuts or cracks).
 - Deformation beyond the natural shape of the hose assembly in depressurized or pressurized state or during bending. This may include separation of layers, blisters, crushed or kinked hose.
 - Damage or deformation of the fitting.
 - Corroded fitting.
 - Hose detaching from the fitting.
 - Maximum storage and utilization times have been exceeded.
- Daily
 - Visual inspection of the hose assemblies by the operator. (see above) Upon discovery of any visible damage, replace the hose assembly or escalate inspection to a designated quality inspector.
 - According to EN 1829-2, hose assemblies whose cover is so badly damaged that the wire reinforcement becomes visible must be withdrawn from service. Repair of the hose cover is not allowed.
- Yearly
 - In addition to the visual inspection of the hose assembly, each assembly must be pressure tested at 1.2 x the working pressure for two minutes. This pressure test is not required for hose assemblies in continuous use (industrial plants).
 - Repair of hose assemblies - Parker Polyflex advises against the repair of hose assemblies as the safety of a hose assembly that has already been in service is always reduced. In general, repair of hose assemblies by authorized Parker Polyflex distributors is permissible with certain restrictions. Please consult your Parker distributor.

User Manual for the Application of Hose Assemblies for High-Pressure Water Jet Machines

7. Polyflex-Lok

Polyflex-Lok is a system designed for the fast mounting of hose assemblies and/or for the connection of the hose assemblies to the pump / gun without any tools. The system for connecting hose assemblies consists of hose assemblies (equipped with protective sleeve as a standard) with special connectors and protective caps, connection sleeves and shells.

Assembly

- Remove the protective caps from the hose connectors.
- Slightly grease the hose connectors or wet them with some water and push them into the connection sleeve up to the stop. Close the shells over the connection sleeve.

CAUTION: Make sure that all parts are perfectly clean and free from dirt and damage or deposits. Otherwise proper tightness and/or easy disassembly cannot be ensured. If necessary, clean the parts prior to assembly.
- Pull the hose assemblies apart (important, as otherwise the protective caps cannot be mounted) and mount the protective caps between the shells and the clamping sleeves for the protective sleeve.

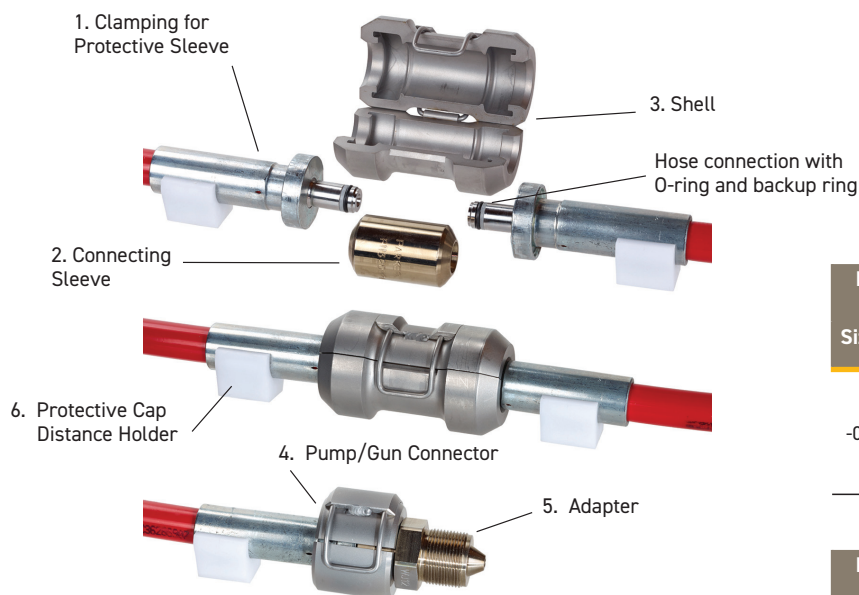

Polyflex-Lok Pressure Rating for Size -03 / DN5: 46,400 psi

Size	DN	Hose Types
-03	DN5	2740D-03Vxx 2740D-03Vxx/xx

Polyflex-Lok Pressure Rating for Size -05 / DN8: 46,400 psi

Size	DN	Hose Types
-05	DN8	2380N-05VxxW 2740D-05Vxx 2740D-05Vxx/xx PFX30-05Vxx/xx

Polyflex-Lok Pressure Rating for Size -08 / DN12: 36,250 psi

Size	DN	Hose Types
-08	DN12	2388N-08Vxx 2840D-08Vxx

Ref	Part Number	Description
1	1TM2X-8-03-HPK	Fitting for DN5 hoses including caps
	1TM2X-8-05-HPK	Fitting for DN8 hoses including caps
	1TMKY-8-05-HPK	Fitting for DN8 hoses including caps
	1TMBL-9-08-HPK	Fitting for DN12 hoses including caps
	1TMBS-9-08-HPK	Fitting for DN12 hoses including caps
2	TFTF-8-8	Hose connector bushing for DN5 and DN8
	TFTF-8-9	Hose connector bushing - connection DN5 or DN8 to DN12
	TFTF-9-9	Hose connector bushing for DN12
3	HPK-HS-8	Hose connector
4	HPK-HSP-8	Pump/gun connector
5	Y6TF-6-8	Adapter 3/4 - 16UNF to DN5 or DN8
	Y6TF-9-8	Adapter 1-1/8 - 12UNF to DN5 or DN8
6	TMCAP-8	Cap DN5 or DN8
	TMCAP-9	Cap DN12

User Manual for the Application of Hose Assemblies for High-Pressure Water Jet Machines

7. Polyflex-Lok (continued)

Disassembling

- Remove the protective caps.
- Push the hose assemblies together up to the stop as otherwise the shells cannot be opened.
- Open the shells and remove them.
- Pull the hose connectors out of the connecting sleeve and immediately place the protective caps on the hose connectors. between the shells and the clamping sleeves for the protective sleeve.

The Polyflex-Lok system for the connection of the hose assembly to the pump / gun is designed according to the same principle. An adapter is screwed onto the pump; a hose assembly is pushed into the adapter and fixed with shells and a cap. Here as well cleanliness is mandatory.

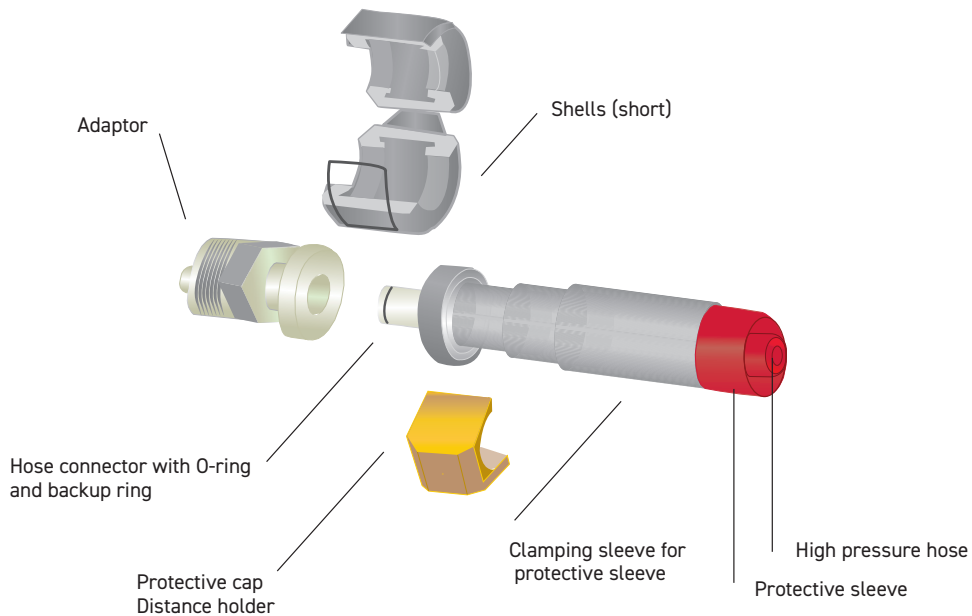

Fitting Configurations

by Connection and End Code

End Code		Description
Pipe	01	Male NPT Pipe - Rigid - Straight
Flare	06	JIC 37° Flare – Female
Metric	C9	Female Metric S - Swivel - Straight (24° Cone)
Specialty	5Y	Medium Pressure Female Swivel
	6Y	High Pressure Female Swivel
	AY	Type "M" Swivel - Female
	HY	Waterblast Nozzle, Female
	Y2	Medium Pressure Male
	Y4	High Pressure Male
	YH	Waterblast Nozzle, Male

Waterblast Hose Size & Pressure Overview

Part Number	Dimension Data							Max. Working Pressure		Min. Bend Radius		Weight		Fitting	Design Factor
	DN	DN	Size	I.D. inch	I.D. mm	O.D. inch	O.D. mm	psi	bar	inch	mm	lbs./ft.	kg/mtr		
DN3															
2240D-02V33-TC	15K3MM	3	-02	1/8	3.2	0.28	7.1	15,950	1,100	2.36	60	0.05	0.07	TX	2.5
2440D-02V37-TC	30K3MM	3	-02	1/8	3.2	0.31	7.9	30,000	2,070	3.94	100	0.08	0.12	LX	2.5
DN4															
2240D-025V33-TC	17K4MM	4	-025	5/32	4.0	0.30	7.7	17,400	1,200	2.95	75	0.07	0.10	TX	2.5
2248D-025V32-TC	21K4MM	4	-025	5/32	4.0	0.31	7.9	21,750	1,500	2.95	75	0.07	0.11	TX	2.5
2440D-025V37-TC	31K4MM	4	-025	5/32	4.0	0.41	10.5	31,900	2,200	3.94	100	0.14	0.21	LX	2.5
2448D-025V35-TC	43K4MM	4	-025	5/32	4.0	0.39	9.9	43,645	3,010	4.72	120	0.15	0.22	LX	2.5
DN5															
2240D-03V33-TC	15K5MM	5	-03	3/16	4.8	0.37	9.5	15,955	1,100	3.74	95	0.09	0.13	TX	2.5
2245D-03V33	15K5MM	5	-03	3/16	4.8	0.42	10.7	15,000	1,034	3.74	95	0.14	0.21	AX	2.7
2248D-03V32-TC	20K5MM	5	-03	3/16	4.8	0.37	9.5	20,300	1,400	3.74	95	0.09	0.14	TX	2.5
2440D-03V32-TC	26K5MM	5	-03	3/16	4.8	0.45	11.5	26,100	1,800	5.12	130	0.19	0.28	LX	2.0
PFX25-03	36K5MM	5	-03	3/16	4.8	0.51	12.9	36,250	2,500	6.89	175	0.28	0.41	2X	2.5
PFX30-03	40K5MM	5	-03	3/16	4.8	0.52	13.3	43,645	3,010	7.87	200	0.32	0.47	2X	2.5
PFX30-03-TJ	40K5MMTJ	5	-03	3/16	4.8	0.68	17.3	43,645	3,010	7.87	200	0.39	0.58	2X	2.5
PFX40-03	58K5MM	5	-03	3/16	4.8	0.59	15.1	58,000	4,000	7.87	200	0.43	0.64	2X	2.1
PFX40-03-TJ	58K5MMTJ	5	-03	3/16	4.8	0.75	19.1	58,000	4,000	7.87	200	0.52	0.77	2X	2.1
DN6															
2240D-04V33-TC	15K6MM	6	-04	1/4	6.4	0.46	11.6	15,950	1,100	4.33	110	0.13	0.20	TX	2.5
2380N-04V66	13K6MM	6	-04	1/4	6.4	0.53	13.4	13,200	910	1.58	40	0.2	0.30	NX	2.5
2388N-04V13W	18K6MM	6	-04	1/4	6.4	0.53	13.4	18,560	1,280	1.58	40	0.2	0.30	KY	2.5
2440D-04V32-TC	23K6MM	6	-04	1/4	6.4	0.49	12.5	23,780	1,640	6.10	155	0.22	0.33	LX	2.5
2440N-04V32	20K6MM	6	-04	1/4	6.4	0.51	13.0	20,300	1,400	6.1	155	0.21	0.31	LX	2.5
DN8															
2248D-05V33-TC	15K8MM-TC	8	-05	5/16	7.9	0.53	13.5	15,000	1,034	4.72	120	0.17	0.25	TX	2.5
2380N-05V03W	15K8MM	8	-05	5/16	7.9	0.62	15.8	15,000	1,034	3.54	90	0.24	0.35	KY	2.5
2440D-05V32-TC	21K8MM	8	-05	5/16	7.9	0.59	15.1	21,750	1,500	6.89	175	0.30	0.44	LX	2.5
PFX25-05-TJ	36K8MMTJ	8	-05	5/16	7.9	0.84	21.3	36,230	2,500	7.87	200	0.63	0.94	2X	2.5
PFX30-05	43K8MM	8	-05	5/16	7.9	.736	18.7	43,645	3,010	9.00	230	0.64	0.96	2X	2.3
PFX30-05-TJ	43K8MMTJ	8	-05	5/16	7.9	.894	22.7	43,645	3,010	9.00	230	0.75	1.10	2X	2.3
PFX38-05-TJ	55K8MMTJ	8	-05	5/16	7.9	.964	24.5	55,000	3,800	11.00	280	0.96	1.43	2X	2.1
DN10															
2440N-06V32	20K10MM	10	-06	3/8	9.5	0.77	19.5	20,300	1,400	7.00	190	0.49	0.73	LX	2.5
DN12															
2388N-08V13	15K13MM	13	-08	1/2	12.7	0.91	23.1	15,950	1,100	4.72	120	0.54	0.80	BS	2.5
2440N-08V32	20K13MM	13	-08	1/2	12.7	0.89	22.7	20,300	1,400	8.00	200	0.63	0.94	LX	2.5
2440N-08V30/12	20K13MMTJ	13	-08	1/2	12.7	1.13	28.6	20,300	1,400	8.00	200	0.81	1.21	LX	2.5
2640N-08V32	26K13MM	13	-08	1/2	12.7	0.96	24.5	26,100	1,800	11.42	290	0.92	1.37	2X	2.5
DN20															
2440N-12V36	14K20MM	20	-12	3/4	19.0	1.19	30.2	14,500	1,000	10.00	250	0.98	1.46	LX	2.5
2640N-12V32	20K20MM	20	-12	3/4	19.0	1.30	33.0	20,300	1,400	13.78	350	1.45	2.16	5X	2.5
2640N-12V32/12	20K20MMTJ	20	-12	3/4	19.0	1.46	37.0	20,300	1,400	13.78	350	1.61	2.40	JX	2.5
2648N-12V32	23K20MM	20	-12	3/4	19.0	1.33	33.7	23,200	1,600	13.78	350	1.53	2.28	JX	2.5
DN25															
2440N-16V36	13K25MM	25	-16	1	25.4	1.46	37.2	13,050	900	12.00	300	1.34	2	LX	2.5
2648N-16V32	21K25MM	25	-16	1	25.4	1.61	40.8	21,750	1,500	15.75	400	2.08	3.10	CX	2.5

Assembly working pressure is dependent on the lowest rated component. Therefore, if fittings have a lower pressure rating than the hose, the working pressure of the fittings is the working pressure of the assembly.

1/8" - 15,950 psi High Pressure Flex Lance Hose

2240D-02V33-TC
15K3MM



Construction

- Core Tube: Polyoxymethylene
- Pressure Reinforcement: Two spiral layers of maximum tensile steel wire
- Cover: Polyamide
- Standard Color: x3 - Green

Temperature

- Temperature Range:
14°F to 158°F (-10°C to 70°C)

Design Factor

- 2.5

Certifications

- DIN EN1829-2 compliant

Notes

- TC Tough Cover offers improved abrasion resistance over the standard.

[Visit the webpage](#)

Part Number	Nominal I.D.		Max. O.D.		Max. Working Pressure		Min. Bend Radius		Weight		Fitting Series		
	DN	Size	inch	mm	inch	mm	psi	bar	inch	mm		lbs./ft.	kg/mtr
2240D-02V33-TC	3	-02	1/8	3.2	0.28	7.1	15,950	1,100	2.36	60	0.05	0.07	TX

101TX - NPT Male

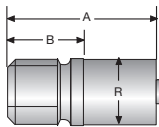

Part Number	Nominal I.D.		Thread Size	Overall Length A		Cutoff Allow. B		Diameter R		Max. Working Pressure			
	DN	Size		inch	mm	inch	mm	inch	mm	psi	bar		
101TX-1-02-PL	3	-02	1/8	3.2	1/16" - 27	0.95	24	0.41	10	0.36	9	15,000	1,034
101TX-2-02-PL					1/8" - 27								

Carbon Steel, Zinc-plated



WARNING

This product can expose you to chemicals including Lead, which is known to the State of California to cause cancer and birth defects or other reproductive harm. For more information go to www.P65Warnings.ca.gov.

5/32" - 17,400 psi High Pressure Flex Lance Hose

2240D-025V33-TC
17K4MM



Construction

- Core Tube: Polyoxymethylene
- Pressure Reinforcement: Two spiral layers of maximum tensile steel wire
- Cover: Polyamide
- Standard Color: x3 - Green

Temperature

- Temperature Range:
14°F to 158°F (-10°C to 70°C)

Design Factor

- 2.5

Certifications

- DIN EN1829-2 compliant

Notes

- TC Tough Cover offers improved abrasion resistance over the standard.

[Visit the webpage](#)

Part Number	Nominal I.D.		Max. O.D.		Max. Working Pressure		Min. Bend Radius		Weight		Fitting Series		
	DN	Size	inch	mm	inch	mm	psi	bar	inch	mm		lbs./ft.	kg/mtr
2240D-025V33-TC	4	-025	5/32	4.0	0.30	7.7	17,400	1,200	2.95	75	0.07	0.10	TX

101TX - NPT Male

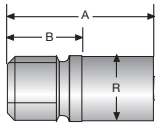

Part Number	Nominal I.D.		Thread Size	Overall Length A		Cutoff Allow. B		Diameter R		Max. Working Pressure			
	DN	Size		inch	mm	inch	mm	inch	mm	psi	bar		
101TX-1-025-PL	4	-025	5/32	4.0	1/16" - 27	1.04	27	0.43	11	0.39	10	15,000	1,034
101TX-2-025-PL					1/8" - 27								

Carbon Steel, Zinc-plated

1AYTX - Type "M" Swivel - Female

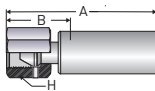

Part Number	Nominal I.D.		Thread Size	Overall Length A		Cutoff Allow. B		Diameter R		H Hex			
	DN	Size		inch	mm	inch	mm	inch	mm	inch	mm		
1AYTX-6-025W	4	-025	5/32	4.0	9/16" - 18	1.99	51	1.10	28	0.39	10	0.75	19

Carbon Steel, Zinc-plated



WARNING

This product can expose you to chemicals including Lead, which is known to the State of California to cause cancer and birth defects or other reproductive harm. For more information go to www.P65Warnings.ca.gov.

3/16" - 15,955 psi High Pressure Flex Lance Hose

2240D-03V33-TC
15K5MM



Construction

- Core Tube: Polyoxymethylene
- Pressure Reinforcement: Two spiral layers of maximum tensile steel wire
- Cover: Polyamide
- Standard Color: x3 - Green

Temperature

- Temperature Range:
14°F to 158°F (-10°C to 70°C)

Design Factor

- 2.5

Certifications

- DIN EN1829-2 compliant

Notes

- TC Tough Cover offers improved abrasion resistance over the standard.

[Visit the webpage](#)

Part Number	Nominal I.D.		Max. O.D.	Max. Working Pressure		Min. Bend Radius		Weight		Fitting Series			
	DN	Size		inch	mm	psi	bar	inch	mm		lbs./ft.	kg/mtr	
2240D-03V33-TC	5	-03	3/16	4.8	0.37	9.5	15,955	1,100	3.74	95	0.09	0.13	TX

101TX - NPT Male

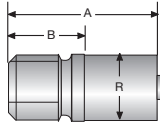

Part Number	Nominal I.D.		Thread Size	Overall Length A		Cutoff Allow. B		Diameter R		Max. Working Pressure		
	DN	Size		inch	mm	inch	mm	inch	mm	psi	bar	
101TX-2-03-PL	5	-03	3/16	4.8	1.04	27	0.45	12	0.47	12	15,000	1,034
101TX-4-03-PL					1.22	31	0.63	16				

Carbon Steel, Zinc-plated

1AYTX - Type "M" Swivel - Female

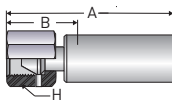

Part Number	Nominal I.D.		Thread Size	Overall Length A		Cutoff Allow. B		Diameter R		H Hex		
	DN	Size		inch	mm	inch	mm	inch	mm	inch	mm	
1AYTX-6-03W	5	-03	3/16	4.8	2.20	56	1.14	29	0.47	12	0.75	19

Carbon Steel, Zinc-plated

Accessories Part Numbers

Hose Stop

AH-03S

Technical details available in Section D.

WARNING

This product can expose you to chemicals including Lead, which is known to the State of California to cause cancer and birth defects or other reproductive harm. For more information go to www.P65Warnings.ca.gov.

1/4" - 15,950 psi High Pressure Flex Lance Hose

2240D-04V33-TC
15K6MM



Construction

- Core Tube: Polyoxymethylene
- Pressure Reinforcement: Two spiral layers of maximum tensile steel wire
- Cover: Polyamide
- Standard Color: x3 - Green

Temperature

- Temperature Range:
14°F to 158°F (-10°C to 70°C)

Design Factor

- 2.5

Certifications

- DIN EN1829-2 compliant

Notes

- TC Tough Cover offers improved abrasion resistance over the standard.

[Visit the webpage](#)

Part Number	Nominal I.D.				Max. O.D.		Max. Working Pressure		Min. Bend Radius		Weight		Fitting Series
	DN	Size	inch	mm	inch	mm	psi	bar	inch	mm	lbs./ft.	kg/mtr	
2240D-04V33-TC	6	-04	1/4	6.4	0.46	11.6	15,950	1,100	4.33	110	0.13	0.20	TX

101TX - NPT Male

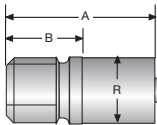

Part Number	Nominal I.D.				Thread Size	Overall Length A		Cutoff Allow. B		Diameter R		Max. Working Pressure	
	DN	Size	inch	mm		inch	mm	inch	mm	inch	mm	psi	bar
101TX-4-04-PL	6	-04	1/4	6.4	1/4" - 18	1.30	33	0.63	16	0.54	13.6	15,000	1,034

Carbon Steel, Zinc-plated

1AYTX - Type "M" Swivel - Female

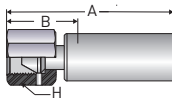

Part Number	Nominal I.D.				Thread Size	Overall Length A		Cutoff Allow. B		Diameter R		H Hex	
	DN	Size	inch	mm		inch	mm	inch	mm	inch	mm	inch	mm
1AYTX-6-04W	6	-04	1/4	6.4	9/16" - 18	1.03	26	1.18	30	0.54	13.6	0.75	19

Carbon Steel, Zinc-plated

Accessories Part Numbers

Bend Restrictor

MBR008

Technical details available in Section D.



WARNING

This product can expose you to chemicals including Lead, which is known to the State of California to cause cancer and birth defects or other reproductive harm. For more information go to www.P65Warnings.ca.gov.

3/16" - 15,000 psi High Pressure Flex Lance Hose

2245D-03V33
15K5MM



Construction

- Core Tube: Polyoxymethylene
- Pressure Reinforcement: Two spiral layers of high tensile steel wire and one braided layer of steel wire
- Cover: Polyamide
- Standard Color: x3 - Green

Temperature

- Temperature Range:
14°F to 158°F (-10°C to 70°C)

Certifications

- DIN EN1829-2 compliant

Design Factor

- 2.7

[Visit the webpage](#)

Part Number	Nominal I.D.				Max. O.D.		Max. Working Pressure		Min. Bend Radius		Weight		Fitting Series
	DN	Size	inch	mm	inch	mm	psi	bar	inch	mm	lbs./ft.	kg/mtr	
2245D-03V33	5	-03	3/16	4.8	0.42	10.7	15,000	1,034	3.74	95	0.14	0.21	AX

601AX - NPT Male

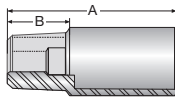

Part Number	Nominal I.D.				Thread Size	Overall Length A		Cutoff Allow. B		Diameter	
	DN	Size	inch	mm		inch	mm	inch	mm	inch	mm
601AX-2-3	5	-03	3/16	4.8	1/8"-27	1.28	33	0.50	13	0.50	13

Carbon Steel

6AYAX - Type "M" Swivel - Female

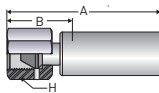

Part Number	Nominal I.D.				Thread Size	Overall Length A		Cutoff Allow. B		H Hex	
	DN	Size	inch	mm		inch	mm	inch	mm	inch	mm
6AYAX-6-3C	5	-03	3/16	4.8	9/16" - 18	1.77	45	0.94	24	0.75	19

C - Stainless Steel



WARNING

This product can expose you to chemicals including Lead, which is known to the State of California to cause cancer and birth defects or other reproductive harm. For more information go to www.P65Warnings.ca.gov.

5/32" - 21,750 psi High Pressure Flex Lance Hose

2248D-025V32-TC
21K4MM



Construction

- Core Tube: Polyoxymethylene
- Pressure Reinforcement: Two spiral layers of maximum tensile steel wire
- Cover: Polyamide
- Standard Color: x2 - Blue

Temperature

- Temperature Range: 14°F to 158°F (-10°C to 70°C)

Design Factor

- 2.5

Certifications

- DIN EN1829-2 compliant

Notes

- TC Tough Cover offers improved abrasion resistance over the standard.

[Visit the webpage](#)

Part Number	Nominal I.D.				Max. O.D.		Max. Working Pressure		Min. Bend Radius		Weight		Fitting Series
	DN	Size	inch	mm	inch	mm	psi	bar	inch	mm	lbs./ft.	kg/mtr	
2248D-025V32-TC	4	-025	5/32	4.0	0.31	7.9	21,750	1,500	2.95	75	0.07	0.11	TX

1YHTX - Waterblast Nozzle - Male

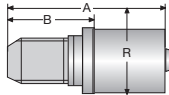

Part Number	Nominal I.D.				Thread Size	Overall Length A		Cutoff Allow. B		Diameter R		Wrench Flat	
	DN	Size	inch	mm		inch	mm	inch	mm	inch	mm	inch	mm
1YHTX-4-025-PL	4	-025	5/32	4.0	1/4" - 28	1.56	40	0.95	24	0.39	10	0.32	8

Carbon Steel, Zinc-plated

1AYTX - Type "M" Swivel - Female

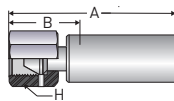

Part Number	Nominal I.D.				Thread Size	Overall Length A		Cutoff Allow. B		H Hex	
	DN	Size	inch	mm		inch	mm	inch	mm	inch	mm
1AYTX-6-025W	4	-025	5/32	4.0	9/16" - 18	1.99	51	1.10	28	0.75	19

Carbon Steel, Zinc-plated

WARNING

This product can expose you to chemicals including Lead, which is known to the State of California to cause cancer and birth defects or other reproductive harm. For more information go to www.P65Warnings.ca.gov.

3/16" - 20,300 psi High Pressure Flex Lance Hose

2248D-03V32-TC
20K5MM



Construction

- Core Tube: Polyoxymethylene
- Pressure Reinforcement: Two spiral layers of maximum tensile steel wire
- Cover: Polyamide
- Standard Color: x2 - Blue

Temperature

- Temperature Range:
14°F to 158°F (-10°C to 70°C)

Certifications

- DIN EN1829-2 compliant

Design Factor

- 2.5

Notes

- TC Tough Cover offers improved abrasion resistance over the standard.

[Visit the webpage](#)

Part Number	Nominal I.D.		Max. O.D.	Max. Working Pressure		Min. Bend Radius		Weight		Fitting Series			
	DN	Size		inch	mm	psi	bar	inch	mm		lbs./ft.	kg/mtr	
2248D-03V32-TC	5	-03	3/16	4.8	0.37	9.5	20,300	1,400	3.74	95	0.09	0.14	TX

1YHTX - Waterblast Nozzle - Male

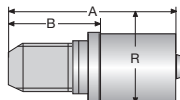

Part Number	Nominal I.D.		Thread Size	Overall Length A		Cutoff Allow. B		Diameter R		Wrench Flat			
	DN	Size		inch	mm	inch	mm	inch	mm	inch	mm		
1YHTX-6-03-PL	5	-03	3/16	4.8	3/8" - 24	1.34	34	0.74	19	0.47	12	0.35	9

Carbon Steel, Zinc-plated

1AYTX - Type "M" Swivel - Female

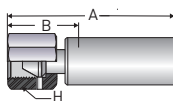

Part Number	Nominal I.D.		Thread Size	Overall Length A		Cutoff Allow. B		H Hex			
	DN	Size		inch	mm	inch	mm	inch	mm		
1AYTX-6-03W	5	-03	3/16	4.8	9/16" - 18	2.20	56	1.14	29	0.75	19

Carbon Steel, Zinc-plated



WARNING

This product can expose you to chemicals including Lead, which is known to the State of California to cause cancer and birth defects or other reproductive harm. For more information go to www.P65Warnings.ca.gov.

5/16" - 15,000 psi High Pressure Flex Lance Hose

2248D-05V33-TC
15K8MM-TC



Construction

- Core Tube: Polyoxymethylene
- Pressure Reinforcement: Two spiral layers of maximum tensile steel wire
- Cover: Polyamide
- Standard Color: x3 - Green

Temperature

- Temperature Range: 14°F to 158°F (-10°C to 70°C)

Design Factor

- 2.5

Certifications

- DIN EN1829-2 compliant

Notes

- TC Tough Cover offers improved abrasion resistance over the standard.

[Visit the webpage](#)

Part Number	Nominal I.D.				Max. O.D.		Max. Working Pressure		Min. Bend Radius		Weight		Fitting Series
	DN	Size	inch	mm	inch	mm	psi	bar	inch	mm	lbs./ft.	kg/mtr	
2248D-05V33-TC	8	-05	5/16	7.9	0.53	13.5	15,000	1,034	4.72	120	0.17	0.25	TX

101TX - NPT Male

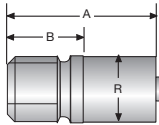

Part Number	Nominal I.D.				Thread Size	Overall Length A		Cutoff Allow. B		Diameter R	
	DN	Size	inch	mm		inch	mm	inch	mm	inch	mm
101TX-4-05-PL	8	-05	5/16	7.9	1/4" - 18	1.42	36	0.55	14	0.64	16
101TX-6-05-PL					3/8" - 18	1.48	38	0.62	16		

Carbon Steel, Zinc-plated

1AYTX - Type "M" Swivel - Female

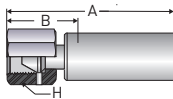

Part Number	Nominal I.D.				Thread Size	Overall Length A		Cutoff Allow. B		H Hex	
	DN	Size	inch	mm		inch	mm	inch	mm	inch	mm
1AYTX-8-05W	8	-05	5/16	7.9	3/4" - 16	2.83	72	1.53	39	1.06	27

Carbon Steel, Zinc-plated

WARNING

This product can expose you to chemicals including Lead, which is known to the State of California to cause cancer and birth defects or other reproductive harm. For more information go to www.P65Warnings.ca.gov.

1/4" - 13,200 psi High Pressure Tube Cleaning Hose

2380N-04V66
13K6MM



Construction

- Core Tube: Polyamide 12
- Pressure Reinforcement: Two closed spiral layers and two open spiral layers of high tensile steel wire
- Cover: Polyamide
- Standard Color: x6 - Yellow

Temperature

- Temperature Range:
-40°F to 158°F (-40°C to 70°C)

Design Factor

- 2.5

Certifications

- DIN EN1829-2 compliant

[Visit the webpage](#)

Part Number	Nominal I.D.				Max. O.D.		Max. Working Pressure		Min. Bend Radius		Weight		Fitting Series
	DN	Size	inch	mm	inch	mm	psi	bar	inch	mm	lbs./ft.	kg/mtr	
2380N-04V66	6	-04	1/4	6.4	0.53	13.4	13,200	910	1.58	40	0.2	0.3	NX

601NX - NPT Male - Prolance

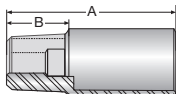

Part Number	Nominal I.D.				Thread Size	Overall Length A		Cutoff Allow. B	
	DN	Size	inch	mm		inch	mm	inch	mm
601NX-4-4	6	-04	1/4	6.4	1/4" - 18	1.56	40	1.35	34

Carbon Steel C - Stainless Steel

606NX - JIC 37° Female Flare

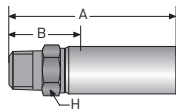

Part Number	Nominal I.D.				Thread Size	Overall Length A		Cutoff Allow. B		H Hex		Max. Working Pressure	
	DN	Size	inch	mm		inch	mm	inch	mm	inch	mm	psi	bar
606NX-4-4C	6	-04	1/4	6.4	7/16" - 20	2.23	57	0.99	25	0.63	16	10,000	690
606NX-6-4C					9/16" - 18	2.36	60	1.11	28	0.68	17		

C - Stainless Steel

6AYNX - Type "M" Swivel - Female

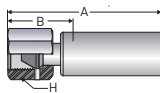

Part Number	Nominal I.D.				Thread Size	Overall Length A		Cutoff Allow. B		H Hex	
	DN	Size	inch	mm		inch	mm	inch	mm	inch	mm
6AYNX-6-4C	6	-04	1/4	6.4	9/16" - 18	2.36	60	1.11	28	0.68	17

C - Stainless Steel

Accessories Part Numbers

Support Grips	Heavy Duty Abrasion Cover	Transition Sleeve
MCGHS10-15	MHDC010	508-J-500-10

Technical details available in Section D.



WARNING

This product can expose you to chemicals including Lead, which is known to the State of California to cause cancer and birth defects or other reproductive harm. For more information go to www.P65Warnings.ca.gov.

5/16" - 15,000 psi High Pressure Tube Cleaning Hose

2380N-05V03W
15K8MM



Construction

- Core Tube: Polyamide 12
- Pressure Reinforcement: Two closed spiral layers and two open spiral layers of high tensile steel wire
- Cover: Polyamide
- Standard Color: x3 - Green

Temperature

- Temperature Range:
14°F to 158°F (-10°C to 70°C)

Design Factor

- 2.5

Certifications

- DIN EN1829-2 compliant

[Visit the webpage](#)

Part Number	Nominal I.D.				Max. O.D.		Max. Working Pressure		Min. Bend Radius		Weight		Fitting Series
	DN	Size	inch	mm	inch	mm	psi	bar	inch	mm	lbs./ft.	kg/mtr	
2380N-05V03W	8	-05	5/16	7.9	0.62	15.8	15,000	1,034	3.54	90	0.24	0.35	KY

101KY - NPT Male

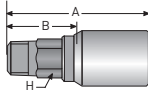

Part Number	Nominal I.D.				Thread Size	Overall Length A		Cutoff Allow. B		H Hex	
	DN	Size	inch	mm		inch	mm	inch	mm	inch	mm
101KY-4-05	8	-05	5/16	7.9	1/4" - 18	2.70	69	1.42	36	0.51	13
101KY-6-05					3/8" - 18			1.38	35	0.68	17

Carbon Steel, Zinc-plated

1AYKY - Type "M" Swivel - Female

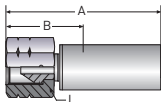

Part Number	Nominal I.D.				Thread Size	Overall Length A		Cutoff Allow. B		J Hex	
	DN	Size	inch	mm		inch	mm	inch	mm	inch	mm
1AYKY-8-05	8	-05	5/16	7.9	3/4" - 16	2.83	72	1.55	39	1.06	27

Carbon Steel, Zinc-plated C - Stainless Steel

Accessories Part Numbers

Support Grips	Heavy Duty Abrasion Cover	Transition Sleeve	Bend Restrictor	Hose Stop
MCGHS10-15	MHDC012	510-A-500-12	MBR012	AH-06S

Technical details available in Section D.



WARNING

This product can expose you to chemicals including Lead, which is known to the State of California to cause cancer and birth defects or other reproductive harm. For more information go to www.P65Warnings.ca.gov.

1/4" - 18,560 psi High Pressure Waterblast Hose

2388N-04V13W
18K6MM



Construction

- Core Tube: Polyamide 12
- Pressure Reinforcement: Two closed spiral layers and two open spiral layers of high tensile steel wire
- Cover: Polyurethane
- Standard Color: x3 - Green

Temperature

- Temperature Range: 14°F to 158°F (-10°C to 70°C)

Design Factor

- 2.5

Certifications

- DIN EN1829-2 compliant

[Visit the webpage](#)

Part Number	Nominal I.D.				Max. O.D.		Max. Working Pressure		Min. Bend Radius		Weight		Fitting Series
	DN	Size	inch	mm	inch	mm	psi	bar	inch	mm	lbs./ft.	kg/mtr	
2388N-04V13W	6	-04	1/4	6.4	0.53	13.4	18,560	1,280	1.58	40	0.2	0.3	KY

101KY - NPT Male

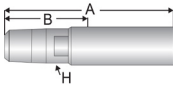

Part Number	Nominal I.D.				Thread Size	Overall Length A		Cutoff Allow. B		H Hex		Max. Working Pressure	
	DN	Size	inch	mm		inch	mm	inch	mm	inch	mm	psi	bar
101KY-4-04	6	-04	1/4	6.4	1/4" - 18	2.22	56	1.14	29	0.39	10	15,000	1,034

Carbon Steel

1AYKY - Type "M" Swivel - Female

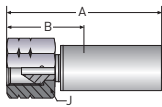

Part Number	Nominal I.D.				Thread Size	Overall Length A		Cutoff Allow. B		J Hex	
	DN	Size	inch	mm		inch	mm	inch	mm	inch	mm
1AYKY-6-04C	6	-04	1/4	6.4	9/16" - 18	2.26	57	1.19	30	0.75	19

C - Stainless Steel

Accessories Part Numbers

Heavy Duty Abrasion Cover	Transition Sleeve
MHDC012	510-A-500-12

Technical details available in Section D.

WARNING

This product can expose you to chemicals including Lead, which is known to the State of California to cause cancer and birth defects or other reproductive harm. For more information go to www.P65Warnings.ca.gov.

1/2" - 15,950 psi Waterblast Hose

2388N-08V13
15K13MM



Construction

- Core Tube: Polyamide 12
- Pressure Reinforcement: Two closed spiral layers and two open spiral layers of high tensile steel wire
- Cover: Polyurethane
- Standard Color: x3 - Green

Temperature

- Temperature Range:
14°F to 158°F (-10°C to 70°C)

Design Factor

- 2.5

[Visit the webpage](#)

Part Number	Nominal I.D.				Max. O.D.		Max. Working Pressure		Min. Bend Radius		Weight		Fitting Series
	DN	Size	inch	mm	inch	mm	psi	bar	inch	mm	lbs./ft.	kg/mtr	
2388N-08V13	13	-08	1/2	12.7	0.91	23.1	15,950	1,100	4.72	120	0.54	0.80	BS

101BS - NPT Male

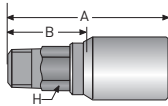

Part Number	Nominal I.D.				Thread Size	Overall Length A		Cutoff Allow. B		H Hex		Max. Working Pressure	
	DN	Size	inch	mm		inch	mm	inch	mm	inch	mm	psi	bar
101BS-8-08	13	-08	1/2	12.7	1/2" - 14	3.66	93	1.56	40	0.87	22	15,000	1,034
101BS-8-08C													

Carbon Steel, Zinc-plated C - All components Stainless Steel

1C9BS - Metric Swivel - Female

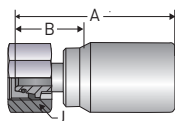

Part Number	Nominal I.D.				Thread Size	Overall Length A		Cutoff Allow. B		J Hex	
	DN	Size	inch	mm		inch	mm	inch	mm	inch	mm
1C9BS-16-08C	13	-08	1/2	12.7	M 24 x 1.5	3.50	89	1.43	36	1.18	30

C - All components Stainless Steel

1AYBS - Type "M" Swivel - Female

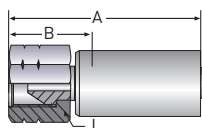

Part Number	Nominal I.D.				Thread Size	Overall Length A		Cutoff Allow. B		J Hex	
	DN	Size	inch	mm		inch	mm	inch	mm	inch	mm
1AYBS-11-08	13	-08	1/2	12.7	1" - 12	3.43	87	1.77	45	1.25	32
1AYBS-11-08C											

Carbon Steel, Zinc-plated C - All components Stainless Steel

⚠ WARNING

This product can expose you to chemicals including Lead, which is known to the State of California to cause cancer and birth defects or other reproductive harm. For more information go to www.P65Warnings.ca.gov.

1/8" - 30,000 psi Ultra High Pressure Flex Lance Hose

2440D-02V37-TC
30K3MM



Construction

- Core Tube: Polyoxymethylene
- Pressure Reinforcement: Four spiral layers of maximum tensile steel wire
- Cover: Polyamide
- Standard Color: x7 - Gray

Temperature

- Temperature Range:
14°F to 158°F (-10°C to 70°C)

Design Factor

- 2.5

Certifications

- DIN EN1829-2 compliant

Notes

- TC Tough Cover offers improved abrasion resistance over the standard.

[Visit the webpage](#)

Part Number	Nominal I.D.				Max. O.D.		Max. Working Pressure		Min. Bend Radius		Weight		Fitting Series
	DN	Size	inch	mm	inch	mm	psi	bar	inch	mm	lbs./ft.	kg/mtr	
2440D-02V37-TC	3	-02	1/8	3.2	0.31	7.9	30,000	2,070	3.94	100	0.08	0.12	LX

6YHLX - Waterblast Nozzle Male - Prolance

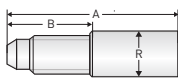

Part Number	Nominal I.D.				Thread Size	Overall Length A		Cutoff Allow. B		Diameter R	
	DN	Size	inch	mm		inch	mm	inch	mm	inch	mm
6YHLX-4-02-PL	3	-2	1/8	3.2	1/4" - 28	2.06	52.2	1.15	29.2	.39	9.8

Carbon Steel, Zinc-plated

1Y4LX - High Pressure Male

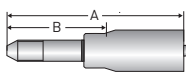

Part Number	Nominal I.D.				Thread Size	Overall Length A		Cutoff Allow. B	
	DN	Size	inch	mm		inch	mm	inch	mm
1Y4LX-4-02	3	-2	1/8	3.2	1/4" - 28 LH	2.47	63	1.57	40

Carbon Steel, Zinc-plated

1AYLX - Type "M" Swivel - Female

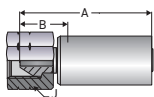

Part Number	Nominal I.D.				Thread Size	Overall Length A		Cutoff Allow. B		J Hex	
	DN	Size	inch	mm		inch	mm	inch	mm	inch	mm
1AYLX-6-02	3	-02	1/8	3.2	9/16" - 18	2.19	56	1.29	33	0.87	22

Carbon Steel, Zinc-plated



WARNING

This product can expose you to chemicals including Lead, which is known to the State of California to cause cancer and birth defects or other reproductive harm. For more information go to www.P65Warnings.ca.gov.

5/32" - 31,900 psi Ultra High Pressure Flex Lance Hose

2440D-025V37-TC
31K4MM



Construction

- Core Tube: Polyoxymethylene
- Pressure Reinforcement: Four spiral layers of maximum tensile steel wire
- Cover: Polyamide
- Standard Color: x7 - Gray

Temperature

- Temperature Range: 14°F to 158°F (-10°C to 70°C)

Certifications

- DIN EN1829-2 compliant

Design Factor

- 2.5

Notes

- TC Tough Cover offers improved abrasion resistance over the standard.

[Visit the webpage](#)

Part Number	Nominal I.D.		Max. O.D.		Max. Working Pressure		Min. Bend Radius		Weight		Fitting Series		
	DN	Size	inch	mm	inch	mm	psi	bar	inch	mm		lbs./ft.	kg/mtr
2440D-025V37-TC	4	-025	5/32	4	0.41	10.5	31,900	2,200	3.94	100	0.14	0.21	LX

6HYLX - Waterblast Nozzle Female - Prolance

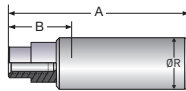

Part Number	Nominal I.D.		Thread Size	Overall Length A		Cutoff Allow. B		Diameter R			
	DN	Size		inch	mm	inch	mm	inch	mm		
6HYLX-4-2AC-PL	4	-025	5/32	4.0	1/4" - 28 UNF	1.97	50	0.72	18	0.46	11.7

C - Stainless Steel

6YHLX - Waterblast Nozzle Male - Prolance

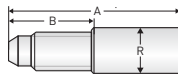

Part Number	Nominal I.D.		Thread Size	Overall Length A		Cutoff Allow. B		Diameter R			
	DN	Size		inch	mm	inch	mm	inch	mm		
6YHLX-4-2AC-PL	4	-025	5/32	4.0	1/4" - 28 UNF	2.25	57	1.01	26	0.46	11.7
6YHLX-4-2AC-PL-LH					1/4" - 28 UNF LH						

C - Stainless Steel

6Y4LX - High Pressure Male

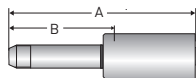

Part Number	Nominal I.D.		Thread Size	Overall Length A		Cutoff Allow. B			
	DN	Size		inch	mm	inch	mm		
6Y4LX-4-2AC	4	-025	5/32	4.0	1/4" - 28 LH	2.96	75	1.71	43
6Y4LX-6-2AC					3/8" - 24 LH				

C - Stainless Steel

6AYLX - Type "M" Swivel - Female

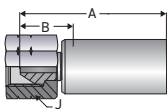

Part Number	Nominal I.D.		Thread Size	Overall Length A		Cutoff Allow. B		J Hex			
	DN	Size		inch	mm	inch	mm	inch	mm		
6AYLX-6-2AC	4	-025	5/32	4.0	9/16" - 18	2.51	64	1.28	33	0.68	17

C - Stainless Steel

Accessories Part Numbers

Hose Stop

AH-04S

Technical details available in Section D.



WARNING

This product can expose you to chemicals including Lead, which is known to the State of California to cause cancer and birth defects or other reproductive harm. For more information go to www.P65Warnings.ca.gov.

3/16" - 26,100 psi Ultra High Pressure Flex Lance Hose

2440D-03V32-TC
26K5MM

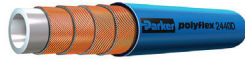

Construction

- Core Tube: Polyoxymethylene
- Pressure Reinforcement: Four spiral layers of maximum tensile steel wire
- Cover: Polyamide
- Standard Color: x2 - Blue

Temperature

- Temperature Range:
14°F to 158°F (-10°C to 70°C)

Certifications

- DIN EN1829-2 compliant

Design Factor

- 2.5

Notes

- TC Tough Cover offers improved abrasion resistance over the standard.

[Visit the webpage](#)

Part Number	Nominal I.D.		Max. O.D.	Max. Working Pressure	Min. Bend Radius		Weight		Fitting Series				
	DN	Size			inch	mm	inch	mm		lbs./ft.	kg/mtr		
2440D-03V32-TC	5	-03	3/16	4.8	0.45	11.5	26,100	1,800	5.12	130	0.19	0.28	LX

6HYLX - Waterblast Nozzle Female - Prolance

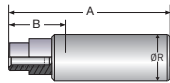

Part Number	Nominal I.D.		Thread Size	Overall Length A		Cutoff Allow. B		Diameter R			
	DN	Size		inch	mm	inch	mm	inch	mm		
6HYLX-4-3C-PL	5	-03	3/16	4.8	1/4" - 28 UNF	1.94	49	0.72	18	0.49	12.5
6HYLX-6-3C-PL					3/8" - 24 UNF	2.09	53	0.87	22	0.49	12.5

C - Stainless Steel

6YHLX - Waterblast Nozzle Male - Prolance

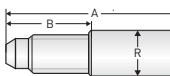

Part Number	Nominal I.D.		Thread Size	Overall Length A		Cutoff Allow. B		Diameter R				
	DN	Size		inch	mm	inch	mm	inch	mm			
6YHLX-4-3C-PL	5	-03	3/16	4.8	1/4" - 28 UNF		2.32	59	1.13	29	0.49	12.5
6YHLX-4-3C-PL-LH					1/4" - 28 UNF LH							
6YHLX-6-3C-PL					3/8" - 24 UNF		2.46	63	1.24	32		
6YHLX-6-3C-PL-LH					3/8" - 24 UNF LH							

C - Stainless Steel

16YLX - High Pressure Female Swivel

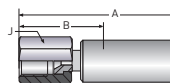

Part Number	Nominal I.D.		Thread Size	Overall Length A		Cutoff Allow. B		J Hex			
	DN	Size		inch	mm	inch	mm	inch	mm		
16YLX-4-03C	5	-03	3/16	4.8	9/16" - 18 UNF	3.37	85	1.77	45	.87	22

C - Stainless Steel

[continued on next page](#)

WARNING

This product can expose you to chemicals including Lead, which is known to the State of California to cause cancer and birth defects or other reproductive harm. For more information go to www.P65Warnings.ca.gov.

3/16" - 26,100 psi Ultra High Pressure Flex Lance Hose

2440D-03V32-TC

26K5MM

1Y4LX - High Pressure Male

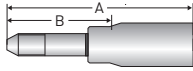

Part Number	Nominal I.D.				Thread Size	Overall Length A		Cutoff Allow. B	
	DN	Size	inch	mm		inch	mm	inch	mm
1Y4LX-6-03C	5	-03	3/16	4.8	3/8" - 24 UNF LH	3.90	99	2.25	57
1Y4LX-9-03C					9/16" - 18 UNF LH	4.25	108	3.10	78

C - Stainless Steel

1AYLX - Type "M" Swivel - Female

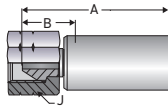

Part Number	Nominal I.D.				Thread Size	Overall Length A		Cutoff Allow. B		J Hex	
	DN	Size	inch	mm		inch	mm	inch	mm	inch	mm
1AYLX-6-03	5	-03	3/16	4.8	9/16" - 18	2.95	74.5	1.32	33.5	0.86	22
1AYLX-6-03C											

C - Stainless Steel

Accessories Part Numbers

Hose Stop	Crimp Sleeve	Spring Guard
AH-05S	508-J-500-10	MSG060

Technical details available in Section D.



WARNING

This product can expose you to chemicals including Lead, which is known to the State of California to cause cancer and birth defects or other reproductive harm. For more information go to www.P65Warnings.ca.gov.

1/4" - 23,780 psi Ultra High Pressure Flex Lance Hose

2440D-04V32-TC
23K6MM



Construction

- Core Tube: Polyoxymethylene
- Pressure Reinforcement: Four spiral layers of maximum tensile steel wire
- Cover: Polyamide
- Standard Color: x2 - Blue

Temperature

- Temperature Range:
14°F to 158°F (-10°C to 70°C)

Certifications

- DIN EN1829-2 compliant

Design Factor

- 2.5

Notes

- TC Tough Cover offers improved abrasion resistance over the standard.

[Visit the webpage](#)

Part Number	Nominal I.D.				Max. O.D.		Max. Working Pressure		Min. Bend Radius		Weight		Fitting Series
	DN	Size	inch	mm	inch	mm	psi	bar	inch	mm	lbs./ft.	kg/mtr	
2440D-04V32-TC	6	-04	1/4	6.4	0.49	12.5	23,780	1,640	6.10	155	0.22	0.33	LX

6HYLX - Waterblast Nozzle Female - Prolance

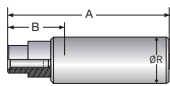

Part Number	Nominal I.D.				Thread Size	Overall Length A		Cutoff Allow. B		Diameter R	
	DN	Size	inch	mm		inch	mm	inch	mm	inch	mm
6HYLX-6-4C-PL	6	-04	1/4	6.4	3/8" - 24 UNF	2.15	55	0.70	18	0.59	15

C - Stainless Steel

6YHLX - Waterblast Nozzle Male - Prolance

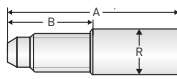

Part Number	Nominal I.D.				Thread Size	Overall Length A		Cutoff Allow. B		Diameter R	
	DN	Size	inch	mm		inch	mm	inch	mm	inch	mm
6YHLX-6-4C-PL	6	-04	1/4	6.4	3/8" - 24 UNF	2.60	66	1.42	36	0.59	15
6YHLX-6-4C-PL-LH					3/8" - 24 UNF LH						

C - Stainless Steel

1Y4LX - High Pressure Male

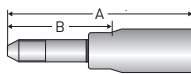

Part Number	Nominal I.D.				Thread Size	Overall Length A		Cutoff Allow. B	
	DN	Size	inch	mm		inch	mm	inch	mm
1Y4LX-6-04	6	-04	1/4	6.4	3/8" - 24 UNF LH	4.02	102	2.28	56

Carbon Steel, Zinc-plated

1AYLX - Type "M" Swivel - Female

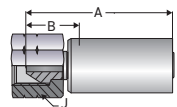

Part Number	Nominal I.D.				Thread Size	Overall Length A		Cutoff Allow. B		J Hex	
	DN	Size	inch	mm		inch	mm	inch	mm	inch	mm
1AYLX-6-04	6	-04	1/4	6.4	9/16" - 18	3.11	79	1.34	34	0.87	22
1AYLX-6-04C											

Carbon Steel, Zinc-plated C - Stainless Steel

Accessories Part Numbers

Heavy Duty Abrasion Cover	Transition Sleeve	Hose Stop
MHDC010	508-J-500-10	AH-05S

Technical details available in Section D.

WARNING

This product can expose you to chemicals including Lead, which is known to the State of California to cause cancer and birth defects or other reproductive harm. For more information go to www.P65Warnings.ca.gov.

5/16" - 21,750 psi Ultra High Pressure Flex Lance Hose

2440D-05V32-TC
21K8MM



Construction

- Core Tube: Polyoxymethylene
- Pressure Reinforcement: Four spiral layers of maximum tensile steel wire
- Cover: Polyamide
- Standard Color: x2 - Blue

Temperature

- Temperature Range: 14°F to 158°F (-10°C to 70°C)

Certifications

- DIN EN1829-2 compliant

Design Factor

- 2.5

Notes

- TC Tough Cover offers improved abrasion resistance over the standard.

[Visit the webpage](#)

Part Number	Nominal I.D.				Max. O.D.		Max. Working Pressure		Min. Bend Radius		Weight		Fitting Series
	DN	Size	inch	mm	inch	mm	psi	bar	inch	mm	lbs./ft.	kg/mtr	
2440D-05V32-TC	8	-05	5/16	7.9	0.59	15.1	21,750	1,500	6.89	175	0.30	0.44	LX

6HYLX - Waterblast Nozzle Female - Prolance

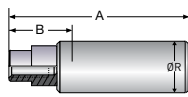

Part Number	Nominal I.D.				Thread Size	Overall Length A		Cutoff Allow. B		Diameter R	
	DN	Size	inch	mm		inch	mm	inch	mm	inch	mm
6HYLX-9-5C-PL	8	-05	5/16	7.9	9/16" - 18 UNF	2.64	67	1.037	26	0.67	17
6HYLX-9-5C-PL-LH					9/16" - 18 UNF LH	2.83	72				

C - Stainless Steel

6YHLX - Waterblast Nozzle Male - Prolance

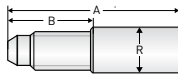

Part Number	Nominal I.D.				Thread Size	Overall Length A		Cutoff Allow. B		Diameter R	
	DN	Size	inch	mm		inch	mm	inch	mm	inch	mm
6YHLX-9-5C-PL	8	-05	5/16	7.9	9/16" - 18 UNF	3.11	79	1.51	38	0.67	17
6YHLX-9-5C-PL-LH					9/16" - 18 UNF LH						

C - Stainless Steel

6Y2LX - Medium Pressure Male

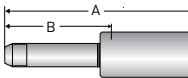

Part Number	Nominal I.D.				Thread Size	Overall Length A		Cutoff Allow. B		Max. Working Pressure	
	DN	Size	inch	mm		inch	mm	inch	mm	psi	bar
6Y2LX-9-5C	8	-05	5/16	7.9	9/16" - 18 LH	4.15	105	2.36	60	20,000	1,380

C - Stainless Steel

6AYLX - Type "M" Swivel - Female

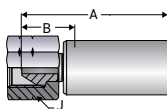

Part Number	Nominal I.D.				Thread Size	Overall Length A		Cutoff Allow. B		J Hex	
	DN	Size	inch	mm		inch	mm	inch	mm	inch	mm
6AYLX-8-5C	8	-05	5/16	7.9	3/4" - 16 UNF	2.95	75	1.25	32	1.00	25

C - Stainless Steel

Accessories Part Numbers

Heavy Duty Abrasion Cover	Transition Sleeve	Pressure Containment Shield & Sleeves	Hose Stop
PVC-BLUE-012	510-A-500-12	MHBS012 412-400	AH-06S

Technical details available in Section D.



WARNING

This product can expose you to chemicals including Lead, which is known to the State of California to cause cancer and birth defects or other reproductive harm. For more information go to www.P65Warnings.ca.gov.

1/4" - 20,300 psi Ultra High Pressure Water Jetting Hose

2440N-04V32
20K6MM



Construction

- Core Tube: Polyamide 12
- Pressure Reinforcement: Four spiral layers of maximum tensile steel wire
- Cover: Polyamide
- Standard Color: x2 - Blue

Temperature

- Temperature Range:
-40°F to 158°F (-40°C to 70°C)

Design Factor

- 2.5

Certifications

- DIN EN1829-2 compliant

[Visit the webpage](#)

Part Number	Nominal I.D.				Max. O.D.		Max. Working Pressure		Min. Bend Radius		Weight		Fitting Series
	DN	Size	inch	mm	inch	mm	psi	bar	inch	mm	lbs./ft.	kg/mtr	
2440N-04V32	6	-04	1/4	6.4	0.51	13	20,300	1,400	6.1	155	0.21	0.31	LX

6YHLX - Waterblast Nozzle Male - Prolance

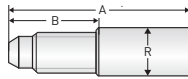

Part Number	Nominal I.D.				Thread Size	Overall Length A		Cutoff Allow. B		Diameter R	
	DN	Size	inch	mm		inch	mm	inch	mm	inch	mm
6YHLX-6-4C-PL	6	-04	1/4	6.4	3/8" - 24 UNF	2.60	66	1.42	36	0.59	15
6YHLX-6-4C-PL-LH					3/8" - 24 UNF LH						

C - Stainless Steel

65YLX - Medium Pressure Female Swivel

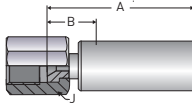

Part Number	Nominal I.D.				Thread Size	Overall Length A		Cutoff Allow. B		J Hex	Max. Working Pressure		
	DN	Size	inch	mm		inch	mm	inch	mm		psi	bar	
65YLX-6-4C	6	-04	1/4	6.4	9/16" - 18 UNF	2.83	72	1.54	39	0.75	19	20,000	1,380

C - Stainless Steel

6AYLX - Type "M" Swivel - Female

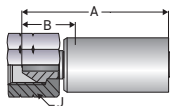

Part Number	Nominal I.D.				Thread Size	Overall Length A		Cutoff Allow. B		J Hex	
	DN	Size	inch	mm		inch	mm	inch	mm	inch	mm
6AYLX-6-4	6	-04	1/4	6.4	9/16" - 18	2.69	68	1.39	35	0.68	17
6AYLX-6-4C											

Carbon Steel, Zinc-plated C - Stainless Steel

Accessories Part Numbers

Heavy Duty Abrasion Cover	Transition Sleeve	Spring Guard
PVC-BLUE-012	510-A-500-12	MSG060 508-J-500-10

Technical details available in Section D.

WARNING

This product can expose you to chemicals including Lead, which is known to the State of California to cause cancer and birth defects or other reproductive harm. For more information go to www.P65Warnings.ca.gov.

3/8" - 20,300 psi Ultra High Pressure Water Jetting Hose

2440N-06V32
20K10MM



Construction

- Core Tube: Polyamide 12
- Pressure Reinforcement: Four spiral layers of maximum tensile steel wire
- Cover: Polyamide
- Standard Color: x2 - Blue

Temperature

- Temperature Range:
14°F to 158°F (-10°C to 70°C)

Design Factor

- 2.5

Certifications

- DIN EN1829-2 compliant

[Visit the webpage](#)

Part Number	Nominal I.D.				Max. O.D.		Max. Working Pressure		Min. Bend Radius		Weight		Fitting Series
	DN	Size	inch	mm	inch	mm	psi	bar	inch	mm	lbs./ft.	kg/mtr	
2440N-06V32	10	-06	3/8	9.5	0.77	19.5	20,300	1,400	7	190	0.49	0.73	LX

1Y2LX - Medium Pressure Male

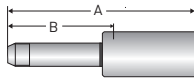

Part Number	Nominal I.D.				Thread Size	Overall Length A		Cutoff Allow. B		Max. Working Pressure	
	DN	Size	inch	mm		inch	mm	inch	mm	psi	bar
1Y2LX-9-06C	10	-06	3/8	9.5	9/16" - 18	5.39	137	3.58	91	20,000	1,380

C - Stainless Steel

1C9LX - Metric Swivel - Female

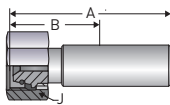

Part Number	Nominal I.D.				Thread Size	Overall Length A		Cutoff Allow. B		J Hex	
	DN	Size	inch	mm		inch	mm	inch	mm	inch	mm
1C9LX-12-06	10	-06	3/8	9.5	M20 X 1.5	3.00	76	1.18	30	1.81	46

Carbon Steel

1AYLX - Type "M" Swivel - Female

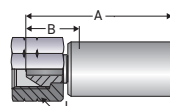

Part Number	Nominal I.D.				Thread Size	Overall Length A		Cutoff Allow. B		J Hex	
	DN	Size	inch	mm		inch	mm	inch	mm	inch	mm
1AYLX-8-06C	10	-06	3/8	9.5	3/4" - 16 UNF	3.10	79	1.32	34	1.060	27

C - Stainless Steel

Accessories Part Numbers

Heavy Duty Abrasion Cover	Transition Sleeve
MHDC016	216-200-18

Technical details available in Section D.

WARNING

This product can expose you to chemicals including Lead, which is known to the State of California to cause cancer and birth defects or other reproductive harm. For more information go to www.P65Warnings.ca.gov.

1/2" - 20,300 psi Ultra High Pressure Water Jetting Hose

2440N-08V3x
20K13MM/ 20K13MMTJ



Built in abrasion resistance eliminates the need for an additional PVC sleeve and it lightens the hose by up to 16%.

Construction

- Core Tube: Polyamide 12
- Pressure Reinforcement: Four spiral layers of maximum tensile steel wire
- Cover: Polyamide or TOUGHJACKET PU
- Standard Color: x2 - Blue

Temperature

- Temperature Range:
14°F to 158°F (-10°C to 70°C)

Design Factor

- 2.5

Certifications

- DIN EN1829-2 compliant

Notes

- Transition Sleeve required on TOUGHJACKET hose assemblies.

[Visit the webpage](#)

Part Number	Nominal I.D.				Max. O.D.		Max. Working Pressure		Min. Bend Radius		Weight		Fitting Series
	DN	Size	inch	mm	inch	mm	psi	bar	inch	mm	lbs./ft.	kg/mtr	
2440N-08V32	13	-08	1/2	12.7	0.89	22.7	20,300	1,400	8	200	0.63	0.94	LX
TOUGHJACKET													
2440N-08V30/12	13	-08	1/2	12.7	1.13	28.6	20,300	1,400	8	200	0.81	1.21	LX

6Y2LX - Medium Pressure Male

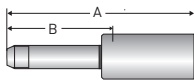

Part Number	Nominal I.D.				Thread Size	Overall Length A		Cutoff Allow. B		Max. Working Pressure	
	DN	Size	inch	mm		inch	mm	inch	mm	psi	bar
6Y2LX-9-8C	13	-08	1/2	12.7	9/16" - 18 LH	4.20	107	2.20	56	20,000	1,380
6Y2LX-12-8C					3/4" - 16 LH	4.13	105	2.08	53		

C - Stainless Steel

6AYLX - Type "M" Swivel - Female

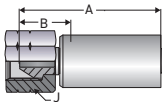

Part Number	Nominal I.D.				Thread Size	Overall Length A		Cutoff Allow. B		J Hex	
	DN	Size	inch	mm		inch	mm	inch	mm	inch	mm
6AYLX-11-8C	13	-08	1/2	12.7	1" - 12	3.53	90	1.50	38	1.25	32

C - Stainless Steel

6C9LX - Metric Swivel - Female

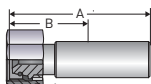

Part Number	Nominal I.D.				Thread Size	Overall Length A		Cutoff Allow. B		J Hex	
	DN	Size	inch	mm		inch	mm	inch	mm	inch	mm
6C9LX-16-8C	13	-08	1/2	12.7	M24 X 1.5	3.48	88	1.44	37	1.26	32

C - Stainless Steel

Accessories Part Numbers - 2440N-08V32

Heavy Duty Abrasion Cover	Transition Sleeve	Support Grips
PVC-BLUE-018	216-200-18	MCGHS20-30

Technical details available in Section D.

Accessories Part Numbers - 2440N-08V32/12

Transition Sleeve	Support Grips
P2529-85AL	MCGHS20-30

Technical details available in Section D.

WARNING

This product can expose you to chemicals including Lead, which is known to the State of California to cause cancer and birth defects or other reproductive harm. For more information go to www.P65Warnings.ca.gov.

3/4" - 14,500 psi Ultra High Pressure Water Jetting Hose

2440N-12V36
14K20MM



Construction

- Core Tube: Polyamide 12
- Pressure Reinforcement: Four spiral layers of maximum tensile steel wire
- Cover: Polyamide
- Standard Color: x6 - Yellow

Temperature

- Temperature Range:
14°F to 158°F (-10°C to 70°C)

Design Factor

- 2.5

Certifications

- DIN EN1829-2 compliant

[Visit the webpage](#)

Part Number	Nominal I.D.				Max. O.D.		Max. Working Pressure		Min. Bend Radius		Weight		Fitting Series
	DN	Size	inch	mm	inch	mm	psi	bar	inch	mm	lbs./ft.	kg/mtr	
2440N-12V36	20	-12	3/4	19.0	1.19	30.2	14,500	1,000	10	250	0.98	1.46	LX

601LX - NPT Male

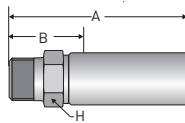

Part Number	Nominal I.D.				Thread Size	Overall Length A		Cutoff Allow. B		H Hex		Max. Working Pressure	
	DN	Size	inch	mm		inch	mm	inch	mm	inch	mm	psi	bar
601LX-12-12C	20	-12	3/4	19	3/4" - 14	4.75	121	2.10	53	1.38	35	10,000	690

C - Stainless Steel

606LX - JIC 37° Female Flare

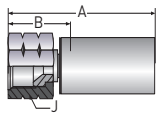

Part Number	Nominal I.D.				Thread Size	Overall Length A		Cutoff Allow. B		J Hex		Max. Working Pressure	
	DN	Size	inch	mm		inch	mm	inch	mm	inch	mm	psi	bar
606LX-16-12C	20	-12	3/4	19	1-5/16" - 12	4.45	113	2.02	51	1.50	38	10,000	690

C - Stainless Steel

6C9LX - Metric Swivel - Female

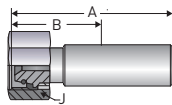

Part Number	Nominal I.D.				Thread Size	Overall Length A		Cutoff Allow. B		J Hex	
	DN	Size	inch	mm		inch	mm	inch	mm	inch	mm
6C9LX-25-12C	20	-12	3/4	19	M 36 x 2	4.26	108	1.58	40	1.81	46

C - Stainless Steel

6AYLX - Type "M" Swivel - Female

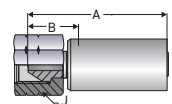

Part Number	Nominal I.D.				Thread Size	Overall Length A		Cutoff Allow. B		J Hex	
	DN	Size	inch	mm		inch	mm	inch	mm	inch	mm
6AYLX-16-12C	20	-12	3/4	19	1-5/16" - 12	4.15	105	1.52	39	1.50	38

C - Stainless Steel

Accessories Part Numbers

Heavy Duty Abrasion Cover	Transition Sleeve	Support Grips
MHDC024	220-200-22	MCGHS30-40

Technical details available in Section D.

⚠ WARNING

This product can expose you to chemicals including Lead, which is known to the State of California to cause cancer and birth defects or other reproductive harm. For more information go to www.P65Warnings.ca.gov.

1" - 13,050 psi Ultra High Pressure Water Jetting Hose

2440N-16V36
13K25MM



Construction

- Core Tube: Polyamide 12
- Pressure Reinforcement: Four spiral layers of maximum tensile steel wire
- Cover: Polyamide
- Standard Color: x6 - Yellow

Temperature

- Temperature Range:
14°F to 158°F (-10°C to 70°C)

Design Factor

- 2.5

Certifications

- DIN EN1829-2 compliant

[Visit the webpage](#)

Part Number	Nominal I.D.		Max. O.D.		Max. Working Pressure		Min. Bend Radius		Weight		Fitting Series		
	DN	Size	inch	mm	inch	mm	psi	bar	inch	mm		lbs./ft.	kg/mtr
2440N-16V36	25	-16	1	25.4	1.46	37.2	13,050	900	12	300	1.34	2	LX

601LX - NPT Male

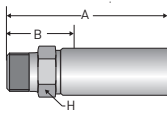

Part Number	Nominal I.D.		Thread Size	Overall Length A		Cutoff Allow. B		H Hex			
	DN	Size		inch	mm	inch	mm	inch	mm		
601LX-16-16C	25	-16	1	25.4	1"- 11-1/2	5.00	125	2.50	64	1.38	35

C - Stainless Steel

606LX - JIC 37° Female Flare

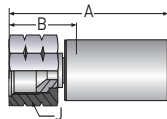

Part Number	Nominal I.D.		Thread Size	Overall Length A		Cutoff Allow. B		J Hex		Max. Working Pressure			
	DN	Size		inch	mm	inch	mm	inch	mm	psi	bar		
606LX-16-16C	25	-16	1	25.4	1-5/16" - 12	3.79	96	1.65	42	1.50	38	10,000	690

C - Stainless Steel

6C9LX - Metric Swivel - Female

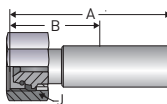

Part Number	Nominal I.D.		Thread Size	Overall Length A		Cutoff Allow. B		J Hex			
	DN	Size		inch	mm	inch	mm	inch	mm		
6C9LX-30-16C	25	-16	1	25.4	M 42 x 2	4.65	118	2.05	52	1.97	50

C - Stainless Steel

6AYLX - Type "M" Swivel - Female

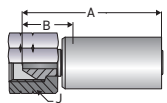

Part Number	Nominal I.D.		Thread Size	Overall Length A		Cutoff Allow. B		J Hex			
	DN	Size		inch	mm	inch	mm	inch	mm		
6AYLX-16-16C	25	-16	1	25.4	1-5/16" - 12	4.45	113	2.02	51	1.50	38

C - Stainless Steel

Accessories Part Numbers

Heavy Duty Abrasion Cover	Transition Sleeve	Support Grips
MHDC026	520-A-500-26	MCGHS30-40

Technical details available in Section D.

WARNING

This product can expose you to chemicals including Lead, which is known to the State of California to cause cancer and birth defects or other reproductive harm. For more information go to www.P65Warnings.ca.gov.

5/32" - 43,645 psi Ultra High Pressure Flex Lance Hose

2448D-025V35-TC
43K4MM



Construction

- Core Tube: Polyoxymethylene
- Pressure Reinforcement: Four spiral layers of maximum tensile steel wire
- Cover: Polyamide
- Standard Color: x5 - Orange

Temperature

- Temperature Range: 14°F to 158°F (-10°C to 70°C)

Design Factor

- 2.5

Notes

- TC Tough Cover offers improved abrasion resistance over the standard.

[Visit the webpage](#)

Part Number	Nominal I.D.		Max. O.D.		Max. Working Pressure		Min. Bend Radius		Weight		Fitting Series		
	DN	Size	inch	mm	inch	mm	psi	bar	inch	mm		lbs./ft.	kg/mtr
2448D-025V35-TC	4	-025	5/32	4	0.39	9.9	43,645	3,010	4.72	120	0.15	0.22	LX

6Y4LX - High Pressure Male

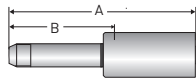

Part Number	Nominal I.D.		Thread Size	Overall Length A		Cutoff Allow. B			
	DN	Size		inch	mm	inch	mm		
6Y4LX-4-2AC	4	-025	5/32	4.0	1/4" - 28 LH	2.96	75	1.71	43
6Y4LX-6-2AC					3/8" - 24 LH	3.40	86	2.16	55

C - Stainless Steel

6HYLX - Waterblast Nozzle Female - Prolance

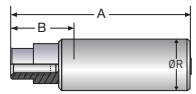

Part Number	Nominal I.D.		Thread Size	Overall Length A		Cutoff Allow. B		Diameter R			
	DN	Size		inch	mm	inch	mm	inch	mm		
6HYLX-4-2AC-PL	4	-025	5/32	4.0	1/4" - 28 UNF	1.97	50	0.72	18	0.51	13

C - Stainless Steel

6YHLX - Waterblast Nozzle Male - Prolance

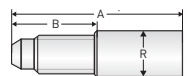

Part Number	Nominal I.D.		Thread Size	Overall Length A		Cutoff Allow. B		Wrench Flat			
	DN	Size		inch	mm	inch	mm	inch	mm		
6YHLX-4-2AC-PL	4	-025	5/32	4.0	1/4" - 28 UNF	2.25	57	1.01	26	0.50	13
6YHLX-4-2AC-PL-LH					1/4" - 28 UNF LH						
6YHLX-6-2AC-PL-LH	4	-025	5/32	4.0	3/8" - 24 UNF LH	2.44	62	1.20	30	0.37	9.5

C - Stainless Steel

6AYLX - Type "M" Swivel - Female

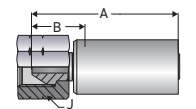

Part Number	Nominal I.D.		Thread Size	Overall Length A		Cutoff Allow. B		J Hex			
	DN	Size		inch	mm	inch	mm	inch	mm		
6AYLX-6-2AC	4	-025	5/32	4.0	9/16" - 18	2.51	64	1.28	33	0.68	17

C - Stainless Steel

Accessories Part Numbers

Hose Stop

AH-04S

Technical details available in Section D.

WARNING

This product can expose you to chemicals including Lead, which is known to the State of California to cause cancer and birth defects or other reproductive harm. For more information go to www.P65Warnings.ca.gov.

3/16" - 36,250 psi Ultra High Pressure Waterblast Hose

PFX25-03
36K5MM



Construction

- Core Tube: Polyoxymethylene
- Pressure Reinforcement: Six spiral layers of maximum tensile steel wire
- Cover: Polyamide
- Standard Color: x7 - Gray

Temperature

- Temperature Range:
14°F to 158°F (-10°C to 70°C)

Design Factor

- 2.5

Certifications

- DIN EN1829-2 compliant

[Visit the webpage](#)

Part Number	Nominal I.D.				Max. O.D.		Max. Working Pressure		Min. Bend Radius		Weight		Fitting Series
	DN	Size	inch	mm	inch	mm	psi	bar	inch	mm	lbs./ft.	kg/mtr	
PFX25-03	5	-03	3/16	4.8	0.51	12.9	36,250	2,500	6.89	175	0.28	0.41	2X

1Y42X - High Pressure Tube Nipple

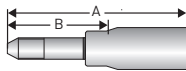

Part Number	Nominal I.D.				Thread Size	Overall Length A		Cutoff Allow. B	
	DN	Size	inch	mm		inch	mm	inch	mm
1Y42X-4-03C	5	-03	3/16	4.8	1/4" - 28 LH	4.45	113	2.48	63
1Y42X-6-03					3/8" - 24 LH				
1Y42X-6-03C					3/8" - 24 LH				
1Y42X-9-03					9/16" - 18 LH				
1Y42X-9-03C					9/16" - 18 LH				

Steel and Stainless Steel C - Stainless Steel

1AY2X - Type "M" Female Swivel

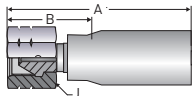

Part Number	Nominal I.D.				Thread Size	Overall Length A		Cutoff Allow. B		J Hex	
	DN	Size	inch	mm		inch	mm	inch	mm	inch	mm
1AY2X-6-03	5	-03	3/16	4.8	9/16" - 18	3.58	91	1.50	38	0.87	22
1AY2X-6-03C											

Steel & Carbon Steel, Zinc-plated C - Stainless Steel

Accessories Part Numbers

Heavy Duty Abrasion Cover	Transition Sleeve	Support Grips	Hose Stop
MHDC012	510-A-500-12	MCGHS10-15	AH-05S

Technical details available in Section D.

WARNING

This product can expose you to chemicals including Lead, which is known to the State of California to cause cancer and birth defects or other reproductive harm. For more information go to www.P65Warnings.ca.gov.

1/2" - 26,100 psi Ultra High Pressure Waterblast Hose

2640N-08V32
26K13MM



Construction

- Core Tube: Polyamide 12
- Pressure Reinforcement: Six spiral layers of maximum tensile steel wire
- Cover: Polyamide
- Standard Color: x2 - Blue

Temperature

- Temperature Range: 14°F to 158°F (-10°C to 70°C)

Design Factor

- 2.5

Certifications

- DIN EN1829-2 compliant

[Visit the webpage](#)

Part Number	Nominal I.D.		Max. O.D.		Max. Working Pressure		Min. Bend Radius		Weight		Fitting Series		
	DN	Size	inch	mm	inch	mm	psi	bar	inch	mm		lbs./ft.	kg/mtr
2640N-08V32	13	-08	1/2	12.7	0.96	24.5	26,100	1,800	11.42	290	0.92	1.37	2X

1C92X - Metric Swivel - Female

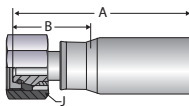

Part Number	Nominal I.D.		Thread Size		Overall Length A		Cutoff Allow. B		J Hex		
	DN	Size	inch	mm	inch	mm	inch	mm	inch	mm	
1C92X-16-08	13	-08	1/2	12.7	M 24 x 1.5	4.61	117	1.85	47	1.26	32

Nipple - Stainless Steel Shell - Carbon Steel, Zinc-plated

1AY2X - Type "M" Female Swivel

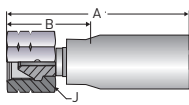

Part Number	Nominal I.D.		Thread Size		Overall Length A		Cutoff Allow. B		J Hex		
	DN	Size	inch	mm	inch	mm	inch	mm	inch	mm	
1AY2X-11-08	11	-08	1/2	12.7	1" - 12UNF	4.41	112	1.83	46	1.26	32

Nipple - Stainless Steel Shell - Carbon Steel, Zinc-plated

Accessories Part Numbers

Heavy Duty Abrasion Cover	Transition Sleeve	Support Grips
PVC-BLUE-024	220-200-22	MCGHS20-30

Technical details available in Section D.



WARNING

This product can expose you to chemicals including Lead, which is known to the State of California to cause cancer and birth defects or other reproductive harm. For more information go to www.P65Warnings.ca.gov.

3/4" - 20,300 psi Ultra High Pressure Waterblast Hose

2640N-12V32

20K20MM / 20K20MMTJ



Construction

- Core Tube: Polyamide 12
- Pressure Reinforcement: Six spiral layers of maximum tensile steel wire
- Cover: Polyamide or TOUGHJACKET PU
- Standard Color: x2 - Blue

Temperature

- Temperature Range: 14°F to 158°F (-10°C to 70°C)

Certifications

- DIN EN1829-2 compliant

Design Factor

- 2.5

[Visit the webpage](#)

Part Number	Nominal I.D.				Max. O.D.		Max. Working Pressure		Min. Bend Radius		Weight		Fitting Series
	DN	Size	inch	mm	inch	mm	psi	bar	inch	mm	lbs./ft.	kg/mtr	
2640N-12V32	20	-12	3/4	19	1.30	33.0	20,300	1,400	13.78	350	1.45	2.16	5X
TOUGHJACKET													
2640N-12V32/12	20	-12	3/4	19	1.46	37.0	20,300	1,400	13.78	350	1.61	2.40	JX

6Y25X - Medium Pressure Tube Nipple

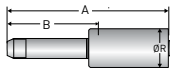

Part Number	Nominal I.D.				Overall Length A		Cutoff Allow. B		Diameter R		Max. Working Pressure	
	DN	Size	inch	mm	inch	mm	inch	mm	inch	mm	psi	bar
6Y25X-16-12C-SL	20	-12	3/4	19	4.83	123	2.73	69	1.69	43	20,000	1,380

C - Stainless Steel

6C95X - Metric Swivel - Female

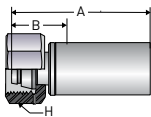

Part Number	Nominal I.D.				Thread Size	Overall Length A		Cutoff Allow. B		H Hex	
	DN	Size	inch	mm		inch	mm	inch	mm	inch	mm
6C95X-25-12C	20	-12	3/4	19	M 36 x 2	4.37	111	1.60	41	1.81	46

C - Stainless Steel

6AY5X - Type "M" Female Swivel

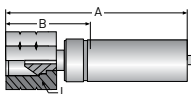

Part Number	Nominal I.D.				Thread Size	Overall Length A		Cutoff Allow. B		J Hex	
	DN	Size	inch	mm		inch	mm	inch	mm	inch	mm
6AY5X-16-12C	20	-12	3/4	19	1-5/16" - 12	4.35	110	1.60	41	1.50	38

C - Stainless Steel

1AYJX - Type "M" Female Swivel

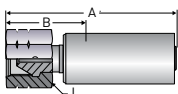

Part Number	Nominal I.D.				Thread Size	Overall Length A		Cutoff Allow. B		J Hex	
	DN	Size	inch	mm		inch	mm	inch	mm	inch	mm
1AYJX-16-12C	20	-12	3/4	19	1-5/16" - 12	4.09	104	1.60	41	1.61	41

C - Stainless Steel

Accessories Part Numbers - 2640N-12V32

Heavy Duty Abrasion Cover	Transition Sleeve	Support Grips
PVC-BLUE-024	220-200-22	MCGHS30-40

Technical details available in Section D.

Accessories Part Numbers - 2640N-12V32/12

Transition Sleeve	Support Grips
P2542-80	MCG003SS

Technical details available in Section D.

WARNING

This product can expose you to chemicals including Lead, which is known to the State of California to cause cancer and birth defects or other reproductive harm. For more information go to www.P65Warnings.ca.gov.

3/4" - 23,200 psi Ultra High Pressure Waterblast Hose

2648N-12V32
23K20MM



Construction

- Core Tube: Polyamide 12
- Pressure Reinforcement: Six spiral layers of maximum tensile steel wire
- Cover: Polyamide
- Standard Color: x2 - Blue

Temperature

- Temperature Range: 14°F to 158°F (-10°C to 70°C)

Design Factor

- 2.5

Certifications

- DIN EN1829-2 compliant

[Visit the webpage](#)

Part Number	Nominal I.D.				Max. O.D.		Max. Working Pressure		Min. Bend Radius		Weight		Fitting Series
	DN	Size	inch	mm	inch	mm	psi	bar	inch	mm	lbs./ft.	kg/mtr	
2648N-12V32	20	-12	3/4	19	1.33	33.7	23,200	1,600	13.78	350	1.53	2.28	JX

1C9JX - Metric Swivel - Female

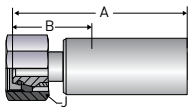

Part Number	Nominal I.D.				Thread Size	Overall Length A		Cutoff Allow. B		J Hex	
	DN	Size	inch	mm		inch	mm	inch	mm	inch	mm
1C9JX-25-12W	20	-12	3/4	19	M 36 x 2	4.25	108	1.93	49	1.81	46

Carbon Steel

1AYJX - Type "M" Female Swivel

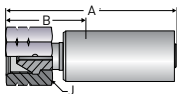

Part Number	Nominal I.D.				Thread Size	Overall Length A		Cutoff Allow. B		J Hex	
	DN	Size	inch	mm		inch	mm	inch	mm	inch	mm
1AYJX-16-12W	20	-12	3/4	19	1-5/16" -12	4.09	104	1.60	41	1.61	41

Carbon Steel

Accessories Part Numbers

Heavy Duty Abrasion Cover	Transition Sleeve	Support Grips	Cover Transition Sleeve
MHDC026	520-A-500-26	MCGHS30-40	P2542-80

Technical details available in Section D.



WARNING

This product can expose you to chemicals including Lead, which is known to the State of California to cause cancer and birth defects or other reproductive harm. For more information go to www.P65Warnings.ca.gov.

1" - 21,750 psi Ultra High Pressure Waterblast Hose

2648N-16V32
21K25MM



Construction

- Core Tube: Polyamide 12
- Pressure Reinforcement: Six spiral layers of maximum tensile steel wire
- Cover: Polyamide
- Standard Color: x2 - Blue

Temperature

- Temperature Range: 14°F to 158°F (-10°C to 70°C)

Design Factor

- 2.5

Certifications

- DIN EN1829-2 compliant

[Visit the webpage](#)

Part Number	Nominal I.D.				Max. O.D.		Max. Working Pressure		Min. Bend Radius		Weight		Fitting Series
	DN	Size	inch	mm	inch	mm	psi	bar	inch	mm	lbs./ft.	kg/mtr	
2648N-16V32	25	-16	11	25.4	1.61	40.8	21,750	1,500	15.75	400	2.08	3.10	CX

1C9CX - Metric Swivel - Female

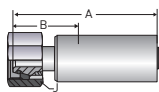

Part Number	Nominal I.D.				Thread Size	Overall Length A		Cutoff Allow. B		J Hex	
	DN	Size	inch	mm		inch	mm	inch	mm	inch	mm
1C9CX-30-16W	25	-16	1	25.4	M 42 x 2	4.76	121	2.17	55	2.17	55

Nipple - Stainless Steel Shell - Carbon Steel, Zinc-plated

1AYCX - Type "M" Female Swivel

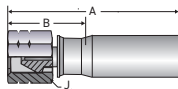

Part Number	Nominal I.D.				Thread Size	Overall Length A		Cutoff Allow. B		J Hex	
	DN	Size	inch	mm		inch	mm	inch	mm	inch	mm
1AYCX-16-16	25	-16	1	25.4	1-5/16" - 12	5.75	146	2.84	72	1.61	41

Nipple - Stainless Steel Nut & Shell - Carbon Steel, Zinc-plated

Accessories Part Numbers

Heavy Duty Abrasion Cover	Transition Sleeve	Support Grips
MHDC032	532-500	MCG003SS

Technical details available in Section D.

WARNING

This product can expose you to chemicals including Lead, which is known to the State of California to cause cancer and birth defects or other reproductive harm. For more information go to www.P65Warnings.ca.gov.



3/16" - 43,645 psi Ultra High Pressure Waterblast Hose

PFX30-03/PFX30-03-TJ 40K5MM/40K5MMTJ



Built in abrasion resistance eliminates the need for an additional PVC sleeve and it lightens the hose by up to 16%.

Construction

- Core Tube: Polyoxymethylene
- Pressure Reinforcement: Six spiral layers of maximum tensile steel wire
- Cover: Polyamide or TOUGHJACKET PU
- Standard Color: x5 - Orange

Temperature

- Temperature Range: 14°F to 158°F (-10°C to 70°C)

Certifications

- DIN EN1829-2 compliant

Design Factor

- 2.5

Notes

- Transition Sleeve required on TOUGHJACKET hose assemblies.

[Visit the webpage](#)

Part Number	Nominal I.D.				Max. O.D.		Max. Working Pressure		Min. Bend Radius		Weight		Fitting Series
	DN	Size	inch	mm	inch	mm	psi	bar	inch	mm	lbs./ft.	kg/mtr	
PFX30-03	5	-03	3/16	4.8	0.52	13.3	43,645	3,010	7.87	200	0.32	0.47	2X
TOUGHJACKET													
PFX30-03-TJ	5	-03	3/16	4.8	0.68	17.3	43,645	3,010	7.87	200	0.39	0.58	2X

1Y42X - High Pressure Tube Nipple

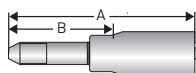

Part Number	Nominal I.D.				Thread Size	Overall Length A		Cutoff Allow. B	
	DN	Size	inch	mm		inch	mm	inch	mm
1Y42X-4-03C	5	-03	3/16	4.8	1/4" - 28 LH	4.45	113	2.48	63
1Y42X-6-03					3/8" - 24 LH				
1Y42X-6-03C									
1Y42X-9-03					9/16" - 18 LH				
1Y42X-9-03C									

Steel and Stainless Steel C - Stainless Steel

1AY2X - Type "M" Female Swivel

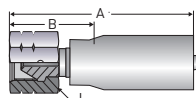

Part Number	Nominal I.D.				Thread Size	Overall Length A		Cutoff Allow. B		J Hex	
	DN	Size	inch	mm		inch	mm	inch	mm	inch	mm
1AY2X-6-03	5	-03	3/16	4.8	9/16" - 18	3.58	91	1.50	38	0.87	22
1AY2X-6-03C											

Steel & Carbon Steel, Zinc-plated C - Stainless Steel

Accessories Part Numbers - PFX30-03

Heavy Duty Abrasion Cover	Transition Sleeve	Support Grips	Bend Stiffener
PVC-ORANGE -012	KL-2841-03	MCGHS10-15	M55STIF4 M55STIF6
Bend Restrictor	Hose Stop	Pressure Containment Shield & Sleeves	
MBR013-BLK 412-400	AH-05S	MHBS012 412-400	

Technical details available in Section D.

Accessories Part Numbers - PFX30-03-TJ

Transition Sleeve	Support Grips
KL-2841	MCGHS15-20

Technical details available in Section D.

WARNING

This product can expose you to chemicals including Lead, which is known to the State of California to cause cancer and birth defects or other reproductive harm. For more information go to www.P65Warnings.ca.gov.

5/16" - 36,230 psi Ultra High Pressure Waterblast Hose



PFX25-05-TJ
36K8MMTJ



Built in abrasion resistance eliminates the need for an additional PVC sleeve and it lightens the hose by up to 16%.

Construction

- Core Tube: Polyoxymethylene
- Pressure Reinforcement: Eight spiral layers of maximum tensile steel wire
- Cover: TOUGHJACKET PU
- Standard Color: x7 - Gray

Temperature

- Temperature Range: 14°F to 158°F (-10°C to 70°C)

Design Factor

- 2.5

Certifications

- DIN EN1829-2 compliant

Notes

- Transition Sleeve required on TOUGHJACKET hose assemblies.

[Visit the webpage](#)

Part Number	Nominal I.D.				Max. O.D.		Max. Working Pressure		Min. Bend Radius		Weight		Fitting Series
	DN	Size	inch	mm	inch	mm	psi	bar	inch	mm	lbs./ft.	kg/mtr	
TOUGHJACKET													
PFX25-05-TJ	8	-05	5/16	7.8	0.84	21.3	36,230	2,500	7.87	200	0.63	0.94	2X

1Y42X - High Pressure Tube Nipple

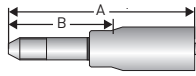

Part Number	Nominal I.D.				Thread Size	Overall Length A		Cutoff Allow. B	
	DN	Size	inch	mm		inch	mm	inch	mm
1Y42X-9-05	8	-05	5/16	7.8	9/16" - 18 UNF LH	4.83	123	2.83	72
1Y42X-9-05C									
Steel and Stainless Steel		C - Stainless Steel							

1AY2X - Type "M" Female Swivel

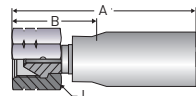

Part Number	Nominal I.D.				Thread Size	Overall Length A		Cutoff Allow. B		J Hex	
	DN	Size	inch	mm		inch	mm	inch	mm	inch	mm
1AY2X-8-05-SA	8	-05	5/16	7.8	3/4" - 16	3.58	91	1.5	38	1	25
1AY2X-10-05-SA					7/8" - 14					1.25	32
1AY2X-13-05-SA					1-1/8" - 12					1.38	35
Steel and Stainless Steel											

Accessories Part Numbers

Support Grips	Transition Sleeve
MCGHS10-15	KL-2841

Technical details available in Section D.



WARNING

This product can expose you to chemicals including Lead, which is known to the State of California to cause cancer and birth defects or other reproductive harm. For more information go to www.P65Warnings.ca.gov.



3/16" - 58,000 psi Ultra High Pressure Waterblast Hose

PFX40-03/PFX40-03-TJ 58K5MM/58K5MMTJ



Built in abrasion resistance eliminates the need for an additional PVC sleeve and it lightens the hose by up to 16%.

Construction

- Core Tube: Polyoxymethylene
- Pressure Reinforcement: Six spiral layers of maximum tensile steel wire
- Cover: Polyamide or TOUGHJACKET PU
- Standard Color: x4 - Red, x5 - Orange

Temperature

- Temperature Range: 14°F to 158°F (-10°C to 70°C)

Design Factor

- 2.1

Notes

- Transition Sleeve required on TOUGHJACKET hose assemblies.

[Visit the webpage](#)

Part Number	Nominal I.D.				Max. O.D.		Max. Working Pressure		Min. Bend Radius		Weight		Fitting Series
	DN	Size	inch	mm	inch	mm	psi	bar	inch	mm	lbs./ft.	kg/mtr	
PFX40-03	5	-03	3/16	4.8	0.59	15.1	58,000	4,000	7.87	200	0.43	0.64	2X
TOUGHJACKET													
PFX40-03-TJ	5	-03	3/16	4.8	0.75	19.1	58,000	4,000	7.87	200	0.52	0.77	2X

1Y42X - High Pressure Tube Nipple

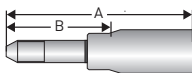

Part Number	Nominal I.D.				Thread Size	Overall Length A		Cutoff Allow. B	
	DN	Size	inch	mm		inch	mm	inch	mm
1Y42X-4-03C	5	-03	3/16	4.8	1/4" - 28 LH	4.45	113	2.48	63
1Y42X-6-03					3/8" - 24 LH	4.45	113	2.48	63
1Y42X-6-03C					3/8" - 24 LH	4.45	113	2.48	63
1Y42X-9-03					9/16" - 18 LH	4.45	113	2.48	63
1Y42X-9-03C					9/16" - 18 LH	4.45	113	2.48	63

Steel and Stainless Steel C - Stainless Steel

1AY2X - Type "M" Swivel - Female

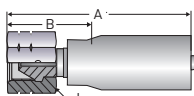

Part Number	Nominal I.D.				Thread Size	Overall Length A		Cutoff Allow. B		J Hex	
	DN	Size	inch	mm		inch	mm	inch	mm	inch	mm
1AY2X-6-03	5	-03	3/16	4.8	9/16" - 18	3.58	91	1.50	38	0.87	22
1AY2X-6-03C											

C - Stainless Steel

Accessories Part Numbers - PFX40-03

Heavy Duty Abrasion Cover	Transition Sleeve	Support Grips	Bend Stiffener
MHDC012	510-A-500-12	MCGHS10-15	M55STIF4 M55STIF6
Bend Restrictor	Hose Stop	Pressure Containment Shield & Sleeves	
MBR013-BLK HPF-6	AH-06S	MHBS012 412-400	

Technical details available in Section D.

Accessories Part Numbers - PFX40-03-TJ

Transition Sleeve	Support Grips
KL-2841-03	MCGHS15-20

Technical details available in Section D.

WARNING

This product can expose you to chemicals including Lead, which is known to the State of California to cause cancer and birth defects or other reproductive harm. For more information go to www.P65Warnings.ca.gov.

5/16" - 43,645 psi Ultra High Pressure Waterblast Hose

PFX30-05/PFX30-05-TJ
43K8MM/43K8MMTJ



Built in abrasion resistance eliminates the need for an additional PVC sleeve and it lightens the hose by up to 16%.

Construction

- Core Tube: Polyoxymethylene
- Pressure Reinforcement: Six spiral layers of maximum tensile steel wire
- Cover: Polyamide or TOUGHJACKET PU
- Standard Color: x5 - Orange

Temperature

- Temperature Range:
14°F to 158°F (-10°C to 70°C)

Design Factor

- 2.3

Certifications

- DIN EN1829-2 compliant

Notes

- Transition Sleeve required on TOUGHJACKET hose assemblies.

[Visit the webpage](#)

Part Number	Nominal I.D.				Max. O.D.		Max. Working Pressure		Min. Bend Radius		Weight		Fitting Series
	DN	Size	inch	mm	inch	mm	psi	bar	inch	mm	lbs./ft.	kg/mtr	
PFX30-05	8	-05	5/16	7.9	.736	18.7	43,645	3,010	9	230	0.64	0.96	2X
TOUGHJACKET													
PFX30-05-TJ	8	-05	5/16	7.9	.894	22.7	43,645	3,010	9	230	0.75	1.10	2X

1Y42X - High Pressure Tube Nipple

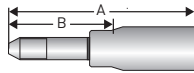

Part Number	Nominal I.D.				Thread Size	Overall Length A		Cutoff Allow. B	
	DN	Size	inch	mm		inch	mm	inch	mm
1Y42X-6-05	8	-05	5/16	7.9	3/8" - 24 UNF LH	4.48	114	2.48	63
1Y42X-9-05					9/16" - 18 UNF LH	4.84	123	2.84	72
1Y42X-9-05C									

Steel and Stainless Steel C - Stainless Steel

1AY2X - Type "M" Female Swivel

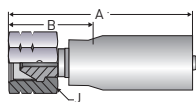

Part Number	Nominal I.D.				Thread Size	Overall Length A		Cutoff Allow. B		J Hex	
	DN	Size	inch	mm		inch	mm	inch	mm	inch	mm
1AY2X-8-05-SA	8	-05	5/16	7.9	3/4" - 16 UNF	3.58	91	1.5	38	1	25
1AY2X-10-05-SA					7/8" - 14 UNF					1.25	32
1AY2X-13-05-SA					1-1/8" - 12					1.38	35

Nipple - Stainless Steel Nut & Shell - Carbon Steel, Zinc-plated

Accessories Part Numbers - PFX30-05

Heavy Duty Abrasion Cover	Transition Sleeve	Support Grips	Pressure Containment Shield & Sleeves
PVC-ORANGE -016	KL-2841	MCGHS15-20	MHBS016 412-400-16

Technical details available in Section D.

Accessories Part Numbers - PFX30-05-TJ

Transition Sleeve	Support Grips
KL-2841	MCGHS20-30

Technical details available in Section D.

WARNING

This product can expose you to chemicals including Lead, which is known to the State of California to cause cancer and birth defects or other reproductive harm. For more information go to www.P65Warnings.ca.gov.



5/16" - 55,100 psi Ultra High Pressure Waterblast Hose

PFX38-05/PFX38-05-TJ
55K8MM/55K8MMTJ



Built in abrasion resistance eliminates the need for an additional PVC sleeve and it lightens the hose by up to 16%.

Construction

- Core Tube: Polyoxymethylene
- Pressure Reinforcement: Eight spiral layers of maximum tensile steel wire
- Cover: Polyamide or TOUGHJACKET PU
- Standard Color: x4 - Red

Temperature

- Temperature Range: 14°F to 158°F (-10°C to 70°C)

Design Factor

- 2.1

Notes

- Transition Sleeve required on TOUGHJACKET hose assemblies.

[Visit the webpage](#)

Part Number	Nominal I.D.				Max. O.D.		Max. Working Pressure		Min. Bend Radius		Weight		Fitting Series
	DN	Size	inch	mm	inch	mm	psi	bar	inch	mm	lbs./ft.	kg/mtr	
PFX38-05	8	-05	5/16	7.8	.807	20.5	55,000	3,800	11	280	0.85	1.26	2X
TOUGHJACKET													
PFX38-05-TJ	8	-05	5/16	7.8	.964	24.5	55,000	3,800	11	280	0.96	1.43	2X

1Y42X - High Pressure Tube Nipple

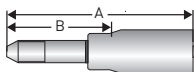

Part Number	Nominal I.D.				Thread Size	Overall Length A		Cutoff Allow. B	
	DN	Size	inch	mm		inch	mm	inch	mm
1Y42X-9-05	8	-05	5/16	7.9	9/16" - 18 UNF LH	4.84	123	2.84	72
1Y42X-9-05C									

Steel and Stainless Steel C - Stainless Steel

1AY2X - Type "M" Female Swivel

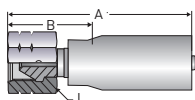

Part Number	Nominal I.D.				Thread Size	Overall Length A		Cutoff Allow. B		J Hex	
	DN	Size	inch	mm		inch	mm	inch	mm	inch	mm
1AY2X-8-05-SA	8	-05	5/16	7.9	3/4" - 16 UNF	3.58	91	1.5	38	1	25
1AY2X-10-05-SA					7/8" - 14 UNF					1.25	32
1AY2X-13-05-SA					1-1/8" - 12					1.38	35

Nipple - Stainless Steel Nut & Shell - Carbon Steel, Zinc-plated

Accessories Part Numbers - PFX38-05



Cover Sleeve

416-400-16

Technical details available in Section D.

Accessories Part Numbers - PFX38-05-TJ



Transition Sleeve

KL-PFX30-06

Technical details available in Section D.

Waterblast Hose



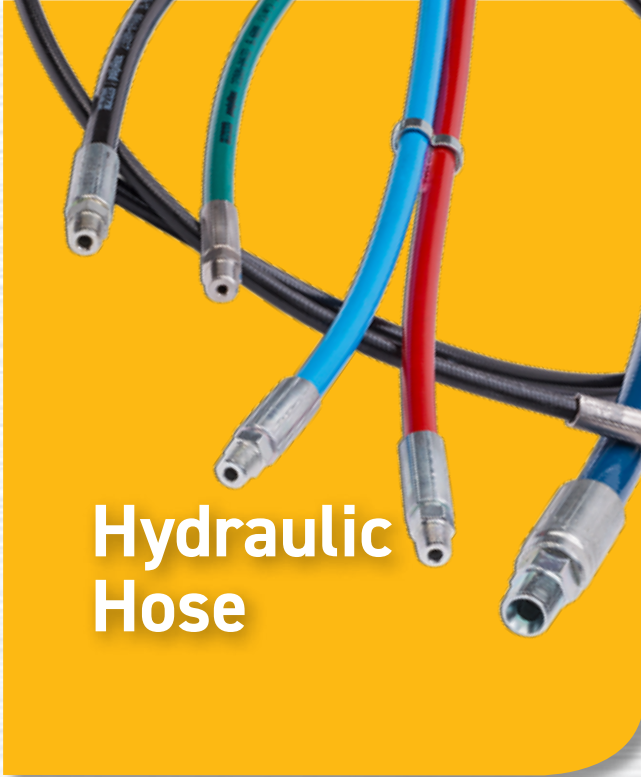

Hydraulic Hose

Hydraulic Hose

Table Of Contents

Introduction

Fitting Configurations.....	A-59
Hydraulic Hose Pressure Overview	A-60

Hose Series

2020N-012.....	A-61	2388N-04	A-69
2020N-02	A-62	2388N-08	A-70
2022N-04	A-64	2390N-06	A-71
2380N-025	A-65	2390N-08	A-72
2380N-04	A-66	2390N-16	A-73
2380N-05	A-67		
2380N-20	A-68		

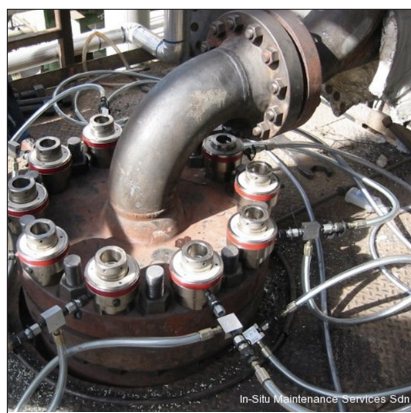

Fitting Configurations

by Connection and End Code

End Code		Description
Pipe	01	Male NPT Pipe - Rigid - Straight
Flare	06 37 39	Female JIC 37° - Swivel - Straight Female JIC 37° - Swivel - 45° Elbow - Short Drop Female JIC 37° - Swivel - 90° Elbow - Short Drop
Metric	1C C9	90° Metric Female Swivel 24° with O-ring Female Metric S - Swivel - Straight (24° Cone with O-ring)
Specialty	9G 9M 9W AY TU	Straight Dual Seal 45° Dual Seal 90° Dual Seal Type "M" Swivel - Female Universal Tube Stub

Hose

A

Waterblast

Hydraulic

Oil & Gas

Adapters

B

Quick Couplings

C

Accessories

D

Appendix

E

Hydraulic Hose Pressure & Size Overview

Part Number	Dimension Data						Max. Working Pressure		Min. Bend Radius		Weight		Fitting	Design Factor
	DN	Size	I.D. inch	I.D. mm	O.D. inch	O.D. mm	psi	bar	inch	mm	lbs./ft.	kg/mtr		
DN2														
2020N-012R30	2	-012	5/64	2.0	0.20	4.9	6,890	475	0.79	20	0.01	0.02	EX	2.5
DN3														
2020N-02V30	3	-02	1/8	3.2	0.24	6.0	5,800	400	1.20	30	0.02	0.02	EX/RX	2.5
DN4														
2380N-025V10	4	-025	5/32	4.0	0.38	9.7	10,875	750	2.17	55	0.11	0.16	8X	4.0
DN6														
2022N-04V15	6	-04	1/4	6.4	0.54	12.8	10,000	690	3.94	100	0.09	0.14	8X	4.0
2022N-04V10-P	6	-04	1/4	6.4	0.54	12.8	10,000	690	3.94	100	0.09	0.14	8X	4.0
2380N-04V0x	6	-04	1/4	6.4	0.52	12.3	10,150	690	2.80	70	0.18	0.27	8X	4.0
2388N-04V14	6	-04	1/4	6.4	0.53	13.4	11,600	800	3.15	80	0.20	0.30	8X	4.0
DN8														
2380N-05V00	8	-05	5/16	7.9	0.62	15.8	14,500	1,000	3.54	90	0.24	0.35	LX	2.5
DN10														
2390N-06V13	10	-06	3/8	9.5	0.71	18.1	6,450	445	4.72	120	0.28	0.41	9X	4.0
DN12														
2388N-08V14	13	-08	1/2	12.7	0.91	23.1	15,950	1,100	4.72	120	0.54	0.80	BS	2.5
2390N-08V1x	13	-08	1/2	12.7	0.83	21.2	6,017	415	5.91	150	0.36	0.54	9X	4.0
DN25														
2390N-16V13	25	-16	1	25.4	1.38	35.0	4,060	280	11.02	280	0.79	1.17	E4	4.0
DN32														
2380N-20V30	32	-20	1-1/4	31.8	1.73	44.0	3,990	275	15.75	400	1.23	1.83	NX	4.0

Assembly working pressure is dependent on the lowest rated component. Therefore, if fittings have a lower pressure rating than the hose, the working pressure of the fittings is the working pressure of the assembly.

5/64" - 6,890 psi Hydraulic Hose

2020N-012R30



Extremely small hose for high pressure service requirements

Construction

- Core Tube: Polyamide 12
- Pressure Reinforcement: One braided layer of high tensile synthetic fiber
- Cover: Polyamide
- Standard Color: x0 - Black

Temperature

- Temperature Range: -40°F to 180°F (-40°C to 82°C)

Design Factor

- 4

Notes

- Not for use in airless paint spray or solvent spraying applications. Not a static dissipative hose.
- For gas service, order 2020N-012R30-PP - Hose is pin-pricked for gas service.
- Refer to pg. A-10, paragraph 5 of "Notes on Chemical Resistance" for gas applications.

[Visit the webpage](#)

Part Number	Nominal I.D.				Max. O.D.		Max. Working Pressure		Min. Bend Radius		Weight		Fitting Series
	DN	Size	inch	mm	inch	mm	psi	bar	inch	mm	lbs./ft.	kg/mtr	
2020N-012R30	2	-012	5/64	2	0.20	4.9	6,890	475	0.79	20	0.01	0.02	EX

101EX - NPT Male

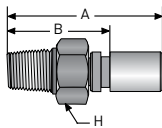

Part Number	Nominal I.D.				Thread Size	Overall Length A		Cutoff Allow. B		H Hex	
	DN	Size	inch	mm		inch	mm	inch	mm	inch	mm
101EX-2-012	2	-012	5/64	2	1/4" - 18	1.54	39	1.10	28	0.56	14
101EX-4-012					1/8" - 27	1.37	35	0.93	24	0.44	11

Carbon Steel, Zinc-plated

106EX - JIC 37° Female Flare

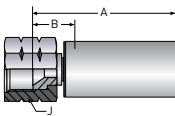

Part Number	Nominal I.D.				Thread Size	Overall Length A		Cutoff Allow. B		J Hex	
	DN	Size	inch	mm		inch	mm	inch	mm	inch	mm
106EX-4-012	2	-012	5/64	2	7/16" - 20	1.00	25	0.55	14	0.67	17

Carbon Steel, Zinc-plated

WARNING

This product can expose you to chemicals including Lead, which is known to the State of California to cause cancer and birth defects or other reproductive harm. For more information go to www.P65Warnings.ca.gov.

1/8" - 5,800 psi Hydraulic Hose

2020N-02V30



Extremely small hose for high pressure service requirements

Construction

- Core Tube: Polyamide 12
- Pressure Reinforcement: One braided layer of high tensile synthetic fiber
- Cover: Polyamide, pin-pricked
- Standard Color: x0 - Black

Temperature

- Temperature Range: -40°F to 180°F (-40°C to 82°C)

Design Factor

- 4

Notes

- Not for use in airless paint spray or solvent spraying applications. Not a static dissipative hose.
- Hose is pin-pricked for gas service.
- RX Series fittings are field assembled. Contact the division for more information.
- Refer to pg. A-10, paragraph 5 of "Notes on Chemical Resistance" for gas applications.

[Visit the webpage](#)

Part Number	Nominal I.D.				Max. O.D.		Max. Working Pressure		Min. Bend Radius		Weight		Fitting Series
	DN	Size	inch	mm	inch	mm	psi	bar	inch	mm	lbs./ft.	kg/mtr	
2020N-02V30	3	-02	1/8	3	0.24	6.0	5,800	400	1.20	30	0.02	0.02	EX/RX

601EX - NPT Male

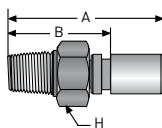

Part Number	Nominal I.D.				Thread Size	Overall Length A		Cutoff Allow. B		H Hex	
	DN	Size	inch	mm		inch	mm	inch	mm	inch	mm
601EX-2-2C	3	-02	1/8	3	1/8" - 27	1.33	34	0.93	24	0.44	11

C - All components Stainless Steel

1C9EX - Metric Swivel - Female

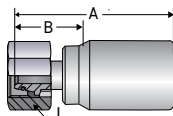

Part Number	Nominal I.D.				Thread Size	Overall Length A		Cutoff Allow. B		J Hex	
	DN	Size	inch	mm		inch	mm	inch	mm	inch	mm
1C9EX-8-02	3	-02	1/8	3	M 16 x 1.5	1.26	32	.87	22	0.75	19

Carbon Steel, Zinc-plated

201RX - NPT Male

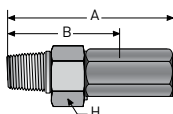

Part Number	Nominal I.D.				Thread Size	Overall Length A		Cutoff Allow. B		H Hex	
	DN	Size	inch	mm		inch	mm	inch	mm	inch	mm
201RX-2-2C	3	-02	1/8	3	1/8" - 27	1.54	39	1.10	28	0.44	11

C - All components Stainless Steel

continued on next page

WARNING

This product can expose you to chemicals including Lead, which is known to the State of California to cause cancer and birth defects or other reproductive harm. For more information go to www.P65Warnings.ca.gov.

1/8" - 5,800 psi Hydraulic Hose

2020N-02V30

206RX - JIC 37° Female Flare

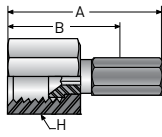

Part Number	Nominal I.D.				Thread Size	Overall Length A		Cutoff Allow. B		H Hex	
	DN	Size	inch	mm		inch	mm	inch	mm	inch	mm
206RX-4-2C	3	-02	1/8	3	7/16" - 20	1.56	40	1.10	28	0.56	14

C - All components Stainless Steel

2TURX - Tube Stub

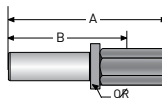

Part Number	Nominal I.D.				Flange Size	Overall Length A		Cutoff Allow. B		Diameter R	
	DN	Size	inch	mm		inch	mm	inch	mm	inch	mm
2TURX-4-2C	3	-02	1/8	3	1/4" TUBE	1.65	42	1.20	30	0.38	10

C - All components Stainless Steel

Accessories Part Numbers

Bend Restrictor

MBR003 (w/ reusable fittings)
MBR004 (w/ crimp fittings)

Technical details available in Section D.



WARNING

This product can expose you to chemicals including Lead, which is known to the State of California to cause cancer and birth defects or other reproductive harm. For more information go to www.P65Warnings.ca.gov.

1/4" - 10,000 psi Hydraulic Hose

2022N-04V1x



Long-length hose and hose umbilicals requiring lightweight construction

Construction

- Core Tube: Polyamide 12
- Pressure Reinforcement: Aramid fiber braid
- Cover: Polyurethane
- Standard Color: x0 - Black, x5 - Orange

Temperature

- Temperature Range:
-40°C to +176°F (-40°C to 80°C)

Certifications

- Meets or exceeds SAE J517/J343 for less than 50 microamps leakage under 75000 volts per foot*

Design Factor

- 4

Notes

- *Non-conductive hose. In non-flammable gas transfer applications, use 2022N-04V10-P.
- Warning tags are required for all hose assemblies.
- Hose guards (HG2022N-4) are required for all hand held applications. Parker Parflex suggests the use of bend restrictors for all assemblies.
- Refer to pg. A-10, paragraph 5 of "Notes on Chemical Resistance" for gas applications.

[Visit the webpage](#)

Part Number	Nominal I.D.		Max. O.D.		Max. Working Pressure		Min. Bend Radius		Weight		Fitting Series		
	DN	Size	inch	mm	inch	mm	psi	bar	inch	mm		lbs./ft.	kg/mtr
2022N-04V10-P	6	-04	1/4	6.4	0.54	12.8	10,000	690	3.94	100	0.09	0.14	8X
2022N-04V15*	6	-04	1/4	6.4	0.54	12.8	10,000	690	3.94	100	0.09	0.14	8X

1018X - NPT Male

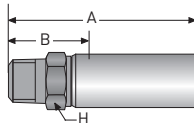

Part Number	Nominal I.D.		Thread Size	Overall Length A		Cutoff Allow. B		H Hex			
	DN	Size		inch	mm	inch	mm	inch	mm		
1018X-4-04	6	-04	1/4	6.4	1/4" - 18	2.54	65	1.30	33	0.56	14
1018X-4-04C					3/8" - 18	2.64	67	1.38	35	0.75	19
1018X-6-04	6	-04	1/4	6.4	3/8" - 18	2.64	67	1.38	35	0.75	19
1018X-6-04C					3/8" - 18	2.64	67	1.38	35	0.75	19

Carbon Steel, Zinc-plated C - All components Stainless Steel

1068X - JIC 37° Female Flare

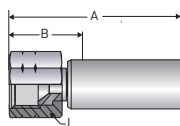

Part Number	Nominal I.D.		Thread Size	Overall Length A		Cutoff Allow. B		J Hex			
	DN	Size		inch	mm	inch	mm	inch	mm		
1068X-4-04	6	-04	1/4	6.4	7/16" - 20	2.24	57	1.02	26	0.75	19
1068X-4-04C					9/16" - 18	3.41	87	0.94	24		
1068X-6-04	6	-04	1/4	6.4	9/16" - 18	3.41	87	0.94	24	0.75	19
1068X-6-04C					9/16" - 18	3.41	87	0.94	24		

Carbon Steel, Zinc-plated C - All components Stainless Steel

1A18X - Type "M" Swivel - Female

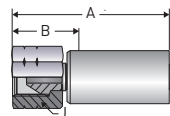

Part Number	Nominal I.D.		Thread Size	Overall Length A		Cutoff Allow. B		J Hex			
	DN	Size		inch	mm	inch	mm	inch	mm		
1A18X-6-04	6	-04	1/4	6.4	9/16" - 18	2.60	66	1.38	35	0.67	17
1A18X-6-04C					9/16" - 18	2.60	66	1.38	35	0.67	17

Carbon Steel, Zinc-plated C - All components Stainless Steel

Accessories Part Numbers

Hose Guard	Hose Tags
HG2022N-4	2022N-TAG 2022N-Nonconductive-TAG

Technical details available in Section D.

WARNING

This product can expose you to chemicals including Lead, which is known to the State of California to cause cancer and birth defects or other reproductive harm. For more information go to www.P65Warnings.ca.gov.

5/32" - 10,875 psi Hydraulic Hose

2380N-025V10



Small diameter hose with low volumetric expansion. Long continuous lengths.

Construction

- Core Tube: Polyamide 12
- Pressure Reinforcement: Two spiral layers and two open spiral layers of high tensile steel wire,
- Cover: Polyurethane
- Standard Color: x0 - Black

Temperature

- Temperature Range: -40°F to 212°F (-40°C to 100°C)

Design Factor

- 4

[Visit the webpage](#)

Part Number	Nominal I.D.		Max. O.D.		Max. Working Pressure		Min. Bend Radius		Weight		Fitting Series		
	DN	Size	inch	mm	inch	mm	psi	bar	inch	mm		lbs./ft.	kg/mtr
2380N-025V10	4	-025	5/32	4	0.38	9.7	10,875	750	2.17	55	0.11	0.16	8X

1018X - NPT Male

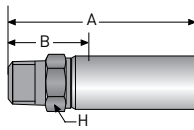

Part Number	Nominal I.D.		Thread Size	Overall Length A		Cutoff Allow. B		H Hex			
	DN	Size		inch	mm	inch	mm	inch	mm		
1018X-2-025	4	-025	5/32	4	1/8" - 27	1.86	47	0.76	19	0.62	16
1018X-4-025					1/4" - 18	2.30	59	1.24	32	0.51	13

Carbon Steel, Zinc-plated

1068X - JIC 37° Female Flare

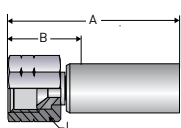

Part Number	Nominal I.D.		Thread Size	Overall Length A		Cutoff Allow. B		J Hex		Max. Working Pressure			
	DN	Size		inch	mm	inch	mm	inch	mm	psi	bar		
1068X-4-025	4	-025	5/32	4	7/16" - 20	2.35	60	1.30	33	0.56	14	10,000	690

Carbon Steel, Zinc-plated

Accessories Part Numbers

Bend Restrictor

MBR008

Technical details available in Section D.

WARNING

This product can expose you to chemicals including Lead, which is known to the State of California to cause cancer and birth defects or other reproductive harm. For more information go to www.P65Warnings.ca.gov.

1/4" - 10,150 psi Hydraulic Hose

2380N-04V0x

Up to 25% lighter than rubber hose



Construction

- Core Tube: Polyamide 12
- Pressure Reinforcement: Two spiral layers and two open spiral layers of high tensile steel wire
- Cover: Polyurethane
- Standard Color: x0 - Black, x2 - Blue, x3 - Green, x4 - Red, x6 - Yellow

Temperature

- Temperature Range: -40°F to 212°F (-40°C to 100°C)

Design Factor

- 4

[Visit the webpage](#)

Part Number	Nominal I.D.				Max. O.D.		Max. Working Pressure		Min. Bend Radius		Weight		Fitting Series
	DN	Size	inch	mm	inch	mm	psi	bar	inch	mm	lbs./ft.	kg/mtr	
2380N-04V00	6	-04	1/4	6.4	0.52	12.3	10,150	690	2.80	70	0.18	0.27	8X
2380N-04V02	6	-04	1/4	6.4	0.52	12.3	10,150	690	2.80	70	0.18	0.27	8X
2380N-04V03	6	-04	1/4	6.4	0.52	12.3	10,150	690	2.80	70	0.18	0.27	8X
2380N-04V04	6	-04	1/4	6.4	0.52	12.3	10,150	690	2.80	70	0.18	0.27	8X
2380N-04V06	6	-04	1/4	6.4	0.52	12.3	10,150	690	2.80	70	0.18	0.27	8X

1018X - NPT Male

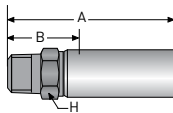

Part Number	Nominal I.D.				Thread Size	Overall Length A		Cutoff Allow. B		H Hex	
	DN	Size	inch	mm		inch	mm	inch	mm	inch	mm
1018X-4-04	6	-04	1/4	6.4	1/4" - 18	2.54	65	1.30	33	0.560	14
1018X-4-04C											
1018X-6-04					2.64	67	1.38	35	0.750	19	
1018X-6-04C											

Carbon Steel, Zinc-plated C - All components Stainless Steel

1068X - JIC 37° Female Flare

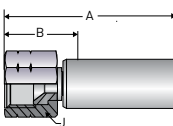

Part Number	Nominal I.D.				Thread Size	Overall Length A		Cutoff Allow. B		J Hex	
	DN	Size	inch	mm		inch	mm	inch	mm	inch	mm
1068X-4-04	6	-04	1/4	6.4	7/16" - 18	2.24	57	1.02	26	.750	19
1068X-4-04C											
1068X-6-04					3.41	87	0.94	24			
1068X-6-04C											

Carbon Steel, Zinc-plated C - All components Stainless Steel

1A98X - Type "M" Swivel - Female

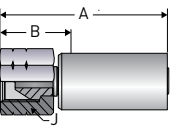

Part Number	Nominal I.D.				Thread Size	Overall Length A		Cutoff Allow. B		J Hex	
	DN	Size	inch	mm		inch	mm	inch	mm	inch	mm
1A98X-6-04	6	-04	1/4	6.4	9/16" - 18	2.60	66	1.38	35	0.670	17
1A98X-6-04C											

Carbon Steel, Zinc-plated C - All components Stainless Steel

Accessories Part Numbers

Heavy Duty Abrasion Cover	Transition Sleeves	Support Grips	Spring Guard	Bend Restrictor
MHDC012	510-A-500-12	MCG001SS MCGHS10-15	MSG2106	MBR010 *HG8X-04

*Rigid polymer Ø1-3/16" x 5-1/8" length 01 Technical details available in Section D. Containment Shield & Sleeves

WARNING

This product can expose you to chemicals including Lead, which is known to the State of California to cause cancer and birth defects or other reproductive harm. For more information go to www.P65Warnings.ca.gov.

5/16" - 9,060 psi Hydraulic Hose

2380N-05V00

Small diameter hose with low volumetric expansion. Long continuous lengths.



Construction

- Core Tube: Polyamide 12
- Pressure Reinforcement: Two spiral layers and two open spiral layers of high tensile steel wire
- Cover: Polyurethane
- Standard Color: x0 - Black

Temperature

- Temperature Range: -40°F to 212°F (-40°C to 100°C)

Design Factor

- 4

[Visit the webpage](#)

Part Number	Nominal I.D.				Max. O.D.		Max. Working Pressure		Min. Bend Radius		Weight		Fitting Series
	DN	Size	inch	mm	inch	mm	psi	bar	inch	mm	lbs./ft.	kg/mtr	
2380N-05V00	8	-05	5/16	7.9	0.62	15.8	9,060	625	3.54	90	0.24	0.35	LX

601LX - NPT Male

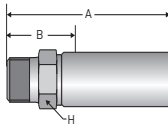

Part Number	Nominal I.D.				Thread Size	Overall Length A		Cutoff Allow. B		H Hex	
	DN	Size	inch	mm		inch	mm	inch	mm	inch	mm
601LX-4-5C	8	-05	5/16	7.9	1/4" - 18	2.78	71	1.18	30	0.62	15.8
601LX-6-5					3/8" - 18	3.96	75	1.37	35	0.75	19
601LX-6-5C											

Carbon Steel, Zinc Plated C - All components Stainless Steel

606LX - JIC 37° Female Flare

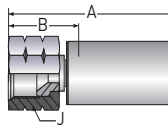

Part Number	Nominal I.D.				Thread Size	Overall Length A		Cutoff Allow. B		J Hex	
	DN	Size	inch	mm		inch	mm	inch	mm	inch	mm
606LX-6-5C	8	-05	5/16	7.9	9/16" - 18	2.80	71	1.03	26	0.75	19

C - All components Stainless Steel

6AYLX - Type "M" Swivel - Female

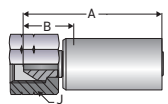

Part Number	Nominal I.D.				Thread Size	Overall Length A		Cutoff Allow. B		J Hex	
	DN	Size	inch	mm		inch	mm	inch	mm	inch	mm
6AYLX-8-5C	8	-05	5/16	7.9	3/4" - 16 UNF	3.57	91	1.80	46	1	25

C - All components Stainless Steel



WARNING

This product can expose you to chemicals including Lead, which is known to the State of California to cause cancer and birth defects or other reproductive harm. For more information go to www.P65Warnings.ca.gov.

1-1/4" - 3,990 psi Hydraulic Hose

2380N-20V30



Small diameter hose with low volumetric expansion. Long continuous lengths.

Construction

- Core Tube: Polyamide 12
- Pressure Reinforcement: Two spiral layers and two open spiral layers of high tensile steel wire
- Cover: Polyamide
- Standard Color: x0 - Black

Temperature

- Temperature Range:
-40°F to 212°F (-40°C to 100°C)

Design Factor

- 4

[Visit the webpage](#)

Part Number	Nominal I.D.		Max. O.D.		Max. Working Pressure		Min. Bend Radius		Weight		Fitting Series		
	DN	Size	inch	mm	inch	mm	psi	bar	inch	mm		lbs./ft.	kg/mtr
2380N-20V30	32	-20	1-1/4	31.8	1.73	44	3,990	275	15-3/4	400	1.23	1.83	NX

1C9NX - Metric Swivel - Female

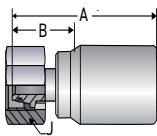

Part Number	Nominal I.D.		Thread Size	Overall Length A		Cutoff Allow. B		J Hex			
	DN	Size		inch	mm	inch	mm	inch	mm		
1C9NX-38-20	32	-20	1-1/4	31.8	M 52 x 2	4.45	113	2.05	52	2.36	60

Carbon Steel

11CNX - 90° Metric Female Swivel 24° with O-ring

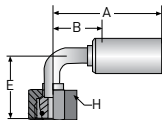

Part Number	Nominal I.D.		Thread Size	Overall Length A		Cutoff Allow. B		H Hex		E			
	DN	Size		inch	mm	inch	mm	inch	mm	inch	mm		
11CNX-38-20	32	-20	1-1/4	31.8	M 52 x 2	5.91	150	3.50	89	2.36	60	3.07	80

C - All components Stainless Steel

106NX- JIC 37° Female Flare

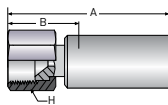

Part Number	Nominal I.D.		Thread Size	Overall Length A		Cutoff Allow. B		H Hex			
	DN	Size		inch	mm	inch	mm	inch	mm		
106NX-20-20	32	-20	1-1/4	31.8	1-5/8" - 12	4.09	104	1.73	44	1.97	50

C - Carbon Steel, Zinc Plated



WARNING

This product can expose you to chemicals including Lead, which is known to the State of California to cause cancer and birth defects or other reproductive harm. For more information go to www.P65Warnings.ca.gov.

1/4" - 11,600 psi Hydraulic Hose

2388N-04V14



Up to 35% lighter weight than a rubber hose assembly

Construction

- Core Tube: Polyamide 12
- Pressure Reinforcement: Two closed spiral layers and two open spiral layers of high tensile steel wire
- Cover: Polyurethane
- Standard Color: x4- Red

Temperature

- Temperature Range: -40°F to 212°F (-40°C to 100°C)

Design Factor

- 4

Part Number	Nominal I.D.				Max. O.D.		Max. Working Pressure		Min. Bend Radius		Weight		Fitting Series
	DN	Size	inch	mm	inch	mm	psi	bar	inch	mm	lbs./ft.	kg/mtr	
2388N-04V14	6	04	1/4	6.3	0.53	13.4	11,600	800	3.15	80	0.20	0.30	8X

1018X - NPT Male

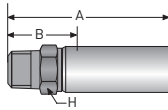

Part Number	Nominal I.D.				Thread Size	Overall Length A		Cutoff Allow. B		H Hex	
	DN	Size	inch	mm		inch	mm	inch	mm	inch	psi
1018X-4-04	6	-04	1/4	6.4	1/4" - 18 NPT	2.54	65	1.30	33	0.56	14
1018X-4-04C	6	-04	1/4	6.4	1/4" - 18 NPT	2.54	65	1.30	33	0.56	14
1018X-6-04	6	-04	1/4	6.4	3/8" - 18 NPT	2.64	67	1.38	35	0.75	19

Carbon Steel, Zinc-plated C - All components Stainless Steel

1068X - JIC Female Swivel

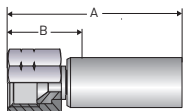

Part Number	Nominal I.D.				Thread Size	Overall Length A		Cutoff Allow. B		J Hex		Max Working Pressure	
	DN	Size	inch	mm		inch	mm	inch	mm	inch	mm	psi	bar
1068X-4-04C	6	-04	1/4	6.4	7/16" - 20 UNF	2.24	57	1.02	26	0.75	19	10,000	690
1068X-6-04	6	-04	1/4	6.4	9/16" - 18 UNF	2.17	55	0.94	24	0.75	19	10,000	690
1068X-6-04C	6	-04	1/4	6.4	9/16" - 18 UNF	2.17	55	0.94	24	0.75	19	10,000	690

Carbon Steel, Zinc-plated C - All components Stainless Steel

1AY8X - Type "M" Swivel - Female

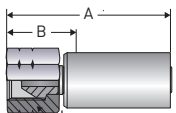

Part Number	Nominal I.D.				Thread Size	Overall Length A		Cutoff Allow. B		J Hex	
	DN	Size	inch	mm		inch	mm	inch	mm	inch	mm
1AY8X-6-04	6	-04	1/4	6.4	9/16" - 18 UNF	2.36	60	1.10	28	0.75	19

Carbon Steel, Zinc-plated C - All components Stainless Steel



WARNING

This product can expose you to chemicals including Lead, which is known to the State of California to cause cancer and birth defects or other reproductive harm. For more information go to www.P65Warnings.ca.gov.

1/2" - 15,950 psi Hydraulic Hose

2388N-08V14



Up to 35% lighter weight than a rubber hose assembly

Construction

- Core Tube: Polyamide 12
- Pressure Reinforcement: Two closed spiral layers and two open spiral layers of high tensile steel wire
- Cover: Polyurethane
- Standard Color: x4- Red

Temperature

- Temperature Range: -40°F to 212°F (-40°C to 100°C)

Design Factor

- 2.5

Certification

- DIN EN1829-2 compliant

[Visit the webpage](#)

Part Number	Nominal I.D.		Max. O.D.		Max. Working Pressure		Min. Bend Radius		Weight		Fitting Series		
	DN	Size	inch	mm	inch	mm	psi	bar	inch	mm		lbs./ft.	kg/mtr
2388N-08V14	13	-08	1/2	12.7	0.91	23.1	15,950	1,100	4.72	120	0.54	0.80	BS

101BS - NPT Male

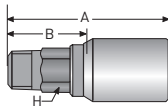

Part Number	Nominal I.D.		Thread Size	Overall Length A		Cutoff Allow. B		H Hex		Max. Working Pressure			
	DN	Size		inch	mm	inch	mm	inch	mm	psi	bar		
101BS-8-08	13	-08	1/2	12.7	1/2" - 14	3.66	93	1.56	40	0.87	22	15,000	1,034
101BS-8-08C													

Carbon Steel, Zinc-plated C - All components Stainless Steel

1C9BS - Metric Swivel - Female

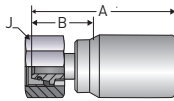

Part Number	Nominal I.D.		Thread Size	Overall Length A		Cutoff Allow. B		J Hex			
	DN	Size		inch	mm	inch	mm	inch	mm		
1C9BS-16-08	13	-08	1/2	12.7	M 24 x 1.5	3.50	89	1.43	36	1.18	30
1C9BS-16-08C											

Carbon Steel, Zinc-plated C - All components Stainless Steel

1AYBS - Type "M" Swivel - Female

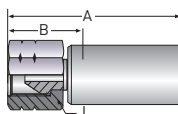

Part Number	Nominal I.D.		Thread Size	Overall Length A		Cutoff Allow. B		J Hex			
	DN	Size		inch	mm	inch	mm	inch	mm		
1AYBS-11-08	13	-08	1/2	12.7	1" - 12	3.43	87	1.77	45	1.25	32
1AYBS-11-08C											

Carbon Steel, Zinc-plated C - All components Stainless Steel

Accessories Part Numbers

Heavy Duty Abrasion Cover	Transition Sleeves	Support Grips	Hose Stop
MHDC018	216-200-18	MCGHS 30-40	AH-08S

Technical details available in Section D.



WARNING

This product can expose you to chemicals including Lead, which is known to the State of California to cause cancer and birth defects or other reproductive harm. For more information go to www.P65Warnings.ca.gov.

3/8" - 6,450 psi Hydraulic High Pressure Hose

2390N-06V13



Low dimensional change under pressure resulting in excellent response times

Construction

- Core Tube: Polyamide 12
- Pressure Reinforcement: Two closed spiral layers and two open spiral layers of high tensile steel wire
- Cover: Sea water resistant polyurethane
- Standard Color: x3 - Green

Temperature

- Temperature Range: -40°F to 212°F (-40°C to 100°C)*

Certifications

- Meets or exceeds the performance requirements of ISO 13628-5

Design Factor

- 4

Notes

- *Temperature: -40°F to 212°F (-40°C to 100°C), max. 158°F (70°C) for water/glycol and methanol based fluids.

[Visit the webpage](#)

Part Number	Nominal I.D.				Max. O.D.		Max. Working Pressure		Min. Bend Radius		Weight		Fitting Series
	DN	Size	inch	mm	inch	mm	psi	bar	inch	mm	lbs./ft.	kg/mtr	
2390N-06V13	10	-6	3/8	9.5	0.71	18.1	6,450	445	4.72	120	0.28	0.41	9X

6019X - NPT Male

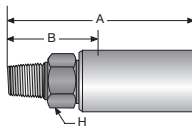

Part Number	Nominal I.D.				Thread Size	Overall Length A		Cutoff Allow. B		H Hex	
	DN	Size	inch	mm		inch	mm	inch	mm	inch	mm
6019X-6-6C	10	-06	3/8	9.5	3/8" - 18	2.95	75	1.35	34	0.75	19

C - All components Stainless Steel

6A9X - Type "M" Swivel - Female

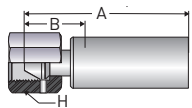

Part Number	Nominal I.D.				Thread Size	Overall Length A		Cutoff Allow. B		H Hex	
	DN	Size	inch	mm		inch	mm	inch	mm	inch	mm
6A9X-8-6C	10	-06	3/8	9.5	3/4" - 16	2.79	71	1.19	30	1	25

C - All components Stainless Steel Non-standard, lead time may be longer

1069X - JIC 37° Female Flare

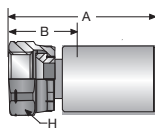

Part Number	Nominal I.D.				Thread Size	Overall Length A		Cutoff Allow. B		H Hex	
	DN	Size	inch	mm		inch	mm	inch	mm	inch	mm
1069X-6-6C	10	-06	3/8	9.5	7/16" - 20	3.64	92	1.74	44	1	25

C - All components Stainless Steel

WARNING

This product can expose you to chemicals including Lead, which is known to the State of California to cause cancer and birth defects or other reproductive harm. For more information go to www.P65Warnings.ca.gov.

1/2" - 6,017 psi Hydraulic Hose

2390N-08V1x

Low dimensional change under pressure
resulting in excellent response times



Construction

- Core Tube: Polyamide
- Pressure Reinforcement: Two closed spiral layers and two open spiral layers of high tensile steel wire
- Cover: Sea water resistant polyurethane
- Standard Color: x3 - Green, x2 - Blue, x6 - Yellow

Temperature

- Temperature Range:
-40°F to 212°F (-40°C to 100°C)*

Design Factor

- 4

Certifications

- Meets or exceeds the performance requirements of ISO 13628-5

Notes

- *Operating temperature will vary depending on the fluid. Consult Parker if more information required.

[Visit the webpage](#)

Part Number	Nominal I.D.				Max. O.D.		Max. Working Pressure		Min. Bend Radius		Weight		Fitting Series
	DN	Size	inch	mm	inch	mm	psi	bar	inch	mm	lbs./ft.	kg/mtr	
2390N-08V12	13	-08	1/2	12.7	0.83	21.2	6,017	415	5.91	150	0.36	0.54	9X
2390N-08V13	13	-08	1/2	12.7	0.83	21.2	6,017	415	5.91	150	0.36	0.54	9X
2390N-08V16	13	-08	1/2	12.7	0.83	21.2	6,017	415	5.91	150	0.36	0.54	9X

6019X - NPT Male

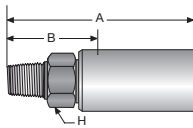

Part Number	Nominal I.D.				Thread Size	Overall Length A		Cutoff Allow. B		H Hex	
	DN	Size	inch	mm		inch	mm	inch	mm	inch	mm
6019X-8-8C	13	-08	1/2	12.7	1/2" - 14	3.35	85	1.43	36	0.87	22

C - All components Stainless Steel Non-standard, lead time may be longer

6069X - Straight 37° JIC Female Flare

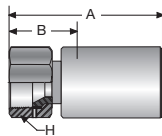

Part Number	Nominal I.D.				Thread Size	Overall Length A		Cutoff Allow. B		H Hex	
	DN	Size	inch	mm		inch	mm	inch	mm	inch	mm
6069X-8-8C	13	-08	1/2	12.7	3/4" - 16	3.00	76	1.30	33	0.87	22

C - All components Stainless Steel Non-standard, lead time may be longer

6AY9X - Type "M" Swivel - Female

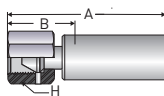

Part Number	Nominal I.D.				Thread Size	Overall Length A		Cutoff Allow. B		H Hex	
	DN	Size	inch	mm		inch	mm	inch	mm	inch	mm
6AY9X-11-8C	13	-08	1/2	12.7	1" - 12	3.22	82	1.52	39	1.25	32

C - All components Stainless Steel Non-standard, lead time may be longer

WARNING

This product can expose you to chemicals including Lead, which is known to the State of California to cause cancer and birth defects or other reproductive harm. For more information go to www.P65Warnings.ca.gov.

1" - 4,060 psi Hydraulic Hose

2390N-16V13



Low dimensional change under pressure resulting in excellent response times

Construction

- Core Tube: Polyamide 12
- Pressure Reinforcement: Two closed spiral layers and two open spiral layers of high tensile steel wire
- Cover: Sea water resistant polyurethane
- Standard Color: x3 - Green

Temperature

- Temperature Range: -40°F to 212°F (-40°C to 100°C)*

Design Factor

- 4

Notes

- *Temperature: -40°F to 212°F (-40°C to 100°C), max. 158°F (70°C) for water/glycol and methanol based fluids.

[Visit the webpage](#)

Part Number	Nominal I.D.		Max. O.D.		Max. Working Pressure		Min. Bend Radius		Weight		Fitting Series		
	DN	Size	inch	mm	inch	mm	psi	bar	inch	mm		lbs./ft.	kg/mtr
2390N-16V13	25	-16	1	25.4	1.38	35.0	4,060	280	11.02	280	0.79	1.17	E4

106E4 - JIC 37° Flare - Female

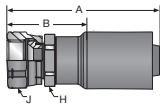

Part Number	Nominal I.D.		Thread Size	Overall Length A		Cutoff Allow. B		J Hex		H Hex			
	DN	Size		inch	mm	inch	mm	inch	mm	inch	mm		
106E4-16-16C	25	-16	1	25.4	1-5/16" - 12	4.76	121	2.38	60	1.62	41	1.50	38

C - All components Stainless Steel

137E4 - 45° JIC

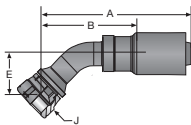

Part Number	Nominal I.D.		Thread Size	Overall Length A		Cutoff Allow. B		J Hex		E			
	DN	Size		inch	mm	inch	mm	inch	mm	inch	mm		
137E4-16-16C-411	25	-16	1	25.4	1-5/16" - 12	6.50	165	4.13	105	1.62	41	1.69	43

C - All components Stainless Steel

139E4 - 90° JIC

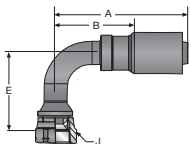

Part Number	Nominal I.D.		Thread Size	Overall Length A		Cutoff Allow. B		J Hex		E			
	DN	Size		inch	mm	inch	mm	inch	mm	inch	mm		
139E4-16-16C-411	25	-16	1	25.4	1-5/16" - 12	5.69	145	3.32	84	1.62	41	3.27	83

C - All components Stainless Steel

[continued on next page](#)

WARNING

This product can expose you to chemicals including Lead, which is known to the State of California to cause cancer and birth defects or other reproductive harm. For more information go to www.P65Warnings.ca.gov.

1" - 4,060 psi Hydraulic Hose

2390N-16V13

19GE4 - Straight Dual Seal

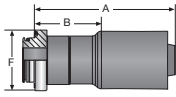

Part Number	Nominal I.D.				Overall Length A		Cutoff Allow. B		F
	DN	Size	inch	mm	inch	mm	inch	mm	inch
19GE4-16-16C	25	-16	1	25.4	4.35	110	2.00	51	1
19GE4-24-16C					4.48	114	2.13	54	1-1/2

C - All components Stainless Steel

19ME4 - 45° Dual Seal

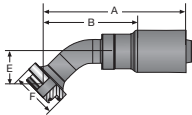

Part Number	Nominal I.D.				Overall Length A		Cutoff Allow. B		F	E	
	DN	Size	inch	mm	inch	mm	inch	mm	inch	inch	mm
19ME4-16-16C	25	-16	1	25.4	6.24	158	3.88	99	1	1.42	36
19ME4-24-16C					6.32	161	3.93	100	1-1/2	1.86	47

C - All components Stainless Steel

19WE4 - 90° Dual Seal

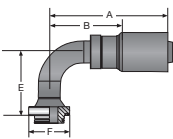

Part Number	Nominal I.D.				Overall Length A		Cutoff Allow. B		F	E	
	DN	Size	inch	mm	inch	mm	inch	mm	inch	inch	mm
19WE4-16-16C	25	-16	1	25.4	5.69	145	3.13	80	1	3.27	83
19WE4-24-16C					5.69	145	3.52	89	1-1/2	3.52	89

C - All components Stainless Steel



WARNING

This product can expose you to chemicals including Lead, which is known to the State of California to cause cancer and birth defects or other reproductive harm. For more information go to www.P65Warnings.ca.gov.

Oil & Gas Hose



Oil & Gas Hose

Table Of Contents

Introduction

Fitting Configurations.....	A-77
Oil & Gas Size and Pressure Overview.....	A-78
Black Eagle Size and Pressure Overview.....	A-96
PFDE-ES28 for Black Eagle Hose.....	A-98

Hose Series

2022N-06.....	A-79
2022N-08.....	A-80
2340N-24.....	A-81
2380N-04.....	A-82
2380N-16.....	A-83
2390N-025.....	A-85
2390N-04.....	A-86
2390N-08.....	A-87
2390N-16.....	A-88
2440N-08.....	A-89
2440N-12.....	A-90
2440N-16.....	A-91
2448N-04.....	A-92
HCRV-8.....	A-94
HCRV-16.....	A-95



BLACK EAGLE Oilfield Service Hose	
2640N-24.....	A-127
2448N-32.....	A-128
2580N-32.....	A-129
2648N-32.....	A-130
2240N-48.....	A-131
2440N-48.....	A-132
2640N-48.....	A-133



Fitting Configurations

by Connection and End Code

End Code	Description
Pipe 01	Male NPT Pipe - Rigid - Straight
Flare 06 39	JIC 37° Flare – Female Female JIC 37° - Swivel - 90° Elbow - Short Drop
Metric C9	Female Metric S - Swivel - Straight (24° Cone)
BSP 92	Female BSP Parallel Pipe - Swivel - Straight (60° Cone)
Specialty 5Y 9G 9M 9W AY GX HB HE HN Y2	Medium Pressure Swivel - Female Straight Dual Seal 45° Dual Seal 90° Dual Seal Type "M" Swivel - Female Grayloc Straight API Clamping Hub Hammer Union (Male) Cone w/Wing Nut Hammer Union (Female) Cone Threaded End w/ Seal Medium Pressure Male

Oil & Gas Hose Size and Pressure Overview

Part Number	Dimension Data						Max. Working Pressure		Min. Bend Radius		Weight		Fitting	Design Factor
	DN	Size	I.D. inch	I.D. mm	O.D. inch	O.D. mm	psi	bar	inch	mm	lbs./ft.	kg/mtr		
DN4														
2390N-025V10	4	-025	5/32	4.0	0.38	9.7	7,500	517	2.16	55	0.11	0.16	8X	4.0
DN6														
2380N-04V91	6	-04	1/4	6.4	0.53	13.4	10,000	690	2.80	70	0.18	0.27	8X	4.0
2390N-04V1x	6	-04	1/4	6.4	0.52	13.3	7,107	490	2.76	70	0.17	0.25	E3	4.0
2448N-04V91	6	-04	1/4	6.4	0.54	13.7	15,000	1,035	5.90	150	0.26	0.38	8X	4.0
DN10														
2022N-06V91-10K	10	-06	3/8	9.5	0.75	19.0	10,000	690	3.94	100	0.16	0.24	3X	4.0
DN12														
2022N-08V91-10K	13	-08	1/2	12.7	0.97	23.2	10,000	690	3.94	100	0.23	0.34	LX	4.0
2390N-08V1x	13	-08	1/2	12.7	0.83	21.2	6,017	415	5.91	150	0.36	0.54	E3	4.0
2440N-08V91	13	-08	1/2	12.7	0.89	22.7	11,745	810	7.87	200	0.63	0.94	LX	4.0
HCRV-8-x	13	-08	1/2	12.7	1.04	26.4	5,000	345	4.00	102	0.45	0.67	HV	4.0
DN20														
2440N-12V91	20	-12	3/4	19.0	1.19	30.2	10,000	690	9.84	250	0.98	1.46	LX	3.6
DN25														
2380N-16V1x	25	-16	1	25.4	1.45	36.8	5,510	380	11.4	290	1.00	1.49	E4	4.0
2440N-16V91	25	-16	1	25.4	1.46	37.2	8,120	560	11.8	300	1.34	2.00	LX	4.0
HCRV-16-x	25	-16	1	25.4	1.83	46.4	5,000	345	11.8	300	1.44	2.15	HV	4.0
DN40														
2640N-24V80-15K	40	-24	1-1/2	38.1	2.60	66.0	15,000	1,035	19.7	500	4.37	6.5	5X	4.0
2340N-24V10	40	-24	1-1/2	38.1	2.19	55.5	5,000	345	17.7	450	2.40	3.5	8X	4.0
DN50														
2448N-32V80	50	-32	2	51.0	3.17	80.5	5,000	345	20.0	508	5.71	8.5	5X	4.0
2580N-32V80	50	-32	2	51.0	3.33	84.5	10,000	690	32.0	813	6.32	9.4	5X	2.5
2648N-32V80	50	-32	2	51.0	3.39	86.0	15,000	1,035	31.0	787	8.13	12.1	CX	2.25
DN78														
2240N-48V80	78	-48	3	76.0	4.49	114.0	5,000	345	39.9	1000	7.73	11.5	TX	2.5
2440N-48V80	78	-48	3	76.0	4.80	122.0	10,000	690	43.3	1100	12.57	18.7	LX	2.5
2640N-48V80	78	-48	3	76.0	5.13	130.3	15,000	1,035	47.3	1200	18.48	27.5	5X	2.25

3/8" - 10,000 psi Oil & Gas Hose

2022N-06V91-10K



Long-length hose and hose umbilicals requiring lightweight construction

Construction

- Core Tube: Polyamide 11, methanol washed
- Pressure Reinforcement: High tensile aramid fiber braid
- Cover: Sea water resistant polyurethane
- Standard Color: x0 - Black

Temperature

- Temperature Range: -40°F to 131°F (-40°C to 55°C)

Design Factor

- 4

Certifications

- ISO 13628-5 "Specification for Subsea Production Control Umbilicals", Section 7.9 Hose construction

Notes

- Cover pin-pricked on request to allow adequate venting of permeable fluids.

[Visit the webpage](#)

Part Number	Nominal I.D.				Max. O.D.		Max. Working Pressure		Min. Bend Radius		Weight		Fitting Series
	DN	Size	inch	mm	inch	mm	psi	bar	inch	mm	lbs./ft.	kg/mtr	
2022N-06V91-10K	10	-06	3/8	9.5	0.75	19.0	10,000	690	3.94	100	0.16	0.24	3X

1063X - JIC 37° Female Flare

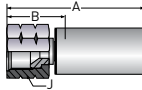

Part Number	Nominal I.D.				Thread Size	Overall Length A		Cutoff Allow. B		J Hex	Max. Working Pressure		
	DN	Size	inch	mm		inch	mm	inch	mm		inch	mm	psi
1063X-6-06C	10	-06	3/8	9.5	9/16" - 18	2.72	69	1.14	29	0.87	22	10,000	690

C - All components Stainless Steel



WARNING

This product can expose you to chemicals including Lead, which is known to the State of California to cause cancer and birth defects or other reproductive harm. For more information go to www.P65Warnings.ca.gov.

1/2" - 10,000 psi Oil & Gas Hose

2022N-08V91-10K



Long-length hose and hose umbilicals requiring lightweight construction

Construction

- Core Tube: Polyamide 11, methanol washed
- Pressure Reinforcement: High tensile aramid fiber braid
- Cover: Sea water resistant polyurethane
- Standard Color: x0 - Black

Temperature

- Temperature Range: -40°C to 212°F (-40°C to 100°C)

Design Factor

- 4

Certifications

- ISO 13628-5 "Specification for Subsea Production Control Umbilicals", Section 7.9 Hose construction

[Visit the webpage](#)

Part Number	Nominal I.D.				Max. O.D.		Max. Working Pressure		Min. Bend Radius		Weight		Fitting Series
	DN	Size	inch	mm	inch	mm	psi	bar	inch	mm	lbs./ft.	kg/mtr	
2022N-08V91-10K	13	-08	1/2	12.7	0.97	23.2	10,000	690	3.94	100	0.23	0.34	LX

101LX - NPT Male

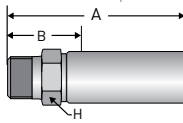

Part Number	Nominal I.D.				Thread Size	Overall Length A		Cutoff Allow. B		H Hex	
	DN	Size	inch	mm		inch	mm	inch	mm	inch	mm
101LX-8-08C	13	-8	1/2	12.7	1/2" - 14	3.58	91	1.46	37	0.87	35

C - All components Stainless Steel

1AYLX - Type "M" Swivel - Female

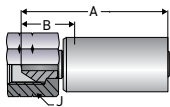

Part Number	Nominal I.D.				Thread Size	Overall Length A		Cutoff Allow. B		J Hex	
	DN	Size	inch	mm		inch	mm	inch	mm	inch	mm
1AYLX-11-08C	13	-08	1/2	12.7	1" - 12	3.43	87	1.77	45	1.26	32

C - All components Stainless Steel

106LX - JIC 37° Female Flare

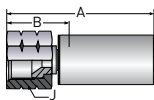

Part Number	Nominal I.D.				Thread Size	Overall Length A		Cutoff Allow. B		J Hex	
	DN	Size	inch	mm		inch	mm	inch	mm	inch	mm
106LX-8-08C	13	-08	1/2	12.7	3/4" - 16	2.52	64	0.83	21	1.06	27

C - All components Stainless Steel

1C9LX - Metric Swivel - Female

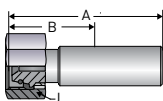

Part Number	Nominal I.D.				Thread Size	Overall Length A		Cutoff Allow. B		J Hex	
	DN	Size	inch	mm		inch	mm	inch	mm	inch	mm
1C9LX-16-08C	13	-08	1/2	12.7	M 24 x 1.5	3.46	88	1.34	34	1.26	32

C - All components Stainless Steel

WARNING

This product can expose you to chemicals including Lead, which is known to the State of California to cause cancer and birth defects or other reproductive harm. For more information go to www.P65Warnings.ca.gov.

1-1/2" - 5,000* psi Oil & Gas Hose

2340N-24V10



Oilfield Service Hose
is ParKrimpable

Construction

- Core Tube: Polyamide 11
- Pressure Reinforcement: Two spiral layers of high tensile steel wire
- Cover: Polyurethane

Temperature

- Temperature Range:
-40°F to 212°F (-40°C to 100°C)**

Certifications

- ISO 13628-5

Design Factor

- 4

Notes

- **Operating temperature will vary depending on the fluid. Consult Parker for more information.

[Visit the webpage](#)

Part Number	Nominal I.D.				Max. O.D.		Max. Working Pressure		Min. Bend Radius		Weight		Fitting Series
	DN	Size	inch	mm	inch	mm	psi	bar	inch	mm	lbs./ft.	kg/mtr	
2340N-24V10	40	-24	1-1/2	38.1	2.19	55.5	5,000	345	17.7	450	2.4	3.5	8X

1068X - JIC 37° Female Flare

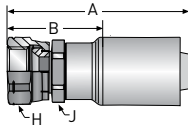

Part Number	Nominal I.D.				Thread Size	Overall Length A		Cutoff Allow. B		H Hex		J Hex	
	DN	Size	inch	mm		inch	mm	inch	mm	inch	mm	inch	mm
1068X-24-24C	40	-24	1-1/2	38.1	1-7/8" - 12 UN	6.82	173	3.51	89	2.56	65	2.16	55

C - All components Stainless Steel



WARNING

This product can expose you to chemicals including Lead, which is known to the State of California to cause cancer and birth defects or other reproductive harm. For more information go to www.P65Warnings.ca.gov.

1/4" - 10,000 psi Oil & Gas Hose

2380N-04V91



Up to 25% lighter than rubber hose

Construction

- Core Tube: Polyamide 11, methanol washed
- Pressure Reinforcement: Two closed spiral layers and two open spiral layers of high tensile steel wire
- Cover: Polyamide 12
- Standard Color: Black

Temperature

- Temperature Range: -40°F to 212°F (-40°C to 100°C)

Design Factor

- 4

Certifications

- Meets/exceeds performance requirements of ISO 13628-5/API 17En

Notes

- Warning tags are required for all hose assemblies.
- Bend restrictors are required for all hand held applications. Parker Parflex suggests the use bend restrictors for all assemblies.

[Visit the webpage](#)

Part Number	Nominal I.D.				Max. O.D.		Max. Working Pressure		Min. Bend Radius		Weight		Fitting Series
	DN	Size	inch	mm	inch	mm	psi	bar	inch	mm	lbs./ft.	kg/mtr	
2380N-04V91	6	-04	1/4	6.4	0.53	13.4	10,000	690	2.80	70	0.18	0.27	8X

1018X - NPT Male

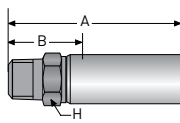

Part Number	Nominal I.D.				Thread Size	Overall Length A		Cutoff Allow. B		H Hex	
	DN	Size	inch	mm		inch	mm	inch	mm	inch	mm
1018X-4-04C	6	-04	1/4	6.4	1/4" - 18	2.54	65	1.30	33	0.56	14
1018X-6-04C					3/8" - 18	2.64	67	1.38	35	0.75	19

C - All components Stainless Steel

1A18X - Type "M" Swivel - Female

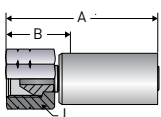

Part Number	Nominal I.D.				Thread Size	Overall Length A		Cutoff Allow. B		J Hex	
	DN	Size	inch	mm		inch	mm	inch	mm	inch	mm
1A18X-6-04C	6	-04	1/4	6.4	9/16" - 18	2.6	66	1.38	35	0.60	17

C - All components Stainless Steel

1068X - JIC 37° Female Flare

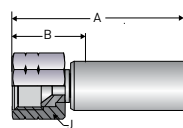

Part Number	Nominal I.D.				Thread Size	Overall Length A		Cutoff Allow. B		J Hex	
	DN	Size	inch	mm		inch	mm	inch	mm	inch	mm
1068X-4-04C	6	-04	1/4	6.4	7/16" - 18	2.24	57	1.02	26	.750	19
1068X-6-04C					9/16" - 18	2.17	55	0.94	24		

C - All components Stainless Steel



WARNING

This product can expose you to chemicals including Lead, which is known to the State of California to cause cancer and birth defects or other reproductive harm. For more information go to www.P65Warnings.ca.gov.

1" - 5,510 psi Oil & Gas Hose

2380N-16V1x

Up to 25% lighter than rubber hose



Construction

- Core Tube: Polyamide
- Pressure Reinforcement: Two closed spiral layers and two open spiral layers of high tensile steel wire
- Cover: Sea water resistant polyurethane
- Standard Color: x3 - Green, x2 - Blue, x6 - Yellow

Temperature

- Temperature Range: -40°F to 212°F (-40°C to 100°C)

Certifications

- Meets/exceeds performance requirements of ISO 13628-5/API 17En

Design Factor

- 4

Notes

- Warning tags are required for all hose assemblies.
- Bend restrictors are required for all hand held applications. Parker Parflex suggests the use bend restrictors for all assemblies.

[Visit the webpage](#)

Part Number	Nominal I.D.			Max. O.D.		Max. Working Pressure		Min. Bend Radius		Weight		Fitting Series	
	DN	Size	inch	mm	inch	mm	psi	bar	inch	mm	lbs./ft.		kg/mtr
2380N-16V12	25	-16	1	25.4	1.45	36.8	5,000	345	11.4	290	1	1.49	E4
2380N-16V13	25	-16	1	25.4	1.45	36.8	5,000	345	11.4	290	1	1.49	E4
2380N-16V16	25	-16	1	25.4	1.45	36.8	5,000	345	11.4	290	1	1.49	E4

19ME4 - 45° Dual Seal

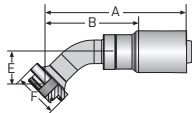

Part Number	Nominal I.D.			Overall Length A		Cutoff Allow. B		F	E		Max. Working Pressure		
	DN	Size	inch	mm	inch	mm	inch	mm	inch	mm	psi	bar	
19ME4-16-16C	25	-16	1	25.4	6.24	158	3.88	99	1	1.42	36	5,000	345
19ME4-24-16C					6.32	161	3.93	100	1-1/2	1.86	47	5,000	345

C - All components Stainless Steel

19WE4 - 90° Dual Seal

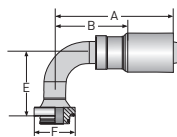

Part Number	Nominal I.D.			Overall Length A		Cutoff Allow. B		F	E		Max. Working Pressure		
	DN	Size	inch	mm	inch	mm	inch	mm	inch	mm	psi	bar	
19WE4-16-16C	25	-16	1	25.4	5.69	145	3.13	80	1	3.27	83	5,000	345
19WE4-24-16C					5.69	145	3.52	89	1-1/2	3.52	89	5,000	345

C - All components Stainless Steel

[continued on next page](#)



WARNING

This product can expose you to chemicals including Lead, which is known to the State of California to cause cancer and birth defects or other reproductive harm. For more information go to www.P65Warnings.ca.gov.

1" - 5,510 psi Oil & Gas Hose

2380N-16V1x

19GE4 - Straight Dual Seal

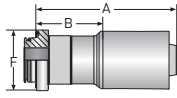

Part Number	Nominal I.D.				Overall Length A		Cutoff Allow. B		F	Max. Working Pressure	
	DN	Size	inch	mm	inch	mm	inch	mm	inch	psi	bar
19GE4-16-16C	25	-16	1	25.4	4.35	110	2.00	51	1	5,000	345
19GE4-24-16C					4.48	114	2.13	54	1-1/2		

C - All components Stainless Steel

139E4 - Female JIC 37° - Swivel - 90° Elbow - Short Drop

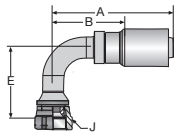

Part Number	Nominal I.D.				Thread Size	Overall Length A		Cutoff Allow. B		J Hex		E		Max. Working Pressure	
	DN	Size	inch	mm		inch	mm	inch	mm	inch	mm	inch	mm	psi	bar
139E4-16-16C-411	25	-16	1	25.4	1-5/16" - 12	5.69	145	3.32	84	1.62	41	3.27	83	5,000	345

C - All components Stainless Steel

106E4 - Straight JIC 37° Female

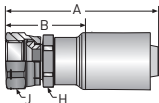

Part Number	Nominal I.D.				Thread Size	Overall Length A		Cutoff Allow. B		J Hex		H Hex		Max. Working Pressure	
	DN	Size	inch	mm		inch	mm	inch	mm	inch	mm	inch	mm	psi	bar
106E4-16-16C	25	-16	1	25.4	1-5/16" - 12	4.76	121	2.38	60	1.62	41	1.50	38	5,000	345

C - All components Stainless Steel



WARNING

This product can expose you to chemicals including Lead, which is known to the State of California to cause cancer and birth defects or other reproductive harm. For more information go to www.P65Warnings.ca.gov.

3/16" - 7,500 psi Oil & Gas Hose

2390N-025V10



Low dimensional change under pressure resulting in excellent response times

Construction

- Core Tube: Polyamide
- Pressure Reinforcement: Two closed spiral layers and two open spiral layers of high tensile steel wire
- Cover: Sea water resistant polyurethane
- Standard Color: x0 - Black

Temperature

- Temperature Range: -40°F to 212°F (-40°C to 100°C)

Design Factor

- 4

[Visit the webpage](#)

Part Number	Nominal I.D.				Max. O.D.		Max. Working Pressure		Min. Bend Radius		Weight		Fitting Series
	DN	Size	inch	mm	inch	mm	psi	bar	inch	mm	lbs./ft.	kg/mtr	
2390N-025V10	4	-025	5/32	4	0.38	9.7	7,500	517	2.16	55	0.11	0.16	8X

1068X - JIC 37° Female Flare

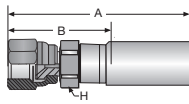

Part Number	Nominal I.D.				Thread Size	Overall Length A		Cutoff Allow. B		H Hex	
	DN	Size	inch	mm		inch	mm	inch	mm	inch	mm
1068X-4-025C-SUBSEA	4	-025	5/32	4	7/16" - 20	2.37	60	1.15	29	0.62	16

Carbon Steel, Zinc-plated C - All components Stainless Steel

WARNING

This product can expose you to chemicals including Lead, which is known to the State of California to cause cancer and birth defects or other reproductive harm. For more information go to www.P65Warnings.ca.gov.

1/4" - 7,100 psi Oil & Gas Hose

2390N-04V1x

Low dimensional change under pressure
resulting in excellent response times



Construction

- Core Tube: Polyamide
- Pressure Reinforcement: Two closed spiral layers and two open spiral layers of high tensile steel wire
- Cover: Sea water resistant polyurethane
- Standard Color: x3 - Green, x2 - Blue, x6 - Yellow, x0 - Black

Temperature

- Temperature Range: -40°F to 131°F (-40°C to 55°C)*

Certifications

- Meets or exceeds the performance requirements of ISO 13628-5

Design Factor

- 4

Notes

- *Operating temperature limited to 131°F (55°C) by E3 fittings.

[Visit the webpage](#)

Part Number	Nominal I.D.				Max. O.D.		Max. Working Pressure		Min. Bend Radius		Weight		Fitting Series
	DN	Size	inch	mm	inch	mm	psi	bar	inch	mm	lbs./ft.	kg/mtr	
2390N-04V10	6	-04	1/4	6.4	0.52	13.3	7,107	490	2.76	70	0.17	0.25	E3
2390N-04V12	6	-04	1/4	6.4	0.52	13.3	7,107	490	2.76	70	0.17	0.25	E3
2390N-04V13	6	-04	1/4	6.4	0.52	13.3	7,107	490	2.76	70	0.17	0.25	E3
2390N-04V16	6	-04	1/4	6.4	0.52	13.3	7,107	490	2.76	70	0.17	0.25	E3

139E3 - Female JIC 37° - Swivel - 90° Elbow - Short Drop

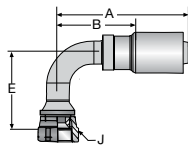

Part Number	Nominal I.D.				Thread Size	Overall Length A		Cutoff Allow. B		J Hex		E		Max. Working Pressure	
	DN	Size	inch	mm		inch	mm	inch	mm	inch	mm	inch	mm	psi	bar
139E3-4-4C	6	-04	1/4	6.4	7/16" - 20	2.41	61	1.38	35	0.62	16	0.83	21	5,000	345

C - All components Stainless Steel

106E3 - Straight 37° JIC Female Flare

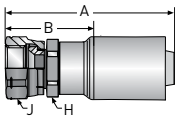

Part Number	Nominal I.D.				Thread Size	Overall Length A		Cutoff Allow. B		J Hex		H Hex		Max. Working Pressure	
	DN	Size	inch	mm		inch	mm	inch	mm	inch	mm	inch	mm	psi	bar
106E3-4-4C	6	-04	1/4	6.4	7/16" - 20	2.46	62	1.44	37	0.62	16	0.62	16	5,000	345
106E3-6-4C					9/16" - 18 UNF 2B	2.55	65	1.50	38	0.75	19				

C - All components Stainless Steel

WARNING

This product can expose you to chemicals including Lead, which is known to the State of California to cause cancer and birth defects or other reproductive harm. For more information go to www.P65Warnings.ca.gov.

1/2" - 6,017 psi Oil & Gas Hose

2390N-08V1x

Low dimensional change under pressure resulting in excellent response times



Construction

- Core Tube: Polyamide
- Pressure Reinforcement: Two closed spiral layers and two open spiral layers of high tensile steel wire
- Cover: Sea water resistant polyurethane
- Standard Color: x3 - Green, x2 - Blue, x6 - Yellow

Temperature

- Temperature Range: -40°F to 212°F (-40°C to 100°C)*

Certifications

- Meets or exceeds the performance requirements of ISO 13628-5

Design Factor

- 4

Notes

- *Operating temperature will vary depending on the fluid. Consult Parker if more information required.

[Visit the webpage](#)

Part Number	Nominal I.D.				Max. O.D.		Max. Working Pressure		Min. Bend Radius		Weight		Fitting Series
	DN	Size	inch	mm	inch	mm	psi	bar	inch	mm	lbs./ft.	kg/mtr	
2390N-08V12	13	-08	1/2	12.7	0.83	21.2	6,017	415	5.91	150	0.36	0.54	E3
2390N-08V13	13	-08	1/2	12.7	0.83	21.2	6,017	415	5.91	150	0.36	0.54	E3
2390N-08V16	13	-08	1/2	12.7	0.83	21.2	6,017	415	5.91	150	0.36	0.54	E3

19WE3 - 90° Dual Seal

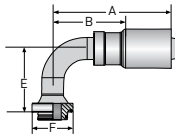

Part Number	Nominal I.D.				Overall Length A		Cutoff Allow. B		F	E	Max. Working Pressure		
	DN	Size	inch	mm	inch	mm	inch	mm	inch	inch	mm	psi	bar
19WE3-8-8C	13	-08	1/2	12.7	4.11	104	2.44	62	1/2	1.80	46	5,000	345
19WE3-16-8C									1	1.73	44		

C - All components Stainless Steel

19GE3 - Straight Dual Seal

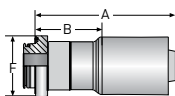

Part Number	Nominal I.D.				Overall Length A		Cutoff Allow. B		F	Max. Working Pressure	
	DN	Size	inch	mm	inch	mm	inch	mm	inch	psi	bar
19GE3-8-8C	13	-08	1/2	12.7	3.25	83	1.56	40	1/2	5,000	345
19GE3-16-8C*					*	*	*	*	1		

C - All components Stainless Steel *Contact division for overall length and cutoff allowance

139E3 - Female JIC 37° - Swivel - 90° Elbow - Short Drop

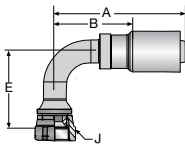

Part Number	Nominal I.D.				Thread Size	Overall Length A		Cutoff Allow. B		J Hex	E	Max. Working Pressure			
	DN	Size	inch	mm		inch	mm	inch	mm	inch	mm	psi	bar		
139E3-8-8C-411	13	-08	1/2	12.7	3/4" - 6	4.11	104	2.44	62	0.94	24	2.11	54	5,000	345

C - All components Stainless Steel

106E3 - Straight 37° JIC Female Flare

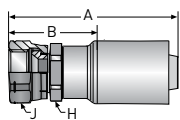

Part Number	Nominal I.D.				Thread Size	Overall Length A		Cutoff Allow. B		J Hex	H Hex	Max. Working Pressure			
	DN	Size	inch	mm		inch	mm	inch	mm	inch	mm	psi	bar		
106E3-8-8C	13	-08	1/2	12.7	3/4" - 6	3.55	90	1.88	48	0.94	24	0.94	24	5,000	345

C - All components Stainless Steel

[continued on next page](#)

WARNING

This product can expose you to chemicals including Lead, which is known to the State of California to cause cancer and birth defects or other reproductive harm. For more information go to www.P65Warnings.ca.gov.

1" - 4,060 psi Hydraulic Hose

2390N-16V13



Low dimensional change under pressure resulting in excellent response times

Construction

- Core Tube: Polyamide 12
- Pressure Reinforcement: Two closed spiral layers and two open spiral layers of high tensile steel wire
- Cover: Sea water resistant polyurethane
- Standard Color: x3 - Green

Temperature

- Temperature Range: -40°F to 212°F (-40°C to 100°C)*

Design Factor

- 4

Notes

- *Temperature: -40°F to 212°F (-40°C to 100°C), max. 158°F (70°C) for water/glycol and methanol based fluids.

[Visit the webpage](#)

Part Number	Nominal I.D.		Max. O.D.		Max. Working Pressure		Min. Bend Radius		Weight		Fitting Series		
	DN	Size	inch	mm	inch	mm	psi	bar	inch	mm		lbs./ft.	kg/mtr
2390N-16V13	25	-16	1	25.4	1.38	35.0	4,060	280	11.02	280	0.79	1.17	E4

106E4 - JIC 37° Flare - Female

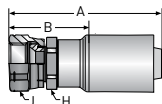

Part Number	Nominal I.D.		Thread Size	Overall Length A		Cutoff Allow. B		J Hex	H Hex				
	DN	Size		inch	mm	inch	mm			inch	mm		
106E4-16-16C	25	-16	1	25.4	1-5/16" - 12	4.76	121	2.38	60	1.62	41	1.50	38

C - All components Stainless Steel

137E4 - 45° JIC

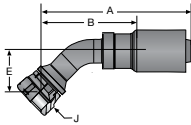

Part Number	Nominal I.D.		Thread Size	Overall Length A		Cutoff Allow. B		J Hex	E				
	DN	Size		inch	mm	inch	mm			inch	mm		
137E4-16-16C-411	25	-16	1	25.4	1-5/16" - 12	6.50	165	4.13	105	1.62	41	1.69	43

C - All components Stainless Steel

139E4 - 90° JIC

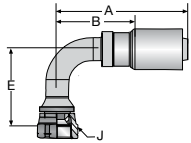

Part Number	Nominal I.D.		Thread Size	Overall Length A		Cutoff Allow. B		J Hex	E				
	DN	Size		inch	mm	inch	mm			inch	mm		
139E4-16-16C-411	25	-16	1	25.4	1-5/16" - 12	5.69	145	3.32	84	1.62	41	3.27	83

C - All components Stainless Steel

19GE4 - Straight Dual Seal

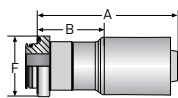

Part Number	Nominal I.D.		Overall Length A	Cutoff Allow. B		F			
	DN	Size		inch	mm		inch	mm	
19GE4-16-16C	25	-16	1	25.4	4.35	110	2.00	51	1
19GE4-24-16C					4.48	114	2.13	54	1-1/2

C - All components Stainless Steel

19ME4 - 45° Dual Seal

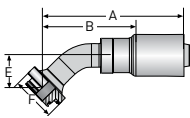

Part Number	Nominal I.D.		Overall Length A	Cutoff Allow. B		F	E				
	DN	Size		inch	mm			inch	mm		
19ME4-16-16C	25	-16	1	25.4	6.24	158	3.88	99	1	1.42	36
19ME4-24-16C					6.32	161	3.93	100	1-1/2	1.86	47

C - All components Stainless Steel

19WE4 - 90° Dual Seal

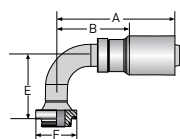

Part Number	Nominal I.D.		Overall Length A	Cutoff Allow. B		F	E				
	DN	Size		inch	mm			inch	mm		
19WE4-16-16C	25	-16	1	25.4	5.69	145	3.13	80	1	3.27	83
19WE4-24-16C					5.69	145	3.52	89	1-1/2	3.52	89

C - All components Stainless Steel



WARNING

This product can expose you to chemicals including Lead, which is known to the State of California to cause cancer and birth defects or other reproductive harm. For more information go to www.P65Warnings.ca.gov.

1/2" - 11,745 psi Oil & Gas Hose

2440N-08V91



Flexible, chemical-resistant, lightweight alternative to steel pipe and rubber hose

Construction

- Core Tube: Polyamide 11, methanol washed
- Pressure Reinforcement: Four spiral layers of maximum tensile steel wire
- Cover: Polyamide 12
- Standard Color: x1 - Black

Temperature

- Temperature Range: -40°F to 212°F (-40°C to 100°C)

Design Factor

- 4

Certifications

- Meets or exceeds the performance requirements of ISO 13628-5

[Visit the webpage](#)

Part Number	Nominal I.D.				Max. O.D.		Max. Working Pressure		Min. Bend Radius		Weight		Fitting Series
	DN	Size	inch	mm	inch	mm	psi	bar	inch	mm	lbs./ft.	kg/mtr	
2440N-08V91	13	-08	1/2	12.7	0.89	22.7	11,745	810	7.87	200	0.63	0.94	LX

101LX - NPT Male

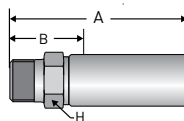

Part Number	Nominal I.D.				Thread Size	Overall Length A		Cutoff Allow. B		H Hex	
	DN	Size	inch	mm		inch	mm	inch	mm	inch	mm
101LX-8-08C	13	-8	1/2	12.7	1/2" - 14	3.58	91	1.46	37	0.87	35

C - All components Stainless Steel

106LX - JIC 37° Female Flare

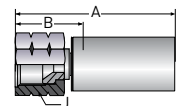

Part Number	Nominal I.D.				Thread Size	Overall Length A		Cutoff Allow. B		J Hex		Max. Working Pressure	
	DN	Size	inch	mm		inch	mm	inch	mm	inch	mm	psi	bar
106LX-8-08C	13	-08	1/2	12.7	3/4" - 16	2.52	64	0.83	21	1.06	27	10,000	690

C - All components Stainless Steel

1C9LX - Metric Swivel - Female

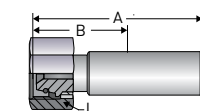

Part Number	Nominal I.D.				Thread Size	Overall Length A		Cutoff Allow. B		J Hex	
	DN	Size	inch	mm		inch	mm	inch	mm	inch	mm
1C9LX-16-08C	13	-08	1/2	12.7	M 24 x 1.5	3.46	88	1.34	34	1.26	32

C - All components Stainless Steel

1AYLX - Type "M" Swivel - Female

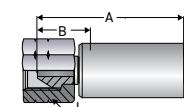

Part Number	Nominal I.D.				Thread Size	Overall Length A		Cutoff Allow. B		J Hex	
	DN	Size	inch	mm		inch	mm	inch	mm	inch	mm
1AYLX-11-08C	13	-08	1/2	12.7	1" - 12	3.43	87	1.77	45	1.26	32

C - All components Stainless Steel



WARNING

This product can expose you to chemicals including Lead, which is known to the State of California to cause cancer and birth defects or other reproductive harm. For more information go to www.P65Warnings.ca.gov.

3/4" - 10,000 psi Oil & Gas Hose

2440N-12V91



Flexible, chemical-resistant, lightweight alternative to steel pipe and rubber hose

Construction

- Core Tube: Polyamide 11, methanol washed
- Pressure Reinforcement: Four spiral layers of maximum tensile steel wire
- Cover: Polyamide 12
- Standard Color: x1 - Black

Temperature

- Temperature Range:
-40°F to 212°F (-40°C to 100°C)

Design Factor

- 3.6

Certifications

- Meets or exceeds the performance requirements of ISO 13628-5

[Visit the webpage](#)

Part Number	Nominal I.D.				Max. O.D.		Max. Working Pressure		Min. Bend Radius		Weight		Fitting Series
	DN	Size	inch	mm	inch	mm	psi	bar	inch	mm	lbs./ft.	kg/mtr	
2440N-12V91	20	-12	3/4	19.0	1.19	30.2	10,000	690	9.84	250	0.98	1.46	LX

106LX - JIC 37° Female Flare

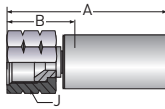

Part Number	Nominal I.D.				Thread Size	Overall Length A		Cutoff Allow. B		J Hex		Max. Working Pressure psi
	DN	Size	inch	mm		inch	mm	inch	mm	inch	mm	
106LX-12-12C4462	20	-12	3/4	19	1-1/16" - 12	3.74	95	1.61	41	1.42	36	5,000
106LX-16-12C4462	20	-12	3/4	19	1-5/16" - 12	3.99	99	1.69	43	1.61	41	10,000

C - All components Stainless Steel

1AYLX - Type "M" Swivel - Female

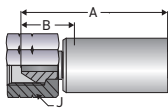

Part Number	Nominal I.D.				Thread Size	Overall Length A		Cutoff Allow. B		J Hex	
	DN	Size	inch	mm		inch	mm	inch	mm	inch	mm
1AYLX-16-12C4462	20	-12	3/4	19	1-5/16" - 12	4.15	105	1.52	39	1.50	38

C - All components Stainless Steel

WARNING

This product can expose you to chemicals including Lead, which is known to the State of California to cause cancer and birth defects or other reproductive harm. For more information go to www.P65Warnings.ca.gov.

1" - 8,120 psi Oil & Gas Hose

2440N-16V91



Flexible, chemical-resistant, lightweight alternative to steel pipe and rubber hose

Construction

- Core Tube: Polyamide 11, methanol washed
- Pressure Reinforcement: Four spiral layers of maximum tensile steel wire
- Cover: Polyamide 12
- Standard Color: x1 - Black

Temperature

- Temperature Range: -40°F to 212°F (-40°C to 100°C)

Design Factor

- 4

Certifications

- Meets or exceeds the performance requirements of ISO 13628-5

[Visit the webpage](#)

Part Number	Nominal I.D.				Max. O.D.		Max. Working Pressure		Min. Bend Radius		Weight		Fitting Series
	DN	Size	inch	mm	inch	mm	psi	bar	inch	mm	lbs./ft.	kg/mtr	
2440N-16V91	25	-16	1	25.4	1.46	37.2	8,120	560	11.8	300	1.34	2.00	LX

106LX - JIC 37° Female Flare

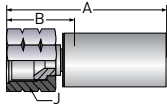

Part Number	Nominal I.D.				Thread Size	Overall Length A		Cutoff Allow. B		J Hex		Max. Working Pressure	
	DN	Size	inch	mm		inch	mm	inch	mm	inch	mm	psi	bar
106LX-16-16C4462	25	-16	1	25.4	1-5/16" - 12	3.03	77	1.00	25	1.61	41	5,000	345

C - All components Stainless Steel

1Y2LX - Medium Pressure Male

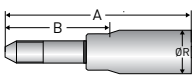

Part Number	Nominal I.D.				Thread Size	Overall Length A		Cutoff Allow. B		Diameter R	
	DN	Size	inch	mm		inch	mm	inch	mm	inch	mm
1Y2LX-16-16C4462	25	-16	1	25.4	1"-14 LH	7.13	181	5.00	127	1.06	27

C - All components Stainless Steel

[continued on next page](#)

WARNING

This product can expose you to chemicals including Lead, which is known to the State of California to cause cancer and birth defects or other reproductive harm. For more information go to www.P65Warnings.ca.gov.

1/4" - 15,000 psi Oil & Gas Hose

2448N-04V91



Flexible, chemical-resistant, lightweight alternative to steel pipe and rubber hose

Construction

- Core Tube: Polyamide 11, methanol washed
- Pressure Reinforcement: Four spiral layers of maximum tensile steel wire
- Cover: Polyamide 12
- Standard Color: x1 - Black

Temperature

- Temperature Range: -40°F to 212°F (-40°C to 100°C)

Design Factor

- 4

Certifications

- Meets/exceeds performance requirements of ISO 13628-5

[Visit the webpage](#)

Part Number	Nominal I.D.				Max. O.D.		Max. Working Pressure		Min. Bend Radius		Weight		Fitting Series
	DN	Size	inch	mm	inch	mm	psi	bar	inch	mm	lbs./ft.	kg/mtr	
2448N-04V91	6	-04	1/4	6.4	0.54	13.7	15,000	1,035	5.90	150	0.26	0.38	8X

1018X - NPT Male

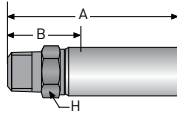

Part Number	Nominal I.D.				Thread Size	Overall Length A		Cutoff Allow. B		H Hex	
	DN	Size	inch	mm		inch	mm	inch	mm	inch	mm
1018X-4-04C	6	-04	1/4	6.4	1/4" - 18	2.54	65	1.30	33	0.56	14

C - All components Stainless Steel

1Y28X - Medium Pressure Male

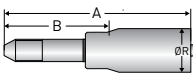

Part Number	Nominal I.D.				Thread Size	Overall Length A		Diameter R	
	DN	Size	inch	mm		inch	mm	inch	mm
1Y28X-6-04C	6	-04	1/4	6.4	3/8" -24 LH	5.08	129	0.86	22

C - All components Stainless Steel

1928X - BSP Swivel - Female

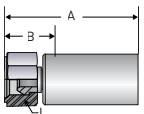

Part Number	Nominal I.D.				Thread Size	Overall Length A		Cutoff Allow. B		J Hex	
	DN	Size	inch	mm		inch	mm	inch	mm	inch	mm
1928X-4-04C	6	-04	1/4	6.4	G1/4" - 19	2.20	56	1.26	32	0.75	19

C - All components Stainless Steel



WARNING

This product can expose you to chemicals including Lead, which is known to the State of California to cause cancer and birth defects or other reproductive harm. For more information go to www.P65Warnings.ca.gov.

1/4" - 15,000 psi Oil & Gas Hose

2448N-04V91

15Y8X - Medium Pressure Swivel - Female

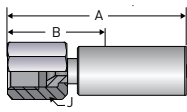

Part Number	Nominal I.D.				Thread Size	Overall Length A		Cutoff Allow. B		J Hex	
	DN	Size	inch	mm		inch	mm	inch	mm	inch	mm
15Y8X-6-04C	6	-04	1/4	6.4	9/16" - 18 UNF	2.56	65	1.265	32	0.75	19

C - All components Stainless Steel

1AY8X - Type "M" Swivel - Female

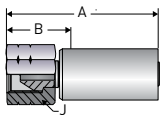

Part Number	Nominal I.D.				Thread Size	Overall Length A		Cutoff Allow. B		J Hex	
	DN	Size	inch	mm		inch	mm	inch	mm	inch	mm
1AY8X-6-04C	6	-04	1/4	6.4	9/16" - 18	2.60	66	1.38	35	0.67	17

C - All components Stainless Steel

1C98X - Metric Swivel - Female

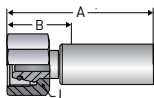

Part Number	Nominal I.D.				Thread Size	Overall Length A		Cutoff Allow. B		J Hex	
	DN	Size	inch	mm		inch	mm	inch	mm	inch	mm
1C98X-8-04C	6	-04	1/4	6.4	M 16 x 1.5	2.32	59	1.06	27	0.75	19
1C98X-10-04C					M 18 x 1.5	2.20	56	1.30	33	0.87	22

C - All components Stainless Steel



WARNING

This product can expose you to chemicals including Lead, which is known to the State of California to cause cancer and birth defects or other reproductive harm. For more information go to www.P65Warnings.ca.gov.

1/2" - 5,000 psi Collapse Resistant Oil & Gas Hose

HCRV-8



The industries only multiple color high collapse resistant hose for easy line identification

Construction

- Carcass: Flexible 316L Stainless Steel
- Core Tube: Polyamide 11
- Pressure Reinforcement: Aramid Fiber Braid
- Cover: Polyurethane
- Standard Color: x2 - Blue, x6 - Yellow

Temperature

- Temperature Range: -40°F to 131°F (-40°C to 55°C)

Design Factor

- 4

Certifications

- Meets or exceeds the performance requirements of ISO 13628-5

Notes

- For maximum lengths, please contact the Parflex Division.
- 1.5 design factor for collapse pressure per API 17E.
- For installation depths greater than 10,000 ft., please contact Parflex Division.

[Visit the webpage](#)

Part Number	Nominal I.D.				Max. O.D.		Max. Working Pressure		Minimum Bend Radius		Weight		Min. Collapse Pressure		Collapse Pressure Rating per ISO13628-5 ^{1,2}		Fitting Series
	DN	Size	inch	mm	inch	mm	psi	bar	inch	mm	lbs./ft.	kg/mtr	psi	bar	psi	bar	
HCRV-8-BLU	13	-8	1/2	12.7	1.04	26.4	5,000	345	4	102	0.45	0.67	6,600	456	4,400	303	HV
HCRV-8-YEL	13	-8	1/2	12.7	1.04	26.4	5,000	345	4	102	0.45	0.67	6,600	456	4,400	303	HV

106HV - JIC 37° Female Flare

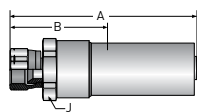

Part Number	Nominal I.D.				Thread Size	Overall Length A		Cutoff Allow. B		J Hex	
	DN	Size	inch	mm		inch	mm	inch	mm	inch	mm
106HV-8-8C	13	-08	1/2	12.7	3/4" - 16 UNF	4.25	108	2.0	51	1.37	35

C - All components Stainless Steel

19GHV - Straight Dual Seal

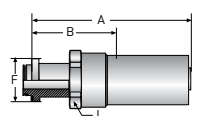

Part Number	Nominal I.D.				Flange Size	Overall Length A		Cutoff Allow. B		Flange Diameter		J Hex	
	DN	Size	inch	mm		inch	mm	inch	mm	inch	mm	inch	mm
19GHV-8-8C	13	-08	1/2	12.7	1/2"	5.00	127	3.00	76	1.25	32	1.37	35

C - All components Stainless Steel

1GXHV - Straight Grayloc 1GR4 HUB

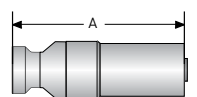

Part Number	Nominal I.D.				Hub Size	Overall Length A		Cutoff Allow. B		C		D	
	DN	Size	inch	mm		inch	mm	inch	mm	inch	mm	inch	mm
1GXHV-4-8C	13	-8	1/2	12.7	1 GR4	4.4	111	2.24	57	2.000	51	0.313	8

C - All components Stainless Steel



WARNING

This product can expose you to chemicals including Lead, which is known to the State of California to cause cancer and birth defects or other reproductive harm. For more information go to www.P65Warnings.ca.gov.

1" - 5,000 psi Collapse Resistant Oil & Gas Hose

HCRV-16



The industries only multiple color high collapse resistant hose for easy line identification

Construction

- Carcass: Flexible 316L Stainless Steel
- Core Tube: Polyamide 11
- Pressure Reinforcement: Aramid Fiber Braid
- Cover: Polyurethane
- Standard Color: x2 - Blue, x6 - Yellow

Temperature

- Temperature Range: -40°F to 131°F (-40°C to 55°C)

Design Factor

- 4

Certifications

- Meets or exceeds the performance requirements of ISO 13628-5

Notes

- For maximum lengths, please contact the Parflex Division.
- 1.5 design factor for collapse pressure per API 17E.
- For installation depths greater than 10,000 ft., please contact Parflex Division.

[Visit the webpage](#)

Part Number	Nominal I.D.				Max. O.D.		Max. Working Pressure		Minimum Bend Radius		Weight		Min. Collapse Pressure		Collapse Pressure Rating per ISO 13628-5 ^{1,2}		Fitting Series
	DN	Size	inch	mm	inch	mm	psi	bar	inch	mm	lbs./ft.	kg/mtr	psi	bar	psi	bar	
HCRV-16-BLU	25	-16	1	25.4	1.83	46.4	5,000	345	11.8	300	1.44	2.15	6,600	456	4,400	303	HV
HCRV-16-YEL	25	-16	1	25.4	1.83	46.4	5,000	345	11.8	300	1.44	2.15	6,600	456	4,400	303	HV

106HV - JIC 37° Female Flare

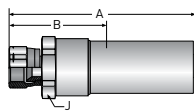

Part Number	Nominal I.D.				Thread Size	Overall Length A		Cutoff Allow. B		J Hex	
	DN	Size	inch	mm		inch	mm	inch	mm	inch	mm
106HV-16-16C	25	-16	1	25.4	1-5/16" - 16 UNF	6.55	166	3.5	89	2.37	60

C - All components Stainless Steel

19GHV - Straight Dual Seal

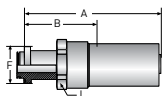

Part Number	Nominal I.D.				Flange Size	Overall Length A		Cutoff Allow. B		Flange Diameter		J Hex	
	DN	Size	inch	mm		inch	mm	inch	mm	inch	mm	inch	mm
19GHV-16-16C	25	-16	1	25.4	1	7.58	192	4.12	105	1.88	48	2.37	60

C - All components Stainless Steel

1GXHV - Straight Grayloc 1GR7 HUB

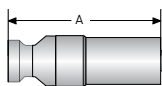

Part Number	Nominal I.D.				Hub Size	Overall Length A		Cutoff Allow. B		C		D	
	DN	Size	inch	mm		inch	mm	inch	mm	inch	mm	inch	mm
1GXHV-7-16C	25	-16	1	25.4	1 GR7	7.40	188	3.5	89	2.00	51	0.313	8

C - All components Stainless Steel



WARNING

This product can expose you to chemicals including Lead, which is known to the State of California to cause cancer and birth defects or other reproductive harm. For more information go to www.P65Warnings.ca.gov.

Black Eagle Hose

For Well Services

The Black Eagle family is a range of multispiral, wire reinforced hoses specifically designed for the oil and gas market, covering applications in offshore projects and land operations.

For many years this range of hoses has enabled our customers to optimize well production by performing operations like acidizing, cementing, methanol injection or gas injection.



Applications

Subsea and land based well operations like:

- Cementing operations acc. to API 7K FSL
- Acidizing
- General Fluid and Gas Injection
- Mud Circulation

Features

- ColorGard™, an extra thick dual color polyurethane sheath significantly reduces the risk of exposing the reinforcing wires. If the outer black cover has been abraded to the point that the "early warning" red inner cover can be seen, the hose needs to be changed out.
- Long continuous lengths (up to 1,500 meters) without splicing (lengths depend on hose size)
- Superior chemical resistant core tube – either seamless Polyamide 11 or fluoropolymer based design – smaller O.D. than flexible pipe
- Up to 30% weight reduction in comparison to R13 rubber hoses – more than 70% in comparison to flexible pipe I.D. from 1 1/4" up to 3" – working pressure from 3,000* psi (207 bar) up to 15,000* psi (1035 bar) – temperature range from -40°C up to 100°C
- Lower bend radius compared to composite hose

Applications

- Increased safety – superior abrasion resistance in combination with a visual indication for damaged cover
- Less connections due to long continuous lengths results in less risk of leakage, less risk to workforce, and faster deployment
- Long service life and less maintenance
- Less effort for logistics due to increased hose capacity per reel
- Easier handling and faster installation
- Comprehensive range of hoses to cover most applications
- Easier handling and improved flexibility



Up to 30% weight reduction in comparison to R13 rubber hoses - more than 70% in comparison to flexible pipe

Black Eagle Hose

Construction & Overview



Polyflex Black Eagle hoses are designed for oilfield applications. For each application different demands need to be considered regarding:

- Composition of fluids
- Short term pressure fluctuations
- Safety requirements and standards
- Temperatures and pressures
- Static and dynamic loads

Thermoplastic Core Tube

The essential requirement for a hose is to contain and transmit a fluid or gas. The core tube of a thermoplastic hose is therefore in direct contact with that medium. The selection of the core tube material depends on fluid compatibility, service temperature, and diffusion rate under operating conditions. The available materials are:

- Polyamide (PA11): It is used in high-performance applications for oil and gas, flexible pipes and control fluid umbilicals. It can operate within a wide range of working temperatures (-40°C up to +70°C), has a high dimensional stability and is low in density.
- Fluoropolymer designed for use in chemical injection systems at high temperature levels, the tubing shows low permeation rates and an excellent chemical resistance. Proven to handle methanol at 100°C and 15,000* psi working pressure.

Thermoplastic core tubes are manufactured with an extremely smooth and clean inner surface. This provides minimum flow resistance and minimum pressure drop in service.

Spiral Wire Reinforcement

Our reinforcement allows flexibility in service without compromising fluid transfer. Various layers of high tensile strength steel wires are used to achieve the best combination of pressure resistance, flexibility, and volumetric expansion. The basic function of the cover is to protect the wire reinforcement from very demanding environment. This could be decompressive media like seawater or extreme abrasion of the cover.

ColorGard™ Cover

ColorGard™ is an extra thick dual layer Polyurethane sheath: a red inner layer and a black or golden outer layer. It offers both an abrasion resistant extra thick over for long service life and acts as an additional safety feature. This concept is a visual early warning system for detection of excessive abrasion. This feature avoids possible injuries and reduction of downtime by anticipating failure.



Table of Contents PFDE-ES28, Rev. U: Handling, Maintenance, Inspection, Repair

Black Eagle Hose Assemblies

1	Scope	A-100
2	Hose Features	A-100
2.1	Design life	A-100
3	Storage	A-100
4	Handling	A-101
4.1	Personnel	A-101
4.2	Spooling and reeling	A-101
5	Possible causes of premature failure, and suggested preventative measures	A-102
5.1	Bending the hose below the minimum bend radius	A-102
5.2	Damage of the hose cover	A-102
5.3	Kinked, crushed, or twisted hose	A-102
5.4	Chemical attack or ageing of the core tube	A-102
5.5	Damage or corrosion of the end fitting	A-102
5.6	Flow rates	A-102
6	Inspection guidelines	A-103
6.1	General	A-103
6.2	Frequencies and Levels of Inspection	A-103
6.3	Routine in-field Pre Job and Post Job Maintenance, Inspection and Testing	A-103
6.3.1	Routine in-field Pre Job Maintenance, Inspection and Testing	A-103
6.3.2	Routine in-field Post Job Maintenance, Inspection and Testing	A-104
6.4	Level 1 On Site Inspection by User	A-104
6.4.1	Level 1 - Visual Inspection	A-104
6.4.2	Level 1 - Hose core tube inspection with a borescope	A-104
6.4.3	Level 1 - Hydrostatic pressure test	A-104
6.5	Level 2 Inspection/Recertification by a Parker Certified Facility	A-105
6.5.1	Level 2 Customer Pre-dispatch procedure before returning a hose assy for Level 2 Inspection	A-105
6.5.2	Level 2 - Inspection Amount	A-105
6.5.3	Level 2 - External inspection	A-105
6.5.4	Level 2 - Internal inspection	A-106
6.5.5	Level 2 - Inspection report	A-106



Table of Contents PFDE-ES28, Rev. U: Handling, Maintenance, Inspection, Repair

Black Eagle Hose Assemblies

7	Procedure for repair and recertification	A-106
7.1	Repair	A-106
7.1.1	Twisted hose, hose with the reduced OD, flattened hose.....	A-106
7.1.2	Hose with cover damage.....	A-106
7.1.3	Fitting re-ending	A-107
7.2	Recertification.....	A-107
8	Parker Certified Distributors/ Service Addresses	A-107
	Appendix 1: Chemical resistance chart	A-108
	Appendix 2: Data for tensile loading and weights of Polyflex hoses	A-112
	Appendix 3: Procedure for a repair of a local damage in the outer cover.....	A-115
	Appendix 4: Recommendations for use of Black Eagle hoses with gas and sour gas	A-121

PFDE-ES28, Rev. U: Handling, Maintenance, Inspection, Repair

Black Eagle Hose Assemblies



Instructions for handling, maintenance, inspection and repair of Parker Polyflex BLACK EAGLE hoses and assemblies.

1. Scope

This engineering standard is focused mainly on larger bore - long length Parker Polyflex multispiral wire reinforced hoses used in well service operations. It is also relevant for shorter length hose assembly applications such as chemical injection, stimulation, cementing, flexible and testing lines. It provides information on recommended practices for handling, maintenance, inspection, and repair of hose assemblies.

Deployed as single line hoses or used in bundles, Parker Polyflex multispiral wire reinforced hoses are available in sizes from 3/16" to 3" inside diameter and working pressures up to 1035 bar / 15000 psi and continuous lengths greater than 3000 m depending on size.

Hose can be self-supporting, clamped, supported by a guide wire or strengthened with an additional tensile reinforcement.

Parker Polyflex have certified several specialized testing facilities and their personnel to assemble, inspect, test and repair hose assemblies. Hose management is an essential part of the service they provide.

SAE J1273, ISO 17165-2, API RP 17B and ISO 13628 are excellent documents providing general guidelines for selection, routing, fabrication, installation, replacement, maintenance, and storage of hose and hose assemblies. Together with Parker Polyflex field experience, they provide the basis for the recommendations included in this engineering standard.

2. Hose Features

Parker Polyflex Oil & Gas multispiral wire reinforced hoses have been used for over 30 years in both onshore and offshore applications. They are proven to be tough, easy to handle, lightweight compared with alternatives and offer excellent chemical resistance, integral external collapse, ozone and microbiological resistance.

In extreme, abrasive applications, Polyflex offers an additional extra thick ColorGard™ sheath incorporating a dual color "early warning" safety feature.

2.1 Design Life

Parker Polyflex large bore hoses are designed for prolonged service life. The prerequisite for this design life is that the hoses are used within the operating limits, stated in the hose specification sheets. These limits include, but are not limited to working pressure, number of pressure cycles, temperature range and bending radius.

In order to ensure a long service life, Parker Polyflex incorporates a combination of raw material suppliers testing and data, fatigue testing, accelerated and specialized testing into the design of the hoses.

Obviously, due to many other factors, affecting the service life, it is not possible to predict or guarantee service life of each individual hose assembly.

These factors may include, but are not limited to mechanical loads (bending, torsion, tensile loads), frequent changes of temperature within the specified range, improper handling and storage, chemical attack, abrasive fluids, hose damage etc.

3. Storage

Hoses and hose assemblies should be stored, wherever possible, empty and protected from the elements in a stress-free condition either straight, in a coil, or on a drum. The inside diameter of the coil or drum should not be less than two times the minimum bend radius. If a hose assembly has been used with chemicals, it shall be flushed with water before putting it to storage (see also P.5.4).

Example: hose with minimum bend radius 800 mm; minimum size of drum core/belly should be $2 \times 800\text{mm} = 1.6\text{m}$.

The fittings should be capped to prevent ingress of dirt or other contamination and any exposed threads protected from damage.

Storage of hoses and hose assemblies should take into account potential exposure to corrosive liquids, rodents, insects, UV light and high temperatures. Storage temperatures should be in the range of hose operating temperatures.



4. Handling

4.1 Personnel

Only trained personnel shall handle and connect hose assemblies.

Incorrect handling will seriously reduce the lifetime of the hose and could cause dramatic failure. The use of wire rope or chains directly against the outer cover should be avoided, and the routing of the assembly should ensure the hose is never bent below its minimum bend radius or twisted. Special attention should be paid to the area at the back of the fitting.

4.2 Spooling and Reeling

When reeling long length hose onto a drum it is essential to minimize the tension on the hose. Proof testing of a "stretched" hose while on the drum can cause premature failure of the hose or damage to the drum.

When operating from a vessel it is recommended that the hose is pressurized during the subsea deployment and retrieving operation. This recommendation is based on the fact that during these operations the hose is always subjected to tensile force, at least due to its own weight. Tensile forces will result in hose elongation and possible deformation.

This is significantly reduced by pressurizing the hose, especially important if it is planned to proof test the hose assembly while coiled on a drum or winch. Deployment and retrieving pressures up to 200 bar had been found to be sufficient but this depends on the hose type and local safety regulations. For recommendations of pressure / load values, see Appendix 2.

When re-spooling a long length assembly, the pay-off and take-up drums should be in line and a minimum of 10m apart. Depending on how the hose was delivered or re-spooled, the hose shall be spooled from either the top of the pay-off drum onto the top of the take-up drum or from bottom to bottom.

See Fig. 1 and Fig. 2. These recommendations minimize the possibility of inducing twist into the hose.

When re-spooling a new hose that has a polyurethane cover, it is recommended to lubricate the hose cover with soapy water or other suitable lubricant so the hose will traverse more easily and position itself correctly onto the take-up drum/winch.

See Fig. 1

It is also recommended, when deploying the hose through a moon pool or over the side of a vessel, to align the hose routing in the same manner.

See Fig. 2

Note: When first supplied, the layline printed on the hose is normally straight and visible. Twisting of the layline is an early indication of poor alignment or high tensile loading.

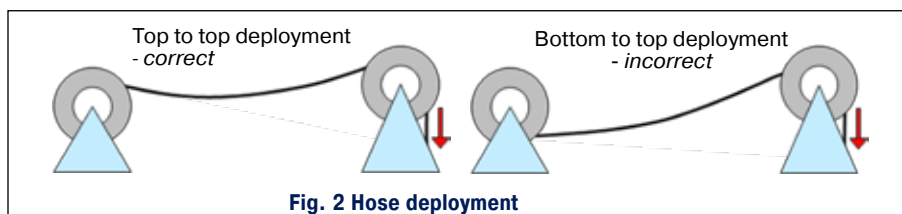
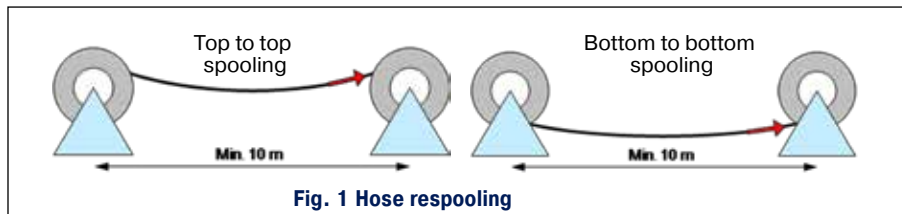

PFDE-ES28, Rev. U: Handling, Maintenance, Inspection, Repair

Black Eagle Hose Assemblies



5. Possible Causes of Premature Failure and Suggested Preventative Measures

5.1 Bending the hose below the minimum bend radius

This is most likely to occur if the end fitting is not supported during lifting, a support sling wrongly positioned, or the hose being pulled around a tight corner. It is important that hose should not be bent close to the end fittings. The straight section should be at least two times the outside diameter of the hose before it starts to bend.

Bend restrictors, lifting clamps and containment grips are useful accessories that help to reduce this type of handling problem.

5.2 Damage of the Hose Cover

Polyflex ColorGard™ extra thick, dual color cover significantly reduces the risk of exposing the reinforcing wires. If the outer black cover has been abraded to the point that the “early warning” red inner cover can be seen, but the wire reinforcement has not been exposed, the assembly is still fit for use but shall be scheduled for inspection. Alternatively, a repair according to section 7.1.1 may be considered.

If the hose cover is damaged to the extent that the reinforcing wires are exposed, localized corrosion of the wires could occur causing a progressive reduction in burst pressure, and ultimately failure.

If used subsea, a damaged cover will allow water to ingress into the carcass of the hose and could cause the corrosion of the wire reinforcement and/or collapse of the core tube.

It is strongly recommended to immediately remove from service any hose assembly with exposed wires. See also section 7.1.2 for details. A Parker Polyflex specialized testing facility should be contacted and the procedure described in section 6.5.1 shall be followed.

5.3 Kinked, Crushed or Twisted Hose

If a visible distortion of the hose occurred (kinked, crushed, twisted) it will have an impact on the function and lifetime of the hose. Reduction of burst pressure and external collapse pressure could result in a sudden failure of the hose assembly. This distortion can be caused by a high tensile load or other factors.

Maintaining pressure in the hose will significantly reduce the risk of such distortion occurring.

5.4 Chemical Attack or Ageing of the Core Tube

The use of chemicals at differing concentrations and/or temperatures can have a major effect on the life of a hose assembly and may cause dramatic hose failure. It is important to reference the chemical compatibility chart in the appendix of this document and keep the temperatures and concentrations within the specified limits.

Note: It is critical that the hose is thoroughly flushed with water after each use.

If the hose is not flushed, the concentration of the fluid that is left in the assembly can increase and cause localized failure of the core tube.

5.5 Damage or Corrosion of the End Fitting

Incorrect handling or insufficient flushing after use could result in damage or corrosion of the end fitting. This will make connection difficult, probably cause leakage, and could result in sudden failure of the connection.

5.6 Flow Rates

Depending on the abrasive properties of the fluid, high flow rates can result in erosion in the core tube or in the bore of the end fitting.

The maximum recommended flow rate is 15 m/sec, although much higher rates have been used short term with non-abrasive fluids. Do note possible temperature increase because of high flow velocities.

Note: The condition of the core tube and end fittings are checked as part of inspection (see 6.2).

PFDE-ES28, Rev. U: Handling, Maintenance, Inspection, Repair

Black Eagle Hose Assemblies



6. Inspection Guidelines

6.1 General

Hoses and hose assemblies have a limited lifetime and if they are not properly maintained, they could fail in service, causing expensive damages of property, unnecessary downtimes, release of hazardous substances and personnel injuries.

Properly planned inspections, preventive actions and timely hose replacements are highly recommended to ensure safety and are less expensive than replacements or repairs of hose assemblies after a failure.

Parker is recommending inspection and re-testing of Black Eagle Hoses on a regular basis.

6.2 Frequencies and Levels of Inspection

The table below represents the general Parker recommendation. However, due to huge variances in operating conditions in various applications, the final responsibility to define proper inspection intervals and amount of inspection is within the hose assembly owner/user.

Some factors, which could be taken into account while defining inspection intervals and amount of inspection, are listed below:

- Operating pressures
- Operating temperatures
- Operating times
- Service fluid type, density & viscosity
- PH levels, Chloride content
- Concentration of acids (i.e.HCL, ...)
- Flow rates (fluids, gas)
- Sand content (erosion monitoring) or other abrasive materials
- Additional stress levels (i.e. tensile loads)

It is also recommended to review these operating parameters in order to best evaluate the condition of a used Black Eagle hose assembly.

The history of each assembly should be logged showing the results of previous inspections and any repairs.

Recommended Frequencies of Inspection		
Pre- and post-job	Every 6 months or during installation/ removal	Every 2 years See 6.3.
See 6.3.	Level 1, see 6.4	Level 2, see 6.5

6.3.1 Routine In-Field Pre Job Maintenance, Inspection and Testing

The operator shall visually inspect the hose assembly before every job. If any of the following conditions are found the hose shall be removed from service and scheduled for Level 1 inspection.

- Damage to the outer cover which exposes the reinforcing wires.
- Kinked, crushed, or twisted hose.
- Reduction in the outside diameter of the hose.
- Blistered, soft, degraded, or loose outer cover.
- Cracked, damaged, or badly corroded fittings.

If in doubt, contact the original supplier or a Parker Polyflex specialized testing facility for advice.

Regular in-field pressure testing, (normally required after attaching connectors prior to hose deployment), should be restricted to a test pressure of $1.1 \times$ actual operating pressure, or the maximum stated working pressure of the hose assembly. Test duration should be 15 minutes. Preferably use water for pressure testing. The hose shall be monitored during the test and observed for signs of leakage in the hose and fittings, any bulging of the hose body, twisting or any abnormal distortion.

Prior to all pressure testing it must be ensured that all air is purged out of the hose. Failure to do so may result in core tube failure. To control that all air is removed it is sufficient to observe that the fluid flow leaving the hose is steady and constant for minimum of 5 minutes without any air bubbles or pulsations.

PFDE-ES28, Rev. U: Handling, Maintenance, Inspection, Repair

Black Eagle Hose Assemblies



6. Inspection Guidelines (cont.)

6.3.2 Routine in-field Post Job Maintenance, Inspection and testing

On completion of each operation both inside and outside hose surfaces should be flushed / cleaned with sufficient clean water to ensure that all chemicals or residues are fully removed from the hose assembly.

The operator shall visually inspect the hose assembly during every recovery. If any of the following conditions are found the assembly shall be removed from service and scheduled for Level 1 inspection.

- Damage to the outer cover which exposes the reinforcing wires.
- Kinked, crushed, or twisted hose.
- Reduction in the outside diameter of the hose.
- Blistered, soft, degraded, or loose outer cover.
- Cracked, damaged, or badly corroded fittings.

If in doubt, contact the original supplier or a Parker Polyflex specialized testing facility for advice.

6.4 Level 1 - On Site Inspection by User

The Black Eagle hose assembly shall be inspected on site by highly skilled users, who have experience and knowledge in using Black Eagle hoses. All observations should be noted and logged.

- Visual inspection
- Hose core tube inspection with borescope
- Hydrostatic pressure test

6.4.1 Level 1 Visual Inspection

For this purpose, the hose assembly should be cleaned inside and outside with water to remove oily traces, dirt, etc. for good viewing results.

The outer cover of the hose body shall be visually inspected for signs of leakage, excessive wear, looseness, kinks, bubbles, bulges, abrasion or cuts. The back side of a bend restrictor (if used) and the hose area behind the fitting should be checked for signs of over-bending/ kinking. The end fittings shall be checked for any signs of leakage, cracks and far advanced corrosion.

See 7.1 for possible hose repairs.

6.4.2 Level 1 - Hose Core Tube Inspection With a Borescope

A suitable video scope equipment is required to inspect the hose core tube and the inside surface of the fittings. Inspect the cleaned hose core tube for color change, cracks, blisters or erosion. Hoses that have been exposed to pressurized gases should be inspected thoroughly to determine, if the integrity of the liner has been breached or the liner has collapsed. If bulges, blisters, punctures or any other damage of the core tube is detected, the hose shall be removed from service and be replaced.

Some Parker Polyflex hoses have a special feature of ColorGard™ core tube. With black inside layer and yellow outside one, damage to core tube becomes visible.

If the hose core tube is damaged to the extent that yellow layer is exposed, hose shall be removed from service.

6.4.3 Level 1 - Hydrostatic Pressure Test

See 6.3.1 for details.

PFDE-ES28, Rev. U: Handling, Maintenance, Inspection, Repair

Black Eagle Hose Assemblies



6.5 Level 2 - Inspection/Recertification by a Parker Certified Facility

To be able to perform "Level 2" inspections and re-certifications of Black Eagle hose assemblies, dedicated equipment, personnel and expertise is required. Parker Polyflex have trained and certified specialized facilities and their personnel to assemble, inspect, test, repair and recertify hose assemblies. Their equipment includes:

- Inspection equipment (i.e. videoscopic camera)
- Manufacturing equipment (i.e. a suitable crimper with enough crimping force, die sets, gauges)
- High volume filling pumps for preparing pressure tests
- Testing equipment/ pressure test unit with the possibility to record pressure test graphs
- Safe testing chamber

Hose management is an essential part of the service they provide.

If necessary, the Black Eagle hose assemblies shall be decommissioned from the installation and returned to Parker Polyflex or a certified facility.

Level 2 inspections shall be conducted, if possible, during a regular equipment shutdown.

After completion of Level 2 inspection, customer will receive detailed report of the findings, including recommended actions:

- Repair (see 8.1)
- Recertification (see 8.2)
- Scrapping

6.5.1 Customer Pre-dispatch procedure before returning a hose assembly for Level 2 Inspection

- The object is to make sure the hose assembly can be safely handled and the condition of the assembly will justify the transportation and inspection costs.
- The chosen inspection facility should be contacted if doubtful about any of the points below.
- Check and record assembly serial number (send information to test facility).
- Assembly must be free of chemical residues inside and outside. (could result in refusal to handle returned assembly)
- Report on any findings out of section 6.3.1
- Method of transport, size and weight. (Long length hose assemblies on drums or reels may require special handling equipment such as drums and re-spooling machinery).
- Customer will receive a budget price for inspection based on the information given by the end user.

6.5.2 Level 2 - Recommended Inspection Amount

- Safety inspection, condition of assembly as received.
 - Check for chemical residue inside and outside (may require flushing or cleaning).
 - Assembly serial number (check assembly history including previous repairs).
- External inspection
- Internal inspection
- Inspection report

6.5.3 Level 2 -External Inspection

- Damage to the outer cover (abrasion, incorrect routing)
- Exposed reinforcing wires. (damaged outer cover)
- Kinked, crushed, or twisted hose. (high tensile loading, incorrect routing)
- Reduction in the outside diameter of the hose (high tensile loading with no pressure)
- Blistered, soft, degraded, or loose outer cover. (chemical attack, leaking fitting, permeation or high temperature)
- Cracked, damaged, or badly corroded fittings (chemical attack, poor handling, old hose assembly)
- Damage or wear on fitting threads (poor handling, old hose assembly)
- Condition of containment grips / clamps. (abrasion, frayed wires, distortion)

PFDE-ES28, Rev. U: Handling, Maintenance, Inspection, Repair

Black Eagle Hose Assemblies



6.5.4 Level 2 - Internal Inspection

Internal inspection will be done with a borescope.

- Check for damage to bore of fittings, cracks, severe abrasion and corrosion.
- Check for damages, bulges, cracks and blisters of core tube at the back of fittings (critical area).
- Scope maximum length of the core tube possible. Recommended minimum is 10 m both sides.
- Hose assemblies shorter than 20 m should be scoped on the complete length.
- Look for uneven surface (sign of wire fatigue, abrasion, chemical attack).

6.5.5 Level 2 - Inspection Report

The testing facility will advise on the overall condition of the hose and end connections.

Customer will receive detailed report of the findings, including recommended actions:

- Repair (see 7.1)
- Recertification (see 7.2)
- Scrapping

7 Procedure for Repair and Recertification

7.1 Repair

It is recommended, that all repairs are done by certified specialized testing facilities. Some repairs (see examples in following pages) could be done in field. Be sure to maintain safety requirements.

7.1.1 Twisted Hose, Hose with the Reduced O.D., Flattened Hose

A hose with signs of twisting or deformation will need to be unreeled, as straight as possible, from the winch/drum in a safe environment and pressurized to working pressure for at least 1 hour and then pressure released. The hose shall be re-inspected to see if the hose has returned to its "untwisted, undistorted" original shape. If so, the hose should be again pressurized before rewinding back onto the winch/drum. Any sections of hose still misshapen should be cut out of the assembly.

7.1.2 Hose with Cover Damage

- No reinforcement wires exposed.

Temporary solution, the damaged area can be cleaned and protected by wrapping with a strong adhesive "duct / riggers" tape. If abraded to the point where the red ColorGard is visible, the damaged area should be thoroughly cleaned with mild solvent, a thin plastic sheet wrapped around the hose to form a mould. A two pack polyurethane mixture can then be poured into the mould and allowed to set. Remove mould after the polyurethane is set. Also, a repair procedure according to Appendix 3 might be applied.

- Reinforcement wires exposed.

It is strongly recommended to remove the hose assembly from service immediately. Any ingress of water into hose carcass will initiate corrosion of the reinforcement wire. It is difficult to estimate the rate of corrosion. At best, the hose could function for months, at worst, possibly less than one week. It is also possible that the core tube could have collapsed if the external pressure acting within the carcass is greater than internal pressure within the hose.

In any case, the lifetime of the hose assembly will be significantly reduced, and the hose assembly shall be immediately scheduled for inspection at certified specialized testing facility.

Decision to further use a hose assembly with exposed wire shall be based on a proof pressure test for 1.1× maximum working pressure of the hose assembly. This test shall be conducted prior to every further job.

Repair of such a hose assembly is possible, but it will include cutting out the section of the hose, where the wires have been subjected to water. Obviously, this will require new fittings to be crimped and hose assembly to be proof pressure tested. Procedure for proof pressure testing in this case is specified in the assembly instructions for the appropriate hose type.

After successfully passing pressure test, hose assembly shall be permanently marked with the new recertification date (see 7.2).

The testing facility will recommend if the condition of the hose warrants the cost of assembling new fittings, joining the lengths together and proof testing.

PFDE-ES28, Rev. U: Handling, Maintenance, Inspection, Repair

Black Eagle Hose Assemblies



7 Procedure for Repair and Recertification (cont.)

7.1.3 Fitting Re-ending

In case of fitting damage or hose damage near fitting (usually due to kinking) it is allowed to cut off the fitting and replace it by a new one. This can be done by Parker certified facilities only and will require pressure test at 1.5 x maximum working pressure of hose assembly. Recommended testing time = 15 minutes.

7.2 Recertification

Recertification shall include Level 2 inspection acc. to section 6.5.2 and a hydrostatic pressure test.

Unless otherwise agreed between customer and test facility, test conditions are:

- Test pressure = 1.5x maximum working pressure of hose assembly. Allow for at least 30 minutes stabilization time before starting recording pressure decay.
- Pressure hold time = 1 hour
- Pressure decrease of maximum 5% is allowed.

To avoid hose damage due to excessive pressurizations, it is recommended to limit the number of pressure tests to 1.5 x maximum working pressure to 20 for the lifetime of the hose assembly. This may include pressure testing during recertification as well as pressure testing after fitting re-ending.

After successfully passing pressure test, hose assembly shall be permanently marked with the word RECERT plus the consecutive number of recertification. i.e. "RECERT-3" and recertification date.

It is recommended to keep the number of recertifications limited to 10 times.

8 Parker Certified Distributors/ Service Addresses

The below listed companies have been certified by Parker Polyflex to manufacture, inspect and re-certify Black Eagle hose assemblies:

- Abdex Industries WA, 49A Sustainable Avenue, Bibra Lake, WA 6163, Australia, +61 89418 3044
- Beattie Industrial Ltd., Div. of Newfoundland Offshore, 1345 Topsail Road, PO Box 8398, A1B 3N7Paradise, NF, Canada, +1 (709) 782-2623
- Flexiflo Corp., PO Box 18532, Jebel Ali Free Zone, Dubai, United Arab Emirates, +971 4 8838131
- Fluid Control Service AS, Ljosheimsvegen 1, 4050 Sola, Norway, +47 51 64 49 50
- Active Service AS, Sjøkrigsskoleveien 15, 5165 Laksevåg, Norway, +47 55 94 22 50
- Hydraulit AS, Bleivassvegen 30F, 5347 Ågotnes, Norway, +47 56 12 67 00
- *Hydrasun Group Ltd., Gateway Business Park, Moss Road, Aberdeen AB12 3GQ, United Kingdom, +44 1224 618618 (24 Hrs.)
- Mento AS, PO.Box 44, Kontinentalveien 22, 4098 Tananger, Norway, +47 51 64 86 00
- Norwesco Industries (1983) Ltd., 6908L - 6th Street S.E., Calgary AB, T2H 2K4, Canada, +1 403 258 3883
- *Parker Hannifin Manufacturing Germany GmbH & Co. KG - FLUID CONNECTORS GROUP - POLYMER HOSE
- DIVISION EUROPE - An der Tuchbleiche 4 - 68623 Lampertheim, Germany, + 49 (0) 6256 81-0
- Parker Hannifin Corporation, Parflex Division, 11151 Cash Road, Stafford, TX 77477, USA, +1 281 566 450

Note: * only these facilities are currently certified to re-end 3" Black Eagle hoses. Level 2 inspection, pressure testing and recertification of all sizes can be done by all above listed facilities.

PFDE-ES28, Rev. U: Handling, Maintenance, Inspection, Repair



Appendix 1: Chemical Resistance Chart

The below chart contains chemical resistance information for Polyamide 11 (Nylon 11), Fluoropolymer and Proprietary Material used on Nautilus 20 hose. These are the most common core tube materials used for Parker Polyflex oil & gas hoses.

Please refer to the technical datasheets for more detailed information.

Rating Codes

Abbreviation	Status	Description
E	Excellent	Good to excellent. Little or no swelling, tensile or surface change. Preferred choice.
A	Good	Good to excellent. Little or no swelling, tensile or surface change. Limitations with temperature and type of fluid.
B	Limited	Marginal or conditional. Noticeable effects but not necessary indicating lack of serviceability. Further testing is suggested for specific application. Very long-term effects.
X	Unsatisfactory	Poor or unsatisfactory. Not recommended without extensive and realistic testing.
-		Indicates that this was not tested.
*	Swelling	Increase of volume of material, due to absorption of a solvent.

Material Code for Hose Core Tubes

Abbreviation	Material
N	Polyamide
M	Co-extruded tube with fluoropolymer inner liner
POM	Polyoxymethylene

Notes on the Chemical Resistance Table

- The chemical resistance table is a simplified rating tabulation based on immersion tests. Higher temperatures tend to reduce ratings. Since final selection depends on pressure, fluid, ambient temperature and many other factors not known to Parker Hannifin, no performance guarantee is expressed or implied.
- The indications do not imply any compliance with standards and regulations and do not refer to possible changes of color, taste or smell.
- Some hose applications must take into account legal and insurance regulations. The chemical resistance indicated does not express or imply approval by certain institutions.
- Chemical resistance does not imply low permeation rates. For gas applications, refer to Gas Permeability of Plastics (pg. A-8). Note that hoses with coextruded core tube with fluoropolymer inner liner are not recommended for gas applications.
- For fluids, not listed or for advice on particular applications, please contact Parker Hannifin, Polyflex Division in Lampertheim, Germany.

PFDE-ES28, Rev. U: Handling, Maintenance, Inspection, Repair

Appendix 1: Chemical Resistance Chart for Black Eagle Hose



Chemical	Concentration	N				M	P		
		20°C (68°F)	40°C (104°F)	60°C (140°F)	90°C (194°F)	100°C (212°F)	23°C (73°F)	100°C (212°F)	150°C (302°F)
Acetaldehyde		A	B	X	X	A	A	A	—
Acetic Acid	5%	A	A	A	B	E	A	A	—
	10%	A	A	B	X	E	A	A	—
	50%	B	X	X	X	E	A	A(75°C)	—
Acetic Anhydride		B	X	X	X	E	—	—	—
Acetone	Pure	A	A	B	X	A	A	A	—
Acetylene		A	A	A	—	A	A	A	—
Air		A	A	A	A	A	A	A	A
Aluminium Sulfate	Saturated Solution	A	A	A	A	A	A	—	—
Ammonia	Liquid or Gas	A	A	A	X	A	A	A	A
Ammonium Chloride		A	A	A	—	A	A	A	—
Ammonium Hydroxide	Concentrated	A	A	A	A	A	A	A(80°C)	—
Ammonium Nitrate		A	A	A	A	A	A	A	—
Ammonium Sulfate	Saturated Solution	A	A	B	—	E	A	—	—
Amyl Acetate		A	A	A	B	A	A	A	—
Aniline		B*	X	X	X	E	A	B	—
Asphalt		A	A	A	A	A	A	—	—
Barium Chloride	Saturated Solution	A	A	A	A	A	A	—	—
Benzaldehyde		A	B	X	X	E	A	A(60°C)	—
Benzene		A	A*	B	X	E	A	A	—
Benzyl Alcohol		B	X	X	X	E	A	A(80°C)	—
Bleach		B	X	X	X	E	A	A	—
Bromine		X	X	X	X	B	X	X	X
Butane		A	A	A	A	A	A	—	—
Butyl Alcohol (Butanol)		A*	B	X	X	E	A	A	—
Calcium Arsenate		A	A	A	—	A	—	—	—
Calcium Bromide		A	A	A	B	—	—	—	—
Calcium Chloride	Saturated Solution	A	A	A	A	A	A	A	—
Calcium Nitrate		A	A	A	—	A	A	—	—
Camphor		A	—	—	—	A	A	—	—
Carbonated Water		A	A	A	A	A	—	—	—
Carbon Dioxide		A	A	A	A	A	A	—	—
Carbon Disulfide		A*	B*	B	X	A	A	A	—
Carbon Monoxide		A	A	A	A	A	A	A	A
Carbon Tetrachloride		X	X	X	X	A	A	A	—
Cement Slurries		A	A	A	—	A	—	—	—
Chlorinated Solvents		B	X	X	X	E	A	A/B	—
Chlorine		X	X	X	X	E	X	X	X
Chloroform		B	X	X	X	E	A	A	—
Chromic Acid		X	X	X	X	E	A	B(80°C)	—
Citric Acid	Saturated Solution	A	A	B	X	E	A	A	—
Copper Sulfate		A	A	A	A	A	A	A	—
Crude Oil		A	A	A	B	A	A	—	—
Cyclohexane		A	A	A	B	A	A	A	—
Cyclohexanol		A	B	X	X	E	A	A	—
Cyclohexanone		A	B	X	X	E	A	A	—
Decalin		A	A	A	B	A	A	—	—
Diacetone Alcohol		A	A	B	X	E	—	—	—
Diammonium Phosphate		A	A	B	—	E	—	—	—
Dichloroethylene		B	X	X	X	E	—	—	—
Diesel		A	A	A	A	A	A	A	—
Diester Oils		A	A	A	B	A	—	—	—
Diethanolamine	20%	A	A*	A*	B	A	—	—	—
Diethyl Ether		A	—	—	—	E	A	A	—
Diocetyl Phosphate		A	A	A	B	—	—	—	—
Diocetyl Phthalate		A	A	A	B	A	A	—	—

PFDE-ES28, Rev. U: Handling, Maintenance, Inspection, Repair



Appendix 1: Chemical Resistance Chart

Chemical	Concentration	N				M	P		
		20°C (68°F)	40°C (104°F)	60°C (140°F)	90°C (194°F)	100°C (212°F)	23°C (73°F)	100°C (212°F)	150°C (302°F)
Ethanol	Pure	A*	B	B	X	E	A	A	—
Ethyl Acetate		A	A	A	—	A	A	A(50°C)	—
Ethylene Chlorhydrin		X	X	X	X	E	A	—	—
Ethylene Oxide		A	A	X	X	E	A	A(50°C)	—
Fatty Acid Esters		A	A	A	A	A	—	—	—
Fluorine		X	X	X	X	X	X	X	X
Formaldehyde	Technical	A	B	X	X	E	A	A	—
Formic Acid	10%	X	X	X	X	E	B	B	—
Freon		A	—	—	—	A	A	—	—
Furfuryl Alcohol		A	A*	B	X	E	A	A	—
Gas (Coal)		A	A	—	—	A	A	—	—
Gasoline (High Octane)		A	A	A*	—	A	A	A	—
Glucose		A	A	A	A	A	A	—	—
Glycerine	Pure	A	A	B	X	E	A	A	—
Heptane		A	A	A*	—	A	A	A	—
Hexane		A	A	A	A	A	A	A(60°C)	—
Hydraulic Fluid (petroleum base)		A	A	A	A	A	A	A	—
Hydraulic Fluid (phosphate ester base)		A	A	A	B	A	A	—	—
Hydraulic Fluid (water base)		A	A	A	A	A	—	—	—
Hydrochloric Acid	15%	A	B	X	X	E	A	A	—
	28%	X	X	X	X	E	A	A	—
	37%	X	X	X	X	A	A	—	—
Hydrofluoric Acid	3%	A	B	X	X	E	B	—	—
Hydrogen		A	A	A	A	A	A	—	—
Hydrogen Peroxide	20%	A	B	—	—	E	A	A	—
Iron Trichloride	Saturated Solution	A	A	A	—	A	A	B	—
Isocyanates		B	X	X	X	E	—	—	—
Isooctane		A	A	A	A	A	A	—	—
Isopropyl Alcohol		A	B	X	X	E	A	A	—
Kerosene		A	A	A*	B	A	A	A(85°C)	—
Lactic Acid		A	A	A	B	E	A	A	—
LP Gas		A	A	A	A	E	—	—	—
Magnesium Chloride	50%	A	A	A	A	A	A	A	—
Mercury		A	A	A	A	A	A	A	—
Methane		A	A	A	A	E	A	A	A
Methanol	Pure	A	B	B*	X	E	A	A	—
Methyl Acetate		A	A	A	—	A	A	—	—
Methyl Bromide		A	X	X	X	E	A	—	—
Methyl-Cellosolve		A	A	A	X	A	—	—	—
Methyl Chloride		A	X	X	X	E	A	—	—
Methylene Chloride		X	X	X	X	A	A	—	—
Methyl Ethyl Ketone (MEK)		A	A	B	X	—	A	A(80°C)	X(200°C)
Methyl Isobutyl Ketone		A	A	B	X	E	A	—	—
Methyl Sulfate		A	B	—	—	E	—	—	—
Monochlorobenzene		B	X	X	X	A	A	A(75°C)	—
Monoethylene Glycol (MEG) Ethane-1, 2-diol		A	A	A*	X	E	A	A	B(200°C)
Naphtha		A	A	A	—	A	A	A	—
Naphthalene		A	A	A	B	A	A	A	—
Natural Gas		A	A	A	A	E	A	—	—
Nitric Acid		X	X	X	X	A	X	X	X
Nitrobenzene		B	X	X	X	A	A	B(80°C)	—
Nitrogen Gas		A	A	A	A	E	A	—	—
Oils Refined		A	A	A	B	A	A	A	—

PFDE-ES28, Rev. U: Handling, Maintenance, Inspection, Repair

Appendix 1: Chemical Resistance Chart for Black Eagle Hose



Chemical	Concentration	N				M	P		
		20°C (68°F)	40°C (104°F)	60°C (140°F)	90°C (194°F)	100°C (212°F)	23°C (73°F)	100°C (212°F)	150°C (302°F)
Oleic Acid		A	A	A	B	A	A	A	—
Oxalic Acid		A	A	B	X	E	A	A	—
Oxygen Gas		A	A	B	X	A	A	—	—
Ozone		B	X	X	X	E	A	B	—
Perchloric Acid		B	X	X	X	B	A	A	—
Perchloroethylene		B	X	X	X	E	A	A	—
Petroleum Ether		X	X	X	X	E	A	A(80°C)	—
Phenols		A	A	A	B	E	B	X	X
Phosphoric Acid	50%	A	B	X	X	E	A	A	A
Picric Acid		B	X	X	X	E	A	A	—
Potassium Carbonate		A	A	B	X	E	A	—	—
Potassium Chloride		A	A	B	X	E	A	A	—
Potassium Hydroxide	50%	A	B	X	X	E	A	A(80°C)	—
Potassium Nitrate		A*	B*	X	X	E	A	A	—
Potassium Permanganate	5%	X	X	X	X	E	A	A(60°C)	—
Potassium Sulfate		A	A	A	A	A	A	A	—
Propane		A	A	A	A	A	A	—	—
Propylene Glycol		A	B	X	X	A	A	—	—
Pyridine	Pure	B	X	X	X	E	A	A(80°C)	—
Sea Water		A	A	A	A	A	A	A	—
Sodium Borate		A	A	A	—	A	A	—	—
Sodium Carbonate	Saturated Solution	A	A	B	X	E	A	A(80°C)	—
Sodium Chloride	Saturated Solution	A	A	A	A	A	A	A	—
Sodium Hydroxide	50%	A	B	X	X	E	A	A	A
Sodium Hypochlorite	Concentrated	B	X	X	X	E	A	—	—
	Dilute Commercial	A	B	X	X	E	A	A	—
Sodium Sulfide		A	A	B	—	E	A	A	—
Stearic Acid		A	A	A	B	A	A	—	—
Stearin		A	B	B	—	E	—	—	—
Styrene Monomer		A	A*	—	—	E	A	—	—
Sulphur Dioxide		B	X	X	X	A	A	A	A
Sulphur Hexafluoride Gas		A	A	A	A	A	A	—	—
Sulphuric Acid	1%	A	B	B	X	A	A	—	—
	10%	A	B	X	X	A	A	B(80°C)	—
Sulphuric Anhydride		B	X	X	X	E	A	—	—
Tartaric Acid		A	A	A	B	A	A	A	—
Tetrahydrofuran (THF)		A	A	B	X	E	A	B	—
Toluene		A	A*	B	B	E	A	A	—
Tributyl Phosphate		A	A	A	B	A	A	—	—
Trichloroethane		B	X	X	X	E	A	A(75°C)	—
Trichloroethylene		B	X	X	X	E	A	A(80°C)	—
Tricresyl Phosphate		A	A	A	B	A	B	—	—
Triphenyl Phosphate		A	A	B	—	A	—	—	—
Trisodium Phosphate		A	A	A	A	A	—	—	—
Turpentine		A	A	B	—	A	A	—	—
Urea		A	A	B	B	E	A	A	—
Uric Acid		A	A	A	B	A	A	—	—
Water		A	A	A	A	A	A	A	—
Water Glycols e.g. Oceanic HW fluids a) Transqua HT/HT2 b) Brayco Micronic SV fluids a) registered trademark of MacDermid Group b) registered trademark of Castrol		A	A	A	B	A	A	A	—
Xylene		A	A*	B	B	E	A	B/X	—
Zinc Bromide		A	A	A	—	—	—	—	—
Zinc Chloride		A	A	B	X	E	A	A(80°C)	—

A Hose
 Waterblast
 Hydraulic
 Oil & Gas
B Adapters
C Quick Couplings
 Accessories
D
E Appendix

PFDE-ES28, Rev. U: Handling, Maintenance, Inspection, Repair

Appendix 2: Data for Tensile Loading and Weights of Black Eagle Hoses

Note that all below values of tensile forces include the own weight of the hoses.

The values below have been established based on lab testing (tensile test followed by impulse testing) of short hose assemblies. At the tensile forces stated below the hoses will not elongate more than 30% at the area of highest load (topside). Pressurized hose can take higher tensile load, it will elongate less.

2448N-32V80	Pressure (bar)	0	100	300 and above
	Max. tensile force (kN)	30	50	100
2580N-32V80	Pressure (bar)	0	100	300 and above
	Max. tensile force (kN)	30	50	100
2648N-32V80	Pressure (bar)	0	100	300 and above
	Max. tensile force (kN)	30	50	100
2240N-48V80	Pressure (bar)	0	100 and above	
	Max. tensile force (kN)	30	50	
2440N-48V80	Pressure (bar)	0	100	300 and above
	Max. tensile force (kN)	600	100	200
2640N-48V80	Pressure (bar)	0	100	300 and above
	Max. tensile force (kN)	60	100	200

The table below shows examples.

Hose Part No.	Hose I.D.		Hose O.D.		Hose Weight			
					In Air		In Water	
	inch	mm	inch	mm	Empty (kg/m)	Full of Water (kg/m)	Empty (kg/m)	Full of Water (kg/m)
2448N-32V80	2	50.5	3.16	80.5	8.5	10.5	3.3	5.3
2580N-32V80	2	50.5	3.32	84.5	9.4	11.5	3.7	5.7
2648N-32V80	2	50.5	3.32	84.5	12.1	14.1	6.2	8.1
2240N-48V80	3	75.0	4.48	114.0	11.5	16.0	1.1	5.6
2440N-48V80	3	75.0	4.80	122.0	18.7	23.2	6.7	11.3

1st Example: No pressure. 1000 m length of 2580N-32V80 shall be deployed. Hose weight in water, full of water, 5,7 kg/m × 1000 m = 5700 kg. Maximum tensile force is 30 kN, therefore a 1000 m length is too heavy to deploy in these conditions.

2nd Example: Pressure 300 bar. 1500 m length of 2580N-32V80 shall be deployed. Hose weight in water, full of water, 5,7 kg/m × 850 m = 8550 kg. Maximum tensile force is 100 kN, so a 1500 m length of 2580N-32V80 is okay to deploy when pressurized at 300 bar, and an additional weight of 10000-8550=1450 kg may be added.

The following maximum tensile force over elongation plots indicate which maximum elongation will locally occur at a specific maximum tensile force is 20 kN, so a 300 m length of 2240N-48V80 is OK to deploy when pressurized at 100 bar, and an additional weight of 2000-1680 = 320 kg may be added.

PFDE-ES28, Rev. U: Handling, Maintenance, Inspection, Repair



Appendix 2: Data for Tensile Loading and Weights of Polyflex Hoses

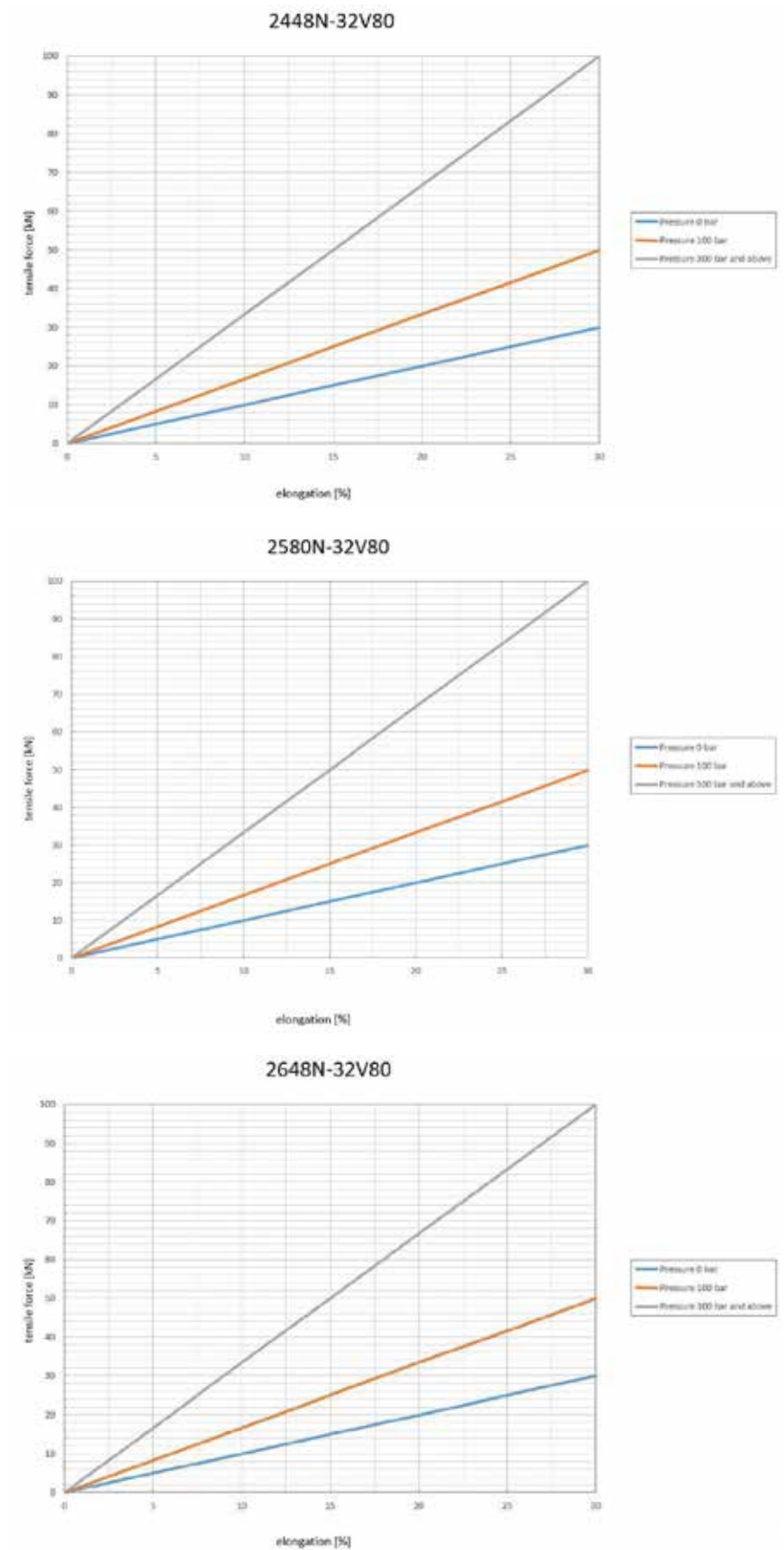

PFDE-ES28, Rev. U: Handling, Maintenance, Inspection, Repair



Appendix 2: Data for Tensile Loading and Weights of Polyflex Hoses

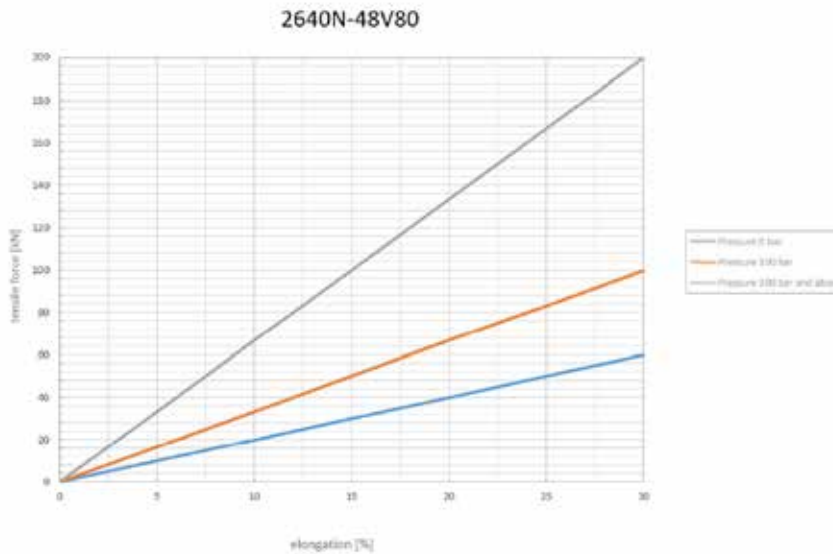
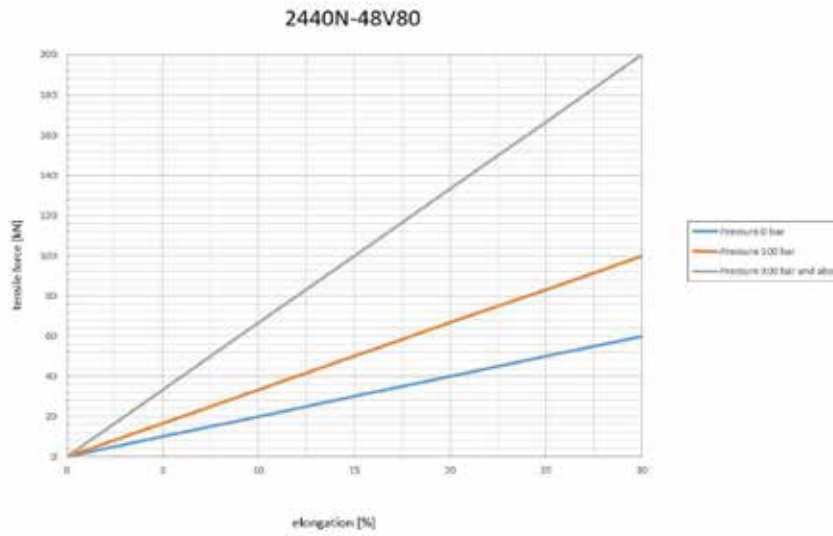
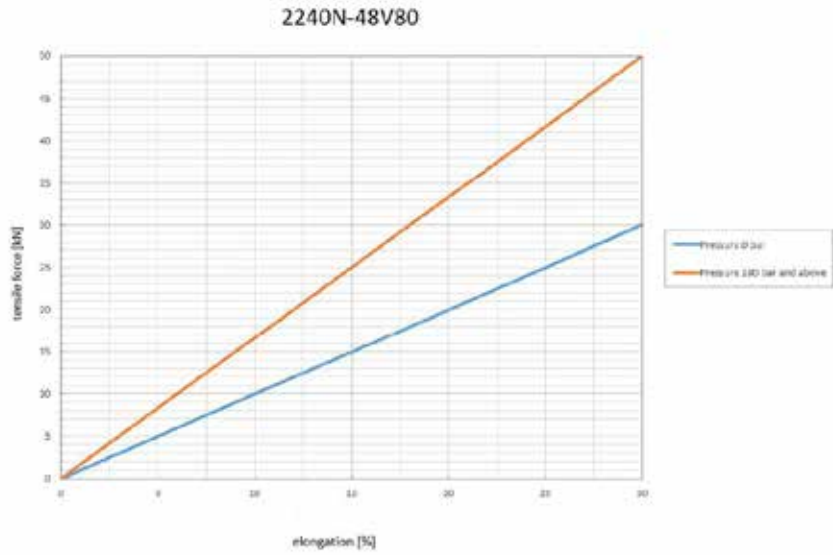

PFDE-ES28, Rev. U: Handling, Maintenance, Inspection, Repair



Appendix 3: Procedure for a repair of a local damage in the outer cover

1 Purpose

This engineering standard provides a recommended practice for repair of local outer cover damage on a Polyflex large bore hose. This instruction is valid for sizes 1-1/2" (DN 38) up to size 3" (DN 75) with ColorGard.

Polyflex large bore hoses are being increasingly used subsea, deployed as single line hoses. These hoses are therefore protected by a dual color outer cover, the extra thick ColorGard sheath (see picture):

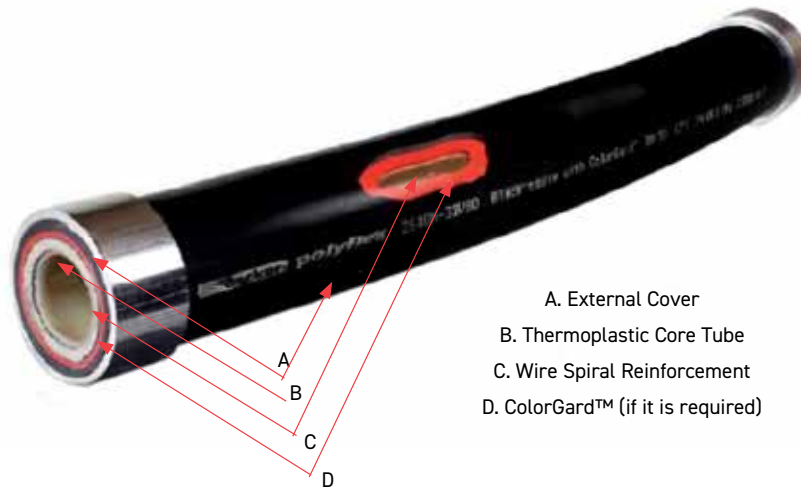

2 Important Safety Notices

Before repairing a Polyflex hose, carefully read and fully understand the below instructions. Refer to section 7.2.1 to determine whether the repair is allowed.

Follow your local safety regulations and ensure that operators are equipped with appropriate protection. The repair of Polyflex hoses requires a safe use of a hot-air gun.

Incorrect handling may significantly reduce the lifetime of the hose and could cause dramatic failures.

PFDE-ES28, Rev. U: Handling, Maintenance, Inspection, Repair

Appendix 3: Procedure for a repair of a local damage in the outer cover

3 Preparation

Recommended equipment and materials:

- Original Polyflex thermoplastic filling material to enable a permanent and proper compound to the original outer cover of the hose
- Industrial hot-air gun (must be able to achieve min. 1200°F/650°C temperature) with a small and removable front nozzle to locally melt the filling material and the damaged area of the outer cover. A spoon, knife or a putty knife to locally press/ fill the melted material into the damaged area
- Enough cold water to cool down the heated hose immediately
- Grinding tool and sand paper (grain 60 80) to smoothen the repaired spot
- Optional: Anti splatter spray/ silicone spray for final polish after the finished repair



4 Repair Procedure

4. 1

Clean the defective spot with a lint-free cloth or with compressed air.

Do not use any cleaning detergent!

For the repair, the area must be dry and free of dirt and dust.

4. 2

Melt the damaged area with the hot-air gun at approx. 1112°F/600°C locally. Immediately when the material is melting, use a spoon or putty knife to press the melted material into the damaged area.

Cool the heated area immediately with cold water.





4 Repair Procedure (cont.)

4.3

Visually check the melted area for any holes or remaining gaps.



4.4

Fill open gaps with melted filling material.



4.5

Spackle the melted material into the gaps by using a putty knife or similar. Make sure that enough melted material is used for the repair.

**ATTENTION:
DO NOT OVERHEAT THE HOSE**

STOP HEATING IMMEDIATELY AFTER MATERIAL IS STARTING TO MELT!



4.6

Cool down the area with cold water in order to avoid any heat damages of the hose.



PFDE-ES28, Rev. U: Handling, Maintenance, Inspection, Repair

Appendix 3: Procedure for a repair of a local damage in the outer cover

4 Repair Procedure (cont.)

4.7

Remove excessive filling material by using a grinding tool. The grain of the tool / grinding paper should be approx. 60 - 80



4.8

By grinding the repaired area, unfilled gaps might become visible. These gaps shall be filled by following step 4.4 to 4.7

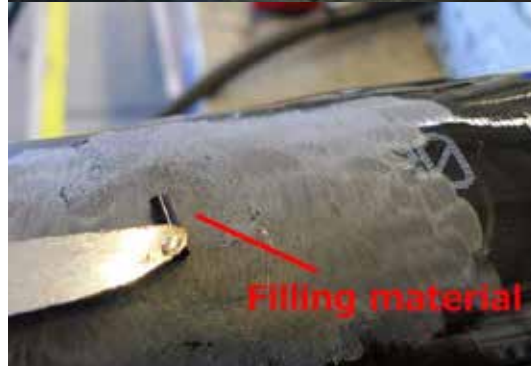



4 Repair Procedure (cont.)

4.9

Remove excessive melted filling material with a grinding tool (see 4.7).



4.10

Final grinding by hand with sand paper (Grain = 60 - 80)



4.11

Final finish by locally heating up the repaired area.

ATTENTION:
DO NOT OVERHEAT THE HOSE

STOP HEATING IMMEDIATELY AFTER MATERIAL IS STARTING TO MELT!

Cool down immediately with cold water to avoid any overheating.



4 Repair Procedure (cont.)

4. 12

Polish repaired outer cover by using Silicone spray or similar. (optional)



PFDE-ES28, Rev. U: Handling, Maintenance, Inspection, Repair

Appendix 4: Recommendations for use of Parker Polyflex Black Eagle hoses with gas and sour gas.

4.1 Use of Black Eagle Hoses with Gas

Please refer to Hose Intro "Chemical compatibility table" (pg. A-108) for chemical compatibility of core tube materials with gases. However, good chemical compatibility is not the only parameter to consider for gas use. The other key parameter is permeability. Permeation could lead to different potential failure modes. One is hose cover blistering and another is core tube collapse due to rapid gas decompression and/or gas trapped under pressure between hose layers.

Permeability is defined as the ability of a substance to allow another substance to pass through it. For a circular tube, it is calculated per the below formula:

Permeability Coefficient

$$V = PW * A * T * P/S$$

- V** volume of gas, in cm³, which diffuses through a 1mm thickness
- PW** permeability coefficient, cm³*mm/m²*day*bar, see table below
- A** is the area across which the gas diffuses, in m²
- S** thickness of tube, in mm
- T** diffusion time, in days
- p** pressure difference across the plastic, in bar

Recommended Frequencies of Inspection							
PW values for various gases, cm ³ *mm/m ² *d*bar	N2	Air	O2	CO2	H2	He	CH4
PA11, methanol washed	5	7	21	60	130		6
PA12	9	13	43	105	900	500	14
POM	2	4	4	20	80		

- These guidance values are taken from literature. They are based on room temperature.
- Higher temperatures significantly increase permeation rates.
- Actual behavior may vary considerably because of variations in processing.

The below simplified estimation formula is a result of recalculations based on the typical core tube thickness and area of Polyflex hoses.

$$V=K PW*P$$

- V** volume of gas, in cm³, which diffuses through a 1mm thickness
- K** recalculation coefficient for area and thickness, see next table
- PW** permeability coefficient, cm³*mm/m²*day*bar, see next table
- P** pressure difference across the tube, in bar K coefficients for hose sizes

PFDE-ES28, Rev. U: Handling, Maintenance, Inspection, Repair

Appendix 4: Recommendations for use of Parker Polyflex Black Eagle hoses with gas and sour gas.

4.1 Use of Black Eagle Hoses with Gas (cont.)

Permeability Coefficient (cont.)

Permeation									
-04	-05	-06	-08	-12	-16	-20	-24	-32	48
0.017	0.019	0.02	0.027	0.035	0.040	0.044	0.048	0.053	0.048

Example: how much CH₄ would permeate through core tube of a 2" hose at 10000 psi.

$$V = 0.053 \times 6 \times 690 = 219.42 \text{ cm}^3 \text{ per core tube meter per day}$$

As previously mentioned, all the calculated values can be used for estimation only. Permeation coefficients are just literature values for lab conditions, permeation through hose cover is not considered.

As an example, permeation of CH₄ at 1 meter has been measured at 170 bar and ambient temperature and the result is represented on the below graph. The above calculation would result in a value of $V = 0.053 \times 6 \times 170 = 54.06 \text{ cm}^3$ per core tube meter per day, which would mean 2.25 cm³ per hour, and only approx. 0.57 cm³ per hour have been measured.

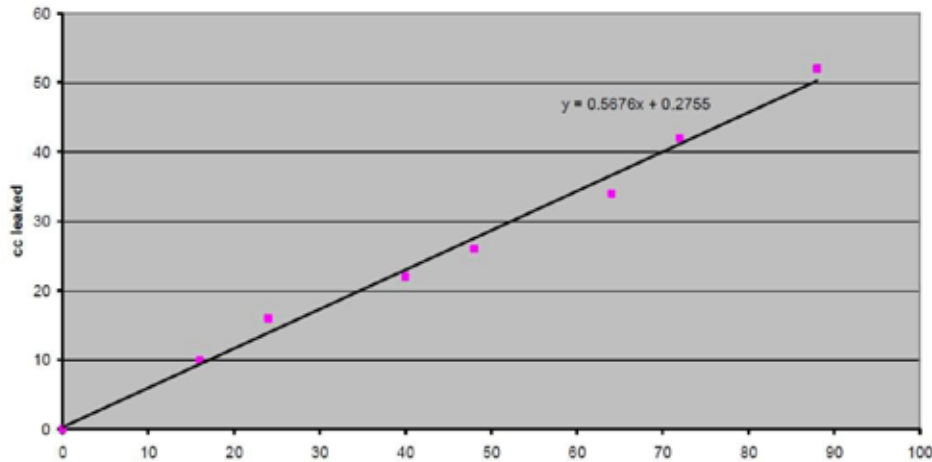

Note that in all previous discussions gas which permeates through the core tube was mentioned. Obviously, there is one more barrier hose cover. If cover is pin-pricked, gas will easily go through it and no issues will occur. But pin-pricking is not acceptable for subsea service as the reinforcement wires will corrode. In addition, collapse resistance of hose would be compromised. For land based operations, all Parker Polyflex hoses may be pin-pricked.

Pin-pricking is not required on hoses with Colorgard. Performance of those hoses with gas has been confirmed by several tests. Test summary is provided below.

Without pin-pricking, gas will also have to permeate through the hose cover. The formula for calculation is the same as for core tube, only other permeability coefficients shall be used. Parker hoses are designed in the way that cover material has higher permeability coefficient compared to core tube, so more gas can permeate through the cover. In addition, area of permeation is larger. Thick cover is rigid enough to withstand any possible pressure build up in the hose annulus without building blisters.

PFDE-ES28, Rev. U: Handling, Maintenance, Inspection, Repair

Appendix 4: Recommendations for use of Parker Polyflex Black Eagle hoses with gas and sour gas.

4. 1 Use of Black Eagle Hoses with Gas (cont.)

Permeability Coefficient (cont.)

Hose Type	Test Description	Test Gas	Test Pressure and Temperature	Test Results
2640N-24V80	Pre-conditioning of hose: 24 hours soak in methanol at room temperature and atmospheric pressure. Pressurize with test gas mixture for 12 hours. Decompress at 20 bar/min. Leave for 1 hour. Repeat this pressure cycle two more times.	Gas mixture 97/3 CH ₄ / CO ₂	740 bar (10730 psi) at 25°C / 77°F	No signs of blistering or slitting and no decompression damage have been found on hose core tube at a magnification of X20.
2640N-24V80	Pressurize with test gas at 345 bar for 24 hours. Decompress at 70 bar/min. Leave for at least 12 hours. Repeat this pressure cycle two more times.	N ₂	345 bar (5000 psi) at ambient temperature	No signs of blistering or slitting and no decompression damage have been found on hose cover at a magnification of X20.
2640N-32V80 2580N-32V80	Pressurize with test gas at 690 bar for 30 days and slowly decompress (decompression rate not noted). Pressure test with water 20 times at 1035 bar for 60 sec. Pressure test with water at 1035 bar for 1 hour. Pressurize with test gas at 690 bar for 47 days and slowly decompress (decompression rate not noted). Pressure test with water 20 times at 1035 bar for 60 sec. Pressure test with water at 1035 bar for 1 hour. Perform burst test.	Gas mixture 97/3/2 CH ₄ /CO ₂ / H ₂ S water added to adjust system pH to 3.5- 3.8	690 bar (10000 psi) at 25°C / 77°F	No deterioration on cover have been found. After all testing, hose passed minimum burst press.
2440N-32V80 2448N-32V80	Pressurize with Nitrogen at 170 bar for 7 days. Then pressurize with Methane at 170 bar for 45 days.	N ₂ and CH ₄	170 bar (2465 psi) at ambient temperature	No leakages at connections and no ballooning of the cover. The bore inspection at about 910 hours revealed that the core tube was perfectly smooth and circular. Hose expands by about 0.6 to 0.8 mm upon inflation to 175 bar, but there is no creep in diameter thereafter. After decompression at the end of testing, it took around 6 hours to return to its original outside diameter.

The situation changes, however, if the hose is in subsea service. With external pressure applied, pressure difference across the cover becomes the limiting factor.

Gas permeating through core tube could stay in the hose annulus between core tube and cover and some pressure will build up there. Due to undefined volume of hose annulus of Polyflex hoses (this is related to hose design and manufacturing), it is not possible to calculate this pressure. And in case of quick hose depressurization this built-up pressure could lead to core tube collapse.

With a hose deployed down from a vessel, the situation becomes even more complicated. External pressure varies over the hose length. Lower part of the hose may have no gas permeation through cover, all gas which has passed through the core tube is creeping up through annulus and starts leaving the hose at the pressure balance point. In this case gas permeates through core tube on the whole length of hose but it permeates through cover only on the part length. Obviously, the volume of gas which needs to locally penetrate through cover is higher. This could lead to blisters on the cover. Quick retrieving of hose (which means external pressure change) could lead to the same phenomenon.

Parker Polyflex Black Eagle hoses have been used in gas applications for many years. Based on the lab testing and field experience, multiple number of parameters shall be considered. Therefore, design factor of min. 4:1 should be applied (max. operating pressure should not exceed 25% of minimum burst pressure of the hose). This is also required by ISO 7751. If possible, guards of hose whip restrictors shall be used. Please also refer to Parker Safety Guide 4400-B.1. (pg E-3)

PFDE-ES28, Rev. U: Handling, Maintenance, Inspection, Repair



Appendix 4: Recommendations for use of Parker Polyflex Black Eagle hoses with gas and sour gas.

4. 2 Use of Parker Polyflex hoses with sour gas.

Core tube of most of Parker Polyflex Black Eagle hoses is made from Polyamide 11. This material is perfectly resistant to Hydrogen sulfide. Only aqueous solutions which are acidic can lead to an acceleration of polymer degradation. Due to the low acidity and generally low partial pressures of Hydrogen sulfide in crude oil or natural gas this effect can be neglected.

Reinforcement wires are made of very high strength steel. Processing of these wires results in very small grain sizes which reduce the susceptibility of the material to cracking that can be caused by H₂S. In addition, contact of wires with H₂S is limited to the amount of gas which has permeated through the core tube. This amount is also very low due to low partial pressures. In addition, testing has been conducted: totally 77 days of exposure to 2% of wet H₂S at 690 bar (resulting in partial pressure of 13,8 bar (200 psi)) and subsequent burst pressure test and SEM analysis of wires. Minimum burst pressure was achieved and in all the wire samples examined, there was no evidence of microcracks or intergranular fracture, nor was there any evidence of embrittlement.

More attention shall be put to hose fittings. They are in direct contact to fluids and can be subjected to H₂S. Some limitations and requirements are listed in ISO 15156 parts 1 to 3 (former NACE MR0175). The usual question "are the fittings NACE compliant?" cannot always be answered with yes or no.

The original and subsequent editions of NACE Standard MR0175/ISO 15156 established limits of H₂S partial pressure above which precautions against sulfide stress cracking (SSC) were always considered necessary. They also provided guidance for the selection and specification of SSC-resistant materials when the H₂S thresholds were exceeded. In more recent editions, NACE MR0175 has also provided application limits for some corrosion resistant alloys, in terms of environmental composition and pH, temperature and H₂S partial pressures.

In addition, requirements for different equipment may be also different.

The two important statements out of **NACE MR01175**/ISO 15156 shall be considered.

The behavior of metallic materials in H₂S-containing environments is affected by complex interactions of parameters, including the following:

- a) chemical composition, method of manufacture, product form, strength, hardness of the material and its local variations, amount of cold work, heat-treatment condition, microstructure, microstructural uniformity, grain size and cleanliness of the material;
- b) H₂S partial pressure or equivalent concentration in the water phase;
- c) chloride ion concentration in the water phase;
- d) acidity (pH) of the water phase;
- e) presence of sulfur or other oxidants;
- f) exposure to non-production fluids;
- g) exposure temperature;
- h) total tensile stress (applied plus residual);
- i) exposure time.

Core tube of most of Parker Polyflex Black Eagle hoses is made from Polyamide 11. This material is perfectly resistant to Hydrogen sulfide. Only aqueous solutions which are acidic can lead to an acceleration of polymer degradation. Due to the low acidity and generally low partial pressures of Hydrogen sulfide in crude oil or natural gas this effect can be neglected.

WARNING — CRAs (corrosion-resistant alloys) and other alloys selected using ISO 15156 are resistant to cracking in defined H₂S-containing environments in oil and gas production, but not necessarily immune to cracking under all service conditions. *It is the equipment users responsibility to select the CRAs and other alloys suitable for the intended service.* Below there is the list of Parker Polyflex hose fittings for some Black Eagle hoses and the information about use with H₂S based on ISO 15156 requirements. Hose fittings are not explicitly listed in ISO 15156.

Note that several fitting types with various materials may exist for the same hose.

PFDE-ES28, Rev. U: Handling, Maintenance, Inspection, Repair

Appendix 4: Recommendations for use of Parker Polyflex Black Eagle hoses with gas and sour gas.

4. 2 Use of Parker Polyflex hoses with sour gas. (cont.)

Hose Type	Fitting Series	Nipple Material	Shell Material	Maximum Temperature		Maximum Partial Pressure (pH ₂ S)		Remarks
				°C	°F	kPa	psi	
2440N-20V80	1xxLX-	Duplex 2205	316 or 316Ti	232	450	10	1.5	Any combination of chloride concentration and in situ pH occurring in production environments is acceptable. If chloride concentration is less than 50 mg/l, no restrictions on pH ₂ S and pH are set.
2640N-24V80	1xx5X-	Duplex 2205	Duplex 2205	232	450	10	1.5	Any combination of chloride concentration and in situ pH occurring in production environments is acceptable. If chloride concentration is less than 50 mg/l, no restrictions on pH ₂ S and pH are set.
	6xx5X-	4340 Q&T	316 or 316Ti	-	-	0.3	0.05	Normally, no special precautions are required for the selection of steels for use under these conditions, nevertheless, highly susceptible steels can crack.
2640N-24V80	6xx5X-	Nitronic 50 (S20910)	316 or 316Ti	66	150	100	15	Any combination of chloride concentration and in situ pH occurring in production environments is acceptable.
2240N-32V10 2248N-32V10	1xxS6-	4340 Q&T	316 or 316Ti	-	-	0.3	0.05	Normally, no special precautions are required for the selection of steels for use under these conditions, nevertheless, highly susceptible steels can crack.
2449N-32V10	1xxS8-	4340 Q&T	316 or 316Ti	-	-	0.3	0.05	Normally, no special precautions are required for the selection of steels for use under these conditions, nevertheless, highly susceptible steels can crack.
2448N-32V80 2580N-32V80	1xxBL-	4340 Q&T	316 or 316Ti	-	-	0.3	0.05	Normally, no special precautions are required for the selection of steels for use under these conditions, nevertheless, highly susceptible steels can crack.
		Super Duplex S32750 or S32760	316 or 316Ti	-	-	10 to 20	1.5* to 3	Any combination of chloride concentration and in situ pH occurring in production environments is acceptable. If chloride concentration is less than 50 mg/l, no restrictions on pH ₂ S and pH are set. * depending on chemical composition of individual material batch
	6xx5X-	4340 Q&T	316 or 316Ti	-	-	0.3	0.05	Normally, no special precautions are required for the selection of steels for use under these conditions, nevertheless, highly susceptible steels can crack.
		Nitronic 50 (S20910)	316 or 316Ti	66	150	100	15	Any combination of chloride concentration and in situ pH occurring in production environments is acceptable.
2648N-32V80	1xxCX-	4340 Q&T	316 or 316Ti	-	-	0.3	0.05	Normally, no special precautions are required for the selection of steels for use under these conditions, nevertheless, highly susceptible steels can crack.
		Inconel 718 (N07718)	316 or 316Ti	135	275	-	-	Any combination of hydrogen sulfide, chloride concentration, and in situ pH in production environments is acceptable.

*fittings out of this material has been manufactured till April 2021, they are still in field and some stock is available. Contact Parker for clarification if required.

PFDE-ES28, Rev. U: Handling, Maintenance, Inspection, Repair

Appendix 4: Recommendations for use of Parker Polyflex Black Eagle hoses with gas and sour gas.

4. 2 Use of Parker Polyflex hoses with sour gas. (cont.)

Hose Type	Fitting Series	Nipple Material	Shell Material	Maximum Temperature		Maximum Partial Pressure (pH ₂ S)		Remarks
				°C	°F	kPa	psi	
2240N-48V80 2440N-48V80 2640N-48V80	1XXTX- 1XXLX- 1XX5X-	4340 Q&T*	316 or 316Ti	-	-	0.3	0.05	Normally, no special precautions are required for the selection of steels for use under these conditions, nevertheless, highly susceptible steels can crack.
	1XXTX- 1XXLX- 1XX5X-	4140 Q&T, max. HRC22	316 or 316Ti	-	-	-	-	Normally, no special precautions are required.
2440N-48V80	1XXLX-	Inconel 625 (N06625)	316 or 316Ti	-	-	-	-	These materials have been used without restriction on temperature, pH ₂ S, chloride concentration, or in situ pH in production environments. No limits on individual parameters are set, but some combinations of the values of these parameters might not be acceptable.

*fittings out of this material has been manufactured till April 2021, they are still in field and some stock is available. Contact Parker for clarification if required.

1-1/2" - 15,000* psi Black Eagle Hose with ColorGard™

2640N-24V80-15K



Oilfield Service Hose

Construction

- Core Tube: Polyamide 11, methanol washed
- Pressure Reinforcement: Six layers of high tensile steel wire
- Cover: Extra thick dual layer polyurethane
- Standard Color: Black w/ ColorGard™ red inner sheath

Temperature

- Temperature Range: -40°F to 158°F (-40°C to 70°C)

Design Factor

- 2.25

Certifications

- DNV Type Approval P 14038 according to API 7K and API 17J with BL Fittings

Notes

- Polyflex ColorGard™ extra thick, dual color cover significantly reduces the risk of exposing the reinforcing wires. If the outer black cover has been abraded to the point that the “early warning” red inner cover can be seen, the hose needs to be changed out.

Black Eagle

[Visit the webpage](#)

Part Number	Nominal I.D.				Max. O.D.		Max. Working Pressure		Min. Bend Radius		Weight		Fitting Series
	DN	Size	inch	mm	inch	mm	psi	bar	inch	mm	lbs./ft.	kg/mtr	
2640N-24V80-15K	40	-24	1-1/2	38.1	2.6	66	15,000	1,035	19.7	500	4.37	6.5	5X

1GX5X - Straight Grayloc

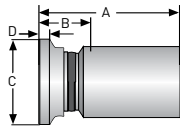

Part Number	Nominal I.D.				Hub Size	Overall Length A		Cutoff Allow. B		C		D	
	DN	Size	inch	mm		inch	mm	inch	mm	inch	mm	inch	mm
1GX5X-32-24C4462-KOP2	40	-24	1 1/2	38.1	B20	6.20	157	2.6	66	4.75	121	0.62	16

Stainless Steel

1HE5X - Hammer Union (Male) Cone w/ Wing Nut

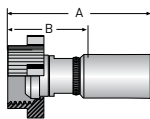

Part Number	Nominal I.D.				Thread Size	Overall Length A		Cutoff Allow. B	
	DN	Size	inch	mm		inch	mm	inch	mm
1HE5X-32-24C4462-KOP2	40	-24	1 1/2	38.1	4-1/8"-3 ACME	9.13	232	4.25	108

Nipple - Carbon Steel, Zinc-plated Shell - Stainless Steel Nut - Carbon Steel

1HN5X - Hammer Union (Female) Cone Threaded End w/ Seal

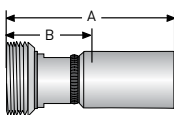

Part Number	Nominal I.D.				Thread Size	Overall Length A		Cutoff Allow. B	
	DN	Size	inch	mm		inch	mm	inch	mm
1HN5X-32-24C4462-KOP2	40	-24	1 1/2	38.1	4-1/8"- 3 ACME	9.65	245	4.25	108

Nipple - Steel Shell - Stainless Steel



WARNING

This product can expose you to chemicals including Lead, which is known to the State of California to cause cancer and birth defects or other reproductive harm. For more information go to www.P65Warnings.ca.gov.

2" - 5,000* psi Black Eagle Hose with ColorGard

2448N-32V80



Oilfield Service Hose

Construction

- Core Tube: Polyamide 11, methanol washed
- Pressure Reinforcement: Four spiral layers of high tensile steel wire
- Cover: Extra thick dual layer polyurethane
- Standard Color: Black w/ ColorGard™ red inner sheath

Temperature

- Temperature Range: -40°F to 158°F (-40°C to 70°C)

Certifications

- DNV GLType Approval TAD00000CA

Design Factor

- 4

Notes

- Polyflex ColorGard™ extra thick, dual color cover significantly reduces the risk of exposing the reinforcing wires. If the outer black cover has been abraded to the point that the “early warning” red inner cover can be seen, the hose needs to be changed out.

Black Eagle

[Visit the webpage](#)

Part Number	Nominal I.D.				Max. O.D.		Max. Working Pressure		Min. Bend Radius		Weight		Fitting Series
	DN	Size	inch	mm	inch	mm	psi	bar	inch	mm	lbs./ft.	kg/mtr	
2448N-32V80	50	-32	2	51	3.17	80.5	5,000	345	20	508	5.71	8.5	5X

6HB5X - API Clamping Hub

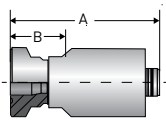

Part Number	Nominal I.D.				Thread Size	Overall Length A		Cutoff Allow. B		Seal
	DN	Size	inch	mm		inch	mm	inch	mm	
6HB5X-41-32-TC3964-5K	50	-32	2	51	2-9/16"	9.42	239	4.03	102	BX153

All components Stainless Steel

6HE5X - Hammer Union (Male) Cone w/ Wing Nut

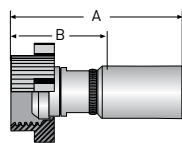

Part Number	Nominal I.D.				Thread Size	Overall Length A		Cutoff Allow. B	
	DN	Size	inch	mm		inch	mm	inch	mm
6HE5X-32-32-FLATTC	50	-32	2	51	4-1/8"-3 ACME	11.48	292	6.09	155

Nipple - Carbon Steel, Zinc-plated Shell - Stainless Steel Nut - Carbon Steel

6HN5X - Hammer Union (Female) Cone Threaded End w/ Seal

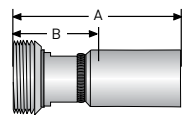

Part Number	Nominal I.D.				Thread Size	Overall Length A		Cutoff Allow. B	
	DN	Size	inch	mm		inch	mm	inch	mm
6HN5X-32-32-TC	50	-32	2	51	4-1/8"- 3 ACME	9.56	243	4.18	106

Nipple - Steel Shell - Stainless Steel

WARNING

This product can expose you to chemicals including Lead, which is known to the State of California to cause cancer and birth defects or other reproductive harm. For more information go to www.P65Warnings.ca.gov.

2" - 10,000* psi Black Eagle Hose with ColorGard™

2580N-32V80



Oilfield Service Hose

Construction

- Core Tube: Polyamide 11, methanol washed
- Pressure Reinforcement: Four spiral layers of high tensile steel wire
- Cover: Extra thick dual layer polyurethane
- Standard Color: Black w/ ColorGard™ red inner sheath

Temperature

- Temperature Range: -40°F to 158°F (-40°C to 70°C)

Certifications

- DNV GLType Approval TAD00000CA

Design Factor

- 2.5

Notes

- Polyflex ColorGard™ extra thick, dual color cover significantly reduces the risk of exposing the reinforcing wires. If the outer black cover has been abraded to the point that the “early warning” red inner cover can be seen, the hose needs to be changed out.

Black Eagle

[Visit the webpage](#)

Part Number	Nominal I.D.				Max. O.D.		Max. Working Pressure		Min. Bend Radius		Weight		Fitting Series
	DN	Size	inch	mm	inch	mm	psi	bar	inch	mm	lbs./ft.	kg/mtr	
2580N-32V80	50	-32	2	51	3.33	84.5	10,000	690	32	813	6.32	9.4	5X, BL

6GX5X - Straight Grayloc

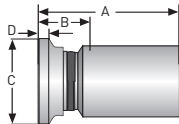

Part Number	Nominal I.D.				Hub Size	Overall Length A		Cutoff Allow. B		C		D	
	DN	Size	inch	mm		inch	mm	inch	mm	inch	mm	inch	mm
6GX5X-32-32-TC3964	50	-32	2	51	B20	7.86	200	2.48	63	4.75	121	0.63	16

Stainless Steel

1HEBL - Hammer Union (Male) Cone w/ Wing Nut

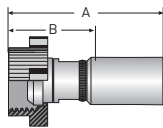

Part Number	Nominal I.D.				Thread Size	Overall Length A		Cutoff Allow. B	
	DN	Size	inch	mm		inch	mm	inch	mm
1HEBL-32-32-FLAT	50	-32	2	51	4-1/8"-3 ACME	10.90	278	5.21	132

Nipple - Carbon Steel, Zinc-plated Shell - Stainless Steel Nut - Carbon Steel

1HNBL - Hammer Union (Female) Cone Threaded End w/ Seal

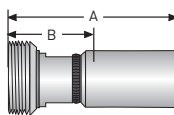

Part Number	Nominal I.D.				Thread Size	Overall Length A		Cutoff Allow. B	
	DN	Size	inch	mm		inch	mm	mm	mm
1HNBL-32-32	50	-32	2	51	4-1/8"- 3 ACME	10.4	263	4.61	117

Nipple - Steel Shell - Stainless Steel

⚠ WARNING

This product can expose you to chemicals including Lead, which is known to the State of California to cause cancer and birth defects or other reproductive harm. For more information go to www.P65Warnings.ca.gov.

2" - 15,000* psi Black Eagle Hose with ColorGard™

2648N-32V80



Oilfield Service Hose

Construction

- Core Tube: Polyamide 11, methanol washed
- Pressure Reinforcement: Slix spiral layers of high tensile steel wire
- Cover: Extra thick dual layer polyurethane
- Standard Color: Black w/ ColorGard™ red inner sheath

Temperature

- Temperature Range:
-40°F to 158°F (-40°C to 70°C)

Certifications

- DNV GLType Approval TAD00000CA

Design Factor

- 2.25

Notes

- Polyflex ColorGard™ extra thick, dual color cover significantly reduces the risk of exposing the reinforcing wires. If the outer black cover has been abraded to the point that the "early warning" red inner cover can be seen, the hose needs to be changed out.

Black Eagle

[Visit the webpage](#)

Part Number	Nominal I.D.				Max. O.D.		Max. Working Pressure		Min. Bend Radius		Weight		Fitting Series
	DN	Size	inch	mm	inch	mm	psi	bar	inch	mm	lbs./ft.	kg/mtr	
2648N-32V80	50	-32	2	51	3.39	86	15,000	1,035	31	787	8.13	12.1	CX

1GXCX - Straight Grayloc

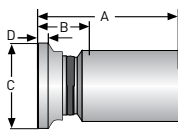

Part Number	Nominal I.D.				Hub Size	Overall Length A		Cutoff Allow. B		C		D	
	DN	Size	inch	mm		inch	mm	inch	mm	inch	mm	inch	mm
1GXCX-20-32C3964	50	-32	2	51	2½-3 GR20	10	255	3.50	89	5.00	127	0.50	12.7
1GXCX-20-32C4542										4.75	121	0.62	16
1GXCX-32-32C3964					B20	10	255	3.50	89	4.75	121	0.62	16
1GXCX-32-32C4542													
3964 - Nitronic 50		4542 - 17-4 Stainless Steel											

1HECX - Hammer Union (Male) Cone w/ Wing Nut

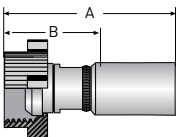

Part Number	Nominal I.D.				Thread Size	Overall Length A		Cutoff Allow. B	
	DN	Size	inch	mm		inch	mm	inch	mm
1HECX-32-32-FLAT	50	-32	2	51	4-1/8" - 3 ACME	11.74	298	5.21	132
Nipple - Steel		Shell - Stainless Steel							

1HNCX - Hammer Union (Female) Cone Threaded End w/ Seal

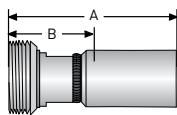

Part Number	Nominal I.D.				Thread Size	Overall Length A		Cutoff Allow. B	
	DN	Size	inch	mm		inch	mm	inch	mm
1HNCX-32-32	50	-32	2	51	4-1/8" - 3 ACME	11.20	284	4.65	118
Nipple - Steel		Shell - Stainless Steel							

WARNING

This product can expose you to chemicals including Lead, which is known to the State of California to cause cancer and birth defects or other reproductive harm. For more information go to www.P65Warnings.ca.gov.

3" - 5,000* psi Black Eagle Hose with ColorGard™

2240N-48V80



Oilfield Service Hose

Construction

- Core Tube: Polyamide 11, methanol washed
- Pressure Reinforcement: Two spiral layers of high tensile steel wire
- Cover: Extra thick dual layer polyurethane
- Standard Color: Black w/ ColorGard™ red inner sheath

Temperature

- Temperature Range: -40°F to 158°F (-40°C to 70°C)

Design Factor

- 2.5

Certifications

- DNV GLType Approval TAD00000CA

Notes

- Polyflex ColorGard™ extra thick, dual color cover significantly reduces the risk of exposing the reinforcing wires. If the outer black cover has been abraded to the point that the “early warning” red inner cover can be seen, the hose needs to be changed out.

Black Eagle

[Visit the webpage](#)

Part Number	Nominal I.D.				Max. O.D.		Max. Working Pressure		Min. Bend Radius		Weight		Fitting Series
	DN	Size	inch	mm	inch	mm	psi	bar	inch	mm	lbs./ft.	kg/mtr	
2240N-48V80	78	-48	3	76	4.49	114	5,000	345	39.9	1000	7.73	11.5	TX

1HNTX - Hammer Union (Female) Cone Threaded End w/ Seal

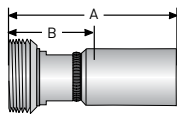

Part Number	Nominal I.D.				Thread Size	Overall Length A		Cutoff Allow. B	
	DN	Size	inch	mm		inch	mm	inch	mm
1HNTX-48-48	78	-48	3	76	5-3/8" 3-1/2 ACME	13.78	350	7.24	184

Nipple - Steel Shell - Stainless Steel

1HETX- Hammer Union (Male) Cone w/ Wing Nut

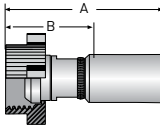

Part Number	Nominal I.D.				Thread Size	Overall Length A		Cutoff Allow. B	
	DN	Size	inch	mm		inch	mm	inch	mm
1HETX-48-48-FLAT	78	-48	3	76	5-3/8"-3 1/2 ACME	13.39	345	7.24	174

Nipple - Steel Shell - Stainless Steel Nut - Steel

Accessories Part Numbers

3" LC- Lifting Clamp and Chain

LC-48-15000

Technical details available in Section D.



WARNING

This product can expose you to chemicals including Lead, which is known to the State of California to cause cancer and birth defects or other reproductive harm. For more information go to www.P65Warnings.ca.gov.

3" - 10,000* psi Black Eagle Hose with ColorGard™

2440N-48V80



Oilfield Service Hose

Construction

- Core Tube: Polyamide 11, methanol washed
- Pressure Reinforcement: Four spiral layers of high tensile steel wire
- Cover: Extra thick dual layer polyurethane
- Standard Color: Black w/ ColorGard™ red inner sheath

Temperature

- Temperature Range: -40°F to 158°F (-40°C to 70°C)

Certifications

- DNV GLType Approval TAD00000CA

Design Factor

- 2.5

Notes

- Polyflex ColorGard™ extra thick, dual color cover significantly reduces the risk of exposing the reinforcing wires. If the outer black cover has been abraded to the point that the "early warning" red inner cover can be seen, the hose needs to be changed out.

Black Eagle

[Visit the webpage](#)

Part Number	Nominal I.D.				Max. O.D.		Max. Working Pressure		Min. Bend Radius		Weight		Fitting Series
	DN	Size	inch	mm	inch	mm	psi	bar	inch	mm	lbs./ft.	kg/mtr	
2440N-48V80	78	-48	3	76	4.8	122	10,000	690	43.3	1100	12.57	18.7	LX

1HNLX - Hammer Union (Female) Cone Threaded End w/ Seal

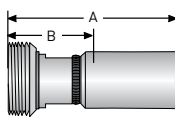

Part Number	Nominal I.D.				Thread Size	Overall Length A		Cutoff Allow. B	
	DN	Size	inch	mm		inch	mm	inch	mm
1HNLX-48-48	78	-48	3	76	5-3/8"-3-1/2 ACME	15.95	405	7.64	194

Nipple - Steel Shell - Stainless Steel

1HELX - Hammer Union (Male) Cone w/ Wing Nut

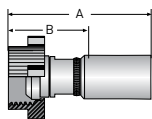

Part Number	Nominal I.D.				Thread Size	Overall Length A		Cutoff Allow. B	
	DN	Size	inch	mm		inch	mm	inch	mm
1HELX-48-48-FLAT	78	-48	3	76	5-3/8"-3 1/2 ACME	15.55	395	7.22	183

Nipple - Carbon Steel, Zinc-plated Shell - Stainless Steel Nut - Carbon Steel

Accessories Part Numbers

3" LC- Lifting Clamp and Chain

LC-48-15000

Technical details available in Section D.

WARNING

This product can expose you to chemicals including Lead, which is known to the State of California to cause cancer and birth defects or other reproductive harm. For more information go to www.P65Warnings.ca.gov.

3" - 15,000* psi Black Eagle Hose with ColorGard™

2640N-48V80



Oilfield Service Hose

Construction

- Core Tube: Polyamide 11, methanol washed
- Pressure Reinforcement: Six spiral layers of high tensile steel wire
- Cover: Extra thick dual layer polyurethane
- Standard Color: Black w/ ColorGard™ red inner sheath

Temperature

- Temperature Range: -40°F to 158°F (-40°C to 70°C)

Design Factor

- 2.25

Certifications

- DNV GL Type Approval TAD00000CA

Notes

- Polyflex ColorGard™ extra thick, dual color cover significantly reduces the risk of exposing the reinforcing wires. If the outer black cover has been abraded to the point that the “early warning” red inner cover can be seen, the hose needs to be changed out.

Black Eagle

[Visit the webpage](#)

Part Number	Nominal I.D.				Max. O.D.		Max. Working Pressure		Min. Bend Radius		Weight		Fitting Series
	DN	Size	inch	mm	inch	mm	psi	bar	inch	mm	lbs./ft.	kg/mtr	
2640N-48V80	78	-48	3	76	5.13	130	15,000	1,035	47.3	1200	18.48	27.5	5X

1HN5X - Hammer Union (Female) Cone Threaded End w/ Seal

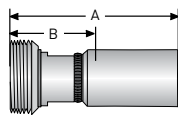

Part Number	Nominal I.D.				Thread Size	Overall Length A		Cutoff Allow. B	
	DN	Size	inch	mm		inch	mm	inch	mm
1HN5X-48-48	78	-48	3	76	5-3/8"-3-1/2 ACME	15.95	405	7.64	194

Nipple - Steel Shell - Stainless Steel

1HE5X - Hammer Union (Male) Cone w/ Wing Nut

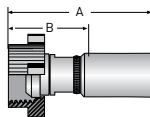

Part Number	Nominal I.D.				Thread Size	Overall Length A		Cutoff Allow. B	
	DN	Size	inch	mm		inch	mm	inch	mm
1HE5X-48-48-FLAT	78	-48	3	76	5-3/8"-3-1/2 ACME	15.55	395	7.22	183

Nipple - Carbon Steel, Zinc-plated Shell - Stainless Steel Nut - Carbon Steel

Accessories Part Numbers

3" LC- Lifting Clamp and Chain

LC-48-15000

Technical details available in Section D.



WARNING

This product can expose you to chemicals including Lead, which is known to the State of California to cause cancer and birth defects or other reproductive harm. For more information go to www.P65Warnings.ca.gov.

Oil & Gas Hose



Adapters



Adapters

Table Of Contents

Introduction

Nomenclature - Adapters	B-3
Nomenclature - Connection Accessory	B-3
Recommended Tightening Procedures	B-6

Series

Type M	B-7	Y501	B-30
YAYA	B-8	5Y02	B-31
YAY6	B-8	6Y02	B-32
YAY5	B-9	6Y01	B-33
YAD9	B-9	Y601	B-34
YAxC Plug	B-10	02Y6	B-34
AYxC Cap	B-10		
YAY1 Torpedo	B-10	K0203	B-35
YAY2 Torpedo	B-10	01D9	B-35
		02D9	B-35
		KL02	B-36
20,000 psi – Medium Pressures	B-11	KT02	B-36
5Y5	B-13	KX02	B-36
Y5Y5	B-12	K02 Cap	B-37
6Y5	B-14	KP01 Plug	B-37
5Y6	B-14		
Y5Y6	B-15	JIC	B-38
Y5Y9	B-15	K0303	B-39
5Y5Y	B-16	K0306	B-39
5Y6Y	B-17	K0606	B-39
Y2N Gland Nut	B-18	YA03	B-40
Y2C Collar	B-18	Y503	B-40
HBPLM Plug	B-18	Y603	B-40
5YxC Cap	B-18	10K06 Cap	B-41
Y204, Y206, Y209, Y212, Y216	B-18	10KP03 Plug	B-41
30,000/60,000 psi – High Pressure	B-19		
6Y6	B-20		
Y6Y6	B-20		
X6Y6	B-21		
6Y6Y	B-21		
Y6D9	B-22		
Y4N Gland Nut	B-22		
Y4C Collar	B-22		
6YxC Cap	B-23		
HBPHM Plug	B-22		
HBPHM Plug	B-22		
KCGLx Locking Nut	B-23		
Y404, Y406, Y409	B-23		
NPT	B-24		
K0101	B-25		
K0201	B-25		
K0202	B-26		
YA02	B-26		
YA01	B-27		
5Y01	B-28		
02Y5	B-29		

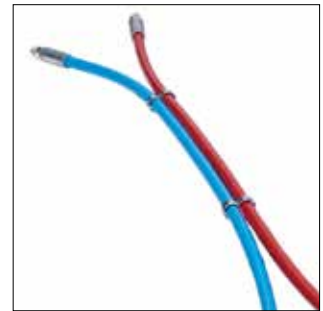
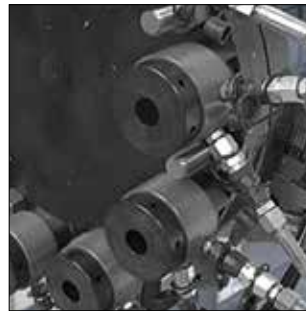

Adapter Nomenclature

Adapter Part Numbers

Most adapter part number structures will follow the below examples.

Accessory Type	
X	Code given for Crosses
L	Code given for Elbows
T	Code given for Tees

Connection Type	
02	Female NPT
5Y	Female Medium Pressure
6Y	Female High Pressure

Example: YA01-11-8C

YA01-11-8C - Connection Type #1 = Male Type M
 YA01-11-8C - Connection Type #2 = Male NPT
 YA01-11-8C - Connection Size #1= 1"-12 thread size for the Type M connection
 YA01-11-8C - Connection Size #2= 1/2"-14 thread size for the NPT connection
 YA01-11-8C - Material = 316 Stainless Steel

Example: 15K0101-4-4C

15K0101-4-4C - Pressure Rating = 15,000 PSI
 15K0101-4-4C - Connection Type #1 = Male NPT
 15K0101-4-4C - Connection Type #2 = Male NPT
 15K0101-4-4C - Connection Size #1= 1/4"-18
 15K0101-4-4C - Connection Size #2= 1/4"-18
 15K0101-4-4C - Material = 316 Stainless Steel

Connection Type Designations

YA	Male, Type M	Y6	Male, High Pressure	3	Male JIC
Y5	Male, Medium Pressure	6Y	Female, High Pressure	X6	Low Angle Face Seal
5Y	Female, Medium Pressure	Y4	Male, High Pressure, Tube Type	D9	Male BSP
Y2	Male, Medium Pressure, Torpedo Type	01	Male NPT Pipe		
		02	Female NPT Pipe		

The choice of connection type may limit the working pressure of the adapter (i.e., a High Pressure to Type M adapter will be limited to Type M pressures).

Connection Tube / Thread Size							
NPT Connections		JIC Connections		Type "M" Connections		BSP Connections	
-01	1/16"-27	-04	7/16"-20 UNF	-06	9/16"-18 UNF	-02	G 1/8"
-02	1/8"-27	-06	9/16"-18 UNF	-08	3/4"-16 UNF	-04	G 1/4"
-04	1/4"-18	-08	3/4"-16 UNF	-10	7/8"-14 UNF	-06	G 3/8"
-06	3/8"-18	-10	7/8"-14 UNF	-11	1"-12 UNF	-08	G 1/2"
-08	1/2"-14	-12	1-1/16"-12 UN	-13	1-1/8"-12 UNF		
-12	3/4"-16	-16	1-5/16"-12 UN	-16	1-5/16"-12 UN		
-16	1"-11-1/2						

Medium & High Pressure Port Sizes				
-04	-06	-09	-12	-16
1/4"	3/8	9/16	3/4	1
Medium Pressure				
7/16"-20 UNF	9/16"-18 UNF	13/16"-16 UN	3/4"-14 NPS	1-3/8"-12 UNF
High Pressure				
9/16"-18 UNF	3/4"-16 UNF	1-1/8"-12 UNF		

Adapter Nomenclature

Connection Accessory Part Numbers – Elbows & Tees

Connection accessories include crosses, elbows and tees. Part numbers for these accessories will always begin with a one-letter code (L or T) designating the accessory type, followed by a two-digit code representing the connection type. The connection size and material make up the end of the part number.

Accessory Type	
X	Code given for Crosses
L	Code given for Elbows
T	Code given for Tees

Example: L-6Y-9C

L-6Y-9C - Accessory Type
 L-6Y-9C - Connection Type = Female High Pressure Connection
 L-6Y-9C - Connection Size= 1-1/8"-12 UNF Thread Size
 L-6Y-9C - Material = 316 Stainless Steel

Connection Type	
02	Female NPT
5Y	Female Medium Pressure
6Y	Female High Pressure

NPT - Connection Tube / Thread Size						
-01	-02	-04	-06	-08	-12	-16
1/8	1/8	1/4	3/8	1/2	3/4	1
1/16"-27	1/8"-27	1/4"-18	3/8"-18	1/2"-14	3/4"-14	1"-11-1/2

Medium & High Pressure - Connection Tube / Thread Size				
-04	-06	-09	-12	-16
1/4	3/8	9/16	3/4	1
Medium Pressure				
7/16"-20 UNF	9/16"-18 UNF	13/16"-16 UN	3/4"-14 NPS	1-3/8"-12 UNF
High Pressure				
9/16"-18 UNF	3/4"-16 UNF	1-1/8"-12 UNF		

Adapter Nomenclature

Connection Accessory Part Numbers – Gland Nuts & Collars

Gland nuts and collars are simple in their make-up. Unlike crosses, elbows and tees, the gland nut and collar part numbers begin with the connection type followed by a one-letter code identifying the part as a gland nut or collar. The connection size and material codes make up the end of the part number.

Connection Type	
Y2	Medium Pressure Connection
Y4	High Pressure Connection

Accessory Type	
N	Gland Nuts
C	Collars

Example: Y4N-6C

Y4N-6C - Connection Type = High Pressure
 Y4N-6C - Accessory Type = Gland Nut
 Y4N-6C - Connection Size #1 = 3/8"
 Y4N-6C - Material = 316 Stainless Steel

Medium & High Pressure - Connection Tube / Thread Size				
-04	-06	-09	-12	-16
1/4	3/8	9/16	3/4	1
Medium Pressure				
7/16"-20 UNF	9/16"-18 UNF	13/16"-16 UN	3/4"-14 NPS	1-3/8"-12 UNF
High Pressure				
9/16"-18 UNF	3/4"-16 UNF	1-1/8"-12 UNF		

Connection Accessory Part Numbers – Threaded Tube Nipples

Connection Type	
Y2	Medium Pressure Connection
Y4	High Pressure Connection

Tube Size		
-04	-06	-09
1/4	3/8	9/16

Tube Length*				
0300	0400	0600	0800	1000
3"	4"	6"	8"	10"

*Length equal distance between tips of each cone

Example: Y406-0800C

Y406-0800C - Connection Type = High Pressure
 Y406-0800C - Connection Size #1 = 3/8"
 Y406-0800C - Tube Length = 8" long
 Y406-0800C - Material = 316 Stainless Steel

Adapter Nomenclature

Recommended Tightening Procedures

Connection	Thread Sizes	Tightening Torque	
		ft/lb.	N/Mtr
High Pressure			
1/4"	9/16" - 18	25	34
3/8"	3/4" - 16	50	69
9/16"	1-1/8" - 12	75	103
Medium Pressure			
1/4"	7/16" - 20	20	28
3/8"	9/16" - 18	30	41
9/16"	13/16" - 16	85	117
3/4"	3/4" NPSM	90	124
1"	1-3/8" - 12	125	173

Connection	Thread Sizes	Tightening Torque	
		ft/lb.	N/Mtr
Type "M" Swivel			
A9	9/16" - 18	25-30	34-41
A12	3/4" - 16	40-50	55-69
A14	7/8" - 14	50-60	69-83
A16	1" - 12	75-85	103-117
A21	1-5/16" - 12	100-120	138-166

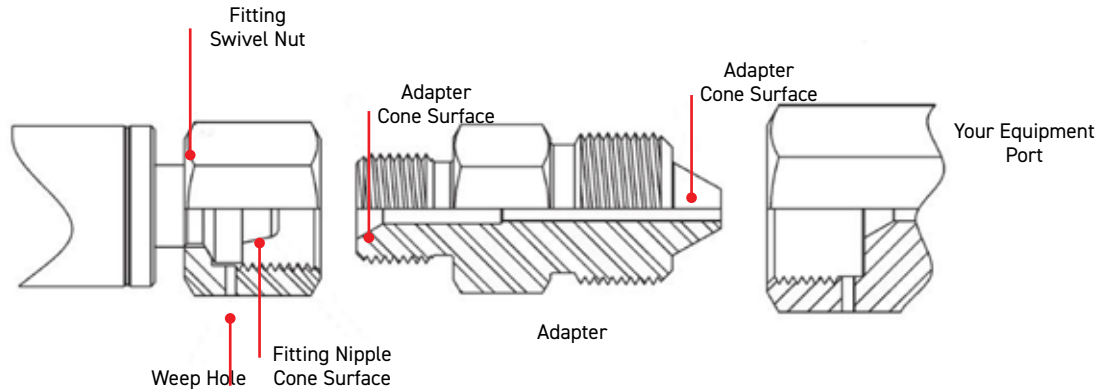

Leakage at Swivel Nut-to-Adapter Joint

(Seen by leak at weep hole in swivel nut)

- 1. Reduce system pressure to zero
- 2. Unscrew swivel nut and check cone surfaces of adapter and hose insert.
- 3. If hose insert is damaged, return hose to polyflex for repair and retest.
- 4. If cone surfaces look good after cleaning, re-tighten swivel nut. Do not exceed 150% of recommended torque.

Leakage at Type "M" Adapter-to-Port

(Seen by leak at weep hole in pressure port, or leak at threads for NPT adapters.)

- 1. Reduce system pressure to zero.
- 2. Slacken hose swivel nut.
- 3. Tighten adaptor into port.
- 4. Re-tighten swivel nut.
- 5. Adapter
- Never use the swivel nut to tighten the adapter into the port.

Adapters

Type "M"

The Type "M" adapters have a 60° female cone. Each Type "M" adapter is rated for the full working pressure of the hose.

Thread Sizes				
-06	-08	-10	-11	-16
9/16" - 18 UNF	3/4" - 16 UNF	7/8" - 14 UNF	1" - 12 UNF	1-5/16" - 12 UNF

Note: Determined by hose type



Construction

The Type "M" Swivel End Fitting is a swivel nut fitting with a 58° male cone nipple and/or a 60° female cone. Each type "M" adapter is rated for the full working pressure of the hose.

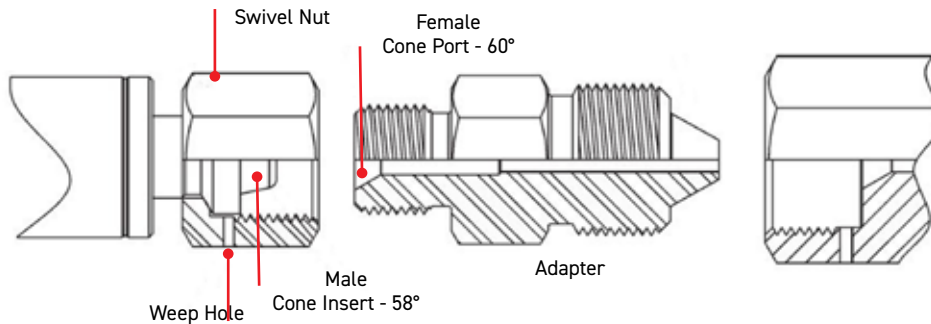

Features

- Rated for the full working pressure of hose
- Provides a swivel for quick and easy connection
- Internal threads and seal are protected from external damage
- Non rotating seal reduces galling and minimizes tightening torque
- Can be adapted to almost any connection required

Adapters

Type "M"

YAYA – Male Type "M" x Male Type "M"

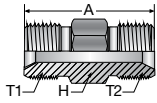

Part Number	T1 Thread Size	T2 Thread Size	Overall Length A		H Hex		Max. Working Pressure	
			inch	mm	inch	mm	psi	bar
YAYA-6-6C	9/16"-18 UNF	9/16"-18 UNF	1.38	35.05	0.630	16.00	60,000	4,140
YAYA-8-6C	3/4"-16 UNF	9/16"-18 UNF	1.63	41.40	0.750	19.05	30,000	2,070
YAYA-8-8C		3/4"-16 UNF	1.75	44.45				
YAYA-10-6C	7/8"-14 UNF	9/16"-18 UNF	1.88	47.75	1.000	25.40	60,000	4,140
YAYA-10-10C		7/8"-14 UNF	2.00	50.80			50,000	3,445
YAYA-11-8C	1"-12 UNF	3/4"-16 UNF	1.88	47.75	1.000	25.40	30,000	2,070
YAYA-11-10C		7/8" 14 UNF	1.98	50.29				
YAYA-11-11C		1"-12 UNF	1.88	47.75				
YAYA-16-11C	1-5/16"-12 UN	1"-12 UNF	2.13	54.10	1.380	35.05	20,000	1,380
YAYA-16-16C		1-5/16"-12 UN						

YAY6 – Male Type "M" x Male High Pressure

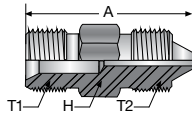

Part Number	T1 Thread Size	T2 Thread Size	Overall Length A		Tube Size	H Hex		Max. Working Pressure	
			inch	mm		inch	mm	psi	bar
YAY6-6-4C	9/16"-18 UNF	9/16"-18 UNF	1/4" HP	1.55	39.37	0.750	19.05	60,000	4,140
YAY6-6-6C		3/4"-16 UNF	3/8" HP	1.75	44.45				
YAY6-6-9C		1-1/8"-12 UNF	9/16" HP	2.00	50.80	1.130	28.70		
YAY6-8-6C	3/4"-16 UNF	3/4"-16 UNF	3/8" HP	2.00	50.80	0.750	19.05	30,000	2,070
YAY6-8-9C		1-1/8"-12 UNF	9/16" HP	2.25	57.15	1.130	28.70		
YAY6-10-6C	7/8"-14 UNF	3/4"-16 UNF	3/8" HP	2.25	57.15	1.000	25.40	60,000	4,140
YAY6-10-9C		1-1/8"-12 UNF	9/16" HP	2.38	60.45	1.130	28.70		
YAY6-11-9C	1"-12 UNF	1-1/8"-12 UNF	9/16" HP	2.25	57.15	1.130	28.70	30,000	2,070



WARNING

This product can expose you to chemicals including Lead, which is known to the State of California to cause cancer and birth defects or other reproductive harm. For more information go to www.P65Warnings.ca.gov.

Adapters

Type "M"

YAY5 – Male Type "M" x Male Medium Pressure

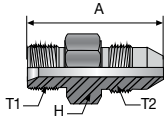

Part Number	T1 Thread Size	T2 Thread Size	Nominal Tube Length		Overall Length A		H Hex		Max. Working Pressure	
			inch	mm	inch	mm	inch	mm	psi	bar
YAY5-6-4C	9/16"-18 UNF	7/16"-20 UNF	1/4" MP	1.56	39.62	0.630	16.00	20,000	1,380	
YAY5-6-6C		9/16"-18 UNF	3/8" MP	1.63	41.40					
YAY5-6-9C		13/16"-16 UN	9/16" MP	2.00	50.80	0.880	22.35			
YAY5-6-12C		3/4"-14 NPS	3/4" MP	2.32	58.93					
YAY5-8-4C	3/4"-16 UNF	7/16"-20 UNF	1/4" MP	1.68	42.67	0.750	19.05			
YAY5-8-6C		9/16"-18 UNF	3/8" MP	1.88	47.75					
YAY5-8-9C		13/16"-16 UN	9/16" MP	2.20	55.88	0.880	22.35			
YAY5-8-12C		3/4"-14 NPS	3/4" MP	2.44	61.98					1.130
YAY5-11-4C	1"-12 UNF	7/16"-20 UNF	1/4" MP	1.94	49.28	1.000	25.40			
YAY5-11-6C		9/16"-18 UNF	3/8" MP	2.00	50.80					
YAY5-11-9C		13/16"-16 UN	9/16" MP	2.25	57.15	1.130	28.70			
YAY5-11-12C		3/4"-14 NPS	3/4" MP	2.44	61.98					
YAY5-16-9C	1-5/16"-12 UN	13/16"-16 UN	9/16" MP	2.50	63.50	1.380	35.05			
YAY5-16-12C		3/4"-14 NPS	3/4" MP	2.70	68.58					

YAD9 – Male Type "M" x Male BSP

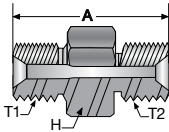

Part Number	T1 Thread Size	T2 Thread Size	Overall Length A		H Hex		Max. Working Pressure	
			inch	mm	inch	mm	psi	bar
YAD9-6-4C	9/16"-18 UNF	G 1/4"-19	1.36	34.54	0.750	19.05	30,000	2,070
YAD9-6-6C*		G 3/8"-19			0.875	22.23		
YAD9-6-8C*		G 1/2"-14	1.54	39.12	1.000	25.40		

*Non-standard part - may require longer lead time



WARNING

This product can expose you to chemicals including Lead, which is known to the State of California to cause cancer and birth defects or other reproductive harm. For more information go to www.P65Warnings.ca.gov.

Adapters

Type "M"

YA_C – Plugs

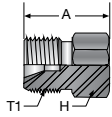

Part Number	T1 Thread Size	Overall Length A		H Hex		Max. Working Pressure	
		inch	mm	inch	mm	psi	bar
YA6C-PLUG	9/16"-18 UNF	2.07	52.58	0.75	19.05	60,000	4,140
YA8C-PLUG	3/4"-16 UNF	2.13	54.10	1.00	25.40	30,000	2,070
YA11C-PLUG	1"-12 UNF	1.25	31.75	1.00	25.40	30,000	2,070
YA16C-PLUG	1-5/16"-12 UN	2.63	66.80	1.38	35.05	20,000	1,380

AY_C – Caps

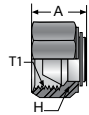

Part Number	T1 Thread Size	Overall Length A		Hex Size		Max. Working Pressure	
		inch	mm	inch	mm	psi	bar
AY6C-CAP	9/16"-18 UNF	0.85	21.59	0.690	17.53	60,000	4,140
AY8C-CAP	3/4"-16 UNF	0.91	23.11	1.000	25.40	30,000	2,070
AY11C-CAP	1"-12 UNF	1.31	33.27	1.250	31.75	30,000	2,070
AY16C-CAP	1-5/16"-12 UN	1.20	30.48	1.500	38.10	20,000	1,380

YAY_ – Torpedos

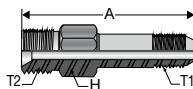

Part Number	T1 Thread Size	T2 Thread Size	Overall Length A		H Hex		Max. Working Pressure	
			inch	mm	inch	mm	psi	bar
YAY1-8-16C	3/4"-16 UNF	1"-14 LH	3.56	90.42	1.130	28.70	20,000	1,380
YAY2-8-16C					1.380	35.05		
YAY1-11-16C	1"-12 UNF	1"-14 LH	3.56	90.42	1.130	28.70		
YAY2-11-16C					1.380	35.05		
YAY1-16-16C	1-5/16"-12 UN	1"-14 LH	3.70	93.98	1.380	35.05		
YAY2-16-16C								



WARNING

This product can expose you to chemicals including Lead, which is known to the State of California to cause cancer and birth defects or other reproductive harm. For more information go to www.P65Warnings.ca.gov.

Adapters

Medium Pressure

Medium Pressure is a 58/60 degree coned and threaded tubing design. They have a maximum working pressure rating of 20,000 psi.



Thread Sizes				
-04	-06	-09	-12	-16
1/4" O.D. x 0.109" I.D.	3/8" O.D. x 0.190" I.D.	9/16" O.D. x 0.310" I.D.	3/4" O.D. x 0.440" I.D.	1" O.D. x 0.560" I.D.
7/16"-20 male thread on gland nut	9/16"-18 male thread on gland nut	13/16"-16 male thread on gland nut	3/4"-NPT Straight male on gland nut	1-3/8"-12 male thread on gland nut

Note: Identification is by tubing O.D.

Construction

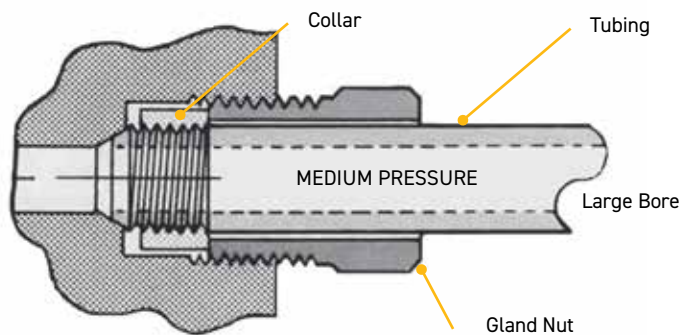

Features

- An industry standard for use at elevated pressures
- Large orifice allows maximum flow of liquids and gases
- Suitable for repetitive assembly and disassembly



WARNING

This product can expose you to chemicals including Lead, which is known to the State of California to cause cancer and birth defects or other reproductive harm. For more information go to www.P65Warnings.ca.gov.

Adapters

Medium Pressure

Y5Y5 – Male Medium Pressure x Male Medium Pressure

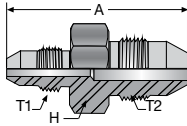

Part Number	T1 Thread Size	T2 Thread Size	Overall Length A		H Hex		Max. Working Pressure	
			inch	mm	inch	mm	psi	bar
Y5Y5-4-4C	7/16"-20 UNF	7/16"-20 UNF	2.00	50.80	0.620	15.75	20,000	1,380
Y5Y5-4-6C		9/16"-18 UNF	2.12	53.85	0.750	19.05		
Y5Y5-4-9C		13/16"-16 UN	2.18	55.37	0.875	22.23		
Y5Y5-4-12C		3/4"-14 NPS	2.50	63.50	1.120	28.45		
Y5Y5-4-16C		1-3/8"-12 UNF	3.62	91.95	1.000	25.40		
Y5Y5-6-6C	9/16"-18 UNF	9/16"-18 UNF	2.25	57.15	0.750	19.05		
Y5Y5-6-9C		13/16"-16 UN	2.50	63.50	0.875	22.10		
Y5Y5-6-12C		3/4"-14 NPS	2.62	66.55	1.120	28.45		
Y5Y5-6-16C		1-3/8"-12 UNF	3.75	95.25	1.000	25.40		
Y5Y5-9-9C	13/16"-16 UN	13/16"-16 UN	2.50	63.50	1.000	25.40		
Y5Y5-9-12C		3/4"-14 NPS	2.87	72.90	1.120	28.45		
Y5Y5-9-16C		1-3/8"-12 UNF	4.00	101.60	1.000	25.40		
Y5Y5-12-12C	3/4"-14 NPS	3/4"-14 NPS	3.00	76.20	1.120	28.45		
Y5Y5-12-16C		1-3/8"-12 UNF	1.25	31.75				
Y5Y5-16-16C	1-3/8"-12 UNF	1-3/8"-12 UNF	4.25	107.95	1.375	34.93		



WARNING

This product can expose you to chemicals including Lead, which is known to the State of California to cause cancer and birth defects or other reproductive harm. For more information go to www.P65Warnings.ca.gov.

Adapters

Medium Pressure

5YY5 – Female Medium Pressure x Male Medium Pressure

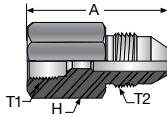

Part Number	T1 Thread Size	T2 Thread Size	Overall Length A		H Hex		Max. Working Pressure	
			inch	mm	inch	mm	psi	bar
5YY5-4-6C	7/16"-20 UNF	9/16"-18 UNF	1.75	44.45	0.750	19.05	20,000	1,380
5YY5-4-9C		13/16"-16 UN	1.87	47.50	0.870	22.10		
5YY5-4-12C		3/4"-14 NPS	2.00	50.80	1.120	28.45		
5YY5-4-16C		1-3/8"-12 UNF	3.00	76.20	1.000	25.40		
5YY5-6-4C	9/16"-18 UNF	7/16"-20 UNF	1.75	44.45	0.750	19.05		
5YY5-6-9C		13/16"-16 UN	1.87	47.50	0.870	22.10		
5YY5-6-12C		3/4"-14 NPS	2.00	50.80	1.120	28.45		
5YY5-6-16C*		1-3/8"-12 UNF	3.12	79.25	1.000	25.40		
5YY5-9-4C	13/16"-16 UN	7/16"-20 UNF	2.12	53.85	1.000	25.40		
5YY5-9-6C		9/16"-18 UNF						
5YY5-9-12C		3/4"-14 NPS	2.50	63.50	1.120	28.45		
5YY5-9-16C		1-3/8"-12 UNF	3.37	85.60	1.000	25.40		
5YY5-12-4C*	3/4"-14 NPS	7/16"-20 UNF	1.25	31.75	1.370	34.80		
5YY5-12-6C		9/16"-18 UNF						
5YY5-12-9C		13/16"-16 UN						
5YY5-12-16C		1-3/8"-12 UNF						
5YY5-16-4C	1-3/8"-12 UNF	7/16"-20 UNF	2.75	69.85	1.75	44.45		
5YY5-16-6C		9/16"-18 UNF						
5YY5-16-9C		13/16"-16 UN						
5YY5-16-12C		3/4"-14 NPS						

*Non-standard part - may require longer lead time

WARNING

This product can expose you to chemicals including Lead, which is known to the State of California to cause cancer and birth defects or other reproductive harm. For more information go to www.P65Warnings.ca.gov.

Adapters

Medium Pressure

6YY5 – Female High Pressure x Male Medium Pressure

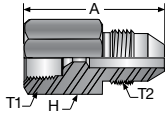

Part Number	T1 Thread Size	T2 Thread Size	Overall Length A		H Hex		Max. Working Pressure	
			inch	mm	inch	mm	psi	bar
6YY5-4-4C	9/16"-18 UNF	7/16"-20 UNF	1.75	44.45	0.750	19.05	20,000	1,380
6YY5-4-6C		9/16"-18 UNF						
6YY5-4-9C		13/16"-16 UN	1.87	47.50	0.870	22.10		
6YY5-4-12C*		3/4"-14 NPS	2.25	57.15	1.120	28.45		
6YY5-4-16C		1-3/8"-12 UNF	3.00	76.20	1.000	25.40		
6YY5-6-4C	3/4"-16 UNF	7/16"-20 UNF	1.87	47.50	1.000	25.40		
6YY5-6-6C		9/16"-18 UNF						
6YY5-6-9C*		13/16"-16 UN	2.00	50.80	1.120	28.45		
6YY5-6-12C		3/4"-14 NPS	2.25	57.15	1.120	28.45		
6YY5-6-16C		1-3/8"-12 UNF	3.25	82.55	1.000	25.40		
6YY5-9-4C	1-1/8"-12 UNF	7/16"-20 UNF	2.12	53.85	1.370	34.80		
6YY5-9-6C*		9/16"-18 UNF						
6YY5-9-9C		13/16"-16 UN	2.37	60.20				
6YY5-9-12C		3/4"-14 NPS	2.50	63.50				
6YY5-9-16C		1-3/8"-12 UNF	3.62	91.95				

*Non-standard part - may require longer lead time

5YY6 – Female Medium Pressure x Male High Pressure

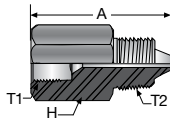

Part Number	T1 Thread Size	T2 Thread Size	Overall Length A		H Hex		Max. Working Pressure	
			inch	mm	inch	mm	psi	bar
5YY6-4-4C	7/16"-20 UNF	9/16"-18 UNF	1.37	34.80	0.750	19.05	20,000	1,380
5YY6-4-6C		3/4"-16 UNF	1.75	44.45				
5YY6-4-9C		1-1/8"-12 UNF	2.12	53.85	1.120	28.45		
5YY6-6-4C	9/16"-18 UNF	9/16"-18 UNF	1.75	44.45	0.750	19.05		
5YY6-6-6C		3/4"-16 UNF						
5YY6-6-9C		1-1/8"-12 UNF	2.12	53.85	1.120	28.45		
5YY6-9-4C	13/16"-16 UN	9/16"-18 UNF	1.87	47.50	1.000	25.40		
5YY6-9-6C		3/4"-16 UNF	2.12	53.85				
5YY6-9-9C		1-1/8"-12 UNF						
5YY6-12-4C	3/4"-14 NPS	9/16"-18 UNF	2.50	63.50	1.370	34.80		
5YY6-12-6C		3/4"-16 UNF	2.37	60.20				
5YY6-12-9C		1-1/8"-12 UNF	2.62	66.55				
5YY6-16-4C*	1-3/8"-12 UNF	9/16"-18 UNF	2.62	66.55	1.750	44.45		
5YY6-16-6C*		3/4"-16 UNF	2.87	72.90				
5YY6-16-9C		1-1/8"-12 UNF	3.12	79.25				

*Non-standard part - may require longer lead time



WARNING

This product can expose you to chemicals including Lead, which is known to the State of California to cause cancer and birth defects or other reproductive harm. For more information go to www.P65Warnings.ca.gov.

Adapters

Medium Pressure

Y5Y6 – Male Medium Pressure x Male High Pressure

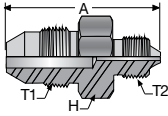

Part Number	T1 Thread Size	T2 Thread Size	Overall Length A		H Hex		Max. Working Pressure	
			inch	mm	inch	mm	psi	bar
Y5Y6-4-4C	7/16"-20 UNF	9/16"-18 UNF	1.73	43.94	0.630	16.00	20,000	1,380
Y5Y6-4-6C		3/4"-16 UNF	2.10	53.34	0.750	19.05		
Y5Y6-4-9C		1-1/8"-12 UNF	2.37	60.20	1.120	28.45		
Y5Y6-6-4C	9/16"-18 UNF	9/16"-18 UNF	2.12	53.85	0.620	15.75		
Y5Y6-6-9C		1-1/8"-12 UNF	2.50	63.50	1.120	28.45		
Y5Y6-9-4C	13/16"-16 UN	9/16"-18 UNF	2.25	57.15	0.870	22.10		
Y5Y6-9-6C		3/4"-16 UNF	2.38	60.45	0.875	22.23		
Y5Y6-9-9C		1-1/8"-12 UNF	2.62	66.55	1.120	28.45		
Y5Y6-12-4C	3/4"-14 NPS	9/16"-18 UNF	2.62	66.55	1.120	28.45		
Y5Y6-12-6C*		3/4"-16 UNF	2.75	69.85				
Y5Y6-12-9C		1-1/8"-12 UNF	3.00	76.20				
Y5Y6-16-4C*	1-1/8"-12 UNF	9/16"-18 UNF	3.62	91.95	1.000	25.40		
Y5Y6-16-6C*		3/4"-16 UNF	4.00	101.60	1.120	28.45		
Y5Y6-16-9C		1-1/8"-12 UNF						

*Non-standard part - may require longer lead time

Y5D9 – Male Medium Pressure x Male BSP

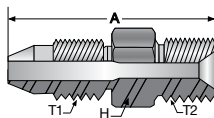

Part Number	T1 Thread Size	T2 Thread Size	Overall Length A		H Hex		Max. Working Pressure	
			inch	mm	inch	mm	psi	bar
Y5D9-4-4C	7/16"-20 UNF	G1/4-19	1.47	37.34	0.750	19.05	20,000	1,380
Y5D9-6-4C	9/16"-18 UNF	G1/4-19	1.69	42.93	0.750	19.05		
Y5D9-6-6C		G3/8-19	1.66	42.16	0.875	22.23		
Y5D9-9-6C	13/16"-16 UN	G3/8-19	1.88	47.75	0.875	22.23		

*Non-standard part - may require longer lead time

WARNING

This product can expose you to chemicals including Lead, which is known to the State of California to cause cancer and birth defects or other reproductive harm. For more information go to www.P65Warnings.ca.gov.

Adapters

Medium Pressure

5Y5Y – Female / Female Medium Pressure, Straight Coupling

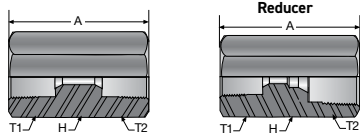

Part Number	T1 Thread Size	T2 Thread Size	Overall Length A		H Hex		Max. Working Pressure	
			inch	mm	inch	mm	psi	bar
5Y5Y-4-4C	7/16"-20 UNF	7/16"-20 UNF	1.62	41.15	0.750	19.05	20,000	1,380
5Y5Y-6-6C	9/16"-18 UNF	9/16"-18 UNF	1.75	44.45	0.750	19.05		
5Y5Y-9-9C	13/16"-16 UN	13/16"-16 UN	2.12	53.85	1.000	25.40		
5Y5Y-12-12C	3/4"-14 NPS	3/4"-14 NPS	2.50	63.50	1.370	34.80		
5Y5Y-16-16C	1-3/8"-12 UNF	1-3/8"-12 UNF	3.50	88.90	1.750	44.45		

Reducer Coupling

Part Number	T1 Thread Size	T2 Thread Size	Overall Length A		H Hex		Max. Working Pressure	
			inch	mm	inch	mm	psi	bar
5Y5Y-4-6C	7/16"-20 UNF	9/16"-18 UNF	1.75	44.45	0.750	19.05	20,000	1,380
5Y5Y-4-9C		13/16"-16 UN	2.12	53.85	1.000	25.40		
5Y5Y-4-12C*		3/4"-14 NPS	2.50	63.50	1.370	34.80		
5Y5Y-4-16C		1-3/8"-12 UNF	3.50	88.90	1.750	44.45		
5Y5Y-6-9C	9/16"-18 UNF	13/16"-16 UN	2.12	53.85	1.000	25.40		
5Y5Y-6-12C		3/4"-14 NPS	2.50	63.50	1.370	34.80		
5Y5Y-6-16C		1-3/8"-12 UNF	3.50	88.90	1.750	44.45		
5Y5Y-9-12C	13/16"-16 UN	3/4"-14 NPS	2.50	63.50	1.370	34.80		
5Y5Y-9-16C		1-3/8"-12 UNF	3.50	88.90	1.750	44.45		
5Y5Y-12-16C	3/4"-14 NPS	1-3/8"-12 UNF	3.50	88.90	1.750	44.45		

*Non-standard part - may require longer lead time



WARNING

This product can expose you to chemicals including Lead, which is known to the State of California to cause cancer and birth defects or other reproductive harm. For more information go to www.P65Warnings.ca.gov.

Adapters

Medium Pressure

5Y6Y – Female Medium Pressure x Female High Pressure Coupling

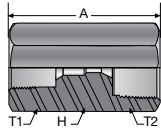

Part Number	T1 Thread Size	T2 Thread Size	Overall Length A		H Hex		Max. Working Pressure	
			inch	mm	inch	mm	psi	bar
5Y6Y-4-4C	7/16"-20 UNF	9/16"-18 UNF	1.62	41.15	0.750	19.05	20,000	1,380
5Y6Y-4-6C		3/4"-16 UNF	1.87	47.50	1.000	25.40		
5Y6Y-4-9C*		1-1/8"-12 UNF	2.37	60.20	1.370	34.80		
5Y6Y-6-4C	9/16"-18 UNF	9/16"-18 UNF	1.75	44.45	0.750	19.05		
5Y6Y-6-6C		3/4"-16 UNF	1.87	47.50	1.000	25.40		
5Y6Y-6-9C		1-1/8"-12 UNF	2.37	60.20	1.370	34.80		
5Y6Y-9-4C	13/16"-16 UN	9/16"-18 UNF	2.12	53.85	1.000	25.40		
5Y6Y-9-6C		3/4"-16 UNF	2.37	60.20				
5Y6Y-9-9C		1-1/8"-12 UNF	1.75	44.45	1.370	34.80		
5Y6Y-12-4C	3/4"-14 NPS	9/16"-18 UNF	2.50	63.50	1.370	34.80		
5Y6Y-12-6C*		3/4"-16 UNF						
5Y6Y-12-9C		1-1/8"-12 UNF						
5Y6Y-16-4C	1-3/8"-12 UNF	9/16"-18 UNF	3.50	88.90	1.370	34.80		
5Y6Y-16-6C*		3/4"-16 UNF						

*Non-standard part - may require longer lead time

Y2N – Medium Pressure Gland Nut

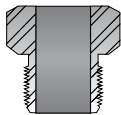

Part Number	Thread Size	Hex Size		Max. Working Pressure	
		inch	mm	psi	bar
Y2N-4C	7/16"-20 UNF	0.500	12.70	20,000	1,380
Y2N-6C	9/16"-18 UNF	0.625	15.88		
Y2N-9C	13/16"-16 UN	0.813	20.64		
Y2N-12C	3/4"-14 NPS	0.750	19.05		
Y2N-16C	1-3/8"-12 UNF	1.375	34.93		

*Non-standard part - may require longer lead time



WARNING

This product can expose you to chemicals including Lead, which is known to the State of California to cause cancer and birth defects or other reproductive harm. For more information go to www.P65Warnings.ca.gov.

Adapters

Medium Pressure

Y2C – Collar



Part Number	Thread Size	Max. Working Pressure	
		psi	bar
Y2C-4C	1/4"-28 UNF LH	20,000	1,380
Y2C-6C	3/8"-24 UNF LH		
Y2C-9C	9/16"-18 UNF LH		
Y2C-12C	3/4"-16 UNF LH		
Y2C-16C	1"-14 UNS LH		

HBPLM – Plug

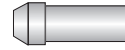

Part Number	Tube Size O.D.	Max. Working Pressure	
		psi	bar
HBPLM4-B	1/4"	20,000	1,380
HBPLM6-B	3/8"		
HBPLM9-B	9/16"		
HBPLM12-B	3/4"		
HBPLM16-B	1"		

NOTE: Gland nuts are required to fasten this plug in place.

5Y_C – Caps

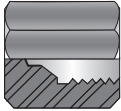

Part Number	T1 Thread Size	Overall Length A		Hex Size		Max. Working Pressure	
		inch	mm	inch	mm	psi	bar
5Y4C-CAP	7/16"-20 UNF	0.95	24.13	0.625	15.88	20,000	1,380
5Y6C-CAP	9/16"-18 UNF	1.38	35.05	0.875	22.23		
5Y9C-CAP	13/16"-16 UNF	1.50	38.10	1.250	31.75		
5Y12C-CAP	3/4"-14 NPSM	1.85	46.99	1.375	34.93		
5Y16C-CAP	1-3/8"-12 UNF	2.20	55.88	1.750	44.45		

Y204, Y206, Y209, Y212 and Y216 – Medium Pressure Nipple



Length	1/4" O.D.	3/8" O.D.	9/16" O.D.	3/4" O.D.	1" O.D.
2.75"	Y204-0275C				
3"	Y204-0300C	Y206-0300C			
4"	Y204-0400C	Y206-0400C	Y209-0400C	Y212-0400C	
6"	Y204-0600C		Y209-0600C	Y212-0600C	Y216-0600C
8"	Y204-0800C	Y206-0800C		Y212-0800C	Y216-0800C*
10"	Y204-1000C*	Y206-1000C	Y209-1000C*	Y212-1000C*	Y216-1000C*
12"	Y204-1200C		Y209-1200C*	Y212-1200C	Y216-1200C*

*Non-standard part - may require longer lead time

WARNING

This product can expose you to chemicals including Lead, which is known to the State of California to cause cancer and birth defects or other reproductive harm. For more information go to www.P65Warnings.ca.gov.

Adapters

High Pressure

High Pressure is a 58/60 degree coned and threaded tubing design. With small bore sizes, they have a maximum working pressure rating of 60,000 psi.



Thread Sizes		
-04	-06	-09
1/4" O.D. x 0.080" I.D.	3/8" O.D. x 0.120" I.D.	9/16" O.D. x 0.180" I.D.
9/16" -18 male thread on gland nut	3/4" -16 male thread on gland nut	1-1/8" -12 male thread on gland nut

Note: Identification is by tubing O.D.

Construction

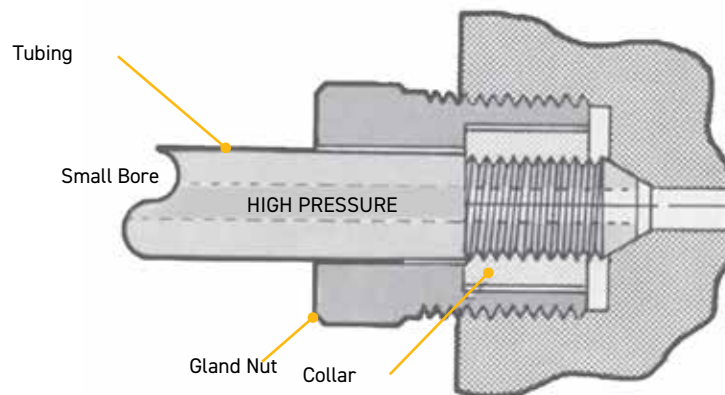

Features

- An industry standard for use at elevated pressures
- Suitable for repetitive assembly and disassembly



WARNING

This product can expose you to chemicals including Lead, which is known to the State of California to cause cancer and birth defects or other reproductive harm. For more information go to www.P65Warnings.ca.gov.

Adapters

High Pressure

6YY6 – Female High Pressure x Male High Pressure

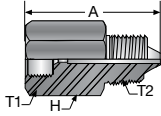

Part Number	T1 Thread Size	T2 Thread Size	Overall Length A		H Hex		Max. Working Pressure	
			inch	mm	inch	mm	psi	bar
6YY6-4-6C	9/16"-18 UNF	3/4"-16 UNF	1.75	44.45	0.750	19.05	60,000	4,140
6YY6-4-9C		1-1/8"-12 UNF	2.12	53.85	1.120	28.45		
6YY6-6-4C	3/4"-16 UNF	9/16"-18 UNF	1.50	38.10	1.000	25.40		
6YY6-6-9C		1-1/8"-12 UNF	2.12	53.85	1.120	28.45		
6YY6-9-4C	1-1/8"-12 UNF	9/16"-18 UNF	1.75	44.45	1.370	34.80		
6YY6-9-6C		3/4"-16 UNF	1.87	47.50				
6YY6-9-9C		1-1/8"-12 UNF	2.26	57.40	1.375	34.93		

Y6Y6 – Male High Pressure x Male High Pressure

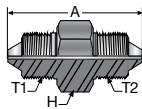

Part Number	T1 Thread Size	T2 Thread Size	Overall Length A		H Hex		Max. Working Pressure	
			inch	mm	inch	mm	psi	bar
Y6Y6-4-4C	9/16"-18 UNF	9/16"-18 UNF	1.68	42.67	0.620	15.75	60,000	4,140
Y6Y6-4-6C		3/4"-16 UNF	2.06	52.32	0.750	19.05		
Y6Y6-4-9C		1-1/8"-12 UNF	2.25	57.15	1.120	28.45		
Y6Y6-6-6C	3/4"-16 UNF	3/4"-16 UNF	2.25	57.15	0.750	19.05		
Y6Y6-6-9C		1-1/8"-12 UNF	2.50	63.50	1.120	28.45		
Y6Y6-9-9C	1-1/8"-12 UNF	1-1/8"-12 UNF	2.62	66.55	1.120	28.45		



WARNING

This product can expose you to chemicals including Lead, which is known to the State of California to cause cancer and birth defects or other reproductive harm. For more information go to www.P65Warnings.ca.gov.

Adapters

High Pressure

X6Y6 – Low Angle Face Seal x Male High Pressure

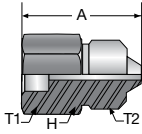

Part Number	T1 Thread Size	T2 Thread Size	Overall Length A		H Hex		Max. Working Pressure	
			inch	mm	inch	mm	psi	bar
X6Y6-6-9C*	9/16"-18 UNF	1-1/8"-12 UNF	2.00	50.80	1.125	28.58	60,000	4,140

*Non-standard part - may require longer lead time

6Y6Y – Female / Female High Pressure, Straight Coupling

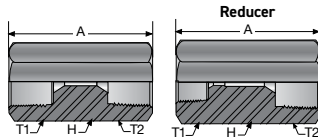

Part Number	T1 Thread Size	T2 Thread Size	Overall Length A		H Hex		Max. Working Pressure	
			inch	mm	inch	mm	psi	bar
6Y6Y-4-4C	9/16"-18 UNF	9/16"-18 UNF	1.75	44.45	1.000	25.40	60,000	4,140
6Y6Y-6-6C	3/4"-16 UNF	3/4"-16 UNF	2.00	50.80	1.000	25.40		
6Y6Y-9-9C	1-1/8"-12 UNF	1-1/8"-12 UNF	2.37	60.20	1.370	34.80		

Reducer Coupling

Part Number	T1 Thread Size	T2 Thread Size	Overall Length A		H Hex		Max. Working Pressure	
			inch	mm	inch	mm	psi	bar
6Y6Y-4-6C	9/16"-18 UNF	3/4"-16 UNF	1.62	41.15	1.000	25.40	60,000	4,140
6Y6Y-4-9C		1-1/8"-12 UNF	1.75	44.45	1.370	34.80		
6Y6Y-6-9C	3/4"-16 UNF	1-1/8"-12 UNF	2.00	50.80	1.370	34.80		

*Non-standard part - may require longer lead time

WARNING

This product can expose you to chemicals including Lead, which is known to the State of California to cause cancer and birth defects or other reproductive harm. For more information go to www.P65Warnings.ca.gov.

Adapters

High Pressure

Y6D9 – Male High Pressure x Male BSP

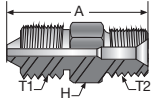

Part Number	T1 Thread Size	T2 Thread Size	Overall Length A		H Hex		Max. Working Pressure	
			inch	mm	inch	mm	psi	bar
Y6D9-4-6C	9/16"-18 UNF	G3/8-19	1.57	39.88	0.875	22.23	30,000*	2,070*
Y6D9-6-6C	3/4"-16 UNF		1.85	46.99				

*BSP connection end lowers working pressure to 30,000 psi

Y4N – High Pressure Gland Nut

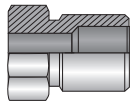

Part Number	Thread Size	Hex Size		Max. Working Pressure	
		inch	mm	psi	bar
Y4N-4C	9/16"-18 UNF	0.625	15.89	60,000	4,140
Y4N-6C	3/4"-16 UNF	0.813	20.64		
Y4N-9C	1-18"-12 UNF	1.188	30.16		

Y4C – Collar

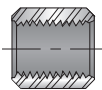

Part Number	Thread Size	Max. Working Pressure	
		psi	bar
Y4C-4C	1/4"-28 UNF LH	60,000	4,140
Y4C-6C	3/8"-24 UNF LH		
Y4C-9C	9/16"-18 UNF LH		

HBPHM – Plug



Part Number	Tube Size O.D.	Max. Working Pressure	
		psi	bar
HBPHM4-B	1/4"	60,000	4,140
HBPHM6-B	3/8"		
HBPHM9-B	9/16"		

NOTE: Gland nuts are required to fasten this plug in place.

WARNING

This product can expose you to chemicals including Lead, which is known to the State of California to cause cancer and birth defects or other reproductive harm. For more information go to www.P65Warnings.ca.gov.

Adapters

High Pressure

6Y_C – Caps

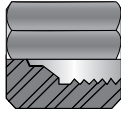

Part Number	T1 Thread Size	Overall Length A		Hex Size		Max. Working Pressure	
		inch	mm	inch	mm	psi	bar
6Y4C-CAP	1/4" HP	1.07	27.18	0.875	22.23	60,000	4,140
6Y6C-CAP	3/8" HP	1.26	32.00	1.000	25.40		
6Y9C-CAP	9/16" HP	1.50	38.10	1.375	34.93		

KCGL – Locking Nut/Collar Anti-Vibration

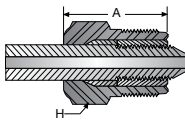

Part Number	Tube Size O.D.	Thread Size	Overall Length A		H Hex	
			inch	mm	inch	mm
KCGL40-316-ACL40*	1/4" HP	9/16"-18 UNF	0.68	17.27	0.630	16.00
KCGL60-316-ACL60	3/8" HP	3/4"-16 UNF	1.06	26.92	0.680	17.27
KCGL90-316-ACL90	9/16" HP	1-1/8"-12 UNF	1.56	39.62	1.680	42.67

*Non-standard part - may require longer lead time

Y404, Y406, Y409 – High Pressure Nipple



Length	1/4" O.D.	3/8" O.D.	9/16" O.D.
3"	Y404-0300C	Y406-0300C	
4"	Y404-0400C	Y406-0400C	Y409-0400C
6"		Y406-0600C	
8"	Y404-0800C	Y406-0800C	
10"	Y404-1000C*	Y406-1000C	Y409-1000C*
12"	Y404-1200C	Y406-1200C	Y409-1200C*

*Non-standard part - may require longer lead time



WARNING

This product can expose you to chemicals including Lead, which is known to the State of California to cause cancer and birth defects or other reproductive harm. For more information go to www.P65Warnings.ca.gov.

Adapters

NPT

polyflex offers a broad range of high quality stainless steel high pressure NPT adapters. Sizes ranging from 1/16" to 1/2" are rated up to 15,000 psi; 3/4" and above are rated to 10,000 psi.



Thread Sizes

-01	-02	-04	-06	-08	-12	-16
1/16" -27	1/8" -27	1/4" -18	3/8" -18	1/2" -14	3/4" -16 UNF	1" -11-1/2

Features

- Used world-wide in OEM and MRO applications
- Compact size make NPT a suitable selection for plumbing in limited or tight space in a compact system



WARNING

This product can expose you to chemicals including Lead, which is known to the State of California to cause cancer and birth defects or other reproductive harm. For more information go to www.P65Warnings.ca.gov.

Adapters

NPT

K0101 – Male NPT x Male NPT

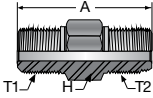

Part Number	T1 Thread Size	T2 Thread Size	Overall Length A		H Hex		Max. Working Pressure			
			inch	mm	inch	mm	psi	bar		
10K0101-12-12C	3/4"-14 NPT	3/4"-14 NPT	2.44	61.98	1.130	28.70	10,000	690		
10K0101-16-16C	1"-11-1/2 NPT	1"-11-1/2 NPT	2.75	69.85	1.380	35.05				
15K0101-1-1C	1/16"-27 NPT	1/16"-27 NPT	1.00	25.40	0.380	9.65	15,000	1,030		
15K0101-2-2C	1/8"-27 NPT	1/8"-27 NPT	1.20	30.48	0.500	12.70				
15K0101-4-4C	1/4"-18 NPT	1/4"-18 NPT	1.44	36.58	0.630	16.00				
15K0101-6-6C	3/8"-18 NPT	3/8"-18 NPT	1.70	43.18	0.750	19.05				
15K0101-8-8C	1/2"-14 NPT	1/2"-14 NPT	2.25	57.15	1.000	25.40				
15K0101-2-1C	1/8"-27 NPT	1/16"-27 NPT	1.13	28.70	0.500	12.70				
15K0101-2-4C		1/4"-18 NPT	1.35	34.29	0.625	15.88				
15K0101-6-8C	3/8"-18 NPT	1/2"-14 NPT	1.85	46.99	1.000	25.40				
10K0101-12-6C	3/4"-14 NPT	3/8"-18 NPT	1.95	49.53	1.125	28.58			10,000	690
10K0101-16-6C	1"-11-1/2 NPT	3/8"-18 NPT	2.16	54.86	1.375	34.93				
10K0101-12-4C	3/4"-14 NPT	1/4"-18 NPT	2.03	51.56	1.125	28.58				
10K0101-16-4C	1"-11-1/2 NPT	1/4"-18 NPT	2.16	54.86	1.375	34.93				
10K0101-16-12C		3/4"-14 NPT	2.56	65.02						

K0201 – Female NPT x Male NPT

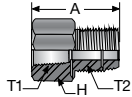

Part Number	T1 Thread Size	T2 Thread Size	Overall Length A		H Hex		Max. Working Pressure	
			inch	mm	inch	mm	psi	bar
15K0201-1-8C	1/16"-27 NPT	1/2"-14 NPT	1.25	31.75	0.870	22.10	15,000	1,030
15K0201-2-8C	1/8"-27 NPT							
15K0201-4-8C	1/4"-18 NPT							
15K0201-6-8C	3/8"-18 NPT	1/2"-14 NPT	1.63	41.40	1.000	25.40		
15K0201-1-4C	1/16"-27 NPT	1/4"-18 NPT	1.30	33.02	0.625	15.88		
15K0201-2-1C	1/8"-27 NPT	1/16"-27 NPT	1.38	35.05	0.750	19.05		
15K0201-4-1C	1/4"-18 NPT	1/16"-27 NPT	1.56	39.62	0.875	22.23		
15K0201-4-6C		3/8"-18 NPT	1.50	38.10	0.870	22.10		
15K0201-6-2C	3/8"-18 NPT	1/8"-27 NPT	1.58	40.13	1.000	25.40		
15K0201-6-6C		3/8"-18 NPT	1.50	38.10	0.875	22.23		
15K0201-8-8C	1/2"-14 NP	1/2"-14 NPT	2.13	54.10	1.250	31.75		
10K0201-4-12C	1/4"-18 NPT	3/4"-14 NPT	1.63	41.40	1.125	28.58	10,000	690
10K0201-6-12C	3/8"-18 NPT	3/4"-14 NPT	1.60	40.64	1.125	28.58		
10K0201-6-16C		1"-11-1/2 NPT	1.90	48.26	1.375	34.93		
10K0201-12-6C		3/8"-18 NPT	2.25	57.15	1.500	38.10		
10K0201-12-12C	3/4"-14 NPT							
10K0201-12-16C	1"-11-1/2 NPT							
10K0201-16-6C	1"-11-1/2 NPT	3/8"-18 NPT	2.35	59.69	2.000	50.80		
10K0201-16-8C		1/2"-14 NPT	2.50	63.50	2.000	50.80		



WARNING

This product can expose you to chemicals including Lead, which is known to the State of California to cause cancer and birth defects or other reproductive harm. For more information go to www.P65Warnings.ca.gov.

Adapters

NPT

K0202 – Female NPT x Female NPT

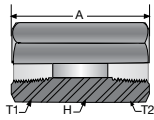

Part Number	T1 Thread Size	T2 Thread Size	Overall Length A		H Hex		Max. Working Pressure	
			inch	mm	inch	mm	psi	bar
15K0202-2-2C	1/8"-27 NPT	1/8"-27 NPT	1.50	38.10	0.750	19.05	15,000	1,030
15K0202-4-1C	1/4"-18 NPT	1/16"-27 NPT	1.63	41.40	0.875	22.23		
15K0202-4-4C		1/4"-18 NPT	1.75	44.45	0.870	22.10		
15K0202-6-2C	3/8"-18 NPT	1/8"-27 NPT	1.75	44.45	1.000	25.40		
15K0202-6-6C		3/8"-18 NPT						
15K0202-8-1C	1/2"-14 NPT	1/16"-27 NPT	1.75	44.45	1.250	31.75		
15K0202-8-2C		1/8"-27 NPT						
15K0202-8-6C		3/8"-18 NPT						
15K0202-8-8C		1/2"-14 NPT						
10K0202-12-4C	3/4"-14 NPT	1/4"-18 NPT	2.00	50.80	1.500	38.10		
10K0202-12-6C		3/8"-18 NPT						
10K0202-12-12C		3/4"-14 NPT	2.13	54.10				
10K0202-12-16C		1"-11-1/2 NPT	2.38	60.45			2.000	50.80
10K0202-16-16C	1"-11-1/2 NPT	1"-11-1/2 NPT	2.50	63.50	2.000	50.80		

YA02 – Male Type "M" x Female NPT

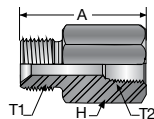

Part Number	T1 Thread Size	T2 Thread Size	Overall Length A		H Hex		Max. Working Pressure			
			inch	mm	inch	mm	psi	bar		
YA02-6-4C	9/16"-18 UNF	1/4"-18 NPT	1.50	38.10	0.750	19.05	15,000	1,030		
YA02-6-8C		1/2"-14 NPT	2.00	50.80	1.250	31.75				
YA02-6-16C		1"-11-1/2 NPT	2.38	60.45	2.000	50.80			10,000	690
YA02-8-4C	3/4"-16 UNF	1/4"-18 NPT	1.63	41.40	0.875	22.23	15,000	1,030		
YA02-8-6C		3/8"-18 NPT	1.75	44.45	1.000	25.40				
YA02-8-8C		1/2"-14 NPT	2.00	50.80	1.250	31.75				
YA02-8-12C		3/4"-14 NPT	2.13	54.10	1.500	38.10			10,000	690
YA02-11-8C		1"-12 UNF	1/2"-14 NPT	2.50	63.50	1.000			25.40	15,000
YA02-11-12C	3/4"-14 NPT		2.13	54.10	1.500	38.10	10,000	690		
YA02-16-16C	1-5/16"-12 UN		1"-11-1/2 NPT	2.38	60.45	2.000	50.80	10,000	690	

**WARNING**

This product can expose you to chemicals including Lead, which is known to the State of California to cause cancer and birth defects or other reproductive harm. For more information go to www.P65Warnings.ca.gov.

Adapters

NPT

YA01 – Male Type “M” x Male NPT

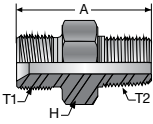

Part Number	T1 Thread Size	T2 Thread Size	Overall Length A		H Hex		Max. Working Pressure	
			inch	mm	inch	mm	psi	bar
YA01-6-2C	9/16" - 18 UNF	1/8" - 27 NPT	1.28	32.51	0.630	16.00	15,000	1,030
YA01-6-4C		1/4" - 18 NPT	1.38	35.05	0.630	16.00		
YA01-6-6C		3/8" - 18 NPT	1.57	39.88	0.750	19.05		
YA01-6-8C		1/2" - 14 NPT	1.75	44.45	0.880	22.35	10,000	690
YA01-6-12C		3/4" - 14 NPT	1.95	49.53	1.130	28.58		
YA01-6-16C		1" - 11-1/2 NPT	2.26	57.40	1.380	34.93		
YA01-8-4C	3/4" - 16 UNF	1/4" - 18 NPT	1.80	45.72	0.750	19.05	15,000	1,030
YA01-8-6C		3/8" - 18 NPT	1.73	43.94				
YA01-8-8C		1/2" - 14 NPT	1.95	49.53	0.880	22.35	10,000	690
YA01-8-12C		3/4" - 14 NPT	2.13	54.10	1.130	28.70		
YA01-8-16C		1" - 11-1/2 NPT	2.38	60.45	1.380	35.05		
YA01-11-6C	1" - 12 UNF	3/8" - 18 NPT	1.85	46.99	1.000	25.40	15,000	1,030
YA01-11-8C		1/2" - 14 NPT	2.00	50.80				
YA01-11-12C		3/4" - 14 NPT	2.13	54.10	1.130	28.70	10,000	690
YA01-11-16C		1" - 11-1/2 NPT	2.38	60.45	1.380	35.05		
YA01-16-8C	1-5/16" - 12 UN	1/2" - 14 NPT	2.13	54.10	1.380	35.05	15,000	1,030
YA01-16-12C		3/4" - 14 NPT	2.38	60.45				
YA01-16-16C		1" - 11-1/2 NPT	2.50	63.50			10,000	690
YA01-16-20C		1-1/4" - 11-1/2 NPT	2.75	69.85	1.750	44.45	7,500	520
YA01-16-24C		1-1/2" - 11-1/2 NPT			2.000	50.80		



WARNING

This product can expose you to chemicals including Lead, which is known to the State of California to cause cancer and birth defects or other reproductive harm. For more information go to www.P65Warnings.ca.gov.

Adapters

NPT

5Y01 – Female Medium Pressure x Male NPT

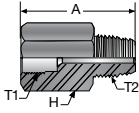

Part Number	T1 Thread Size	T2 Thread Size	Overall Length A		H Hex		Max. Working Pressure	
			inch	mm	inch	mm	psi	bar
5Y01-4-2C	7/16"-20 UNF	1/8"-27 NPT	1.43	36.32	0.750	19.05	15,000	1,030
5Y01-4-4C		1/4"-18 NPT	1.62	41.15				
5Y01-4-6C		3/8"-18 NPT	1.75	44.45				
5Y01-4-8C		1/2"-14 NPT	1.87	47.50	1.000	25.40	10,000	690
5Y01-4-12C		3/4"-14 NPT	1.87	47.50	1.370	34.80		
5Y01-4-16C*		1"-11-1/2 NPT	1.87	47.50	1.370	34.80		
5Y01-6-2C*	9/16"-18 UNF	1/8"-27 NPT	1.43	36.32	0.750	19.05	15,000	1,030
5Y01-6-4C		1/4"-18 NPT	1.62	41.15				
5Y01-6-6C		3/8"-18 NPT	1.74	44.20				
5Y01-6-8C		1/2"-14 NPT	1.87	47.50	1.000	25.40	10,000	690
5Y01-6-12C		3/4"-14 NPT	1.87	47.50	1.370	34.80		
5Y01-6-16C		1"-11-1/2 NPT	1.87	47.50	1.370	34.80		
5Y01-9-2C*	13/16"-16 UN	1/8"-27 NPT	1.87	47.50	1.000	25.40	15,000	1,030
5Y01-9-4C		1/4"-18 NPT						
5Y01-9-6C		3/8"-18 NPT						
5Y01-9-8C		1/2"-14 NPT			1.370	34.80	10,000	690
5Y01-9-12C		3/4"-14 NPT						
5Y01-9-16C		1"-11-1/2 NPT						
5Y01-12-2C*	3/4"-14 NPS	1/8"-27 NPT	2.50	63.50	1.370	34.80	15,000	1,030
5Y01-12-4C		1/4"-18 NPT						
5Y01-12-6C*		3/8"-18 NPT						
5Y01-12-8C		1/2"-14 NPT			1.370	34.80	10,000	690
5Y01-12-12C		3/4"-14 NPT						
5Y01-12-16C		1"-11-1/2 NPT						
5Y01-16-2C*	1-3/8"-12 UNF	1/8"-27 NPT	2.50	63.50	1.750	34.80	15,000	1,030
5Y01-16-4C		1/4"-18 NPT						
5Y01-16-6C*		3/8"-18 NPT						
5Y01-16-8C		1/2"-14 NPT			1.750	34.80	10,000	690
5Y01-16-12C		3/4"-14 NPT						
5Y01-16-16C		1"-11-1/2 NPT						

**WARNING**

This product can expose you to chemicals including Lead, which is known to the State of California to cause cancer and birth defects or other reproductive harm. For more information go to www.P65Warnings.ca.gov.

Adapters

NPT

02Y5 – Female NPT x Male Medium Pressure

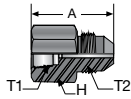

Part Number	T1 Thread Size	T2 Thread Size	Overall Length A		H Hex		Max. Working Pressure	
			inch	mm	inch	mm	psi	bar
02Y5-1-9C	1/16"-27 NPT	13/16"-16 UN	2.00	50.80	1.120	28.45	15,000	1,030
02Y5-2-4C	1/8"-27 NPT	7/16"-20 UNF	1.75	44.45	0.750	19.05	15,000	1,030
02Y5-2-6C		9/16"-18 UNF	1.87	47.50				
02Y5-2-9C		13/16"-16 UN			0.870	22.10		
02Y5-2-12C		3/4"-14 NPSM	2.00	50.80	1.120	28.45		
02Y5-2-16C*		1-3/8"-12 UNF	3.00	76.20	1.000	25.40		
02Y5-4-4C	1/4"-18 NPT	7/16"-20 UNF	1.75	44.45	0.750	19.05	15,000	1,030
02Y5-4-6C		9/16"-18 UNF	1.87	47.50				
02Y5-4-9C		13/16"-16 UN			0.870	22.10		
02Y5-4-12C		3/4"-14 NPSM	2.00	50.80	1.120	28.45		
02Y5-4-16C		1-3/8"-12 UNF	3.00	76.20	1.000	25.40		
02Y5-6-4C	3/8"-18 NPT	7/16"-20 UNF	2.00	50.80	1.000	25.40	15,000	1,030
02Y5-6-6C		9/16"-18 UNF	2.12	53.85				
02Y5-6-9C		13/16"-16 UN	2.25	57.15				
02Y5-6-12C		3/4"-14 NPSM	2.00	50.80	1.120	28.45		
02Y5-6-16C		1-3/8"-12 UNF	3.00	76.20	1.000	25.40		
02Y5-8-4C	1/2"-14 NPT	7/16"-20 UNF	2.12	53.85	1.120	28.45	15,000	1,030
02Y5-8-6C		9/16"-18 UNF	1.25	31.75				
02Y5-8-9C		13/16"-16 UN	2.37	60.20				
02Y5-8-12C		3/4"-14 NPSM	2.50	63.50				
02Y5-8-16C		1-3/8"-12 UNF	3.75	95.25				
02Y5-12-4C*	3/4"-14 NPT	7/16"-20 UNF	2.37	60.20	1.370	34.80	10,000	690
02Y5-12-6C		9/16"-18 UNF	2.50	63.50				
02Y5-12-9C		13/16"-16 UN	2.62	66.55				
02Y5-12-12C		3/4"-14 NPSM	2.75	69.85	1.500	38.10		
02Y5-12-16C		1-3/8"-12 UNF	4.12	104.65				
02Y5-16-6C	1-3/8"-12 UNF	9/16"-18 UNF	2.87	72.90	1.870	47.50	10,000	690
02Y5-16-9C		13/16"-16 UN	3.00	76.20				
02Y5-16-12C		3/4"-14 NPSM						
02Y5-16-16C		1-3/8"-12 UNF	4.37	111.00				

*Non-standard part - may require longer lead time



WARNING

This product can expose you to chemicals including Lead, which is known to the State of California to cause cancer and birth defects or other reproductive harm. For more information go to www.P65Warnings.ca.gov.

Adapters

NPT

Y501 – Male Medium Pressure x Male NPT

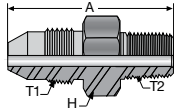

Part Number	T1 Thread Size	T2 Thread Size	Overall Length A		H Hex		Max. Working Pressure	
			inch	mm	inch	mm	psi	bar
Y501-4-4C	7/16"-20 UNF	1/4"-18 NPT	1.60	40.64	0.630	16.00	15,000	1,030
Y501-4-8C		1/2"-14 NPT	2.12	53.85	0.870	22.10		
Y501-6-4C	9/16"-18 UNF	1/4"-18 NPT	2.06	52.32	0.750	19.05	15,000	1,030
Y501-6-6C		3/8"-18 NPT						
Y501-6-8C		1/2"-14 NPT	2.18	55.37	0.870	22.10		
Y501-9-2C*	13/16"-16 UNF	1/8"-27 NPT	2.12	53.85	0.870	22.10	15,000	1,030
Y501-9-4C		1/4"-18 NPT	2.25	57.15				
Y501-9-6C		3/8"-18 NPT						
Y501-9-8C		1/2"-14 NPT	2.37	60.20	1.120	28.45	10,000	690
Y501-9-12C		3/4"-14 NPT	2.62	66.55				
Y501-9-16C		1"-11-1/2 NPT			1.370	34.80		
Y501-12-2C*	3/4"-14 NPS	1/8"-27 NPT	2.37	60.20	1.120	28.45	15,000	1,030
Y501-12-4C*		1/4"-18 NPT	2.50	63.50				
Y501-12-6C*		3/8"-18 NPT						
Y501-12-8C		1/2"-14 NPT	2.62	66.55	1.370	34.80	10,000	690
Y501-12-12C		3/4"-14 NPT	2.75	69.85				
Y501-12-16C		1"-11-1/2 NPT	3.00	76.20				
Y501-16-2C*	1-3/8"-12 UNF	1/8"-27 NPT	3.62	91.95	1.000	25.40	15,000	1,030
Y501-16-4C		1/4"-18 NPT	3.75	95.25				
Y501-16-6C		3/8"-18 NPT						
Y501-16-8C		1/2"-14 NPT	3.87	98.30	1.120	28.45	10,000	690
Y501-16-12C		3/4"-14 NPT						
Y501-16-16C		1"-11-1/2 NPT	4.00	101.60	1.370	34.80		

*Non-standard part - may require longer lead time

**WARNING**

This product can expose you to chemicals including Lead, which is known to the State of California to cause cancer and birth defects or other reproductive harm. For more information go to www.P65Warnings.ca.gov.

Adapters

NPT

5Y02 – Female Medium Pressure x Female NPT Coupling

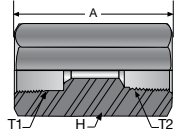

Part Number	T1 Thread Size	T2 Thread Size	Overall Length A		H Hex		Max. Working Pressure	
			inch	mm	inch	mm	psi	bar
5Y02-4-2C	7/16"-20 UNF	1/8"-27 NPT	1.62	41.15	0.750	19.05	15,000	1,030
5Y02-4-4C		1/4"-18 NPT						
5Y02-4-6C		3/8"-18 NPT	2.00	50.80	1.000	25.40		
5Y02-4-8C		1/2"-14 NPT						
5Y02-4-12C*		3/4"-14 NPT	2.37	60.20	1.370	34.80	10,000	690
5Y02-4-16C*		1"-11-1/2 NPT	2.62	66.55	2.000	50.80		
5Y02-6-2C	9/16"-18 UNF	1/8"-27 NPT	1.75	44.45	0.750	19.05	15,000	1,030
5Y02-6-4C		1/4"-18 NPT						
5Y02-6-6C		3/8"-18 NPT	2.12	53.85	1.000	25.40		
5Y02-6-8C		1/2"-14 NPT						
5Y02-6-12C		3/4"-14 NPT	2.37	60.20	1.370	34.80	10,000	690
5Y02-6-16C*		1"-11-1/2 NPT	2.75	69.85	2.000	50.80		
5Y02-9-2C*	13/16"-16 UN	1/8"-27 NPT	2.12	53.85	1.000	25.40	15,000	1,030
5Y02-9-4C		1/4"-18 NPT						
5Y02-9-6C		3/8"-18 NPT	2.25	57.15	1.120	28.45		
5Y02-9-8C		1/2"-14 NPT						
5Y02-9-12C		3/4"-14 NPT	2.50	63.50	1.370	34.80	10,000	690
5Y02-9-16C*		1"-11-1/2 NPT	2.87	72.90	2.000	50.80		
5Y02-12-2C*	3/4"-14 NPS	1/8"-27 NPT	2.50	63.50	1.370	34.80	15,000	1,030
5Y02-12-4C*		1/4"-18 NPT						
5Y02-12-6C*		3/8"-18 NPT	2.75	69.85	1.500	38.10		
5Y02-12-8C		1/2"-14 NPT						
5Y02-12-12C		3/4"-14 NPT	2.75	69.85	1.500	38.10	10,000	690
5Y02-12-16C		1"-11-1/2 NPT	3.00	76.20	1.870	47.50		
5Y02-16-2C*	1-3/8"-12 UNF	1/8"-27 NPT	3.00	76.20	1.750	44.45	15,000	1,030
5Y02-16-4C*		1/4"-18 NPT						
5Y02-16-6C*		3/8"-18 NPT	3.50	88.90	1.500	38.10		
5Y02-16-8C*		1/2"-14 NPT						
5Y02-16-12C		3/4"-14 NPT	3.50	88.90	1.500	38.10	10,000	690
5Y02-16-16C		1"-11-1/2 NPT	3.75	95.25	1.870	47.50		

*Non-standard part - may require longer lead time



WARNING

This product can expose you to chemicals including Lead, which is known to the State of California to cause cancer and birth defects or other reproductive harm. For more information go to www.P65Warnings.ca.gov.

Adapters

NPT

6Y02 – Female High Pressure x Female NPT Coupling

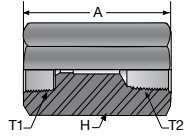

Part Number	T1 Thread Size	T2 Thread Size	Overall Length A		H Hex		Max. Working Pressure	
			inch	mm	inch	mm	psi	bar
6Y02-4-2C*	9/16"-18 UNF	1/8"-27 NPT	1.50	38.10	1.00	25.40	15,000	1,030
6Y02-4-4C		1/4"-18 NPT						
6Y02-4-6C		3/8"-18 NPT	1.87	47.50	1.12	28.45	10,000	690
6Y02-4-8C		1/2"-14 NPT						
6Y02-4-12C		3/4"-14 NPT	2.00	50.80	1.62	41.15		
6Y02-4-16C*		1"-11-1/2 NPT					1.75	44.45
6Y02-6-2C	3/4"-16 UNF	1/8"-27 NPT	1.87	47.50	1.00	25.40	15,000	1,030
6Y02-6-4C		1/4"-18 NPT						
6Y02-6-6C		3/8"-18 NPT	2.12	53.85	1.37	34.80	10,000	690
6Y02-6-8C		1/2"-14 NPT						
6Y02-6-12C		3/4"-14 NPT	2.50	63.50	1.75	44.45		
6Y02-6-16C*		1"-11-1/2 NPT						
6Y02-9-2C	1-1/8"-12 UNF	1/8"-27 NPT	2.37	60.20	1.37	34.80	15,000	1,030
6Y02-9-4C		1/4"-18 NPT						
6Y02-9-6C		3/8"-18 NPT	2.62	66.55	2.00	50.80	10,000	690
6Y02-9-8C		1/2"-14 NPT						
6Y02-9-12C		3/4"-14 NPT						
6Y02-9-16C*		1"-11-1/2 NPT						

*Non-standard part - may require longer lead time

**WARNING**

This product can expose you to chemicals including Lead, which is known to the State of California to cause cancer and birth defects or other reproductive harm. For more information go to www.P65Warnings.ca.gov.

Adapters

NPT

6Y01 – Female High Pressure x Male NPT

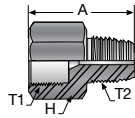

Part Number	T1 Thread Size	T2 Thread Size	Overall Length A		H Hex		Max. Working Pressure	
			inch	mm	inch	mm	psi	bar
6Y01-4-2C	9/16" - 18 UNF	1/8" - 27 NPT	1.25	31.75	0.750	19.05	15,000	1,030
6Y01-4-4C		1/4" - 18 NPT	1.37	34.80				
6Y01-4-6C		3/8" - 18 NPT	1.75	44.45	1.000	25.40	10,000	690
6Y01-4-8C		1/2" - 14 NPT						
6Y01-4-12C		3/4" - 14 NPT	1.62	41.15	1.370	34.80		
6Y01-4-16C		1" - 11-1/2 NPT						
6Y01-6-1C	3/4" - 16 UNF	1/16" - 27 NPT	1.63	41.40	1.00	25.40	15,000	1,030
6Y01-6-2C*		1/8" - 27 NPT	1.50	38.10				
6Y01-6-4C		1/4" - 18 NPT	1.62	41.15				
6Y01-6-6C		3/8" - 18 NPT	1.75	44.45	1.37	34.80	10,000	690
6Y01-6-8C		1/2" - 14 NPT						
6Y01-6-12C*		3/4" - 14 NPT	1.87	47.50	1.37	34.80	10,000	690
6Y01-6-16C	1" - 11-1/2 NPT							
6Y01-9-2C*	1-1/8" - 12 UNF	1/8" - 27 NPT	1.50	38.10	1.37	34.80	15,000	1,030
6Y01-9-4C		1/4" - 18 NPT	1.62	41.15	1.27	32.26		
6Y01-9-6C		3/8" - 18 NPT	1.75	44.45	1.37	34.80		
6Y01-9-8C		1/2" - 14 NPT	1.87	47.50				
6Y01-9-12C		3/4" - 14 NPT			10,000	690		

*Non-standard part - may require longer lead time

WARNING

This product can expose you to chemicals including Lead, which is known to the State of California to cause cancer and birth defects or other reproductive harm. For more information go to www.P65Warnings.ca.gov.

Adapters

NPT

Y601 – Male High Pressure x Male NPT

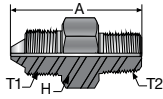

Part Number	T1 Thread Size	T2 Thread Size	Overall Length A		H Hex		Max. Working Pressure	
			inch	mm	inch	mm	psi	bar
Y601-4-4C	9/16" - 18 UNF	1/4" - 18 NPT	2.06	52.32	0.750	19.05		
Y601-4-6C		3/8" - 18 NPT	2.00	50.80				
Y601-4-8C		1/2" - 14 NPT	2.12	53.85	0.870	22.10		
Y601-4-12C		3/4" - 14 NPT	2.25	57.15	1.120	28.45		
Y601-6-4C	3/4" - 16 UNF	1/4" - 18 NPT	2.12	53.85	0.870	22.10	15,000	1,030
Y601-6-6C		3/8" - 18 NPT						
Y601-6-8C		1/2" - 14 NPT	2.28	57.91	0.875	22.23		
Y601-9-4C	1-1/8" - 12 UNF	1/4" - 18 NPT	2.37	60.20	1.120	28.45	15,000	1,030
Y601-9-6C		3/8" - 18 NPT						
Y601-9-8C		1/2" - 14 NPT	2.50	63.50				
Y601-9-12C		3/4" - 14 NPT	2.62	66.55			10,000	690
Y601-9-16C		1" - 11-1/2 NPT	2.75	69.85	1.370	34.80		

*Non-standard part - may require longer lead time

02Y6 – Female NPT x Male High Pressure

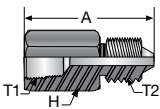

Part Number	T1 Thread Size	T2 Thread Size	Overall Length A		H Hex		Max. Working Pressure	
			inch	mm	inch	mm	psi	bar
02Y6-1-6C	1/16" - 27 NPT	3/4" - 16 UNF	1.75	44.45	0.750	19.05	15,000	1,030
02Y6-2-4C	1/8" - 27 NPT	9/16" - 18 UNF	1.62	41.15				
02Y6-2-6C		3/4" - 16 UNF						
02Y6-2-9C		1-1/8" - 12 UNF	2.12	53.85	1.120	28.45		
02Y6-4-4C	1/4" - 18 NPT	9/16" - 18 UNF	1.75	44.45	0.750	19.05		
02Y6-4-6C		3/4" - 16 UNF						
02Y6-4-9C		1-1/8" - 12 UNF	2.12	53.85	1.120	28.45		
02Y6-6-4C	3/8" - 18 NPT	9/16" - 18 UNF	1.75	44.45	1.000	25.40		
02Y6-6-6C		3/4" - 16 UNF						
02Y6-6-9C		1-1/8" - 12 UNF	2.12	53.85	1.120	28.45		
02Y6-8-4C	1/2" - 14 NPT	9/16" - 18 UNF	2.12	53.85	1.120	28.45		
02Y6-8-6C		3/4" - 16 UNF						
02Y6-8-9C		1-1/8" - 12 UNF						

WARNING

This product can expose you to chemicals including Lead, which is known to the State of California to cause cancer and birth defects or other reproductive harm. For more information go to www.P65Warnings.ca.gov.

Adapters

NPT

10K0203 – Female NPT x Male JIC

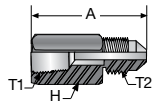

Part Number	T1 Thread Size	T2 Thread Size	Overall Length A		H Hex		Max. Working Pressure	
			inch	mm	inch	mm	psi	bar
10K0203-4-6C	1/4" - 18 NPT	9/16" - 18 UNF	1.68	42.67	0.875	22.23	10,000	690
10K0203-4-8C		3/4" - 16 UNF	1.79	45.47				
10K0203-6-4C	3/8" - 18 NPT	7/16" - 20 UNF	1.76	44.70	1.000	25.40		
10K0203-6-6C		9/16" - 18 UNF	1.68	42.67				
10K0203-6-8C		3/4" - 16 UNF	1.88	47.75				
10K0203-8-4C	1/2" - 14 NPT	7/16" - 20 UNF	2.05	52.07	1.250	31.75		
10K0203-8-6C		9/16" - 18 UNF	1.93	49.02				
10K0203-8-8C		3/4" - 16 UNF	2.04	51.82				
10K0203-16-16C	1" - 11-1/2 NPT	1-5/16" - 12 UN	2.68	68.07	2.00	50.80		

01D9 – Male NPT x Male BSP

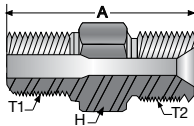

Part Number	T1 Thread Size	T2 Thread Size	Overall Length A		H Hex		Max. Working Pressure	
			inch	mm	inch	mm	psi	bar
01D9-6-6C	3/8" - 18 NPT	G3/8-19	1.57	39.88	0.875	22.23	15,000	1,030
01D9-8-6C	1/2" - 14 NPT	G3/8-19	1.86	47.24	0.875	22.23		
01D9-8-8C		G1/2-14	1.98	50.29	1.000	25.40		

02D9 – Female NPT x Male BSP

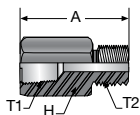

Part Number	T1 Thread Size	T2 Thread Size	Overall Length A		H Hex		Max. Working Pressure	
			inch	mm	inch	mm	psi	bar
02D9-8-8C	1/2" - 14 NPT	G1/2-14	2.10	53.34	1.250	31.75	15,000	1,030



WARNING

This product can expose you to chemicals including Lead, which is known to the State of California to cause cancer and birth defects or other reproductive harm. For more information go to www.P65Warnings.ca.gov.

Adapters

NPT

KL02 – NPT Elbow - 90° Elbow & 45° Elbow

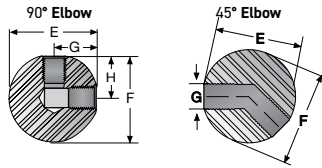

Part Number	Thread Size	Thickness	E		F		G		H		Max. Working Pressure	
			inch	mm	inch	mm	inch	mm	inch	mm	psi	bar
10KL02-12C	3/4" - 14 NPT	2.05	1.85	46.99	1.85	46.99	1.35	34.29	1.350	34.29	10,000	690
10KL02-16C	1" - 11 - 1/2 NPT	2.50	3.83	97.28	3.83	97.28	1.82	46.23	1.820	46.23		
15KL02-4C	1/4" - 18 NPT	1.15	1.70	43.18	1.70	43.18	0.80	20.32	0.800	20.32	15,000	1,030
15KL02-6C	3/8" - 18 NPT	1.38	1.90	48.26	1.90	48.26	0.90	22.86	0.900	22.86		
15KL02-8C	1/2" - 14 NPT	1.63	2.15	54.61	2.15	54.61	1.03	26.16	1.030	26.16		
15KL02-4C-45	1/4" - 18 NPT	1.15	1.68	42.67	1.68	42.67	0.70	17.78	—	—	15,000	1,030
15KL02-6C-45	3/8" - 18 NPT	1.38	1.89	48.01	1.89	48.01	0.91	23.11	—	—		
15KL02-8C-45	1/2" - 14 NPT	1.63	2.15	54.61	2.15	54.61	0.94	23.88	—	—		
10KL02-12C-45	3/4" - 14 NPT	2.00	2.88	73.15	2.88	73.15	1.20	30.48	—	—	10,000	690

KT02 – NPT Tee

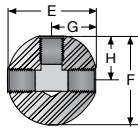

Part Number	Thread Size	Thickness	E		F		G		H		Max. Working Pressure	
			inch	mm	inch	mm	inch	mm	inch	mm	psi	bar
10KT02-12C	3/4" - 14 NPT	2.05	2.70	68.58	1.85	46.99	1.35	34.29	2.050	52.07	10,000	690
10KT02-16C	1" - 11 - 1/2 NPT	2.50	3.63	92.20	3.83	97.28	1.82	46.23	2.500	63.50		
15KT02-4C	1/4" - 18 NPT	1.15	1.60	40.64	1.70	43.18	0.80	20.32	1.150	29.21	15,000	1,030
15KT02-6C	3/8" - 18 NPT	1.38	1.80	45.72	1.90	48.26	0.90	22.86	1.380	35.05		
15KT02-8C	1/2" - 14 NPT	1.63	2.05	52.07	2.15	54.61	1.03	26.16	1.630	41.40		

KX02 – NPT Cross

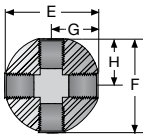

Part Number	Thread Size	Thickness	E		F		G		H		Max. Working Pressure	
			inch	mm	inch	mm	inch	mm	inch	mm	psi	bar
10KX02-12C	3/4" - 14 NPT	2.05	2.70	68.58	2.70	68.58	1.35	34.29	1.350	34.29	10,000	690
10KX02-16C	1" - 11 - 1/2 NPT	2.50	3.63	92.20	3.63	92.20	1.82	46.23	1.820	46.23		
15KX02-4C	1/4" - 18 NPT	1.15	1.60	40.64	1.60	40.64	0.80	20.32	0.800	20.32		
15KX02-6C	3/8" - 18 NPT	1.38	1.80	45.72	1.80	45.72	0.90	22.86	0.900	22.86		
15KX02-8C	1/2" - 14 NPT	1.63	2.05	52.07	2.05	52.07	1.03	26.16	1.030	26.16	15,000	1,030

**WARNING**

This product can expose you to chemicals including Lead, which is known to the State of California to cause cancer and birth defects or other reproductive harm. For more information go to www.P65Warnings.ca.gov.

Adapters

NPT

K02 – NPT Caps

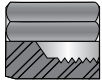

Part Number	Thread Size	Overall Length A		H Hex		Max. Working Pressure	
		inch	mm	inch	mm	psi	bar
15K02-2C-CAP	1/8"-27 NPT	0.90	22.86	0.750	19.05	15,000	1,030
15K02-4C-CAP	1/4"-18 NPT	1.16	29.46	0.875	22.23		
15K02-6C-CAP	3/8"-18 NPT	1.25	31.75	1.000	25.40		
15K02-8C-CAP	1/2"-14 NPT	1.43	36.32	1.250	31.75		
10K02-12C-CAP	3/4"-14 NPT	1.50	38.10	1.500	38.10	10,000	690

KP01 – NPT Plugs

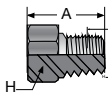

Part Number	Thread Size	Overall Length A		H Hex		Max. Working Pressure	
		inch	mm	inch	mm	psi	bar
10KP01-12C	3/4"-14 NPT	1.45	36.83	1.125	28.58	10,000	690
10KP01-16C	1"-11-1/2 NPT	1.81	45.97	1.375	34.93		
15KP01-1C	1/16"-27 NPT	0.68	17.27	0.375	9.53	15,000	1,030
15KP01-2C	1/8"-27 NPT	0.75	19.05	0.500	12.70		



WARNING

This product can expose you to chemicals including Lead, which is known to the State of California to cause cancer and birth defects or other reproductive harm. For more information go to www.P65Warnings.ca.gov.

Adapters

JIC

Parker Parflex offers a wide range of high quality stainless steel high pressure JIC adapters from 10,000 psi to 15,000 psi operating pressure. Sizes range from 1/4" to 1" and above are rated to 10,000 psi.



Thread Sizes

-04	-06	-08	-10	-12	-16
7/16" -20 UNF	9/16" -18 UNF	3/4" -16 UNF	7/8" -14 UNF	1-1/16"-12 UN	1-5/16"-12 UN

Features

- All adapters are rated to a minimum operating pressure of 10,000 psi
- Meets SAE J514 configuration on flare end
- Compact envelope size for ease of installation



WARNING

This product can expose you to chemicals including Lead, which is known to the State of California to cause cancer and birth defects or other reproductive harm. For more information go to www.P65Warnings.ca.gov.

Adapters

JIC

K0303 – Male JIC x Male JIC

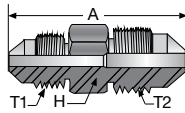

Part Number	T1 Thread Size	T2 Thread Size	Overall Length A		H Hex		Max. Working Pressure	
			inch	mm	inch	mm	psi	bar
10K0303-4-4C	7/16"-20 UNF	7/16"-20 UNF	1.50	38.10	0.625	15.88	10,000	690
10K0303-4-6C		9/16"-18 UNF						
10K0303-4-8C		3/4"-16 UNF						
10K0303-6-8C	9/16"-18 UNF	3/4"-16 UNF	1.73	43.94	0.875	22.23		

K0306 – Male JIC x Female JIC

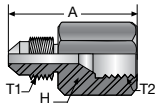

Part Number	T1 Thread Size	T2 Thread Size	Overall Length A		H Hex		Max. Working Pressure	
			inch	mm	inch	mm	psi	bar
10K0306-4-4C	7/16"-20 UNF	7/16"-20 UNF	1.43	36.32	0.750	19.05	10,000	690
10K0306-4-6C		9/16"-18 UNF	1.55	39.37	0.875	22.23		
10K0306-4-8C		3/4"-16 UNF	1.60	40.64	1.000	25.40		
10K0306-6-6C	9/16"-18 UNF	9/16"-18 UNF	1.55	39.37	0.875	22.23		
10K0306-8-6C	3/4"-16 UNF							

K0606 – Female JIC x Female JIC

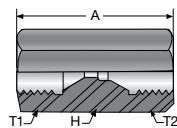

Part Number	T1 Thread Size	T2 Thread Size	Overall Length A		H Hex		Max. Working Pressure	
			inch	mm	inch	mm	psi	bar
10K0606-4-4C	7/16"-20 UNF	7/16"-20 UNF	1.35	34.29	0.750	19.05	10,000	690
10K0606-4-6C		9/16"-18 UNF	1.50	38.10	0.875	22.23		
10K0606-6-6C	9/16"-18 UNF	9/16"-18 UNF	1.40	35.56	0.875	22.23		



WARNING

This product can expose you to chemicals including Lead, which is known to the State of California to cause cancer and birth defects or other reproductive harm. For more information go to www.P65Warnings.ca.gov.

Adapters

JIC

YA03 – Male Type “M” x Male JIC

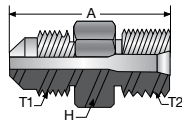

Part Number	T1 Thread Size	T2 Thread Size	Overall Length A		H Hex		Max. Working Pressure	
			inch	mm	inch	mm	psi	bar
YA03-11-6C	1" - 12 UNF	9/16" - 18 UNF	1.69	42.93	1.000	34.93	10,000	690
YA03-16-8C	1-5/16" - 12 UN	3/4" - 16 UNF	1.79	45.47	1.375	34.93		
YA03-16-12C		1-1/16" - 12 UN	2.00	50.80				

Y503 – Male Medium Pressure x Male JIC

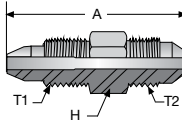

Part Number	T1 Thread Size	T2 Thread Size	Overall Length A		H Hex		Max. Working Pressure	
			inch	mm	inch	mm	psi	bar
Y503-4-8C	7/16" - 20 UNF	3/4" - 16 UNF	1.74	44.20	0.875	22.23	10,000	690
Y503-9-10C	13/16" - 16 UN	7/8" - 14 UNF	2.38	60.45	1.000	25.40		
Y503-9-12C		1-1/16" - 12 UN	2.47	62.74	1.125	28.58		
Y503-9-16C		1-5/16" - 12 UN	2.55	64.77	1.375	34.93		
Y503-12-6C	3/4" - 14 NPSM	9/16" - 18 UNF	2.25	57.15	1.125	28.58		
Y503-12-8C		3/4" - 16 UNF	2.35	59.69				
Y503-12-12C		1-1/16" - 12 UN	2.66	67.56				
Y503-16-12C	1" - 14 UNF LH	1-1/16" - 12 UN	4.02	102.11	1.125	28.58		
Y503-16-16C		1-5/16" - 12 UN	4.07	103.38	1.375	34.93		

Y603 – Male High Pressure x Male JIC

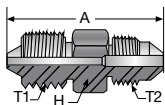

Part Number	T1 Thread Size	T2 Thread Size	Overall Length A		H Hex		Max. Working Pressure	
			inch	mm	inch	mm	psi	bar
Y603-4-4C	9/16" - 18 UNF	7/16" - 20 UNF	1.61	40.89	0.625	15.88	10,000	690
Y603-4-6C		9/16" - 18 UNF						
Y603-4-8C		3/4" - 16 UNF	1.81	45.97	0.875	22.23		
Y603-6-4C	3/4" - 16 UNF	7/16" - 20 UNF	1.84	46.74	0.750	19.05		
Y603-6-6C		9/16" - 18 UNF	1.94	49.28				
Y603-6-8C		3/4" - 16 UNF	2.04	51.82	0.875	22.23		
Y603-9-6C	1-1/8" - 12 UNF	9/16" - 18 UNF	2.09	53.09	1.125	28.58		
Y603-9-8C	1-1/8" - 12 UNF	3/4" - 16 UNF	2.19	55.63				

**WARNING**

This product can expose you to chemicals including Lead, which is known to the State of California to cause cancer and birth defects or other reproductive harm. For more information go to www.P65Warnings.ca.gov.

Adapters

JIC

10K06 – JIC Caps

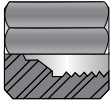

Part Number	Thread Size	Overall Length A		H Hex		Max. Working Pressure	
		inch	mm	inch	mm	psi	bar
10K06-4C-CAP	7/16"-20 UNF	0.83	21.08	0.625	15.88	10,000	690
10K06-6C-CAP	9/16"-18 UNF	0.93	23.62	0.750	19.05		
10K06-8C-CAP	3/4"-16 UNF	1.04	26.42	0.875	22.23		
10K06-10C-CAP	7/8"-14 UNF	1.16	29.46	1.000	25.40		
10K06-12C-CAP	1-1/16"-12 UN	1.31	33.27	1.250	31.75		

10KP03 – JIC Plugs

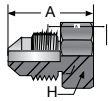

Part Number	Thread Size	Overall Length A		H Hex		Max. Working Pressure	
		inch	mm	inch	mm	psi	bar
10KP03-4C	7/16"-20 UNF	0.81	20.57	0.500	12.70	10,000	690
10KP03-6C	9/16"-18 UNF	0.85	21.59	0.625	15.88		
10KP03-8C	3/4"-16 UNF	0.95	24.13	0.812	20.62		
10KP03-10C	7/8"-14 UNF	1.11	28.19	0.937	23.80		
10KP03-12C	1-1/16"-12 UNF	1.29	32.80	0.750	19.05		
10KP03-16C	1-5/16"-12 UN	1.34	34.04	1.375	34.93		



WARNING

This product can expose you to chemicals including Lead, which is known to the State of California to cause cancer and birth defects or other reproductive harm. For more information go to www.P65Warnings.ca.gov.

Adapters



Quick Couplings



Quick Couplings

Table Of Contents

Introduction

Nomenclature - Rogan Series C-3
 Nomenclature - C Series C-4

Series

Rogan C-5
 HP006 Coupler C-5
 HP006 Nipple without Check Valve C-6
 HP006 Nipple with Check Valve C-6

 HP010 Coupler C-7
 HP010 Nipple without Check Valve C-7
 HP010 Nipple with Check Valve C-8

 C Series C-9
 115 Coupler C-10
 115 Nipple C-10
 116 Coupler C-11
 116 Nipple C-11
 125 Coupler C-12
 125 Nipple C-12
 Quick Coupling Adapters C-13



Quick Coupling Nomenclature

Quick Coupling Part Numbers (Rogan Series)

The part number description given to the Rogan Series (Walther Quick Couplings) is as follows:

Example: HP006-0-NMC

HP006-0-NMC – Thru Hole Size = .240" or 6mm nominal thru hole diameter
 HP006-0-NMC – Component Type = Female coupler with check valve
 HP006-0-NMC – Connection Type = NPT
 HP006-0-NMC – Connection Gender = Male
 HP006-0-NMC – Connection Size = 3/8" NPT

Most adapter part number structures will follow the below examples.

Thru Hole Size

HP006	.240" or 6mm, nominal thru hole diameter
HP010	.400" or 10mm, nominal thru hole diameter

Component Type

0	Female coupler with check valve
1	Male nipple w/o check valve (straight through)
2	Male nipple with check valve

		Thread Form			
Connection Type		Connection Gender		Connection Size	
H	High Pressure	M	Male	4	1/4"
L	Medium Pressure	F	Female	6	3/8"
A	Type "M"			9	9/16"
N	NPT			12	3/4"
X	Low Angle Face Seal			16	1"
				B	1/4" NPT
				C	3/8" NPT
				D	1/2" NPT

Quick Coupling Nomenclature

Quick Coupling Part Numbers (C Series)

The part number description given to the C Series couplings is as shown below. This description is for couplings only. The part numbers for quick coupling adapters will deviate from this structure.

Example: C10-116-1202

C10-116-1202 - Part Type - Coupling Component
 C10-**116**-1202 - Maximum Working Pressure = 21,760 psi
 C10-116-**1202** - Component Type = Coupler
 C10-116-1**202** - Connection = BSP
 C10-116-12**02** - Gender = Female
 C10-116-120**2** - Size = 1/4"

Part Type	
C10	Coupling component
C19	Adapter

Series	
115	Working pressure of 14,500 psi (100 MPa)
116	Working pressure of 21,760 psi (150 MPa)
125	Working pressure of 29,000 psi (200 MPa)
950	Adapters only - Working pressures up to 43,500 psi (300 MPa)

Coupling Part*	
1	Coupler
6	Nipple
5	Nipple w/o Check Valve

* Not applicable to adapters

Coupling Thread Form*					
Connection Type		Connection Gender		Connection Size	
2	BSP	5	Male	1	1/8"
4	NPT	0	Female	2	1/4"
		2	Female w/ built-in locking device	4	3/8"

* Not applicable to adapters

Quick Couplings

Rogan Series

Rogan series quick couplings are versatile connecting devices that permit easy and rapid joining of hose assemblies to your system. Each coupling is assembled and pressure tested to at least 5,000 psi above its maximum rated working pressure. Couplings with check-valves can withstand the full working pressure in the disconnected condition. The standard seal material is Nitrile, however, Viton, EPDM and FFKM are also available.

Type	Maximum Working Pressure psi	Test Pressure psi	Nominal Thru Hole Diameter inch
HP006	30,000	35,000	0.240
HP010	20,000	25,000	0.400

Note: The choice of the threaded end form may limit the working pressure and the size of the thru hole in the coupling. Call Parflex for additional information.



HP006 – Coupler

Part Number	Thread Type	Overall Length A		H Hex		Max. Working Pressure	
		inch	mm	inch	mm	psi	bar
HP006-0-A9	Type "M" (9/16" - 18)	3.30	83.82	1.190	30.23	30,000	2,070
HP006-0-A12	Type "M" (3/4" - 16)	3.34	84.84				
HP006-0-HM4	1/4" High Pressure Male	3.46	87.88			30,000	2,070
HP006-0-HM9	9/16" High Pressure Male	3.70	93.98				
HP006-0-LM6	3/8" Medium Pressure Male	3.54	89.92			20,000	1,380
HP006-0-NFB	1/4" NPT Female	3.30	83.82				
HP006-0-NFC	3/8" NPT Female					15,000	1,030
HP006-0-NMB	1/4" NPT Male	3.40	86.36				
HP006-0-NMC	3/8" NPT Male	3.30	83.82				
HP006-0-NMD	1/2" NPT Male	3.45	87.63			30,000	2,070
HP006-0-X13	Low Angle Face Seal (9/16" - 18)	3.37	85.60				

Alloy Steel

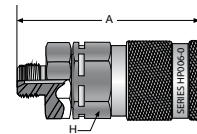

HP006-0-A9
HP006-0-A12

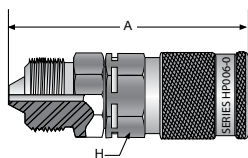

HP006-0-HM4
HP006-0-HM9

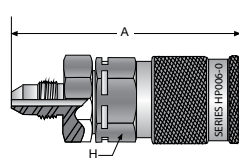

HP006-0-LM6

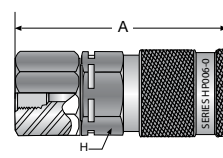

HP006-0-NFB
HP006-0-NFC

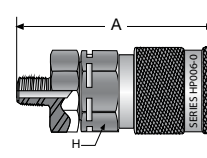

HP006-0-NMB
HP006-0-NMC
HP006-0-NMD

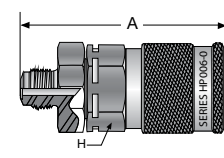

HP006-0-X13



WARNING

This product can expose you to chemicals including Lead, which is known to the State of California to cause cancer and birth defects or other reproductive harm. For more information go to www.P65Warnings.ca.gov.

Quick Couplings

Rogan Series

HP006 – Nipple w/o Check Valve

Part Number	Thread Type	Overall Length A		H Hex		Max. Working Pressure	
		inch	mm	inch	mm	psi	bar
HP006-1-A9	Type "M" (9/16" - 18)	1.98	50.29	0.750	19.05	30,000	2,070
HP006-1-A12	Type "M" (3/4" - 16)	2.16	54.86	0.870	22.10		
HP006-1-HM4	1/4" High Pressure Male	2.25	57.15	0.750	19.05	30,000	2,070
HP006-1-LM6	3/8" Medium Pressure Male	2.33	59.18	0.750	19.05	20,000	1,380
HP006-1-LM9	9/16" Medium Pressure Male	2.57	65.28	1	25.40		
HP006-1-NMB	1/4" NPT Male	2.09	53.09	0.750	19.05	15,000	1,030
HP006-1-NMC	3/8" NPT Male	2.13	54.10				
HP006-1-NMD	1/2" NPT Male	2.31	58.67	1	25.40		
HP006-1-X13	Low Angle Face Seal (9/16" - 18)	2.17	55.12	0.750	19.05	30,000	2,070

Alloy Steel

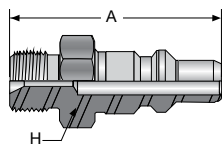

HP006-1-A9
HP006-1-A12

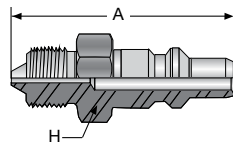

HP006-1-HM4

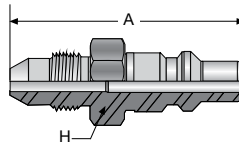

HP006-1-LM6
HP006-1-LM9

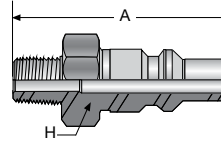

HP006-1-NMB
HP006-1-NMC
HP006-1-NMD

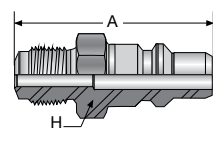

HP006-1-X13

HP006 – Nipple w/Check Valve

Part Number	Thread Type	Overall Length A		H Hex		Max. Working Pressure	
		inch	mm	inch	mm	psi	bar
HP006-2-A9	Type "M" (9/16" - 18)	3.28	83.31	1.190	30.23	30,000	2,070
HP006-2-A12	Type "M" (3/4" - 16)	3.30	83.82			30,000	2,070
HP006-2-HM4	1/4" High Pressure Male	3.45	87.63			20,000	1,380
HP006-2-LM6	3/8" Medium Pressure Male	3.52	89.41			15,000	1,030
HP006-2-NFB	1/4" NPT Female	3.26	82.80				
HP006-2-NFC	3/8" NPT Female	3.25	82.55			15,000	1,030
HP006-2-NMB	1/4" NPT Male	3.34	84.84				
HP006-2-NMC	3/8" NPT Male	3.34	84.84				
HP006-2-NMD	1/2" NPT Male	3.43	87.12			30,000	2,070
HP006-2-X13	Low Angle Face Seal (9/16" - 18)	3.35	85.09				

Alloy Steel

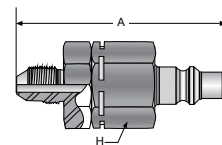

HP006-2-HM4

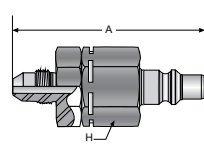

HP006-2-LM6

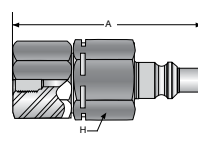

HP006-2-NFB
HP006-2-NFC

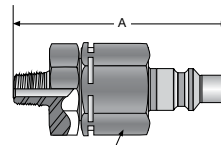

HP006-2-NMB
HP006-2-NMC
HP006-2-NMD

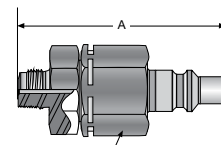

HP006-2-X13

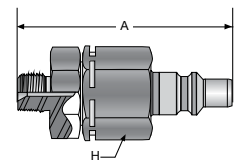

HP006-2-A9
HP006-2-A12

WARNING

This product can expose you to chemicals including Lead, which is known to the State of California to cause cancer and birth defects or other reproductive harm. For more information go to www.P65Warnings.ca.gov.

Quick Couplings

Rogan Series

HP010 – Coupler

Part Number	Thread Type	Overall Length A		H Hex		Max. Working Pressure	
		inch	mm	inch	mm	psi	bar
HP010-0-A12	Type "M" (3/4" - 16)	4	101.60	1.620	41.15	20,000	1,380
HP010-0-A16	Type "M" (1" - 12)	4.10	104.14				
HP010-0-LM12	3/4" Medium Pressure Male	4.64	117.86				
HP010-0-NFD	1/2" NPT Female	4.27	108.46				
HP010-0-NMD	1/2" NPT Male	4.13	104.90				
HP010-0-X23	Low Angle Face Seal (3/4" - 16)	4.19	106.43				

Alloy Steel

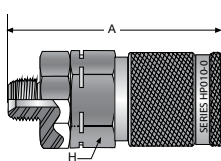

HP010-0-A12
HP010-0-A16

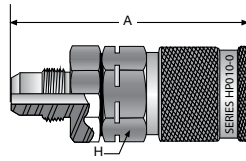

HP010-0-LM12

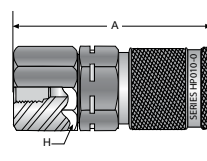

HP010-0-NFD

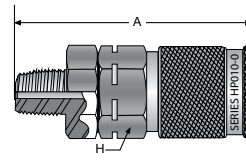

HP010-0-NMD

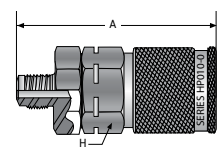

HP010-0-X23

HP010 – Nipple w/o Check Valve

Part Number	Thread Type	Overall Length A		H Hex		Max. Working Pressure	
		inch	mm	inch	mm	psi	bar
HP010-1-A12	Type "M" (3/4" - 16)	2.40	60.96	1.060	26.92	20,000	1,380
HP010-1-A16	Type "M" (1" - 12)	2.53	64.26	1.180	29.97		
HP010-1-LM9	9/16" Medium Pressure Male	3.12	79.25	1.180	29.97	20,000	1,380
HP010-1-LM12	3/4" Medium Pressure Male	2.84	72.14	1.060	26.92		
HP010-1-NMD	1/2" NPT Male	2.52	64.01	1.060	26.92	15,000	1,030
HP010-1-X23	Low Angle Face Seal (3/4" - 16)	2.58	65.53	1.060	26.92	20,000	1,380

Alloy Steel

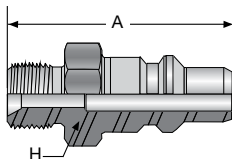

HP010-1-A12
HP010-1-A16

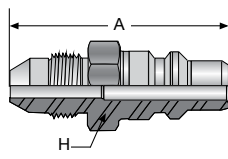

HP010-1-LM9
HP010-1-LM12

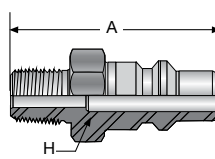

HP010-1-NMD

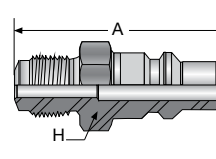

HP010-1-X23



WARNING

This product can expose you to chemicals including Lead, which is known to the State of California to cause cancer and birth defects or other reproductive harm. For more information go to www.P65Warnings.ca.gov.

Quick Couplings

Rogan Series

HP010 – Nipple w/ Check Valve

Part Number	Thread Type	Overall Length A		H Hex		Max. Working Pressure	
		inch	mm	inch	mm	psi	bar
HP010-2-A12	Type "M" (3/4" - 16)	4	101.60	1.620	41.15	20,000	1,380
HP010-2-A16	Type "M" (1" - 12)	4.08	103.63				
HP010-2-NFD	1/2" NPT Female	4.14	105.16			15,000	1,030
HP010-2-NMD	1/2" NPT Male	4.13	104.90				
HP010-2-X23	Low Angle Face Seal (3/4" - 16)	4.18	106.17			20,000	1,380

Alloy Steel

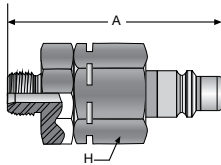

HP010-2-A12
HP010-2-A16

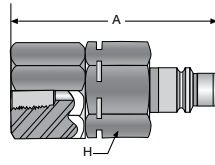

HP010-2-NFD

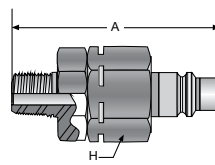

HP010-2-NMD

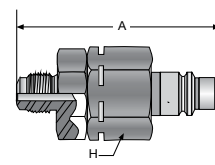

HP010-2-X23



WARNING

This product can expose you to chemicals including Lead, which is known to the State of California to cause cancer and birth defects or other reproductive harm. For more information go to www.P65Warnings.ca.gov.

Quick Couplings

C Series

C Series quick couplings are and pressures up to 29,000 psi.

Advantages:

- Non-drip valving for clean, safe, trouble-free performance air inclusion
- Built-in safety locking device to prevent accidental disconnect
- Wide range of threaded styles: NPT, BSP and "High Pressure"
- Adapters for ease of connection to high pressure hoses and fixed ports
- Thread sizes from 1/8" to 3/8"
- Protective dust caps are included to prevent damage and fluid contamination in disconnected position
- Rugged design and construction for long life in demanding applications



Applications		
Torque Tensioning	Pumps	Presses
Stud Tensioning	Jacks	Clamping Fixtures
Rescue	Spreaders	Crimpers
Bearing Pullers	Cable Cutters	Blow-out Preventers
Intensifiers	Nut Splitters	
Hydrostatic Testing	Pipe Coupling Swagers	

Type	Maximum Working Pressure psi	Test Pressure psi	Nominal Thru Hold Diameter inch
C Series 115	14,500	21,800	0.11
C Series 116	21,800	29,200	0.11
C Series 125	29,800	36,300	0.11

Note: The choice of the threaded end form may limit the working pressure and the size of the thru hole in the coupling. Call Parflex for additional information.



WARNING

This product can expose you to chemicals including Lead, which is known to the State of California to cause cancer and birth defects or other reproductive harm. For more information go to www.P65Warnings.ca.gov.

Quick Couplings

C Series

115 – Coupler

Part Number	Thread Type	Overall Length A		H Hex		Max. Working Pressure	
		inch	mm	inch	mm	psi	bar
C10-115-1202	1/4" BSP Female (thru type)	2.30	58.42	0.940	23.8	14,500	1,000
C10-115-1222	1/4" BSP Female (with built-in locking device)						
C10-115-1401	1/8" NPT Female	2.30	58.42				
C10-115-1402	1/4" NPT Female						
C10-115-1404	3/8" NPT Female	2.38	60.45				
C10-115-1452	1/4" NPT Male	2.45	62.23				
C10-115-1454	3/8" NPT Male						

All exposed components are made of zinc-plated steel.

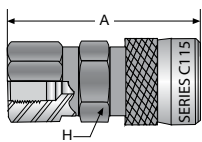

C10-115-1202

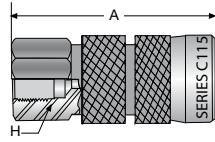

C10-115-1222

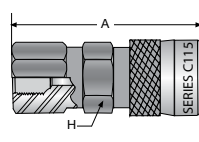
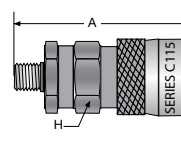
C10-115-1401
C10-115-1402
C10-115-1404C10-115-1452
C10-115-1454

115 – Nipple

Part Number	Thread Type	Overall Length A		H Hex		Max. Working Pressure	
		inch	mm	inch	mm	psi	bar
C10-115-6202	1/4" BSP Female	1.47	37.34	0.870	22.10	14,500	1,000
C10-115-6204	3/8" BSP Female	1.56	39.62	0.940	23.88		
C10-115-6401	1/8" NPT Female	1.42	36.07	0.870	22.10		
C10-115-6402	1/4" NPT Female						
C10-115-6404	3/8" NPT Female	1.46	37.08	0.940	23.88		
C10-115-6452	1/4" NPT Male	2.40	60.96	0.870	22.10		
C10-115-6454	3/8" NPT Male	2.55	64.77	0.940	23.88		

All exposed components are made of zinc-plated steel.

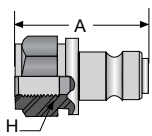
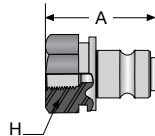
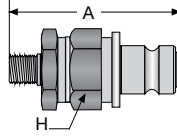
C10-115-6202
C10-115-6204C10-115-6401
C10-115-6402
C10-115-6404C10-115-6452
C10-115-6454

WARNING

This product can expose you to chemicals including Lead, which is known to the State of California to cause cancer and birth defects or other reproductive harm. For more information go to www.P65Warnings.ca.gov.

Quick Couplings

C Series

116 – Coupler

Part Number	Thread Type	Overall Length A		H Hex		Max. Working Pressure	
		inch	mm	inch	mm	psi	bar
C10-116-1202	1/4" BSP Female	2.3	58.42	0.940	23.88	21,750	1,500
C10-116-1222	1/4" BSP Female (with built-in locking device)						
C10-116-1402	1/4" NPT Female (with built-in locking device)					15,000	1,035

All exposed components are made of zinc-plated steel.

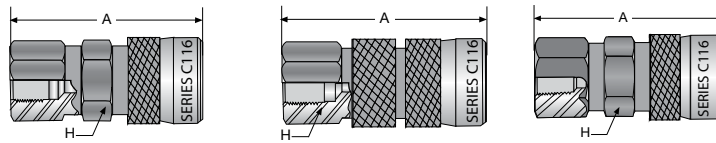

C10-116-1202

C10-116-1222

C10-116-1402

116 – Nipple

Part Number	Thread Type	Overall Length A		H Hex		Max. Working Pressure	
		inch	mm	inch	mm	psi	bar
C10-116-5202	1/4" BSP Female (thru type)	1.47	37.34	0.870	22.1	21,750	1,500
C10-116-6202	1/4" BSP Female						
C10-116-6402	1/4" NPT Female	1.41	35.81	0.870	22.1	15,000	1,035

All exposed components are made of zinc-plated steel.

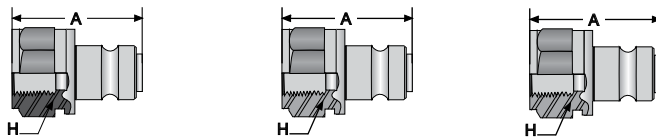

C10-116-5202

C10-116-6202

C10-116-6402



WARNING

This product can expose you to chemicals including Lead, which is known to the State of California to cause cancer and birth defects or other reproductive harm. For more information go to www.P65Warnings.ca.gov.

Quick Couplings

C Series

125 – Coupler

Part Number	Thread Type	Overall Length A		H Hex		Max. Working Pressure	
		inch	mm	inch	mm	psi	bar
C10-125-1203	1/4" BSP Female	2.53	64.26	0.950	24.13	36,300	2,502

All exposed components are made of zinc-plated steel.

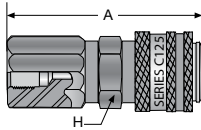

C10-125-1203

125 – Nipple

Part Number	Thread Type	Overall Length A		H Hex		Max. Working Pressure	
		inch	mm	inch	mm	psi	bar
C10-125-5202	1/4" BSP Female (thru type)	1.50	38.1	0.870	22.1	29,000	2,000
C10-125-6203	1/4" BSP Female					36,300	2,500

All exposed components are made of zinc-plated steel.

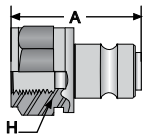

C10-116-5202

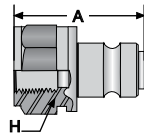

C10-125-6203



WARNING

This product can expose you to chemicals including Lead, which is known to the State of California to cause cancer and birth defects or other reproductive harm. For more information go to www.P65Warnings.ca.gov.

Quick Couplings

C Series

Quick Coupling Adapters

Part Number	Thread Type	Overall Length A		H Hex		Max. Working Pressure	
		inch	mm	inch	mm	psi	bar
C09-125-1680	1/4" BSP 120° external cone x 1/4" HP Male	2	43.69	0.670	17.02	29,000	2,000
C19-950-0029	1/4" BSP 120° external cone x 9/16" UNF	1	37.59				
C19-950-0062	1/4" Rubber Metal Seal	0	2.030	0.810	20.57	14,500	1,000
C19-950-0064	3/8" Rubber Metal Seal	0	2.030	0.940	23.88		
C19-950-1600	1/4" BSP 120° external cone Blind Plug	1	27.18	0.670	17.02	29,000	2,000
C19-950-1601	1/4" BSP x 1/4" BSP 120° external cones	2	44.70	0.080	2.030		
C19-950-1602	1/4" BSP 120° external cone x 1/4" BSP 60° internal cone	2	39.12	0.830	21.08		
C19-950-1622	1/4" BSP x 1/4" BSP with 60° internal cone	1	31.75				
C19-950-1623	1/4" NPT Male x 1/4" BSP with 60° internal cone	1	32.26	0.830	21.08	14,500	1,000
C19-950-1680	Porting Block	2	45.72	N/A	N/A	29,000	2,000
HAHM4BM4	1/4" BSP with 60° internal cone x 1/4" HP Male	1	37.34	0.830	21.08	30,000	2,070

All exposed components are made of zinc-plated steel.

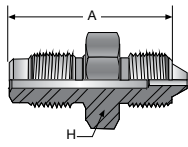

C09-125-1680

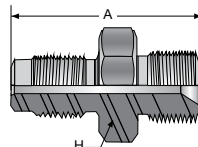

C19-950-0029

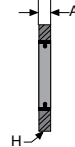

C19-950-0062

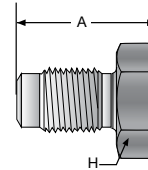

C19-950-1600
C19-950-0064

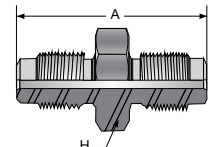

C19-950-1601

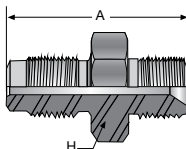

C19-950-1602

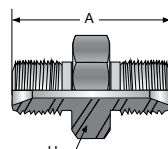

C19-950-1622

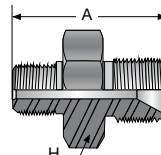

C19-950-1623

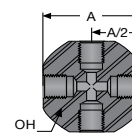

C19-950-1680

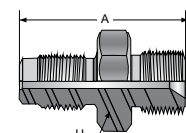

HAHM4BM4



WARNING

This product can expose you to chemicals including Lead, which is known to the State of California to cause cancer and birth defects or other reproductive harm. For more information go to www.P65Warnings.ca.gov.

Quick Couplings



Accessories



Accessories

Table Of Contents

- Abrasion Cover / Cover SleevesD-3
- Bend RestrictorsD-3
- Dies for Parkrimp 2.....D-5
- Hose Guards.....D-3
- Hose Stops.....D-4
- Lifting Clamp and Chain.....D-4
- Lubricant.....D-5
- Pressure Containment ShieldD-4
- Spring GuardsD-3
- Support GripsD-4
- Transition SleevesD-3
- Warning TagsD-5

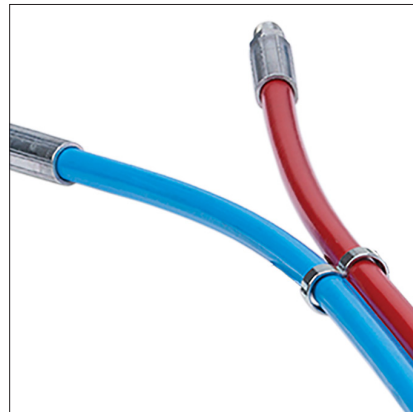

Accessories

Heavy Duty Abrasion Cover and Cover Sleeves

Part Number	Size I.D. inch	Size O.D. inch	Material	Reinforcement	Bend Radius inch	Weight (lbs/ft)	Cover Sleeve	Cover Sleeve Material
PVC-BLUE-012	3/4	0.938	Clear Vinyl	Blue PVC Helix	3	0.20	510-A-500-12	Aluminum
PVC-BLUE-018	1-1/8	1.375	Clear Vinyl	Blue PVC Helix	3	0.29	216-200-18	Carbon Steel
PVC-BLUE-024	1-1/2	1.780	Clear Vinyl	Blue PVC Helix	5	0.40	220-200-22	Carbon Steel
PVC-ORANGE-012	3/4	0.938	Clear Vinyl	Orange PVC Helix	3	0.20	510-A-500-12	Aluminum
PVC-ORANGE-016	1	1.250	Clear Vinyl	Orange PVC Helix	3	0.27	412-400	Carbon Steel



Spring Guards

Part Number	I.D. inch	O.D. inch	Length inch	Material	Designated Hose Series
MSG060	0.61	0.77	300	Stainless Steel	2440N-04
MSG2106	0.63	0.89	7.87	Carbon Steel	2380N-04



Bend Restrictors

Part Number	I.D. inch	O.D. inch	Length inch	Material	Designated Hose Series
HG8X-04	.673	1.18	5.12	Rigid Polymer	2380N-4
MBR003	.250	.515	2.33	Molded Vinyl	2020N*
MBR004	.250	.490	2.16	Molded Vinyl	2020N**
MBR008	.500	.800	6	Molded Vinyl	2380N-025, 2440D-025
MBR010	.625	.925	6	Molded Vinyl	2380N-04
MBR013-BLK	.845	1.10	9.84	Molded Rigid Vinyl	2648N-16
HG2022N-4	.700	1.18	5.12	Rigid Polymer	2022N-4



Note: * for RX fittings ** for EX fittings

Transition Sleeves

Part Number	I.D. inch	O.D. inch	Length inch	Material	Designated Hose Series
520-A-500-26	Contact division			2440N-16, 2648N-12	
KL-2841	.965	1.142	1.181	Carbon Steel	2740D-03, 2740D-05, 2840D-03, PFX30-05-TJ
KL-2841-03	.807	.984	1.181	Carbon Steel	2740D-03-TJ
P2529-85AL	1.17	1.44	3.35	Aluminum	2440N-08-TJ
532-500	Contact division			2648N-16	
508-J-500-10	Contact division			2380N-04, 2440D-03, 2440D-04, 2440N-04	
P2542-80	1.65	1.89	3.15	Carbon Steel	2640N-12V32/12



WARNING

This product can expose you to chemicals including Lead, which is known to the State of California to cause cancer and birth defects or other reproductive harm. For more information go to www.P65Warnings.ca.gov.

Accessories

Hose Stops

Part Number	I.D. inch	O.D. inch	Length inch	Material	Designated Hose Series
AH-03S	.400	.530	1.181	Carbon Steel	2240D-03
AH-04S	.480	.610	1.181	Carbon Steel	2440D-025, 2448D-025
AH-05S	.560	.710	1.575	Carbon Steel	2440D-03, 2440D-04, 2640D-03, 2740D-03
AH-06S	.690	.885	1.575	Carbon Steel	2380N-05, 2440D-05, 2840D-03
AH-08S	1.063	1.26	1.575	Carbon Steel	2388N-08



Support Grips - Dual Eye

Part Number	Loop Size. inch	Overall Length inch	Material	Breaking Strength (lbs/ft)	Hose Size O.D. inch	Weight lbs.
MCGHS10-15	0.71	26.18	Galvanized Steel	2,293	0.40" - 0.59"	0.15
MCGHS15-20	0.71	27.17	Galvanized Steel	2,900	0.59" - 0.79"	0.33
MCGHS20-30	0.71	26.97	Galvanized Steel	5,463	0.79" - 1.18"	0.40
MCGHS30-40	0.71	27.56	Galvanized Steel	7,891	1.18" - 1.57"	0.68
MCGHS40-50	0.71	28.54	Galvanized Steel	10,791	1.57" - 1.96"	1.04
MCGHS50-60	0.71	33.46	Galvanized Steel	10,791	1.96" - 2.36"	1.81
MCGHS3295-SS	4.50	81.5	Stainless Steel	49,000	1-1/2" and 2" (Black Eagle)	9.50



Lifting Clamp and Chain

Part Number	Size. inch
LC-48-15000	3

Pressure Containment Shield

Part Number	I.D. inch	O.D. inch	Retaining Sleeve Part Number	Stiffener	Material	Bend Radius inch	Weight (lbs/ft)	Designated Hose Series
MHBS012	0.75	1.09	412-400	M55STIF-4 M55STIF-6	Rubber	9.5	0.42	2740D-03 and 2840D-03
MHBS016	1	1.41	416-400-16	N/A	Rubber	12	0.63	PFX25-5; PFX30-5; PFX38-5



WARNING

This product can expose you to chemicals including Lead, which is known to the State of California to cause cancer and birth defects or other reproductive harm. For more information go to www.P65Warnings.ca.gov.

Accessories

Dies for Parkrimp 2

Part Number	Description	Fitting Series
83C-9X04	2390N-04	E3
80C-9X06	2390N-06	9X
83C-9X08	2390N-08	E3
83C-9X16	2390N-16	E4
83C-L24	2340N-24	8X
83C-8X16	2380N-16	E4



Warning Tags

Part Number	Description
G214-240	White - General warning tag should be applied to all hoses
G214-245	Yellow - Warning tag for flex lances
2022N Tag	General caution tag should be applied to all 2022N hoses
2022N Non-Conductive Tag	Non-conductive hose tag should be applied to all non-conductive hoses



G214-240



G214-245



2022N



2022N
Non-conductive

ThreadMate® Anti-Gall Lubricant

Part Number	Description
MTM04T	4 oz Tube



ThreadMate is an extreme duty lubricant developed to reduce galling during the assembly of threaded parts. It promotes reliable sealing of pipe threads, even at high pressure, by reducing friction and galling during tightening, resulting in higher contact pressures of the sealing surfaces and better metal-to-metal contact. It also reduces the torque needed to make pressure-tight connections and tighten fasteners

Shelf life: 2 years from manufacture date



WARNING

This product can expose you to chemicals including Lead, which is known to the State of California to cause cancer and birth defects or other reproductive harm. For more information go to www.P65Warnings.ca.gov.

Accessories

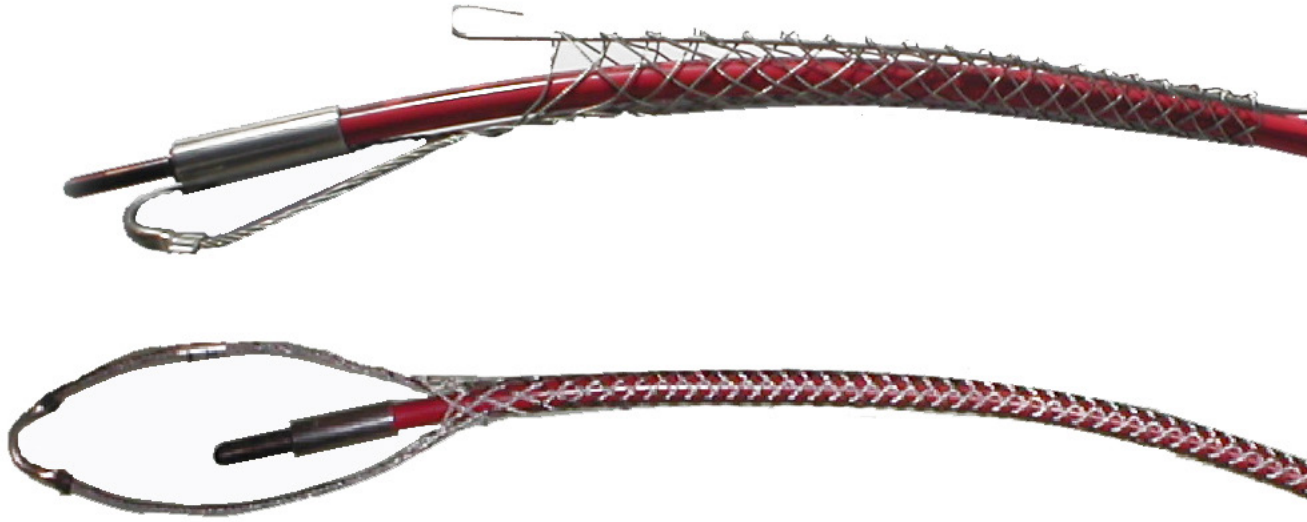

Appendix

Table Of Contents

Parker Safety Guide E-3

Offer of Sale E-7

Part Number Index E-9

Keyword Index E-11

Technical Data Index E-11



Parker Safety Guide

Parker Safety Guide for Selecting and Using Hose, Tubing, Fittings, Connectors, Conductors, Valves and Related Accessories



! Parker Safety Guide for Selecting and Using Hose, Tubing, Fittings and Related Accessories
Publication No. 4400-B.1
Revised: October 2015, Rev A

WARNING:

Failure or improper selection or improper use of hose, tubing, fittings, assemblies, valves, connectors, conductors or related accessories (“Products”) can cause death, personal injury and property damage. Possible consequences of failure or improper selection or improper use of these Products include but are not limited to:

- Fittings thrown off at high speed.
- High velocity fluid discharge.
- Explosion or burning of the conveyed fluid.
- Electrocutation from high voltage electric power lines.
- Contact with suddenly moving or falling objects that are controlled by the conveyed fluid.
- Injections by high-pressure fluid discharge.
- Dangerously whipping Hose.

- Tube or pipe burst.
- Weld joint fracture.
- Contact with conveyed fluids that may be hot, cold, toxic or otherwise injurious.
- Sparking or explosion caused by static electricity buildup or other sources of electricity.
- Sparking or explosion while spraying paint or flammable liquids.
- Injuries resulting from inhalation, ingestion or exposure to fluids.

Before selecting or using any of these Products, it is important that you read and follow the instructions below. No product from any division in Parker Fluid Connectors Group is approved for in-flight aerospace applications. For hoses and fittings used in in-flight aerospace applications, please contact Parker Aerospace Group.

1.0 GENERAL INSTRUCTIONS

1.1 Scope: This safety guide provides instructions for selecting and using (including assembling, installing, and maintaining) these Products. For convenience, all rubber and/or thermoplastic products commonly called “hose” or “tubing” are called “Hose” in this safety guide. Metallic tube or pipe are called “tube”. All assemblies made with Hose are called “Hose Assemblies”. All assemblies made with Tube are called “Tube Assemblies”.

All products commonly called “fittings”, “couplings” or “adapters” are called “Fittings”. Valves are fluid system components that control the passage of fluid. Related accessories are ancillary devices that enhance or monitor performance including crimping, flaring, flanging, presetting, bending, cutting, deburring, swaging machines, sensors, tags, lockout handles, spring guards and associated tooling. This safety guide is a supplement to and is to be used with the specific Parker publications for the specific Hose, Fittings and Related Accessories that are being considered for use. Parker publications are available at www.parker.com. SAE J1273 (www.sae.org) and ISO 17165-2 (www.ansi.org) also provide recommended practices for hydraulic Hose Assemblies, and should be followed.

1.2 Fail-Safe: Hose, Hose Assemblies, Tube, Tube Assemblies and Fittings can and do fail without warning for many reasons. Design all systems and equipment in a fail-safe mode, so that failure of the Hose, Hose Assembly, Tube, Tube Assembly or Fitting will not endanger persons or property.

1.3 Distribution: Provide a copy of this safety guide to each person responsible for selecting or using Hose, Tube and Fitting products. Do not select or use Parker Hose, Tube or Fittings without thoroughly reading and understanding this safety guide as well as the specific Parker publications for the Products.

1.4 User Responsibility: Due to the wide variety of operating conditions and applications for Hose, Tube and Fittings. Parker does not represent or warrant that any particular Hose, Tube or Fitting is suitable for any specific end use system. This safety guide does not analyze all technical parameters that must be considered in selecting a product. The user, through its own analysis and testing, is solely responsible for:

- Making the final selection of the Products.
- Assuring that the user’s requirements are met and that the application presents no health or safety hazards.
- Following the safety guide for Related Accessories and being trained to operate Related Accessories.
- Providing all appropriate health and safety warnings on the equipment on which the Products are used.
- Assuring compliance with all applicable government and industry standards.

1.5 Additional Questions: Call the appropriate Parker technical service department if you have any questions or require any additional information. See the Parker publication for the Products being considered or used, or call 1-800-CPARKER, or go to www.parker.com, for telephone numbers of the appropriate technical service department.

2.0 HOSE, TUBE & FITTINGS SELECTION INSTRUCTIONS

2.1 Electrical Conductivity: Certain applications require that the Hose be nonconductive to prevent electrical current flow. Other applications require the Hose and the Fittings and the Hose/Fitting interface to be sufficiently conductive to drain off static electricity. Extreme care must be exercised when selecting Hose, Tube and Fittings for these or any other applications in which electrical conductivity or nonconductivity is a factor.

The electrical conductivity or nonconductivity of Hose, Tube and Fittings is dependent upon many factors and may be susceptible to change. These factors include but are not limited to the various materials used to make the Hose and the Fittings, Fitting finish (some Fitting finishes are electrically conductive while others are nonconductive), manufacturing methods (including moisture control), how the Fittings contact the Hose, age and amount of deterioration or damage or other changes, moisture content of the Hose at any particular time, and other factors.

The following are considerations for electrically nonconductive and conductive Hose. For other applications consult the individual catalog pages and the appropriate industry or regulatory standards for proper selection.

2.1.1 Electrically Nonconductive Hose: Certain applications require that the Hose be nonconductive to prevent electrical current flow or to maintain electrical isolation. For applications that require Hose to be electrically nonconductive, including but not limited to applications near high voltage electric lines, only special nonconductive Hose can be used. The manufacturer of the equipment in which the nonconductive Hose is to be used must be consulted to be certain that the Hose, Tube and Fittings that are selected are proper for the application. Do not use any Parker Hose or Fittings for any such application requiring nonconductive Hose, including but not limited to applications near high voltage electric lines or dense magnetic fields, unless (i) the application is expressly approved in the Parker technical publication for the product, (ii) the Hose is marked “nonconductive”, and (iii) the manufacturer of the equipment on which the Hose is to be used specifically approves the particular Parker Hose, Tube and Fittings for such use.

2.1.2 Electrically Conductive Hose: Parker manufactures special Hose for certain applications that require electrically conductive Hose. Parker manufactures special Hose for conveying paint in airless paint spraying applications. This Hose is labeled “Electrically Conductive Airless Paint Spray Hose” on its layline and packaging. This Hose must be properly connected to the appropriate Parker Fittings and properly grounded in order to dissipate dangerous static charge buildup, which occurs in all airless paint spraying applications. Do not use any other Hose for airless paint spraying, even if electrically conductive. Use of any other Hose or failure to properly connect the Hose can cause a fire or an explosion resulting in death, personal injury, and property damage. All hoses that convey fuels must be grounded.

Parker manufactures a special Hose for certain compressed natural gas (“CNG”) applications where static electricity buildup may occur. Parker CNG Hose assemblies comply with the requirements of ANSI/IAS NGV 4.2; CSA 12.52, “Hoses for Natural Gas Vehicles and Dispensing Systems”

Parker Safety Guide pg. 2

(www.ansi.org). This Hose is labeled “Electrically Conductive for CNG Use” on its layline and packaging. This Hose must be properly connected to the appropriate Parker Fittings and properly grounded in order to dissipate dangerous static charge buildup, which occurs in, for example, high velocity CNG dispensing or transfer. Do not use any other Hose for CNG applications where static charge buildup may occur, even if electrically conductive. Use of other Hoses in CNG applications or failure to properly connect or ground this Hose can cause a fire or an explosion resulting in death, personal injury, and property damage. Care must also be taken to protect against CNG permeation through the Hose wall. See section 2.6, Permeation, for more information. Parker CNG Hose is intended for dispenser and vehicle use within the specified temperature range. Parker CNG Hose should not be used in confined spaces or unventilated areas or areas exceeding the specified temperature range. Final assemblies must be tested for leaks. CNG Hose Assemblies should be tested on a monthly basis for conductivity per ANSI/IAS NGV 4.2; CSA 12.52.

Parker manufactures special Hose for aerospace in-flight applications. Aerospace in-flight applications employing Hose to transmit fuel, lubricating fluids and hydraulic fluids require a special Hose with a conductive inner tube. This Hose for in-flight applications is available only from Parker’s Stratoflex Products Division. Do not use any other Parker Hose for in-flight applications, even if electrically conductive. Use of other Hoses for in-flight applications or failure to properly connect or ground this Hose can cause a fire or an explosion resulting in death, personal injury and property damage. These Hose assemblies for in-flight applications must meet all applicable aerospace industry, aircraft engine and aircraft requirements .

2.2 Pressure: Hose, Tube and Fitting selection must be made so that the published maximum working pressure of the Hose, Tube and Fittings are equal to or greater than the maximum system pressure. The maximum working pressure of a Hose, or Tube Assembly is the lower of the respective published maximum working pressures of the Hose, Tube and the Fittings used. Surge pressures or peak transient pressures in the system must be below the published maximum working pressure for the Hose, Tube and Fitting. Surge pressures and peak pressures can usually only be determined by sensitive electrical instrumentation that measures and indicates pressures at millisecond intervals. Mechanical pressure gauges indicate only average pressures and cannot be used to determine surge pressures or peak transient pressures. Published burst pressure ratings for Hose is for manufacturing test purposes only and is no indication that the Product can be used in applications at the burst pressure or otherwise above the published maximum recommended working pressure.

2.3 Suction: Hoses used for suction applications must be selected to insure that the Hose will withstand the vacuum and pressure of the system. Improperly selected Hose may collapse in suction application.

2.4 Temperature: Be certain that fluid and ambient temperatures, both steady and transient, do not exceed the limitations of the Hose, Tube, Fitting and Seals. Temperatures below and above the recommended limit can degrade Hose, Tube, Fittings and Seals to a point where a failure may occur and release fluid. Tube and Fittings performances are normally degraded at elevated temperature. Material compatibility can also change at temperatures outside of the rated range. Properly insulate and protect the Hose Assembly when routing near hot objects (e.g. manifolds). Do not use any Hose in any application where failure of the Hose could result in the conveyed fluids (or vapors or mist from the conveyed fluids) contacting any open flame, molten metal, or other potential fire ignition source that could cause burning or explosion of the conveyed fluids or vapors.

2.5 Fluid Compatibility: Hose, and Tube Assembly selection must assure compatibility of the Hose tube, cover, reinforcement, Tube, Plating and Seals with the fluid media used. See the fluid compatibility chart in the Parker publication for the product being considered or used. This information is offered only as a guide. Actual service life can only be determined by the end user by testing under all extreme conditions and other analysis.

Hose, and Tube that is chemically compatible with a particular fluid must be assembled using Fittings and adapters containing likewise compatible seals. Flange or flare processes can change Tube material properties that may not be compatible with certain requirements such as NACE

2.6 Permeation: Permeation (that is, seepage through the Hose or Seal) will occur from inside the Hose or Fitting to outside when Hose or Fitting is used with gases, liquid and gas fuels, and refrigerants (including but not limited to such materials as helium, diesel fuel, gasoline, natural gas, or LPG). This permeation may result in high concentrations of vapors which are potentially flammable, explosive, or toxic, and in loss of fluid. Dangerous explosions, fires, and other hazards can result when using the wrong Hose for such applications. The system designer must take into account the fact that this permeation will take place and must not use Hose or Fit-

ting if this permeation could be hazardous. The system designer must take into account all legal, government, insurance, or any other special regulations which govern the use of fuels and refrigerants. Never use a Hose or Fitting even though the fluid compatibility is acceptable without considering the potential hazardous effects that can result from permeation through the Hose or Tube Assembly. Permeation of moisture from outside the Hose or Fitting to inside the Hose or Fitting will also occur in Hose or Tube assemblies, regardless of internal pressure. If this moisture permeation would have detrimental effects (particularly, but not limited to refrigeration and air conditioning systems), incorporation of sufficient drying capacity in the system or other appropriate system safeguards should be selected and used. The sudden pressure release of highly pressurized gas could also result in Explosive Decompression failure of permeated Seals and Hoses.

2.7 Size: Transmission of power by means of pressurized fluid varies with pressure and rate of flow. The size of the components must be adequate to keep pressure losses to a minimum and avoid damage due to heat generation or excessive fluid velocity.

2.8 Routing: Attention must be given to optimum routing to minimize inherent problems (kinking or flow restriction due to Hose collapse, twisting of the Hose, proximity to hot objects or heat sources). For additional routing recommendations see SAE J1273 and ISO 17165-2. Hose Assemblies have a finite life and should be installed in a manner that allows for ease of inspection and future replacement. Hose because of its relative short life, should not be used in residential and commercial buildings inside of inaccessible walls or floors, unless specifically allowed in the product literature. Always review all product literature for proper installation and routing instructions.

2.9 Environment: Care must be taken to insure that the Hose, Tube and Fittings are either compatible with or protected from the environment (that is, surrounding conditions) to which they are exposed. Environmental conditions including but not limited to ultraviolet radiation, sunlight, heat, ozone, moisture, water, salt water, chemicals and air pollutants can cause degradation and premature failure.

2.10 Mechanical Loads: External forces can significantly reduce Hose, Tube and Fitting life or cause failure. Mechanical loads which must be considered include excessive flexing, twist, kinking, tensile or side loads, bend radius, and vibration. Use of swivel type Fittings or adapters may be required to insure no twist is put into the Hose. Use of proper Hose or Tube clamps may also be required to reduce external mechanical loads. Unusual applications may require special testing prior to Hose selection.

2.11 Physical Damage: Care must be taken to protect Hose from wear, snagging, kinking, bending smaller than minimum bend radius and cutting, any of which can cause premature Hose failure. Any Hose that has been kinked or bent to a radius smaller than the minimum bend radius, and any Hose that has been cut or is cracked or is otherwise damaged should be removed and discarded. Fittings with damages such as scratches on sealing surfaces and deformation should be replaced.

2.12 Proper End Fitting: See instructions 3.2 through 3.5. These recommendations may be substantiated by testing to industry standards such as SAE J517 for hydraulic applications, or MIL-A-5070, ASI339, or AS3517 for Hoses from Parker’s Stratoflex Products Division for aerospace applications.

2.13 Length: When determining the proper Hose or Tube length of an assembly, be aware of Hose length change due to pressure, Tube length change due to thermal expansion or contraction, and Hose or Tube and machine tolerances and movement must be considered. When routing short hose assemblies, it is recommended that the minimum free hose length is always used. Consult the hose manufacturer for their minimum free hose length recommendations. Hose assemblies should be installed in such a way that any motion or flexing occurs within the same plane.

2.14 Specifications and Standards: When selecting Hose, Tube and Fittings, government, industry, and Parker specifications and recommendations must be reviewed and followed as applicable.

2.15 Hose Cleanliness: Hose and Tube components may vary in cleanliness levels. Care must be taken to insure that the Hose and Tube Assembly selected has an adequate level of cleanliness for the application.

2.16 Fire Resistant Fluids: Some fire resistant fluids that are to be conveyed by Hose or Tube require use of the same type of Hose or Tube as used with petroleum base fluids. Some such fluids require a special Hose, Tube, Fitting and Seal, while a few fluids will not work with any Hose at all. See instructions 2.5 and 1.5. The wrong Hose, Tube, Fitting or Seal may fail after a very short service. In addition, all liquids but pure water may burn fiercely under certain conditions, and even pure water leakage may be hazardous.

2.17 Radiant Heat: Those and Seals can be heated to destruction without contact by such nearby items as hot manifolds or molten metal. The same heat source may then initiate a fire. This can occur despite the presence of cool air around the Hose or Seal. Performance of Tube and Fitting subjected to the heat could be degraded.

2.18 Welding or Brazing: When using a torch or arc welder in close proximity to hydraulic lines, the hydraulic lines should be removed or shielded with appropriate fire resistant materials. Flame or weld spatter could burn through the Hose or Seal and possibly ignite escaping fluid resulting in a catastrophic failure. Heating of plated parts, including Hose Fittings and adapters, above 450°F (232°C) such as during welding, brazing or soldering may emit deadly gases. Any elastomer seal on fittings shall be removed prior to welding or brazing, any metallic surfaces shall be protected after brazing or welding when necessary. Welding and brazing filler material shall be compatible with the Tube and Fitting that are joined.

2.19 Atomic Radiation: Atomic radiation affects all materials used in Hose and Tube assemblies. Since the long-term effects may be unknown, do not expose Hose or Tube assemblies to atomic radiation. Nuclear applications may require special Tube and Fittings.

2.20 Aerospace Applications: The only Hose, Tube and Fittings that may be used for in-flight aerospace applications are those available from Parker's Stratoflex Products Division. Do not use any other Hose or Fittings for in-flight applications. Do not use any Hose or Fittings from Parker's Stratoflex Products Division with any other Hose or Fittings, unless expressly approved in writing by the engineering manager or chief engineer of Stratoflex Products Division and verified by the user's own testing and inspection to aerospace industry standards.

2.21 Unlocking Couplings: Ball locking couplings or other Fittings with quick disconnect ability can unintentionally disconnect if they are dragged over obstructions, or if the sleeve or other disconnect member, is bumped or moved enough to cause disconnect. Threaded Fittings should be considered where there is a potential for accidental uncoupling.

3.0 HOSE AND FITTINGS ASSEMBLY AND INSTALLATION INSTRUCTIONS

3.1 Component Inspection: Prior to assembly, a careful examination of the Hose and Fittings must be performed. All components must be checked for correct style, size, catalog number, and length. The Hose must be examined for cleanliness, obstructions, blisters, cover looseness, kinks, cracks, cuts or any other visible defects. Inspect the Fitting and sealing surfaces for burrs, nicks, corrosion or other imperfections. Do NOT use any component that displays any signs of nonconformance.

3.2 Hose and Fitting Assembly: Do not assemble a Parker Fitting on a Parker Hose that is not specifically listed by Parker for that Fitting, unless authorized in writing by the engineering manager or chief engineer of the appropriate Parker division. Do not assemble a Parker Fitting on another manufacturer's Hose or a Parker Hose on another manufacturer's Fitting unless (i) the engineering manager or chief engineer of the appropriate Parker division approves the Assembly in writing or that combination is expressly approved in the appropriate Parker literature for the specific Parker product, and (ii) the user verifies the Assembly and the application through analysis and testing. For Parker Hose that does not specify a Parker Fitting, the user is solely responsible for the selection of the proper Fitting and Hose Assembly procedures. See instruction 1.4.

To prevent the possibility of problems such as leakage at the Fitting or system contamination, it is important to completely remove all debris from the cutting operation before installation of the Fittings. The Parker published instructions must be followed for assembling the Fittings on the Hose. These instructions are provided in the Parker Fitting catalog for the specific Parker Fitting being used, or by calling 1-800-CPARKER, or at www.parker.com.

3.3 Related Accessories: Do not crimp or swage any Parker Hose or Fitting with anything but the listed swage or crimp machine and dies in accordance with Parker published instructions. Do not crimp or swage another manufacturer's Fitting with a Parker crimp or swage die unless authorized in writing by the engineering manager or chief engineer of the appropriate Parker division.

3.4 Parts: Do not use any Parker Fitting part (including but not limited to socket, shell, nipple, or insert) except with the correct Parker mating parts, in accordance with Parker published instructions, unless authorized in writing by the engineering manager or chief engineer of the appropriate Parker division.

3.5 Field Attachable/Permanent: Do not reuse any field attachable Hose Fitting that has blown or pulled off a Hose. Do not reuse a Parker permanent Hose Fitting (crimped or swaged) or any part thereof. Complete Hose Assemblies may only be reused after proper inspection under section 4.0. Do not assemble Fittings to any previously used hydraulic Hose that was in service, for use in a fluid power application.

3.6 Pre-Installation Inspection: Prior to installation, a careful examination of the Hose Assembly must be performed. Inspect the Hose Assembly for any damage or defects. DO NOT use any Hose Assembly that displays any signs of nonconformance.

3.7 Minimum Bend Radius: Installation of a Hose at less than the minimum listed bend radius may significantly reduce the Hose life. Particular attention must be given to preclude sharp bending at the Hose to Fitting juncture. Any bending during installation at less than the minimum bend radius must be avoided. If any Hose is kinked during installation, the Hose must be discarded.

3.8 Twist Angle and Orientation: Hose Assembly installation must be such that relative motion of machine components does not produce twisting.

3.9 Securement: In many applications, it may be necessary to restrain, protect, or guide the Hose to protect it from damage by unnecessary flexing, pressure surges, and contact with other mechanical components. Care must be taken to insure such restraints do not introduce additional stress or wear points.

3.10 Proper Connection of Ports: Proper physical installation of the Hose Assembly requires a correctly installed port connection insuring that no twist or torque is transferred to the Hose when the Fittings are being tightened or otherwise during use.

3.11 External Damage: Proper installation is not complete without insuring that tensile loads, side loads, kinking, flattening, potential abrasion, thread damage or damage to sealing surfaces are corrected or eliminated. See instruction 2.10.

3.12 System Checkout: All air entrapment must be eliminated and the system pressurized to the maximum system pressure (at or below the Hose maximum working pressure) and checked for proper function and freedom from leaks. Personnel must stay out of potential hazardous areas while testing and using.

3.13 Routing: The Hose Assembly should be routed in such a manner so if a failure does occur, the escaping media will not cause personal injury or property damage. In addition, if fluid media comes in contact with hot surfaces, open flame or sparks, a fire or explosion may occur. See section 2.4.

3.14 Ground Fault Equipment Protection Devices (GFEPDs): WARNING! Fire and Shock Hazard. To minimize the danger of fire if the heating cable of a Multitube bundle is damaged or improperly installed, use a Ground Fault Equipment Protection Device. Electrical fault currents may be insufficient to trip a conventional circuit breaker.

For ground fault protection, the IEEE 515: (www.ansi.org) standard for heating cables recommends the use of GFEPDs with a nominal 30 milliampere trip level for "piping systems in classified areas, those areas requiring a high degree of maintenance, or which may be exposed to physical abuse or corrosive atmospheres".

4.0 TUBE AND FITTINGS ASSEMBLY AND INSTALLATION INSTRUCTIONS

4.1 Component Inspection: Prior to assembly, a careful examination of the Tube and Fittings must be performed. All components must be checked for correct style, size, material, seal, and length. Inspect the Fitting and sealing surfaces for burrs, nicks, corrosion, missing seal or other imperfections. Do NOT use any component that displays any signs of nonconformance.

4.2 Tube and Fitting Assembly: Do not assemble a Parker Fitting with a Tube that is not specifically listed by Parker for that Fitting, unless authorized in writing by the engineering manager or chief engineer of the appropriate Parker division. The Tube must meet the requirements specified to the Fitting. The Parker published instructions must be followed for assembling the Fittings to a Tube. These instructions are provided in the Parker Fitting catalog for the specific Parker Fitting being used, or by calling 1-800-CPARKER, or at www.parker.com.

4.3 Related Accessories: Do not preset or flange Parker Fitting components using another manufacturer's equipment or procedures unless authorized in writing by the engineering manager or chief engineer of the appropriate Parker division. Tube, Fitting component and tooling must be checked for correct style, size and material. Operation and maintenance of Related Accessories must be in accordance with the operation manual for the designated Accessory.

4.4 Securement: In many applications, it may be necessary to restrain, protect, or guide the Tube to protect it from damage by unnecessary flexing, pressure surges, vibration, and contact with other mechanical components. Care must be taken to insure such restraints do not introduce additional stress or wear points.

4.5 Proper Connection of Ports: Proper physical installation of the Tube Assembly requires a correctly installed port connection insuring that no torque is transferred to the Tube when the Fittings are being tightened or otherwise during use.

Parker Safety Guide pg. 4

4.6 External Damage: Proper installation is not complete without insuring that tensile loads, side loads, flattening, potential abrasion, thread damage or damage to sealing surfaces are corrected or eliminated. See instruction 2.10.

4.7 System Checkout: All air entrapment must be eliminated and the system pressurized to the maximum system pressure (at or below the Tube Assembly maximum working pressure) and checked for proper function and freedom from leaks. Personnel must stay out of potential hazardous areas while testing and using.

4.8 Routing: The Tube Assembly should be routed in such a manner so if a failure does occur, the escaping media will not cause personal injury or property damage. In addition, if fluid media comes in contact with hot surfaces, open flame or sparks, a fire or explosion may occur. See section 2.4.

5.0 HOSE AND FITTING MAINTENANCE AND REPLACEMENT INSTRUCTIONS

5.1 Even with proper selection and installation, Hose life may be significantly reduced without a continuing maintenance program. The severity of the application, risk potential from a possible Hose failure, and experience with any Hose failures in the application or in similar applications should determine the frequency of the inspection and the replacement for the Products so that Products are replaced before any failure occurs. Certain products require maintenance and inspection per industry requirements. Failure to adhere to these requirements may lead to premature failure. A maintenance program must be established and followed by the user and, at minimum, must include instructions 5.2 through 5.7

5.2 Visual Inspection Hose/Fitting: Any of the following conditions require immediate shut down and replacement of the Hose Assembly:

- Fitting slippage on Hose;
- Damaged, cracked, cut or abraded cover (any reinforcement exposed);
- Hard, stiff, heat cracked, or charred Hose;
- Cracked, damaged, or badly corroded Fittings;
- Leaks at Fitting or in Hose;
- Kinked, crushed, flattened or twisted Hose; and
- Blistered, soft, degraded, or loose cover.

5.3 Visual Inspection All Other: The following items must be tightened, repaired, corrected or replaced as required:

- Leaking port conditions;
- Excess dirt buildup;
- Worn clamps, guards or shields; and
- System fluid level, fluid type, and any air entrapment.

5.4 Functional Test: Operate the system at maximum operating pressure and check for possible malfunctions and leaks. Personnel must avoid potential hazardous areas while testing and using the system. See section 2.2.

5.5 Replacement Intervals: Hose assemblies and elastomeric seals used on Hose Fittings and adapters will eventually age, harden, wear and deteriorate under thermal cycling and compression set. Hose Assemblies and elastomeric seals should be inspected and replaced at specific replacement intervals, based on previous service life, government or industry recommendations, or when failures could result in unacceptable downtime, damage, or injury risk. See section 1.2. Hose and Fittings may be subjected to internal mechanical and/or chemical wear from the conveying fluid and may fail without warning. The user must determine the product life under such circumstances by testing. Also see section 2.5.

5.6 Hose Inspection and Failure: Hydraulic power is accomplished by utilizing high pressure fluids to transfer energy and do work. Hoses, Fittings and Hose Assemblies all contribute to this by transmitting fluids at high pressures. Fluids under pressure can be dangerous and potentially lethal and, therefore, extreme caution must be exercised when working with fluids under pressure and handling the Hoses transporting the fluids. From time to time, Hose Assemblies will fail if they are not replaced at proper time intervals. Usually these failures are the result of some form of misapplication, abuse, wear or failure to perform proper maintenance. When Hoses fail, generally the high pressure fluids inside escape in a stream which may or may not be visible to the user. Under no circumstances should the user attempt to locate the leak by “feeling” with their hands or any other part of their body. High pressure fluids can and will penetrate the skin and cause severe tissue damage and possibly loss of limb. Even seemingly minor hydraulic fluid injection injuries must be treated immediately by a physician with knowledge of the tissue damaging properties of hydraulic fluid.

If a Hose failure occurs, immediately shut down the equipment and leave the area until pressure has been completely released from the Hose Assembly. Simply shutting down the hydraulic pump may or may not eliminate the pressure in the Hose Assembly. Many times check valves, etc., are employed in a system and can cause pressure to remain in a Hose Assembly even when pumps or equipment are not operating. Tiny holes in the Hose, commonly known as pinholes, can eject small, dangerously powerful but hard to see streams of hydraulic fluid. It may take several minutes or even hours for the pressure to be relieved so that the Hose Assembly may be examined safely.

Once the pressure has been reduced to zero, the Hose Assembly may be taken off the equipment and examined. It must always be replaced if a failure has occurred. Never attempt to patch or repair a Hose Assembly that has failed. Consult the nearest Parker distributor or the appropriate Parker division for Hose Assembly replacement information.

NEVER TOUCH OR EXAMINE A FAILED HOSE ASSEMBLY UNLESS IT IS OBVIOUS THAT THE HOSE NO LONGER CONTAINS FLUID UNDER PRESSURE. THE HIGH PRESSURE FLUID IS EXTREMELY DANGEROUS AND CAN CAUSE SERIOUS AND POTENTIALLY FATAL INJURY.

5.7 Elastomeric seals: Elastomeric seals will eventually age, harden, wear and deteriorate under thermal cycling and compression set. Elastomeric seals should be inspected and replaced.

5.8 Refrigerant gases: Special care should be taken when working with refrigeration systems. Sudden escape of refrigerant gases can cause blindness if the escaping gases contact the eye and can cause freezing or other severe injuries if it contacts any other portion of the body.

5.9 Compressed natural gas (CNG): Parker CNG Hose Assemblies should be tested after installation and before use, and at least on a monthly basis per instructions provided on the Hose Assembly tag. The recommended procedure is to pressurize the Hose and check for leaks and to visually inspect the Hose for damage and to perform an electrical resistance test.

Caution: Matches, candles, open flame or other sources of ignition shall not be used for Hose inspection. Leak check solutions should be rinsed off after use.

6.0 HOSE STORAGE

6.1 Age Control: Hose and Hose Assemblies must be stored in a manner that facilitates age control and first-in and first-out usage based on manufacturing date of the Hose and Hose Assemblies. Unless otherwise specified by the manufacturer or defined by local laws and regulations:

6.1.1 The shelf life of rubber hose in bulk form or hose made from two or more materials is 28 quarters (7 years) from the date of manufacture, with an extension of 12 quarters (3 years), if stored in accordance with ISO 2230;

6.1.2 The shelf life of thermoplastic and polytetrafluoroethylene hose is considered to be unlimited;

6.1.3 Hose assemblies that pass visual inspection and proof test shall not be stored for longer than 2 years.

6.1.4 Storage: Stored Hose and Hose Assemblies must not be subjected to damage that could reduce their expected service life and must be placed in a cool, dark and dry area with the ends capped. Stored Hose and Hose Assemblies must not be exposed to temperature extremes, ozone, oils, corrosive liquids or fumes, solvents, high humidity, rodents, insects, ultraviolet light, electromagnetic fields or radioactive materials.

Offer of Sale

PARKER-HANNIFIN CORPORATION

1. Definitions. As used herein, the following terms have the meanings indicated.

"Buyer" means any customer receiving a Quote for Products.

"Buyer's Property" means any tools, patterns, plans, drawings, designs, specifications materials, equipment, or information furnished by Buyer, or which are or become Buyer's property.

"Confidential Information" means any technical, commercial, or other proprietary information of Seller, including, without limitation, pricing, technical drawings or prints and/or part lists, which has been or will be disclosed, delivered, or made available, whether directly or indirectly, to Buyer.

"Goods" means any tangible part, system or component to be supplied by Seller.

"Intellectual Property Rights" means any patents, trademarks, copyrights, trade dress, trade secrets or similar rights.

"Products" means the Goods, Services and/or Software as described in a Quote.

"Quote" means the offer or proposal made by Seller to Buyer for the supply of Products.

"Seller" means Parker-Hannifin Corporation, including all divisions, subsidiaries and businesses selling Products under these Terms.

"Seller's IP" means patents, trademarks, copyrights, or other intellectual property rights relating to the Products, including without limitation, names, designs, images, drawings, models, software, templates, information, any improvements or creations or other intellectual property developed prior to or during the relationship contemplated herein.

"Services" means any services to be provided by Seller.

"Software" means any software related to the Goods, whether embedded or separately downloaded.

"Special Tooling" means equipment acquired by Seller or otherwise owned by Seller necessary to manufacture Goods, including but not limited to tools, jigs, and fixtures.

"Terms" means the terms and conditions of this Offer of Sale.

2. Terms. All sales of Products by Seller will be governed by, and are expressly conditioned upon Buyer's assent to, these Terms. These Terms are incorporated into any Quote provided by Seller to Buyer. Buyer's order for any Products whether communicated to Seller verbally, in writing, by electronic data interface or other electronic commerce, shall constitute acceptance of these Terms. Seller objects to any contrary or additional terms or conditions of Buyer. Reference in Seller's order acknowledgement to Buyer's purchase order or purchase order number shall in no way constitute an acceptance of any of Buyer's terms or conditions of purchase. Any Quote made by Seller to Buyer shall be considered a firm and definite offer and shall not be deemed to be otherwise despite any language on the face of the Quote. Seller reserves all rights to accept or reject any purported acceptance by Buyer to Seller's Quote if such purported acceptance attempts to vary the terms of the Quote. If Seller ships Products after Buyer issues an acceptance to the Quote, any additional or different terms proposed by Buyer will not become part of the parties' business relationship unless agreed to in a writing that is signed by an authorized representative of Seller, excluding email correspondence. If the transaction proceeds without such agreement on the part of Seller, the business relationship will be governed solely by these Terms and the specific terms in Seller's Quote.

3. Price; Payment. The Products set forth in the Quote are offered for sale at the prices indicated in the Quote. Unless otherwise specifically stated in the Quote, prices are valid for thirty (30) days and do not include any sales, use, or other taxes or duties. Seller reserves the right to modify prices for any reason and at any time by giving ten (10) days prior written notice. Unless otherwise specified by Seller, all prices are F.C.A. Seller's facility (INCOTERMS 2020). All sales are contingent upon credit approval and full payment for all purchases is due thirty (30) days from the date of invoice (or such date as may be specified in the Quote). Under any circumstances, Buyer may not withhold or suspend payment of any amounts due and payable as a deduction, set-off or recoupment of any amount, claim or dispute with Seller. Unpaid invoices beyond the specified payment date incur interest at the rate of 1.5% per month or the maximum allowable rate under applicable law. Seller reserves the right to require advance payment or provision of securities for first and subsequent deliveries if there is any doubt, in Seller's sole determination, regarding the Buyer's creditworthiness or for other business reasons. If the requested advance payment or securities are not provided to Seller's satisfaction, Seller reserves the right to suspend performance or reject the purchase order, in whole or in part, without prejudice to Seller's other rights or remedies, including the right to full compensation. Seller may revoke or shorten any payment periods previously granted in Seller's sole determination. The rights and remedies herein reserved to Seller are cumulative and in addition to any other or further rights and remedies available at law or in equity. No waiver by Seller of any breach by Buyer of any provision of these terms will constitute a waiver by Seller of any other breach of such provision.

4. Shipment; Delivery; Title and Risk of Loss. All delivery dates are approximate, and Seller is not responsible for damages or additional costs resulting from any delay. All deliveries are subject to our ability to procure materials from our suppliers. Regardless of the manner of shipment, delivery occurs and title and risk of loss or damage pass to Buyer, upon placement of the Products with the carrier at Seller's facility. Unless otherwise agreed

prior to shipment and for domestic delivery locations only, Seller will select and arrange, at Buyer's sole expense, the carrier and means of delivery. When Seller selects and arranges the carrier and means of delivery, freight and insurance costs for shipment to the designated delivery location will be prepaid by Seller and added as a separate line item to the invoice. Buyer shall be responsible for any additional shipping charges incurred by Seller due to Buyer's acts or omissions. Buyer shall not return or repackage any Products without the prior written authorization from Seller, and any return shall be at the sole cost and expense of Buyer.

5. Warranty. The warranty for the Products is as follows:

(i) Goods are warranted against defects in material or workmanship for a period of twelve (12) months from the date of delivery or 2,000 hours of use, whichever occurs first; (ii) Services shall be performed in accordance with generally accepted practices and using the degree of care and skill that is ordinarily exercised and customary in the field to which the Services pertain and are warranted for a period of six (6) months from the date of completion of the Services; and (iii) Software is only warranted to perform in accordance with applicable specifications provided by Seller to Buyer for ninety (90) days from the date of delivery or, when downloaded by a Buyer or end-user, from the date of the initial download. All prices are based upon the exclusive limited warranty stated above, and upon the following disclaimer: **EXEMPTION CLAUSE; DISCLAIMER OF WARRANTY, CONDITIONS, REPRESENTATIONS; THIS WARRANTY IS THE SOLE AND ENTIRE WARRANTY, CONDITION, AND REPRESENTATION, PERTAINING TO PRODUCTS. SELLER DISCLAIMS ALL OTHER WARRANTIES, CONDITIONS, AND REPRESENTATIONS, WHETHER STATUTORY, EXPRESS OR IMPLIED, INCLUDING BUT NOT LIMITED TO THOSE RELATING TO DESIGN, NON-INFRINGEMENT, MERCHANTABILITY, AND FITNESS FOR A PARTICULAR PURPOSE. SELLER DOES NOT WARRANT THAT THE SOFTWARE IS ERROR-FREE OR FAULT-TOLERANT, OR THAT BUYER'S USE THEREOF WILL BE SECURE OR UNINTERRUPTED, UNLESS OTHERWISE AUTHORIZED IN WRITING BY SELLER, THE SOFTWARE SHALL NOT BE USED IN CONNECTION WITH HAZARDOUS OR HIGH-RISK ACTIVITIES OR ENVIRONMENTS. EXCEPT AS EXPRESSLY STATED HEREIN, ALL PRODUCTS ARE PROVIDED "AS IS".**

6. Claims; Commencement of Actions. Buyer shall promptly inspect all Products upon receipt. No claims for shortages will be allowed unless reported to Seller within ten (10) days of delivery. Buyer shall notify Seller of any alleged breach of warranty within thirty (30) days after the date the non-conformance is or should have been discovered by Buyer. Any claim or action against Seller based upon breach of contract or any other theory, including tort, negligence, or otherwise must be commenced within twelve (12) months from the date of the alleged breach or other alleged event, without regard to the date of discovery.

7. LIMITATION OF LIABILITY. IN THE EVENT OF A BREACH OF WARRANTY, SELLER WILL, AT ITS OPTION, REPAIR OR REPLACE THE NON-CONFORMING PRODUCTS, RE-PERFORM THE SERVICES, OR REFUND THE PURCHASE PRICE PAID WITHIN A REASONABLE PERIOD OF TIME. IN NO EVENT IS SELLER LIABLE FOR ANY SPECIAL, INDIRECT, INCIDENTAL OR CONSEQUENTIAL DAMAGES INCLUDING ANY LOSS OF REVENUE OR PROFITS, WHETHER BASED IN CONTRACT, TORT OR OTHER LEGAL THEORY. IN NO EVENT SHALL SELLER'S LIABILITY UNDER ANY CLAIM MADE BY BUYER EXCEED THE PURCHASE PRICE PAID FOR THE PRODUCTS.

8. Confidential Information. Buyer acknowledges and agrees that Confidential Information has been and will be received in confidence and will remain the property of Seller. Buyer further agrees that it will not use Seller's Confidential Information for any purpose other than for the benefit of Seller and shall return all such Confidential Information to Seller within thirty (30) days upon request.

9. Loss to Buyer's Property. Buyer's Property will be considered obsolete and may be destroyed by Seller after two (2) consecutive years have elapsed without Buyer ordering the Products manufactured using Buyer's Property. Also, Seller shall not be responsible for any loss or damage to Buyer's Property while it is in Seller's possession or control.

10. Special Tooling. Seller may impose a tooling charge for any Special Tooling. Special Tooling shall be and remain Seller's property. In no event will Buyer acquire any interest in the Special Tooling, even if such Special Tooling has been specially converted or adapted for manufacture of Goods for Buyer and notwithstanding any charges paid by Buyer. Unless otherwise agreed, Seller has the right to alter, discard or otherwise dispose of any Special Tooling or other property owned by Seller in its sole determination at any time.

11. Security Interest. To secure payment of all sums due from Buyer, Seller retains a security interest in all Products delivered to Buyer and, Buyer's acceptance of these Terms is deemed to be a Security Agreement under the Uniform Commercial Code. Buyer authorizes Seller as its attorney to execute and file on Buyer's behalf all documents Seller deems necessary to perfect Seller's security interest.

12. User Responsibility. Buyer, through its own analysis and testing, is solely responsible for making the final selection of the Products and assuring that all performance, endurance, maintenance, safety and warning requirements of the application of the Products are met. Buyer must analyze all aspects of the application and follow applicable industry standards, specifications, and any technical information provided with the Quote or the Products, such as Seller's instructions, guides and specifications. If Seller provides options of or for Products based upon data or specifications provided by Buyer, Buyer is responsible for determining that such data and specifications are suitable and sufficient for all applications

Offer of Sale pg. 2 PARKER-HANNIFIN CORPORATION

and reasonably foreseeable uses of the Products. In the event Buyer is not the end-user of the Products, Buyer will ensure such end-user complies with this paragraph.

13. Use of Products, Indemnity by Buyer. Buyer shall comply with all instructions, guides and specifications provided by Seller with the Quote or the Products. If Buyer uses or resells the Products in any way prohibited by Seller's instructions, guides or specifications, or Buyer otherwise fails to comply with Seller's instructions, guides and specifications, Buyer acknowledges that any such use, resale, or non-compliance is at Buyer's sole risk. Further, Buyer shall indemnify, defend, and hold Seller harmless from any losses, claims, liabilities, damages, lawsuits, judgments and costs (including attorney fees and defense costs), whether for personal injury, property damage, intellectual property infringement or any other claim, arising out of or in connection with: (a) improper selection, design, specification, application, or any misuse of Products; (b) any act or omission, negligent or otherwise, of Buyer; (c) Seller's use of Buyer's Property; (d) damage to the Products from an external cause, repair or attempted repair by anyone other than Seller, failure to follow instructions, guides and specifications provided by Seller, use with goods not provided by Seller, or opening, modifying, deconstructing, tampering with or repackaging the Products; or (e) Buyer's failure to comply with these Terms, including any legal or administrative proceedings, collection efforts, or other actions arising from or relating to such failure to comply. Seller shall not indemnify Buyer under any circumstance except as otherwise provided in these Terms.

14. Cancellations and Changes. Buyer may not cancel or modify, including but not limited to movement of delivery dates for the Products, any order for any reason except with Seller's written consent and upon terms that will indemnify, defend and hold Seller harmless against all direct, incidental and consequential loss or damage and any additional expense. Seller, at any time, may change features, specifications, designs and availability of Products.

15. Assignment. Buyer may not assign its rights or obligations without the prior written consent of Seller.

16. Force Majeure. Seller is not liable for delay or failure to perform any of its obligations by reason of any events or circumstances beyond its reasonable control. Such circumstances include without limitation: accidents, labor disputes or stoppages, government acts or orders, acts of nature, pandemics, epidemics, other widespread illness, or public health emergency, cyber related disruptions, cyber-attacks, ransomware sabotage, delays or failures in delivery from carriers or suppliers, shortages of materials, sudden increases in the price of raw material or components, shutdowns or slowdowns affecting the supply of raw materials or components, or the transportation thereof, oil shortages or oil price increases, energy crisis, energy or fuel interruption, war (whether declared or not) or the serious threat of same, riots, rebellions, acts of terrorism, embargoes, fire or any reason whether similar to the foregoing or otherwise. Seller will resume performance as soon as practicable after the event of force majeure has been removed. All delivery dates affected by an event of force majeure shall be tolled for the duration of such event of force majeure and rescheduled for mutually agreed dates as soon as practicable after the event of force majeure ceases to exist. The right to allocate capacity is in the Seller's sole discretion. An event of force majeure shall not include financial distress, insolvency, bankruptcy, or other similar conditions affecting one of the parties, affiliates and/or sub-contractors. An event of force majeure in the meaning of these Terms means any circumstances beyond Seller's control that permanently or temporarily hinders performance, even where that circumstance was already foreseen. Buyer shall not be entitled to cancel any orders following its claim of an event of force majeure.

17. Waiver and Severability. Failure to enforce any provision of these Terms will not invalidate that provision; nor will any such failure prejudice either party's right to enforce that provision in the future. Invalidation of any provision of these Terms shall not invalidate any other provision herein and, the remaining provisions will remain in full force and effect.

18. Duration. Unless otherwise stated in the Quote, any agreement governed by or arising from these Terms shall: (a) be for an initial duration of one (1) year; and (b) shall automatically renew for successive one-year terms unless terminated by Buyer with at least 180-days written notice to Seller or if Seller terminates the agreement pursuant to Section 19 of these Terms.

19. Termination. Seller may, without liability to Buyer, terminate any agreement governed by or arising from these Terms for any reason and at any time by giving Buyer thirty (30) days prior written notice. Seller may immediately terminate, in writing, if Buyer: (a) breaches any provision of these Terms, (b) becomes or is deemed insolvent, (c) appoints or has appointed a trustee, receiver or custodian for all or any part of Buyer's property, (d) files a petition for relief in bankruptcy on its own behalf, or one is filed against Buyer by a third party, (e) makes an assignment for the benefit of creditors; or (f) dissolves its business or liquidates all or a majority of its assets.

20. Ownership of Rights. Buyer agrees that (a) Seller (and/or its affiliates) owns or is the valid licensee of Seller's IP and (b) the furnishing of information, related documents or other materials by Seller to Buyer does not grant or transfer any ownership interest or license in or to Seller's IP to Buyer, unless expressly agreed in writing. Without limiting the foregoing, Seller retains ownership of all Software supplied to Buyer. In no event shall Buyer obtain any

greater right in and to the Software than a right in a license limited to the use thereof and subject to compliance with any other terms provided with the Software. Buyer further agrees that it will not, directly or through intermediaries, reverse engineer, decompile, or disassemble any Software (including firmware) comprising or contained within a Product, except and only to the extent that such activity may be expressly permitted, either by applicable law or, in the case of open source software, the applicable open source license.

21. Indemnity for Infringement of Intellectual Property Rights. Seller is not liable for infringement of any Intellectual Property Rights except as provided in this Section. Seller will defend at its expense and will pay the cost of any settlement or damages awarded in an action brought against Buyer based on a third-party claim that one or more of the Products infringes the Intellectual Property Rights of a third party in the country of delivery of the Products by Seller to Buyer. Seller's obligation to defend and indemnify Buyer is contingent on Buyer notifying Seller within ten (10) days after Buyer becomes aware of any such claim, and Seller having sole control over the defense of the claim including all negotiations for settlement or compromise. If one or more Products is subject to such a claim, Seller may, at its sole expense and option, procure for Buyer the right to continue using the Products, replace or modify the Products to render them non-infringing, or offer to accept return of the Products and refund the purchase price less a reasonable allowance for depreciation. Seller has no obligation or liability for any claim of infringement: (i) arising from information provided by Buyer (including Seller's use of Buyer's Property); or (ii) directed to any Products for which the designs are specified in whole or part by Buyer; or (iii) resulting from the modification, combination or use in a system of any Products. The foregoing provisions of this Section constitute Seller's sole and exclusive liability and Buyer's sole and exclusive remedy for claims of infringement of Intellectual Property Rights.

22. Governing Law. These Terms, the terms of any Quote, and the sale and delivery of all Products are deemed to have taken place in, and shall be governed and construed in accordance with, the laws of the State of Ohio, as applicable to contracts executed and wholly performed therein and without regard to conflicts of laws principles. Buyer irrevocably agrees and consents to the exclusive jurisdiction and venue of the courts of Cuyahoga County, Ohio with respect to any dispute, controversy or claim arising out of or relating to the sale and delivery of the Products.

23. Entire Agreement. These Terms, along with the terms set forth in the Quote, forms the entire agreement between the Buyer and Seller and constitutes the final, complete and exclusive expression of the terms of sale and purchase. In the event of a conflict between any term set forth in the Quote and these Terms, the terms set forth in the Quote shall prevail. All prior or contemporaneous written or oral agreements or negotiations with respect to the subject matter shall have no effect. No modification to these Terms will be binding on Seller unless agreed to in a writing that is signed by an authorized representative of Seller, excluding email correspondence, "clickwrap" or other purported electronic assent to different or additional terms. Sections 2-25 of these Terms shall survive termination or cancellation of any agreement governed by or arising from these Terms.

24. No 'Wrap' Agreements/No Authority to Bind. Seller's clicking any buttons or any similar action, such as clicking "I Agree" or "Confirm," to utilize Buyer's software or webpage for the placement of orders, is NOT an agreement to Buyer's Terms and Conditions. **NO EMPLOYEE, AGENT OR REPRESENTATIVE OF SELLER HAS THE AUTHORITY TO BIND SELLER BY THE ACT OF CLICKING ANY BUTTON OR SIMILAR ACTION ON BUYER'S WEBSITE OR PORTAL.**

25. Compliance with Laws. Buyer agrees to comply with all applicable laws, regulations, and industry and professional standards, including those of the United States of America, and the country or countries in which Buyer may operate, including without limitation the U.S. Foreign Corrupt Practices Act ("FCPA"), the U.S. Anti-Kickback Act ("Anti-Kickback Act"), U.S. and E.U. export control and sanctions laws ("Export Laws"), the U.S. Food Drug and Cosmetic Act ("FDCA"), and the rules and regulations promulgated by the U.S. Food and Drug Administration ("FDA"), each as currently amended. Buyer agrees to indemnify, defend, and hold harmless Seller from the consequences of any violation of such laws, regulations and standards by Buyer, its employees or agents. Buyer represents that it is familiar with all applicable provisions of the FCPA, the Anti-Kickback Act, Export Laws, the FDCA and the FDA and certifies that Buyer will adhere to the requirements thereof and not take any action that would make Seller violate such requirements. Buyer represents and agrees that Buyer will not make any payment or give anything of value, directly or indirectly, to any governmental official, foreign political party or official thereof, candidate for foreign political office, or commercial entity or person, for any improper purpose, including the purpose of influencing such person to purchase Products or otherwise benefit the business of Seller. Buyer further represents and agrees that it will not receive, use, service, transfer or ship any Products from Seller in a manner or for a purpose that violates Export Laws or would cause Seller to be in violation of Export Laws. Buyer agrees to promptly and reliably provide Seller all requested information or documents, including end-user statements and other written assurances, concerning Buyer's ongoing compliance with Export Law.

September 2022

Part Number

Part Number	Page	Part Number	Page	Part Number	Page	Part Number	Page
01D9.....	B-35	106LX-8-08C.....	A-80, A-88	1AYLX-8-06C.....	A-41	2020N-02V30.....	A-62
02D9.....	B-35	106NX-20-20.....	A-68	1AYTX-6-025W.....	A-23, A-27	2022N-04V10-P.....	A-64
02Y5.....	B-29	10K06 Cap.....	B-41	1AYTX-6-03W.....	A-24, A-28	2022N-04V15.....	A-64
02Y6.....	B-34	10KP01.....	B-37	1AYTX-6-04W.....	A-25	2022N-06V91-10K.....	A-79
1018X-2-025.....	A-65	10KP03 Plug.....	B-41	1AYTX-8-05W.....	A-29	2022N-08V91-10K.....	A-80
1018X-4-025.....	A-65	11CNX-38-20.....	A-68	1C98X-10-04C.....	A-93	2022N Tag.....	D-5
1018X-4-04.....	A-64, A-66	137E4-16-16C-411.....	A-72	1C98X-8-04C.....	A-92	206RX-4-2C.....	A-63
1018X-4-04C.....	A-64, A-66, A-82	139E3-4-4C.....	A-86	1C9BS-16-08.....	A-69	2240D-025V33-TC.....	A-23
1018X-6-04.....	A-64, A-66	139E3-8-8C-411.....	A-87	1C9BS-16-08C.....	A-33, A-69	2240D-02V33-TC.....	A-22
1018X-6-04C.....	A-64, A-66, A-82	139E4-16-16C-411...A-72, A-84	A-84	1C9CX-30-16W.....	A-50	2240D-03V33-TC.....	A-24
101BS-8-08.....	A-33, A-69	15K0101.....	B-25	1C9EX-8-02.....	A-62	2240D-04V33-TC.....	A-25
101BS-8-08C.....	A-33, A-69	15K0201.....	B-25	1C9JX-16-08W.....	A-47	2240N-48V80.....	A-131
101EX-2-012.....	A-61	15K02.....	B-37	1C9LX-12-06.....	A-41	2245D-03V33.....	A-26
101EX-4-012.....	A-61	15K0202.....	B-26	1C9LX-16-08C.....	A-80, A-89	2248D-025V32-TC.....	A-27
10K0101.....	B-25	15K0202.....	B-26	1C9NX-38-20.....	A-68	2248D-03V32-TC.....	A-28
10K0201.....	B-25	15KL02.....	B-36	1GX5X-32-24C4462-KOP2.....	A-127	2248D-05V33-TC.....	A-29
10K02.....	B-37	15KP01.....	B-37	1GXCX-20-32C3964.....	A-130	2340N-24V10.....	A-81
10K0202.....	B-26	15KT02.....	B-36	1GXCX-20-32C4542.....	A-130	2380N-025V10.....	A-65
10K0203.....	B-35	15KX02.....	B-36	1GXCX-32-32C3964.....	A-130	2380N-04V0x.....	A-66
10K0303.....	B-39	16YLX-4-03C.....	A-36	1GXCX-32-32C4542.....	A-130	2380N-04V66.....	A-30
10K0306.....	B-39	1928X-4-04C.....	A-92	1GXHV-4-8C.....	A-94	2380N-04V91.....	A-82
10K0606.....	B-39	19GE3-16-8C.....	A-87	1GXHV-7-16C.....	A-95	2380N-05V00.....	A-67
10KL02.....	B-36	19GE3-8-8C.....	A-87	1HE5X-32-24C4462-KOP2.....	A-127	2380N-05V03W.....	A-31
10KP01.....	B-37	19GE4-16-16C.....	A-73, A-84	1HE5X-48-48-FLAT.....	A-131, A-133	2380N-16V1x.....	A-83
10KT02.....	B-36	19GE4-24-16C.....	A-73, A-84	1HECX-32-32-FLAT.....	A-130	2380N-20V30.....	A-68
10KX02.....	B-36	19GE4-16-16C.....	A-95	1HELX-48-48-FLAT.....	A-132	2388N-04V13W.....	A-32
101KY-4-04.....	A-32	19GHV-16-16C.....	A-95	1HN5X-32-24C4462-KOP2.....	A-127	2388N-08V14.....	A-69
101KY-4-05.....	A-31	19GHV-8-8C.....	A-94	1HN5X-48-48.....	A-133	2388N-08V13.....	A-33
101KY-6-05.....	A-31	19ME4-16-16C.....	A-73, A-83	1HNXCX-32-32.....	A-130	2390N-025V10.....	A-85
101LX-8-08C.....	A-80	19ME4-24-16C.....	A-73, A-83	1HNLX-48-48.....	A-132	2390N-04V1x.....	A-86
101TX-1-025-PL.....	A-23	19WE3-16-8C.....	A-87	1HNTX-48-48.....	A-131	2390N-06V13.....	A-70
101TX-1-02-PL.....	A-22	19WE3-8-16C.....	A-87	1Y2LX-16-16C4462.....	A-91	2390N-08V1x.....	A-71
101TX-2-025-PL.....	A-23	19WE4-16-16C.....	A-73, A-83	1Y2LX-9-06C.....	A-41	2390N-08V1x.....	A-87
101TX-2-02-PL.....	A-22	19WE4-24-16C.....	A-73, A-83	1Y42X-4-03C...A-46, A-51, A-53	A-53	2390N-16V13.....	A-72, A-88
101TX-2-03-PL.....	A-24	1AY2X-10-05-SA.....	A-52, A-54	1Y42X-6-03.....A-46, A-51, A-53	A-53	2440D-025V37-TC.....	A-35
101TX-4-03-PL.....	A-24	1AY2X-13-05-SA.....	A-52, A-54	1Y42X-6-03C...A-46, A-51, A-53	A-53	2440D-02V37-TC.....	A-34
101TX-4-04-PL.....	A-25	1AY2X-6-03.....A-46, A-51, A-53	A-53	1Y42X-6-05.....	A-54	2440D-03V32-TC.....	A-36
101TX-4-05-PL.....	A-29	1AY2X-6-03C...A-46, A-51, A-53	A-53	1Y42X-9-03.....A-46, A-51, A-53	A-53	2440D-04V32-TC.....	A-38
101TX-6-05-PL.....	A-29	1AY2X-8-05-SA.....	A-52	1Y42X-9-03C...A-46, A-51, A-53	A-53	2440D-05V32-TC.....	A-39
1063X-6-06C.....	A-79	1AY8X-6-04.....	A-64, A-66	1Y42X-9-05.....	A-52, A-54	2440N-04V32.....	A-40
1068X-24-24C.....	A-81	1AY8X-6-04C.....	A-64, A-66, A-82, A-91	1Y42X-9-05C.....	A-52, A-54	2440N-06V32.....	A-41
1068X-4-025.....	A-65, A-85	1AYBS-11-08.....	A-33, A-69	1Y4LX-4-02.....	A-34	2440N-08V30/12.....	A-42
1068X-4-04.....	A-64, A-66	1AYBS-11-08C.....	A-33, A-69	1Y4LX-6-03C.....	A-36, A-37	2440N-08V32.....	A-42
1068X-4-04C...A-64, A-66, A-82	A-64, A-66, A-82	1AYCX-16-16.....	A-50	1Y4LX-6-04.....	A-38	2440N-08V91.....	A-89
1068X-6-04.....	A-64, A-66	1AYJX-11-08C.....	A-47	1Y4LX-9-03C.....	A-37	2440N-12V36.....	A-43
1068X-6-04C...A-64, A-66, A-82	A-64, A-66, A-82	1AYJX-16-12C.....	A-49	1YHTX-4-025-PL.....	A-27	2440N-12V91.....	A-90
1069X-4-4C.....	A-70	1AYKY-6-04C.....	A-32	1YHTX-6-03-PL.....	A-28	2440N-16V36.....	A-44
106E3-4-4C.....	A-86	1AYKY-8-05.....	A-31	201RX-2-2C.....	A-62	2440N-16V91.....	A-91
106E3-6-4C.....	A-86	1AYLX-11-08C.....	A-80, A-89	2020N-012R30.....	A-61	2440N-48V80.....	A-132
106E3-8-8C.....	A-87	1AYLX-16-12C4462.....	A-90	2448D-025V35-TC.....	A-45	2448N-04V91.....	A-92
106E4-16-16C.....	A-72, A-84	1AYLX-6-02.....	A-34	2448N-32V80.....	A-128		
106EX-4-012.....	A-61	1AYLX-6-03.....	A-37				
106HV-16-16C.....	A-94	1AYLX-6-03C.....	A-37				
106HV-8-8C.....	A-93	1AYLX-6-04.....	A-38				
106LX-16-12C4462.....	A-89	1AYLX-6-04C.....	A-38				
106LX-16-16C4462.....	A-90						

Part Number	Page	Part Number	Page	Part Number	Page	Part Number	Page
2580N-32V80.....	A-129	6AYLX-6-2AC.....	A-35, A-45	83C-9X16.....	D-5	MCGHS30-40.....	D-4
2640D-03V37.....	A-46	6AYLX-8-5C.....	A-67	83C-L24.....	D-5	MCGHS3295-SS.....	D-4
2640N-08V32.....	A-47	6AYNX-6-4C.....	A-30	AYxC Cap.....	B-10	MCGHS40-50.....	D-4
2640N-12V32.....	A-48	6C95X-25-12.....	A-48	C09-125.....	C-13	MCGHS50-60.....	D-4
2640N-12V32/12.....	A-48	6C99X-25-12C.....	A-43	C10-115.....	C-10	MHBS012.....	D-4
2640N-24V80-15K.....	A-127	6C9LX-30-16C.....	A-44	C10-116.....	C-11	MHBS016.....	D-4
2640N-48V80.....	A-133	6GX5X-32-32-TC3964.....	A-129	C10-125.....	C-12	MK022-03-039.....	D-4
2648N-12V32.....	A-49	6HB5X-41-32-TC3964-5K.....	A-128	C19-950.....	C-13	MK022-03-041.....	D-4
2648N-16V32.....	A-50	6HE5X-32-32-FLATTC.....	A-128, A-129	G214-240.....	D-5	MK022-03-042.....	D-4
2648N-32V80.....	A-130	6HN5X-32-32-TC.....	A-128	G214-245.....	D-5	MSG060.....	D-3
2740D-03V34/15.....	A-51	6HN5X-32-32-TC.....	A-129	HAHM4BM4.....	C-13	MSG2106.....	D-3
2740D-03V35.....	A-51	6HYLX-4-2AC-PL.....	A-35, A-45	HBPHM Plug.....	B-22	MTM04T.....	D-5
2840D-03V34.....	A-53	6HYLX-4-3C-PL.....	A-36	HBPLM Plug.....	B-18	PFX25-05.....	A-52
2840D-03V36/14.....	A-53	6HYLX-6-3C-PL.....	A-36	HCRV-16.....	A-94	PFX30-05.....	A-54
2TURX-4-2C.....	A-63	6HYLX-6-4C-PL.....	A-38	HCRV-8.....	A-93	PFX30-05TJ.....	A-54
5Y01.....	B-28	6HYLX-9-5C-PL.....	A-39	HP006-0.....	C-5	PVC-Blue.....	D-3
5Y5Y.....	B-16	6Y25X-16-12C-SL.....	A-48	HP006-1.....	C-5	PVC-Orange.....	D-3
5Y6Y.....	B-17	6Y2LX-12-8C.....	A-42	HP006-2.....	C-6	X6Y6.....	B-21
5YxC Cap.....	B-18	6Y2LX-9-5C.....	A-39	HP010-0.....	C-7	Y204, Y206, Y209, Y212, Y216.....	B-18
5YY5.....	B-13	6Y2LX-9-8C.....	A-42	HP010-1.....	C-7	Y2C Collar.....	B-18
5YY6.....	B-14	6Y4LX-4-2AC.....	A-35, A-45	HP010-2.....	C-8	Y2N Gland Nut.....	B-18
6019X-6-6C.....	A-71	6Y4LX-6-2AC.....	A-35, A-45	K0101.....	B-25	Y404, Y406, Y409.....	B-23
6019X-8-8C.....	A-72	6Y6Y.....	B-21	K0201.....	B-25	Y4C Collar.....	B-22
601EX-2-2C.....	A-62	6YHLX-4-02-PL.....	A-34	K0202.....	B-26	Y4N GlandNut.....	B-22
601LX-12-12C.....	A-43	6YHLX-4-2AC-PL.....	A-35, A-45	K02 Cap.....	B-37	Y501.....	B-30
601LX-16-16C.....	A-44	6YHLX-4-2AC-PL-LH.....	A-35, A-45	K0303.....	B-39	Y503.....	B-40
601LX-4-5C.....	A-67	6YHLX-4-3C-PL.....	A-36	K0306.....	B-39	Y5Y5.....	B-12
601LX-6-5.....	A-67	6YHLX-6-2AC-PL-LH.....	A-45	K0606.....	B-39	Y5Y6.....	B-15
601LX-6-5C.....	A-67	6YHLX-6-3C-PL.....	A-36	KCGLx LockingNut.....	B-23	Y5Y9.....	B-15
601NX-4-4.....	A-30	6YHLX-6-3C-PL-LH.....	A-36	KL02.....	B-36	Y603.....	B-40
6069X-8-8C.....	A-72	6YHLX-6-4C-PL.....	A-38, A-40	KP01Plug.....	B-37	Y6D9.....	B-22
606LX-16-12C.....	A-43	6YHLX-6-4C-PL-LH.....	A-38, A-40	KT02.....	B-36	Y6Y6.....	B-20
606LX-16-16C.....	A-44	6YHLX-9-5C-PL.....	A-39	KX02.....	B-36	YA01.....	B-27
606LX-6-5C.....	A-67	6YHLX-9-5C-PL-LH.....	A-39	LC-48-15000.....	D-4	YA02.....	B-26
606NX-4-4C.....	A-30	6YxC Cap.....	B-23	MBR010.....	D-3	YA03.....	B-40
606NX-6-4C.....	A-30	6YY5.....	B-14	MBR012.....	D-3	YAD9.....	B-9
65YXL-6-4C.....	A-40	6YY6.....	B-20	MBR013-BLK.....	D-3	YAxC Plug.....	B-10
6AY5X-16-12C.....	A-48	80C-9X06.....	D-5	MCG001SS.....	D-4	YAY5.....	B-9
6AY9X-11-8C.....	A-71	83C-9X04.....	D-5	MCG002SS.....	D-4	YAY6.....	B-8
6AY9X-8-6C.....	A-70	83C-9X08.....	D-5	MCG003SS.....	D-4	YAYA.....	B-8
6AYLX-11-8C.....	A-42	83C-9X16.....	D-5	MCGHS10-15.....	D-4	YAY1.....	B-10
6AYLX-16-12C.....	A-43			MCGHS15-20.....	D-4	YAY2.....	B-10
6AYLX-16-16C.....	A-44			MCGHS20-30.....	D-4		

Keyword	Page	Description	Page
API 17J	A-127	Maintenance,	
API 7K.....	A-127	Inspection, Repair"	A-98
Abrasion Cover	D-3	Black Eagle - Recommendations for Hose with Sour Gas	A-121
Accessories.....	D-1	Chemical Resistance - Thermoplastic Hose	A-10
Bend Restrictors.....	D-3	Data for Tensile Load & Weights of Polyflex Hose	A-112
Black Eagle Hose	A-96	Fitting Configurations by End Code - Hydraulic	A-59
Collapse Resistant Hose.....	A-93, A-94	Fitting Configurations by End Code - Oil & Gas.....	A-77
Coupler.....	C-5, C-7, C-10, C-11, C-12	Fitting Configurations by End Code - Waterblast.....	A-20
Couplings.....	C-1	Flow Rate & Velocity	A-7
Cover Sleeves	D-3	Gas Permeability of Plastics.....	A-9
Dies.....	D-5	Hose Construction - Black Eagle	A-97
DIN EN1829-2.....	A-22 - A-32, A-34 - A-44, A-46 - A-52, A A-55, A-69	Hose Dash Sizes	A-5
DNV Type	A-127 - A-133	Hose Installation & Maintenance	A-5
Flex Lance Hose	A-22 - A-29, A-34 - A-39, A-45	Hose Selection, Installation & Maintenance, Right/Wrong.....	A-6
High Pressure Adapters	B-19	Hose Size & Pressure Overview - Hydraulic	A-60
Hydraulic Hose.....	A-69	Hose Size & Pressure Overview - Oil Gas	A-78
ISO 13628-5	A-70, A-71, A-79 - A-84, A-86 - A-94	Hose Size & Pressure Overview - Waterblast.....	A-21
JIC Adapters.....	B-38	Hose Sizing & Nomenclature	A-4
Lifting Clamp.....	D-4	How To Select Hose	A-5
Lubricant.....	D-5	Nomenclature - Adapter	B-3 - B-5
Medium Pressure Adapters	B-11	Nomenclature - Hose	A-4
Nipple	C-6 - C-8, C-10 - C-12	Nomenclature - Quick Couplings - C Series	C-4
NPT Adapters	B-24	Nomenclature - Quick Couplings - Rogan Series	C-3
Oil & Gas Hose	A-87	Pressure Drop - Determination of Pressure Drop.....	A-8
Parkrimp 2 Dies	D-5	Recommended Tightening Procedures for Adapters.....	B-6
Polyflex Lok	A-30	Repair of Local Damage in the Outer Cover	A-115
Pressure Shield	D-4	Selection of Hose Diameter from Flow Rate	A-7
Quick Coupling Adapters	C-13	Stamped Form	A-4
Rogan	C-3	Waterblast - User Manual for the Application of Hose Assemblies for High-Pressure Water Jet Machines	A-15
SAE J517.....	A-64	Why Use Thermoplastic Hose	6
SAE J343.....	A-64		
Spring Guards.....	D-3		
Support Grip.....	D-4		
TAD00000CA.....	A-128 - A-133		
Threadmate	D-5		
Type M Adapters	B-7		
Tube Cleaning Hose.....	A-30, A-31		
Warning Tags	D-5		
Waterblast Hose	A-13		
Black Eagle - Chemical Resistance	A-108		
Black Eagle - Hose Selection	A-96		
"Black Eagle - PFDE-ES28, Rev. U: Handling,			

Hose

A

Waterblast

Hydraulic

Oil & Gas

Adapters

B

Quick Couplings

Accessories

D

Appendix

E

Parker Fluid Connectors Group

North American Divisions & Distribution Service Centers

Your complete source for quality tube fittings, hose & hose fittings, brass & composite fittings, quick-disconnect couplings, valves and assembly tools, locally available from a worldwide network of authorized distributors.

Fittings:

Available in inch and metric sizes covering SAE, BSP, DIN, GAZ, JIS and ISO thread configurations, manufactured from steel, stainless steel, brass, aluminum, nylon and thermoplastic.

Hose, Tubing and Bundles:

Available in a wide variety of sizes and materials including rubber, wire-reinforced, thermoplastic, hybrid and custom compounds.

Worldwide Availability:

Parker operates Fluid Connectors manufacturing locations and sales offices throughout North America, South America, Europe and Asia-Pacific.

For information, call toll free...

**1-800-C-PARKER
(1-800-272-7537)**

North American Divisions

Fluid System Connectors Division

Otsego, MI
phone 269 694 9411
fax 269 694 4614

Hose Products Division

Wickliffe, OH
phone 440 943 5700
fax 440 943 3129

Industrial Hose Division

Wickliffe, OH
phone 440 833 2120
fax 440 833 2230

Parflex Division

Ravenna, OH
phone 330 296 2871
fax 330 296 8433

Quick Coupling Division

Minneapolis, MN
phone 763 544 7781
fax 763 544 3418

Tube Fittings Division

Columbus, OH
phone 614 279 7070
fax 614 279 7685

Distribution Service Centers

Buena Park, CA

phone 714 522 8840
fax 714 994 1183

Conyers, GA

phone 770 929 0330
fax 770 929 0230

Louisville, KY

phone 502 937 1322
fax 502 937 4180

Portland, OR

phone 503 283 1020
fax 503 283 2201

Toledo, OH

phone 419 878 7000
fax 419 878 7001
fax 419 878 7420
(FCG Kit Operations)

Canada

Milton, ONT

phone 905 693 3000
fax 905 876 1958
(Contact Grimsby for other Service Center locations.)

Mexico

Toluca, MEX

phone (52) 722 2754 200
fax (52) 722 2722 168

