

Parker Worldwide

Europe, Middle East, Africa

AE – United Arab Emirates,
Dubai
Tel: +971 4 8127100
parker.me@parker.com

AT – Austria, St. Florian
Tel: +43 (0)7224 66201
parker.austria@parker.com

AZ – Azerbaijan, Baku
Tel: +994 50 2233 458
parker.azerbaijan@parker.com

BE/NL/LU – Benelux,
Hendrik Ido Ambacht
Tel: +31 (0)541 585 000
parker.nl@parker.com

BG – Bulgaria, Sofia
Tel: +359 2 980 1344
parker.bulgaria@parker.com

BY – Belarus, Minsk
Tel: +48 (0)22 573 24 00
parker.poland@parker.com

CH – Switzerland, Etoy
Tel: +41 (0)21 821 87 00
parker.switzerland@parker.com

CZ – Czech Republic, Klecany
Tel: +420 284 083 111
parker.czechrepublic@parker.com

DE – Germany, Kaarst
Tel: +49 (0)2131 4016 0
parker.germany@parker.com

DK – Denmark, Ballerup
Tel: +45 43 56 04 00
parker.denmark@parker.com

ES – Spain, Madrid
Tel: +34 902 330 001
parker.spain@parker.com

FI – Finland, Vantaa
Tel: +358 (0)20 753 2500
parker.finland@parker.com

FR – France, Contamine s/Arve
Tel: +33 (0)4 50 25 80 25
parker.france@parker.com

GR – Greece, Piraeus
Tel: +30 210 933 6450
parker.greece@parker.com

HU – Hungary, Budaörs
Tel: +36 23 885 470
parker.hungary@parker.com

IE – Ireland, Dublin
Tel: +353 (0)1 466 6370
parker.ireland@parker.com

IL – Israel,
Tel: +39 02 45 19 21
parker.israel@parker.com

IT – Italy, Corsico (MI)
Tel: +39 02 45 19 21
parker.italy@parker.com

KZ – Kazakhstan, Almaty
Tel: +7 7273 561 000
parker.easteurope@parker.com

NO – Norway, Asker
Tel: +47 66 75 34 00
parker.norway@parker.com

PL – Poland, Warsaw
Tel: +48 (0)22 573 24 00
parker.poland@parker.com

PT – Portugal,
Tel: +351 22 999 7360
parker.portugal@parker.com

RO – Romania, Bucharest
Tel: +40 21 252 1382
parker.romania@parker.com

RU – Russia, Moscow
Tel: +7 495 645-2156
parker.russia@parker.com

SE – Sweden, Spånga
Tel: +46 (0)8 59 79 50 00
parker.sweden@parker.com

SK – Slovakia, Banská Bystrica
Tel: +421 484 162 252
parker.slovakia@parker.com

SL – Slovenia, Novo Mesto
Tel: +386 7 337 6650
parker.slovenia@parker.com

TR – Turkey, Istanbul
Tel: +90 216 4997081
parker.turkey@parker.com

UA – Ukraine, Kiev
Tel: +48 (0)22 573 24 00
parker.poland@parker.com

UK – United Kingdom, Warwick
Tel: +44 (0)1926 317 878
parker.uk@parker.com

ZA – South Africa, Kempton Park
Tel: +27 (0)11 961 0700
parker.southafrica@parker.com

North America

CA – Canada, Milton, Ontario
Tel: +1 905 693 3000

US – USA, Cleveland
Tel: +1 216 896 3000

Asia Pacific

AU – Australia, Castle Hill
Tel: +61 (0)2-9634 7777

CN – China, Shanghai
Tel: +86 21 2899 5000

HK – Hong Kong
Tel: +852 2428 8008

IN – India, Mumbai
Tel: +91 22 6513 7081-85

JP – Japan, Tokyo
Tel: +81 (0)3 6408 3901

KR – South Korea, Seoul
Tel: +82 2 559 0400

MY – Malaysia, Shah Alam
Tel: +60 3 7849 0800

NZ – New Zealand, Mt
Wellington
Tel: +64 9 574 1744

SG – Singapore
Tel: +65 6887 6300

TH – Thailand, Bangkok
Tel: +662 186 7000

TW – Taiwan, Taipei
Tel: +886 2 2298 8987

South America

AR – Argentina, Buenos Aires
Tel: +54 3327 44 4129

BR – Brazil, Sao Jose dos
Campos
Tel: +55 800 727 5374

CL – Chile, Santiago
Tel: +56 2 623 1216

MX – Mexico, Toluca
Tel: +52 72 2275 4200

Industrial Tube Fittings Europe Technical Handbook



Industrial Tube Fittings Europe

Technical handbook/Catalogue 4100/UK



Parker's Motion & Control Technologies

At Parker, we're guided by a relentless drive to help our customers become more productive and achieve higher levels of profitability by engineering the best systems for their requirements. It means looking at customer applications from many angles to find new ways to create value. Whatever the motion and control technology need, Parker has the experience, breadth of product and global reach to consistently deliver. No company knows more about motion and control technology than Parker.

For further info call
00800 27 27 5374



Aerospace

Key Markets
Aftermarket services
Commercial transports
Engines
General & business aviation
Helicopters
Launch vehicles
Military aircraft
Missiles
Power generation
Regional transports
Unmanned aerial vehicles

Key Products
Control systems & actuation products
Engine systems & components
Fluid conveyance systems & components
Fluid metering, delivery & atomization devices
Fuel systems & components
Fuel tank inerting systems
Hydraulic systems & components
Thermal management
Wheels & brakes



Hydraulics

Key Markets
Aerial lift
Agriculture
Alternative energy
Construction machinery
Forestry
Industrial machinery
Machine tools
Marine
Material handling
Mining
Oil & gas
Power generation
Refuse vehicles
Renewable energy
Truck hydraulics
Turf equipment

Key Products
Accumulators
Cartridge valves
Electrohydraulic actuators
Human machine interfaces
Hybrid drives
Hydraulic cylinders
Hydraulic motors & pumps
Hydraulic systems
Hydraulic valves & controls
Hydrostatic steering
Integrated hydraulic circuits
Power take-offs
Power units
Rotary actuators
Sensors



Climate Control

Key Markets
Agriculture
Air conditioning
Construction Machinery
Food & beverage
Industrial machinery
Life sciences
Oil & gas
Precision cooling
Process
Refrigeration
Transportation

Key Products
Accumulators
Advanced actuators
CO₂ controls
Electronic controllers
Filter driers
Hand shut-off valves
Heat exchangers
Hose & fittings
Pressure regulating valves
Refrigerant distributors
Safety relief valves
Smart pumps
Thermostatic expansion valves



Pneumatics

Key Markets
Aerospace
Conveyor & material handling
Factory automation
Life science & medical
Machine tools
Packaging machinery
Transportation & automotive

Key Products
Air preparation
Brass fittings & valves
Manifolds
Pneumatic accessories
Pneumatic actuators & grippers
Pneumatic valves & controls
Quick disconnects
Rotary actuators
Rubber & thermoplastic hose & couplings
Structural extrusions
Thermoplastic tubing & fittings
Vacuum generators, cups & sensors



Electromechanical

Key Markets
Aerospace
Factory automation
Life science & medical
Machine tools
Packaging machinery
Paper machinery
Plastics machinery & converting
Primary metals
Semiconductor & electronics
Textile
Wire & cable

Key Products
AC/DC drives & systems
Electric actuators, gantry robots & slides
Electrohydraulic actuation systems
Electromechanical actuation systems
Human machine interface
Linear motors
Stepper motors, servo motors, drives & controls
Structural extrusions



Process Control

Key Markets
Alternative fuels
Biopharmaceuticals
Chemical & refining
Food & beverage
Marine & shipbuilding
Medical & dental
Microelectronics
Nuclear Power
Offshore oil exploration
Oil & gas
Pharmaceuticals
Power generation
Pulp & paper
Steel
Water/wastewater

Key Products
Analytical instruments
Analytical sample conditioning products & systems
Chemical injection fittings & valves
Fluoropolymer chemical delivery fittings, valves & pumps
High purity gas delivery fittings, valves, regulators & digital flow controllers
Industrial mass flow meters/controllers
Permanent no-weld tube fittings
Precision industrial regulators & flow controllers
Process control double block & bleeds
Process control fittings, valves, regulators & manifold valves



Filtration

Key Markets
Aerospace
Food & beverage
Industrial plant & equipment
Life sciences
Marine
Mobile equipment
Oil & gas
Power generation & renewable energy
Process
Transportation
Water Purification

Key Products
Analytical gas generators
Compressed air filters & dryers
Engine air, coolant, fuel & oil filtration systems
Fluid condition monitoring systems
Hydraulic & lubrication filters
Linear motors
Hydrogen, nitrogen & zero air generators
Instrumentation filters
Membrane & fiber filters
Microfiltration
Sterile air filtration
Water desalination & purification filters & systems



Sealing & Shielding

Key Markets
Aerospace
Chemical processing
Consumer
Fluid power
General industrial
Information technology
Life sciences
Microelectronics
Military
Oil & gas
Power generation
Renewable energy

Key Products
Dynamic seals
Elastomeric o-rings
Electro-medical instrument design & assembly
EMI shielding
Extruded & precision-cut, fabricated elastomeric seals
High temperature metal seals
Homogeneous & inserted elastomeric shapes
Medical device fabrication & assembly
Metal & plastic retained composite seals
Shielded optical windows
Silicone tubing & extrusions
Thermal management
Vibration dampening



Fluid & Gas Handling

Key Markets
Aerial lift
Agriculture
Bulk chemical handling
Construction machinery
Food & beverage
Fuel & gas delivery
Industrial machinery
Life sciences
Marine
Mining
Mobile
Oil & gas
Renewable energy
Transportation

Key Products
Check valves
Connectors for low pressure fluid conveyance
Deep sea umbilicals
Diagnostic equipment
Hose couplings
Industrial hose
Mooring systems & power cables
PTFE hose & tubing
Quick couplings
Rubber & thermoplastic hose
Tube fittings & adapters
Tubing & plastic fittings

ENGINEERING YOUR SUCCESS.

Tube fittings catalogue/Table of contents

| | |
|--|---------|
| Introduction | page 2 |
| Detailed table of contents | page 14 |
| Function of fittings..... | A |
| Systematic fitting selection | B |
| Performance data..... | C |
| Dimensioning..... | D |
| Tube assembly | E |
| Fitting assembly | F |
| Trouble shooting guide..... | G |
| Tooling | H |
| DIN fittings..... | I |
| O-Lok®..... | J |
| Triple-Lok®..... | K |
| Ferulok®..... | L |
| Weld fittings..... | M |
| High Pressure Hydraulic Flanges | N |
| Adapters..... | O |
| Valves | P |
| Rotary fittings | Q |
| Parker SensoControl® Diagnostic equipment..... | R |
| Tubes..... | S |
| Tube clamps | T |
| Custom Products | U |
| Alphanumerical index..... | V |

A
B
C
D
E
F
G
H
I
J
K
L
M
N
O
P
Q
R
S
T
U
V



Parker Hannifin – Professionals in System Solutions

Parker Hannifin is the world's leading manufacturer of motion and control technologies. The company develops and designs systems and precision solutions for mobile and industrial applications as well as the aerospace industry. Parker Hannifin employs around 56,000 people in 50 countries.

The Company's main business objective is to help customers achieve maximum productivity for their applications with the support of professional Parker engineers. This is achieved through innovative, top quality and reliable proprietary products. These can be delivered quickly thanks to a worldwide sales network. Parker is the consummate provider of customized system solutions.

Video



The strength of Parker

Under the umbrella of the Fluid Connectors Group Europe, Parker Hannifin brings together the connector technology of the brands Ermeto, Legris Transair, Legris Connectic, Legris Auto-line, Polyflex, ITR, Rectus, and Tema. Whether it be tube fittings, hose fittings, or hoses, Parker offers the most comprehensive range available from a single supplier.

As part of the Fluid Connectors Group Europe, High Pressure Connectors Europe (HPCE) is one of the largest businesses in Parker. The foundation stone for enduring business success was laid with the development of the Ermeto cutting ring. Nowadays, flanges, valves, tubing, measuring systems, and tube forming and pre-assembly machines, besides the classic DIN and SAE fittings, are manufactured in several locations.



Whether standard parts or application-specific special developments, the Parker product programme offers an appropriate solution for every customer requirement.

Always new product ideas

Innovations secure the future

Without new product ideas there would be no progress: Parker has an efficient product development program in the form of the Winovation Program. From the initial idea through to market readiness, every stage is checked to

exacting criteria before it moves on to the next project phase. This is how the customers are guaranteed beneficial products ready for series production, that work reliably from the first use and over the long term.

EO-2

For over 25 years, EO-2 fitting series have stood for leak-free performance with elastomer seals, long service lives thanks to above-average corrosion resistance. Significant cost and time savings thanks to higher rated pressures.

www.parker.com/eo-2

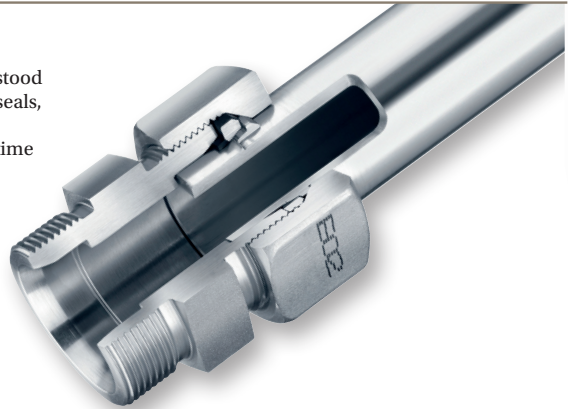

Complete Piping Solutions

Complete Piping Solutions is the high-quality complete solution for weld-free connection technology for hydraulic systems. From advising to designing and pre-assembly to delivery and installation – all with outstanding quality and reliability. Major time and cost savings.

Video



The Parflange F37 product range is a personnel and environmentally-friendly technology. In comparison to conventional welding, production times are reduced by more than half.

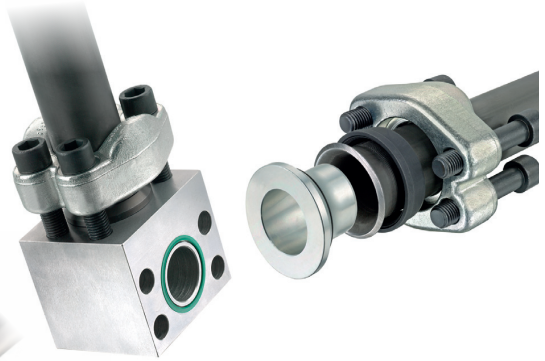

Parflange® F37

For tube and pipeline connections. Outstanding seal, high mechanical strength. For tubes from 16 to 165 mm exterior diameter, wall thickness up to 9 mm and pressures up to 420 bar.

High Performance flange

vibration-resistant. Resistant to tear-out. For mobile hydraulic and industrial applications, working pressures up to 420 bar and tube diameters from 25-88 mm. Wall thickness up to 14 mm. Flange hole pattern in accordance with ISO 6162-1, ISO 6162-2 and ISO 6154.

Video



Serviceman Plus

Mobile measurement technology for everyday use. "Plug & play" with automatic sensor recognition. Simply insert and measure. New memory concept with Nano USB stick. USB-PC interface for convenient analysis and documentation of measurements via the SensoWin software.

Serviceman Plus – Benefits in hand The Serviceman Plus is a highly robust, mobile, and easy to operate measurement device for many measurement tasks in mobile hydraulic or stationary hydraulic systems.

www.parker.com/hpce

Video

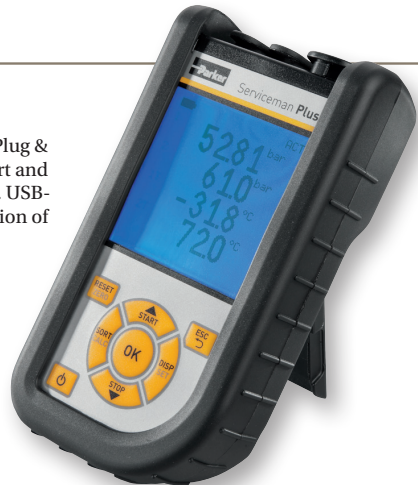

Markets make the brand

The right concepts for every need

Partnership and collaboration with customers is what makes our product policy at Parker unique. With a refined feel for the needs of users and the requirements of different markets, Parker engineers develop the solutions they need.

The result is a range of products that bear the hallmarks of consistent high quality in materials and production, and offer reliable function at a world-class level.

www.parker.com/hpce

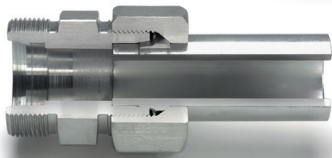

E0-PSR



The world's most widespread high-pressure fittings system: Highest pressure resistance and extreme corrosion resistance thanks to Cr(VI)-free surfaces. Perceptibly reduced tightening torques. Considerable assembly advantages.



The positively locking high-pressure form connector.

Special features - classical E0-2 sealing ring and cold-formed tubing. Impressively superior mechanical strength and maximum pull-out resistance. For 800 bar (PN) in S Series and up to 500 bar (PN) in L Series.

E02-Form

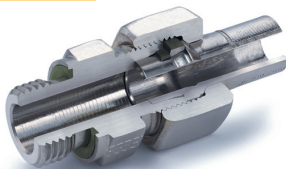

The tried and tested Dry Technology concept.

Has a large volume elastomeric seal on the tube side and Cr(VI)-free surfaces, which are very corrosion resistant. Suitable for 800 bar (PN) in S Series and up to 500 bar (PN) in the L Series.

E0-2

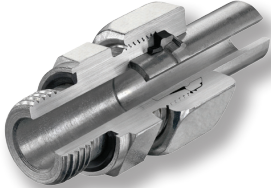

O-Lok®



Fittings series with face-side O-ring seal.

Suitable for a wide range of tube wall thicknesses, Applicable to metric and inch tubes and hose connections.



37° flare system.

The most widely used fittings system for inch tubes. For pressures up to 500 bar for smaller sizes and up to 140 bar for larger dimensions.

Triple-Lok®



The Parker Service Master Connect. Portable multi-function handheld measuring instrument.

Measures, stores, monitors and analyses pressure, temperature, flow and rotational speeds.

Multiple measurement and triggering methods. Measurement and display of more than 100 channels.



Certified products are...

CERTIFICATE

The Certification Body
of TÜV SÜD Management Service GmbH
certifies that

Parker Hannifin Manufacturing Germany GmbH & Co. KG
An ISO 9001 certified company

including the site
NIPPON KAIJI KYOKAI

has set an Environment
An audit was performed
Proof has been found

ISO 14001

This certificate is issued to
Manufacturer: **Parker Hannifin Manufacturing Germany GmbH & Co. KG**
Bielefeld, Germany

Product description: **Mechanical Joint**
Type of joint: **Flare Couplings**
Type designation: **Triple-Lok 3/4" Flare Couplings**
Approval No.: **12FV134B**
Valid until: **25 December 2022**

This certificate is subject to the conditions specified in the attached annex.
Issued at Tokyo on 16 November 2017

The Parker management of quality and environment is certified by ISO 9001, ISO/TS 16949, DIN/EN/ISO 14001 and IRIS.

CERTIFICATE OF DESIGN ASSESSMENT

This is to Certify that a representative of this Bureau dEC, at the request of
PARKER HANNIFIN MANUFACTURING GERMANY GMBH & CO. KG - D-33659 BIELEFELD

This assessment is representative of the ISO 9001 certification of the Bureau. This assessment is not intended to certify the product, but only the conformity of the product with the requirements of the ISO 9001 standard.

This certificate, by itself, does not reflect the results of the assessment nor the level of the assessment nor the level of the assessment nor the level of the assessment.

This certificate is issued to
PRODUCER: Parker Hannifin Manufacturing Germany GmbH & Co. KG
Bielefeld, Germany

DESCRIPTION: **Flare couplings used in being ISO 15774 and PFR programme exp. ISO 15774 and ISO 15774-2, 3, 4, 5, 6, 7, 8, 9, 10, 11, 12, 13, 14, 15, 16, 17, 18, 19, 20, 21, 22, 23, 24, 25, 26, 27, 28, 29, 30, 31, 32, 33, 34, 35, 36, 37, 38, 39, 40, 41, 42, 43, 44, 45, 46, 47, 48, 49, 50, 51, 52, 53, 54, 55, 56, 57, 58, 59, 60, 61, 62, 63, 64, 65, 66, 67, 68, 69, 70, 71, 72, 73, 74, 75, 76, 77, 78, 79, 80, 81, 82, 83, 84, 85, 86, 87, 88, 89, 90, 91, 92, 93, 94, 95, 96, 97, 98, 99, 100.**

TYPES: **ISO 15774 and PFR Programme Exp. ISO 15774-2, 3, 4, 5, 6, 7, 8, 9, 10, 11, 12, 13, 14, 15, 16, 17, 18, 19, 20, 21, 22, 23, 24, 25, 26, 27, 28, 29, 30, 31, 32, 33, 34, 35, 36, 37, 38, 39, 40, 41, 42, 43, 44, 45, 46, 47, 48, 49, 50, 51, 52, 53, 54, 55, 56, 57, 58, 59, 60, 61, 62, 63, 64, 65, 66, 67, 68, 69, 70, 71, 72, 73, 74, 75, 76, 77, 78, 79, 80, 81, 82, 83, 84, 85, 86, 87, 88, 89, 90, 91, 92, 93, 94, 95, 96, 97, 98, 99, 100.**

APPLICATION: **Compliance with Part 2, Clause 8.1 and 8.2 to ensure offshore and industrial piping systems are designed and constructed in accordance with ISO 15774-2, 3, 4, 5, 6, 7, 8, 9, 10, 11, 12, 13, 14, 15, 16, 17, 18, 19, 20, 21, 22, 23, 24, 25, 26, 27, 28, 29, 30, 31, 32, 33, 34, 35, 36, 37, 38, 39, 40, 41, 42, 43, 44, 45, 46, 47, 48, 49, 50, 51, 52, 53, 54, 55, 56, 57, 58, 59, 60, 61, 62, 63, 64, 65, 66, 67, 68, 69, 70, 71, 72, 73, 74, 75, 76, 77, 78, 79, 80, 81, 82, 83, 84, 85, 86, 87, 88, 89, 90, 91, 92, 93, 94, 95, 96, 97, 98, 99, 100.**

016
017
018

Page 1 / 4

Certificate number: 20200101-01
File number: ACM 15000115-4
Product name: ISO 15774

This certificate is issued to
Parker Hannifin Manufacturing Germany GmbH & Co. KG
Bielefeld, Germany

SCREW COUPLINGS
ESMETO ORIGINAL FIBRE FITTINGS EO-3 Series

NOTE: 1. VERIFIED BASIS for the Classification of Offshore Use
2. VERIFIED BASIS for the Classification of Offshore Use

This certificate will expire on 01 Mar 2021

MAU HANFANG
Bielefeld, 15 Mar 2017
TUV

...official proof for the use that Parker components satisfy the highest standards for design features, material quality and machining. When applying the product at the point of installation, approval is frequently an absolute necessity.

Whether ABS, LR or DNV, Parker products regularly pass the international and independent accreditation bodies' stringent tests. So suitability for reliable application even under the toughest conditions is officially confirmed.

Please look for approvals at www.parker.com/hpce



...of excellent quality

The manufacture of quality high-performance fitting components starts already at the ordering stage for the crack-tested primary material, which must be in accordance with Parker material specifications specially determined for product manufacture. Through the processing stages required both before and after production, those properties which will fulfil constantly increasing material requirements are guaranteed.

To ensure that the high quality of the materials used and the tube fittings made from them are guaranteed, continuous tests e.g. spectral analysis and dye penetration tests, are carried out in our own laboratories and testing facilities. The fittings systems' resistance to corrosion and static and dynamic loads are put through their paces on in-house test stands.



Top-class products result from selected materials and the most up-to-date manufacturing methods. Functionally reliable and durable. Quality pays off.

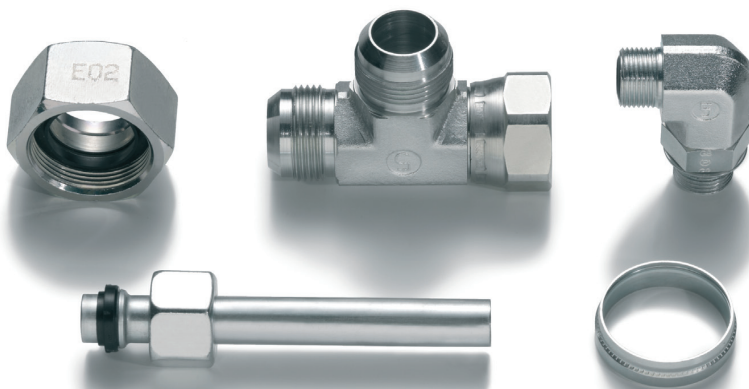



Thermal Management



The requirements for quick connect couplings for tempering and thermal management are extremely high.

is the avoidance of any fluid loss, as this is the only way to guarantee faultfree function of the installation.

Whether for applications in the area of renewable energies, for computer cooling, in transport or for industrial applications the coupling systems from Parker offer optimally tailored solutions.

Our systems stand out for their high level of compatibility with the broadest range of liquids (for example water or heat exchange oils) and the application environment.

Likewise, their resistance to mechanical stresses are vital. One of the most important requirements in the cooling of electronic systems

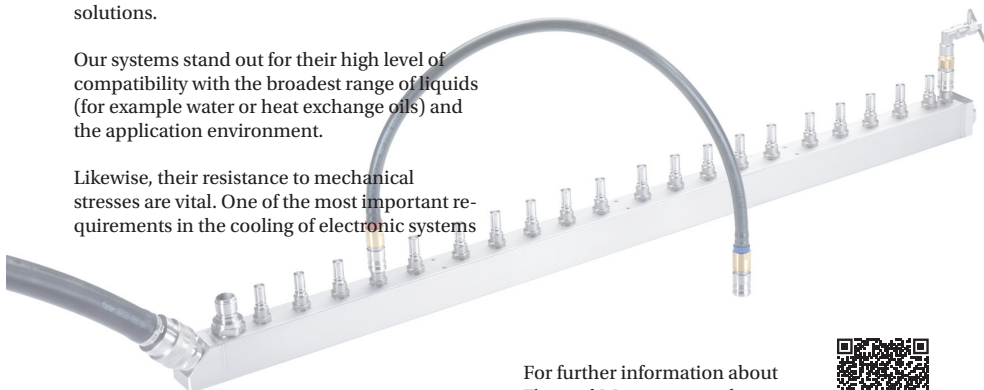

For further information about Thermal Management please see the PDF file:



Service before and after sales

To support its products, Parker offers its customers a comprehensive selection of services, i.e.

The Parker Store

Providing outstanding expert consultation, it was one of the first self-service shops for hydraulic and pneumatic fittings - and much more besides. It offers immediate manufacture of hose assemblies. Up to 3,000 items from stock.

Parker Hose Doctor

This emergency service can be reached via a toll-free hotline 24 hours a day, 7 days a week. Hose Doctor vans have fully-equipped workshops, spare parts and hydraulic oils on board. This enables the technician to rapidly replace faulty assemblies on site.

Tech Services

Together with the customer, Parker engineers assess on site the optimal operation of the equipment in question. They are present from the design stage through to installation and carry out training for operatives.

Kitting Services

Should the customer require a particular set of fittings and related items, Parker can supply these items under a single reference number as a totally complete assembly set.

Parker Logistic Services

Parker products can be supplied either directly from Parker or through a certified distributor on a just-in-time basis straight to the assembly point.

www.parkerstore.com



More than a product:
Parker offers an elaborated service to the customers.



Online: High Pressure Connectors Europe

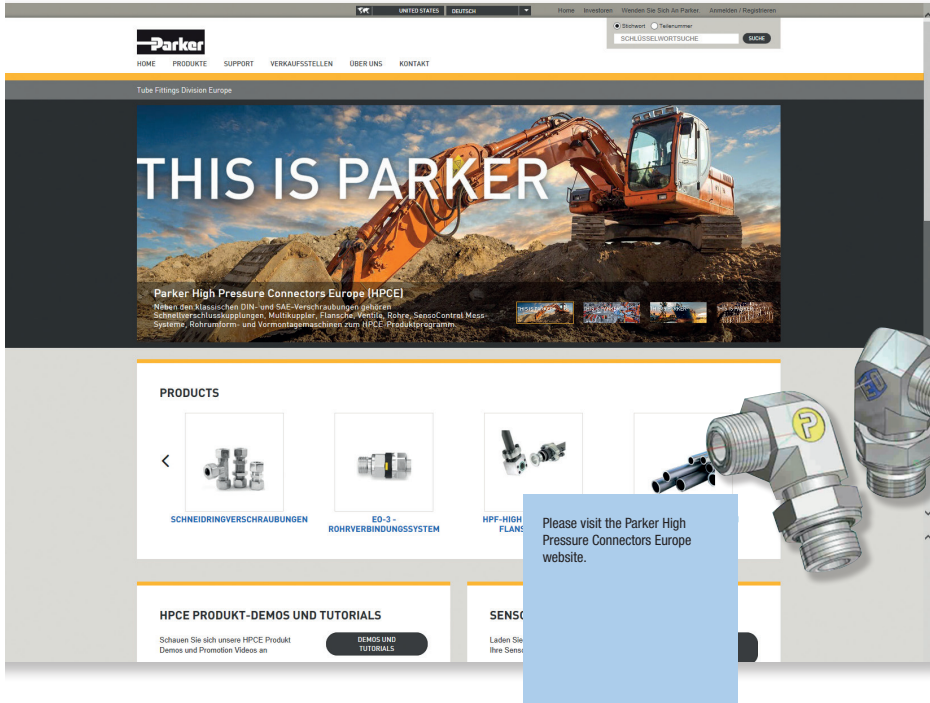

Whether it be product information, catalogues, brochures or approvals, all the information you may require can quickly be found on, and downloaded from, our website

www.parker.com/hpce

Or if in your design activities you need CAD data for any product, simply visit our website

<http://parker.partcommunity.com/portal/portal/parker>

and you can then download the relevant data after prior registration.



Detailed Table of Contents

| | | | |
|--|------------------|---|------------------|
| Function of fittings | Section A | Performance data | Section C |
| Tube Connection Systems DIN | 3 | Pressure rating | 2 |
| EO-PSR: Progressive Stop Ring for steel fittings..... | 4 | Pressure reductions and temperatures | 2 |
| EO progressive ring DPR for stainless steel fittings.... | 6 | Materials..... | 3 |
| EO-2 | 9 | Surface treatment..... | 4 |
| EO2-FORM..... | 13 | Fluid compatibility | 5 |
| EO-Weld nipple | 16 | Biodegradable oils..... | 8 |
| O-Lok®..... | 17 | Flow characteristics | 9 |
| Parflange® orbital flaring process | 20 | Flow diameter and wall thickness | 13 |
| Triple-Lok®..... | 23 | | |
| Adapters..... | 27 | Dimensioning | Section D |
| Thread configurations | 31 | Overview EO 24° cone connections..... | 3 |
| | | Not recommended | 4 |
| Systematic fitting selection | Section B | EO 24° cone end (DIN 3865/ISO 8434-1)/dimension | 4 |
| Introduction | 2 | EO 24°-DKO swivel connector (DIN 3861/DIN EN ISO 8434-4)/dimensions..... | 5 |
| Design criteria for fitting selection..... | 2 | Overview O-Lok® connections..... | 6–7 |
| Best solution..... | 2 | O-Lok® end (ISO 8434-3/SAE J1453)/dimensions..... | 8 |
| Material selection: Fitting material..... | 3 | O-Lok® swivel connector (ISO 8434-3/SAE J1453)/dimensions..... | 9 |
| Material selection: Sealing material..... | 4 | Overview Triple-Lok® connections | 10–11 |
| LL/L/S Series selection for EO fittings | 5 | Triple-Lok® end (ISO 8434-2/SAE J514)/dimensions..... | 12 |
| Tube end selection | 6–7 | Triple-Lok® swivel connector (ISO 8434-3/SAE J514)/dimensions..... | 13 |
| Flange type selection | 8 | DIN 60° cone end (DIN 7631)/dimensions | 14 |
| Port/Stud selection..... | 9–11 | Adapter 60° cone end (ISO/DIS 8434-6)/dimensions..... | 15 |
| Orientable fitting selection..... | 12–13 | NPSM Swivel adapters (SAE J516)/dimensions | 16 |
| Standardization | 14 | Male stud ends/ Port end dimensions for tube fittings..... | 17–19 |
| Approvals | 14 | | |
| Tube Specifications | 15–16 | | |
| Fitting selection summary | 17 | | |
| Dry technology versus traditional technology | 17–20 | | |

Contents

Detailed Table of Contents

| | | | |
|--|------------------|---|-------|
| Tube assembly | Section E | EO-KARRYFORM | 25 |
| Fitting assembly | Section F | WorkCenter for EO2-FORM high pressure tube connections | 28–30 |
| Trouble shooting guide | Section G | Flaring tools for Triple-Lok® tubes | 31 |
| Tooling | Section H | Flaring tool selection guide | 31 |
| Parker tube fabricating equipment | 4 | Manual flaring tools for Triple-Lok® tubes | 32 |
| Manual assembly tools for EO/EO-2 | 5 | Combination impact flarer 1004 for small dimension metric tube | 32 |
| VOMO – Pre-assembly tools for EO/EO-2 tube connections | 5 | Combination impact flarer 210A for small dimension inch tube | 32 |
| KONU – Cone-template for tools VOMO/MOK/MOSI | 6 | Impact flaring tools for metric and inch tube | 33 |
| Selection guide: | | KARRYFLARE Portable flaring device for Triple-Lok® | 34 |
| Checking equipment for EO assembly | 6 | Parflare ECO mobile flaring machine for Triple-Lok® hydraulic fittings | 35–36 |
| Distance Gauge for Assembly AKL | 7 | 37° flaring tools for KARRYFLARE device and Parflare ECO, EOMAT UNI, II and III | 37 |
| Manual assembly devices for EO/EO-2 tube connections | 8 | Assembly machines for O-Lok® and Triple-Lok® | 38 |
| Machine selection guide | 8 | Parflange® machine selection guide | 38 |
| HVM-B Pre-assembly tool | 9–10 | Parflange® 1025 workshop machine for O-Lok® and Triple-Lok® | 39–40 |
| EO-KARRYMAT portable pre-assembly device for EO tube connections | 11 | Parflange® 50 WorkCenter | 41 |
| Assembly machines for EO/EO-2 and Triple-Lok® | 12 | Parflange® 50 Basic WorkCenter | 42 |
| Machine selection guide | 12 | Parflange® 50 Pro WorkCenter | 43 |
| EOMAT ECO Mobile assembly machine for EO-2 and PSR hydraulic fittings | 13–14 | Parflange® 50 Ordering | 44 |
| EOMAT UNI Assembly and flaring machine | 15–18 | Tooling for Parflange® machines | 45 |
| EO PSR/DPR and EO-2 assembly tools for EOMAT/EO-KARRYMAT | 19 | Parflange® tool identification | 46 |
| Ferulok assembly tools for EOMAT/EO-KARRYMAT | 20 | Parflange® tools for O-Lok® | 47 |
| EOMAT PRO – Economic assembly machine for EO-2 and progressive ring fittings | 21–22 | Parflange® tools for Triple-Lok® | 48 |
| Assembly tools for EO fittings | 23 | Lubricants | 49 |
| The WorkCenter F3 | 24 | EO-NIROMONT lubricant for fitting assembly | 49 |
| The WorkCenter PRO22 | 24 | Cutting and bending tools | 50 |
| | | AV 6/42 – Tube saw square | 50 |
| | | BAV 6/12 – Combined tube bending and cutting tool | 51 |
| | | In-Ex tube deburring tool | 51 |
| | | BV 6/18 – Tube bending tool | 52 |

Detailed Table of Contents

| | | | |
|---|------------------|--|------------------|
| BV 20/25 – Tube bending tool..... | 53 | Weld fittings | Section M |
| Par-Lok wrench | 54 | Contents..... | 2 |
| WZK – Tool boxes | 55 | High Pressure Hydraulic Flanges | Section N |
| O-ring assembly tools | 56 | Introduction | 4 |
| Corg O-ring installation tool for O-Lok® | 56 | Design and construction | 4 |
| O-ring pick for O-Lok® | 56 | Methods of connection | 5 |
| Port cutting tools..... | 57 | How flange connections work..... | 6 |
| Counterbore tools and thread taps for metric ports..... | 57 | Assembly of flanges | 7 |
| Counterbore tools and thread taps for straight SAE thread ports..... | 57 | Bolt torques for SAE flanges | 8 |
| Operation of port cutting tools..... | 58 | Technical data | 9 |
| Thread identification..... | 59 | Order codes bolts and O-rings..... | 10 |
| Thread identification kit..... | 59 | Features, advantages and benefits | 11 |
| Portboard | 59 | How to order | 12 |
| HPCE sample case..... | 60 | Visual index | 13 |
| DIN fittings | Section I | SAE Flange clamps | 16 |
| Contents..... | 2–5 | SAE Flange adapters | |
| How to order | 6 | EO 24° cone end | 21 |
| How to order EO fittings | 7 | BSPP 60° cone end..... | 25 |
| Codes for fittings/styles shapes | 8–9 | Male NPT thread | 27 |
| O-Lok® | Section J | O-Lok® ORFS end..... | 28 |
| Contents..... | 2–3 | Triple-Lok® 37° flare end | 31 |
| How to order O-Lok® fittings | 4 | Butt weld end | 34 |
| Triple-Lok® | Section K | Socket weld end..... | 39 |
| Contents..... | 2–3 | SAE Full flanges | |
| How to order Triple-Lok® fittings | 4 | Female BSPP thread | 42 |
| Ferulok® | Section L | Female NPT thread..... | 46 |
| Contents..... | 2–3 | EO 24° cone end | 49 |
| How to order Ferulok® fittings | 4 | BSPP 60° cone end..... | 51 |
| | | Triple-Lok® 37° flare end | 53 |
| | | O-Lok® ORFS end..... | 55 |
| | | Butt weld end | 57 |
| | | Socket weld end..... | 60 |
| | | Complete flange connections | 64 |

Contents

Detailed Table of Contents

| | | | |
|--|------------------|--|------------------|
| SAE Flange accessories | 67 | Acc. to DIN EN 10216-5, DIN 10305-1 | 13 |
| Gear pump flanges | | Seamless EO tube bends 90° | |
| EO 24° cone end | 75 | Material E235N (St. 37.4) and 1.4571 | 14 |
| O-Lok® ORFS end | 78 | | |
| Male/Female BSPP thread | 80 | Tube clamps | Section T |
| Socket weld end | 82 | Contents | 2 |
| Special pump size flanges | 83 | Technical data | 3 |
| Aluminium flanges | 86 | Material properties | 4 |
| ISO 6164 Square flanges | 88 | Special materials | 5 |
| | | Assembly instruction | 6 |
| Adapters | Section O | Series A Light series (DIN 3015-1) | 8 |
| Contents | 2-3 | Series B Double series (DIN 3015-3) | 24 |
| | | Series C Heavy series (DIN 3015-2) | 29 |
| Valves | Section P | Multiclamps | 38 |
| Contents | 2-7 | Hydraulic steel clamps | 46 |
| | | Tube clamps with Elastomer inlay | 48 |
| Rotary fittings | Section Q | Fixed adaptor | 51 |
| Contents | 2 | | |
| | | Custom Products | Section U |
| Parker SensoControl® | Section R | | |
| Contents | 2 | Alphanumerical index | Section V |
| | | | |
| Tubes | Section S | | |
| General recommendations for tubes | 3 | | |
| Seamless EO steel tubes | | | |
| Material E235+N / St. 37.4 (1.0308) | | | |
| Acc. to DIN EN 10305-4 | 8-9 | | |
| Seamless EO steel tubes | | | |
| Material E355+N / St. 52.4 (1.0580) | | | |
| Acc. to DIN EN 10305-4 | 10 | | |
| Seamless EO stainless steel tubes | | | |
| Material 316Ti (1.4571) | | | |
| Acc. to DIN EN 10216/5, DIN EN 10305-1 | 11 | | |
| Seamless EO stainless steel tubes | | | |
| Material 316L (1.4404) | | | |
| Acc. to ASTM A269/A213, DIN EN 10305-4 | 12 | | |
| Seamless EO stainless steel tubes | | | |
| Material 316L (1.4404) | | | |



Function of fittings

Function of fittings



Index

| | |
|---|-----|
| Tube Connection Systems DIN | A3 |
| EO-PSR: Progressive Stop Ring for steel fittings | A4 |
| EO progressive ring DPR for stainless steel fittings..... | A6 |
| EO-2 | A9 |
| EO2-FORM..... | A13 |
| EO-Weld nipple | A16 |
| O-Lok® | A17 |
| Parflange® orbital flaring process | A20 |
| Triple-Lok® | A23 |
| Adapters..... | A27 |
| Thread configurations | A31 |

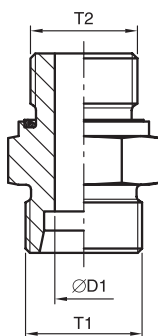
Function of fittings

1) Weld nipple for steel and stainless steel EO-DUR fittings, series L + S

- Excellent leakage free performance due to elastomeric sealing element
- Low requirements on tube quality

2) E02-FORM Soft sealed tube forming system for steel and stainless steel EO-DUR fittings, series L + S

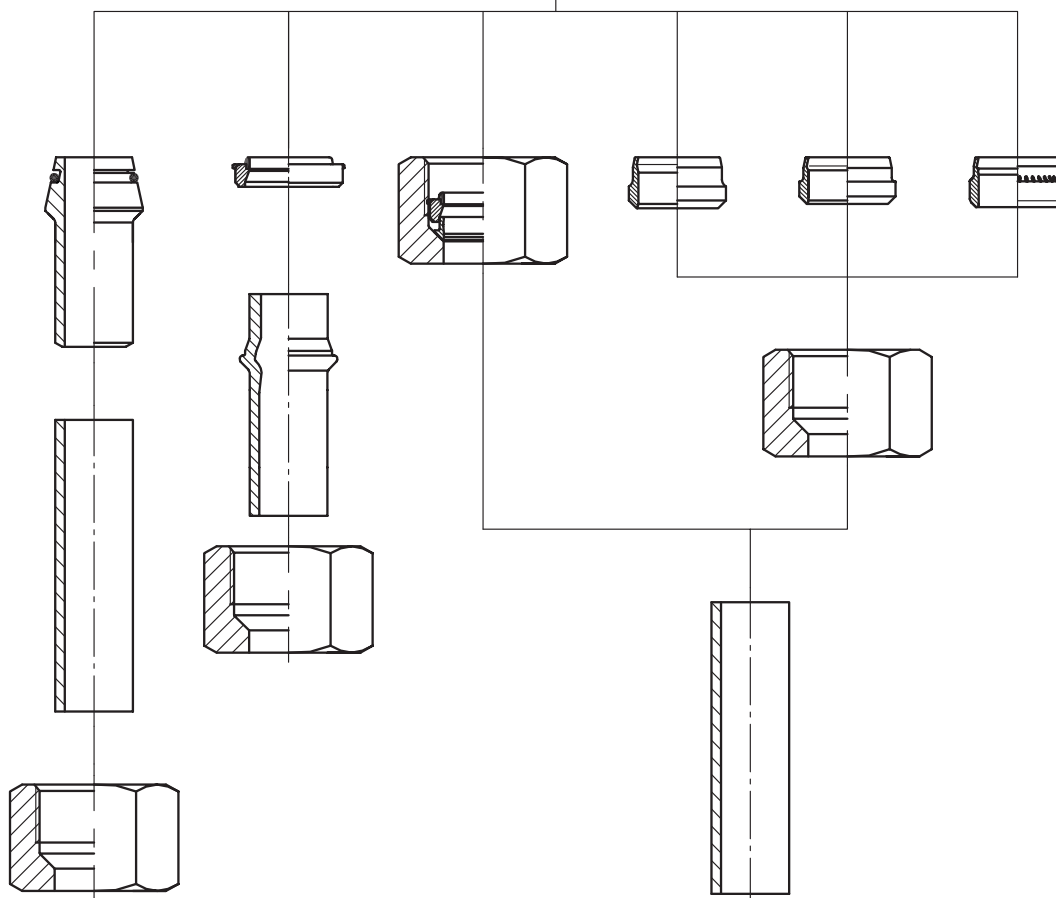
- Based on E0-2: Optimal leak free performance due to replaceable elastomeric sealing element
- Cutting ring free – best possible alternative to welding for applications, where form closing connections are required
- Assembly-proof – reduction of error sources due to machined pre-assembly/tube forming

3) E0-2 Soft sealed bite-type system for steel and stainless steel EO-DUR fittings, series L + S

- Optimal leak free performance due to elastomeric sealing element
- Easy assembly "on block" – also directly in fitting body
- Safety due to clear assembly check
- Replaceable sealing element

4) Cutting ring for steel and stainless steel EO-DUR fittings, series LL, as well as brass fittings, series L + S

- For decades approved cutting ring
- Tube clamping to transfer vibration and to protect the tube within the cutting area
- Spring effect – no settlement of the nut

5) DPR EO-progressive ring for stainless steel EO-DUR fittings, series L + S

- Especially adjusted to the requirements of stainless steel
- Optional in "SPH" finish – thereby despite of hardening no loss of corrosion resistance

6) E0-PSR Progressive Stop Ring for steel fittings, series L + S

- 2 cutting edges for optimal holding function and tear-off protection
- Over-assembly protection due to clear noticeable increase in force and stop shape
- Tube clamping to transfer vibration and to protect the tube within the cutting area

Function of fittings

EO-PSR: Progressive Stop Ring for steel fittings

Introduction

The worldwide well-established high-pressure-fitting system is characterized by the highest pressure, Cr(VI)-free surface treatment with significantly higher corrosion resistance, and considerably reduced tightening torques.

The ingenious invention of the cutting ring system was made by the founder of Parker Ermeto in the late nineteen twenties. In 1934, this idea was patented and today it is just as useful as it was on the very first day. Considering the range of applications, quality, reliability and functional safety, the principle of the Parker's cutting ring fitting has been a leading system up to today.

Of course, this has only been possible by continuously adapting the original invention from 1934 to the practical requirements of state of the art technology. Thus, the first Parker Ermeto cutting ring has little left in common with the latest multifunctional EO-PSR cutting ring, the heart of EO-PSR.

The EO-PSR fitting meets the requirements of modern hydraulic systems. This is especially true for applications where the systems are exposed to extremely high loads.

EO-PSR is designed for metric tube and based on German Standards DIN 3861 and DIN 2353, which today are represented by the international standard ISO 8434-1. EO-PSR is available in "L"- and "S"-Series.

The EO-PSR (Progressive Stop Ring) is available for the steel fitting range. For stainless steel applications, the Progressive ring DPR 71 is used and the Cutting ring for brass fittings and series LL.

EO-PSR fitting features

The EO-PSR fitting produces high pressure, leak free connection of tubes and components in hydraulic systems. The basic function of EO-PSR is the controlled progressive bite of the EO-PSR into the tube due to a unique internal geometry.

The front cutting edge (A) has already started cutting into the tube before the second cutting edge (B) begins. As soon as both cutting edges have cut into the tube to the designed depth further advance is limited by the stop shape (C) and the new overtightening protection (D). Additionally, the special form of the EO-PSR with its dimples at the front shoulder section gives an assembly state control.

Owing to the design of both cutting edges and stop shape all forces arising are equally distributed. This distribution along with the specially designed interior collar (E) of the ring guarantees increased safety, particularly with regard to vibration and flexure stresses. Service vibration loading is not present in the areas of the tubing where the bite is made.

The stop shape as well as the overtightening protection cause a clear sharp increase in tightening forces. After assembly, a visible collar (F) of cut tube material must completely fill the space in front of the first cutting edge. A slight bowing up of the ring (G) is desirable. This spring effect provides permanent compensation for flexural vibration and settling effects in the thread of the fitting nuts.

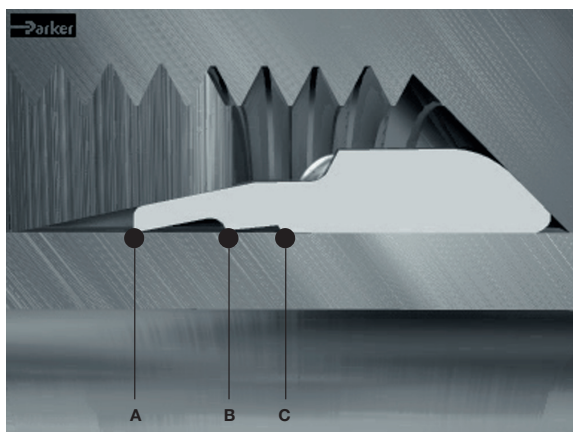

Before tightening the nut

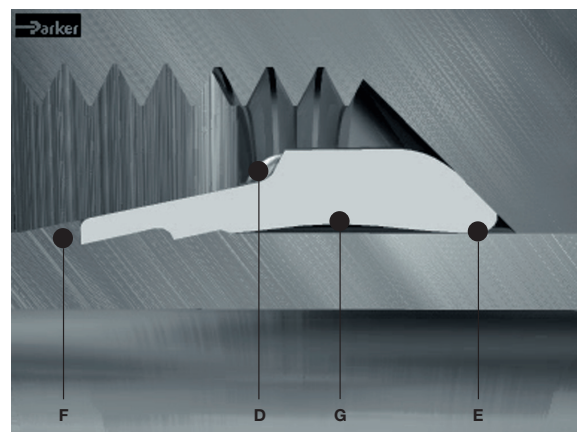

After tightening the nut



Assembly

Assembly process is according to the EO-Progressive ring instruction. The design allows a 100%-pre-assembly for an easier final assembly.

Features, advantages and benefits of EO-PSR fittings

- **High corrosion resistance** – The Cr(VI)-free surface treatment causes an average corrosion resistance of more than 500 hours to white rust.
- **High pressure** – Due to the application of even better materials combined with the special processing of individual components, EO-PSR can be used in applications of up to 800 bar (S series) and 500 bar (L series). EO-PSR considerably exceeds the DIN/ISO requirements and guarantees a 4-fold design factor. Thanks to the higher pressure levels, less expensive “L” series fittings can now be used instead of the heavier “S” series, which also is of benefit in limited or tight space applications.
- **EO-LUB** – Due to the special treatment of the larger sized nuts by the EO-LUB procedure (25S/28L and larger), the tightening torques of EO-PSR fittings have been reduced by 25%. This makes assembly easier and prevents underassembly, the most common reason for tube fitting failure.
- **Safe assembly** – Two distinctive cutting edges provide a progressive increase of the tightening torque of the EO-PSR. The noticeable end point of assembly contributes to maximum safety of assembly, and the multifunctional ring geometry prevents over-tightening.
- **Overtightening protection** – The special geometry of the EO-PSR prevents the overassembly of EO-PSR fittings.
- **Spring effect** – Thanks to the spring effect, re-tightening of the fitting is not necessary. Upon the completion of the assembly (due to the geometry, material and heat treatment) an elastic initial tension is achieved which compensates displacement effects in the thread and at the bite point of the tube.
- **Cr(VI)-free** – Due to its Cr(VI)-free treated surface, Parker Ermeto meets the requirements of the automotive industry which prohibits the use of Cr(VI) since 2007. The removal of Cr(VI) reflects Parker’s ongoing commitment to an environmentally clean and safe production process.
- **Worldwide availability** – EO-PSR is available worldwide and meets the requirements of the applicable standards for 24° cutting ring fittings. The multifunctional EO-PSR can be used with all types, series and dimensions of the wide range of EO-PSR fittings.



The multifunctional EO-PSR



Classical application of the EO-PSR: Cranes

Function of fittings

EO-DUR Progressive Ring DPR for stainless steel fittings

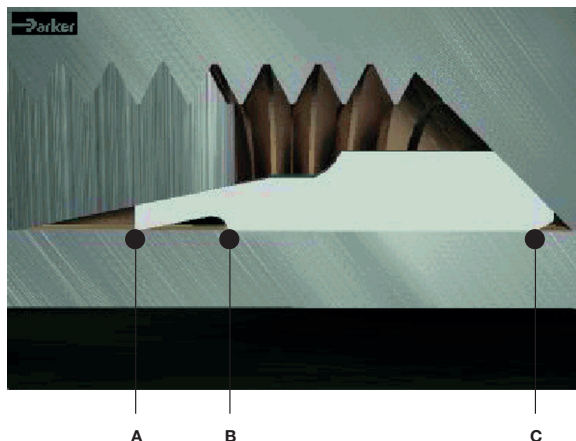

Before tightening the nut

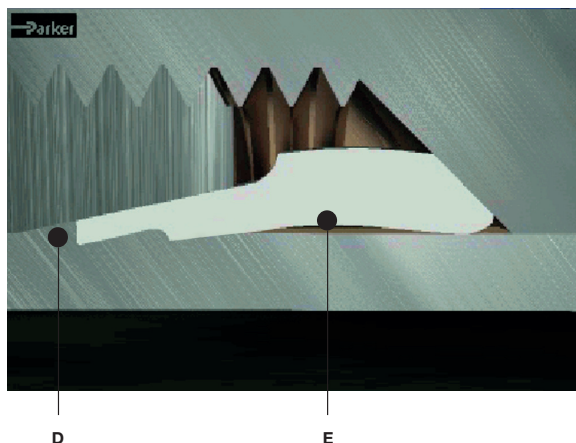

After tightening the nut

The proper assembly result is achieved by 1½ turns of the nut.

The function of the EO stainless steel progressive ring fitting

The EO progressive ring fitting produces a low to high pressure, leak free connection of tubes and components in hydraulic systems. The basic function of the EO progressive ring is the controlled progressive bite of the ring into the tube due to its unique internal geometry. The design of the EO-DUR stainless steel progressive ring is based on three essential functions.

The front cutting edge (A) has already started cutting into the tube before the second cutting edge (B) starts. As soon as both cutting edges have cut into the tube to the designed depth further advance is limited.

Owing to the design of both cutting edges all forces arising are equally distributed. This distribution along with the specially designed interior collar (C) of the ring

guarantees increased safety, particularly with regard to vibration and flexure stresses. The design and function of the cutting ring ensure that service vibration loading is not present in the areas of the tubing where the bite is made.

After assembly, a visible collar (D) of cut tube material must completely fill the space in front of the first cutting edge. With stainless steel tube and standpipe hose connections, the collar is smaller due to the harder material.

A slight bowing up of the ring (E) is desirable while this happens. This spring effect provides permanent compensation for flexural vibration and setting effects in the thread of the fitting nuts.

All EO-DUR stainless steel fittings show a special progressive ring design for best performance with stainless steel tubes. LL – series fittings and all brass fittings are equipped with a single bite “D”-ring.

The spring effect

$$\textcircled{1} + \textcircled{2} + \textcircled{3} = 1\frac{1}{2} \text{ } \curvearrowright$$

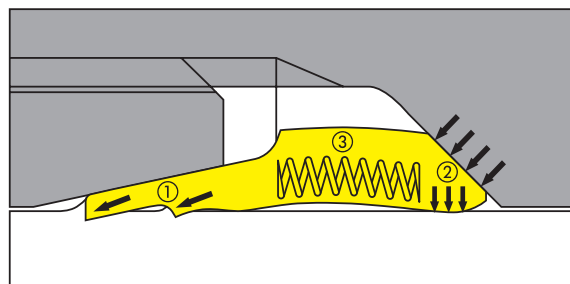

The 3 vital effects of Progressive-Ring assembly: sealing (1), tube clamping (2), spring effect (3).

During assembly of the EO progressive ring fitting, three essential functions are achieved:

① Tube bite

The tube bite guarantees the leak free sealing and ensures the necessary holding power for high operating pressures. After assembly, a collar of cut tube material in front of the cutting edge is the visible control for the proper function of the connection.

② Tube clamping

The rear section of the progressive ring is designed for clamping the tube firmly. This ensures that service vibration loading is not present in the tube bite area.

③ Spring effect

Towards the end of assembly, the special EO progres-



sive ring design, material and heat treatment allow a defined elastic deformation of the ring. This spring effect compensates subsidences of tube bite and threads, thus ensuring long term leakfree performance without retightening.

EO-DUR stainless steel products with silver plated threads

All threads of the EO-DUR stainless steel nuts are surface treated to reduce the tightening-torques by 40 % compared to non treated products. The treatment also avoids galling of the threads. Nuts larger than size 12S/15L are delivered with silver plated threads, all smaller sizes are treated with a special wax.

The EO-DUR Supercased SPH cutting ring

On the basis of the proven progressive ring design, the supercased stainless steel bite-type ring has been developed especially for aggressive internal and external media. The special geometry and thermochemical hardening process guarantee a permanently leak-proof and corrosion-resistant connection under extreme conditions. Typical applications are in the food, chemical and medical industries as well as in process engineering.

Common features, advantages and benefits of the EO Bite type system

- **Field assembly** – EO progressive ring fittings can be assembled anywhere with just a couple of wrenches. For stainless steel tube simple presetting tools are available. No additional equipment or machine is required.
- **Low cost assembly** – Using an EOMAT machine is the most economic method to preassemble EO rings onto tube ends. Whereas the actual preassembly process only takes some 1.4 seconds on the EOMAT, the total “floor-to-floor” time averages around 15 seconds.
- **3 series** – Very Light (LL), Light (L) and Heavy (S) series can be individually selected. For each application there is a solution for best flow rate, sufficient pressure resistance, smallest envelope size, low assembly force and minimum fitting cost.
- **Available sizes** – Most EO fittings are available in 25 sizes from 4 to 42 mm tube OD. Additional reducers allow optimum dimensioning of each individual fluid line. This saves space and material costs.
- **Tube wall** – EO fittings are suitable for use with light wall, medium wall, heavy wall, and extra heavy wall tubing. Light wall tube may require support sleeve (VH). Usage of VH, see chapter E.

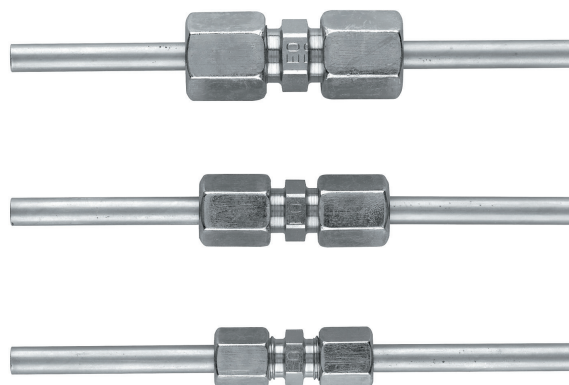

Top to bottom: EO Heavy (S), Light (L) and Very Light (LL) series:
Best choice for each individual application
(Illustration: Straight union 6 mm tube OD)

- **Tube material** – Even plastic tubes such as nylon, polyurethane, chlorinated polyvinyl chloride (PVC) or Polytetrafluoroethylene (PTFE) can be easily connected by using additional support sleeves E.
- **Visible bite** – The critical ring to tube front bite is clearly visible to tube fitters & inspectors. The presence of the recommended bite virtually eliminates any risk of catastrophic blow-off. This is a very important safety feature.
- **Reduced torque** – All nuts of EO-fittings are coated with a highly effective lubricant. Reduced assembly effort helps to prevent underassembly which is the most common reason for bite type fitting failure.
- **Sealing capability** – EO fittings have demonstrated a remarkable ability to remain leak free under various service conditions ranging from sealing high vacuum and small molecule gases to high pressure hydraulic fluids.
- **Distributed stresses** – Stresses due to flexural loading in service are distributed at several points in the joint, thus stress concentration in the bite is minimised.
- **Vibration control** – The rear bevel of the ring firmly grips tubing, thus dampening the effects of system vibration in the joint.
- **Envelope size** – EO fittings are comparatively small and compact, making them a suitable selection for tube connections in limited or tight spaces.
- **Temperature rating** – EO fittings are suitable for sub zero through elevated temperature applications. Service temperature rating is limited by the material chosen.



Function of fittings

- **Compatibility** – Since EO fittings can be manufactured from a wide range of metals, compatibility factor with various fluids and atmospheric conditions is extensive.
- **Manufacture** – EO fittings are manufactured under tight quality controls which ensures that the product routinely satisfies or surpasses the requirements of the pertinent military and industrial standards. All manufacturing locations are ISO 9001 certified.
- **Silver plated nuts** – Stainless steel tube nuts are pre-lubricated with silver plated threads (size 15L – 42L, 12S – 38S). The threads of smaller sized stainless steel nuts are waxed. Thread galling is eliminated and assembly torque is reduced by as much as 40 percent. The EO-DUR treatment increases the speed and efficiency of stainless steel fitting assembly.
- **Tube length determination** – Exact tube length and bending can easily be checked by just trying out before assembly. This makes on-site piping very efficient.
- **Broad range of configurations** – EO fittings are available in more than 50 configurations. Especially for orientable fittings there is a wide variety of banjos, adjustable elbows or swivel combinations that allow an optimum solution for each application.
- **Functional fittings** – A variety of rotary fittings, non-return valves, Shut-off valves and test point connectors are available with the original EO-joint. This greatly reduces assembly time and cost of additional fittings and also eliminates possible leak paths.
- **True metric design** – EO fittings are designed to metric standards. All threads, hexagons, bores and other dimensions are purely metric.
- **No restrictions** – All bores of each fitting fit the inner diameter of the matching tube. LL, L and S-Series fittings are designed for best flow rate with thin, medium and heavy wall tube. Therefore, best performance without excessive noise or heat generation is always guaranteed.
- **World wide popularity** – The bite type fitting has worldwide acceptance. Most European, Asian, African and South American industry standards are purely metric. But also in Australia and Northern America DIN bite type fittings are gaining acceptance due to the metrification and end user specifications. Many machine operators prefer fittings that can be assembled without any additional equipment.



EO-2

Introduction

The common feature of all EO-2 fittings is elastomeric seals on all joints. These are also now available in FKM for applications with higher temperatures or aggressive media. This assures leak free operation without retightening – even under extreme working conditions. The easy handling, time and cost saving features, and many assembly advantages of the unique EO-2 functional nuts have made EO-2 fittings increasingly popular.

EO-2 is designed for metric tube and based on German Standards DIN 3861 and DIN 2353, which today are represented by the international standard ISO 8434-1. EO-2 is available in “LL”, “L”- and “S”-Series.

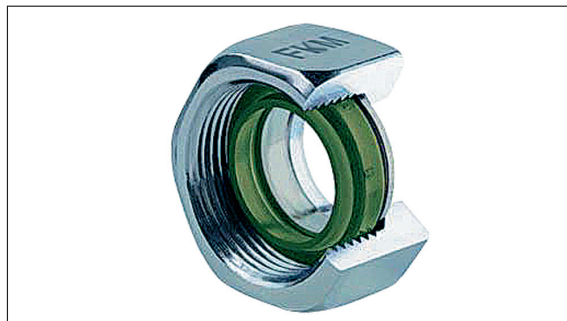

The Cr(VI) free EO-2 functional nut also with FKM sealing ring. Easy to handle and fast to assemble.

Function of the EO-2 fitting system

Elastomeric sealing

The elastomeric seal assures a hermetically sealed tube joint. It is located between the inner cone of the fitting body and the tube surface, thus blocking the only possible leak path. Due to its large cross-section, the seal effectively compensates for all manufacturing tolerances on tube and fitting cone.

The sealing effect is pressure supported which makes the EO-2 fitting suitable for high pressure applications. The static compression also eliminates air-ingress into the fluid system at vacuum conditions.

Elastomerically sealed EO-2 fittings do not require any retightening even in heavy duty applications. Seal extrusion is prevented by proper housing without gaps or dead volume. The sealing lip is bonded to a metallic support ring.

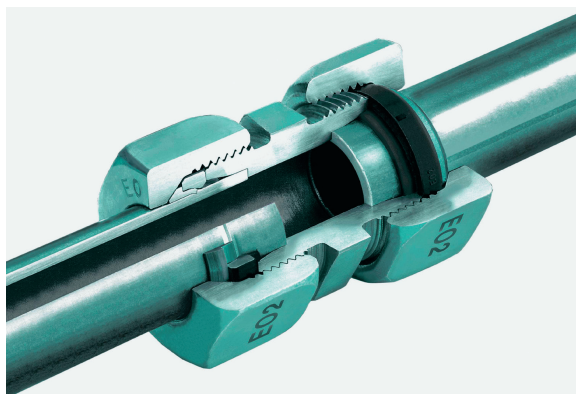

EO-2: Safe dry – clean – leakfree

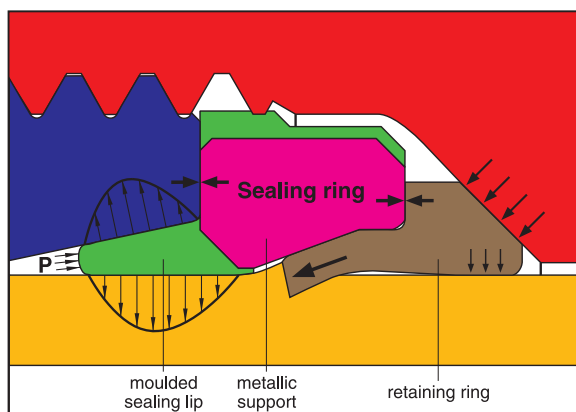

The metallic support of the sealing ring acts just like an integrated pre-assembly tool.

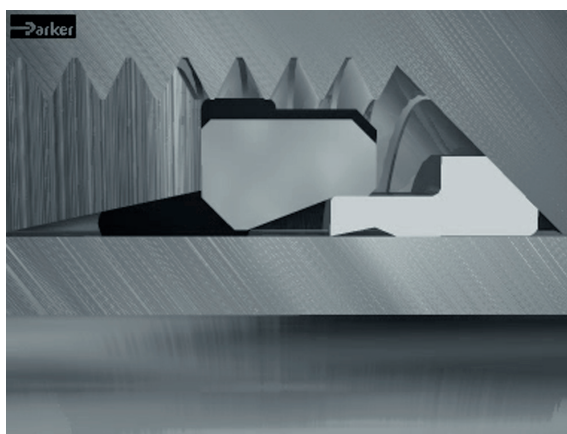

Before tightening the nut



Function of fittings

Assembly “to block”

The retaining ring bites into the tube in accordance to the proven bite ring principle. The support ring reduces the danger of over- or underassembly by a special EO-2 design feature: Before assembly there is a gap in between the flat surfaces of the retaining ring and the metallic support ring of the seal. As soon as the retaining ring has reached the proper bite depth, the gap closes, resulting in a sharp increase of assembly torque. This results in uniform and reliable fitting assemblies. The assembly result can easily be inspected by just checking if the gap is closed.

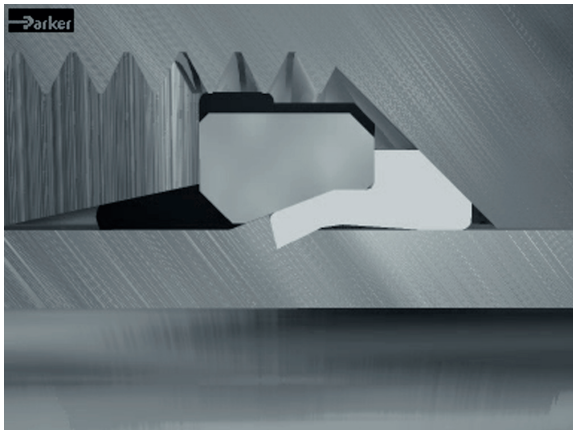

After tightening the nut

Closing the gap at the end of assembly provides a clear “Hit-Home-Feel”.

The separation of sealing and fixing function to two separate elements finally allows a more effective solution of the over- and undertightening problems of bite type fittings than increasing the number of cutting edges.

Integrated assembly tool

The metallic support ring of the seal is made of a special design, material and heat-treatment to act as an assembly tool. This makes sure that the retaining ring securely cuts into the tube surface without damaging the sensitive inner cone of the fitting body.

This unique feature of EO-2 fittings even allows direct assembly of stainless steel tube without any additional pre-assembly process. An EOMAT machine can be used to allow easy assembly of large dimension tube and drastically save total assembly time, effort and costs.

The integrated assembly tool of EO-2 fittings even helps to save further costs and trouble when using an EOMAT-type presetting machine:

As the presetting cone is only in contact with the elasto-

meric sealing lip, it cannot be worn out or damaged even after thousands of assemblies. This does not only save replacement costs but also avoids leakage problems caused by worn presetting tools.

The functional nut

The unique functional nut simplifies handling of fitting components and helps to minimise storage and procurement costs. The sealing and retaining rings are combined as a pair and are inserted into the internal thread of the nut in such a manner that they cannot fall out, so that these three parts form one functional element.

Individual components such as seals or retaining rings cannot be forgotten, confused or assembled in the wrong orientation. Time and cost is saved arranging the components to make up individual joints.

The functional nuts match all EO tube fitting joints. After assembly and disassembly, the sealing ring can be replaced individually without cutting off the tube end.

Common features, advantages and benefits of the EO-2 fitting system

- **High corrosion resistance** – The Cr(VI)-free surface treatment causes an average corrosion resistance of more than 500 hours to white rust.
- **Increased pressure** – Due to the application of even better materials combined with the special processing of individual components, EO-2 can be used in applications of up to 800 bar (S series) and 500 bar (L series). EO-2 considerably exceeds the DIN/ISO requirements and guarantees a 4-fold design factor. Thanks to the higher pressure levels, less expensive “L” series fittings can now be used instead of the heavier “S” series, which also is of benefit in limited or tight space applications.
- **EO-LUB** – Due to the special treatment of the larger sized nuts by the EO-LUB procedure (25S/28L and larger), the tightening torques of EO-2 fittings have been reduced by 25%. This makes assembly easier and prevents underassembly, the most common reason for tube fitting failure.
- **Cr(VI)-free** – Due to its Cr(VI)-free treated surface, Parker Ermeto now meets the requirements to be expected in the automotive industry and the expected requirements issued by the European Parliament to eliminate the use of materials and surfaces containing Cr(VI). The removal of Cr(VI) reflects Parker’s ongoing commitment to an environmentally clean and safe production process.



- **Worldwide availability** – EO-2 is available worldwide and meets the requirements of the applicable standards for 24° cutting ring fittings.
- **Sealing capability** – An elastomeric seal forms the primary sealing element, thus assuring leakfree sealing. Even low-viscosity media such as water or gas are hermetically sealed. Hydraulic systems therefore do not “sweat” at fittings.
- **Durability** – The elastomeric seal does not require any retightening even after years of operation under extreme working conditions.

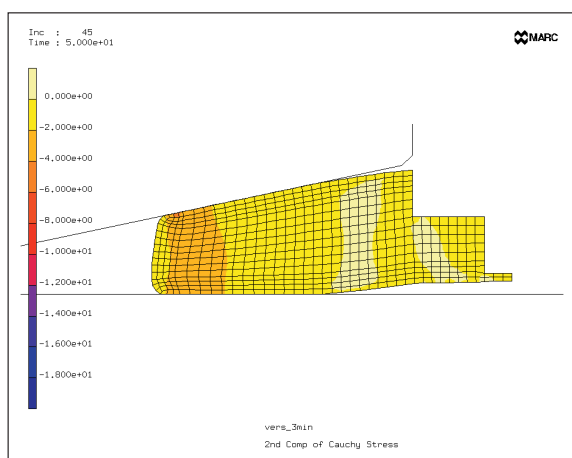

FEM (Finite Element Method) has been used to optimize the seal design (Picture: FES, Raiffeisenstr. 10a, D-74343 Sachsenheim).

- **Bite control** – The ideal bite depth is controlled by the fitting design rather than by the fitters force. Closing the gap at the end of manual assembly, the fitts gets a clear signal that setting is completed and the joint is ready for inspection.
- **Functional nut** – Individual components such as the retaining ring or seal cannot be lost, forgotten, confused or assembled in the wrong orientation. This dramatically saves assembly cost and helps to avoid dangerous assembly errors.
- **Assembly cost** – With less than 10 seconds cycle time on the EOMAT (actual presetting process: 1.4 seconds) the cost of presetting EO-2 is extremely low.
- **Integrated preassembly tool** – Each EO-2 functional nut comes assembled with an integrated assembly tool that makes sure that the retaining ring securely cuts into the tube surface without damaging the sensitive inner cone of the fitting body. This greatly reduces the danger of tube blow-off, even when using stainless steel tube.
- **Reliable repeatability** – When EOMAT machines are used for cost-efficient presetting, the preassembly tools do not wear out as they are only in contact with the rubber seal. This avoids leaks and dangerous blow-off which can result when traditional bite-type fittings are assembled using worn presetting tools.
- **Final assembly** – From the wrench-tight position of the preset EO-2 joint, one short pull on the wrench (approx. 1/6 to 1/4 turn) gives the assembly a quick high rise to required torque. EO-2 fittings have a solid “Hit-home-feel” and excellent over-torque resistance.
- **Visible inspection** – There is no doubt if an EO-2 functional nut has been preset correctly or not. Inspection is as simple as checking if the gap between retaining ring and sealing ring is completely closed. The tube end does not have to be disassembled out of the fitting for bite inspection.
- **No phantom leaks** – Lubrication is not mandatory for the assembly of steel EO-2 fittings. The machine operator will not be irritated about lubricant coming out of the fittings once the hydraulic system gets hot.
- **Reusability/Remakeability** – EO-2 fittings can be disassembled and reassembled many times. There is no wear or widening of the vulnerable inner cone. Damaged seals can easily be replaced. All spare DOZ-seals are marked by size-code (e.g.: 12-L).
- **On-Site-Maintenance** – For the maintenance and replacement of EO-2 fittings a set of wrenches is sufficient. Additional in – line – components, such as test points (GMA), ball valves (KH) or Tee-fittings can be added to an existing assembly within minutes.
- **Interchangeability** – The EO-2 functional nut can be used for the whole variety of the broad range of more than 50 configurations in some 25 sizes of standard EO LL, L and S-series fittings. Changeover from progressive ring or weld nipple is easy by the simple use of EO-2 functional nuts.
- **Reliability** – Millions of EO-2 fittings are working trouble free in applications like: Mobile Construction equipment, stationary machine tools, hydraulic presses, plastic injection moulding machines, shipbuilding, offshore exploration, submarines, railway trains and military equipment. Leakage does not occur on EO-2 pipework.
- **Trouble-free** – Regular bite type fittings allow typical assembly-errors such as: confusion of bite type ring material and size. Also, the use of worn-out preassembly tool may result in fitting failure. The clever EO-2 design does not allow most of these mistakes without making the assembly process more complicated.

Function of fittings

- **Popularity** – EO-2 fittings are as easy to assemble as traditional bite type fittings, but they eliminate most of their typical assembly problems. EO-2 fittings are therefore appreciated by an increasing number of original

equipment manufactures. EO-2 also has become the fitting of choice of end-users that appreciate the leak-free performance, the easy maintenance and the global availability of the metric soft-seal bite type system.

Suitable FM-type

| | Steel tube | Stainless tube | Plastic tube |
|-------------------------------------|------------|----------------|--------------|
| Steel fittings body (EO-2) | FM...CF | FM...SSA | FM...CF |
| Stainless steel fitting body (EO-2) | — | FM...71 | FM...71 |



EO-2 fittings are used for heavy-duty applications, such as construction equipment or plastic injection molding.

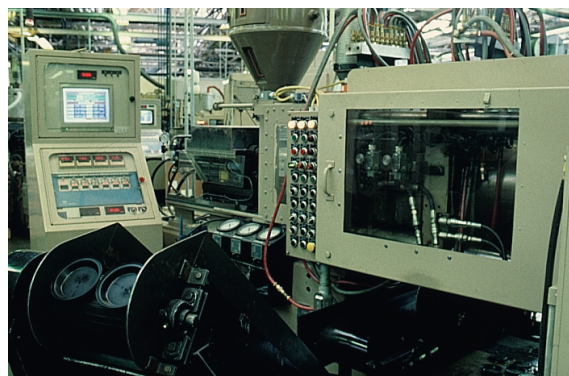

Every day millions of EO-2 fittings perform absolutely trouble-free.



EO2-FORM

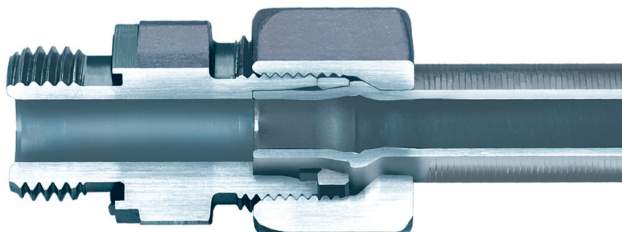

Introduction

EO2-FORM is the high pressure formed tube Generation of the High Pressure Connectors Europe division. As with EO-2, it is designed in to eliminate leakage in all fluid systems, by using elastomeric sealing systems.

The common feature of all EO2-FORM connections are the EO-2 seal elements as well as the new cold forming process, that gives extreme rigidity and low tightening torques. The seals are also available in FKM for applications with higher temperatures or aggressive media.

Through EO2-FORM, elastomeric sealing technology is made available even where bite-type connectors are not popular, like in hydraulic presses, cranes, lifts or ship canal locks. Compared to welding or brazing, the EO2-FORM process is faster and easier. It does not require special tube treatment, heating or chemicals.

EO2-FORM is designed for metric tube and fully interchangeable to the complete Ermeto Original product range according to ISO 8434-1/DIN 2353. EO2-FORM is available in "L"- and "S"-Series.

Function of EO2-FORM

EO-2/EO2-FORM system

EO2-FORM is not a stand-alone product. It has been developed as an extension of the proven EO-2 system product range. All EO2-FORM components like nuts, seals

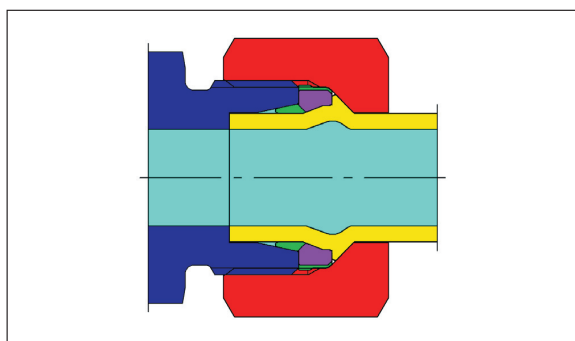

The EO2-FORM connection:
Extreme rigidity and low tightening torques



The EO2-FORM F3 machine

and fitting bodies come from the EO-2 program. The only investment needed is the forming machine, which pays off quickly as it reduces assembly time and effort. Assembly characteristics of EO2-FORM are similar to EO-2 too. This allows the customer to use both products for his hydraulic pipework without increasing stock or confusing workflow engineers with new components.

Elastomeric sealing

For EO2-FORM, the same sealing ring "DOZ" is used as for EO-2. The high volume elastomeric seal assures a hermetically sealed tube joint. It is located between the inner cone of the fitting body and the tube surface, thus blocking the only possible leak path. Due to its large cross

Function of fittings

The EO2-FORM process

Tube end is prepared and equipped with EO nut

Tube is inserted into the tools until it firmly touches the stop at the end

After starting the process, the dies clamp the tube and the forming pin starts to move forward

While moving, the pin is continuously forming the tube wall and compressing the material

The tool shape defines the outer contour of the formed tube wall

The inner contour also gets slightly deformed but remains smooth and unrestricted for good flow characteristics

As soon as the moving pin touches the clamping jaws, the forming process is completed

The tube end is released and ready for attaching the EO-2 seal

Installation is made in the fitting body

section, the seal effectively compensates for all manufacturing tolerances between the tube and fitting cone.

The sealing effect is pressure supported which makes the EO2-FORM fitting ideal for high pressure applications. The static compression also eliminates air-ingress into the fluid system in vacuum conditions.

Elastomerically sealed EO2-FORM fittings do not require any retightening even in heavy-duty applications. Seal extrusion is prevented by proper housing without gaps or dead volume areas. The sealing lip is bonded to a metallic support ring.

Cold-formed tube

The cold-forming of the tube is carried out by the EO2-FORM machine. Machine operation and tool setup are optimised for short cycle times, which makes the process

easy and fast. The tube is connected when the sealing ring is fixed and the nut is tightened.

The working contact area of the EO2-FORM connection is the flat front surface of the metallic support ring which is made of heat-treated, high-strength steel. This provides superior mechanical strength without settling, loosening or need for re-tightening.

Features, advantages and benefits of the EO2-FORM fitting system

- **System solution** – No additional items need to be purchased or stocked on top of the existing EO-2 product range. Assembly characteristics of EO2-FORM are similar to EO-2.

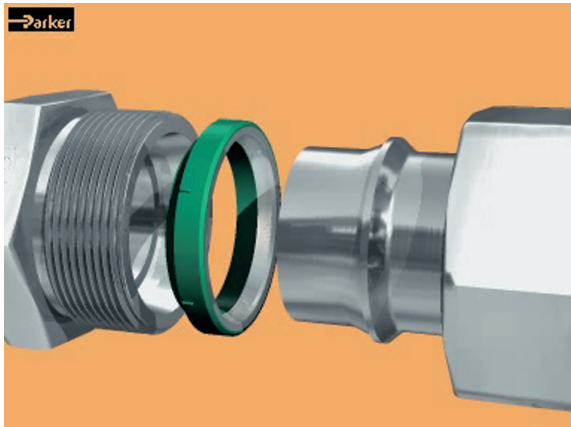

Before tightening the nut

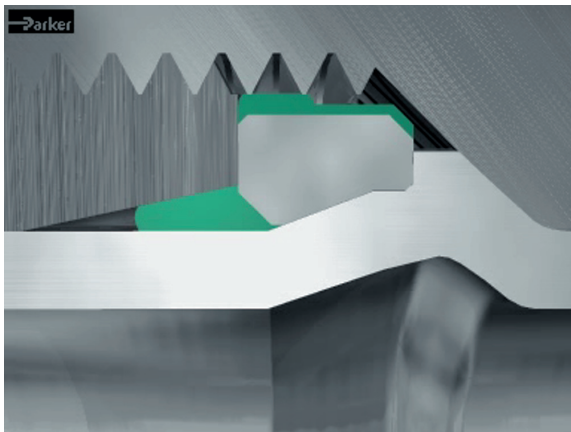

After tightening the nut

- Flexible concept** – The product family of EO-2 and EO2-FORM allows the application of the optimum product within a complex hydraulic system or a whole manufacturing facility. EO2-FORM can be used for heavy duty applications like presses, EO-2 is ideal for general hydraulic and pneumatic pipework. This allows maximum total system performance with minimum component, assembly and stocking cost.
- No risk** – EO2-FORM technology is based on the proven EO-2 technology. All components and the assembly technology are approved. The customer does not have to test a new system.
- High pressure performance** – Due to the application of even better materials combined with the special processing of individual components, EO2-FORM can be used in applications of up to 800 bar (S series) and 500 bar (L series). EO2-FORM considerably exceeds the DIN/ISO requirements and guarantees a 4-fold design factor. Thanks to the higher pressure levels, less
 - expensive “L” series fittings can now be used instead of the heavier “S” series, which also is a benefit in limited or tight space applications.
- Sealing capability** – The high volume elastomeric seal forms the primary sealing element, thus assuring leak-free sealing. Even low-viscosity media such as water or gas are hermetically sealed. Hydraulic systems therefore do not “sweat” at the fitting joints.
- No phantom leaks** – Lubrication is not mandatory for the assembly of steel EO weld nipples. The machine operator will not be irritated about lubricant coming out of the fittings once the hydraulic system gets hot.
- Universal** – The EO2-FORM machine can cold-form all common steel tubes used in hydraulic systems (the EO2-FORM process also allows the use of stainless steel and exotic materials such as CuNiFe; please ask for separate catalogue). EO2-FORM tools cover metric tube from 6 to 42 mm OD. Thin wall tube of 1 mm wall thickness can be formed, too.
- Vibration resistance** – The new EO2-FORM process achieves a smooth structural transformation of the tube wall allowing superior vibration resistance.
- Durability** – The elastomeric seal does not require any re-tightening even after years of operation under extreme working conditions.
- Efficient** – Compared to welding or brazing, EO2-FORM is much less time consuming. Special tube preparation and finishing are not necessary. Forming uses only a fraction of the energy needed for brazing or welding.
- Quality** – Tube clamping and tooling are fully automated. Therefore, high and consistent quality is achieved without manual adjustment.
- Noise reduction** – Compared to other forming methods, the EO2-FORM process results in a smooth inner contour of the tube that does not allow the accumulation of air, dirt or other sources of trouble. Less pressure drop, heat and noise is created.
- Re-usability** – EO2-FORM connections can be disassembled and reassembled many times. There is no wear or widening of the vulnerable fitting inner cone.
- Approved** – Both, EO-2 high pressure tube fittings and the EO2-FORM process are tested and approved by independent organisations such as Germanischer Lloyd and Det Norske Veritas (DNV).
- Small bending radii** – The compact clamping device and special dies are suitable for forming short tube ends.
- Clean** – The EO2-FORM process is environmentally clean and safe. As no heat is used, hazards from chemicals, fumes or heat do not occur.

Function of fittings

EO weld nipple

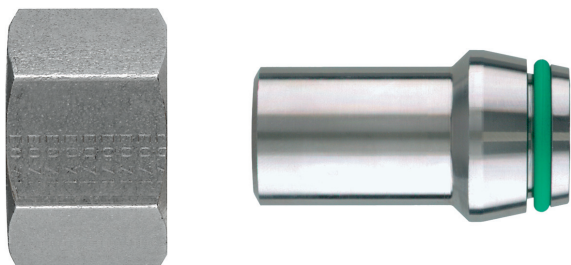

The leakfree performance of EO Weld nipples is assured by an o-ring seal.

Function of the EO weld nipple

The wide EO fitting range allows welded tube connections. Therefore, the EO weld nipple has to be welded onto the tube end.

Using the standard EO nut, this weld nipple can then be connected to the tube joint of any EO tube fitting.

EO weld nipples are available for L and S-series tubes of 6–38/42 mm diameter. A broad range of weld nipple fittings including reducers or elbows covers most applications.

The use of EO weld nipples allows remakeable pipe systems based on rigid weld connections.

Features, advantages and benefits of the EO weld nipple

EO weld nipples feature most advantages of the attractive EO fitting program. The specific benefits of the EO weld nipple program are:

- **Low quality tube** – Unlike bite-type or flared fittings, dimensional tolerances and rough tube surface are not very critical. Therefore weld nipples are suitable for countries where only poor quality tube is available.
- **Sealing capability** – An elastomeric seal forms the primary sealing element, thus assuring leakfree sealing. Even low-viscosity media such as water or gas are hermetically sealed. Hydraulic systems therefore do not “sweat” at fittings.

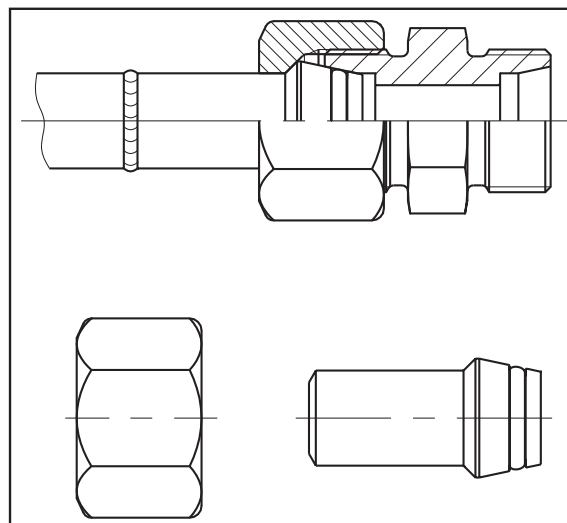

EO-Weld Nipples

- **Durability** – The O-ring seal is assembled with a high initial compression. It does not require any retightening even after years of operation under extreme working conditions.
- **Failure mode** – Unlike bite type fittings there is little danger of tube blow off if the fitting is not properly tightened. A loose joint shows excessive leakage before total failure.
- **Reusability/Remakeability** – EO weld nipples can be disassembled and reassembled many times. There is no wear or widening up of vulnerable inner fitting cone. Damaged O-rings can easily be replaced.
- **Smooth edge** – Under extreme working conditions, weld nipples are most likely to crack at the dimensional step just under the nut. In an additional rolling process this critical edge is smoothed for increased vibration strength.
- **Stress-free** – By welding, small deviations on tube cutting or bending can be compensated. Tension-free pipework is not likely to break even under extreme working conditions.
- **Welding process** – EO weld nipples are designed to be used for most popular welding processes.

Introduction to O-Lok®



The O-Lok® fitting was developed by Parker Tube Fittings Division in the USA in the early 1980's. This product has proven to be extremely effective in eliminating leaks at the higher pressures found in today's hydraulic systems.

The O-Lok® fitting is an O-ring face seal (O.R.F.S.) type fitting that consists of a nut, a body, an O-ring and a sleeve. Parker O-Lok® fittings come standard with a trapezoidal seal "Trap Seal". As shown in Fig. 1 the tube is flanged to 90° using the Parflange® system (or the tube may be brazed instead to a braze-type sleeve). When the fitting is assembled, it compresses an elastomeric seal in the precision-machined groove in the fitting body to form a leak-free connection.

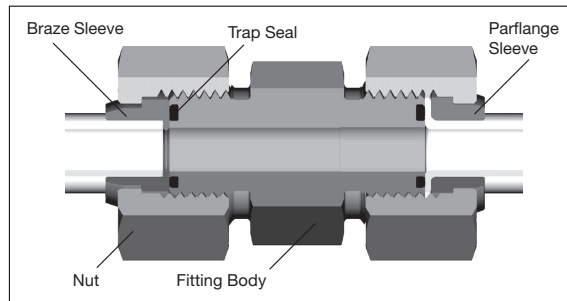
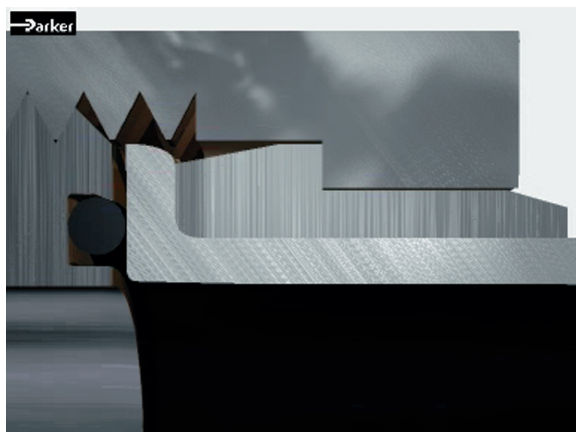

Fig. 1 - O-Lok® Union cutaway with brazed (LHS) and flanged assembly

O-Lok® fittings are suitable for a wide range of tube wall thickness and are also readily adaptable to inch or metric tubing and hose connections.



Before tightening the nut



After tightening the nut
Standard O-Rings can be fitted instead of "Trap Seals"

O-Lok® Progress

The last twenty years of experience supplying O-Lok® to the largest OEM customers have been well used in terms of listening to customer needs and refining design and material details to achieve the optimum mix of headline performance and a long trouble-free service life. After extensive product testing, it has been recognised that Parker O-Lok® fittings can be updated to higher performance levels.

O-Lok®

The O-Lok® fitting system is characterised by the words.

'Durability' and 'leakfree performance'.

- **Pressure Plus** – Larger fitting sizes nominal pressure increased
 - 20 from 280 to 420 bar*
 - 24 from 280 to 350 bar*

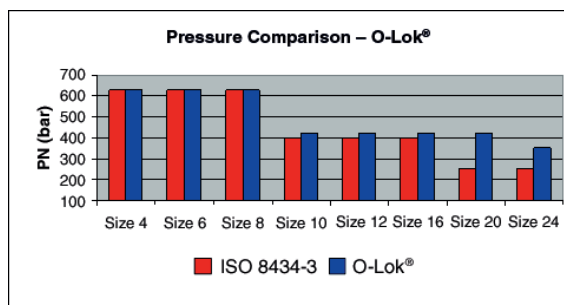

*For detailed pressure ratings see chapter C.



Function of fittings

acesolutions™

- **Plating Plus** – 120 hours resistance to white rust corrosion exceeds the requirements of international standards.
- **Cleanliness Plus** – Contamination is the biggest source of early component failure in hydraulic systems. Parker O-Lok® fittings meet all requirements from the factory to the point of use – backed up by individual bagging.
- **CORG Plus** – All Parker O-Lok® fittings are manufactured with the Captive O-Ring Grooves (CORG) as standard. (This is an optional version in ISO 8434-3 and SAE J1453). See fig. 2.
- **Range Plus** – Parker offers the widest range of catalogue standard materials, seal combinations, styles and sizes in the industry. Only Parker has all this.

Introducing ACE Solutions

Advance Connector Enhancements are product features that take the fitting performance in the hands of customers beyond the standard we have come to expect. Driven by customer experiences and feedback from the field, ACE solutions are exactly that – simple engineering answers to real world problems.

Trap Seal

The Trap Seal in Parker O-Lok® fittings eliminates any possibility of the seal being rubbed out of position during the assembly process and hence cuts warranty costs and end customer dissatisfaction. Standard O-Rings can be dislodged without being noticed, leading to unexplained leaks after machines have been delivered to the end user. The simple patent pending engineered solution requires no changes in assembly method or order codes, and so is a seamless product upgrade unique to Parker. Existing standard O-Rings fit in the groove where necessary as field replacements.

Robust Adjustable Port Fittings

Robust Adjustable Port connections have been developed and tested to prevent leaks caused by incorrect assembly procedures. The joint geometry is re-designed to stop the backup washer being deformed / damaged if the fitting is over tightened when threaded into the port. The new robust locknut eliminates the possibilities of excessive tightening damage. It is available for all parallel thread types – UNF, Metric, BSPP. The simple design improvement leaves the assembly instructions unchanged. Patent pending.

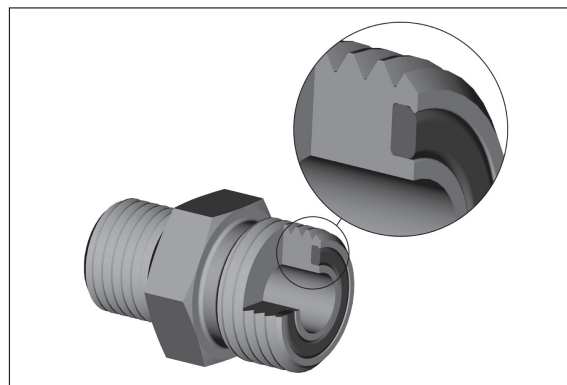

Fig 2 – Captive O-ring Groove (CORG) cutaway

Cr(VI)-free Surface finish

In accordance with European “end of vehicle life” directive 2000/53/EC which became law on 1st July 2007, all O-Lok® products have Cr(VI)-free surface protection. The new surface – introduced as a running change – gives a minimum of 120 hours to first white rust as measured according to ISO 9227 / ASTM B117 5% NaCl solution test standards.

Applications

The original development of the O-Lok® fitting was heavily influenced to meet the needs of international mobile equipment companies, mining, site clearance, agricultural and other heavy duty equipment. Today, the O-Lok® fitting is becoming an industry standard hydraulic fitting system for rugged duty equipment mounted on tracks or wheels. Equipment in these fields of application endure some of the highest levels of use, sometimes round the clock operation, in tough environments with extremes of temperature and mechanical stress. The simple, but effective design of the O-Lok® connection when used with the Parflange® tube preparation technology mean that long term ‘fit and forget’ performance is ensured, despite the physical conditions.

Simple, low torque assembly, no tube entry breakaway feature, 2"/50 mm max. tube size, and the ease of use with inch or metric tubing also make O-Lok® eminently suitable for general hydraulic applications in hydraulic presses, injection moulding equipment, shipbuilding, machine tools and a range of other areas. Anywhere in fact where a high quality leak-free tube or hose connection is needed.



Function of O-Lok® fittings

The O-Lok® fitting consists of four main components: a body, sleeve trapezoidal elastomeric seal and nut.

The O-Lok® fitting body

There are over 40 different body configurations to choose from for specific applications. The body face has a groove, which contains a high durometer seal that is held captive during installation. In addition, the O-Lok® fitting body shapes are all forged for added strength and longer service life.

Straight fittings are made from cold drawn barstock. The cold drawing process ensures consistent dimensional tolerances, improved strength and consistent surface finish.

CORG Groove

O-Lok® fittings are manufactured with a Captive seal Groove (CORG) design for prevention of seal fall out prior to final assembly. The international standards for ORFS fittings contain two versions of the seal groove. The original design had straight sides and under certain conditions of tolerance between the seal and the groove, it was possible for the seal to be dislodged. As a further refinement of the O-Lok® fitting, Parker introduced the CORG groove as standard production in all its plants in 1998.

Elastomeric Sealing

From the design of the system, the Trap Seal compression gives excellent sealing characteristics from low pressure, low temperature circumstances found in winter during machine storage, to full pressure, high temperature cycles. Trap Seals are made from the same high quality NBR compound as the O-Rings superseded in 2006.

The O-Lok® fitting nut

Smaller size O-Lok® fitting nuts are cold-formed to provide a more tightly packed grain structure, resulting in a much stronger component. Larger size nuts are made of warm-forged steel-blanks.

The O-Lok® Parflange® sleeve

The preferred method of making an O-Lok® tube connection is by using the Parker Parflange® process to create the 90° flange on the tube end. A flange sleeve is used to support the flange and the tube, and provides the contact shoulder for the nut. After the Parflange® process, the sleeve is permanently fixed on the end of the tube reinforcing the joint.

The O-Lok® connection using the Parflange® method can be made with either metric or inch tubing by choosing the appropriate sleeves and tooling.

Parflange® sleeves from Parker are manufactured to exacting tolerances and geometry to work with the Parflange® machine and tooling, producing the robust, reinforced tube end connection. Failure to use the correct components can result in premature joint failure in the final application.

The O-Lok® braze sleeve

The braze sleeve provides the mating surface between the tube and the fitting body. Secondly, the braze sleeve, as the name implies, is attached to the tube through silver brazing. The braze provides holding power as well as a method to seal the joint. It also has a flat and smooth contact shoulder for the nut to connect the tube to the fitting body.

O-Lok® braze sleeves are manufactured to exacting dimensions. Tightly toleranced dimensions are required to prevent binding in the nut when torqued, to provide a flat and smooth sealing surface against the seal, and to give the appropriate clearance for silver brazing to the tube.

The O-Lok® connection can be made with either metric or inch tubing by choosing the appropriate braze sleeve.

The O-Lok® reducing braze sleeves

O-Lok® braze sleeves are manufactured in both even and reducing sizes. The reducing sleeves make it easy to adapt a larger face seal fitting to a smaller tube connection.

O-Lok® fitting function

The O-Lok® fitting body face contains a high durometer seal that is held captive in a precision machined groove. As the nut is tightened onto the fitting body, the seal is compressed between the body and flat face of the tube flange or braze sleeve to form a tight, positive seal.

As the two faces come in contact, further tightening of the nut produces a sharp rise in assembly torque. A solid pull of the wrench at this point, to the recommended assembly torque, completes the assembly.

The sharp torque rise gives a “solid feel” at assembly, and minimises the possibility of over tightening.

Because the sealing surfaces are flat and perpendicular to the assembly forces, they remain virtually free of distortion during assembly, giving O-Lok® fittings virtually unlimited remakeability. The seal should be inspected at each disassembly and replaced when necessary.



Function of fittings

Parflange® orbital flaring process

The Parflange® process

With the Parflange® process, the tube to sleeve attachment is achieved mechanically during an orbital cold forming process with a Parflange® machine. The process progressively flares then flanges the tube. The final dwell action in the cycle ensures that the seal surface produced is smooth and flat, and also eliminates spring-back effects in the material. This flange provides both the holding power and sealing surface (eliminating the braze joint, and hence, a potential leak path found with brazed sleeve attachment). The only sealing point is between the fitting body and the tube flange face via the high durometer elastomeric seal. Trap Seals are now fitted as standard to Parker O-Lok® fittings.

The flanging process is very fast and requires very little cleaning prior to or after flanging. Thus, the process enhances the integrity of the joint and reduces cost.



Parflange® 1025

The Parflange® process utilises an orbital cold flow forming process to produce a flat, smooth, rigidly supported 90° sealing surface on the tube end. The process progressively flares then flanges the tube.

The Parflange® process conforms to the requirements for mechanical tube forming shown in the SAE J1453 standard, and has been specified after extensive testing by the majority of the large mobile equipment manufacturers.



Upgraded Parflange® 50 – Easier to use, reliable machine

Flanging with Parflange® eliminates the need for welding or brazing of the sleeve to the tube end.

Parflange® 50 series production machine

The 50 generation of the hugely successful Parflange® machine incorporates all the feedback and suggestions from professional tube manipulation users across the world. Ergonomics, controls and electronics and maintenance aspects are all improved, but the heart of the process – the Parflange® orbital forming head remains unchanged. Similarly existing tooling can be used with the new machine, making a 50 upgrade from the 1040 generation a seamless experience. For full details please see chapter H.

Parflange® advantages over brazing or welding

- **Flexibility** – Fast tool changes and easy set-up make small batches economical to reduce WIP (work in progress) and inventory costs.

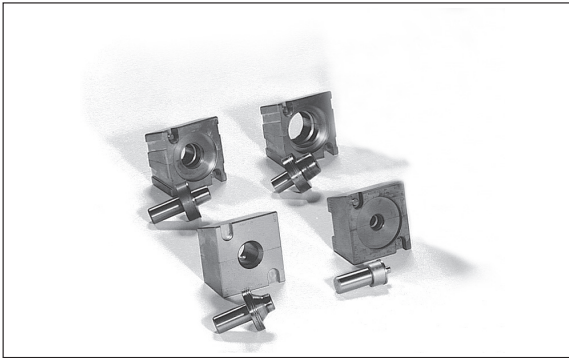

Parflange® tools

- **Faster** – 9 to 12 times the speed of comparable induction brazing.
- **Simple tube preparation** – The Parflange® process does not require any special pre- or post-flange cleaning of the tube and sleeve. The process is simple and the machine requires straightforward training only to operate.
- **Safety** – Unlike brazing, the Parflange® process does not require any flux, braze alloy, post braze cleaner or rust inhibitor. An environmentally safe lubricant applied to the flanging pin is the only additive associated with the Parflange®.

The Parflange® process

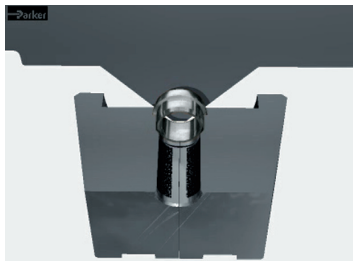

For O-Lok®, the sleeve is placed into clamping dies first

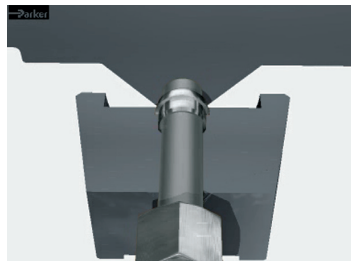

Tube is inserted into the tools until it firmly touches the stop at the end

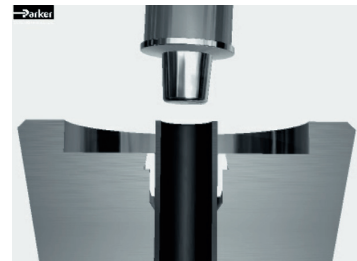

After starting the process, the dies clamp the tube and the flanging pin starts the orbital movement and the forward stroke



While moving, the front pin expands the tube wall from the inside

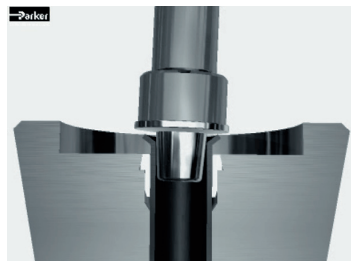

As soon as the flat working surface of the pin contacts the tube end, the flanging process begins



The front surface is continuously rolled and compressed. From the inside, the tube surface is slightly expanded to clamp the sleeve

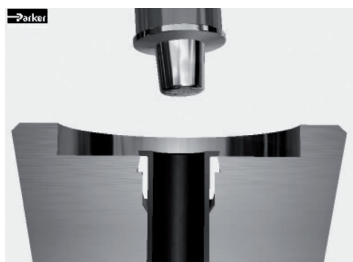

As soon as the defined flange contour is achieved, the orbital movement stops and the pin withdraws

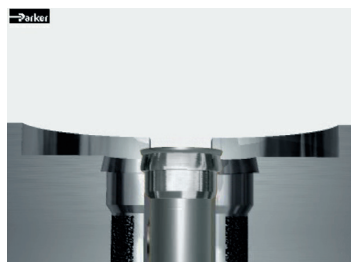

The tube end is released and can be taken out of the machine



The connection is ready for assembly

Function of fittings

- **Environment** – The Parflange® process is environmentally clean and safe. It does not require open flame or any form of heating. Additionally, there is no emission of hazardous fumes, as is typical with welding and brazing.
- **Energy** – The Parflange® process uses only a fraction of the energy needed for welding or brazing.
- **Corrosion resistance** – The Parflange® process accommodates the use of plated or unplated components (i.e. tube and sleeve). Thus, the high costs of electroplating assemblies after fabrication is eliminated by using pre-plated tube.
- **Excellent surface quality** – The Parflange® process eliminates the potential leak path present at the braze or weld joint.
The Parflange® process produces a burnished sealing surface, typically much smoother than the 3.1 µm/125 micro-inch Ra surface smoothness requirement of SAE J1453.

Users of Parflange® and Parker's O-Lok® fittings enjoy all the inherent sealing, reliability, time and cost saving benefits, without the many drawbacks which accompany welding or brazing.

Therefore, Parker strongly recommends the Parflange® process for the assembly of Triple-Lok® and O-Lok® connections. Parflange® machines range from desktop 1025 for flexible workshop use to Parflange® 50 for economic industrial production.

Features, advantages and benefits of the Parflange® process for Triple-Lok®, O-Lok®

- **Superior sealing performance** – The Parflange® process achieves a sealing surface of unique surface quality and mechanical strength.
- **Superior vibration resistance** – Unlike conventional flaring, the Parflange® process results in a rigid connection of the O-Lok® sleeve on the tube-end. Parflange®/O-Lok® connections perform much better under reversed bending stress conditions.
- **Easy to use** – No programming or adjustments necessary. High quality results are consistently achieved without manual adjustment.
- **Cost saving** – Compared to brazing or welding, orbital flanging is much less time consuming. Special tube preparation and finishing are not necessary. Flanging uses only a fraction of the energy needed for brazing or welding. In summary the Parflange® process can reduce costs for volume manufacture by more than half.
- **Clean** – The Parflange® process is environmental clean and safe. As no heat or chemicals are used, hazards from fumes or heat do not occur.
- **Zinc plated tubing** – The Parflange® process allows the use of zinc-plated tubing. The cost for cleaning, post process plating or painting can be saved.
- **Process/Product concept** – Parflange® machines are specially designed to match Parker O-Lok® and Triple-Lok® standards. Machine, tools and products are fine-tuned for reliable performance.
- **Proven technology** – For more than 14 years, hundreds of Parflange® machines have operated worldwide under heavy duty workshop conditions.

Introduction to Triple-Lok®



The concept of flaring tube to provide a seal and holding power to the connection is very old. It's origin goes back to the early days of the automobile. Different types of flared connections including 45° single and double flares, inverted flare, 30° flare, etc., were developed for coolant, fuel, brake and lube systems of the early automobile.

Pioneered by Parker Hannifin, the Triple-Lok® 37° flared fitting evolved as a higher pressure version of the above connections. Its initial use was in the developing hydraulic systems of agricultural and earth moving machinery, automotive transfer lines and other machine tools.

As exports of machinery increased after World War II, the Triple-Lok® Plus fitting gained worldwide use and acceptance. Today it is the most widely used fitting in the world.



Before tightening the nut

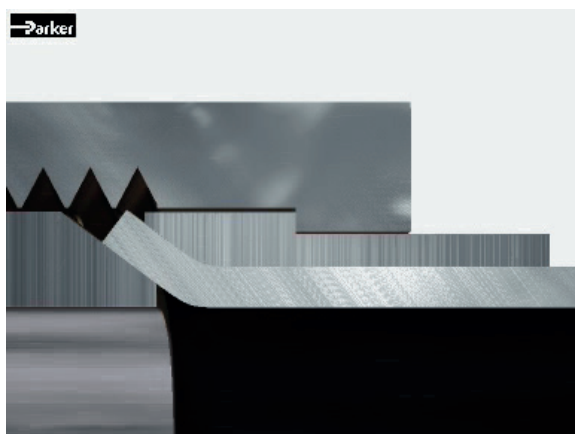

After tightening the nut

It enjoys conformance approvals by a range of national and international technical and certifying organisations.

Its appeal is in its simplicity, compact design, ease of assembly, reliability (single sealing point), wide availability and acceptance. It is especially suited for low and medium wall thickness tubing. Today the Triple-Lok® generation capabilities range from 500 bar for smaller sizes to 140 bar for largest – 2" size. Currently it is used in virtually every application that uses fluid power for motion control.

Triple-Lok® Progress

Parker have supplied more Triple-Lok® fittings than any other manufacturer over the last seventy years. Parker engineers take a leading position in advising both customers and the international standards committees concerning 37° flare fittings. This experience, combined with optimised manufacturing methods and materials have resulted in steady product performance improvements verified by extensive testing in the laboratory. A combination of simple burst tests (with a 4x design factor), impulse and vibration tests have shown Parker Triple-Lok® fittings can be upgraded to higher performance levels in the smaller and in the larger sized parts. Additionally, the corrosion protection level has been improved by 100% due to effective process control.

Triple-Lok®

The Triple-Lok® fitting can be characterised by the phrase "reliable product performance".

- **Pressure Plus** – Following fitting sizes nominal pressure increased
 - Size 4: 350 ISO 8434-2 (bar) 500 Triple-Lok® (bar)
 - Size 5: 350 ISO 8434-2 (bar) 420 Triple-Lok® (bar)
 - Size 6: 350 ISO 8434-2 (bar) 420 Triple-Lok® (bar)
 - Size 8: 350 ISO 8434-2 (bar) 420 Triple-Lok® (bar)
 - Size 20: 210 ISO 8434-2 (bar) 280 Triple-Lok® (bar)
 - Size 24: 140 ISO 8434-2 (bar) 210 Triple-Lok® (bar)
 - Size 32: 105 ISO 8434-2 (bar) 140 Triple-Lok® (bar)

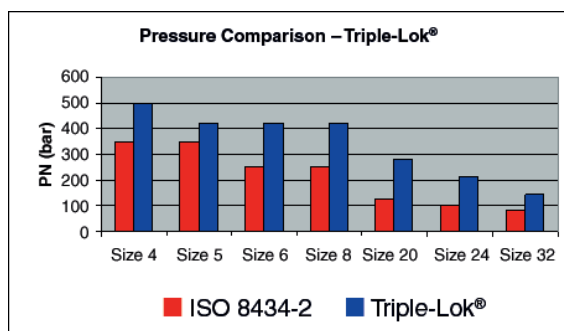

Function of fittings

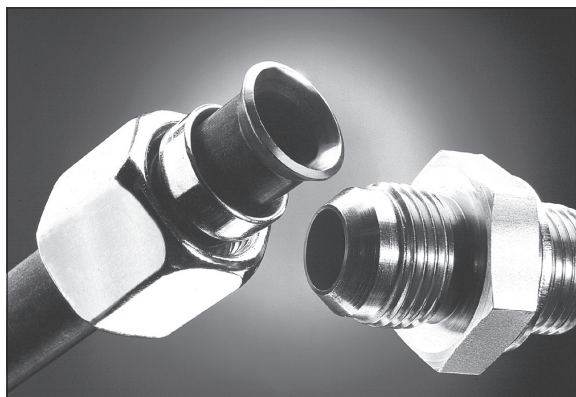

Fig. C1 – Assembled Triple-Lok® fitting cutaway and Triple-Lok® fitting components (fitting body with O-ring, sleeve and nut).

- **Plating Plus** – 120 hours resistance to white rust corrosion exceeds the requirements of international standards.
- **Cleanliness Plus** – Contamination is the biggest source of early component failure in hydraulic systems. Parker Triple-Lok® fittings meet all requirements from the factory to the point of use – backed up by individual bagging.
- **Range Plus** – Parker offers the widest range of catalogue standard materials, seal combinations, styles and sizes in the industry. Only Parker has all this.

This all adds up to an unbeatable combination of performance and customer-friendly features.

Introducing ACE Solutions

Advance Connector Enhancements are product features that take the fitting performance in the hands of customers beyond the standard we have come to expect. Driven by customer experiences and feedback from the field, ACE solutions are exactly that – simple engineering answers to real world problems.

- **Robust Adjustable Port Fittings**

Robust Adjustable Port connections have been developed and tested to prevent leaks caused by incorrect assembly procedures. The joint geometry is re-designed to stop the backup washer being deformed / damaged if the fitting is over tightened when threaded into the port. The new robust locknut eliminates the possibilities of excessive tightening damage. It is available for all parallel thread types – UNF, Metric, BSPP. The simple design improvement leaves the assembly instructions unchanged.

- **Cr(VI)-free Surface finish**

In accordance with European “end of vehicle life” directive 2000/53/EC which became law on 1st July 2007, all

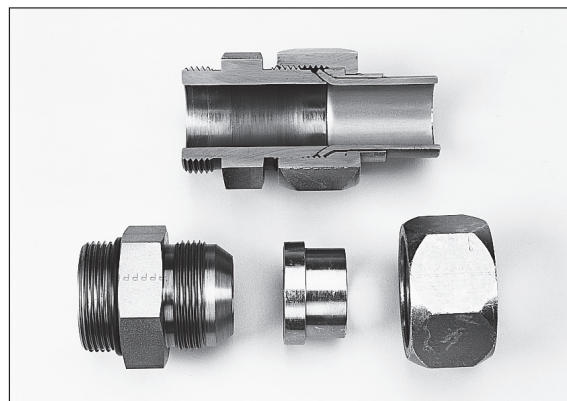

Fig. C2

Triple-Lok® products have Cr(VI)-free surface protection. The new surface – introduced as a running change – gives a minimum of 120 hours to first white rust as measured according to ISO 9227 / ASTM B117 5% NaCl solution test standards.

- **Dual Angle Swivel Connections**

In another ‘first’ for Parker, all swivel female cone connections will be switched to the unique dual angle design. This will make the connections even more effective by increasing the reliability in dynamic pressure conditions, making the contact point between the cones more stable, and easier to make a tight connection when the sealing cone gets damaged. Further, the pressure rating for some of the connections will be increased, without the need for heavier or higher strength materials. Another elegant engineering upgrade from Parker. There are no changes to the assembly procedures or part numbers. Customers need do nothing to start to receive a superior product.

Applications

Because of its long history and the heavy influence of American industry worldwide, Triple-Lok® fittings designed to the original American SAE standard are found in almost every branch of hydraulics, from garbage trucks to shipbuilding. They are particularly prevalent in those branches of mobile hydraulics where medium pressure systems are used. The Triple-Lok® fitting system is especially applicable where high volumes of tubes are prepared, and efficient tube flaring equipment can be employed. Still field repairs can be made with hand tools where needed.

Function of Triple-Lok® fittings

The Triple-Lok® fitting design is very simple. It uses an easily produced flare at the tube end to seal and hold fluid under high pressure. The fitting consists of three pieces: the body, sleeve and nut. The tube end is flared to a 37°

Function of fittings

angle and held between the fitting nose (seat) and the sleeve (support) with the nut as shown in Fig. C1, providing a very effective single seal point between the fitting nose and the tube flare.

The support sleeve serves several important functions:

- It provides a clamping surface against the rear of the tube flare and a bearing shoulder for the nut. This minimises tube twisting during assembly.
- It provides support to the tube flare. The tapered fitting nose tends to wedge open the flare during assembly. The sleeve helps to resist this expansion, allowing the fitting to be tightened adequately.
- It makes the fitting adaptable to both metric and inch O.D. tubing merely by changing the sleeve. This feature has made Triple-Lok® fittings accepted worldwide.

The Triple-Lok® design is also very efficient. It has the smallest seal area of all fitting designs. The seal area is only slightly larger than the fluid flow area. The small seal area results in compactness and low assembly torque compared to the holding power of the joint.

The design was standardised initially as a J.I.C. (Joint Industrial Council) design and was later adopted by the S.A.E. (Society of Automotive Engineers) and I.S.O. (International Organisation for Standardisation) to assure complete dimensional interchangeability between various manufacturers.

Even though many manufacturers conform to the same dimensional standard, there are significant differences in actual performance of the fittings because of a variety of methods of manufacture and quality standards used.

Triple-Lok® fitting components are produced using the best methods of manufacture and state of the art equipment to assure construction integrity, high strength, long service life and high quality.

The Triple-Lok® body – Straight bodies are made from either cold drawn bar stock, or cold-formed construction. All shapes are of one-piece forged construction eliminating potential leak paths of multiple component constructions such as brazed shapes. The Triple-Lok® steel forged shapes also feature higher hardness for high pressure capability and minimising nose collapse (typical of sizes – 10 and under) during repeated assembly. This compares very favourably to parts of brazed construction, which typically exhibit lower hardness and hence much more nose deformation.

The Triple-Lok® sleeve – Triple-Lok® fitting support sleeves are cold-formed and heat treated for an optimum combination of strength and ductility. Cold forming also eliminates the problems of laps, folds, stringers, etc., associated with sleeves machined from bar stock.

The Triple-Lok® nut – Nuts for all but the three largest sizes (–20, –24 and –32) are cold formed. Cold forming increases material strength and its fatigue properties, imparting high strength and longer service life to the nuts.

Larger nuts which are less severely stressed, are hot forged.

Triple-Lok® fittings sealing function

As seen in Fig. C2, tightening of the nut clamps the tube flare against the body nose, producing a leak tight joint. This clamping onto the 37° cone provides a measure of elasticity to the joint helping it to resist loosening under vibration. The clamping force results in a radial load (F_R) that tends to deform the fitting nose inwards. The resistance of the nose to elastic deformation provides a constant pre-load (similar to a spring washer) keeping it tight.

The clamping force provided by the nut resists the opposing force of the fluid under pressure. The joint remains leak tight as long as the clamping force is higher than the opposing pressure load. Properly assembled Triple-Lok® fittings with appropriate tube will seal consistently under pressure until the tube bursts.

Sealing in Triple-Lok® fittings takes place between two smooth metal surfaces, the fitting nose and inside of the tube flare. Therefore, the sealing surfaces have to be round and smooth, free of any, scratches, dents, spiral tool marks, splits or weld beads, in the seal area.

Seamless or welded and redrawn fully annealed tubing is recommended for Triple-Lok® fittings for ease of flaring and tube bending.

Features, advantages and benefits

- **Pressure** – Triple-Lok® fittings are rated up to 500 bar nominal pressure with 4x design factor. Triple-Lok® can be used in more applications.
- **Robust Adjustable Port connections** – Eliminates potential assembly errors associated with over tightening of the elbow or tee bodies into ports. Reduces warranty claims from unseen assembly faults.
- **Cr(VI)-free surface** – Triple-Lok® fittings conform to the requirements of the European directive 2000/53/EC.
- **Corrosion resistance** – Triple-Lok® fittings achieve a minimum of 120 hours to first white rust, exceeding industry standards.
- **Dual Angle Swivel** – improved reliability in dynamic pressure conditions and increased pressure ratings for the swivel connection.

Function of fittings

- **Safety** – The flared tube provides a solid and visible stop for the nut. The tube flare means there is no risk of tear out of the tube, thus giving the Triple-Lok® system a reputation for safety.
- **Single seal point** – Triple-Lok® fittings have only one seal (between the fitting nose and flare I.D.). This makes a highly reliable joint that is easily maintained.
- **Easy to assemble** – Small seal area under pressure makes for high-pressure capability at relatively low torque levels. This allows the use of small wrenches for easy installation and maintenance.
- **Wide temperature and media compatibility** – Metal to metal seal allows a range of uses and many applications.
- **Tube materials** – Triple-Lok® fittings can be used with most tube materials, such as high and low-grade steel or stainless steel, copper and aluminium.
- **No minimum tube wall limitation** – Triple-Lok® fittings are suitable for very thin to medium wall tubing. The optimum wall thickness tubing can be used, reducing overall system cost.
- **Ease of installation and maintenance** – Short tube entry means that installation is simplified and minimum tube prying is necessary when maintenance is required on the system. It is easy and quick.
- **Adaptability to metric & inch tubing** – Triple-Lok® fitting sleeves make the system suitable for inch and metric tubing by merely changing the sleeve.
- **Adaptability to hose assembly** – Triple-Lok® fittings allow for direct connection to 37° flare hose assemblies, the most popular industrial hose connection worldwide.
- **Forged shapes** – Triple-Lok® fittings have no braze joints to leak. Forgings provide higher dependability and longer life compared to multiple component brazed constructions.
- **Hard forgings** – High hardness of Triple-Lok® fittings forged shapes minimises the deformation of the 37° nose during assembly, maintaining full flow area and good reuseability.
- **Cold formed sleeves and nuts** – Sleeves and nuts in popular sizes are cold formed for high strength and toughness through optimum grain flow. This imparts high dependability and long service life.
- **International standard design** – Triple-Lok® fittings offer worldwide availability and interchangeability, they conform to SAE and ISO standards. 37° fittings are the most widely used fitting type in the world.
- **Availability** – Triple-Lok® fittings offer the broadest range of sizes and configurations of any fitting. This provides users with the optimum choice of tube fitting options. Standard materials offered are steel, stainless steel and brass.

Adapters – introduction

In addition to the tube fittings described earlier, there are needs for other adapters to complete hydraulic circuits which perform different functions:

- **Thread size adapters** – to reduce or expand the existing thread
- **Thread conversion adapters** – to change from one port thread to another to allow tube fitting or hose connections
- **Hose end adapters** – hose to port, hose to hose etc.
- Blanking plugs.

The range of Tube Fittings products, when used without the tube nut and ring/sleeve, can also be used as hose adapters to allow the corresponding hose assembly to connect to a port.

Adapters are frequently used in maintenance situations, where equipment is used outside the region in which it was manufactured. For example to convert BSPP threads from a European manufacturer to an American thread alternative – UNF or NPT. Adapters are therefore often the most economical way to solve short-term problems.

There are many types of threads used in the Fluid Power industry throughout the world. This section contains adapters with a wide range of those thread types including: NPT, NPTF, NPSM, BSPT, BSPP, SAE, UN/UNF, and Metric. All threads in this section are made to industry specifications with conformance shown in Table F1.

| Thread | Standard |
|---------|---------------------------------------|
| NPT | ANSI B1.21.1, FED-STD-H28/7 |
| NPTF | SAE J476, ANSI B1.20.3, FED-STD-H28/8 |
| NPSM | ANSI B1.20.1, FED-STD-28/7 |
| BSPT | BS 21, ISO 7/1 |
| BSPP | BS 2779, ISO 228/1 |
| Metric | ISO 261, ANSI B1.13M, FED-STD-H28/21 |
| UN/UNF* | ANSI B1.1, FED-STD-H28/2 |

Table F1 – Thread conformance standards

Adapters from Parker Hannifin are manufactured from drawn barstock for straight parts, or from forgings in the case of elbows, tees and crosses, to give higher durability and long term performance. Pressure ratings are based on the same requirements used for the tube fittings product ranges. Parts are corrosion protected also to the same high standard found in other High Pressure Connectors Division products.

Adapters – function

NPT/NPTF adapters

Commonly known as pipe thread adapters in USA, NPT and NPTF (Dryseal) adapters have tapered threads. These threads feature a 60° flank angle and 1°47' taper, as shown in Fig. F1. Because of the taper, they are commonly used in the USA as adjustable fittings in the elbow and tee forms. It has been found that although NPT/NPTF have a high static pressure capability, they are unreliable in dynamic applications, especially in the larger thread sizes 1" and above. Parker therefore recommends the use of alternative thread forms and sealing, based on elastomeric seals for new applications and designs.

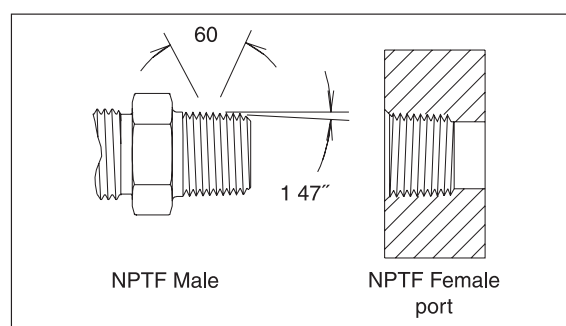

Fig. 1 – NPTF thread

NPT threads when assembled without a sealant, leave a spiral leak path at the crest-root junction as shown in Fig. F2. To seal pressurised fluid, NPT threads need a suitable sealer.

NPTF threads (Dryseal) on the other hand, when assembled, do not leave such spiral leak path. This is because they have controlled truncation at the crest and root, ensuring metal to metal crest-root contact as the male-female thread flanks make contact as seen in Fig. F3. Upon further tightening, the thread crests are flattened out until the flanks also make metal to metal contact as seen in Fig. F4. Theoretically, at least, there is no passage left for the fluid to leak, provided all surfaces are flawless and dimensions exact. In the real world, however, this is not the case and a sealant/lubricant is necessary to achieve a leak free joint even with NPTF threads. Because of the higher surface pressure contact with the NPTF design, Parker manufactures all Stainless steel adapters with the NPT thread form to reduce the possibility of thread galling (Cold welding effects).

Function of fittings

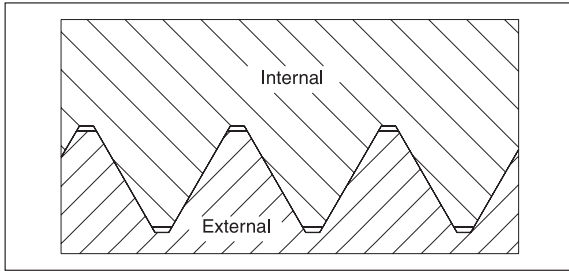

Fig. 2 – NPT – Wrench tight – No Crest-Root contact, Flank contact only.

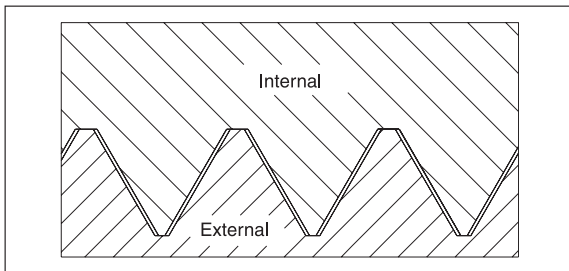

Fig. 3 – NPTF – Hand tight crest-root contact

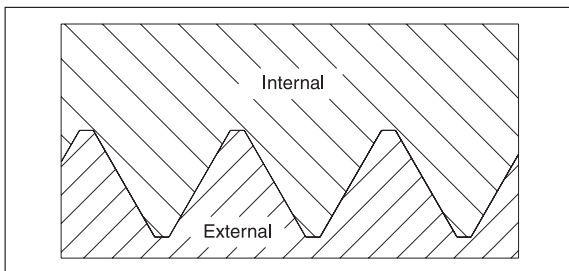

Fig. 4 – NPTF – Wrench tight crest-root and flank contact

Type of sealant/lubricant

Sealant/Lubricant assist in sealing and provide lubrication during assembly, reducing the potential for galling. Pipe thread sealants are available in various forms such as dry pre-applied, tape, paste and anaerobic liquid. PTFE tape, if not applied properly, can contribute to system contamination during assembly and disassembly. Paste sealants can also contribute to system contamination, if not applied properly. They are also messy to work with, and some types require a cure period after component installation, prior to system start up.

BSPT adapters

BSPT threads came from the British gas industry, where the outside diameter of a gas pipe was threaded at the end to allow a connection to be made. The thread form has a 55 degree flank angle, and the thread pitch is dif-

ferent generally to NPT threads. Therefore the two forms are not compatible. Today the BSPT thread is used in the pneumatics industry, but use on the hydraulics side is limited. In most cases, the BSPT male stud is screwed into a BSPP – parallel – port. Thread engagement in this situation is limited, giving lower holding power compared to NPT equivalents.

To seal BSPT threads, a sealant is always needed, since the sealing function is on the threads. BSPT fittings offer a limited adjustability when using elbow or tee types, and it is easy to overtighten and damage the port thread, stud thread or both. Re-useability is also therefore very limited. For all these reasons, BSPT threads should be limited to lower pressure applications with limited dynamic changes in pressure. Parker Hannifin does not use BSPT threads in its “Dry Technology” programmes for this reason.

UNF thread adapters

Function of UNF adapters

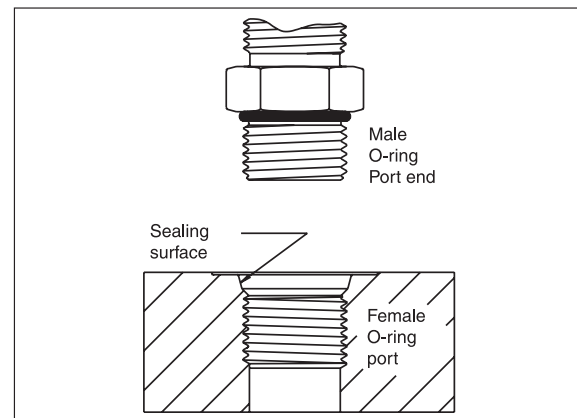

Fig. 5 – UNF port

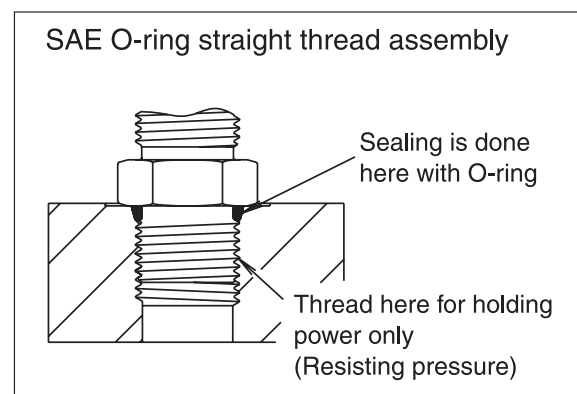

Fig. 6 – UNF port assembly

Function of fittings

Parker fittings incorporating UN/UNF thread, O-ring port studs shown in this section are for connection with the UN/UNF thread ports. They are also known as O-Ring Boss (O.R.B.) connections. When properly assembled, they give performance equal to the best leak-free port connection available.

For this style of connection, the sealing and holding functions are separated. The threads have only the holding function. Thread tolerances are wider between the male stud and female port, and so the sensitivity to damage of the threads is much lower than the NPT for example. Sealing is achieved via a high durometer O-ring seal seated in a specially machined chamfer at the top of the port thread. When energised under pressure, the O-ring seals the only leak path. Good initial compression of the seal, means that the joint is leak tight at low and high pressures.

Features, advantages and benefits

SAE straight thread

- **Elastomeric seal** – SAE straight thread O-ring connections offer a high sealing reliability, especially in dynamic and shock loading applications. The O-ring seal offers a high tolerance to minor surface imperfections and damage.
- **Ease of assembly** – This design is extremely easy to assemble, even for less experienced workers.
- **Infinite positioning of shaped fittings** – Due to the design of shaped fittings, incorporating adjustable SAE straight thread connections, they allow for infinite positioning of the port end. Aligning for tube and hose connections is much easier as compared to tapered threads.
- **Reusability** – Since the sealing and mechanical holding functions are separated, the SAE straight thread male studs can be re-used many times simply by changing the O-ring.

ISO 6149 adapters

The ISO 6149 connection design is similar to the UN/UNF, but with metric threads. The pressure performance of the connections is therefore similar, and also the user-friendly assembly characteristics. This design is recommended by the ISO standards committee for all new applications and designs. The ISO 6149 thread has gained widespread use with OEM's in the agricultural and construction equipment segments. Parker Hannifin offers one of the widest range of tube fittings and adapters to the ISO6149 standard.

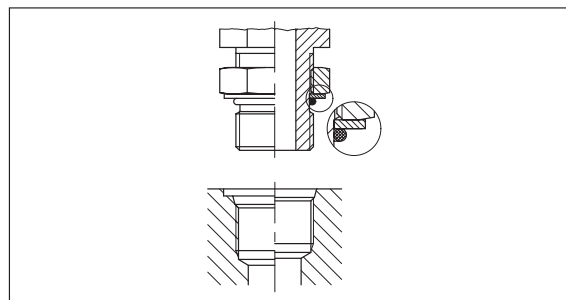

Fig. 7 – Adjustable UNF Port connection

Japanese Industrial Standard (JIS) adapters

JIS adapters are typically used as hose adapters on equipment designed or built in Japan or Korea. Sealing is achieved with a line contact between the surfaces of mating 60 degree cones on the fitting and the hose end. These adapters are made according to the JIS B8363 standard. Although they have the same cone angle and threads as the BSPP 60 degree cone adapters below, they are not interchangeable. (Longer thread lengths on the JIS female swivel fittings lead to threads bottoming out before the seal is made on the corresponding BSPP fitting).

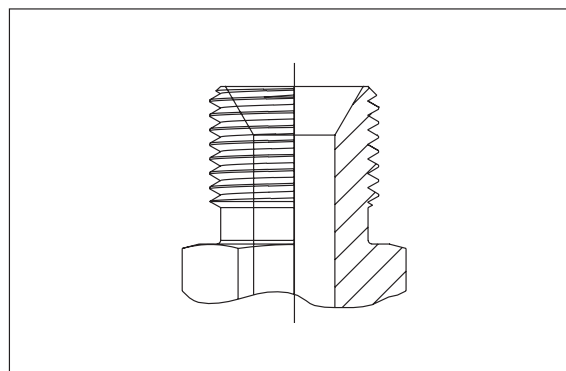

Fig. 8 – JIS adapter

BSPP thread adapters

British Standard Pipe (Parallel) threads are still the most widely type used today in the Fluid Power Industry in Europe. This section is split into two parts, covering the thread adapters and later the BSP hose adapters.

Function of 60 Deg cone

This form of BSPP adapter which has been modified to work as a hose adapter is still popular in the UK, Scandinavia and throughout the rest of Europe. These connections are standardised in BS5200. The bore of the BSPP thread is coned inwards with a 60 degree includ-

Function of fittings

ed angle to match with a male cone of the same angle on a Swivel Female hose end see figure 9 below. When the nut is tightened, the two cone halves are clamped together to form a metallic seal. This type of connection is flexible in use, since the same thread end could also be used to screw into a BSPP threaded port.

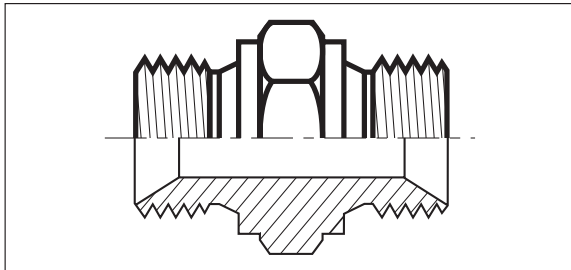

Fig. 9 – BSPP 60° cone adapter

Despite this flexibility, these adapters cannot be used as tube fittings in the same way as Triple-Lok®, O-Lok® or EO fittings, and therefore cannot be classed as a “universal system”.

Many manufacturers produce the elbow and tee adapters by brazing together straight parts. This can result in the fitting being effectively annealed during the brazing process, and therefore the material is left in it's softest state. Parker tees and elbows are manufactured from high integrity forgings and offer superior long term performance.

Function of BSPP thread adapters

BSPP thread adapters are designed to work with ports that have been machined with a flat ‘spot face’ concentrically around the thread. This spot face provides a consistent flat sealing area, whether the port is in a machined valve block, or on the face of a pump housing casting. Originally, the sealing was in the form of a copper (or other ductile metal) washer, but today most adapters use some form of elastomeric seal.

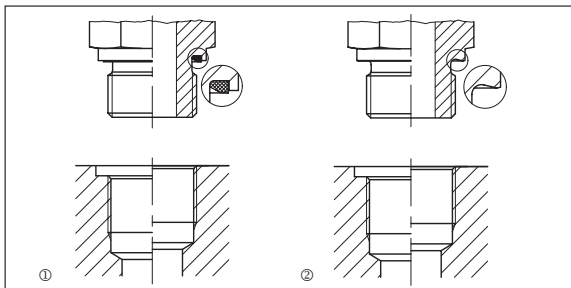

Fig. 10 – ① ED-seal; ② Form B

The highest performance is achieved by the ED seal version, followed by the O-ring and retainer ring, bonded washer and lastly the German “Form-B” metallic sealed design. In terms of adjustable fittings, they are only normally available in the O-ring and retainer version. The ED seal design does not lend itself to adjustability.

Metric thread adapters

Metric thread adapters have developed in parallel with the BSPP threaded adapters with a similar design based around the metric thread sizes.

Pipe (NPSM) swivel adapters

Function of NPSM swivels

NPSM swivel adapters are designed for use with male NPT/NPTF hose fittings that have a 30° machined seat. NPSM adapters do not seal on the threads like most NPT thread adapters, they seal on the nose of the NPSM swivel and the seat on the male NPT/NPTF pipe thread. This creates a metal to metal seal as shown in Fig. 11. The most important preparation prior to assembly is to make certain that the mating male NPT/NPTF pipe thread has a 30° seat as shown in Fig. 12.

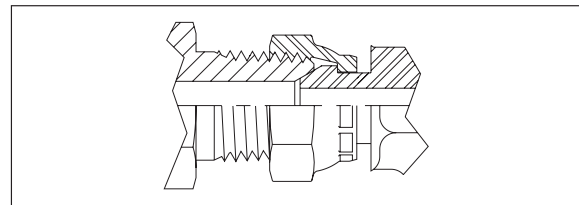

Fig. 11 – Illustration showing how NPSM swivel adapters seal on mating chamfer in male NPT thread

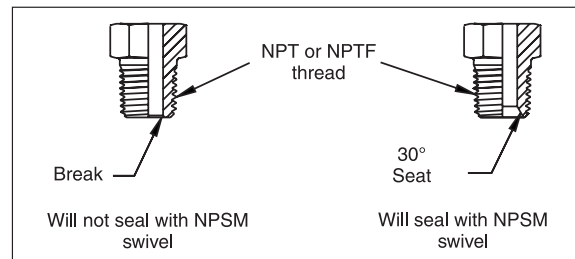

Fig. 12 – Illustration showing the required 30° seat on NPT/NPTF threads for NPSM swivel to seal

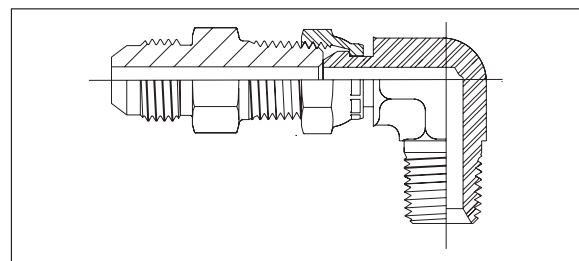

Fig. 13 – Chamfer of NPT/NPTF male thread does not provide appropriate contact for a reliable seal with cone of NPSM swivel

Thread configurations

| | | |
|---|--|---|
| Taper thread adapters NPTF and | | NPTF thread SAE J476-B2 |
| | | BSPT taper thread ISO 7 |
| BSPT | | BSPT taper thread ISO 7 |
| BSPP 60° cone adapters | | BSPP male parallel thread 60° female cone BS5200 |
| | | BSPP female parallel thread 60° male cone BS5200 |
| JIS adapters | | BSPP male parallel thread JIS B8363 60° female cone |
| | | BSPP female parallel thread JIS B8363 60° male cone |
| 37° Flare (Triple-Lok®) and | | SAE 37° Flare UNF thread SAE J514 ISO 8434-2 |
| | | ORFS (O-ring Face Seal) UNF thread SAE J1453 ISO 8434-3 |
| ORFS (O-Lok®) adapters | | BSPP parallel thread O-ring and retaining ring according to ISO 1179 |
| | | BSPP parallel thread with ED seal according to ISO 1179-2 |
| | | Metric parallel thread with ED seal according to ISO 9974-2 |
| | | Metric straight thread ISO 6149-2+3 |
| | | UN/UNF threads SAE J475 thread ISO 11926-2/-3 |
| Male studs and female port threads | | BSPP parallel thread O-ring and retaining ring according to ISO 1179 |
| | | BSPP parallel thread with ED seal according to ISO 1179-2 |
| | | Metric parallel thread with ED seal according to ISO 9974-2 |
| | | Metric straight thread ISO 6149-2+3 |
| | | UN/UNF threads SAE J475 thread ISO 11926-2/-3 |
| NPSM female Swivel adapters | | Hose adapters National pipe straight thread for mechanical joint 30° cone male / NPTF male thread. SAE J516 |

Function of fittings



Systematic fitting selection

Systematic fitting selection

Introduction

Product selection

Ultimate target is to find the “best solution”. This optimum solution provides high system reliability, easy assembly characteristics, low maintenance effort and avoids the use of exotic components.

This “best solution” is not the ultimately achievable technology, but an adequate solution which fulfils the requirements of the individual application with minimum system cost.

The “best solution” looks different depending on the specific criteria of the given application.

Dry Technology

Modern HPCE fittings are designed for high reliability, easy assembly and lowest total cost performance.

These products are marked *Dry Technology* and indicated grey in selection charts.

Parker recommends to select only *Dry Technology* products for all new designs.

Design criteria for fitting selection

Step 1

First clarify all design criteria for the given application or project.

Step 2

Then determine the “best solution” product. Use selection charts on following pages.

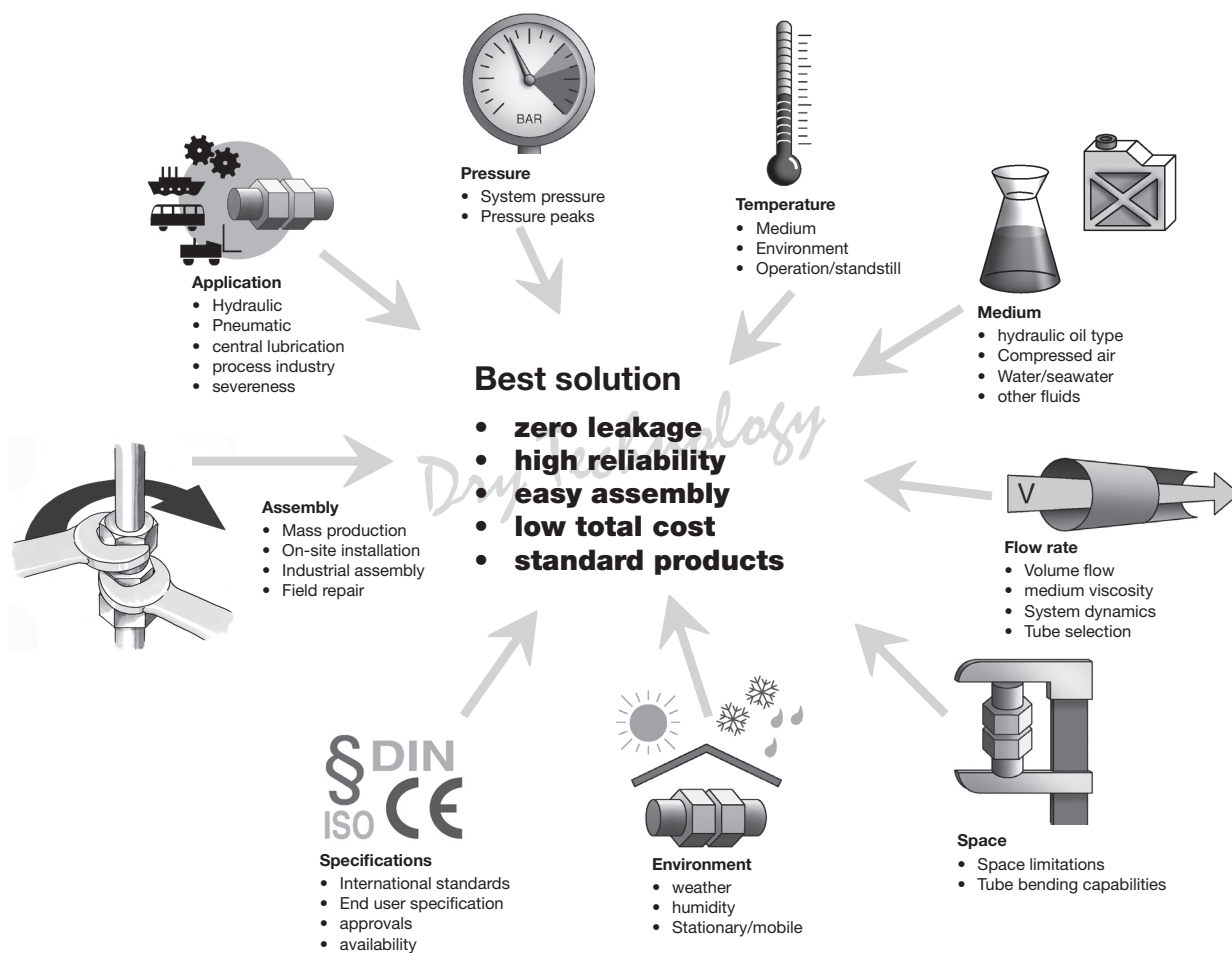

Material selection: Fitting material

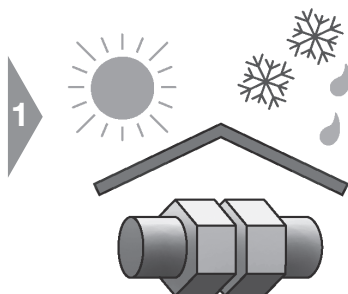
B

Environment

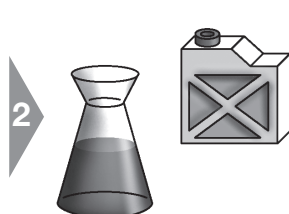
- select fitting material with suitable corrosion resistance

Medium

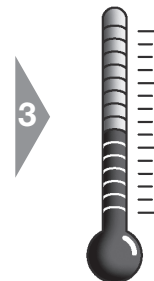
- select compatible fitting material

Temperature

- check suitability

| Tube Material: Fitting material: | Steel, zinc-plated Steel, zinc-plated | Stainless steel Stainless steel | Copper Brass | Stainless steel Steel | Plastic Steel, Stainless steel, Brass |
|-------------------------------------|--|--|---|---|--|
| Performance characteristics: | | | | | |
| Pressure capability | Excellent | Excellent | Good | Excellent | Low |
| External temperature capability | Very good | Excellent | Very good | Very good | Depending on tube and material |
| Corrosion resistance | Good | Excellent | Very good | Good | Good |
| Internal media compatibility | Good | Excellent | Very good | Good | Good |
| Current use | Standard material combination for general use in hydraulic systems | Standard material combination for use with aggressive media or application in corrosive environments | Low to medium pressure applications in corrosive environment Use with compressed air (condensed water) or slightly corrosive media (water) | Special material combination for mildly corrosive environments | Special material combination for low pressure applications |
| Typical applications: | Machine tools, Mobile construction equipment | Shipbuilding, Offshore exploration, Process engineering, Paper machines costal installations | Central lubrication systems, Pneumatics, cooling water tubes | Some airbrake systems in railway industry wet machining area on machine tools | Pneumatic systems on machine tools central lubrication and airbrakes in truck industry |

Special Materials

"Due to their reliability and corrosion resistance, the austenitic stainless steel that we offer usually meet all the demands in markets, including the oil and gas, marine engineering, power generation, or pulp and paper among others.

However, the unique requirements of some of the projects often demand special approaches. Parker High Pressure Connectors Europe division understand those needs and has the technical knowledge and experience to help our customers to find the better solutions for their applications and meet even the most challenging demands. 1.4547 (6Mo), 1.4539, 2.1972 (CuNiFe), Inconel or other alloys might be offered on request."

Systematic fitting selection

Material selection: Sealing material

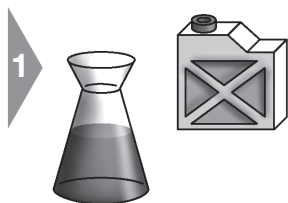

Medium

- select compatible fitting material

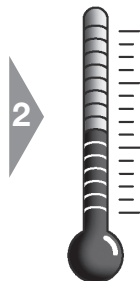

Temperature

- check suitability

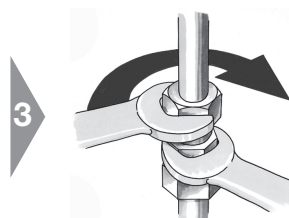

Assembly

- Prefer elastomer sealing for easy assembly and economic service

| Sealing technology | metal-to-metal | nitrile rubber (NBR)-Elastomer | Fluorocarbon (FKM)-Elastomer |
|-------------------------------------|---|---|--|
| Performance characteristics: | | | |
| High pressure capability | Good | Excellent | Excellent |
| Low temperature capability | Excellent | Very good | Good |
| High temperature capability | Excellent | Good | Very Good |
| Media compability | Excellent | Good | Very Good |
| Long term reliability | Good | Excellent | Excellent |
| Assembly characteristics: | | | |
| Ease of initial assembly | Good | Excellent | Excellent |
| Repeated assembly | Good | Excellent | Excellent |
| Replacement of seal | Not possible | Easy | Easy |
| Current use | Suitable for aggressive media respectively for very low or very high temperatures | General use in – hydraulic – pneumatic – lubrication – airbrake systems | Hydraulic and pneumatic systems with high operating temperature process engineering: some aggressive media |
| Typical applications: | Process engineering Agricultural Equipment | Machine tools Hydraulic presses Mobile construction equipment | Steelmill equipment Casting machines |

LL/L/S Series selection for EO fittings

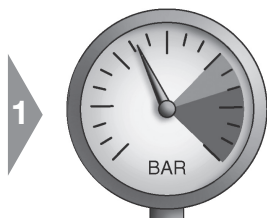
B

Pressure

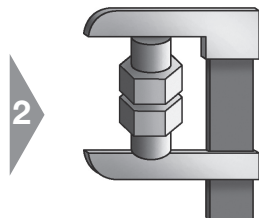
- select series with adequate pressure performance

Space

- select series according to available space



Specification

- prefer L or S series for best availability

| Series | LL | L | S |
|--|---|--|--|
| Example of order code | G06ZLLCF | G06ZLCF | G06ZSCF |
| Design | Very light | Light | Heavy |
| Performance PN | 100 bar | 160–500 bar | 315–800 bar |
| Suitability for heavy duty applications | Good | Good | Excellent |
| Tube dimension (mm) | 4, 6, 8, 10, 12 | 6, 8, 10, 12, 15, 18, 22, 28, 35, 42 | 6, 8, 10, 12, 14, 16, 20, 25, 30, 38 |
| Assembly Tightening effort Space requirement | Very low Very low | Normal Low | High High |
| Current use | Very light design for space-limited assemblies in low to medium pressure applications | medium to high pressure fitting for general use in hydraulic and pneumatic systems | Rigid design for use in heavy-duty applications |
| Typical applications: | Central lubrication Airbrake systems fuel lines oil/gas stoves micro hydraulics | machine tools agricultural vehicles | hydraulic presses plastic injection molding steel mills shipbuilding Mobile construction equipment |

Systematic fitting selection

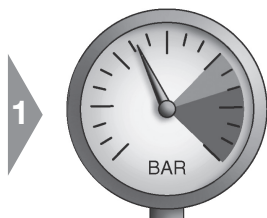
Tube end selection



Pressure

- select connection type with adequate pressure performance
- prefer elastomeric seal for most reliable sealing performance

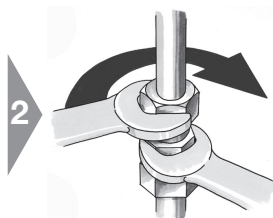

Assembly

- select product with adequate assembly process

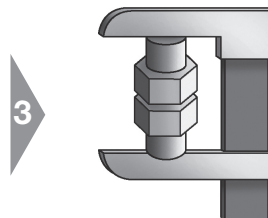

Space

- select most suitable product



Specification

- fitting type according to project specification

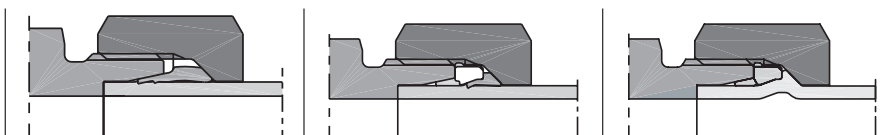

| Type | EO PSR/DPR Metal seal bite type | EO-2 Soft seal bite type | EO2-Form Tube forming |
|--|--|--|--|
| Sealing method | Metal seal | Elastomeric seal | Elastomeric seal |
| International Standard | ISO 8434-1 | ISO 8434-1 | ISO 8434-1/4 |
| National Standards | DIN EN ISO 8434-1 (old: DIN 2353/DIN 3861) | DIN EN ISO 8434-1 (old: DIN 2353/DIN 3861) | DIN EN ISO 8434-1 (old: DIN 3861) |
| Tube compatibility | Metal and plastic tube (steel, stainless steel, copper, aluminium, polyamide ...) | | Steel, stainless steel, copper alloy |
| Available sizes (Tube O.D.) | 4LL-12LL 6L-42L 6S-38S | 4LL-6LL 6L-42L 6S-38S | Tube O.D. 6 to 42 mm 6L-42L 6S-38S |
| Performance seal reliability | Very good | Excellent | Excellent |
| Assembly Tube preparation Installation Field repair | Excellent Good Very good | Excellent Very good Excellent | Good Excellent Use EO2 |
| Space requirements | Excellent | Excellent | Good |
| Current use | Most popular fitting for metric tube | | Heavy duty alternative to EO/EO2 and EO weld nipple |
| | Traditional bite type fitting new designs | Global popularity for all | |
| Typical applications | General use in hydraulic, pneumatic, lubrication and coupling systems | | General use in high pressure applications |
| | Agricultural equipment Process engineering | Hydraulic presses Injection Molding Mobile equipment Heavy machinery Ship building | |

Systematic fitting selection

Tube end selection

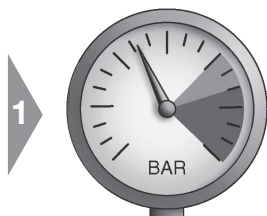
B

Pressure

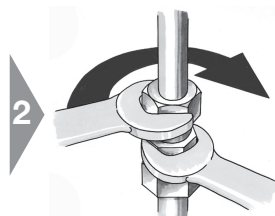
- select connection type with adequate pressure
- prefer elastomeric seal for most reliable sealing performance

Assembly

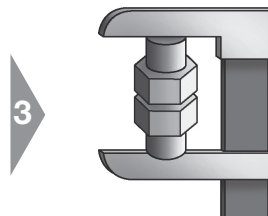
- select product with adequate assembly process

Space

- select most suitable product



Specification

- fitting type according to project specification

| Type | EO SKA Weld nipple | O-Lok® O-Ring Face Seal (ORFS) | Triple-Lok® 37° Flare | Ferulok® Flareless Tube Fitting |
|--|--|--|---|---|
| Sealing method | Elastomeric seal | Elastomeric seal | Metal seal | Metal seal |
| International Standard | ISO 8434-1/4 | ISO 8434-3 | ISO 8434-2 | |
| National Standards | DIN EN ISO 8434-1/-4 (old: DIN 3865) | SAE J1453/J516 | SAE J514/J516 | SAE J514 / MIL-F-18866H |
| Tube compatibility | Weldable steel and stainless steel | Metal tube (steel, stainless steel, copper, aluminium) | | Metal and plastic tube (steel, stainless steel, copper, aluminium, nylon, polyethylene) |
| Available sizes (Tube O.D.) | 6L-42L 6S-38S | Tube O.D. 6 to 50 mm Tube O.D. 1/4" to 2" | Tube O.D. 6 to 42 mm Tube O.D. 1/8" to 2" | Tube O.D. 1/8" -2" |
| Performance seal reliability | Excellent | Excellent | Very good | Very good |
| Assembly Tube preparation Installation Field repair | Difficult Excellent Difficult | Good Excellent Use braze adapter | Good Excellent Hand flaring | Excellent Good Very good |
| Space requirements | Very good | Good | Very good | Excellent |
| Current use | Limited use in Northern Europe and Asia | Heavy duty <i>Dry Technology</i> alternative to Triple-Lok® | | North America, limited use in Asia and Europe |
| | | Most popular fitting for inch tube (metric tube on request) | | |
| | | USA, Europe, gaining acceptance in Asia. | Worldwide | |
| Typical applications | Limited use for special applications | General use in high pressure-hydraulic | General use in hydraulic, pneumatic, lubrication and coupling systems | General use in hydraulic, pneumatic and lubrication systems |
| | Heavy machinery Ship building power plants | Mobile equipment Injection Molding Hydraulic presses Heavy machinery Ship building | Agricultural equipment* Process engineering | Process engineering, railways, mobile equipment |

Systematic fitting selection

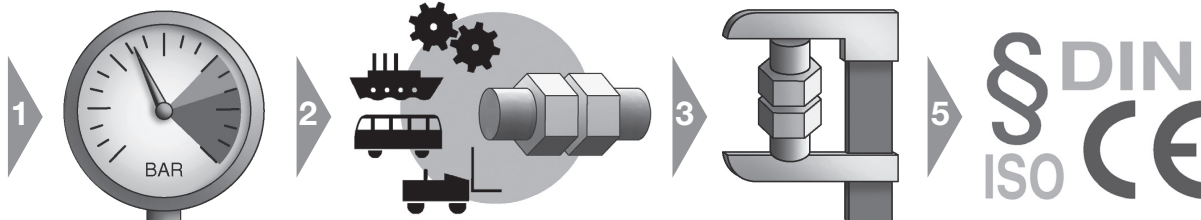
Flange type selection



Pressure

- select flange type connection with adequate pressure performance

Application

- select suitable flange type for specific application

Space

- select flange type according to available space

Specification

- select flange type according to project specification

| Flange type | Four screw split flange | Four screw one piece square flange | Gear pump flanges |
|--|---|--|---|
| Sealing method | Elastomeric seal | Elastomeric seal | Elastomeric seal |
| International standard | ISO 6162-1/-2 | ISO 6164 (1994) | |
| National standard | DIN ISO 6162-1/-2/SAE J518 | – | – |
| Tube compatibility | Combines weld and thread connections | Combines weld and thread connections | thread connection |
| Available sizes (Tube O.D.) | 1/2" up to 5" | 3/8" up to 4" | 10L-42L 16S-30S |
| Performance seal reliability | Excellent | Excellent | Excellent |
| Assembly Tube preparation Installation Field repair | Good Excellent Good | Good Excellent Good | Good Excellent Good |
| Space requirements | Low | Low | Low |
| Used screws | metric screws according to: ISO 4762-10.9 (DIN 912-10.9) or higher quality UNC bolts according to ANSI/ASME B 18.3* | metric screws according to: ISO 4762-8.8 (DIN 912-8.8) or ISO 4762-10.9 (DIN 912-10.9) | metric screws according to: ISO 4762-8.8 (DIN 912-8.8) |
| Current use | Widely used throughout the world | Mainly used in Germany | Mainly used in Europe |
| Typical applications | Agriculture Hydraulic Offshore Ship building Cranes | Agriculture Hydraulic Offshore Ship building Cranes | Agriculture Hydraulic Offshore Ship building Cranes |

*UNC bolts acc. to ISO 6162-1 and -2 should not be used for new designs.

Port/Stud selection

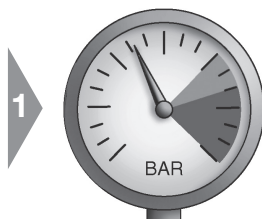
B

1

Pressure

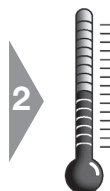
- select connection with adequate pressure performance

2

Temperature

- Use elastomeric seal when suitable

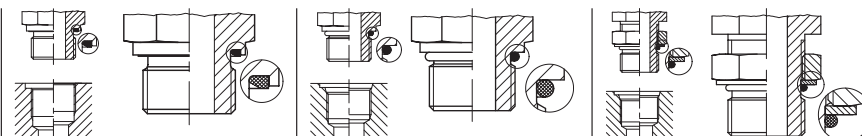

| Port end selection: | Male stud with EOLASTIC-seal | Male stud with O-Ring seal | Male stud adjustable with O-Ring seal |
|--|---|--|---|
| Port description metric | Male stud with EOLASTIC-sealing | Male stud with O-ring sealing | Male stud adjustable with O-ring sealing |
| Thread | Metric | Metric | Metric |
| Example of order code EO = | GE12ZLMEDCF | GE012ZLMCF | VEE12ZSMORCF |
| Example of order code Triple-Lok® = | 8M16F82EDMXS | 8M16F870MXS; | 8M18V870MXS |
| Example of order code O-Lok® = | 8M16F82EDMLOS | 8M16F870MLOS | 8M18V870MLOS |
| Thread standard (Example) | M 16×1.5 ISO 261; ISO 724; DIN 13-T5-T7 | M 16×1.5 ISO 261; ISO 724; DIN 13-T5-T7 | M 18×1.5 ISO 261; ISO 724; DIN 13-T5-T7 |
| Male stud standard | DIN EN ISO 9974-2 (old: DIN 3852 T11, type E) | DIN ISO 6149-2/3 (old: DIN 3852 T3, type F) | DIN ISO 6149-2/3 |
| Port tapping standard | DIN EN ISO 9974-1 (old: DIN 3852 T1, type X, Y) | DIN ISO 6149-1 (old: DIN 3852 T3, type W) | DIN ISO 6149-1 (old: DIN 3852 T3, type W) |
| Performance characteristics – pressure capacity – sealing characteristics – additional sealant required | Very high Excellent No | Very high Excellent No | High Very good No |
| Current use | Solid, soft sealing male studs. Known worldwide. Well suitable for using with gas and high pressure hydraulics. | New safe sealing system for all areas of application, especially suitable for high pressure hydraulics. Standard sealing for the future. Identifying marking for metric version is a groove at the collar. | New safe adjustable sealing system for all areas of application, especially suitable for high pressure hydraulics. Standard sealing for the future. |
| | Well suitable for softener for counter material (e.g. housing of Al-alloy). | | |
| Port description inch | Male stud with EOLASTIC-sealing | Male stud with O-ring sealing | Male stud adjustable with O-ring sealing |
| Thread | BSP | UN/UNF threads | UN/UNF threads |
| Example of order code EO = | GE12ZLR1/4EDCF | GE12ZL3/4UNFCF | VEE12ZL3/4UNFCF |
| Example of order code Triple-Lok® = | 8-4F42EDMXS | 8F50XS | 8V50MXS |
| Example of order code O-Lok® = | 8-4F42EDMLOS | 8F50MLOS | 8V50MLOS |
| Thread standard (Example) | G 1/4 A DIN/ISO 228-T1 BS 2779 | 3/4-16 UNF ISO 725/ANSI B1.1-1974 | 3/4-16 UNF ISO 725/ANSI B1.1-1974 |
| Male stud standard | DIN 3852 T11, type E ISO 1179-2 | ISO 11926-2/3 | ISO 11926-2/3 |
| Port tapping standard | DIN 3852 T2, type X, Y ISO 1179-1 | ISO 11926-1 | ISO 11926-1 |
| Performance characteristics – pressure capacity – sealing characteristics – additional sealant required | Very high Excellent No | Very high Excellent No | High Very good No |
| Current use | Solid, soft sealing male studs. Known worldwide. Well suitable for softener counter material (e.g. housing of Al-alloy). Well suitable for using with gas and high pressure hydraulics. | Predecessor of metric sealing system. Often used in USA. Well suitable for softener counter material (e.g. housing of Al-alloy). Well suitable for using with gas. | Predecessor of metric adjustable sealingsystem. Often used in USA. Well suitable for softener counter material (e.g. housing of Al-alloy). |

Systematic fitting selection

Port/Stud selection

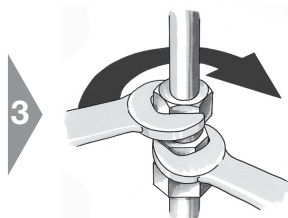

Assembly

- prefer O-Ring/ ED-seal for easy assembly and economic service
- avoid tapered threads

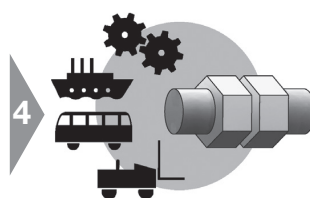

Application

- select standard connection for specific application

| Port end selection: | Male stud O-ring retainer ring | Male stud adjustable with O-ring seal and Backup washer | Male stud with sealing by cutting face |
|--|---|---|---|
| Port description metric | Male stud adjustable with O-ring sealing | Male stud adjustable with O-ring sealing | Male stud with sealing by cutting face |
| Thread | Metric | Metric | Metric |
| Example of order code EO = | – | VEE12ZSMCF | GE12LMCF |
| Example of order code Triple-Lok® = | 8M16F80MXS | 8M18V80MXS | – |
| Example of order code O-Lok® = | – | 8M18V80MLOS | – |
| Thread standard (Example) | M 18×1.5 ISO 261; ISO 724; DIN 13-T5-T7 | M 18×1.5 ISO 261; ISO 724; DIN 13-T5-T7 | M 16×1.5 ISO 261; ISO 724; DIN 13-T5-T7 |
| Male stud standard | – | – | DIN EN ISO 9974-3 (old: DIN 3852 T3, type B) |
| Port tapping standard | DIN EN ISO 9974-1 (old: DIN 3852 T1, type X, Y) | DIN EN ISO 9974-1 (old: DIN 3852 T1, type X, Y) | DIN EN ISO 9974-1 (old: DIN 3852 T1, type X, Y) |
| Performance characteristics – pressure capacity – sealing characteristics – additional sealant required | Medium Good No | Medium to high Good No | High Medium to good No |
| Current use | | New adjustable sealing system for all areas of application. | Suitable for aggressive media respectively for very low or high temperatures, where elastic sealing cannot be used. |
| | Used in Europe and Asia-Pacific areas. | | |
| | Well suitable for softer counter material/e. g. housing of Al-alloy. | | |
| Port description inch | Male stud adjustable with O-ring sealing | Male stud adjustable with O-ring sealing and Backup washer | Male stud with sealing by cutting face |
| Thread | BSP | BSP | BSP |
| Example of order code EO = | – | VEE12ZLRFCF | GE12LR1/4CF |
| Example of order code Triple-Lok® = | 8-F40MXS | 8V40MXS | – |
| Example of order code O-Lok® = | – | 8V40MLOS | – |
| Thread standard (Example) | G 3/8 A DIN/ISO 228-T1 | G 3/8 A DIN/ISO 228-T1 | G 1/4 A DIN/ISO 228-T1, BS 2779 |
| Further standards | GB: 1/4 BSPP, Japan: 1/4 PF | GB: 1/4 BSPP, Japan: 1/4 PF | GB: 1/4 BSPP, Japan: 1/4 PF |
| Male stud standard | ISO 1179-3 | ISO 1179-3 | DIN 3852 T2, type B, ISO 1179-4 |
| Port tapping standard | ISO 1179-1; DIN 3852 T2, type X, Y | ISO 1179-1; DIN 3852 T2, type X, Y | DIN 3852 T2, type X, Y, ISO 1179-1 |
| Performance characteristics – pressure capacity – sealing characteristics – additional sealant required | High Very good No | Medium to high Good No | High Medium to good No |
| Current use | Used in Europe and Asia-Pacific areas. | Solid, soft sealing male studs. Known worldwide. | Suitable for aggressive media respectively for very low or high temperatures, where elastic sealing cannot be used. |
| | Well suitable for softer counter material (e.g. housing of Al-alloy). | | |

Port/Stud selection

B



Specification

- select connection type according to project specification
- prefer international standards
- select ISO 6149 for new designs

| Port end selection: | Male stud with sealing by metal sealing ring | Male stud with sealing by taper thread | Male stud with sealing by taper thread | Male stud with sealing by taper thread |
|--|--|--|---|---|
| Port description metric | Male stud with sealing by metal sealing ring | Male stud with sealing by taper thread | – | Male stud with sealing by taper thread |
| Thread | Metric | NPT | – | Metric |
| Example of order code EO = | GE12LMACF | GE12L1/2NPTCF | – | GE08LLMCF |
| Example of order code Triple-Lok® = | – | 8-8FMTXSS | – | – |
| Example of order code O-Lok® = | – | 8-8FLOSS | – | – |
| Thread standard (Example) | M 16×1.5; ISO 261; ISO 724; DIN 13-T5-T7 | 1/2-14 NPT ANSI B1.20.1-1983 | – | M 10×1.0 tap. DIN 158 |
| Male stud standard | DIN 3852 T1, type A DIN 7603 (Sealing washer) | ANSI B1.20.1-1983 | – | DIN 3852 T1, type C |
| Port tapping standard | DIN EN ISO 9974-1 (old: DIN 3852 T1, type X, Y) | ANSI B1.20.1-1983 | – | DIN 3859 T1, type Z (parallel) |
| Performance characteristics – pressure capacity – sealing characteristics – additional sealant required | Low Medium No | Very high Medium Yes | – | Low Medium Yes |
| Current use | Partly used for pneumatics and gas applications. | Mainly used in North America. Some used in rest of the world. Male studs and port tapping are tapered. Sealing only achieved with fluid or plastic sealing material. | – | Only for low requirements due to parallel port. Leakfree performance is only achieved with fluid or plastic thread sealing material. Mainly used in Germany. |
| Port description inch | Male stud with sealing by metal sealing ring | Male stud with sealing by taper thread | Male stud with sealing by taper thread | Male stud with sealing by taper thread |
| Thread | BSPP | NPTF | BSPT | Shorter BSPT |
| Example of order code EO = | GE12LR1/4ACF | – | GE12LR1/2KLCF**) | GE12LR1/4KEGCF |
| Example of order code Triple-Lok® = | – | 12FMTXS | 8-8F3MXS | – |
| Example of order code O-Lok® = | – | 12FLOS | – | – |
| Thread standard (Example) | G 1/4 A DIN/ISO 228-T1 BS 2779 | 3/4-14 NPTF ANSI B1.20.3-1983 | R 1/2 ISO 7; DIN 2999-1 BS 21 | R 1/4 (short) DIN 3858 |
| Further standards | GB: 1/4 BSPP; Japan: 1/4 PF | – | GB: 1/4 BSPT; Japan: 1/4 PT | – |
| Male stud standard | DIN 3852 T2, type A DIN 7603 (Sealing washer) | SAEJ 476a | ISO 7; DIN 2999-1 | DIN 3852 T2, type C |
| Port tapping standard | DIN 3852 T2, type X, Y ISO 1179-1 | SAEJ 476a ANSI B1.20.3 | ISO 7/1-Rp/Rc; DIN 2999-Rc BS 21-Rp/Rc; Japan PT-Port | DIN 3852 T2, type Z (parallel) |
| Performance characteristics – pressure capacity – sealing characteristics – additional sealant required | Low Medium No | Very high Medium Recommended | Medium Medium Yes | Low Medium Yes |
| Current use | More and more unimportant. Partly used for pneumatics. | Mainly used in North America. Male studs and port tapping are tapered. The same as NPT except that closer tolerances are held to assure metal to metal contact (dryseal thread). | Mainly used in GB and Asia-Pacific areas. Male studs are tapered. Ports are mainly tapered, but can be parallel also. Leakfree performance is only achieved with fluid or plastic thread sealing material. **)Male stud end not included in the catalogue! | Only for low requirements due to parallel port. Leakfree performance is only achieved with fluid or plastic thread sealing material. Mainly used in Germany. Not to be used for BSPT ports and PT ports (Japanese Standard) due to poor thread engagement! |

Systematic fitting selection

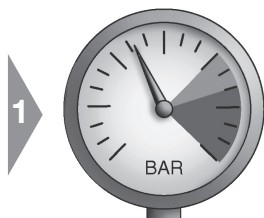
Orientable Fitting Selection



Pressure

- pre-select orientable fitting with sufficient pressure performance
- prefer elastomeric seal for most reliable sealing performance

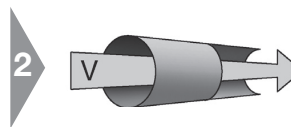

Flow Rate

- select optimum solution for best flow rate and available space

| Type | 90° tube bend and male stud | | Swivel Elbow | | Adjustable Elbow |
|-----------------------|---|---|---|---|---|
| | | | | | |
| EO: | GE12LMCF | GE12ZLMEDCF | EVW | EW | WEE |
| Triple-Lok®: | FMTX, F3MX | F82EDMX | – | F82EDMX+C6MX | C80MX |
| O-Lok®: | – | F82EDMLO | – | F82EDMLO+C6MLO | C80MLO |
| Design | DPR/PSR Triple-Lok® Metal sealed port | EO-2 O-Lok® Elastomeric sealed port | Adjustable elbow with preassembled EO-DPR/PSR | Adjustable elbow with swivel nut connection | Adjustable Elbow with adjustable male stud |
| Sealing method | Metal | Elastomeric | Metal | Elastomeric | Elastomeric |
| Performance | | | | | |
| pressure | Good | Excellent | Good | Excellent | Very good |
| Seal reliability | Good | Excellent | Good | Excellent | Good |
| Flow characteristics | Excellent | Excellent | Very good | Very good | Very good |
| Compactness | Bulky | Bulky | Good | Good | Very good |
| Assembly/Installation | Very good | Excellent | Good | Excellent | Very good |
| Field repair | Good | Excellent | Good | Excellent | Difficult |
| Available sizes | Tube Outside Diameter 4 mm to 42 mm for DPR/PSR Triple-Lok® 6 mm to 50 mm and 1/4 in to 2 in | Tube Outside Diameter 4 mm to 42 mm for DPR/PSR/EO-2 Triple-Lok® and O-Lok® 6 mm to 50 mm and 1/4 in to 2 in | Tube Outside Diameter 6 mm to 42 mm for DPR/PSR | Tube Outside Diameter 6 mm to 42 mm for for DPR/PSR/EO-2 Triple-Lok® and O-Lok® 6 mm to 50 mm and 1/4 in to 2 in | Tube Outside Diameter 4 mm to 42 mm for DPR/PSR/EO-2 Triple-Lok® and O-Lok® 6 mm to 50 mm and 1/4 in to 2 in |
| Available threads | Metric ISO 9974-3 BSPP ISO 1179-4 DIN 3852 Form B NPT/NPFT | Metric ISO 6149 Metric ISO 9974-2 BSPP ISO 1179-2 UN/UNF | Metric ISO 9974-3 BSPP ISO 1179-4 DIN 3852 Form B NPT/NPFT | Metric ISO 6149 Metric ISO 9974-2 BSPP UN/UNF | Metric ISO ISO 6149 Metric ISO 9974-2 BSPP ISO 1179-2 UN/UNF |
| Current use | preferred use is not critical when space | | not for new design | general use | general use |
| Typical Applications | Agricultural Equipment process engineering | All hydraulic + pneumatic systems | Agricultural Equipment process engineering | All hydraulic + pneumatic systems | All hydraulic + pneumatic systems |

Systematic fitting selection

Orientable Fitting Selection

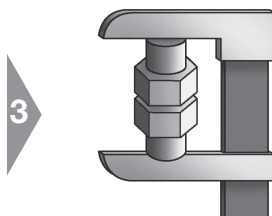
B

3
Space

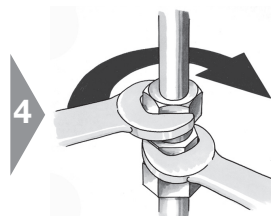
- select optimum solution for available space and best flow

4
Assembly

- check, if assembly process is suitable

| Type | Banjo | | High pressure banjo | |
|-----------------------|---|---|---|--|
| | | | | |
| EO: | DSW | SWVE | WH DKA | WH KDS |
| Triple-Lok®: | – | – | – | – |
| O-Lok®: | – | – | – | – |
| Design | Fitting body with hollow bolt and cap | Fitting body with hollow bolt | Fitting body with hollow bolt | Fitting body with hollow bolt |
| Sealing method | Metal | Metal | Metal | Elastomeric |
| Performance | Low pressure | Good | Very good | Very good |
| pressure | Good | Good | Good | Excellent |
| Seal reliability | Good | Good | Good | Good |
| Flow characteristics | Excellent | Excellent | Excellent | Excellent |
| Compactness | | | | |
| Assembly/Installation | Good | Very good | Very good | Excellent |
| Field repair | Good | Good | Good | Excellent |
| Available sizes | Tube Outside Diameter 4 mm to 42 mm for DPR/PSR | Tube Outside Diameter 4 mm to 42 mm for DPR/PSR | Tube Outside Diameter 6 mm to 42 mm for DPR/PSR | Tube Outside Diameter 6 mm to 42 mm for DPR/PSR/EO-2 |
| Available threads | – Metric DIN 3852 BSPP – | – Metric BSPP – | – Metric BSPP – | – Metric BSPP – |
| Current use | Low pressure systems only, not for new designs | Low pressure systems only | Best solution for limited application space | |
| Typical Applications | Airbrake systems Return lines | Low to medium pressure systems | Space critical applications such as: forklift trucks Mobile hydraulics | |

Systematic fitting selection

Standardization



Specification

- select fittings according to international standardisation
- check specification of end-customer/end user
- consider project-specific guidelines
- avoid non-standard items

| ISO-fitting standards | | | | National Standards | |
|--|---|--|--|---|---|
| EO 24° fittings DIN EN ISO 8434-1/-4 (former: DIN 2353) | Triple-Lok® ISO 8434-2 • 37° flared fittings | O-Lok® ISO 8434-3 • O-ring face seal fittings | K4 Adapter ISO 8434-6 • BSPP 60° cone adapter | P4 Adapter JIS B 8363 JIS BSPP 60° cone dapter | NPSM-Adapter SAE J 516 NPTF 30° cone |

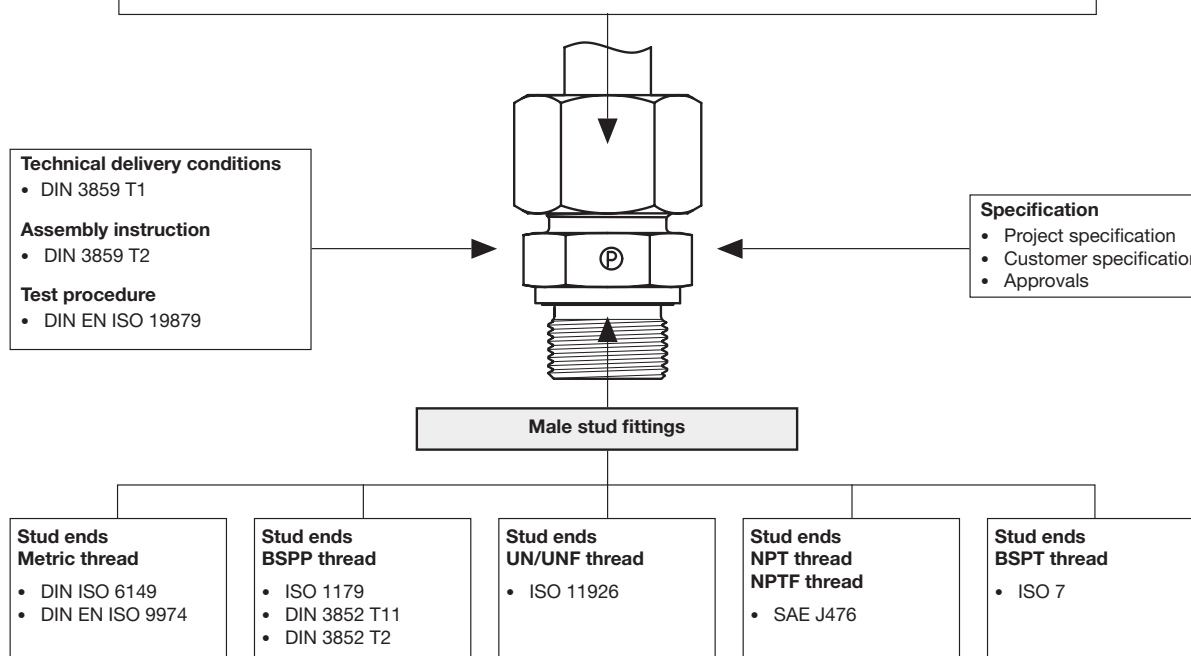

Approvals

Parker tube fittings are recognized by various acceptance organizations, among which are:

Germanischer Lloyd (GL)
Lloyds Register of Shipping (LR)
Det Norske Veritas (DNV)
American Bureau of Shipping (ABS)
Russian Maritime Register of Shipping (RMS)
China Classification Society (CCS)
Deutscher Verein des Gas- und Wasserfaches (DVGW)

For other applications, Parker tube fittings also approved by diverse national authorities.

Numerous original equipment manufacturers and end-users of various industries have approved Parker tube fittings.

Attention:

Type Approvals usually are limited to certain products, applications, working conditions, validity time or other restrictions. We gladly inform you on your individual application and send out the required documentation.

Systematic fitting selection

Tube Specifications

Tubes with metric outside diameters

B

| Tube material Steel | Speci- fication | Construction | Condition | Tolerances OD/ wallthickness | Surface | Suitable fitting systems | | | | Note |
|------------------------|--------------------|---------------------|-------------------------|---------------------------------|--------------------------------|--------------------------|--------------|---------|--------|------|
| | | | | | | DPR/PSR/ EO-2 | EO-2 Form | T- Lok® | O-Lok® | |
| E235 (= 1.0308) | DIN EN 10305-4 | Seamless cold drawn | +N (= normal annealed) | EN 10305-4 | phosphated, oiled or A3C or CF | X | X | X | X | 1) |
| R37 | ISO 3304 | | NBK (= normal annealed) | ISO 3304 | | X | X | X | X | 2) |
| E355 (= 1.0580) | DIN EN 10305-4 | | +N (= normal annealed) | EN 10305-4 | | X | X | X | X | 3) |
| R50 | ISO 3304 | | NBK (= normal annealed) | ISO 3304 | | X | X | X | X | 4) |

| Tube material Stainless steel | Speci- fication | Construction | Condition | Tolerances OD/ wallthickness | Surface | Suitable fitting systems | | | | Note |
|----------------------------------|-------------------------------|---------------------|--|--|------------------------------------|--------------------------|--------------|---------|--------|------|
| | | | | | | DPR/PSR/ EO-2 | EO-2 Form | T- Lok® | O-Lok® | |
| 1.4571 (= TP 316 Ti) | DIN EN 10216-5 | Seamless cold drawn | CFA | DIN EN 10305-1 | plain | X | X | X | (X) | 5) |
| 1.4541 (= TP 321) | | | | | | X | (X) | X | (X) | 6) |
| 1.4404 (= TP 316L) | EN ISO 1127 or ASTM A269/A213 | | Solution heat treated (bright annealed) | D4/T3* (EN ISO 1127) or ASTM A269/A213 | | X | (X) | X | X | 7) |
| 1.4301 (= TP 304) | | | | | | X | (X) | X | X | 8) |
| 1.4306 (= TP 304L) | EN ISO 1127 | Welded tube | DIN 17457-K2 for OD 6–12 mm, cold drawn welded (CDW) with smooth outer surface for OD 14–42 mm | D4/T3* (EN ISO 1127) or ASTM A269/A213 | plain, weld seam approx. invisible | X | (X) | X | X | 9) |
| 1.4401 (= TP 316) | | | | | | X | (X) | (X) | (X) | 10) |
| 1.4301 (= TP 304) | | | | | | X | (X) | (X) | (X) | |
| 1.4541 (= TP 321) | | | | | | X | (X) | (X) | (X) | |

| Tube material Copper | Speci- fication | Construction | Condition | Tolerances OD/ wallthickness | Surface | Suitable fitting systems | | | | Note |
|-------------------------|--------------------|---------------|------------------|---------------------------------|---------------------|--------------------------|--------------|---------|--------|------|
| | | | | | | DPR/PSR/ EO-2 | EO-2 Form | T- Lok® | O-Lok® | |
| Cu DHP R290/250/200 | EN 1057 EN 12449 | Seamless tube | EN 1057 EN 12449 | EN 1057 EN 12449 | clean, smooth plain | X | X | X | X | 11) |

- 1) Recommended EO standard precision tubes for high pressure hydraulic applications. Tight tolerances for easy handling. Good bendability and weldability.
- 2) Tolerance on large tube OD's not as tight as EO tube.
- 3) Precision tubes for very high pressure hydraulic applications. Tight tolerances for easy handling. Good bendability and weldability.
- 4) Tolerance on large tube OD's not as tight as EO tube.
- 5) Recommended EO standard precision tubes for high pressure hydraulic applications. Tight tolerances (same as steel tubes) for easy handling. Good weldability and corrosion resistance. () = on request
- 6) Recommended EO standard precision tubes for high pressure hydraulic applications. Tight tolerances (same as steel tubes) for easy handling. Good weldability. () = on request
- 7) Common tube, OD. tolerance not as tight as EO tube. Good weldability and corrosion resistance. () = on request
- 8) Common tube, OD. tolerance not as tight as EO tube. () = on request
- 9) Common tube, OD. tolerance not as tight as EO tube. () = on request
- 10) Used in Pneumatic (low pressure) applications. () = Only for tube with smooth outer and inner surface.
- 11) Support sleeve "VH" may be required, e.g. for R250-28x1.5.

* = For DPR/PSR/EO-2 systems: thin walled tubes which need a support sleeve require tighter tolerance class T4. Tube O.D. tolerance class D3 is not recommended. D3 may reduce function and capability of the tube connection systems. The outside diameter tolerance is theoretically too large for EO2-FORM and an outer tube diameter of 25-42 mm.

Systematic fitting selection

Tube Specifications

Tubes with imperial (inch) outside diameters

| Tube material Steel | Specification | Construction | Condition | Tolerance OD/ wallthickness | Surface | Suitable | | Note |
|------------------------|-------------------------------------|---------------------|----------------|-------------------------------------|--------------|----------|--------|------|
| | | | | | | T- Lok® | O-Lok® | |
| Carbon steel C-1010 | SAE J524 (AMS 5050 J, ASTM A179) | Seamless | Fully annealed | SAE J524 (AMS 5050 J, ASTM A179) | plain, oiled | X | X | 1) |
| | SAE J525 | Welded and drawn | | SAE J525 | | X | X | 2) |

| Tube material Stainless steel | Specification | Construction | Condition | Tolerance OD/ wallthickness | Surface | Suitable | | Note |
|----------------------------------|-------------------------|---------------------|----------------|--------------------------------|---------|----------|--------|------|
| | | | | | | T- Lok® | O-Lok® | |
| 1.4404 (= TP 316L) | ASTM A269, ASTM A213 | Seamless | Fully annealed | ASTM A269, ASTM A213 | plain | X | X | 3) |
| 1.4301 (= TP 304) | | | | | | X | X | 4) |
| 1.4401 (= TP 316) | | | | | | X | X | |
| 1.4404 (= TP 316L) | ASTM A249, ASTM A269 | Welded and drawn | | ASTM A249, ASTM A269 | | X | X | |
| 1.4301 (= TP 304) | | | | | | X | X | |
| 1.4401 (= TP 316) | | | | | | X | X | |

| Tube material Copper | Specification | Construction | Condition | Tolerance OD/ wallthickness | Surface | Suitable | | Note |
|-------------------------|----------------------|--------------|-----------------------------|--------------------------------|---------|----------|--------|------|
| | | | | | | T- Lok® | O-Lok® | |
| Copper | SAE J528 (ASTM B-75) | Seamless | Soft annealed Temper "O" | SAE J528 (ASTM B-75) | plain | X | X | 4) |

- 1) Recommended EO tubes for Hydraulic/Pneumatic applications
- 2) Common tubes in North-America
- 3) Recommended tubes for Hydraulic/Pneumatic applications. Good weldability and corrosion resistance
- 4) Tubes in North-America

Fitting selection summary

B

Traditional bite-type fittings have been originally developed and designed for operating conditions of fluidpower systems completely different from today's and future market requirements.

New products and improved assembly technologies have been developed and introduced by Parker to fulfill today's and future requirements of the operators of fluidpower equipment. This new tube fitting generation and the according assembly methods are classified as *Dry Technology*. All qualifying products are explicitly *Dry Technology*-labelled throughout this catalogue.

For all new designs of

- hydraulic systems
- pneumatic systems,
- coolant systems,
- lubrication systems and
- sprinkler systems

only *Dry Technology*-classified components should be selected.

Dry technology versus traditional technology

EO-2 versus bite type

- + Elastomeric seal
- + Sufficient seal volume to compensate tube tolerance
- + High degree of fine sealing
- + Long-term reliability without retightening
- + No air ingress
- + Clear hit-home-feel at assembly
- + Easy assembly check
- + Integrated preassembly tool
- + No stress of inner cone of fitting body
- + No wear of preassembly tools
- + Direct assembly of stainless steel tubes possible (EO-2)
- + No galling of stainless steel threads
- + Existing tools and EOMAT machines can be used for efficient assembly (EO-2)
- + All parts integrated in Functional Nut (EO-2)
- + No confusion of individual ferrules
- + Less handling effort
- + Unlimited repeated assembly
- + Seal can be individually replaced
- + ISO-standardised (DIN EN ISO 8434-1)
- + Million times proven product since 1993 (EO-2)
- + Interchangeable with EO Progressive Ring (EO-2)
- Higher component cost than traditional bite-type fittings
- + Low total cost
- + Best value for end user
- + Mandatory specified from various industries, such as: automotive production, injection molding, mobile equipment, shipbuilding and offshore exploration
- + Globally gaining popularity

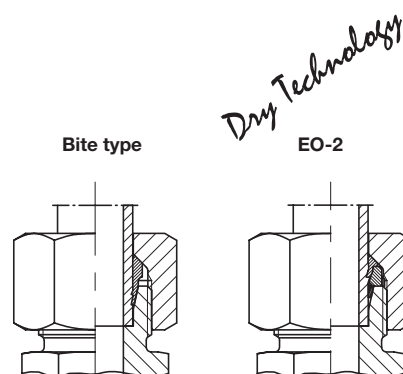

Systematic fitting selection

O-Lok® versus traditional Triple-Lok®

- + Higher pressure resistance than Triple-Lok®
- + Elastomeric seal
- + Sufficient seal volume to compensate tube tolerance
- + High degree of fine sealing
- + Long-term reliability without retightening
- + No air ingress
- + Clear hit-home-feel at assembly
- + Easy assembly check
- + Easy installation of flat-face components
- + Superior vibration resistance
- + Parflange® orbital flanging technology
- + Unlimited repeated assembly
- + Seal can be individually replaced
- + ISO-standardised (DIN EN ISO 8434-2)
- + Million times proven product
- Higher component cost than Triple-Lok®
- Parflange® machine required
- + braze sleeves can be used for field repair
- + Low total cost
- + Best value for end user
- + Mandatory specified from various industries, such as: agricultural equipment, mobile construction machines, injection molding
- + Globally gaining popularity

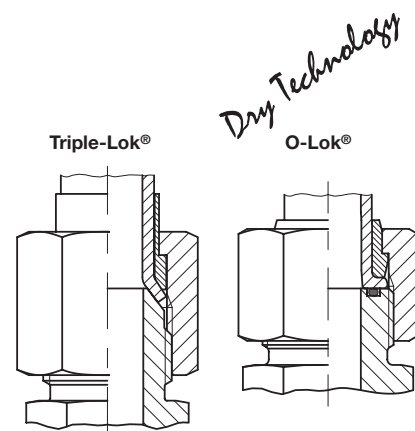

EO2-FORM versus traditional Weld nipple

- + Safe, form-fit connection
- + Easy assembly process
- + trouble-free with zinc-plated tube
- + Elastomeric seal
- + Sufficient seal volume to compensate tube tolerance
- + High degree of fine sealing
- + Long-term reliability without retightening
- + No air ingress
- + Clear hit-home-feel at assembly
- + Easy assembly check
- + Easy tube preparation
- + Easy quality inspection
- + No rework of welding
- + Use of existing EO-2 seals
- + Unlimited repeated assembly
- + Seal can be individually replaced
- + ISO-standardised (DIN EN ISO 8434-1/-4)
- + Basic product EO-2 is million times proven
- + Interchangeable with EO Progressive Ring (EO-2)
- + No new or additional components required
- Higher component cost than traditional bite-type fittings
- EO2-FORM machine required
- + EO-2 can be used for field repair
- + Low total cost
- + Best value for end user
- + Approved for application in hydraulic presses, injection molding, lifts, waterlocks and shipbuilding
- + Globally gaining popularity

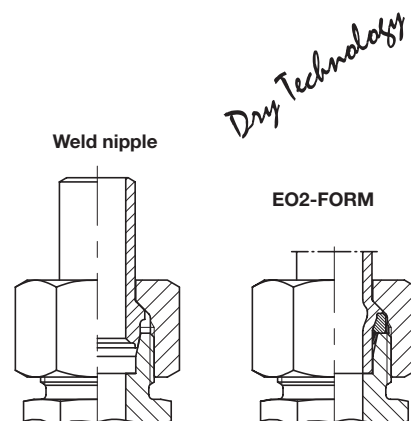

Systematic fitting selection

Swivel adjustable versus traditional standpipe

- + Elastomeric seal
- + High degree of fine sealing
- + Long-term reliability without retightening
- + No air ingress
- + Superior pressure rating
- + High mechanical strength
- + No blow-out at incomplete assembly
- + Easy fitting installation
- + No stress of inner cone of fitting body
- + No wear of preassembly tools
- + Unlimited repeated assembly
- + Seal can be individually replaced
- + ISO-standardised (DIN EN ISO 8434-1/-4)
- + Milliontimes proven product since 1970
- + Interchangeable with EO standpipe fittings
- Higher component cost than traditional standpipe fittings
- + Low total cost
- + Best value for end user
- + Mandatory specified from various industries, such as: automotive production, injection molding, mobile equipment, shipbuilding and offshore exploration
- + Most frequently used and still gaining popularity

B

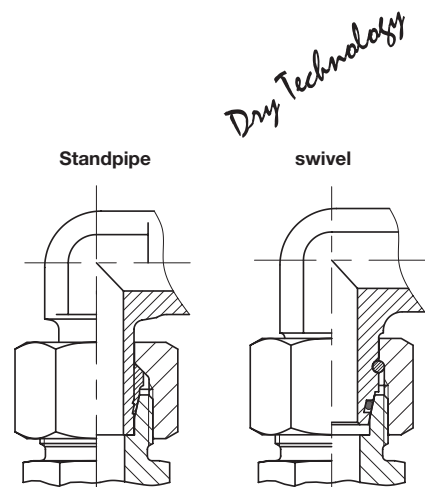

Male stud with Elastomeric or O-ring seal versus traditional Metal seal tapered thread

- + Elastomeric seal
- + High degree of fine sealing
- + Long-term reliability without retightening
- + No air ingress
- + Superior pressure rating
- + Clear hit-home-feel at assembly
- + No damage to port surface
- + Assembly and performance almost independent of port material
- + Low assembly torques
- + No metal sealing edge which may be damaged at transport or handling
- + Unlimited repeated assembly
- + Seal can be individually replaced
- + ISO-standardised (ISO 1179/ISO 6149/DIN ISO 6149)
- + Million times proven product since 1964
- + Interchangeable with traditional fittings
- + Wider product range and better availability
- Higher component cost than traditional bite-type fittings
- + Low total cost
- + Best value for end user
- + Mandatory specified from various industries, such as: automotive production, injection molding, mobile equipment, shipbuilding and offshore exploration
- + Most frequently used and still gaining popularity

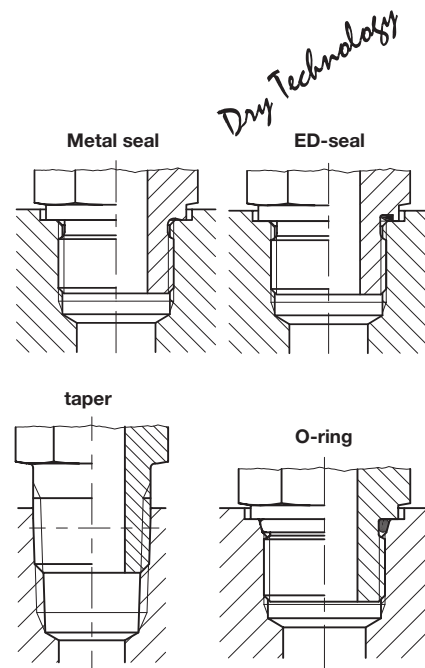

Systematic fitting selection

Locknut Adjustables versus tapered thread

- + Elastomeric seal
- + High degree of fine sealing
- + Long-term reliability without retightening
- + No air ingress
- + Good flow characteristic
- + 360° orientable
- + More compact than swivel orientable combination
- + No additional sealant required
- + Clear hit-home-feel at assembly
- + No damage to port surface
- + Assembly and performance almost independant of port material
- + Low assembly torques
- + Unlimited repeated assembly
- + Seal can be individually replaced
- + Interchangeable with traditional fittings
- + Available in 90°, 45° elbow, T- and Run-T-configuration
- Machined spot surface required
- + Lower price than Banjo fittings
- + Low total cost
- + Best value for end user
- + Globally gaining popularity

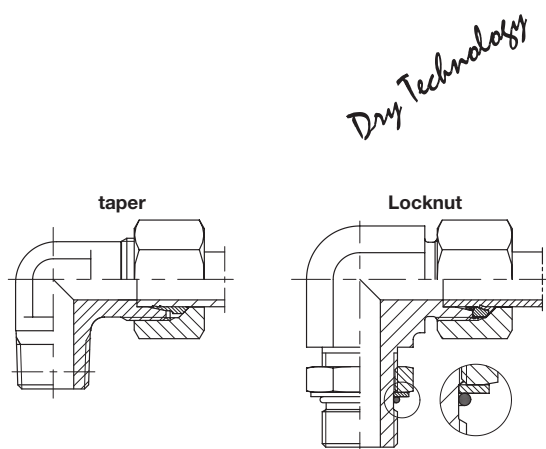

High pressure banjo versus traditional low pressure elbow

- + Elastomeric seal
- + High degree of fine sealing
- + Long-term reliability without retightening
- + No air ingress
- + 360° orientable
- + Compact design
- + Suitable for high pressure applications
- + Matching small spot surface
- + Clear hit-home-feel at assembly
- + No damage to port surface
- + Assembly and performance almost independant of port material
- + Seal does not fall off
- + Only one hollow bolt needs to be tightened
- + No hidden screw
- + Unlimited repeated assembly
- + Seal can be individually replaced
- + Million times proven product since 1980
- + Interchangeable with traditional fittings
- + Available in 90°elbow and T-configuration
- Slight flow restriction
- + Low total cost
- + Best value for end user
- + Globally gaining popularity

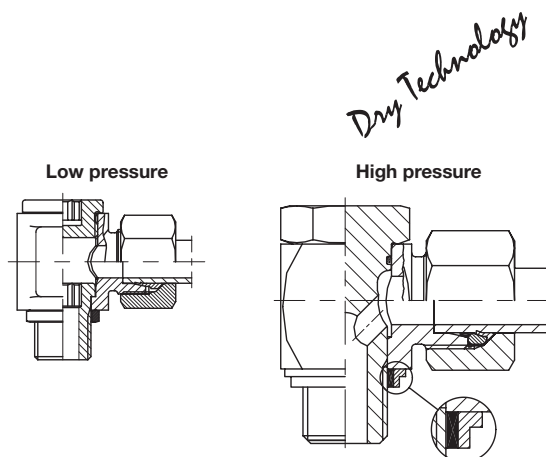



EO[®] Ermeto Original
Performance data

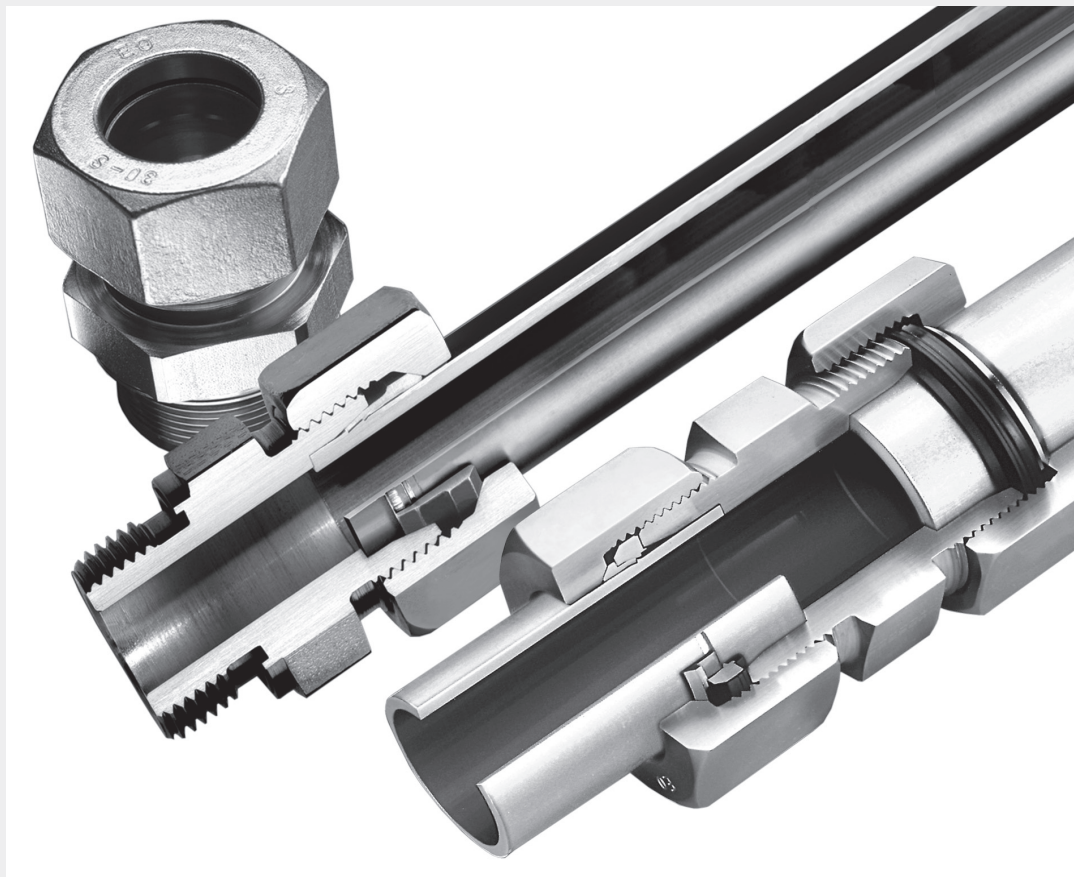

Performance data



Pressure rating

Nominal pressure PN

The Nominal pressure PN is a figure relating to the pressure rating of a fluid component for continuous dynamic applications. It is rounded to correspond to internationally standardised ratings. Logical series of fittings are grouped together, with the nominal pressure of the group being that of the "lowest common denominator" within the group.

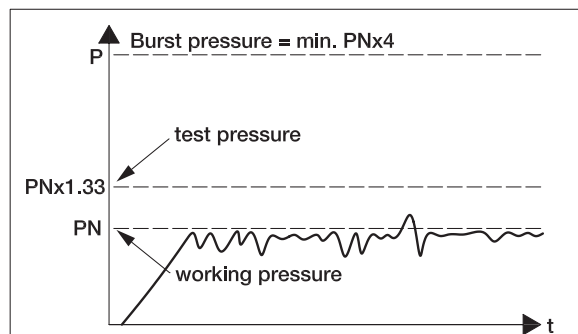

Internationally, these nominal pressures are recognised and serve to match common sizes of components together. Parker tube fittings meet or exceed common standardised pressure ratings.

To prove the long term dynamic load resistance, components are tested under pressure impulse conditions of $PN \times 1.33$, at 1Hz for 1 million cycles. Static test burst pressures are at least 4 times the PN value.

Exception: for ball valves the static test burst pressures are at least 1.5 times the PN value according to DIN 3230 T5 and ISO 5108.

Conversion chart

| Bar | Mpa | PSI |
|-----|------|------|
| 100 | 10.0 | 1450 |
| 160 | 16.0 | 2321 |
| 210 | 21.0 | 3045 |
| 315 | 31.5 | 4569 |
| 350 | 35.0 | 5075 |
| 400 | 40.0 | 5801 |

Pressure reductions and temperatures

Required pressure reductions (dependant on the material) with reference to the catalogue pressures for higher temperatures. Both metal fitting material and elastomeric sealing compound have to be selected according to the temperature range of the system.

Attention: Fluid Compatibility see page C5.

| Fittings material | Pressure reduction of permissible operating temperatures TB in °C | | | | | | | | | | | | | | |
|--------------------------------------|---|-----|-----|-----|-----|-------|-----|--------|---------|-------|---------|-------|-------|-------|------|
| | -60 | -50 | -40 | -35 | -25 | +20 | +50 | +100 | +120 | +150 | +175 | +200 | +250 | +300 | +400 |
| Steel, fittings | | | | | | 0 % | | | | -11 % | -19 % | -28 % | | | |
| Steel, tubes | | | | | | 0 % | | | | -19 % | | -27 % | | | |
| Stainless steel, fittings | | | | | | 0 % | | | | -11 % | | -20 % | | -30 % | |
| Stainless steel, tubes | | | | | | 0 % | | -5.5 % | -11.5 % | | -21.5 % | | -29 % | -34 % | |
| Brass, fittings ¹⁾ | | | | | | -35 % | | | | | | | | | |
| Sealing material NBR (e.g. Perbunan) | | | | | | | | | | | | | | | |
| Sealing material FKM | | | | | | | | | | | | | | | |
| Sealing material EPDM ²⁾ | | | | | | | | | | | | | | | |

| | |
|--|---|
| | Permissible operating temperature |
| | Ambient temperature of hydraulic and pneumatic applications |
| | Temperature not permissible |

Perbunan = registered trademark of Bayer

¹⁾ 35 % from material 1.4571 (if not extra shown in PN-Column "MS" for Brass)

²⁾ EPDM is not compatible with oil (not normally held in Stock)

Calculation example:

PN fitting 16S/71 = 400 bar
 Temperature = 200°C
 Material = Stainless steel
 Pressure reduction fittings = 20 %
 Pressure reduction tubes = 21,5 %
 PN tube 16 x 2.5/71, DIN 2413 III = 362 bar

Formula:

$$PN_{\text{fitting } 200^\circ\text{C}} = \frac{400 \text{ bar}}{100\%} \times (100\% - 20\%) = 320 \text{ bar}$$

$$PN_{\text{tube } 200^\circ\text{C}} = \frac{362 \text{ bar}}{100\%} \times (100\% - 21,5\%) = 284 \text{ bar}$$

Materials

| Fittings | Raw material | Material | | | | Fitting type | | | | | | | | | |
|-----------------|--|--|--------------|----------------|------------------------------|--------------|------|----------|---------------|--------|------|---------|-------------|------|---------|
| | | | | | | EO | | | | O-Lok® | | | Triple-Lok® | | |
| | | Designation ²⁾ | Material No. | Standard | US Designation ²⁾ | Bodies | Nuts | Ferrules | Weld fittings | Bodies | Nuts | Sleeves | Bodies | Nuts | Sleeves |
| Steel | Barstock | 11SMnPb30 | 1.0718 | DIN EN 10277-3 | SAE 12L14 | X | | | | X | | X | X | | X |
| | Free cutting steel | 11SMn30 | 1.0715 | DIN EN 10277-3 | SAE 1213 | X | | | | | | | | | |
| | | 46S20 | 1.0727 | DIN EN 10277-3 | SAE 1146 | X | | | | | | | | | |
| | Forgings | 15S10 | 1.0710 | DIN 1651 | | X | | | | | | | | | |
| | Free cutting steel | 11SMn30 modified | 1.0715 | DIN EN 10087 | SAE 1213 modified | | | | | X | | | X | | |
| | | 36SMn14 | 1.0764 | DIN EN 10087 | | X | | | | | | | | | |
| | | C45 modified | 1.0503 | DIN EN 10083 | SAE 1045 modified | | X | | | | X | | | X | |
| | Extrusion steel | C10C | 1.0214 | DIN EN | SAE C1010 | | X | | | | X | X | | X | X |
| | Weldable steel | C15 | 1.0401 | DIN 10277-3 | | | | | X | | | | | | |
| Other | Steel at the manufacturers discretion special heat treated | | | | | | | X | | | | | | X | |
| Stainless steel | Barstock | X6CrNiMoTi 17-12-2 | 1.4571 | DIN EN 10088 | ANSI 316TI | X | X | | X | | | | | | |
| | | X2CrNiMo 17-13-2 | 1.4404 | DIN EN 10088 | ANSI 316L | | | | | X | X | X | X | X | X |
| | Forgings | X6CrNiMo Ti17-12-2 | 1.4571 | DIN EN 10088 | ANSI 316TI | X | X | | X | | | | | | |
| | | X5CrNiMo 17-12-2 | 1.4401 | DIN EN 10088 | ANSI 316 | | | | | X | X | X | X | X | X |
| | Other | Stainless steel at the manufacturers discretion special heat treated | | | | | | | X | | | | | | |
| Brass | Barstock | CuZn35Ni2 | 2.0540 | DIN 17660 | | X | X | X | | | | | | | |
| | | | | ASTM B16/B453 | CA360/345 | | | | X | X | X | X | X | X | |
| | Forgings | CuZn35Ni2 | 2.0540 | DIN 17660 | | | X | | | | | | | | |
| ASTM B124 | | | | CA377 | | | | | X | | | X | | | |

1) Non standard fitting types like e.g. banjo fittings, rotary fittings, adjustable fittings with locknut and flanges might be made from different materials.

2) Equivalent materials may be used

Forging: 11 SMn 30+Bi (similar to 1.0715/DIN EN 10087)

Straight: 11 SMn Pb30 (1.0718/DIN EN 102773)

Special Material

"Due to their reliability and corrosion resistance, the austenitic stainless steels that we offer usually meet all the demands in markets, including the oil and gas, marine engineering, power generation, or pulp and paper among others. However, the unique requirements of some of the projects often demand special approaches. Parker Tube Fitting Division Europe understand those needs and has the technical knowledge and experience to help our customers to find the better solutions for their applications and meet even the most challenging demands. 1.4547 (6Mo), 1.4539, 2.1972 (CuNiFe), Inconel or other alloys might be offered on request."

| | | |
|----------|------|--|
| Sealings | NBR | e.g. N552-90, Perbunan (registered trademark of Bayer) |
| | FKM | e.g. V894-90 |
| | EPDM | e.g. E540-80 |
| | PTFE | e.g. Teflon® (registered trademark of DuPont) |
| | POM | e.g. Delrin (registered trademark of DuPont) |



Performance data



Surface treatment

Parker tube fittings from steel are delivered worldwide with a high quality surface protection:

Galvanic zinc plated and bright passivated with special sealer (suffix CF).

Why zinc plated?

The requirements for corrosion resistance of tube fittings have been increasing in the past few years. Increasingly tube systems are not painted. Higher demands are requested also for an aesthetic point of view.

The traditional black-grey surface “phosphated and oiled” (Znphr5f – DIN 50942) used for tube connections in the past does not longer meet these demands. An galvanized deposit zinc layer offers the following advantages: The corrosion resistance increases significantly due to a plating of min. 8 μ and additional sealing by chromating process. In case of scratches or nicks – which are unavoidable during assembly – zinc develops a cathodical protection of the steel fitting body against localised corrosion and abrasion.

The corrosion resistance of the CF surface is 400 % above zinc plated surfaces to meet highest requirements. The CF surface is also Cr(VI)-free to avoid any contamination in

the manufacturing process and meets current regulations e.g. European “End of Life Vehicles“ directive.

The silver bright colour due to the chromating or passivation process offers an attractive appearance.

All major HPCE manufacturing locations are equipped with their own modern galvanic plants. The process control is specially orientated to the tube fitting product.

The users of Parker fittings benefit from:

- homogeneous thickness of plating (average 13 μm), measured on outside contour for good screwable threads
- high quality above-average concerning avoidance of nicks
- very good corrosion resistance

Continuous corrosion tests like salt spray tests according to ISO 9227/5% NaCl show an average resistance of 500 hr in contrast to white rust and 700 hr in contrast to red rust for CF surfaces.

Particular fitting series or fitting components and valves are delivered with other or modified surfaces for functional reasons or for better differentiation.

| Material | Fitting system | Fitting type | Surface protection/Surface | | | | | | |
|-----------------|----------------|----------------------------------|--|--------------------------|--|--------------------------------|---------------------|-----------------------------|-----------------------------|
| | | | CF/Cr3* Zinc plated bright passivated | CF + Glide coating | A3K Zinc plated bright passivated | Znphr5f black phosphated | Plain no coating | Plain + Glide coating | Plain + Inside silver |
| Steel | EO-2 | Fitting bodies | X | | | | | | |
| | | Functional nuts | | X | | | | | |
| | EO | Fitting bodies | X | | | | | | |
| | | Nuts | | X | | | | | |
| | | Progressive stop rings | | | X | | | | |
| | | Weld fittings | | | | X | | | |
| | EO2-FORM | Bodies and nuts from EO are used | | | | | | | |
| | O-Lok® | Fitting bodies | X | | | | | | |
| | | Nuts | X | | | | | | |
| | | Parflange® sleeves | X | | | | | | |
| | | Brazing sleeves | | | | | X | | |
| | Triple-Lok® | Fitting bodies | X | | | | | | |
| | | Nuts | X | | | | | | |
| | | Sleeves | X | | | | | | |
| Stainless steel | EO-2 | Fitting bodies | | | | | X | | |
| | | Functional nuts up to 12-L/10-S | | | | | | X | |
| | | Functional nuts from 15-L/12-S | | | | | | | X |



Performance data

| Material | Fitting system | Fitting type | Surface protection/Surface | | | | | | | |
|--------------------|----------------|----------------------------------|--|--------------------------|--|--------------------------------|---------------------|-----------------------------|-----------------------------|--|
| | | | CF/Cr3* Zinc plated bright passivated | CF + Glide coating | A3K Zinc plated bright passivated | Znphr5f black phosphated | Plain no coating | Plain + Glide coating | Plain + Inside silver | |
| Stainless steel | EO | Fitting bodies | | | | | X | | | |
| | | Nuts up to 12-L/10-S | | | | | | X | | |
| | | Nuts from 15-L/12-S | | | | | | | X | |
| | | Progressive rings | | | | X | | | | |
| | EO2-FORM | Bodies and nuts from EO are used | | | | | | | | |
| | O-Lok® | Fitting bodies | | | | | X | | | |
| | | Nuts | | | | | X | | | |
| | | Sleeves | | | | | X | | | |
| | Triple-Lok® | Fitting bodies | | | | | X | | | |
| | | Nuts | | | | | X | | | |
| | | Sleeves | | | | | X | | | |
| | Brass | All systems | Fitting bodies | | | | | X | | |
| Nuts | | | | | | | X | | | |
| Sleeves & ferrules | | | | | | | X | | | |

A3K according to DIN EN ISO 4042 / Znphr5f according to DIN EN ISO 3892 and DIN 50942

O-Lok and Triple-Lok parts are plated Cr3 and conform to FC-F01 specification, 120 hours to white rust, 240 hours to red rust.

Fluid compatibility

Both metal fitting material and elastomeric seal compound have to be selected according to the fluid used.

Standard recommendations for static seals based on experience and sealing compound manufacturers specification. For use of sealing compounds that are used for dynamic seals like rotary fittings or non-return-valves, see note at end of table.

| Fluid | Fitting material | | | Sealing material | | |
|-------------------------|------------------|-----------------|-------|------------------|-----|------|
| | Steel | Stainless steel | Brass | NBR | FKM | EPDM |
| Acetone | 2 | 1 | 1 | 3 | 3 | 1 |
| Acetylene | 2 | 1 | 3 | 3 | 3 | 2 |
| Air (oil free) | 1 | 1 | 1 | 1 | 1 | 1 |
| Ammonia liquid | 2 | 1 | 3 | 2 | 3 | 1 |
| Ammonia gas, cold | 1 | 1 | 3 | 1 | 3 | 1 |
| Animal oils (Lard oil) | 2 | 2 | 2 | 1 | 1 | 2 |
| Aral, Vitam BAF | 1 | 1 | X | 1 | 1 | 3 |
| Argon | 1 | 1 | 1 | 1 | 1 | 1 |
| Asphalt | 3 | 1 | 3 | 2 | 1 | 3 |
| ASTM-Oil, no. 1 | 1 | 1 | 1 | 1 | 1 | 3 |
| ASTM-Oil, no. 2 | 1 | 1 | 1 | 1 | 1 | 3 |
| ASTM-Oil, no. 3 | 1 | 1 | 1 | 1 | 1 | 3 |
| ASTM-Oil, no. 4 | 1 | 1 | 1 | 2 | 1 | 3 |
| ATF oil | 1 | 1 | 1 | 1 | 1 | 3 |
| Automotive brake fluid | 1 | 1 | 1 | 3 | 3 | 1 |
| Benzene | 1 | 1 | 1 | 3 | 1 | 3 |
| Brine (sodium chloride) | X | 2 | X | 1 | 1 | 1 |
| Butane | 1 | 1 | 3 | 1 | 1 | 3 |
| Carbon bisulphide | 1 | 1 | 3 | 3 | 1 | X |
| Carbon dioxide | 1 | 1 | 1 | 1 | 2 | 1 |
| Carbon oxide | 1 | 1 | 1 | 1 | 1 | 1 |
| Castrol, Biotec HVX | 1 | 1 | X | 1 | 1 | 3 |
| Chlorine (dry) | 3 | 1 | 3 | 3 | 1 | X |
| Compressed air | 1 | 1 | 1 | 1 | 1 | 1 |
| Crude oil | 2 | 1 | 3 | 2 | 1 | 3 |



Performance data

| Fluid | Fitting material | | | Sealing material | | |
|------------------------------------|------------------|-----------------|-------|------------------|-----|------|
| | Steel | Stainless steel | Brass | NBR | FKM | EPDM |
| Cutting oil | 1 | 1 | X | 1 | 3 | 1 |
| DEA, Econa E22 | 1 | 1 | X | 1 | X | 3 |
| DEA, Econa E46 | 1 | 1 | X | 1 | X | 3 |
| Diesel fuel | 1 | 1 | 1 | 1 | 1 | 3 |
| ECOOL | 1 | 1 | X | 1 | 1 | X |
| ESSO, Univis 13 | 1 | 1 | X | 1 | 1 | 3 |
| ESSO, Univis 26 | 1 | 1 | X | 1 | 1 | 3 |
| ESSO, Univis 32 | 1 | 1 | X | 1 | 1 | 3 |
| ESSO, Univis 46 | 1 | 1 | X | 1 | 1 | 3 |
| Ethanol (Ethylacohol) | 1 | 1 | 1 | 1 | 3 | 1 |
| Ether | 1 | 1 | 1 | 3 | 3 | 2 |
| FINA, Biohydran RS 38 | 1 | 1 | X | 1 | 1 | 3 |
| Flue gas | 3 | 1 | 3 | 3 | 2 | X |
| FRAGOL, Hydrolub 125 | 1 | 1 | X | 1 | X | 3 |
| Freon 11 | X | X | 1 | 2 | 2 | 3 |
| Freon 12 | 1 | 3 | 1 | 2 | 1 | 3 |
| Freon 22 | 3 | 1 | 1 | 3 | 2 | 3 |
| Gasoline | 2 | 1 | 1 | 2 | 1 | 3 |
| Gas, liquid propane (LPG) | 1 | 1 | 1 | 1 | 1 | 3 |
| Glycerine | 2 | 1 | 2 | 1 | 1 | 1 |
| Glycol (Ethylenglykol) | 1 | 1 | 2 | 1 | 1 | 1 |
| Heating fuel oil | 1 | 1 | 1 | 1 | 1 | 3 |
| Helium | 1 | 1 | 1 | 1 | 1 | 1 |
| Houghton Safe 1120 | 1 | 1 | X | 3 | 1 | 1 |
| Houghton Safe 620 | 1 | 1 | X | 1 | 2 | 1 |
| Hydrochlorid acid | 3 | 2 | 3 | 3 | 1 | 2 |
| Hydrogen | 3 | 1 | X | 3 | 3 | 3 |
| Hydrogen peroxide | 3 | 1 | 3 | 3 | 1 | 2 |
| Hydrolube | 1 | 1 | 1 | 1 | 1 | 1 |
| Iodine | 3 | 1 | 3 | 2 | 1 | 2 |
| Kerosene | 1 | 1 | 1 | 1 | 1 | 3 |
| Lubricating oil SAE 10,20,30,40,50 | 1 | 1 | 1 | 1 | 1 | 3 |
| Methane | 1 | 1 | 1 | 1 | 1 | 3 |
| Methanol | 1 | 1 | 1 | 1 | 3 | 1 |
| MIL-F-8192 (JP-9) | 1 | 1 | 1 | 3 | 1 | 3 |
| MIL-H-5606 | 1 | 1 | 1 | 1 | 1 | 3 |
| MIL-H-6083 | 1 | 1 | 1 | 1 | 1 | 3 |
| MIL-H-7083 | 1 | 1 | 1 | 1 | 2 | 1 |
| MIL-H-8446 (MLO-8515) | 1 | 1 | 2 | 2 | 1 | 3 |
| MIL-L-2104 & 2104B | 1 | 1 | 1 | 1 | 1 | 3 |
| MIL-L-7808 | 2 | 1 | 3 | 2 | 1 | 3 |
| Mineral oil | 1 | 1 | 1 | 1 | 1 | 3 |
| Natural gas | 1 | 1 | 2 | 1 | 1 | 3 |
| Natural gas, untreated | 3 | 2 ¹⁾ | 3 | 3 | 3 | 3 |
| Natural mineral oil | 1 | 1 | 3 | 2 | 1 | 3 |
| Neon | 3 | 1 | 1 | 1 | 1 | 1 |
| Nitric acid | 3 | 1 | 3 | 3 | 2 | 3 |
| Nitrogen | 1 | 1 | 1 | 1 | 1 | 1 |
| Oil | 1 | 1 | 3 | 1 | 1 | 3 |
| Oxygen (gas, cold) | 3 | 1 | 2 | 3 | 3 | 3 |
| Ozone | 1 | 1 | 3 | 3 | 1 | 1 |
| Petrolatum | 1 | 1 | 1 | 1 | 1 | 3 |
| Petroleum oil | 1 | 1 | 1 | 1 | 1 | 3 |
| Phosphoric acid | 3 | 3 | 1 | 3 | 1 | 2 |
| Plantohyd 32 S | 1 | 1 | X | 1 | 1 | 3 |
| Plantohyd 40 N | 1 | 1 | X | 1 | 1 | 3 |
| Propane | 1 | 1 | 1 | 1 | 1 | 3 |
| R134A | 1 | 1 | 1 | 3 | 3 | 1 |



Performance data

| Fluid | Fitting material | | | Sealing material | | |
|--------------------------|------------------|-----------------|-----------------|------------------|-----|------|
| | Steel | Stainless steel | Brass | NBR | FKM | EPDM |
| Sea Water | 3 | 2 | 3 | 1 | 1 | 1 |
| SHELL, Naturelle HF-E-46 | 1 | 1 | X | 1 | 1 | 3 |
| SHELL, Tellus Oil DO 32 | 1 | 1 | X | 1 | 1 | 3 |
| Silicone oil | 1 | 1 | X | 1 | 1 | 1 |
| Skydrol 500 | 1 | 1 | 3 | 3 | 3 | 1 |
| Skydrol 7000 | 1 | 1 | 3 | 3 | 2 | 1 |
| Soap solutions | 3 | 1 | 3 | 1 | 1 | 1 |
| Steam | 2 | 1 | 2 | 3 | 3 | 1 |
| Stoddard solvent | 1 | 1 | 2 | 1 | 1 | 3 |
| Sulphur dioxide | 3 | 1 | 3 | 3 | 3 | 1 |
| Sulphuric acid | 3 | 2 | 3 | 3 | 1 | 3 |
| Toluol | 1 | 1 | 1 | 3 | 2 | 3 |
| Transmission fluid | 1 | 1 | 1 | 1 | 1 | 3 |
| Trichlorethane | 2 | 1 | X | 3 | 1 | 3 |
| Turpentine | 2 | 1 | 3 | 1 | 1 | 3 |
| Water | 2 | 1 | 1 ²⁾ | 1 | 2 | 1 |
| Xylol | 1 | 1 | 1 | 3 | 1 | 3 |

C

Applicability: 1 = satisfactory
 2 = fair
 3 = not recommended
 X = insufficient data

NBR = e.g. Perbunan (registered trademark of Bayer)
 FKM

¹⁾ Untreated natural gas requires stainless steel with reduced material hardness.

²⁾ Brass is resistant against crack under normal circumstances. If overloaded (e.g. by overassembly) the resistance especially against ammoniac and nitric derivatives can be negatively influenced. This might cause the defect of the connection.

This fluid compatibility chart is only applicable on so called “static seals”, such as O-rings and profile sealing rings (e.g. ED-seal, DOZ-seal) in tube fitting and flange systems.

For fluid compatibility data of valves, rotary fittings or other multi-function components please review the relevant product pages.



Performance data

Biodegradable oils

Due to environmental concerns and new legislation biodegradable oils are rapidly gaining importance for both mobile and stationary applications. The usage of non-flammable fluids will remain limited to special applications like mining, steel mills and heavy machines.

Media

Biodegradable oils can be classified into 3 categories:

HEPG (Glycol based fluids)

- + Wide temperature range (-45°C ... 100°C)
- + Very stable against ageing
- + NBR and FKM seals are compatible
- + Moderate viscosity change with temperature
- + Water soluble
- Not mixable with mineral oils or HEES, HETG types
- Careful flushing recommended when changing from mineral oil
- Paints can be dissolved
- Care required with material compatibility (e.g. do not use any zinc containing materials)
- Density > 1,100 kg/m³ possible design changes
- Price?

HETG (Vegetable-based fluids)

- + Mixable with mineral oils
- + Normal sealing material are compatible (e.g. NBR or FKM)
- + Good lubricating properties
- + Paint resistant to fluid
- + Viscosity changes with temperature are moderate
- Limited temperature range (-25° C to +70°C)
- Max. temperature not to be exceeded
- Limited lifetime
- UV and ozone sensitive
- Beware of water take-up (cracking?)
- Price?

HEES (Synthetic ester based fluids)

- + Wide temperature range (-30° C ... +90° C or over 100° C with some variants)
- + Good lifetime
- + Mixable with mineral oils
- + Normal sealing materials compatible (FKM and NBR recommended)
- + Machine paints resistant to fluid
- + Viscosity changes with temperature are moderate
- + Good lubricating properties
- Danger of hydrolysis with water take-up (filters, dryer, occlusion)
- Price?

Compatibility

Generally, HPCE steel fittings with standard NBR seals are suitable for most applications.

| | -20 °C ... 80 °C | 80 °C ... 120 °C |
|---------------------------|------------------|-------------------------|
| HEPG Polyalkylenglycol | NBR FKM | Not suitable for Oil |
| HETG Vegetable Oil | NBR FKM | - FKM |
| HEES Synthetic ester | NBR FKM | - FKM |

Suitable sealing compounds

Experience shows that media compatibility is not a critical issue for static seals used on tube fittings. In doubt please contact HPCE application engineering.

Pragmatic approach

If there is doubt about switching over to softseal fitting systems (ISO6149/Eolastic/O-Lok®/EO-2), it might be a good idea to have a close look on the existing hydraulic system. If NBR seals perform well on hoses, cylinders, valves or filters there is nothing to worry about standard HPCE fittings. Usually the design engineers know when special seal compounds like FKM have to be used.



Flow characteristics

Hydraulic systems are in most cases only rated with a flow velocity defined on the basis of experience. The pressure losses in lines are not taken into account, or measured later on when testing the system. As the pressure losses increase proportionally greater than the flow resistance, it is important to achieve the best rating of the system, that they are already taken into account when planning the tube connections. Calculation is not as difficult as it is often thought, and this chapter is intended to provide a guideline. Besides, it provides information on how excessive pressure losses can be avoided, because pressure losses result in losses in performance and excessive heat. Noise occurs, and possibly cavitation in suction lines.

Medium

All indication given with regard to flow restrictions and to flow properties refer exclusively to liquids. For gaseous media, the variable density of the gas must additionally be taken into account.

Units

c = Flow velocity $\left[\frac{\text{m}}{\text{s}} \right]$

d = Pipe inside diameter [m]

L = Pipe length [m]

p = Pressure [Pa], 1 bar = 100000 Pa

\dot{V} = Flow rate $\left[\frac{\text{m}^3}{\text{s}} \right]$, $1 \frac{\text{m}^3}{\text{s}} = 60000 \frac{\text{l}}{\text{min}}$

λ = Pipe friction factor

$\nu(T)$ = Kinematic viscosity of the medium depending on temperature $\left[\frac{\text{m}^2}{\text{s}} \right]$

$\rho(T)$ = Density of the medium depending on temperature $\left[\frac{\text{kg}}{\text{m}^3} \right]$

ζ = Individual pressure loss coefficient

Only base units have been used. This has the advantage that the formula do not contain correction factors and there is no danger of confusion, e.g. that values are used with the wrong unit. In case values are given in other units – the flow rate is e.g. often given in l/min – it is advisable to convert them into the base units before starting calculation.

Pressure losses in pipe lines

To calculate pressure losses in pipe lines, it must first be determined whether there is a laminar or a turbulent flow. Laminar flow is homogenous and without turbulence. In case of turbulent flow, the losses increase much more quickly.

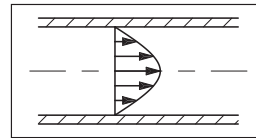

Flow profile with laminar flow

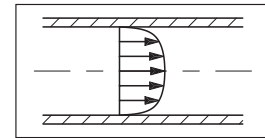

Flow profile with turbulent flow

C

The kind of flow is defined by the Reynolds' number. With a Reynolds' number of more than 2320, the flow changes to turbulent. The Reynold number is calculated according to the formula:

$$Re = \frac{c \cdot d}{\nu(T)}$$

The Reynolds' number is a non-dimensional number. The critical fluid velocity at which the flow regime can change, is thus calculated from:

$$c_{cr} = 2320 \cdot \frac{\nu(T)}{d} \left[\frac{\text{m}}{\text{s}} \right]$$

With a given flow rate, the fluid velocity can be calculated according to the formula:

$$c = \frac{\dot{V} \cdot 4}{d^2 \cdot \pi} \left[\frac{\text{m}}{\text{s}} \right]$$

Subsequently, the pipe friction factor λ can be calculated. The pipe friction factor λ is a function of the Reynold number and also depends on the roughness of the pipe. As hydraulically smooth pipes can generally be assumed in hydraulic applications, the pipe friction factor λ is calculated according to the following formula:

$$\text{laminar flow, } (Re < 2320): \lambda = \frac{64}{Re}$$

$$\text{turbulent flow, } (Re < 2320): \lambda = \frac{0.3164}{\sqrt[4]{Re}}$$

Finally, if all factors are known, the pressure loss in a certain pipe line can be calculated according to the formula:

$$\Delta p = \lambda \cdot \frac{L}{d} \cdot \frac{\rho(T) \cdot c^2}{2} \text{ [Pa]}$$

Calculation of individual losses

A hydraulic system does not only incorporate pipes, but also valves, fittings, pipe bends etc. that cause flow losses. These individual losses are often much higher than the pipe losses and are calculated according to the following formula:

$$\Delta p = \zeta \cdot \rho(T) \cdot \frac{c^2}{2} \text{ [Pa]}$$



Performance data

The pressure loss coefficient ζ relates to an individual hydraulic component. It covers circulation, impact and separation losses of the flow in a component. In most cases, valve or fitting manufacturers state the pressure loss coefficient of their products. The ζ values are not completely constant. The values increase in the case of very low fluid velocities. The following diagram shows the typical course of the ζ values for a component, depending on the fluid velocity, as it has been determined through a series of tests in the laboratory of the Parker Hannifin GmbH & Co. KG.

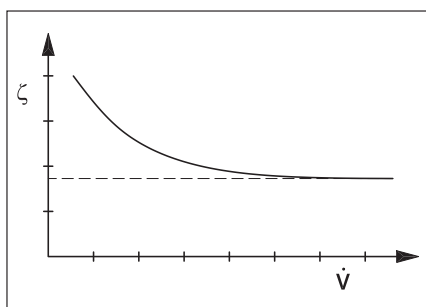

As only the flow resistances at nominal power, i.e. at higher fluid velocities, are generally calculated to rate a hydraulic plant, they may therefore be slight variations for individual sizes.

Straight fittings, e.g. G, GE, EGE, HMTX, F...MTX, F6...MX, HMLO, F...MLO, F6...MLO, ...

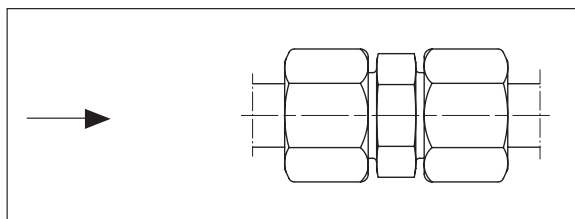

If there is a step change between the bore of the fitting and the inside diameter of the pipe, the conditions applicable to reducers (see below) are valid. In a normal case, however, the pressure loss is very small, so that it cannot be measured by normal methods. Literature gives a pressure loss coefficient of 0.01 to 0.05.

Reducers, e.g. RED, GR, TRMTX, TRMLO, ...

With reducers, distinction must be made between a cross section increase or reduction. The fluid velocity taken as a basis to calculate the pressure loss is always the velocity at the outlet of the flow.

Extension of the cross section:

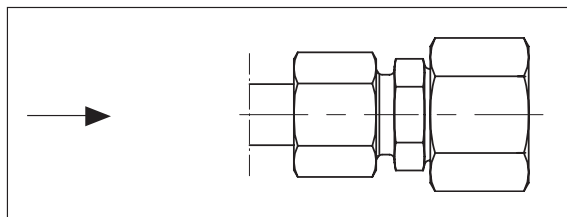

$$\zeta = \left(\frac{A_2}{A_1} - 1 \right)^2$$

With A_1 ... Inlet cross section area
 A_2 ... Outlet cross section area

The formula stated is valid for a transition angle $> 60^\circ$, and thus also for EO fittings.

It is difficult to state a figure, as the program of reducers is extensive.

With an RED style of fitting, the pressure loss coefficient ζ can vary between 1.5 and 5000, always referred to the flow velocity at the outlet.

Reduction of the cross section:

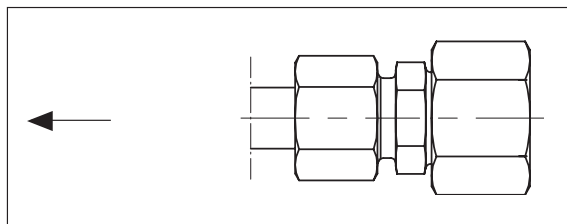

| | | | | |
|-----------|------|------|------|------|
| A_2/A_1 | 0.80 | 0.60 | 0.40 | 0.20 |
| ζ | 0.15 | 0.25 | 0.35 | 0.42 |

Elbow connectors, e.g. W, EW, EMTX, C...MTX, EMLO, C...MLO, ...

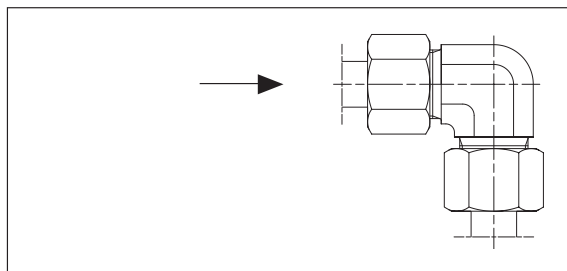

| Type | Pressure loss coefficient ζ |
|----------------------|-----------------------------------|
| W, EMTX, EMLO | 1 |
| EW, C...MTX, C...MLO | 1 |



Performance data

Tube bends

With pipe bends, the pressure loss coefficient results from the ratio of bend radius to inside diameter (R/d).

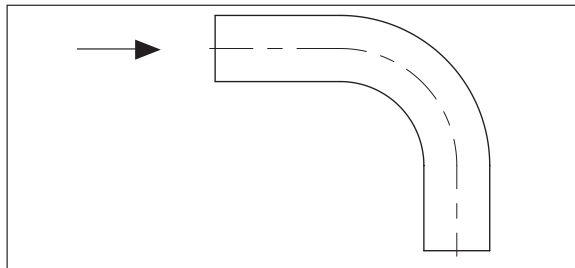

| Bend radius/Inside diameter | Pressure loss coefficient ζ |
|-----------------------------|-----------------------------------|
| 2 | 0.21 |
| 4 | 0.14 |
| 6 and more | 0.11 |

Banjo fittings

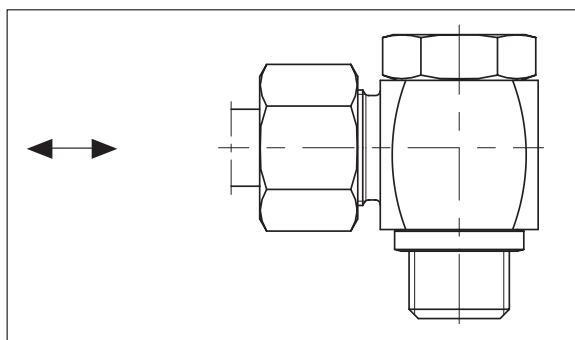

| Type | Pressure loss coefficient ζ |
|------|-----------------------------------|
| WH | 3 ... 6 |
| SWVE | 6 ... 9 |
| DSVW | approx. 4 |

With WH and SWVE, the pressure loss depends on the position of the banjo bolt cross hole drilling to the tube connection aperture. The pressure loss coefficient is therefore given as a range.

Manifolds and Tee/Cross fittings

The pressure loss coefficient depends on whether the medium is divided or flows together, and in what ratio the medium is divided.

Index a: The medium flows straight through the manifold.
Index b: The medium flows through the cross branch of the manifold.

| Flow division (to/from T branch) | Pressure loss coefficient ζ in case of pipe branching | | Pressure loss coefficient ζ in case of pipe junction | |
|-------------------------------------|---|-----------|--|-----------|
| | ζ_a | ζ_b | ζ_a | ζ_b |
| \dot{V}_b / \dot{V} | | | | |
| 0.6 | 0.07 | 0.95 | 0.40 | 0.47 |
| 0.8 | 0.20 | 1.10 | 0.50 | 0.73 |
| 1.0 | 0.35 | 1.30 | 0.60 | 0.92 |

C

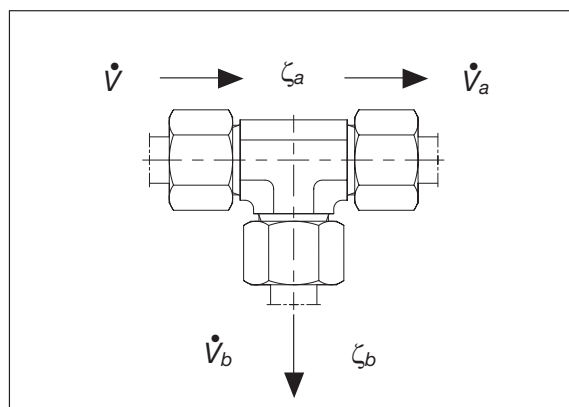

Pipe branching

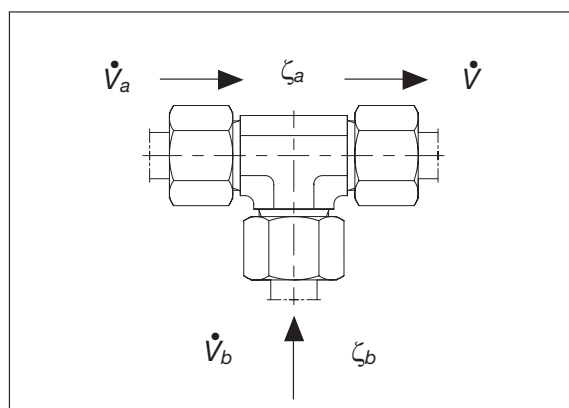

Pipe junction

Performance data

Valves, e.g. RHD, DV, VDHA, ...

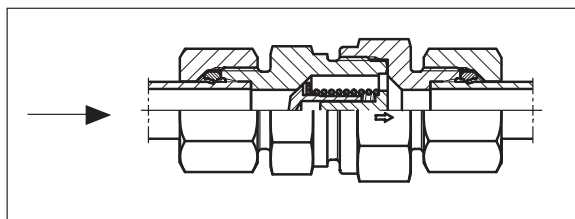

| Type | Pressure loss coefficient ζ |
|--------|-----------------------------------|
| RH ... | 5.0 |
| DV | 5.5 |
| LD | 4.0 |
| VDHA | 5.0 |
| VDHB | 5.5 |

The pressure loss coefficient stated is always valid for the fully opened valve.

Calculation of the pressure loss Δp – example a WH 16-SR/CF (Banjo fitting).

The pressure loss Δp is calculated according to the following formula:

$$\Delta p = \zeta \cdot \rho(T) \cdot \frac{c^2}{2} \text{ [Pa]}$$

To calculate pressure loss at a flow rate of 20 l/min is to be calculated.

The following values are known:

Pipe inside diameter $d = 12 \text{ mm} = 0.012 \text{ m}$

Density of the medium $\rho = 869; 4 \text{ kg/m}^3$

(Oil manufacturer's data sheet)

Pressure loss coefficient $\zeta = 4.5$

(Average value for WH fittings)

$$\text{Flow rate } \dot{V} = \left[\frac{20}{60000} \right] = 0.000333 \left[\frac{\text{m}^3}{\text{s}} \right]$$

$$\text{Fluid velocity } c = \frac{\dot{V} \cdot 4}{d_2 \cdot \pi} = \frac{0.000333 \cdot 4}{0.012^2 \cdot \pi} = 2.95 \left[\frac{\text{m}}{\text{s}} \right]$$

The thus resulting flow loss is then:

$$\Delta p = 4.5 \cdot 869.4 \cdot \frac{2.95^2}{2} = 17000 \text{ [Pa]} = 0.17 \text{ [bar]}$$



Flow diameter and wall thickness

Determining tube size for hydraulic systems

Proper tube material, type and size for a given application and type of fitting is critical for efficient and trouble free operation of the fluid system. Selection of proper tubing involves choosing the right tube material, and determining the optimum tube size (O.D. and wall thickness).

Proper sizing of the tube for various parts of a hydraulic system results in an optimum combination of efficient and cost effective performance.

A tube that is too small causes high fluid velocity, which has many detrimental effects. In pressure lines, it causes high friction losses and turbulence, both resulting in high pressure drops and heat generation. High heat accelerates wear in moving parts and rapid aging of seals and hoses, all resulting in reduced component life. High heat generation also means wasted energy, and hence, low efficiency.

Too large tubes increase system cost. Thus, optimum tube sizing is very critical. The following is a simple procedure for sizing the tubes.

Determine required flow diameter

Use table to determine recommended flow diameter for the required flow rate and type of line.

The table is based on the following recommended flow velocities:

$$\text{Pressure lines} - 3 \rightarrow 5 \left[\frac{\text{m}}{\text{s}} \right]$$

Avoid flow rates > 8 m/s!
The resulting forces are high and can destroy the tube lines.

$$\text{Return lines} - 2 \rightarrow 4 \left[\frac{\text{m}}{\text{s}} \right]$$

$$\text{Suction lines} - 1 \left[\frac{\text{m}}{\text{s}} \right]$$

If you desire to use different velocities than the above, use one of the following formula to determine the required flow diameter.

$$\text{Tube-I.D. [mm]} = 4.61 \cdot \sqrt{\frac{\text{Flow} \left[\frac{\text{ltr.}}{\text{min}} \right]}{\text{Velocity} \left[\frac{\text{m}}{\text{s}} \right]}}$$

Determine required wall thickness

Use 2nd table to determine recommended wall thickness for the required working pressure and flow diameter of the line. Therefore choose an working pressure which is equal or higher than the required working pressure.

For other tubes and tube materials you have to calculate the wall thickness and working pressure acc. to the formula shown in the tube chapter.

| Maximum flow l/min | Flow diameter in millimeters | | |
|--------------------|------------------------------|--------------------|---------------------|
| | 5 m/s Pressure lines | 3 m/s Return lines | 1 m/s Suction lines |
| 1 | 2.1 | 2.7 | 4.6 |
| 2 | 2.9 | 3.8 | 6.5 |
| 3 | 3.6 | 4.6 | 8.0 |
| 4 | 4.1 | 5.3 | 9.2 |
| 5 | 4.6 | 6.0 | 10.3 |
| 6 | 5.1 | 6.5 | 11.3 |
| 7 | 5.5 | 7.0 | 12.2 |
| 8 | 5.8 | 7.5 | 13.0 |
| 9 | 6.2 | 8.0 | 13.8 |
| 10 | 6.5 | 8.4 | 14.6 |
| 12 | 7.1 | 9.2 | 16.0 |
| 14 | 7.7 | 10.0 | 17.2 |
| 16 | 8.2 | 10.6 | 18.4 |
| 18 | 8.7 | 11.3 | 19.6 |
| 20 | 9.2 | 11.9 | 20.6 |
| 22 | 9.7 | 12.5 | 21.6 |
| 24 | 10.1 | 13.0 | 22.6 |
| 26 | 10.5 | 13.6 | 23.5 |
| 28 | 10.9 | 14.1 | 24.4 |
| 30 | 11.3 | 14.6 | 25.3 |
| 32 | 11.7 | 15.1 | 26.1 |
| 34 | 12.0 | 15.5 | 26.9 |
| 36 | 12.4 | 16.0 | 27.7 |
| 38 | 12.7 | 16.4 | 28.4 |
| 40 | 13.0 | 16.8 | 29.2 |
| 45 | 13.8 | 17.9 | 30.9 |
| 50 | 14.6 | 18.8 | 32.6 |
| 55 | 15.3 | 19.7 | 34.2 |
| 60 | 16.0 | 20.6 | 35.7 |
| 65 | 16.6 | 21.5 | 37.2 |
| 70 | 17.2 | 22.3 | 38.6 |
| 75 | 17.9 | 23.1 | 39.9 |
| 80 | 18.4 | 23.8 | 41.2 |
| 85 | 19.0 | 24.5 | 42.5 |
| 90 | 19.6 | 25.3 | 43.7 |
| 95 | 20.1 | 25.9 | 44.9 |
| 100 | 20.6 | 26.6 | 46.1 |
| 110 | 21.6 | 27.9 | 48.4 |
| 120 | 22.6 | 29.2 | 50.5 |
| 130 | 23.5 | 30.3 | 52.6 |
| 140 | 24.4 | 31.5 | 54.5 |
| 150 | 25.3 | 32.6 | 56.5 |
| 160 | 26.1 | 33.7 | 58.3 |
| 170 | 26.9 | 34.7 | 60.1 |
| 180 | 27.7 | 35.7 | 61.8 |
| 190 | 28.4 | 36.7 | 63.5 |
| 200 | 29.2 | 37.6 | 65.2 |
| 220 | 30.6 | 39.5 | 68.4 |
| 240 | 31.9 | 41.2 | 71.4 |
| 260 | 33.2 | 42.9 | 74.3 |
| 280 | 34.5 | 44.5 | 77.1 |
| 300 | 35.7 | 46.1 | 79.8 |
| 320 | 36.9 | 47.6 | 82.5 |
| 340 | 38.0 | 49.1 | 85.0 |
| 360 | 39.1 | 50.5 | 87.5 |
| 380 | 40.2 | 51.9 | 89.9 |
| 400 | 41.2 | 53.2 | 92.2 |
| 450 | 43.7 | 56.5 | 97.8 |
| 500 | 46.1 | 59.5 | 103.1 |





Dimensioning

Dimensioning

Index

| | |
|---|---------|
| Overview EO 24° cone connections | D3 |
| Not recommended | D4 |
| EO 24° cone end (DIN 3861/ISO 8434-1)/dimension..... | D4 |
| EO 24°-DKO swivel connector (DIN 3865/DIN EN ISO 8434-1/-4)/dimensions | D5 |
| Overview O-Lok® connections..... | D6–D7 |
| O-Lok® end (ISO 8434-3/SAE J1453)/dimensions | D8 |
| O-Lok® swivel connector (ISO 8434-3/SAE J1453)/dimensions | D9 |
| Overview Triple-Lok® connections..... | D10–D11 |
| Triple-Lok® end (ISO 8434-2/SAE J514)/dimensions | D12 |
| Triple-Lok® swivel connector (ISO 8434-3/SAE J514)/dimensions | D13 |
| DIN 60° cone end (DIN 7631)/dimensions | D14 |
| Adapter 60° cone end (ISO/DIS 8434-6)/dimensions | D15 |
| NPSM Swivel adapters (SAE J516)/dimensions | D16 |
| Port end dimensions for tube fittings..... | D17–D19 |

Overview EO 24° cone connections

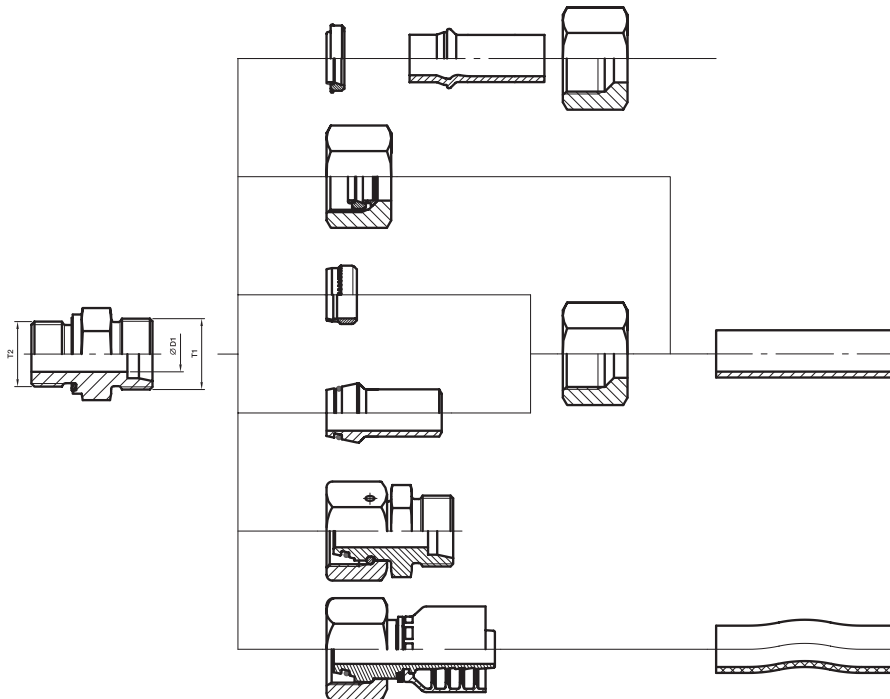

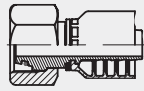
D

| Size | D1 Tube O.D. mm | T1 Thread metric | Thread O.D. mm | T2 Port thread | | | |  |
|------|--------------------------|------------------------|----------------------|-------------------|----------|--------------|----------------|---|
| | | | | BSPP | metric | BSPT (short) | metric tapered | |
| LL | 04 | M 08×1.0 | 8.0 | G 1/8 A | M 08×1.0 | R 1/8 tap. | M 08×1.0 tap. | |
| | 05 | M 10×1.0 | 10.0 | G 1/8 A | M 08×1.0 | | | |
| | 06 | M 10×1.0 | 10.0 | G 1/8 A | M 10×1.0 | R 1/8 tap. | M 10×1.0 tap. | |
| | 08 | M 12×1.0 | 12.0 | G 1/8 A | M 10×1.0 | R 1/8 tap. | M 10×1.0 tap. | |
| | 10 | M 14×1.0 | 14.0 | G 1/4 A | | R 1/4 tap. | | |
| | 12 | M 16×1.0 | 16.0 | G 1/4 A | | R 1/4 tap. | | |
| L | 06 | M 12×1.5 | 12.0 | G 1/8 A | M 10×1.0 | | M 10×1.0 tap. | 1CAxx-6-yy |
| | 08 | M 14×1.5 | 14.0 | G 1/4 A | M 12×1.5 | | M 12×1.5 tap. | 1CAxx-8-yy |
| | 10 | M 16×1.5 | 16.0 | G 1/4 A | M 14×1.5 | | M 14×1.5 tap. | 1CAxx-10-yy |
| | 12 | M 18×1.5 | 18.0 | G 3/8 A | M 16×1.5 | | M 16×1.5 tap. | 1CAxx-12-yy |
| | 15 | M 22×1.5 | 22.0 | G 1/2 A | M 18×1.5 | | M 18×1.5 tap. | 1CAxx-15-yy |
| | 18 | M 26×1.5 | 26.0 | G 1/2 A | M 22×1.5 | | M 22×1.5 tap. | 1CAxx-18-yy |
| | 22 | M 30×2.0 | 30.0 | G 3/4 A | M 26×1.5 | | M 26×1.5 tap. | 1CAxx-22-yy |
| | 28 | M 36×2.0 | 36.0 | G 1 A | M 33×2.0 | | | 1CAxx-28-yy |
| | 35 | M 45×2.0 | 45.0 | G 1 1/4 A | M 42×2.0 | | | 1CAxx-35-yy |
| | 42 | M 52×2.0 | 52.0 | G 1 1/2 A | M 48×2.0 | | | 1CAxx-42-yy |
| S | 06 | M 14×1.5 | 14.0 | G 1/4 A | M 12×1.5 | | M 12×1.5 tap. | 1C9xx-6-yy |
| | 08 | M 16×1.5 | 16.0 | G 1/4 A | M 14×1.5 | | M 14×1.5 tap. | 1C9xx-8-yy |
| | 10 | M 18×1.5 | 18.0 | G 3/8 A | M 16×1.5 | | M 16×1.5 tap. | 1C9xx-10-yy |
| | 12 | M 20×1.5 | 20.0 | G 3/8 A | M 18×1.5 | | M 18×1.5 tap. | 1C9xx-12-yy |
| | 14 | M 22×1.5 | 22.0 | G 1/2 A | M 20×1.5 | | M 20×1.5 tap. | 1C9xx-14-yy |
| | 16 | M 24×1.5 | 24.0 | G 1/2 A | M 22×1.5 | | M 22×1.5 tap. | 1C9xx-16-yy |
| | 20 | M 30×2.0 | 30.0 | G 3/4 A | M 27×2.0 | | | 1C9xx-20-yy |
| | 25 | M 36×2.0 | 36.0 | G 1 A | M 33×2.0 | | | 1C9xx-25-yy |
| | 30 | M 42×2.0 | 45.0 | G 1 1/4 A | M 42×2.0 | | | 1C9xx-30-yy |
| | 38 | M 52×2.0 | 52.0 | G 1 1/2 A | M 48×2.0 | | | 1C9xx-38-yy |

 xx – Fitting Series • yy – Hose Size
 From Parker hose fitting (PHDE)

Dimensioning
Not recommended

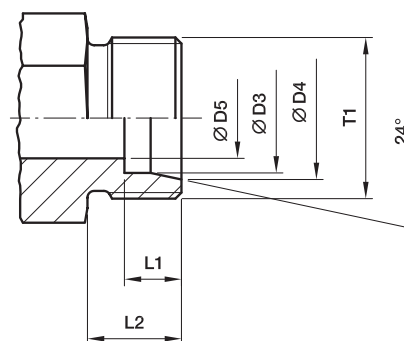
| | Reason |
|--|--|
| | High risk of hose blow off. For ferrule assembly special hardened tools are required. |
| | With the use of the Universal-connection high risk of cracks in 24° cone area of stud ends sizes 6-L up to 18-L. |

EO 24° cone end (DIN 3861/ISO 8434-1)/dimension

| Tube O.D. Size | T1 | Ø D3 mm | Ø D4 mm | Ø D5 mm | L1 mm | L2 mm |
|-------------------|----------|---------|---------|---------|-------|-------|
| 04-LL | M 08×1.0 | 04 | 5.0 | 3.0 | 4.1 | 8 |
| 06-LL | M 10×1.0 | 06 | 7.5 | 4.5 | 5.6 | 8 |
| 08-LL | M 12×1.0 | 08 | 9.5 | 6.0 | 5.6 | 9 |
| 10-LL | M 14×1.0 | 10 | 11.5 | 8.0 | 5.6 | 9 |
| 12-LL | M 16×1.0 | 12 | 13.5 | 10.0 | 6.1 | 9 |
| 06-L | M 12×1.5 | 06 | 8.1 | 4.0 | 7.1 | 10 |
| 08-L | M 14×1.5 | 08 | 10.1 | 6.0 | 7.1 | 10 |
| 10-L | M 16×1.5 | 10 | 12.3 | 8.0 | 7.1 | 11 |
| 12-L | M 18×1.5 | 12 | 14.3 | 10.0 | 7.1 | 11 |
| 15-L | M 22×1.5 | 15 | 17.3 | 12.0 | 7.1 | 12 |
| 18-L | M 26×1.5 | 18 | 20.3 | 15.0 | 7.6 | 12 |
| 22-L | M 30×2.0 | 22 | 24.3 | 19.0 | 7.6 | 14 |
| 28-L | M 36×2.0 | 28 | 30.3 | 24.0 | 7.6 | 14 |
| 35-L | M 45×2.0 | 35 | 38.0 | 30.0 | 10.6 | 16 |
| 42-L | M 52×2.0 | 42 | 45.0 | 36.0 | 11.1 | 16 |
| 06-S | M 14×1.5 | 06 | 8.1 | 4.0 | 7.1 | 12 |
| 08-S | M 16×1.5 | 08 | 10.1 | 5.0 | 7.1 | 12 |
| 10-S | M 18×1.5 | 10 | 12.3 | 7.0 | 7.6 | 12 |
| 12-S | M 20×1.5 | 12 | 14.3 | 8.0 | 7.6 | 12 |
| 14-S | M 22×1.5 | 14 | 16.3 | 10.0 | 8.1 | 14 |
| 16-S | M 24×1.5 | 16 | 18.3 | 12.0 | 8.6 | 14 |
| 20-S | M 30×2.0 | 20 | 22.9 | 16.0 | 10.6 | 16 |
| 25-S | M 36×2.0 | 25 | 27.9 | 20.0 | 12.1 | 18 |
| 30-S | M 42×2.0 | 30 | 33.0 | 25.0 | 13.6 | 20 |
| 38-S | M 52×2.0 | 38 | 41.0 | 32.0 | 16.1 | 22 |

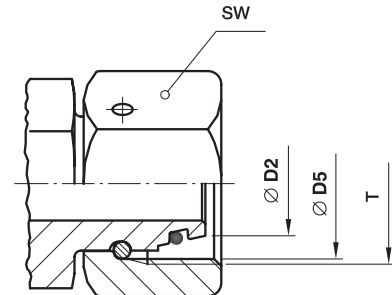
EO 24°-DKO swivel connector (DIN 3865/DIN EN ISO 8434-4)/dimensions

D

| Tube O.D. Size | T | Ø D2 mm | Ø D5 mm Thread core diameter | SW mm |
|-------------------|----------|---------|---------------------------------|-------|
| 06-L | M 12×1.5 | 5.5 | 10.38 | 14 |
| 08-L | M 14×1.5 | 7.5 | 12.38 | 17 |
| 10-L | M 16×1.5 | 9.7 | 14.38 | 19 |
| 12-L | M 18×1.5 | 11.7 | 16.38 | 22 |
| 15-L | M 22×1.5 | 14.7 | 20.38 | 27 |
| 18-L | M 26×1.5 | 17.7 | 24.38 | 32 |
| 22-L | M 30×2.0 | 21.7 | 27.84 | 36 |
| 28-L | M 36×2.0 | 27.7 | 33.84 | 41 |
| 35-L | M 45×2.0 | 34.5 | 42.84 | 50 |
| 42-L | M 52×2.0 | 41.5 | 49.84 | 60 |
| 06-S | M 14×1.5 | 5.5 | 12.38 | 17 |
| 08-S | M 16×1.5 | 7.5 | 14.38 | 19 |
| 10-S | M 18×1.5 | 9.7 | 16.38 | 22 |
| 12-S | M 20×1.5 | 11.7 | 18.38 | 24 |
| 14-S | M 22×1.5 | 13.5 | 20.38 | 27 |
| 16-S | M 24×1.5 | 15.5 | 22.38 | 30 |
| 20-S | M 30×2.0 | 19.5 | 29.84 | 36 |
| 25-S | M 36×2.0 | 24.5 | 33.84 | 46 |
| 30-S | M 42×2.0 | 29.5 | 39.84 | 50 |
| 38-S | M 52×2.0 | 37.5 | 49.84 | 60 |

Dimensioning

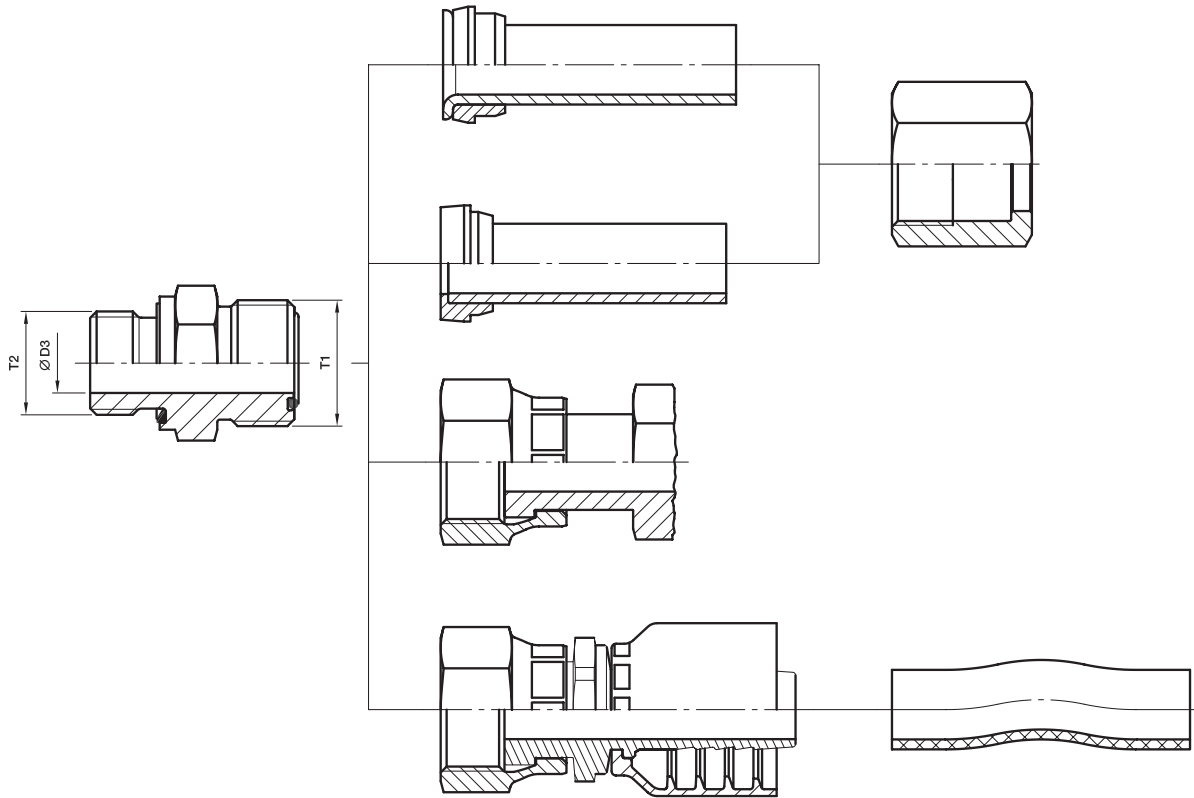
Overview O-Lok® connections



Overview O-Lok® connections

| Size | Tube | | | | T1 Thread UN/UNF | Ø D3 Bore diameter mm | T2 Port thread | | | | |
|-------|---------------------------|------------------------------|---------------------------|--------------------------------|------------------------|--------------------------------|-------------------|-----------|-------|----------|-------------|
| | Metric tube O.D. mm | max. Wall thickness mm | Inch tube O.D. inch | max. Wall thickness inch | | | BSP | UN/UNF | NPTF | metric | |
| 4 | 6 | 1.5 | 1/4 | 0.065 | 9/16-18 | 4.0 | G 1/8 A | 7/16-20 | 1/8 | M 12x1.5 | 1JCxx-4-yy |
| 4-4 | 6 | 1.5 | 1/4 | 0.065 | | 4.5 | G 1/4 A | | 1/4 | | |
| 4-6 | 6 | 1.5 | 1/4 | 0.065 | | 4.5 | G 3/8 A | 9/16-18 | 3/8 | | |
| 4-8 | 6 | 1.5 | 1/4 | 0.065 | | 4.5 | G 1/2 A | 3/4-16 | | | |
| 6 | 8 | 2.0 | 5/16 | 0.095 | 11/16-16 | 6.5 | G 1/4 A | 9/16-18 | 1/4 | M 16x1.5 | 1JCxx-6-yy |
| 6 | 10 | 2.0 | 3/8 | 0.095 | 11/16-16 | 6.5 | G 1/4 A | 9/16-18 | 1/4 | M 16x1.5 | |
| 6-2 | 10 | 2.0 | 3/8 | 0.095 | | 4.5 | G 1/8 A | | | | |
| 6-4 | 10 | 2.0 | 3/8 | 0.095 | | 4.5 | | 7/16-20 | | | |
| 6-6 | 10 | 2.0 | 3/8 | 0.095 | | 6.5 | G 3/8 A | | 3/8 | | |
| 6-8 | 10 | 2.0 | 3/8 | 0.095 | | 6.5 | G 1/2 A | 3/4-16 | 1/2 | | |
| 6-10 | 10 | 2.0 | 3/8 | 0.095 | | 6.5 | | 7/8-14 | | | |
| 6-12 | 10 | 2.0 | 3/8 | 0.095 | 6.5 | G 3/4 A | | | | | |
| 8 | 12 | 3.0 | 1/2 | 0.095 | 13/16-16 | 9.5 | G 3/8 A | 3/4-16 | 3/8 | M 18x1.5 | 1JCxx-8-yy |
| 8-4 | 12 | 3.0 | 1/2 | 0.095 | | 7.5 | G 1/4 A | | | | |
| 8-6 | 12 | 3.0 | 1/2 | 0.095 | | 9.5 | | 9/16-18 | | | |
| 8-8 | 12 | 3.0 | 1/2 | 0.095 | | 9.5 | G 1/2 A | 1/2-20 | | | |
| 8-10 | 12 | 3.0 | 1/2 | 0.095 | | 9.5 | | 7/8-14 | | | |
| 8-12 | 12 | 3.0 | 1/2 | 0.095 | | 9.5 | G 3/4 A | 1 1/16-12 | 3/4 | | |
| 8-16 | 12 | 3.0 | 1/2 | 0.095 | | 9.5 | | 1 5/16-12 | | | |
| 10 | 14 | 2.5 | | | 1-14 | 12.5 | G 1/2 A | 7/8-14 | 1/2 | M 22x1.5 | 1JCxx-10-yy |
| 10 | 15 | 2.5 | | | 1-14 | 12.5 | G 1/2 A | 7/8-14 | 1/2 | M 22x1.5 | |
| 10 | 16 | 3.0 | 5/8 | 0.120 | 1-14 | 12.5 | G 1/2 A | 7/8-14 | 1/2 | M 22x1.5 | |
| 10-6 | 16 | 3.0 | 5/8 | 0.120 | | 10.0 | G 3/8 A | | | | |
| 10-8 | 16 | 3.0 | 5/8 | 0.120 | | 9.5 | | 3/4-16 | | | |
| 10-12 | 16 | 3.0 | 5/8 | 0.120 | | 12.5 | G 3/4 A | 1 1/16-12 | 3/4 | | |
| 10-16 | 16 | 3.0 | 5/8 | 0.120 | | 12.5 | G 1 A | | | | |
| 12 | 18 | 3.0 | | | 1 3/16-12 | 15.5 | G 3/4 A | 1 1/16-12 | 3/4 | M 27x2.0 | 1JCxx-20-yy |
| 12 | 20 | 3.5 | 3/4 | 0.156 | 1 3/16-12 | 15.5 | G 3/4 A | 1 1/16-12 | 3/4 | M 27x2.0 | |
| 12-8 | 20 | 3.5 | 3/4 | 0.156 | | 9.5 | G 1/2 A | 3/4-16 | 1/2 | | |
| 12-10 | 20 | 3.5 | 3/4 | 0.156 | | 12.5 | | 7/8-14 | | | |
| 12-16 | 20 | 3.5 | 3/4 | 0.156 | | 12.5 | G 1 A | 1 5/16-12 | 1 | | |
| 12-20 | 20 | 3.5 | 3/4 | 0.156 | 12.5 | G 1 1/4 A | | | | | |
| 16 | 22 | 4.0 | | | 1 7/16-12 | 20.5 | G 1 A | 1 5/16-12 | 1 | M 33x2.0 | 1JCxx-16-yy |
| 16 | 25 | 4.0 | 1 | 0.188 | 1 7/16-12 | 20.5 | G 1 A | 1 5/16-12 | 1 | M 33x2.0 | |
| 16-12 | 25 | 4.0 | 1 | 0.188 | | 15.5 | G 3/4 A | 1 1/16-12 | 3/4 | | |
| 16-20 | 25 | 4.0 | 1 | 0.188 | | 20.5 | G 1 1/4 A | 1 5/8-12 | | | |
| 16-24 | 25 | 4.0 | 1 | 0.188 | | 20.5 | G 1 1/2 A | | | | |
| 20 | 28 | 4.0 | | | 1 11/16-12 | 26.0 | G 1 1/4 A | 1 5/8-12 | 1 1/4 | M 42x2.0 | 1JCxx-20-yy |
| 20 | 30 | 4.0 | | | 1 11/16-12 | 26.0 | G 1 1/4 A | 1 5/8-12 | 1 1/4 | M 42x2.0 | |
| 20 | 32 | 4.0 | 1 1/4 | 0.188 | 1 11/16-12 | 26.0 | G 1 1/4 A | 1 5/8-12 | 1 1/4 | M 42x2.0 | |
| 20-16 | 32 | 4.0 | 1 1/4 | 0.188 | | 21.5 | G 1 A | 1 5/16-12 | | | |
| 20-24 | 32 | 4.0 | 1 1/4 | 0.188 | | 26.0 | G 1 1/2 A | 1 7/8-12 | | | |
| 24 | 35 | 4.0 | | | 2-12 | 32.0 | G 1 1/2 A | 1 7/8-12 | 1 1/2 | M 48x2.0 | 1JCxx-24-yy |
| 24 | 38 | 5.0 | 1 1/2 | 0.220 | 2-12 | 32.0 | G 1 1/2 A | 1 7/8-12 | 1 1/2 | M 48x2.0 | |
| 24-20 | 38 | 5.0 | 1 1/2 | 0.220 | | 27.5 | G 1 1/4 A | 1 5/8-12 | | | |
| 32 | 50 | 3.0 | 2 | 0.120 | 2 1/2-12 | 45.0 | G 2 A | 2 1/2-12 | | M 60x2.0 | — |

xx – Fitting Series • yy – Hose Size
From Parker hose fitting (HPDE and PFDE)

Dimensioning

O-Lok® end (ISO 8434-3/SAE J1453)/dimensions

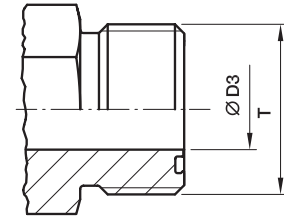

| Ø D5 Size | Tube O.D. | | T UN/UNF | T Major thread Ø mm | Ø D3 mm |
|--------------|-----------|------------|-------------|------------------------|---------|
| | inch | mm | | | |
| 4 | 1/4 | 6 | 9/16-18 | 14.0 | 5.0 |
| 6 | 5/16, 3/8 | 8, 10 | 11/16-16 | 17.0 | 6.5 |
| 8 | 1/2 | 12 | 13/16-16 | 20.5 | 9.5 |
| 10 | 5/8 | 14, 15, 16 | 1-14 | 25.0 | 12.5 |
| 12 | 3/4 | 18, 20 | 1 3/16-12 | 30.0 | 15.5 |
| 16 | 7/8, 1 | 22, 25 | 1 7/16-12 | 36.0 | 20.5 |
| 20 | 1 1/4 | 28, 30, 32 | 1 11/16-12 | 42.5 | 26.0 |
| 24 | 1 1/2 | 35, 38 | 2-12 | 50.5 | 32.0 |
| 32 | 2 | 50 | 2 1/2-12 | 63.0 | 45.0 |

All dimensions shown are nominal for identification only.
Small deviations may be found between SAE J1453 or ISO 8434-3 on bore sizes.

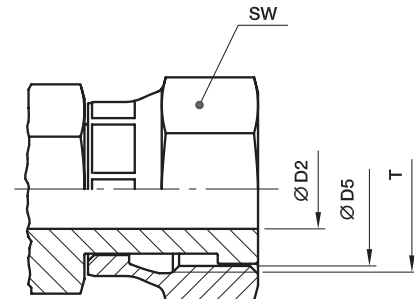
O-Lok® swivel connector (ISO 8434-3/SAE J1453)/dimensions

D

| Size | Tube O.D. | | T UN/UNF | Ø D5 Thread core diameter mm | SW mm | Ø D2 mm |
|------|-----------|------------|-------------|------------------------------------|-------|---------|
| | inch | mm | | | | |
| 4 | 1/4 | 6 | 9/16-18 | 12.5 | 17 | 4.0 |
| 6 | 5/16, 3/8 | 8, 10 | 11/16-16 | 16.0 | 22 | 6.5 |
| 8 | 1/2 | 12 | 13/16-16 | 19.0 | 24 | 9.0 |
| 10 | 5/8 | 14, 15, 16 | 1-14 | 23.0 | 30 | 11.5 |
| 12 | 3/4 | 18, 20 | 1 3/16-12 | 28.0 | 36 | 14.0 |
| 16 | 7/8, 1 | 22, 25 | 1 7/16-12 | 34.0 | 41 | 20.0 |
| 20 | 1 1/4 | 28, 30, 32 | 1 11/16-12 | 40.5 | 50 | 26.0 |
| 24 | 1 1/2 | 35, 38 | 2-12 | 48.0 | 60 | 32.0 |

All dimensions shown are nominal for identification only.
Small deviations may be found between SAE J1453 or ISO 8434-3 on bore sizes.

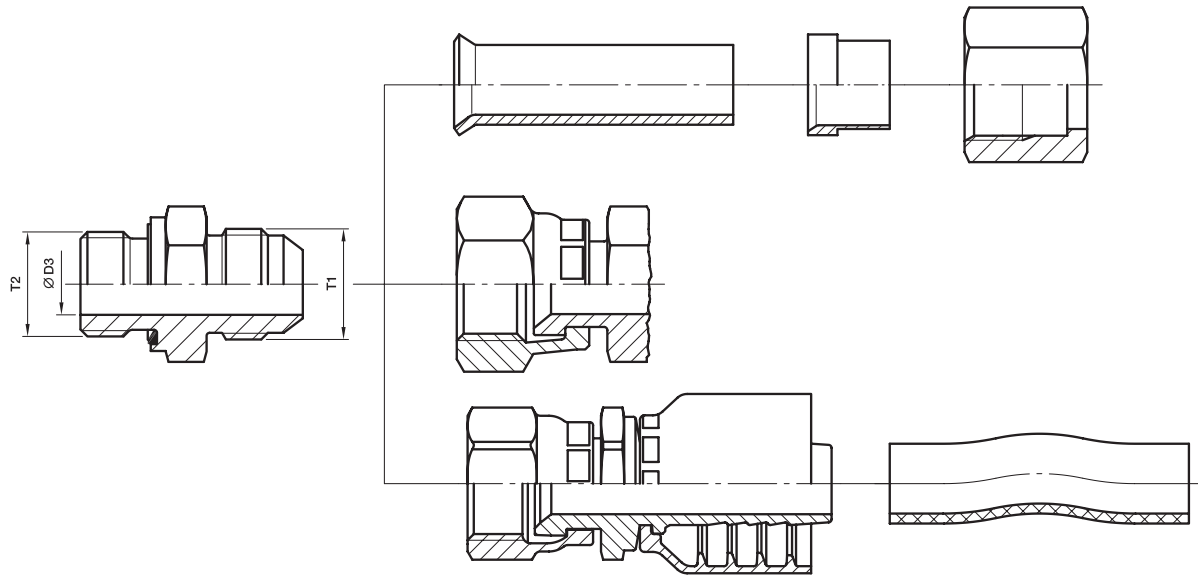
Overview Triple-Lok® connections

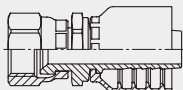

Overview Triple-Lok® connections

| Size | Tube | | | | T1 Thread UN/UNF | Ø D3 Bore diameter mm | T2 Port thread | | |  |
|-------|-------------|------------------------------|--------------|--------------------------------|------------------------|--------------------------------|----------------------|-----------|----------|---|
| | Metric tube | | Inch tube | | | | BSPP (BSPT, NPTF) | UN/UNF | metric | |
| | O.D. mm | max. Wall thickness mm | O.D. inch | max. Wall thickness inch | | | | | | |
| 4 | 6 | 1.5 | 1/4 | 0.065 | 7/16-20 | 4.5 | G 1/8 A | 7/16-20 | M 10×1.0 | 168xx-4-yy |
| 4-4 | 6 | 1.5 | 1/4 | 0.065 | | 4.5 | G 1/4 A | | | |
| 4-5 | 6 | 1.5 | 1/4 | 0.065 | | 4.5 | | 1/2-20 | | |
| 4-6 | 6 | 1.5 | 1/4 | 0.065 | | 4.5 | G 3/8 A | 9/16-18 | | |
| 4-8 | 6 | 1.5 | 1/4 | 0.065 | | 4.5 | G 1/2 A | | | |
| 5 | 8 | 1.5 | 5/16 | 0.065 | 1/2-20 | 6.0 | G 1/8 A | 1/2-20 | M 12×1.5 | 168xx-5-yy |
| 5-4 | 8 | 1.5 | 5/16 | 0.065 | | 6.0 | G 1/4 A | | | |
| 5-6 | 8 | 1.5 | 5/16 | 0.065 | | 6.0 | G 3/8 A | | | |
| 5-8 | 8 | 1.5 | 5/16 | 0.065 | | 6.0 | G 1/2 A | | | |
| 6-2 | 10 | 1.5 | 3/8 | 0.065 | 9/16-18 | 7.5 | G 1/8 A | 9/16-18 | M 14×1.5 | 106xx-6-yy |
| 6 | 10 | 1.5 | 3/8 | 0.065 | | 7.5 | G 1/4 A | | | |
| 6-6 | 10 | 1.5 | 3/8 | 0.065 | | 7.5 | G 3/8 A | | | |
| 6-8 | 10 | 1.5 | 3/8 | 0.065 | | 7.5 | G 1/2 A | | | |
| 8-4 | 12 | 2.0 | 1/2 | 0.083 | 3/4-16 | 10.0 | G 1/4 A | 3/4-16 | M 16×1.5 | 168xx-8-yy |
| 8 | 12 | 2.0 | 1/2 | 0.083 | | 10.0 | G 3/8 A | | | |
| 8-8 | 12 | 2.0 | 1/2 | 0.083 | | 10.0 | G 1/2 A | | M 18×1.5 | |
| 8-10 | 12 | 2.0 | 1/2 | 0.083 | | 10.0 | | 7/8-14 | | |
| 8-12 | 12 | 2.0 | 1/2 | 0.083 | | 10.0 | G 3/4 A | 1 1/16-12 | | |
| | | | | | | | | | | |
| 10-6 | 14, 15, 16 | 2.5 | 5/8 | 0.095 | 7/8-14 | 12.5 | G 3/8 A | 3/4-16 | M 18×1.5 | 168xx-10-yy |
| 10-8 | 14, 15, 16 | 2.5 | 5/8 | 0.095 | | 12.5 | | | | |
| 10 | 14, 15, 16 | 2.5 | 5/8 | 0.095 | | 12.5 | G 1/2 A | 7/8-14 | | |
| 10-12 | 14, 15, 16 | 2.5 | 5/8 | 0.095 | | 12.5 | G 3/4 A | 1 1/16-12 | | |
| 12-8 | 18, 20 | 3.0 | 3/4 | 0.109 | 1 1/16-12 | 15.5 | G 1/2 A | 3/4-16 | M 27×2.0 | 106xx-12-yy |
| 12-10 | 18, 20 | 3.0 | 3/4 | 0.109 | | 15.5 | | 7/8-14 | | |
| 12 | 18, 20 | 3.0 | 3/4 | 0.109 | | 15.5 | G 3/4 A | 1 1/16-12 | | |
| 12-16 | 18, 20 | 3.0 | 3/4 | 0.109 | | 15.5 | G 1 A | 1 5/16-12 | | |
| | | | | | | | | | | |
| 14 | 22 | 3.0 | 7/8 | 0.109 | 1 3/16-12 | 18.0 | G 3/4 A | 1 3/16-12 | M 27×2.0 | - |
| 14-16 | 22 | 3.0 | 7/8 | 0.109 | | 18.0 | G 1 A | 1 5/16-12 | | |
| 16-12 | 25 | 3.0 | 1 | 0.120 | 1 5/16-12 | 21.5 | G 3/4 A | 1 1/16-12 | M 33×2.0 | 106xx-16-yy |
| 16 | 25 | 3.0 | 1 | 0.120 | | 21.5 | G 1 A | 1 5/16-12 | | |
| 16-20 | 25 | 3.0 | 1 | 0.120 | | 21.5 | G 1 1/4 A | 1 5/8-12 | | |
| 20-12 | 28, 30, 32 | 3.0 | 1 1/4 | 0.120 | 1 5/8-12 | 27.5 | G 3/4 A | 1 5/8-12 | M 42×2.0 | 106xx-20-yy |
| 20-16 | 28, 30, 32 | 3.0 | 1 1/4 | 0.120 | | 27.5 | G 1 A | | | |
| 20 | 28, 30, 32 | 3.0 | 1 1/4 | 0.120 | | 27.5 | G 1 1/4 A | | | |
| 24-20 | 35, 38 | 4.0 | 1 1/2 | 0.120 | 1 7/8-12 | 33.0 | G 1 1/4 A | 1 7/8-12 | M 48×2.0 | 106xx-24-yy |
| 24 | 35, 38 | 4.0 | 1 1/2 | 0.120 | 33.0 | G 1 1/2 A | | | | |
| 28-24 | 42 | 3.0 | | | 2 1/4-12 | 39.0 | G 1 1/2 A | | | - |
| 32 | 50 | 3.5 | 2 | 0.134 | 2 1/2-12 | 45.0 | G 2 A | 2 1/2-12 | | 106xx-32-yy |

xx – Fitting Series • yy – Hose Size
From Parker hose fitting
(HPDE and PFDE)

Dimensioning

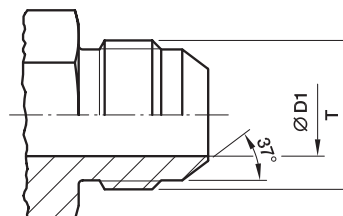
Triple-Lok® end (ISO 8434-2/SAE J514)/dimensions

| Size | Tube O.D. | | T UN/UNF | T Major thread Ø mm | Ø D1 mm |
|------|-----------|------------|-------------|------------------------|---------|
| | inch | mm | | | |
| 4 | 1/4 | 6 | 7/16-20 | 11.0 | 4.5 |
| 5 | 5/16 | 8 | 1/2-20 | 12.5 | 6.0 |
| 6 | 3/8 | 10 | 9/16-18 | 14.0 | 7.5 |
| 8 | 1/2 | 12 | 3/4-16 | 19.0 | 10.0 |
| 10 | 5/8 | 14, 15, 16 | 7/8-14 | 22.0 | 12.5 |
| 12 | 3/4 | 18, 20 | 1 1/16-12 | 27.0 | 15.5 |
| 14 | 7/8 | 22 | 1 3/16-12 | 30.0 | 18.0 |
| 16 | 1 | 25 | 1 5/16-12 | 33.0 | 21.5 |
| 20 | 1 1/4 | 28, 30, 32 | 1 5/8-12 | 41.0 | 27.5 |
| 24 | 1 1/2 | 35, 38 | 1 7/8-12 | 47.5 | 33.0 |
| 28* | 1 3/4 | 42 | 2 1/4-12 | 57.0 | 39.0 |
| 32 | 2 | - | 2 1/2-12 | 63.5 | 45.0 |

*Size 28 is not part of SAE J514 or ISO 8434-2.

All dimensions shown are nominal for identification only.
Small deviations may be found between SAE J514 or ISO 8434-2 on bore sizes.

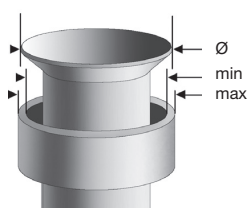
Suitable Flare

| Tube O.D. | | Ø D | |
|-----------|--------|------|------|
| mm | inch | Min. | Max. |
| 6 | 1/4" | 8.6 | 9.7 |
| 8 | 5/16" | 10.2 | 11.3 |
| 10 | 3/8" | 11.7 | 12.7 |
| 12 | 1/2" | 16.0 | 17.3 |
| 14 | | 19.3 | 20.2 |
| 15 | | 19.3 | 20.2 |
| 16 | 5/8" | 19.3 | 20.2 |
| 18 | | 23.4 | 24.7 |
| 20 | 3/4" | 23.4 | 24.7 |
| 22 | 7/8" | 26.5 | 27.8 |
| 25 | 1" | 29.7 | 31.0 |
| 28 | | 37.6 | 38.9 |
| 30 | | 37.6 | 38.9 |
| 32 | 1 1/4" | 37.6 | 38.9 |
| 35 | | 43.2 | 45.3 |
| 38 | 1 1/2" | 43.2 | 45.3 |
| 42 | | 52.0 | 54.8 |
| | 2" | 59.2 | 61.2 |

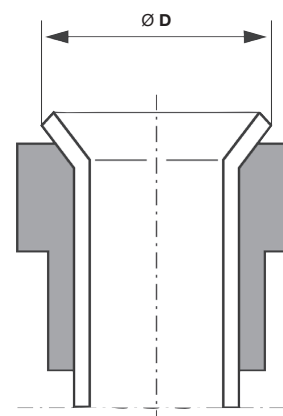

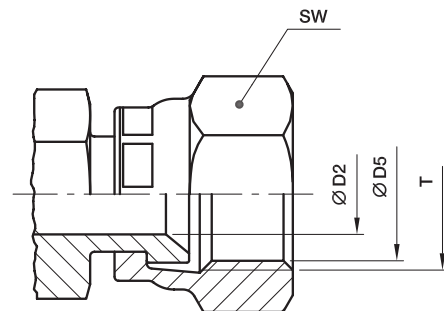
Triple-Lok® swivel connector (ISO 8434-2/SAE J514)/dimensions

D

| Size | Tube O.D. | | T UN/UNF | SW mm | Ø D5 Thread core diameter mm | Ø D2 mm |
|------|-----------|------------|-------------|-------|------------------------------------|---------|
| | inch | mm | | | | |
| 4 | 1/4 | 6 | 7/16-20 | 17 | 10.0 | 4.4 |
| 5 | 5/16 | 8 | 1/2-20 | 17 | 11.5 | 6.0 |
| 6 | 3/8 | 10 | 9/16-18 | 19 | 13.0 | 7.5 |
| 8 | 1/2 | 12 | 3/4-16 | 22 | 17.5 | 9.9 |
| 10 | 5/8 | 14, 15, 16 | 7/8-14 | 27 | 20.5 | 12.3 |
| 12 | 3/4 | 18, 20 | 1 1/16-12 | 32 | 25.0 | 15.5 |
| 14 | 7/8 | 22 | 1 3/16-12 | 35 | 28.0 | 18.0 |
| 16 | 1 | 25 | 1 5/16-12 | 38 | 31.0 | 21.5 |
| 20 | 1 1/4 | 28, 30, 32 | 1 5/8-12 | 50 | 39.0 | 27.5 |
| 24 | 1 1/2 | 35, 38 | 1 7/8-12 | 60 | 45.5 | 33.0 |
| 32 | 2 | - | 2 1/2-12 | 75 | 61.5 | 45.0 |

All dimensions shown are nominal for identification only.
Small deviations may be found between SAE J514 or ISO 8434-2 on bore sizes.

Dimensioning

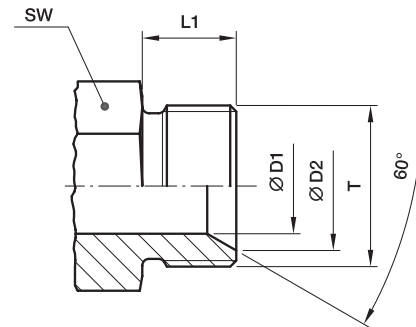
DIN 60° cone end (DIN 7631)/dimensions

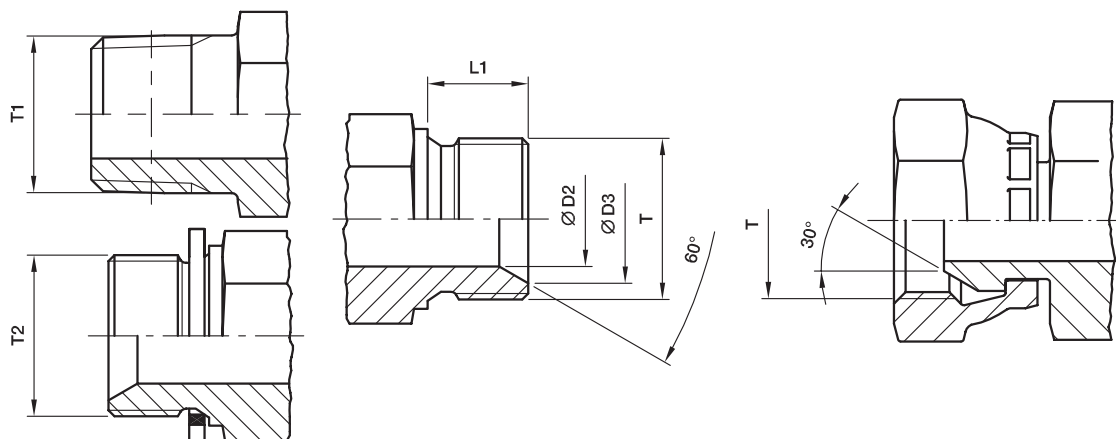

| Tube O.D. mm | T | Ø D1 mm | Ø D2 mm | L1 mm | SW mm |
|--------------|----------|---------|---------|-------|-------|
| 4-5 | M 10×1.5 | 3 | 8.0 | 8 | 11 |
| 06 | M 12×1.5 | 4 | 9.0 | 10 | 12 |
| 08 | M 14×1.5 | 6 | 11.0 | 10 | 14 |
| 10 | M 16×1.5 | 8 | 13.0 | 11 | 17 |
| 12 | M 18×1.5 | 10 | 15.0 | 11 | 19 |
| 15 | M 22×1.5 | 12 | 19.0 | 12 | 24 |
| 18 | M 26×1.5 | 15 | 22.0 | 12 | 27 |
| 22 | M 30×1.5 | 19 | 26.0 | 14 | 32 |
| 28 | M 38×1.5 | 25 | 33.0 | 14 | 41 |
| 35 | M 45×1.5 | 32 | 40.0 | 16 | 46 |
| 42 | M 52×1.5 | 39 | 47.0 | 16 | 55 |

Adapter 60° cone end (ISO/DIS 8434-6)/dimensions

| Size | T | D2 | D3 | L1 | T1 | | T2 |
|------|-----------|------|------|----|------|--------|-------|
| | BSPP | mm | mm | | BSPT | NPT(F) | |
| 02 | G 1/8 A | 3.5 | 7.5 | 8 | 1/8 | 1/8 | 1/8 |
| | | | | | 1/4 | 1/4 | |
| 04 | G 1/4 A | 4.7 | 10.4 | 11 | 1/4 | 1/4 | 1/4 |
| | | | | | 1/8 | 1/8 | 1/8 |
| | | | | | 3/8 | 3/8 | 3/8 |
| 06 | G 3/8 A | 7.9 | 14.0 | 12 | 3/8 | 3/8 | 3/8 |
| | | | | | 1/4 | 1/4 | 1/4 |
| | | | | | 1/2 | 1/2 | 1/4 |
| 08 | G 1/2 A | 11.1 | 17.5 | 14 | 1/2 | 1/2 | 1/2 |
| | | | | | 3/8 | 3/8 | 1/4 |
| | | | | | | 3/4 | 3/8 |
| 10 | G 5/8 A | 14.3 | 19.3 | 16 | 1/2 | | 1/2 |
| | | | | | 3/4 | | 5/8 |
| 12 | G 3/4 A | 16.7 | 22.9 | 16 | 3/4 | 3/4 | 3/4 |
| | | | | | 1/2 | 1/2 | 1/4 |
| | | | | | 1 | 1 | 3/8 |
| | | | | | | | 1/2 |
| 16 | G 1 A | 22.2 | 28.7 | 19 | | | 5/8 |
| | | | | | | | 3/4 |
| | | | | | 1 | 1 | 1 |
| | | | | | 3/4 | 3/4 | 1/2 |
| 20 | G 1 1/4 A | 28.6 | 36.8 | 22 | | | 3/4 |
| | | | | | | | 1 |
| | | | | | | | 1 1/4 |
| | | | | | | | 1 |
| 24 | G 1 1/2 A | 33.3 | 42.7 | 22 | | | 1 1/4 |
| | | | | | | | 1 |
| | | | | | | | 1 1/2 |
| | | | | | | | 1 1/4 |
| 32 | G 2 A | 46.0 | 54.6 | 25 | | | 1 1/2 |
| | | | | | | | 2 |

NPSM Swivel adapters (SAE J516)/dimensions

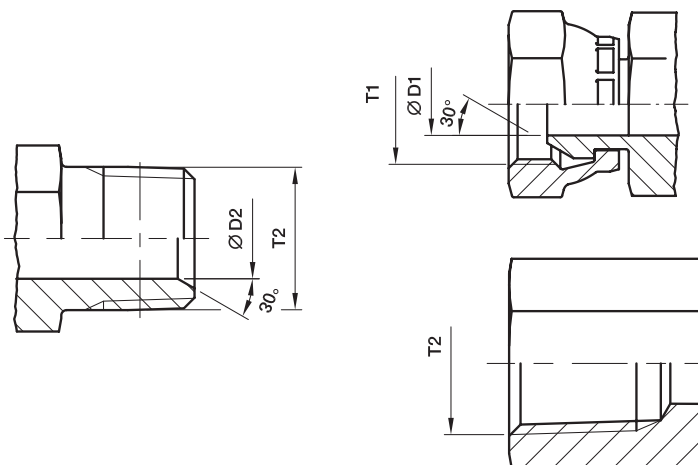

| Size | T1 Thread NPSM | Ø D1 mm | Ø D2 mm | T2 Thread NPTF |
|-------|----------------------|---------|---------|----------------------|
| 2-2 | 1/8-27 | 4.0 | 5.0 | 1/8-27 |
| 2-4 | 1/4-18 | 5.6 | 7.0 | 1/8-27 |
| 4-4 | 1/4-18 | 5.6 | 7.0 | 1/4-18 |
| 4-6 | 3/8-18 | 8.8 | 10.0 | 1/4-18 |
| 4-8 | 1/2-14 | 12.0 | 13.5 | 1/4-18 |
| 6-4 | 1/4-18 | 5.6 | 7.0 | 3/8-18 |
| 6-6 | 3/8-18 | 8.8 | 10.0 | 3/8-18 |
| 6-8 | 1/2-14 | 12.0 | 13.5 | 3/8-18 |
| 8-4 | 1/4-18 | 5.6 | 7.0 | 3/4-16 |
| 8-6 | 3/8-18 | 8.8 | 10.0 | 1/2-14 |
| 8-8 | 1/2-14 | 12.0 | 13.5 | 1/2-14 |
| 8-12 | 3/4-14 | 16.3 | 18.0 | 1/2-14 |
| 10-6 | 3/8-18 | 8.8 | 10.0 | 7/8-14 |
| 10-8 | 1/2-14 | 12.0 | 13.5 | 7/8-14 |
| 10-12 | 3/4-14 | 16.3 | 18.0 | 7/8-14 |
| 12-6 | 3/8-18 | 8.8 | 10.0 | 3/4-14 |
| 12-8 | 1/2-14 | 12.0 | 13.5 | 3/4-14 |
| 12-12 | 3/4-14 | 16.3 | 18.0 | 3/4-14 |
| 12-16 | 1-11.5 | 21.4 | 28.9 | |
| 16-12 | 3/4-14 | 16.3 | 13.5 | 1-11.5 |
| 16-16 | 1-11.5 | 21.4 | 28.9 | 1-11.5 |
| 16-20 | 1 1/4-11.5 | 29.0 | 32.0 | 1-11.5 |
| 20-16 | 1-11.5 | 21.4 | 28.9 | 1 1/4-11.5 |
| 20-20 | 1 1/4-11.5 | 29.0 | 32.0 | 1 1/4-11.5 |
| 24-24 | 1 1/2-11.5 | 34.5 | 38.0 | 1 1/2-11.5 |
| 32-32 | 2-11.5 | 46.0 | 49.0 | 2-11.5 |

Male stud ends/Port end dimensions for tube fittings

Preferred male stud ends for hydraulic applications

For new designs the metric version is recommended according to DIN ISO 6149

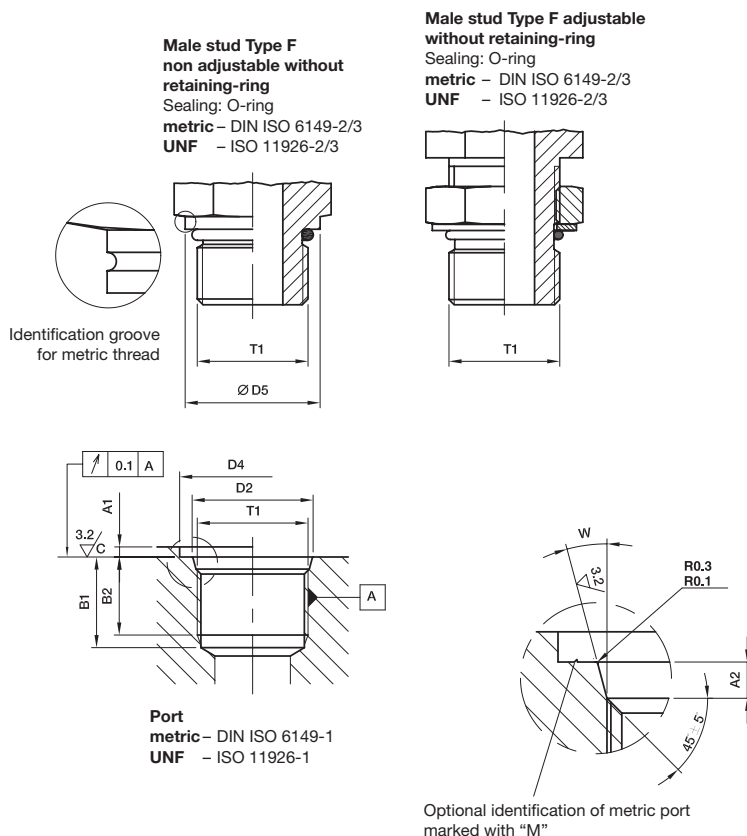

| Thread T1 | D5 | D4 | | D2 0.1 | A1 max. | A2 0.4 | B1 min. | B2 min. | W ± 1° | Identification internal | |
|-----------------|------|---------------|--------------|-----------|------------|-----------|------------|------------|-----------|--------------------------|--------------------------|
| | | small min. | wide min. | | | | | | | Thread major diameter | Thread minor diameter |
| M 08x1.0 | 11.8 | 14 | 17 | 9.10 | 1.0 | 1.6 | 11.5 | 10.0 | 12° | 8.00 | 6.92 |
| M 10x1.0 | 13.8 | 16 | 20 | 11.10 | 1.0 | 1.6 | 11.5 | 10.0 | 12° | 10.00 | 8.92 |
| M 12x1.5 | 16.8 | 19 | 23 | 13.80 | 1.5 | 2.4 | 14.0 | 11.5 | 15° | 12.00 | 10.38 |
| M 14x1.5 | 18.8 | 21 | 25 | 15.80 | 1.5 | 2.4 | 14.0 | 11.5 | 15° | 14.00 | 12.38 |
| M 16x1.5 | 21.8 | 24 | 28 | 17.80 | 1.5 | 2.4 | 15.5 | 13.0 | 15° | 16.00 | 14.38 |
| M 18x1.5 | 23.8 | 26 | 30 | 19.80 | 2.0 | 2.4 | 17.0 | 14.5 | 15° | 18.00 | 16.38 |
| M 22x1.5 | 26.8 | 29 | 34 | 23.80 | 2.0 | 2.4 | 18.0 | 15.5 | 15° | 22.00 | 20.38 |
| M 27x2.0 | 31.8 | 34 | 40 | 29.40 | 2.0 | 3.1 | 22.0 | 19.0 | 15° | 27.00 | 24.84 |
| M 33x2.0 | 40.8 | 43 | 49 | 35.40 | 2.5 | 3.1 | 22.0 | 19.0 | 15° | 33.00 | 30.84 |
| M 42x2.0 | 49.8 | 52 | 60 | 44.40 | 2.5 | 3.1 | 22.5 | 19.5 | 15° | 42.00 | 39.84 |
| M 48x2.0 | 54.8 | 57 | 66 | 50.40 | 2.5 | 3.1 | 25.0 | 22.0 | 15° | 48.00 | 45.84 |
| 7/16-20 UNF-2B | 13.8 | 21 | – | 12.40 | 1.6 | 2.4 | 14.0 | 11.5 | 12° | 11.11 | 9.74 |
| 1/2-20 UNF-2B | 16.8 | 23 | – | 14.50 | 1.6 | 2.5 | 14.0 | 11.5 | 12° | 12.70 | 11.30 |
| 9/16-18 UNF-2B | 16.8 | 25 | – | 15.65 | 1.6 | 2.5 | 15.5 | 12.7 | 12° | 14.29 | 12.76 |
| 3/4-16 UNF-2B | 21.8 | 30 | – | 20.60 | 2.4 | 2.5 | 17.5 | 14.3 | 15° | 19.05 | 17.33 |
| 7/8-14 UNF-2B | 26.8 | 34 | – | 23.95 | 2.4 | 2.5 | 20.0 | 16.7 | 15° | 22.23 | 20.26 |
| 1 1/16-12 UN-2B | 31.8 | 41 | – | 29.15 | 2.4 | 3.3 | 23.0 | 19.0 | 15° | 26.99 | 24.69 |
| 1 5/16-12 UN-2B | 40.8 | 49 | – | 35.50 | 3.2 | 3.3 | 23.0 | 19.0 | 15° | 33.34 | 31.04 |
| 1 5/8-12 UN-2B | 49.8 | 58 | – | 43.50 | 3.2 | 3.3 | 23.0 | 19.0 | 15° | 41.28 | 38.99 |
| 1 7/8-12 UN-2B | 54.8 | 65 | – | 49.85 | 3.2 | 3.3 | 23.0 | 19.0 | 15° | 47.63 | 45.33 |

Dimensioning

Port end dimensions for tube fittings

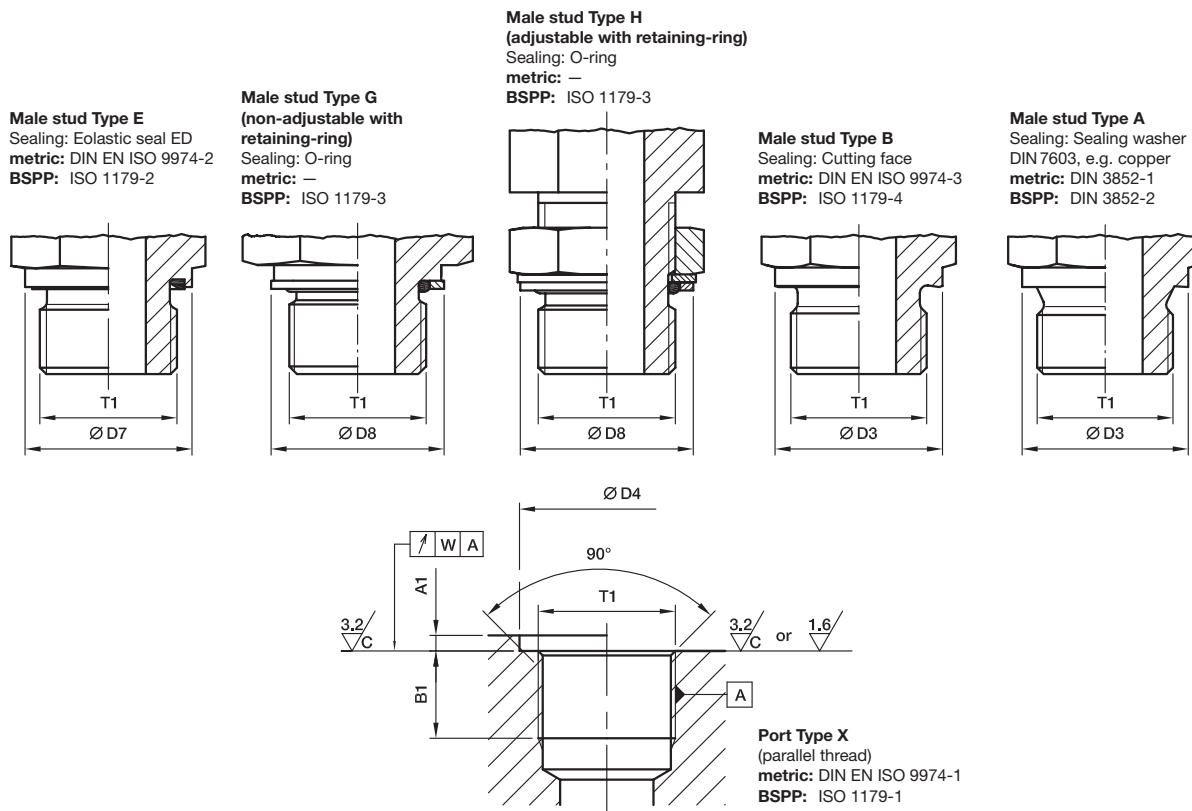

| Thread T1 | Ø D3 mm | Ø D7 mm | D8 | | D4 min. small | D4 ^{+0.4} wide* | A1 max. | B1 min. | W | Identification internal | |
|--------------|---------------|---------------|-------|-------|------------------|-----------------------------|------------|------------|-----|--------------------------|--------------------------|
| | | | small | wide | | | | | | Thread major diameter | Thread minor diameter |
| M 08x1.0 | | | 12.8 | 13.15 | | | | | 0.1 | 8.00 | 6.92 |
| M 10x1.0 | 13.9 | 13.9 | 14.8 | 14.75 | 15 | 20 | 1.0 | 8 | 0.1 | 10.00 | 8.92 |
| M 12x1.5 | 16.9 | 16.9 | 17.8 | 17.75 | 18 | 25 | 1.5 | 12 | 0.1 | 12.00 | 10.38 |
| M 14x1.5 | 18.9 | 18.9 | 19.8 | 19.75 | 20 | 25 | 1.5 | 12 | 0.1 | 14.00 | 12.38 |
| M 16x1.5 | 20.9 | 21.9 | 22.8 | 21.75 | 23 | 28 | 1.5 | 12 | 0.1 | 16.00 | 14.38 |
| M 18x1.5 | 22.9 | 23.9 | 24.8 | 23.75 | 25 | 30 | 2.0 | 12 | 0.1 | 18.00 | 16.38 |
| M 20x1.5 | 24.9 | 25.9 | 26.8 | 25.75 | 27 | 34 | 2.0 | 14 | 0.1 | 20.00 | 18.38 |
| M 22x1.5 | 26.9 | 26.9 | 27.8 | 27.75 | 28 | 34 | 2.5 | 14 | 0.1 | 22.00 | 20.38 |
| M 26x1.5 | 30.9 | 31.9 | 32.8 | 31.75 | 33 | 42 | 2.5 | 16 | 0.2 | 26.00 | 24.38 |
| M 27x2.0 | 31.9 | 31.9 | 32.8 | 32.75 | 33 | 42 | 2.5 | 16 | 0.2 | 27.00 | 24.84 |
| M 33x2.0 | 38.9 | 39.9 | 40.8 | 39.75 | 41 | 47 | 2.5 | 18 | 0.2 | 33.00 | 30.84 |
| M 42x2.0 | 48.9 | 49.9 | 50.8 | 49.75 | 51 | 58 | 2.5 | 20 | 0.2 | 42.00 | 39.84 |
| M 48x2.0 | 54.9 | 54.9 | 55.8 | 54.95 | 56 | 65 | 2.5 | 22 | 0.2 | 48.00 | 45.84 |
| G 1/8 A | 13.8 | 13.9 | 14.8 | 15.00 | 15 | 19 | 1.0 | 8 | 0.1 | 9.73 | 8.57 |
| G 1/4 A | 17.8 | 18.9 | 19.8 | 19.50 | 20 | 25 | 1.5 | 12 | 0.1 | 13.16 | 11.45 |
| G 3/8 A | 21.8 | 21.9 | 22.8 | 23.50 | 23 | 28 | 2.0 | 12 | 0.1 | 16.66 | 14.95 |
| G 1/2 A | 25.8 | 26.9 | 27.8 | 28.50 | 28 | 34 | 2.5 | 14 | 0.1 | 20.96 | 18.63 |
| G 3/4 A | 31.8 | 31.9 | 32.8 | 34.50 | 33 | 42 | 2.5 | 16 | 0.2 | 26.44 | 24.12 |
| G 1 A | 38.8 | 39.9 | 40.8 | 43.50 | 41 | 47 | 2.5 | 18 | 0.2 | 33.25 | 30.29 |
| G 1 1/4 A | 48.8 | 49.9 | 50.8 | 52.50 | 51 | 58 | 2.5 | 20 | 0.2 | 41.91 | 38.95 |
| G 1 1/2 A | 54.8 | 54.9 | 55.8 | 60.00 | 56 | 65 | 2.5 | 22 | 0.2 | 47.80 | 44.85 |

*For inch threads: Enlarged diameter vs. ISO 1179-1 to adopt multiple seal ring designs.

Port end dimensions for tube fittings

Male stud NPT/F

 Sealing: Tapered thread¹⁾
NPT ANSI/ASME B 1.20.1-1983

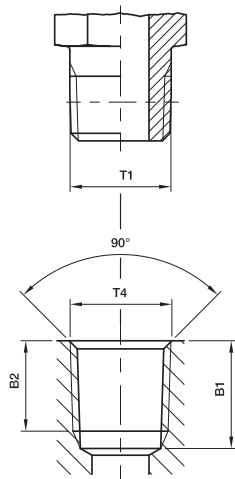
NPTF ANSI/ASME B 1.20.3-1976

Port NPT/F (taper)

NPT ANSI/ASME B 1.20.1-1983

NPTF ANSI/ASME B 1.20.3-1976

Male stud BSPT

 Sealing: Tapered thread¹⁾

ISO 7/BS 21/DIN 2999-1

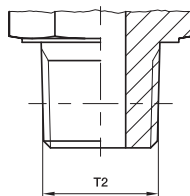

Port BSPP (parallel)

ISO 7/1-Rp

BS 21-Rp (ISO 1179-1)

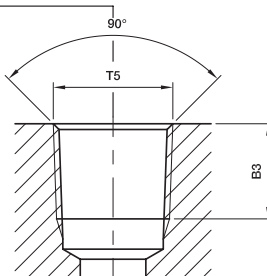

Port BSPT (taper)

ISO 7/1-Rc/BS 21-Rc

DIN 2999-Rc (Japan: PT)

Male stud Type C

 Sealing: Tapered thread short¹⁾
metric DIN 3852-1

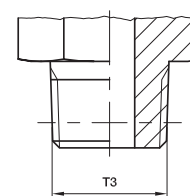
BSPT DIN 3852-2

Port (parallel)

metric DIN 3852-1

BSPP DIN 3852-2

D

| Thread T1 | Thread T2 | Thread T3 | Thread T4 | Thread T5 | B1 min. | B2 min. | B3 min. |
|-------------------|--------------|---------------|-------------------|--------------|------------|------------|------------|
| 1/8-27 NPT/F* | | | 1/8-27 NPT/F* | | 11.6 | 6.9 | |
| 1/4-18 NPT/F* | | | 1/4-18 NPT/F* | | 16.4 | 10.0 | |
| 3/8-18 NPT/F* | | | 3/8-18 NPT/F* | | 17.4 | 10.3 | |
| 1/2-14 NPT/F* | | | 1/2-14 NPT/F* | | 22.6 | 13.6 | |
| 3/4-14 NPT/F* | | | 3/4-14 NPT/F* | | 23.1 | 14.1 | |
| 1-11.5 NPT/F* | | | 1-11.5 NPT/F* | | 27.8 | 16.8 | |
| 1 1/4-11.5 NPT/F* | | | 1 1/4-11.5 NPT/F* | | 28.3 | 17.3 | |
| 1 1/2-11.5 NPT/F* | | | 1 1/2-11.5 NPT/F* | | 28.3 | 17.3 | |
| | R 1/8 | | Rp 1/8 | Rc 1/8 | 9.7 | 7.9 | 7.4 |
| | R 1/4 | | Rp 1/4 | Rc 1/4 | 12.0 | 11.2 | 11.0 |
| | R 3/8 | | Rp 3/8 | Rc 3/8 | 13.5 | 12.0 | 11.4 |
| | R 1/2 | | Rp 1/2 | Rc 1/2 | 17.6 | 15.0 | 15.0 |
| | R 3/4 | | Rp 3/4 | Rc 3/4 | 19.1 | 16.0 | 16.3 |
| | R 1 | | Rp 1 | Rc 1 | 21.4 | 19.1 | 19.0 |
| | R 1 1/4 | | Rp 1 1/4 | Rc 1 1/4 | 21.4 | 19.9 | 21.4 |
| | R 1 1/2 | | Rp 1 1/2 | Rc 1 1/2 | 22.4 | 20.6 | 21.4 |
| | | M 08×1.0 tap. | M 08×1.0 | | 10.0 | 5.5 | |
| | | M 10×1.0 tap. | M 10×1.0 | | 10.0 | 5.5 | |
| | | M 12×1.5 tap. | M 12×1.5 | | 13.5 | 8.5 | |
| | | M 14×1.5 tap. | M 14×1.5 | | 13.5 | 8.5 | |
| | | M 16×1.5 tap. | M 16×1.5 | | 13.5 | 8.5 | |
| | | M 18×1.5 tap. | M 18×1.5 | | 13.5 | 8.5 | |
| | | M 20×1.5 tap. | M 20×1.5 | | 15.5 | 10.5 | |
| | | M 22×1.5 tap. | M 22×1.5 | | 15.5 | 10.5 | |
| | | R 1/8 tap. | Rp 1/8 | | 8.5 | 5.5 | |
| | | R 1/4 tap. | Rp 1/4 | | 12.5 | 8.5 | |
| | | R 3/8 tap. | Rp 3/8 | | 12.5 | 8.5 | |
| | | R 1/2 tap. | Rp 1/2 | | 16.5 | 10.5 | |

*In the EO fitting range only NPT thread is manufactured.

In the Triple-Lok®, O-Lok® and adapters fitting range for steel NPTF thread is manufactured and for stainless steel NPT thread is manufactured.

1) Tightness can only be achieved by liquid or plastic sealing aids.

For your notes

DW Technology



Tube assembly



Tube assembly

Index

| | |
|---|-----|
| Safety instructions..... | E4 |
| General | E5 |
| Selection of assembly process..... | E6 |
| New EO assembly instructions for 30° final assembly | E10 |
| EO Progressive ring PSR/DPR | E11 |
| EO-2 assembly instructions..... | E16 |
| Checking instructions for EO assembly tools..... | E22 |
| EO2-FORM assembly instructions | E23 |
| Checking instructions for EO2-FORM tools | E29 |
| Weld fitting assembly..... | E30 |
| O-Lok® assembly instructions | E31 |
| Triple-Lok® assembly instructions | E35 |
| Checking instructions for O-Lok® / Triple-Lok® | E39 |
| Ferulok® assembly instructions | E40 |

Tube assembly

Safety instructions

Tube fittings are safe high-pressure connections

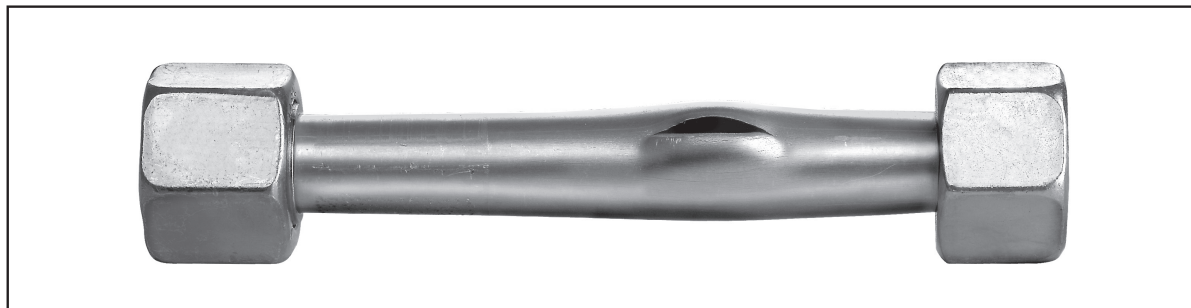

A carefully assembled Parker tube fitting will provide a sealed joint even up to tube burst. Experience has shown that break-downs, re-tightening and leaks can be avoided by following these safety instructions. Please review your fitting procedures.

General safety instructions

- Uncompleted assembly will reduce the pressure and vibration capability of a fitting. It can reduce the life cycle time of a connection and leakage can occur. In extreme cases the connection can fail due to tube shear or tube crack.
- After opening a tube connection, the unit has to be re-tightened with the same force used during prior assembly. Under tightening can result in leakage and can reduce the vibration resistance. Over tightening can reduce the possibilities of repeated assembly. In extreme cases the components can be destroyed.
- Parker tube fittings are intended solely for connections for fluid applications.
- Observe tube recommendations. Non-standard materials or tolerances lead to incorrect assembly.
- Do not use ball bearings, fitting pins or tapered pins, coins or washers instead of the correct Parker blanking plug as blanking parts for 24° cones.
- Tube connection and fitting body once assembled, should remain together. Fitting body is to be used once only for pre-assembly.
- Air bleeding of tube fittings which are under pressure can be dangerous.
- Tube under tension can lead to vibration failure. Tube length and bend angles are to be adhered to precisely. Fix tube lines with tube clamps.
- Tubes are not to be clamped to one another but to suitable fixed points. Plate brackets, cable connections and fixing elements are not suitable. Tubes are not mountings on which to integrate other components e.g. filters, ventilators or shut-off valves.
- Prevent oscillation, pressure surges and inherent strain by using flexible hoses for example.
- Under and over tightening of fittings during assembly reduces the capacity for withstanding pressure and vibration loads and therefore reduces the life of the tube fitting. Leaks from the tube can occur under these circumstances.
- When dismantling/transporting and re-assembling, make sure that no dirt enters the system, that the connection elements (threads, sealing surfaces) are not damaged, seals are not lost and tubes are not bent or flattened. We recommend the use of suitable protective caps.
- Disassembled fittings are to be checked for accuracy and damage and replaced if necessary.
- Do not use hand cutters or tube cutters.

- Dirt and metal contamination can lead to damage to the system and leaks.
- The operating parameters given (e.g. pressure, temperature, medium compatibility) are to be adhered to.
- Avoid flow rates > 8 m/s. The resulting forces are high and can destroy the tube lines.
- Relevant guidelines (e.g. CE, ISO, BG, TÜV, DIN) are to be observed.
- Weld fittings are manufactured out of weldable materials. No other fittings are suitable for welding.
- EO-NIROMONT and Parflange LUBSS are high-performance lubricants. The use of other lubricants generally leads to an increase in assembly force.
- The tools and lubricants recommended by Parker guarantee safe assembly.
- Components and tooling of different manufacturers are not necessarily compatible. For complete safety, use only Parker components.
- Fittings are to be handled with care.
- Tube lines need to be adapted tension free of the relevant connectors before assembly. An easy turning of the nut is required for the complete thread length. Otherwise leakage can occur. In extreme cases with additional vibrations tube cracks can occur.
- Vibrations have to be clamped by tube clamps. Independent vibrating units need to be separated with hoses. Otherwise tube cracks can occur.

Specific safety instructions for assembly

- During a progressive ring and EO-2 fitting assembly the tube has to bottom up in the stud or in the tool. Without tube bottoming the ring cannot bite sufficiently. Under load the connection can fail due to tube shear.
- Correctly flared tubes are essential for leak free performance of Triple-Lok® fittings. Special care must be taken over the flare diameter and surface finish.
- Preset bite type fittings (Progressive ring) need a final assembly according to assembly instructions.
- Stainless steel progressive ring fittings have to be preassembled in hardened tools. Otherwise the connection may fail under load due to tube shear.
- Do not assemble progressive rings and functional nuts on self-made standpipe stud ends. There is a risk of false assembly with the result of connection shear under load.
- The use of steel cutting rings for stainless steel tubes or other unauthorised tool combinations leads to incorrect assembly.

In case of doubt please contact your Parker representative!

General

Assembly of Parker tube fittings always follows the same pattern:

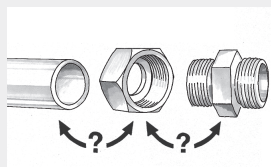

Material combinations

- Use recommended tube material
- Select suitable components according to tube material

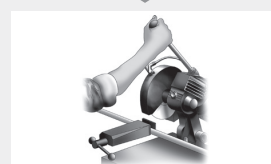

Tube preparation

- Cut and deburr thoroughly
- Follow recommendations for minimum straight tube length
- Apply support sleeves when necessary

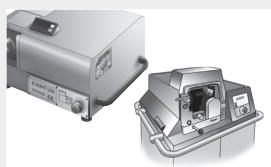

Machine assembly

- Preferred method
- Most efficient method
- Recommended for large EO progressive ring and EO-2
- Parflange® recommended for 37° flaring

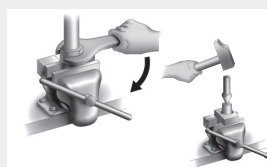

Manual assembly

- Economical for assembly of small quantities
- Suitable for small O.D. tube
- For repair work
- Hand flaring does not provide reliable results
- Stainless steel progressive ring fittings need to be assembled with pre-assembly tools



Assembly check

- Check assembly tube preparation result
- ⚠ Incorrect assemblies must be corrected or scrapped

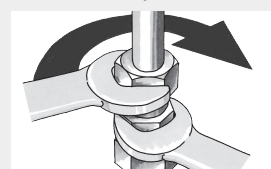

















Final installation

- Final fitting assembly according to instruction
- Do not assemble under tension
- Clamp onto rigid fixtures
- Tighten tube clamps after final fitting installation

Tube assembly

Selection of assembly process for bite systems

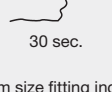
| Workshop machines for industrial assembly | | | | | |
|--|---|--|--|---|--|
| Procedure | Process | | Economic production qty. | Product | |
| | Equipment | Process/Time* | | EO progressive ring PSR/DPR | EO-2 |
| Pre-assembly using EOMAT ECO machine |  |  30 sec. | max. 50 assemblies per day | hydraulic service and on-site installation | ideal for workshop assembly, not ideal for serial production |
| Pre-assembly using EOMAT UNI machine |  |  15 sec. | max. 100 assemblies per day | ideal for workshop assembly, not suitable for LL series | ideal for workshop assembly, not suitable for LL series |
| Pre-assembly using EOMAT PRO machine |  |  8-12 sec. | min. 100 assemblies per day | ideal for workshop assembly and mass production | ideal for workshop assembly and mass production |
| Tube forming using EO-KARRYFORM machine |  |  20 sec. | max. 100 assemblies per day | not applicable | not applicable |
| Tube forming using EO2-FORM F3 machine |  |  20 sec. | max. 300 assemblies per day | not applicable | not applicable |
| Tube forming using EO2-FORM PRO22 |  |  6 sec. | min. 100 assemblies per day | not applicable | not applicable |
| Tube flaring using Parflare ECO |  |  30 sec. | max. 50 assemblies per day | not applicable | not applicable |
| Tube flaring using Parflange® 1025 machine |  |  45 sec. | max. 100 assemblies per day | not applicable | not applicable |
| Tube flaring using Parflange® 50 machine |  |  30 sec. | Basic: max. 500 assemblies per day PRO: 1200 assemblies per day | not applicable | not applicable |

*Average for total assembly time of medium size fitting including assembly check and final tightening

Selection of assembly process for bite systems

















| Manual assembly for field repair | | | | | |
|----------------------------------|-----------|---------------|-----------------------------|---|---|
| Procedure | Process | | Economic production qty. | Product | |
| | Equipment | Process/Time* | | EO progressive ring PSR/DPR | EO-2 |
| Direct in fitting | | 60 sec. | max. 10 assemblies per week | field repair only, not for efficient production and tubes larger than 22 mm OD, preferred method for PSR, not for stainless steel | field repair only, not for efficient production and tubes larger than 22 mm OD |
| Pre-assembly in vice | | 45 sec. | max. 10 assemblies per week | field repair only, not for efficient production | field repair only, not for efficient production |
| Flaring in vice | | 120 sec. | max. 10 flarings per week | not applicable | not applicable |
| Pre-assembly using HVM-B device | | 30 sec. | max. 50 assemblies per day | final assembly in fitting must be 1/2 turn, not for tubes larger than 15 mm OD, not for stainless steel | not applicable |
| Pre-assembly using EO-KARRYMAT | | 60 sec. | max. 20 assemblies per day | ideal for repair jobs and small on-site installations, not suitable for volume production | ideal for repair jobs and small on-site installations, not suitable for volume production |
| Tube flaring using KARRYFLARE | | 60 sec. | max. 20 flarings per day | not applicable | not applicable |

*Average for total assembly time of medium size fitting including assembly check and final tightening

E

Tube assembly

Selection of assembly process for tube forming systems

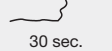
| Workshop machines for industrial assembly | | | | | |
|--|---|--|--|--|--|
| Process | | | Product | | |
| Procedure | Equipment | Process/Time* | EO2-FORM | Triple-Lok® | O-Lok® |
| Pre-assembly using EOMAT ECO machine |  |  30 sec. | not applicable | not applicable | not applicable |
| Pre-assembly using EOMAT UNI machine |  |  30 sec. | not applicable | suitable for workshop assembly, preferred process is Parflange® | not applicable |
| Pre-assembly using EOMAT PRO machine |  |  10 sec. | not applicable | not applicable | not applicable |
| Tube forming using EO-KARRYFORM machine |  |  20 sec. | ideal for repair jobs and small on-site installations, not recommended for mass production | not applicable | not applicable |
| Tube forming using EO2-FORM F3 machine |  |  40 sec. | ideal for workshop assembly and serial production | not applicable | not applicable |
| Tube forming with EO2-FORM PRO22 machine |  |  6 sec. | ideal for workshop assembly and serial production | not applicable | not applicable |
| Tube flaring using Parflare ECO machine |  |  30 sec. | not applicable | ideal for on-site installations, not recommended for mass production | not applicable |
| Tube flaring using Parflange® 1025 machine |  |  45 sec. | not applicable | ideal for workshop assembly, not recommended for mass production, not suitable for assembly of SS tubes over 25 mm | ideal for workshop assembly, not recommended for mass production, not suitable for assembly of SS tubes over 25 mm |
| Tube flaring using Parflange® 50 machine |  |  30 sec. | not applicable | ideal for workshop assembly and serial production | ideal for workshop assembly and serial production automatic sleeve feeder available for mass production |

*Average for total assembly time of medium size fitting including assembly check and final tightening

Selection of assembly process for tube forming systems

| Manual assembly for field repair | | | | | |
|---------------------------------------|-----------|---------------|--|--|--|
| Process | | | Product | | |
| Procedure | Equipment | Process/Time* | EO2-FORM | Triple-Lok® | O-Lok® |
| Direct in fitting | | 60 sec. | not possible, use EO-2 for field repair | not possible, use 1015 device or hand flaring tools for field repair | not possible, use braze sleeves or hose lines for field repair |
| Pre-assembly in vice | | 45 sec. | not possible, use EO-2 for field repair | not possible, use 1015 device or hand flaring tools for field repair | not possible, use braze sleeves or hose lines for field repair |
| Flaring in vice | | 120 sec. | not applicable | field repair only, not for efficient production, not for stainless steel tubes | not possible, use braze sleeves or hose lines for field repair |
| Pre-assembly using HVM-B device | | 30 sec. | not applicable | not applicable | not applicable |
| Pre-assembly using EO-KARRYMAT | | 60 sec. | not possible, use EO-2 for field repair | not applicable | not applicable |
| Tube flaring using KARRYFLARE | | 60 sec. | not possible, use EO-2 for field repair | ideal for repair jobs and small on-site installations, not suitable for industrial production | not applicable |

*Average for total assembly time of medium size fitting including assembly check and final tightening

Tube assembly

New EO assembly instructions for 30° final assembly

Traditional pre-assembly

- According to DIN 3859 T2
- Can be used optional as usual
- Machine preset
- Manual preset



- Machine presetting: Machine preset corresponding to 1¼ turn of nut

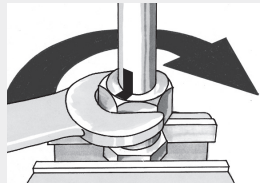

- Manual presetting: Tighten the nut by 1¼ turns

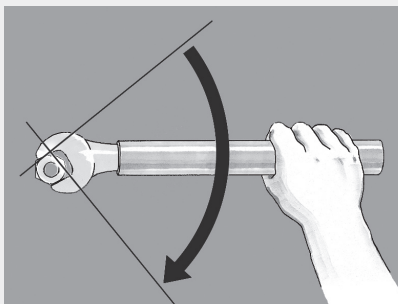

Final assembly
Before 90°
 1/4 turn
 after perceptible rise in force

Optimized EO pre-assembly

- Machine preset
- Manual preset



- Machine presetting: Machine preset corresponding to 1½ turn of nut

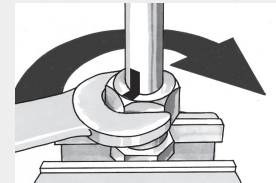

- Manual presetting: Tighten the nut by 1½ turns

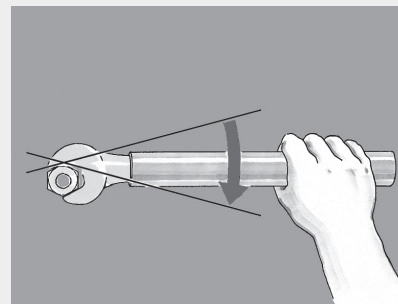

Final assembly
Now 30°
 1/12 turn
 after perceptible rise in force

EO progressive ring PSR/DPR

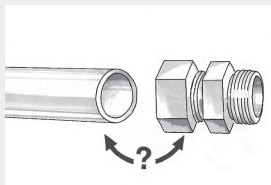

Material combinations

- Select suitable EO progressive ring fitting

| Tube material | EO-Fitting body | assembly instructions |
|---------------------------|----------------------------------|--|
| Steel | Steel (LL=D-Ring) | |
| Stainless Steel | Stainless Steel | Pre-assembly by machine or hardened tool required |
| Copper | Brass (D-Ring) | |
| Plastic e.g. Polyamide | Steel, Brass, Stainless Steel | Support sleeve E required Check assembly devices for suitability |
| Stainless Steel | Steel | Stainless Steel DPR must be used Pre-assembly by machine or hardened tool required |



Tube preparation

- Cut and deburr thoroughly
- Do not assemble under tension

Min. length straight tube ends

| Tube OD | Series L | | | | | | | | | |
|---------|----------|----|----|----|----|----|----|----|----|----|
| | 06 | 08 | 10 | 12 | 15 | 18 | 22 | 28 | 35 | 42 |
| L min | 39 | 39 | 42 | 42 | 45 | 49 | 53 | 53 | 60 | 60 |

| Tube OD | Series S | | | | | | | | | |
|---------|----------|----|----|----|----|----|----|----|----|----|
| | 06 | 08 | 10 | 12 | 14 | 16 | 20 | 25 | 30 | 38 |
| L min | 44 | 44 | 47 | 47 | 54 | 54 | 59 | 68 | 73 | 82 |

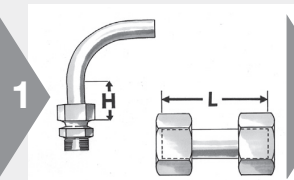

- Minimum lengths of straight tube-ends, H=2x nut length
- Use swivel union "GZ" instead of short tubes

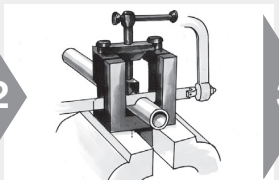

- Cut tube squarely
- max ±1° deviation
- ⚠ Do not use pipe cutters
- EO tube-cutting tool (AV) for manual cutting



- Remove internal and external burrs
- max. chamfer 0.3 mm x 45°
- Recommendation: In-Ex Tube Deburring Tool 226

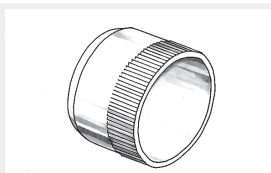

Support sleeves VH

- Support sleeve VH for thin wall or soft metal tubes (see chart)

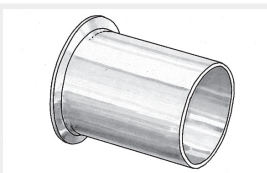

Tube insert E

- Support sleeve E for plastic tubes

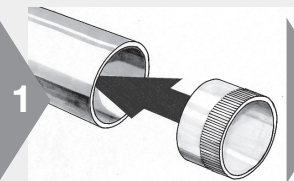

- Insert support sleeve like shown

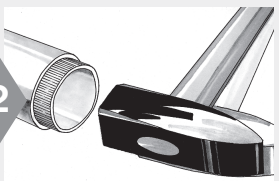

- Drive VH into tube-end

- Support sleeve required
- Support sleeve required for heavily loaded lines (vibrations)

VH selection chart for EO Progressive Ring

For steel tubes material ST 37.4 and for stainless steel tubes material 1.4571 and 1.4541

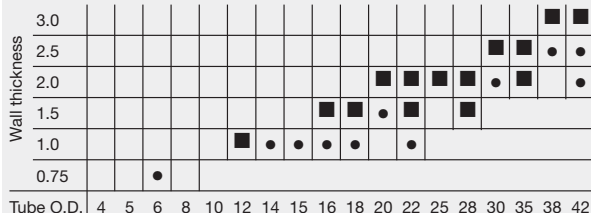

For soft metal tubes (e. g. copper)

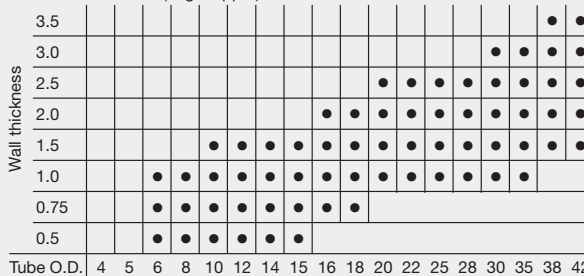

Tube assembly

EO progressive ring PSR/DPR

EOMAT PRO

EOMAT UNI

EO-KARRYMAT

100% Pre-assembly with EOMAT/EO-KARRYMAT

- Preferred method
- Most efficient method
- ⚠ HVMB-device not suitable for 100% assembly of PSR fittings

| Automatik | |
|--------------|---------|
| 12-L PSR/DPR | |
| 1 Counter | 123 000 |
| Lifetime MOK | 123456 |

2

Ok?

3

4

- EOMAT ECO/UNI and EO-KARRYMAT: Adjustment according to pressure chart on machine (PSR/DPR) Reduction of preset pressures for tube materials softer than steel and stainless steel required
- EOMAT PRO: Automatic tool recognition
- Non-EOMAT-machines: Check suitability
- ⚠ Use genuine Parker assembly cone "MOK"
 - Control (see checking instructions)
 - Clean and lubricate assembly cone and thread regularly
 - For EOMAT PRO use assembly cone "MOK...PRO" with transponder chip
- Insert proper tools
- Clean and lubricate assembly cones regularly
- EO-KARRYMAT: Close valve on handpump
- 2-piece backing plates for 35-L and 42-L
- Slide nut and progressive ring as shown onto the end of the tube

5

6

- Place tube with progressive ring and nut into the die
- Press tube-end firmly into the assembly cone
- Hold tube firmly
- EOMAT: Press and hold start button
- Use support and foot switch for long tubes
- EO-KARRYMAT: Operate handpump until assembly pressure is reached
- Safe holding of to be processed tubes
- While holding and setting down, do not hold onto the lifting zone of the cylinder

7

8

9

10

- After completion of pre-assembly, remove the tube for assembly check
- EO-KARRYMAT: Open valve on handpump
- ⚠ Check to make sure that a visible collar covers the front of the first cutting edge
 - It does not matter if the ring can be rotated on the tube-end
- Use distance gauge AKL for checking in mass production
- Assemble fitting until wrench-tight (without spanner extension) Mark position of nut
- ⚠ The body must be held rigid

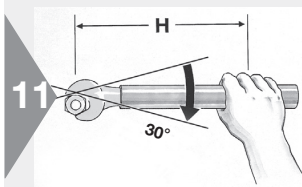

Spanner length

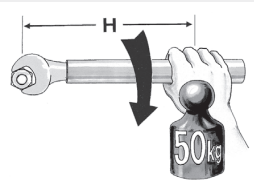

- ⚠ Then tighten fitting firmly by 30° (½ flat)
- ⚠ Recommended to use spanner extension for sizes over 20 mm O.D. (see chart)
- Assembly torques are available on request

| Size | Spanner length H [mm] |
|-----------|--------------------------|
| 22-L | 400 |
| 28-L 20-S | 500 |
| 35-L 25-S | 800 |
| 42-L 30-S | 1000 |
| 38-S | 1200 |

E

Tube assembly

EO progressive ring PSR/DPR

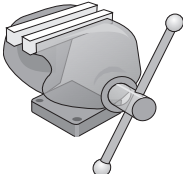

Pre-assembly with hardened tool VOMO

- Reliable method for repair jobs
- Only economic for assembly of small quantities

⚠️ Stainless steel EO progressive rings must be pre-assembled using a hardened tool (VOMO)

- For tubes over 25 mm, EO-KARRYMAT/EOMAT is recommended

1

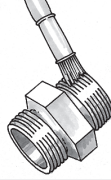

2

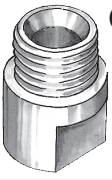

Ok?

3

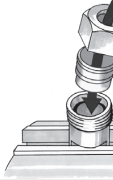

4

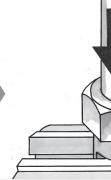

⚠️ For stainless steel assembly threads must be lubricated

- Use EO-NIROMONT special high-performance lubricant for stainless steel fittings

- Control (see checking instructions)
- Cones of pre-assembly bodies must be checked regularly (after 50 pre-assemblies) with cone templates (KONU)
- Clean and lubricate assembly cone and thread regularly

- Use pre-assembly tool VOMO
- Fitting body may be used one time only (not for stainless steel)
- Screw on nut until finger-tight

⚠️ Press tube-end firmly into the assembly cone

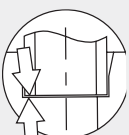

5



6

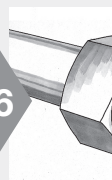

7

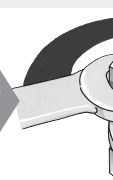

8

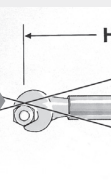

⚠️ Mark position of the nut

- Tighten the nut by 1½ turns

⚠️ Recommended to use spanner extension for sizes over 20 mm O.D.

Assembly check:

- Loosen nut
- Check to make sure that a visible collar covers the front of the first cutting edge
- It does not matter if the ring can be rotated on the tube-end

- Assemble fitting until wrench-tight (without spanner extension)
- Mark position of nut
- The body must be held rigid

⚠️ Then tighten fitting firmly by 30° (½ flat)

⚠️ Recommended to use spanner extension for sizes over 20 mm O.D. (see chart)

- Assembly torques are available on request

Spanner length

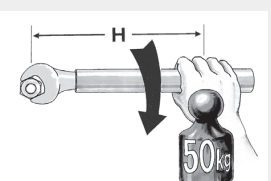

| Size | Spanner length H [mm] |
|-----------|-----------------------|
| 22-L | 400 |
| 28-L 20-S | 500 |
| 35-L 25-S | 800 |
| 42-L 30-S | 1000 |
| 38-S | 1200 |

EO progressive ring PSR/DPR

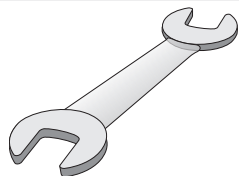

Direct assembly

- Simple procedure for single assemblies of small dimensions
- Not economic for series assembly
- ⚠ Tubes \varnothing 30, 35, 38 and 42 mm must be pre-assembled in vice
- ⚠ Stainless steel connections have to be assembled using pre-assembly tool (VOMO)
- ⚠ Properly cleaned studs ("BE") have to be assembled with pre-assembly tools

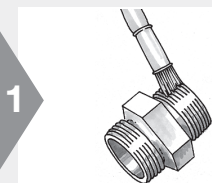

- 1
- ⚠ Lubrication of threads will reduce wear and assembly forces
 - ⚠ Threads on stainless steel fittings must be lubricated
 - ⚠ Use EO-NIROMONT special high-performance lubricant for stainless steel fittings

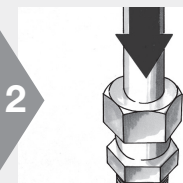

- 2
- Screw on nut until finger-tight
 - ⚠ Press tube-end firmly into fitting body

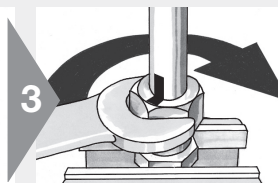

- 3
- Mark position of the nut
 - Tighten the nut by 1½ turns
 - ⚠ Recommended to use spanner extension for sizes over 20 mm O.D. (see chart)
 - Fitting body may be used one time only

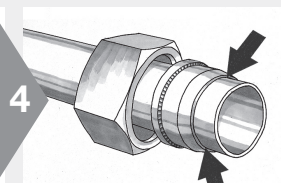

- 4
- Assembly check:**
- Loosen nut
 - ⚠ Check to make sure that a visible collar covers the front of the first cutting edge
 - It does not matter if the ring can be rotated on the tube-end

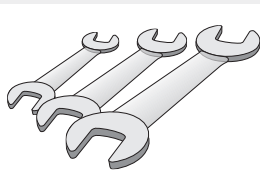

Repeated assembly

- Each time the tube-end has been disconnected, the fitting must be properly tightened again
- ⚠ EO progressive rings cannot be replaced, once assembled

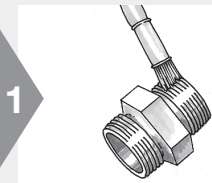

- 1
- ⚠ Threads on stainless steel fittings must be lubricated
 - ⚠ Use EO-NIROMONT special high-performance lubricant for stainless steel fittings

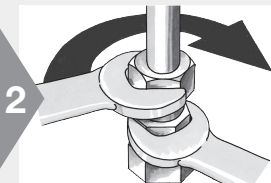

- 2
- When repeating the assembly the nut must be tightened with a wrench in the primary original position.
 - The body must be held rigid
 - ⚠ Recommended to use spanner extension for sizes over 20 mm O.D. (see chart)

Spanner length

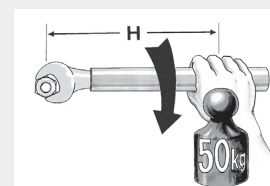

| Size | Spanner length H [mm] |
|-----------|-----------------------|
| 22-L | 400 |
| 28-L 20-S | 500 |
| 35-L 25-S | 800 |
| 42-L 30-S | 1000 |
| 38-S | 1200 |

Tube assembly

EO-2 assembly instructions

Tube preparation

- Cut and deburr thoroughly
- Do not assemble under tension

1

- Cut tube squarely
- max ± 1° deviation
- ⚠ Do not use pipe cutters
- EO tube-cutting tool (AV)

2

- Don't deform tube end at cutting or bending
- Marks or scratches can result in leakage
- Thin wall and soft tubes are very sensitive

3

- Remove internal and external burrs
- max. chamfer 0.3 mm × 45°
- Seal can be damaged by large burrs

Material combinations

- Select suitable FM-type

| | Steel tube | Stainless Steel tube | Plastic tube |
|-------------------------|------------|----------------------|--------------|
| Steel fitting | FM...CF | FM...SSA | FM...CF+E |
| Stainless Steel fitting | — | FM...71 | FM...71+E |

Tube insert E

- Tube insert E for plastic tubes

Support sleeves VH

- Support sleeve VH for thin wall or soft metal tubes

1

- Support-sleeve selection: see instruction shipped with product

2

- Drive VH into tube-end

Use of support sleeves "VH" with EO-2 fittings

| Tube O.D. | 0.5 | 0.75 | 1 | 1.5 | 2 | 2.5 | 3 | 3.5 | 4 |
|-----------|-----|------|---|-----|---|-----|---|-----|---|
| 4 | | | | | | | | | |
| 6 | | | | | | | | | |
| 8 | | | | | | | | | |
| 10 | | | | | | | | | |
| 12 | | | | | | | | | |
| 14 | | | | | | | | | |
| 15 | | | | | | | | | |
| 16 | | | | | | | | | |
| 18 | | | | | | | | | |
| 20 | | | | | | | | | |
| 22 | | | | | | | | | |
| 25 | | | | | | | | | |
| 28 | | | | | | | | | |
| 30 | | | | | | | | | |
| 35 | | | | | | | | | |
| 38 | | | | | | | | | |
| 42 | | | | | | | | | |

Functional test required for other materials or dimensions not specified. Support sleeve VH not required for EO-2 steel (FM/CF) and steel tube. For EO-2 stainless steel (FM/71) and stainless steel tube, a functional test is required. Support sleeve VH **not required** for EO-2 and steel tube. Support sleeve VH **not required** for EO-2/71 or EO-2/SSA and stainless steel tube.

EO-2 assembly instructions

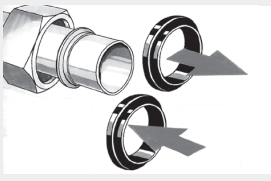

Replacement of sealing ring/Repeated assembly

- Sealing ring DOZ can be changed separately

Spanner length

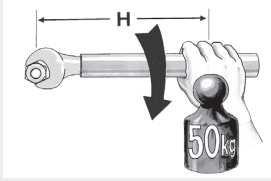

1

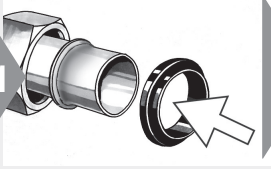

2

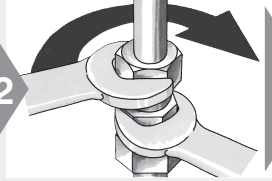

3

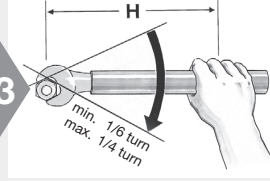

- After disassembly, sealing ring can be pulled off the tube-end
- Check for damage and replace if necessary
- Abrasion on outer rubber parts does not affect performance

- Assemble fitting until wrench-tight (without spanner extension) **⚠** The body must be held rigid

- Then tighten fitting firmly by min 1/6 (max 1/4) turn (1 to 1 1/2 flats) **⚠**
- Recommended to use spanner extension for sizes over 20 mm O.D. (see chart) **⚠**

| Size | Spanner length H [mm] |
|-----------|-----------------------|
| 22-L | 400 |
| 28-L 20-S | 500 |
| 35-L 25-S | 800 |
| 42-L 30-S | 1000 |
| 38-S | 1200 |

E

Tube assembly

EO-2 assembly instructions



EOMAT PRO



EOMAT UNI

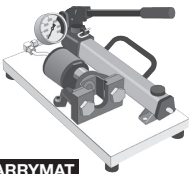

EO-KARRYMAT

Assembly with EOMAT/EO-KARRYMAT

- Preferred method
- Most efficient method
- HVM-B device is not suitable for EO-2

1

Automatik

12-L EO-2

Counter 123

2

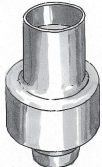

Ok?

3

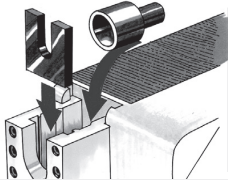

4

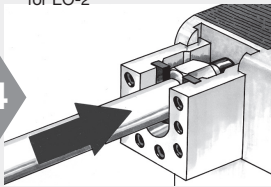



- EOMAT ECO/UNI: Adjustment according to pressure on machine (see instructions shipped with product box)
- EOMAT PRO: Automatic tool recognition
- EO-KARRYMAT: Refer to chart on machine
- Non-EOMAT-machines: check suitability

- ⚠ Use genuine Parker assembly cone "MOKEO2"
- Check according to MOK checking instructions
- For EOMAT PRO use assembly cone "MOK...PRO" with transponder chip. Advantages: easy and safe assembly

- Insert proper tools
- 2-piece tube backing plates for 35-L and 42-L
- EO-KARRYMAT: Close valve on handpump

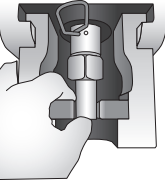
- Place tube with functional nut into the die
- Press tube-end firmly into the assembly cone
- Hold back nut for easy tube insertion



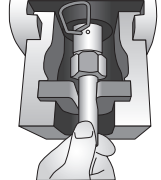

- Safe holding of to be processed tubes
- While holding and setting down, do no hold onto the lifting zone of the cylinder

5

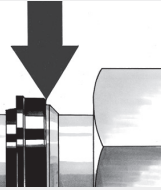

6

7

8

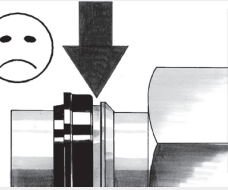

- Hold tube firmly
- EOMAT: Press and hold start button
- Use support and foot switch for long tubes
- EO-KARRYMAT: Operate handpump until assembly pressure is reached. Then open valve on handpump

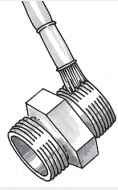
Assembly check:

- Gap between sealing ring and retaining ring must be closed
- A little relaxation (approx. 0.2 mm) is allowed

- ⚠ **Gap not closed:** Check all components, tube, machine, tools and pressure setting
- ⚠ Repeat assembly with increased pressure if necessary

- ⚠ Threads of stainless steel fittings must be lubricated
- ⚠ Use EO-NIROMONT special high-performance lubricant for stainless steel fittings



9

- Assemble fitting until wrench-tight (without spanner extension)

⚠ The body must be held rigid



10

min. 1/6 turn
max. 1/4 turn

- ⚠ Then tighten fitting firmly by min 1/6 (max. 1/4) turn (1 to 1 1/2 flats)
- ⚠ Recommended to use spanner extension for sizes over 20 mm O.D. (see chart)

Spanner length



| Size | Spanner length H [mm] |
|-----------|-----------------------|
| 22-L | 400 |
| 28-L 20-S | 500 |
| 35-L 25-S | 800 |
| 42-L 30-S | 1000 |
| 38-S | 1200 |

E

Tube assembly

EO-2 assembly instructions

Assembly in vice

- Reliable method
- Only economic for assembly of small quantities

1

2

3

4

1 Threads on stainless steel fittings must be lubricated
 Use EO-NIROMONT special high-performance lubricant for stainless steel fittings

2 Check according to VOMO (checking instructions)
 Use pre-assembly tool VOMO
 Fitting body may be used one time only and components must stay together

3 Push functional nut onto tube-end
 Advantage: Easy tube insertion, particularly large dimensions

4 Press tube-end firmly into the assembly cone
 Screw on nut until finger-tight

5

6

7

8

5 Tighten until sharp increase of resistance (approx. 1 to 1½ turns)
 Recommended to use spanner extension for sizes over 20 mm O.D. (see chart)

6 **Assembly check:**
 Gap between sealing ring and retaining ring must be closed
 A little relaxation (approx. 0.2 mm) is allowed

7 **Gap not closed:**
 Repeat assembly with increased torque. Check gap again.

8 Assemble fitting until wrench-tight (without spanner extension)
 The body must be held rigid

9

min. 1/6 turn
max. 1/4 turn

Then tighten fitting firmly by min 1/6 (max. 1/4) turn (1 to 1½ flats)
 Recommended to use spanner extension for sizes over 20 mm O.D. (see chart)

Spanner length

| Size | Spanner length H [mm] |
|-----------|-----------------------|
| 22-L | 400 |
| 28-L 20-S | 500 |
| 35-L 25-S | 800 |
| 42-L 30-S | 1000 |
| 38-S | 1200 |

EO-2 assembly instructions

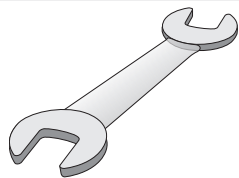
Direct assembly

- Simple procedure for single assemblies of small dimensions
- Not economic for series assemblies
- ⚠ Tubes \varnothing 30, 35, 38 and 42 mm must be pre-assembled in vice

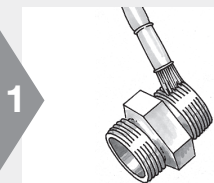

- 1
- ⚠ Threads on stainless steel fittings must be lubricated
 - ⚠ EO-NIROMONT is a special high-performance lubricant for stainless steel fittings

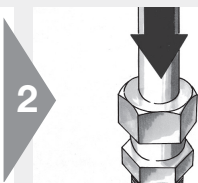

- 2
- ⚠ Press tube-end firmly into the assembly cone
 - Push back nut for easy tube insertion

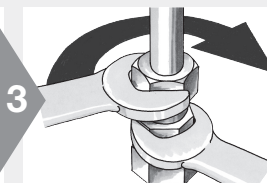

- 3
- Tighten until sharp increase of resistance (approx. 1 to 1½ turns)
 - Recommended to use spanner extension for sizes over 20 mm O.D. (see chart)

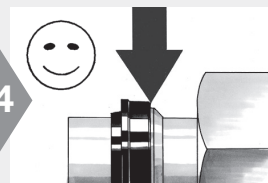

- 4
- Assembly check:**
- Gap between sealing ring and retaining ring must be closed
 - A little relaxation (approx. 0.2 mm) is allowed

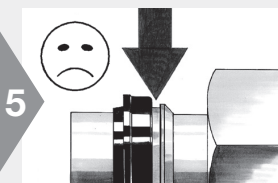

- 5
- ⚠ **Gap not closed:** Check all components including tube

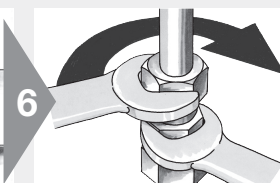

- 6
- Assemble fitting until wrench-tight (without spanner extension)
 - ⚠ The body must be held rigid

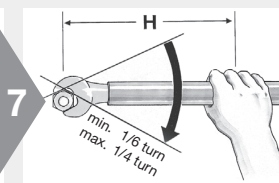

- 7
- ⚠ Then tighten fitting firmly by min 1/8 (max 1/4) turn (1 to 1½ flats)
 - ⚠ Recommended to use spanner extension for sizes over 20 mm O.D. (see chart)

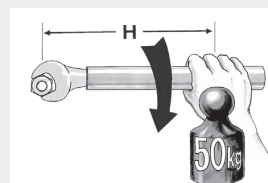
Spanner length

| Size | Spanner length H [mm] |
|-----------|-----------------------|
| 22-L | 400 |
| 28-L 20-S | 500 |
| 35-L 25-S | 800 |
| 42-L 30-S | 1000 |
| 38-S | 1200 |

Tube assembly

Checking instructions for EO assembly tools

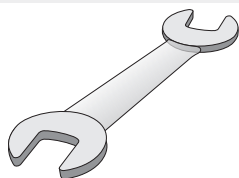
**VOMO tools for manual pre-assembly in vice
MOK for use in EO assembly machines**

- ⚠ Use of damaged, worn or non-suitable tooling may result in fitting failure or machine damage
- ⚠ Tools must be checked regularly, at least after 50 assemblies
- ⚠ Worn tools must be replaced ⚠ Use only genuine Parker tools
- ⚠ Tools must be kept clean and lubricated

1

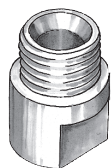

- Clean cone surface for checking

2

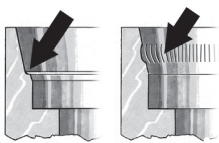

- Visual checks:
Cone must be free of wear, damage or cracks

3



- Check for deformation of geometry
- ⚠ Special cone template KONU must be used
- KONU cone templates are precision measuring devices and must be handled accordingly

4

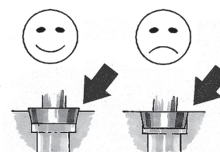

- Check contour:
The rear of the template must protrude slightly above the top face of the cone or may be flush

5

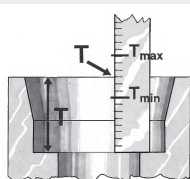

- Check insertion depth
- ⚠ Deviations from the insertion depth can cause leakages

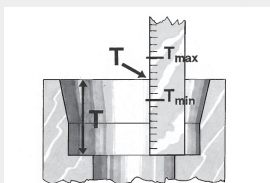

- Insertion depth T

Table: Tool for presetting tool (MOK and VOMO)

| Type | T _{min} | T _{max} | Typ | T _{min} | T _{max} |
|------|------------------|------------------|------|------------------|------------------|
| 6-L | 6.95 | 7.05 | 6-S | 6.95 | 7.05 |
| 8-L | 6.95 | 7.05 | 8-S | 6.95 | 7.05 |
| 10-L | 6.95 | 7.05 | 10-S | 7.45 | 7.55 |
| 12-L | 6.95 | 7.05 | 12-S | 7.45 | 7.55 |
| 15-L | 6.95 | 7.05 | 14-S | 7.95 | 8.05 |
| 18-L | 7.45 | 7.55 | 16-S | 8.45 | 8.55 |
| 22-L | 7.45 | 7.55 | 20-S | 10.45 | 10.55 |
| 28-L | 7.45 | 7.55 | 25-S | 11.95 | 12.05 |
| 35-L | 10.45 | 10.55 | 30-S | 13.45 | 13.55 |
| 42-L | 10.95 | 11.05 | 38-S | 15.95 | 16.05 |

E02-FORM assembly instructions

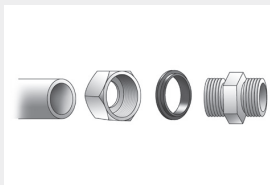

Material combinations

- Select suitable materials
- See catalogue for exact tube specifications

Material selection chart

| Tube material | Fitting and nut material | Sealing material |
|-----------------|--------------------------|-------------------------|
| Steel | Steel | Steel/NBR or Steel/FKM |
| Stainless Steel | Stainless Steel | Stainless/Steel FKM/NBR |
| Stainless Steel | Steel | Steel/NBR or Steel/FKM |

E

Tube preparation

- Cut and deburr thoroughly
- Cut and bend tubes exactly

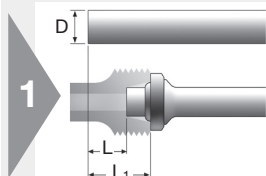

- Take extra length into account (see tube preparation chart)

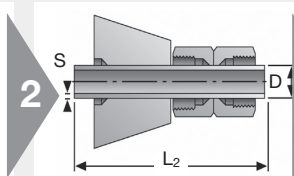

- Minimum lengths L_2 of straight tubes (see chart)

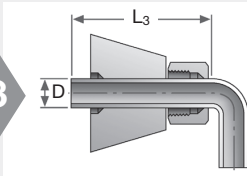

- Minimum lengths L_3 of straight tube-ends before bend (see chart)

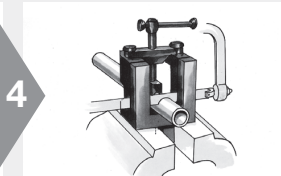

- Cut tube squarely
- max $\pm 1^\circ$ deviation
- ⚠ Do not use pipe cutters
- EO tube-cutting tool (AV) for manual cutting

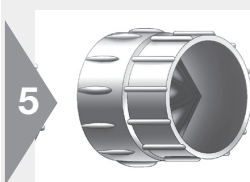

- Remove internal and external burrs
- max. chamfer 0.3 mm \times 45°
- Recommendation: In-Ex Tube Deburring Tool 226

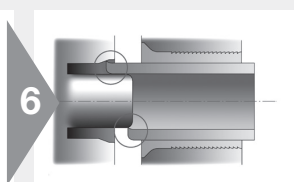

- Chips, dirt, internal or external burrs and paint prevent correct tube insertion
- ⚠ Dirty tubes result in worn-out or damaged tools

Tube assembly

EO2-FORM assembly instructions

Tube preparation chart – Series L

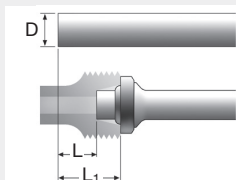

- Extra length

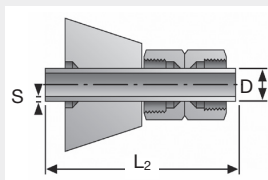

- Minimum tube length

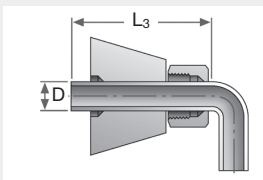

- Minimum straight length before bend

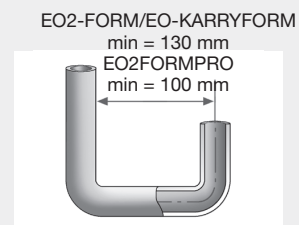

- Minimum clearance of U-shape bends

| Tube-OD Series | S Wall-thickness | L Steel ± 0.5 | L Stainless steel ± 0.5 | L1 Steel | L1 Stainless Steel | L2 | L3 |
|----------------|------------------|---------------|-------------------------|----------|--------------------|-----|-----|
| 6L | 1.0 | 6.0 | 6.0 | 13.0 | 13.0 | 90 | 63 |
| | 1.5 | 6.0 | 6.0 | 13.0 | 13.0 | | |
| | 2.0 | 5.5 | | 12.5 | | | |
| 8L | 1.0 | 5.5 | 5.5 | 12.5 | 12.5 | 92 | 65 |
| | 1.5 | 5.5 | 5.5 | 12.5 | 12.5 | | |
| | 2.0 | 5.0 | | 12.0 | | | |
| | 2.5 | 4.5 | | 11.5 | | | |
| 10L | 1.0 | 5.5 | 5.5 | 12.5 | 12.5 | 95 | 68 |
| | 1.5 | 5.0 | 6.0 | 12.0 | 13.0 | | |
| | 2.0 | 5.0 | 6.0 | 12.0 | 13.0 | | |
| 12L | 1.0 | 4.5 | 5.0 | 11.5 | 12.0 | 95 | 70 |
| | 1.5 | 5.0 | 5.5 | 12.0 | 12.5 | | |
| | 2.0 | 5.0 | 5.5 | 12.0 | 12.5 | | |
| 15L | 1.0 | 5.0 | 6.5 | 12.0 | 13.5 | 102 | 75 |
| | 1.5 | 5.0 | 6.5 | 12.0 | 13.5 | | |
| | 2.0 | 5.0 | 6.0 | 12.0 | 13.0 | | |
| | 2.5 | 5.0 | | 12.0 | | | |
| 18L | 1.5 | 5.5 | 6.0 | 13.0 | 13.5 | 110 | 80 |
| | 2.0 | 5.5 | 6.5 | 13.0 | 14.0 | | |
| | 2.5 | 6.0 | | 14.0 | | | |
| | 3.0 | 6.0 | 6.5 | 14.0 | 14.0 | | |
| 22L | 1.5 | 6.0 | 6.0 | 13.5 | 13.5 | 120 | 90 |
| | 2.0 | 6.5 | 7.0 | 14.0 | 14.5 | | |
| | 2.5 | 6.5 | 7.0 | 14.0 | 14.5 | | |
| | 3.0 | 7.0 | 7.5 | 14.5 | 15.0 | | |
| 28L | 1.5 | 5.5 | 6.0 | 13.0 | 13.5 | 140 | 98 |
| | 2.0 | 5.5 | 7.0 | 13.0 | 14.5 | | |
| | 2.5 | 7.0 | 7.5 | 14.5 | 15.0 | | |
| | 3.0 | 7.0 | | 14.5 | | | |
| | 4.0 | 6.5 | | 14.0 | | | |
| 35L | 2.0 | 7.0 | 8.5 | 17.5 | 19.0 | 170 | 115 |
| | 2.5 | 7.5 | 9.5 | 18.0 | 20.0 | | |
| | 3.0 | 8.5 | 10.5 | 19.0 | 21.0 | | |
| 42L | 2.0 | 7.5 | 7.5 | 18.5 | 18.5 | 190 | 125 |
| | 3.0 | 9.0 | 10.5 | 20.0 | 21.5 | | |
| | 4.0 | 9.0 | 10.5 | 20.0 | 21.5 | | |
| | 5.0 | 10.0 | | 21.0 | | | |

EO2-FORM assembly instructions

Tube preparation chart – Series S

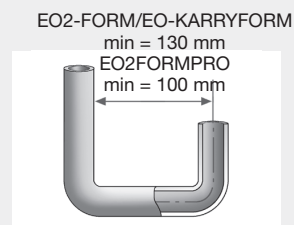
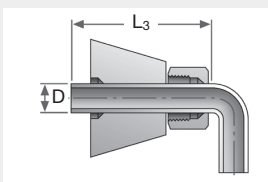
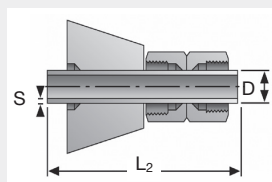
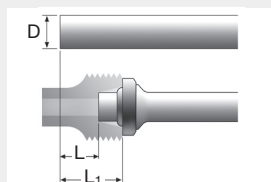

• Extra length

• Minimum tube length

• Minimum straight length before bend

• Minimum clearance of U-shape bends

| Tube-OD Series | S Wall-thickness | L Steel ± 0.5 | L Stainless Steel ± 0.5 | L ₁ Steel | L ₁ Stainless Steel | L ₂ | L ₃ |
|----------------|------------------|-------------------|-----------------------------|----------------------|--------------------------------|----------------|----------------|
| 6S | 1.0 | 6.0 | 6.0 | 13.0 | 13.0 | 92 | 65 |
| | 1.5 | 6.0 | 6.0 | 13.0 | 13.0 | | |
| | 2.0 | 5.5 | | 12.5 | | | |
| 8S | 1.0 | 5.5 | 5.5 | 12.5 | 12.5 | 95 | 68 |
| | 1.5 | 5.5 | 5.5 | 12.5 | 12.5 | | |
| | 2.0 | 5.0 | | 12.0 | | | |
| 10S | 1.5 | 5.0 | 6.0 | 12.5 | 13.5 | 100 | 70 |
| | 2.0 | 5.0 | 6.0 | 12.5 | 13.5 | | |
| | 3.0 | 4.5 | | 12.0 | | | |
| 12S | 1.5 | 5.0 | 6.5 | 12.5 | 14.0 | 100 | 72 |
| | 2.0 | 5.0 | 6.0 | 12.5 | 13.5 | | |
| | 2.5 | 5.0 | 6.0 | 12.5 | 13.5 | | |
| | 3.0 | 4.5 | 4.5 | 12.0 | 12.0 | | |
| 16S | 1.5 | 5.0 | 6.5 | 13.5 | 15.0 | 110 | 80 |
| | 2.0 | 5.5 | 6.5 | 14.0 | 15.0 | | |
| | 2.5 | 5.5 | 6.5 | 14.0 | 15.0 | | |
| | 3.0 | 5.0 | 6.5 | 13.5 | 15.0 | | |
| | 4.0 | | 6.0 | | 14.5 | | |
| 20S | 2.0 | 7.0 | 7.0 | 17.5 | 18.5 | 135 | 98 |
| | 2.5 | 7.0 | 8.0 | 17.5 | 18.5 | | |
| | 3.0 | 7.0 | 8.0 | 17.5 | 18.5 | | |
| | 3.5 | 7.0 | | 17.5 | | | |
| 25S | 2.0 | 8.5 | 8.5 | 20.5 | 20.5 | 155 | 112 |
| | 2.5 | 8.5 | 9.0 | 20.5 | 21.0 | | |
| | 3.0 | 8.0 | 9.5 | 20.0 | 21.5 | | |
| | 4.0 | 8.5 | 9.5 | 20.5 | 21.5 | | |
| 30S | 2.0 | 8.0 | 8.5 | 21.5 | 22.0 | 165 | 122 |
| | 2.5 | 8.5 | 9.0 | 22.0 | 22.5 | | |
| | 3.0 | 8.5 | 9.5 | 22.0 | 23.0 | | |
| | 4.0 | 9.5 | 10.0 | 23.0 | 23.5 | | |
| | 5.0 | 8.5 | 9.0 | 22.0 | 22.5 | | |
| 38S | 2.5 | 7.5 | 9.0 | 21.0 | 25.0 | 190 | 135 |
| | 3.0 | 10.0 | 9.5 | 26.0 | 25.5 | | |
| | 3.5 | 10.0 | 11.5 | 26.0 | 27.5 | | |
| | 4.0 | 10.0 | 11.0 | 26.0 | 27.0 | | |
| | 5.0 | 11.0 | 12.5 | 27.0 | 28.5 | | |
| | 6.0 | 11.5 | 12.5 | 27.5 | 28.5 | | |
| | 7.0 | 11.5 | 12.5 | 27.5 | 28.5 | | |

Tube assembly

E02-FORM assembly instructions

Tube forming with E02-FORM F3/EO-KARRYFORM

- Reliable forming method
- Reliable process



1

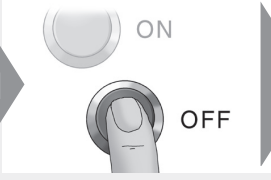

- ⚠ Change tool only when drive switched off (button OFF)
- ⚠ Obey safety instructions
- ⚠ Do not operate machine without tooling

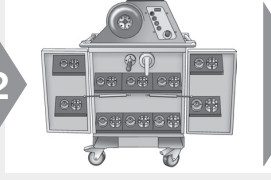

2

- Open doors to access tools and handling devices
- Tool handling devices are stored in middle on top

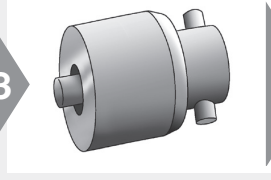

3

- Select suitable forming pin according to tube material, outer diameter and wall thickness

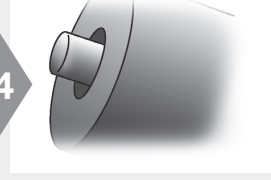

4

- Check forming pin for dirt, wear and damage



5

- Use magnetic holder to insert forming pin
- Turn clockwise to lock bayonet fixture

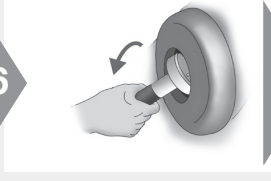

6

- Tilt magneto holder to remove handle

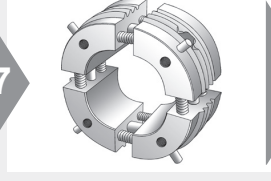

7

- Select suitable clamping die set according to tube outer diameter and material
- ⚠ Keep stainless tube clamping dies separate from other tube materials to prevent contact corrosion

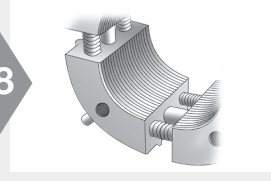

8

- Check clamping dies for dirt, wear and damage
- Use wire-brush to remove metal particles from grip surface

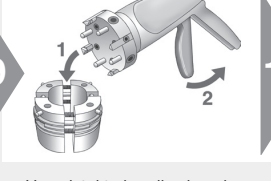

9

- Use pistol to handle clamping die set
- Pull and hold handle to grab die set

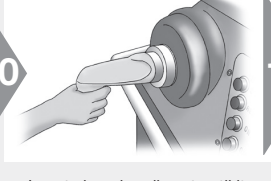

10

- Insert clamping die set until it bottoms up (twist pistol for easy insertion)
- Release handle to fix die set
- ⚠ Never operate machine while pistol is inserted

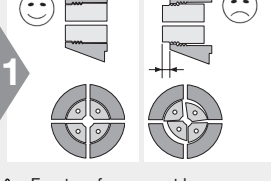

11

- ⚠ Front surfaces must be completely flat
- ⚠ Die segments must fit without gaps



12

- ⚠ Wear safety glasses

E02-FORM assembly instructions

E

- Switch on drive (button ON)
- Each time the drive is switched on, the reset button (RESET) must be pressed first
- The automatic tool recognition is initiated
- ⚠ Clamping dies will close, reset button (RESET) must be held until it lights up
- Lighten of reset button (RESET) indicates "ready to start"

- ⚠ Make sure tube-end is free of burrs, chips and dirt
Lubricate inside and outside of tube-end
- Use EO-NIROMONT for best performance

- Insert tube-end with nut into open tool until it firmly touches the stop at the end
- ⚠ Press tube-end firmly into the tube stop
- ⚠ Do not turn tube-end anti-clockwise to prevent unlocking forming-pin

- Press and hold start button (Ⓜ START) until tube is clamped
- Instead of start-button (Ⓜ START), footswitch can be used
- ⚠ Hold tube firmly until clamping dies are closed
- Use support for long tubes
- ⚠ Do not reach into tool area while machine is working

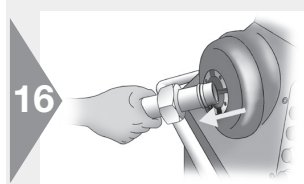

- Tube can be taken out after the clamping dies are open
- Reset button (RESET) lights up and the machine is ready for the next operation
- Check tools regularly (approx. 50 assemblies) for dirt and wear
- Remove tools for cleaning
- Clean clamping dies with wire brush
- Clean forming die using compressed air
- Replace worn-out tooling

Tube assembly

EO2-FORM assembly instructions

Assembly check

- Check assembly result
- ⚠ Incorrect assemblies must be scrapped

- Sealing surface (arrow) must be free of scratches and damage

- Check contour: Contact surface for sealing ring (arrow) must be flat, at right angle to tube

- Check outer diameter \varnothing ... (see chart)
- ⚠ Incorrect tube-ends must be scrapped. Tools must be cleaned and checked

Tube OD check

| Tube \varnothing -Series | min \varnothing [mm] | max \varnothing [mm] |
|----------------------------|------------------------|------------------------|
| 6-L/S | 8.3 | 10.3 |
| 8-L/S | 10.3 | 12.3 |
| 10-L | 12.5 | 14.3 |
| 12-L | 14.5 | 16.3 |
| 15-L | 18.0 | 20.3 |
| 18-L | 21.0 | 24.0 |
| 22-L | 25.5 | 27.8 |
| 28-L | 31.5 | 33.8 |
| 35-L | 39.0 | 42.5 |
| 42-L | 45.5 | 49.5 |
| 10-S | 13.0 | 15.5 |
| 12-S | 15.0 | 17.5 |
| 14-S | 17.5 | 19.5 |
| 16-S | 19.5 | 21.5 |
| 20-S | 24.0 | 27.5 |
| 25-S | 29.5 | 34.0 |
| 30-S | 34.5 | 39.0 |
| 38-S | 42.5* | 47.0 |

* \varnothing 42.0 mm successfully tested with stainless steel tubes

Installation

- Place sealing ring (DOZ) onto tube-end

- Threads of stainless steel fittings must be lubricated
- EO-NIROMONT is a special high-performance lubricant for stainless steel fittings

- Tube must fit without tension
- Assemble fitting until wrench-tight (without spanner extension)
- ⚠ The body must be held rigid

- ⚠ Then tighten fitting firmly by 1/6 turn (1 flat)
- ⚠ Recommended to use spanner extension for sizes over 20 mm O.D. (see chart)
- ⚠ Incorrect assembly reduces performance and reliability of the connection

Spanner length

| Size | Spanner length H [mm] |
|-----------|-----------------------|
| 22-L | 400 |
| 28-L 20-S | 500 |
| 35-L 25-S | 800 |
| 42-L 30-S | 1000 |
| 38-S | 1200 |

Checking instructions for EO2-FORM tools



Forming pin and clamping dies for EO2-FORM machine

- ⚠ Use of damaged, worn or non-suitable tooling may result in fitting failure and damage of machine
- ⚠ Tools must be checked regularly, at least after 50 assemblies
- ⚠ Worn tools must be replaced
- ⚠ Use only genuine Parker tools
- ⚠ Tools must always be kept clean and lubricated

1

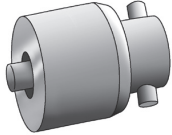

2

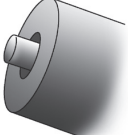

3

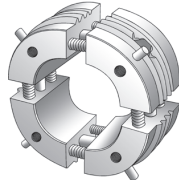

4

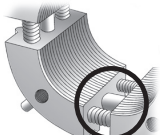

- Clean forming pin for checking
- Do not disassemble

- Visual check: Surface must be free of wear and damage
- Use air blowgun to remove chips and dirt

- Clean clamping pin for checking
- Do not disassemble
- Pins must not be loose or damaged

- Visual check: Grip surface must be clean and free of wear
- Use wire-brush to remove metal particles from grip surface
- Check springs and connection bolts

E

Tube assembly

Weld fitting



Weld fitting assembly

- EO weld nipple and weld fitting

⚠ Use weldable material

⚠ Depending on application or project specification, special requirements may apply for: Tube preparation, welding process, operator qualification, inspection of welding connection and surface finish



Tube preparation

- Cut and deburr thoroughly
- Do not assemble under tension

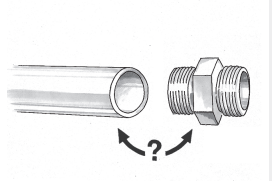

Material combinations

- Select suitable tube material

| Fitting material | Tube specification |
|------------------|--------------------------|
| Steel | Weldable Steel |
| Stainless Steel | Weldable Stainless Steel |

1

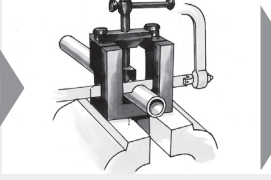

- Cut tube squarely
- max $\pm 1^\circ$ deviation

⚠ Do not use pipe cutters

- EO tube-cutting tool (AV) for manual cutting

2

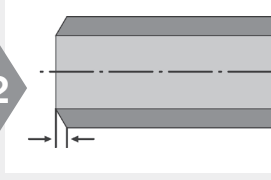

- Bevel tube-end similar to weld nipple bevel

Assembly

3

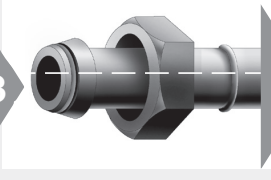

- Slide nut onto tube-end
- Weld fitting onto tube-end
- Fitting and tube must be aligned

⚠ Remove all elastomeric seals before welding

4



- Clean weld
- Calibrate inner diameter
- Check welding quality
- Surface protection if necessary

5

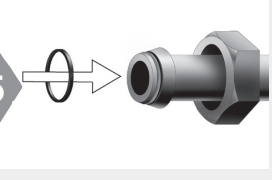

- Assemble O-ring
- Lubricate O-ring for easy assembly
- Avoid damage or twisting of O-ring

6

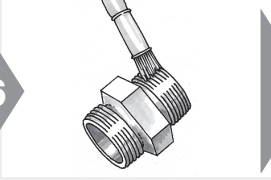

- ⚠ Threads of stainless steel fittings must be lubricated
- ⚠ Use EO-NIROMONT special high-performance lubricant for stainless steel fittings

7

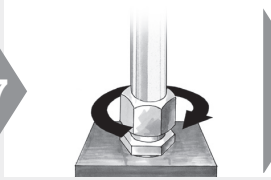

- Assemble fitting until wrench-tight (without spanner extension)

8

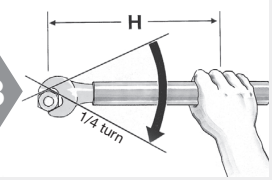

- ⚠ Then tighten fitting firmly by $\frac{1}{4}$ turn ($1\frac{1}{2}$ flats)
- ⚠ The body must be held rigid

O-Lok® assembly instructions

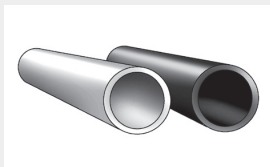

Tube selection

- Select suitable tube material

| Steel tube | | Stainless Steel tube | |
|---------------------|------------------|----------------------|-------------------|
| Cold drawn seamless | Welded & redrawn | Cold drawn seamless | |
| NF A 49330 | NF A 49341 | NF A 49341 | |
| ISO 3304 R | DIN 2393 | DIN 17458 DA/T3 | |
| DIN 2391C pt 1 | BS 3602/2 | ASTM A 269 | 1.4571 on request |
| BS 3602 pt1 | SAE J525 | | |
| SAE J524 | | | |



Tube preparation

- Cut and deburr thoroughly

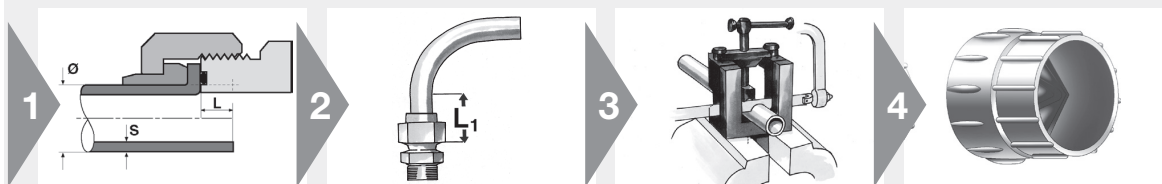

- Calculate tube length before cutting
- Add extra length "L"

- Minimum length of straight tube-ends (see chart below)

- Cut tube squarely
- max. $\pm 1^\circ$ deviation
- ⚠ Do not use pipe cutters
- Use tube-cutting tool AV for manual cutting

- Remove internal and external burrs
- max. chamfer $0.3 \text{ mm} \times 45^\circ$
- Recommendation: In-Ex Tube Deburring Tool 226
- ⚠ Proper deburring and cleaning of inner diameter essential for sealing surface quality

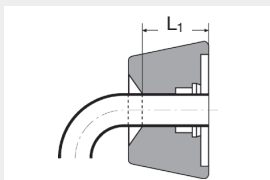

| Metric tube [mm] | | Minimum straight length to start to bend L1 [mm] | Extra length ~ L [mm] for Tube Wall thickness | | | | | | | |
|--------------------|----------------|--|---|-----|-----|-----|-----|-----|-----|---|
| Tube \varnothing | Wall thickness | | 1 | 1.5 | 2 | 2.5 | 3 | 3.5 | 4 | 5 |
| 6 | 1.0 - 1.5 | 40 | 4.5 | 5.5 | | | | | | |
| 8 | 1.0 - 2.0 | 40 | 5.0 | 5.0 | | | | | | |
| 10 | 1.0 - 2.0 | 40 | 2.5 | 4.0 | 3.5 | | | | | |
| 12 | 1.0 - 3.0 | 50 | 3.5 | 4.5 | 4.5 | 4.0 | 4.0 | | | |
| 14 | 1.5 - 2.0 | 50 | | | 5.0 | | | | | |
| 15 | 1.0 - 2.0 | 50 | | 4.5 | 5.0 | | | | | |
| 16 | 1.5 - 3.0 | 50 | | 3.0 | 3.0 | 3.0 | 2.5 | | | |
| 18 | 1.5 - 2.0 | 50 | | 6.0 | 5.5 | | | | | |
| 20 | 2.0 - 3.5 | 50 | | | 3.5 | 4.0 | 4.0 | 3.5 | | |
| 22 | 1.5 - 2.5 | 50 | | | 6.5 | 7.0 | | | | |
| 25 | 2.0 - 4.0 | 50 | | | | 4.0 | 4.5 | | 4.0 | |
| 28 | 1.5 - 3.0 | 50 | | | 6.0 | 7.0 | | | | |
| 30 | 2.0 - 4.0 | 50 | | | 5.0 | | | | 5.0 | |
| 32 | 2.0 - 4.0 | 50 | | | | | 3.5 | 3.5 | | |
| 35 | 2.0 - 3.0 | 50 | | | | | 7.0 | | | |
| 38 | 2.0 - 5.0 | 50 | | | | | 5.0 | 5.0 | 4.5 | |
| 50 | 3.0 | 50 | | | | | 4.0 | | | |

| Inch tube [inch] | | Minimum straight length to start to bend L1 [mm] | Extra length ~ L [mm] Tube Wall thickness | | | | | | | | | | |
|--------------------|----------------|--|---|--------|--------|--------|--------|--------|--------|--------|--------|--------|--------|
| Tube \varnothing | Wall thickness | | 0.028" | 0.035" | 0.049" | 0.065" | 0.083" | 0.095" | 0.109" | 0.120" | 0.134" | 0.156" | 0.188" |
| 1/4" | 0.020 - 0.065 | 40 | 4.5 | 5.0 | 4.0 | | | | | | | | |
| 3/8" | 0.020 - 0.095 | 40 | | 3.5 | 3.5 | 4.0 | 4.0 | 4.0 | | | | | |
| 1/2" | 0.028 - 0.095 | 50 | | 3.5 | 3.5 | 3.5 | 3.5 | 3.5 | | | | | |
| 5/8" | 0.035 - 0.120 | 50 | | | 4.0 | 4.0 | 3.0 | 4.5 | 4.0 | 4.5 | | | |
| 3/4" | 0.035 - 0.156 | 50 | | | 4.0 | 4.0 | 3.0 | 2.5 | 3.5 | 4.0 | 4.5 | | |
| 1" | 0.035 - 0.188 | 50 | | | | 3.5 | 2.5 | 4.5 | 4.5 | 5.0 | | | |
| 1 1/4" | 0.049 - 0.188 | 50 | | | | | 4.0 | 3.0 | 3.0 | 3.0 | 4.0 | 4.5 | 4.5 |
| 1 1/2" | 0.049 - 0.220 | 50 | | | | | 4.5 | 4.5 | 5.0 | 5.0 | 5.0 | 6.0 | 5.5 |
| 2" | 0.083 - 0.120 | 50 | | | | | | 4.0 | 4.0 | 5.0 | | | |

Tube assembly

O-Lok® assembly instructions

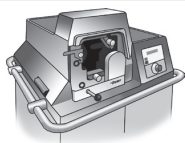

Parflange® 50



Parflange® 1025

**O-Lok® machine
flanging and assembly**

- Preferred method
- Most efficient method
- Parflange® recommended

1



Parflange® machines:

- Select flaring pin according to tube dimensions
- Use special "SS" pin for stainless steel tube
- Pin must be clean and free of wear, damage and metal particles
- Keep flaring pin clean and lubricate regularly

2

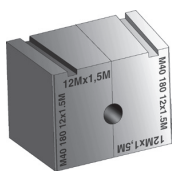

- Select flanging dies according to tube dimensions
- Use special "SS" dies for stainless steel tube to avoid contact corrosion
- Grip surface must be clean and free of wear
- Use only genuine Parker tooling for flanging O-Lok®

3

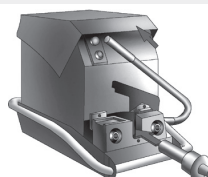

- Load pin into machine
- Ensure lubricating system is filled with EO-NIROMONT (LUBSS)

4

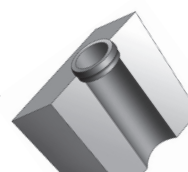

- Place sleeve in lower die half
- Locate upper die half onto lower half

5

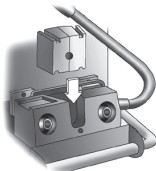

- Place the dies in the die housing
- 50: Close safety cover

6

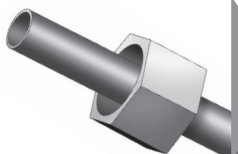

- Slide nut onto tube before flanging!
- Open threads towards machine

- ⚠ Press tube firmly into the die against the tube stop

7

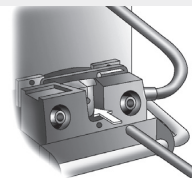

8



- Pull down the handle to clamp the tube in the dies (1025)
- 1040/50 die clamping automatic in cycle
- Press button to start flanging cycle
- ⚠ Keep hands clear off the working area

9

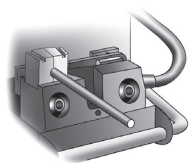

- Parflange® 1025:
Unclamp the dies
- Remove tube from machine
- Use die separator to free tube
- Parflange® 1040/50:
Die unclamping is automatic

O-Lok® assembly instructions

Checking of flange

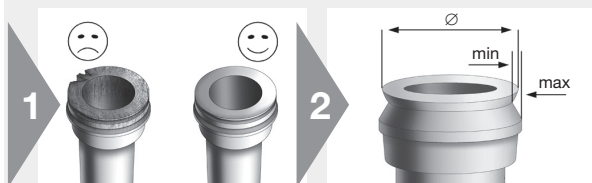

- 1
- Clean flange for inspection
 - Check sealing surface for cracks, burrs, scratches and pitting

- 2
- Dimensional check of the flare
 - Flare O.D. should not exceed outside sleeve diameter
 - Flare O.D. should not be less than smaller diameter of front of sleeve
 - When in doubt, measure

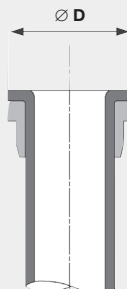

| Tube O.D. | | Ø D | |
|-----------|--------|-----------|-----------|
| mm | In. | min. [mm] | max. [mm] |
| 6 | 1/4" | 12.10 | 12.75 |
| 8 | | 14.85 | 15.75 |
| 10 | 3/8" | 14.85 | 15.75 |
| 12 | 1/2" | 18.00 | 18.90 |
| 14 | | 22.20 | 23.45 |
| 15 | | 22.20 | 23.45 |
| 16 | 5/8" | 22.20 | 23.45 |
| 18 | | 26.60 | 27.85 |
| 20 | 3/4" | 26.60 | 27.85 |
| 22 | | 32.95 | 34.20 |
| 25 | 1" | 32.95 | 34.20 |
| 28 | | 39.35 | 40.55 |
| 30 | | 39.35 | 40.55 |
| 32 | 1 1/4" | 39.35 | 40.55 |
| 35 | | 47.25 | 48.50 |
| 38 | 1 1/2" | 47.25 | 48.50 |
| 50 | 2" | 58.90 | 60.60 |

E

Installation in fitting

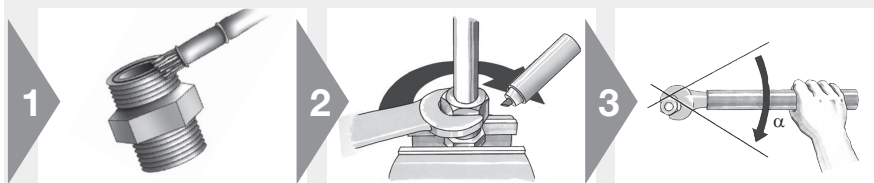

- 1
- ⚠ Steel fittings:
No thread lubrication
 - Stainless steel fittings:
⚠ O-ring and thread lubrication required
 - EO-NIROMONT is a special high-performance lubricant for stainless steel fittings

- 2
- Thread nut onto body
 - Tighten until no relative movement between the components
 - Mark body and nut as quality check

- 3
- Tighten to recommended torque level
 - Recommended: Tighten with spanner the number of flats indicated α
 - 1 flat = 60°
 - ⚠ The body must be held rigid

Tightening recommendation

| Metric tube [mm] | Inch tube [Inch] | SAE dash size | SAE thread | recommended | | reference | |
|------------------|------------------|---------------|------------|--|-----------|------------------------------|-----------------|
| | | | | α flats from wrench resistance method | | Assembly torque Nm -0% + 10% | |
| | | | | Tube | Swivel | Steel | Stainless Steel |
| 6 | 1/4" | -4 | 9/16-18 | 1/4 - 1/2 | 1/2 - 3/4 | 25 | 32 |
| 8 | 3/8" | -6 | 11/16-16 | 1/4 - 1/2 | 1/2 - 3/4 | 40 | 50 |
| 10 | 3/8" | -6 | 11/16-16 | 1/4 - 1/2 | 1/2 - 3/4 | 40 | 50 |
| 12 | 1/2" | -8 | 13/16-16 | 1/4 - 1/2 | 1/2 - 3/4 | 65 | 70 |
| 14 | 5/8" | -10 | 1-14 | 1/4 - 1/2 | 1/2 - 3/4 | 80 | 100 |
| 15 | 5/8" | -10 | 1-14 | 1/4 - 1/2 | 1/2 - 3/4 | 80 | 100 |
| 16 | 5/8" | -10 | 1-14 | 1/4 - 1/2 | 1/2 - 3/4 | 80 | 100 |
| 18 | 3/4" | -12 | 1 3/16-12 | 1/4 - 1/2 | 1/3 - 1/2 | 115 | 145 |
| 20 | 3/4" | -12 | 1 3/16-12 | 1/4 - 1/2 | 1/3 - 1/2 | 115 | 145 |
| 22 | | -16 | 1 7/16-12 | 1/4 - 1/2 | 1/3 - 1/2 | 150 | 190 |
| 25 | 1" | -16 | 1 7/16-12 | 1/4 - 1/2 | 1/3 - 1/2 | 150 | 190 |
| 28 | 1 1/4" | -20 | 1 11/16-12 | 1/4 - 1/2 | 1/3 - 1/2 | 190 | 235 |
| 30 | 1 1/4" | -20 | 1 11/16-12 | 1/4 - 1/2 | 1/3 - 1/2 | 190 | 235 |
| 32 | 1 1/4" | -20 | 1 11/16-12 | 1/4 - 1/2 | 1/3 - 1/2 | 190 | 235 |
| 35 | 1 1/2" | -24 | 2-12 | 1/4 - 1/2 | 1/3 - 1/2 | 245 | 305 |
| 38 | 1 1/2" | -24 | 2-12 | 1/4 - 1/2 | 1/3 - 1/2 | 245 | 305 |
| 50 | 2" | -32 | 2 1/2-12 | - | - | - | 490 |

* "Flats From Wrench Resistance" Method for steel and stainless steel

O-Lok® assembly instructions



O-Lok®: Replacement of O-ring

- Parker CORG assembly tool should be used for O-Lok® fitting with captive O-ring groove (O-Lok®)

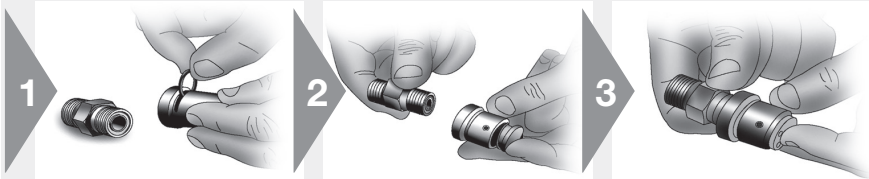

- 1
- Insert the O-ring into the slot located on the side of the tool

- 2
- Position the open end of the tool over the tube-end of the fitting

- 3
- Push the piston of the tool until the O-ring is released into the fitting groove

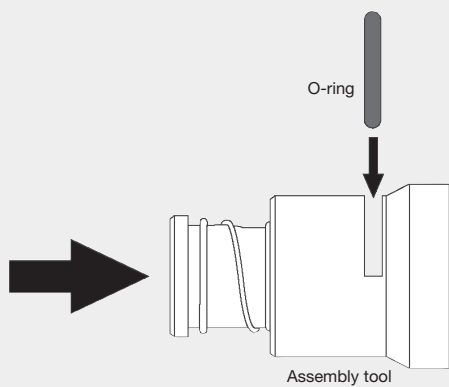

- Function of Parker CORG assembly tool

Triple-Lok® assembly instructions

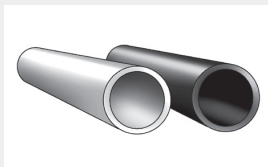

Tube selection

- Select suitable tube material

| Steel tube | | Stainless steel tube |
|---------------------|------------------|----------------------|
| Cold drawn seamless | Welded & redrawn | Cold drawn seamless |
| NF A 49330 | NF A 49341 | |
| ISO 3304 R | DIN 2393 | NF A 49341 |
| DIN 2391C pt 1 | BS 3602/2 | DIN 17458 DA/T3 |
| BS 3602 pt1 | SAE J525 | ASTM A 269 |
| SAE J524 | | |

E

Tube preparation

- Cut and deburr thoroughly

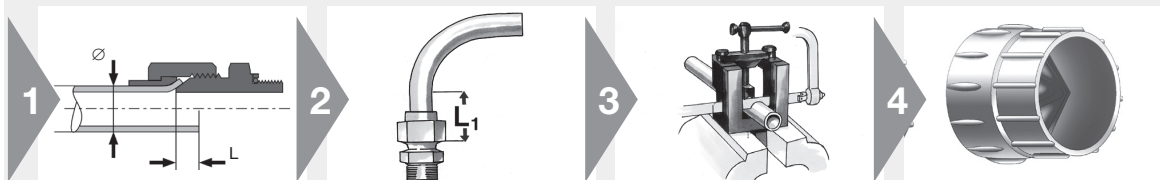

- Calculate tube length before cutting
- Add extra length "L"

- Minimum length L_1 of straight tube-ends (see chart below)

- Cut tube squarely
- max. $\pm 1^\circ$ deviation
- ⚠ Do not use pipe cutters
- Use tube cutting tool AV for manual cutting

- Remove internal and external burrs
- max. chamfer $0.3 \text{ mm} \times 45^\circ$
- Recommendation: In-Ex Tube Deburring Tool 226
- ⚠ Proper deburring and cleaning of inner diameter essential for sealing surface quality

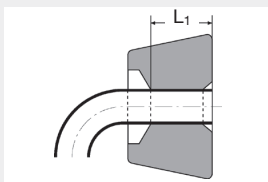

Tube preparation chart

| Metric tube [mm] | | Inch tube [inch] | | Extra length ~ L [mm] | Minimum straight length to start to bend L_1 [mm] | Flare \varnothing $\varnothing D$ [mm] |
|--------------------|----------------|--------------------|----------------|--------------------------|--|---|
| Tube \varnothing | Wall thickness | Tube \varnothing | Wall thickness | | | |
| 6 | 1.0 - 1.5 | 1/4" | 0.020 - 0.065 | 2.0 | 40 | 8.6 - 9.7 |
| 8 | 1.0 - 1.5 | 5/16" | 0.020 - 0.065 | 2.0 | 40 | 10.2 - 11.3 |
| 10 | 1.0 - 1.5 | 3/8" | 0.020 - 0.065 | 2.0 | 42 | 11.7 - 12.7 |
| 12 | 1.0 - 2.0 | 1/2" | 0.028 - 0.083 | 2.5 | 43 | 16.0 - 17.3 |
| 14 | 1.5 - 2.0 | | | 2.5 | 52 | 19.3 - 20.2 |
| 15 | 1.0 - 2.5 | | | 2.5 | 52 | 19.3 - 20.2 |
| 16 | 1.5 - 2.5 | 5/8" | 0.035 - 0.095 | 2.5 | 52 | 19.3 - 20.2 |
| 18 | 1.5 - 3.0 | | | 3.0 | 56 | 23.4 - 24.7 |
| 20 | 2.0 - 3.0 | 3/4" | 0.035 - 0.109 | 3.0 | 57 | 23.4 - 24.7 |
| 22 | 1.5 - 3.0 | | | 3.0 | 58 | 26.5 - 27.8 |
| 25 | 2.0 - 3.0 | 1" | 0.035 - 0.120 | 3.0 | 58 | 29.7 - 31.0 |
| 28 | 1.5 - 3.0 | | | 4.0 | 65 | 37.6 - 38.9 |
| 30 | 2.0 - 3.0 | | | 4.0 | 65 | 37.6 - 38.9 |
| 32 | 2.0 - 3.0 | 1 1/4" | 0.049 - 0.120 | 4.0 | 65 | 37.6 - 38.9 |
| 35 | 2.0 - 3.0 | | | 4.0 | 70 | 43.2 - 45.3 |
| 38 | 2.0 - 4.0 | 1 1/2" | 0.049 - 0.120 | 4.0 | 70 | 43.2 - 45.3 |
| 42* | 2.0 - 3.0 | | | 5.0 | 80 | 52.0 - 54.8 |
| 50 | 2.0 - 3.5 | 2" | 0.058 - 0.134 | 5.0 | | 59.2 - 61.2 |

- * Tube OD 42 mm:
- 1015: not suitable
- KARRYFLARE: special flaring pin KARRYFLARE/FPIN42 required

Tube assembly

Triple-Lok® assembly instructions

**37° Flaring
Parflange®-Process**

- Preferred method
- Most efficient method
- Parflange® recommended

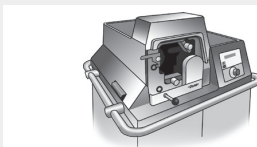

Parflange® 50



Parflange® 1025



1

- Select flaring pin according to tube dimensions
- Use special "SS" pin for stainless steel tube
- Pin must be clean and free of wear and damage
- Load tooling into machine
- Keep flaring pin clean and lubricate regularly

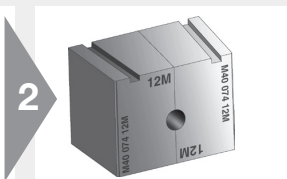

2

- Select flaring dies according to tube dimensions
- Use special "SS" dies for stainless steel tube
- Grip surface must be clean and free of wear
- Use only genuine Parker tooling for flaring Triple-Lok®

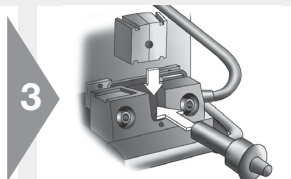

3

- Load tooling into machine
- Keep sliding surfaces clean and lubricated
- 50: Close safety cover
- Ensure lubricant system is filled with EO-NIROMONT (LUBSS)

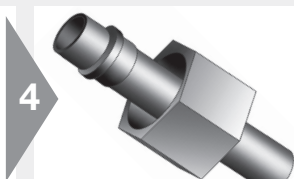

4

- Slide nut and sleeve as shown onto the tube-end

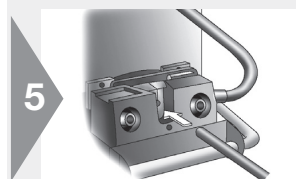

5

- ⚠ Press tube firmly into the die against the tube stop
- Parflange® 1025: Operate clamping lever
- Parflange® 1040/50: Automatic tube clamping

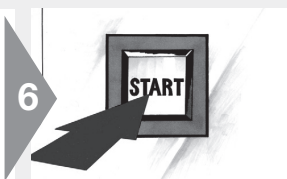

6

- Hold tube firmly
- Press start button
- ⚠ Keep hands clear off the working area

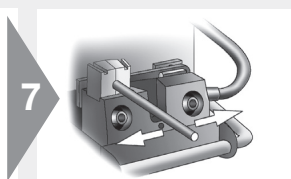

7

- Parflange® 1025: Unclamp the dies
- Parflange® 1040/50: Die unclamping is automatic
- Remove tube from machine
- Use die separator to free tube

Triple-Lok® assembly instructions

37° Flaring with EOMAT/KARRYFLARE/Parflare ECO

- Preferred method
- Most efficient method
- Parflange® recommended

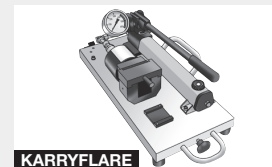
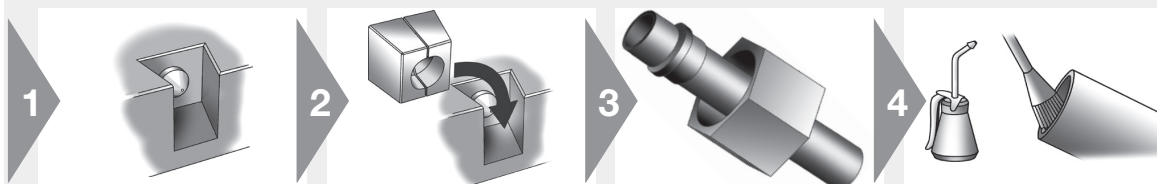

E

- Flaring pin is integrated in flaring block
- Pin must be clean and free of wear and damage
- Keep flaring pin clean
- KARRYFLARE: Flaring pin for 42 mm tube O.D. must be fitted with flat face on top

- Select flaring dies according to tube O.D.
- Grip surface must be clean and free of wear
- Use only genuine Parker tooling for flaring Triple-Lok®
- Keep sliding surfaces clean and lubricated

- Slide nut and sleeve as shown onto the tube-end

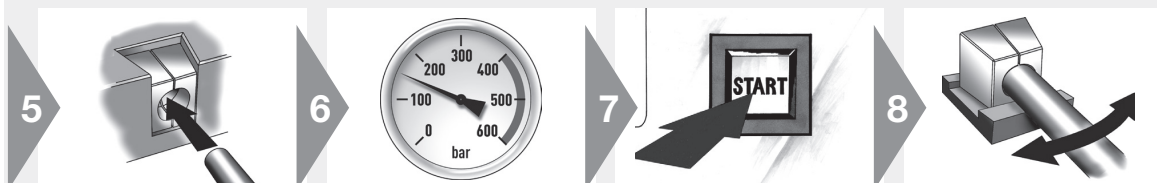
- Lubricate tube-end inside
- Lubricant EO-NIROMONT recommended



- ⚠ Press tube firmly into the die against the tube stop
- KARRYFLARE: Close valve on handpump
 - KARRYFLARE: Keep lid closed

- EOMAT UNI: Adjustment according to pressure on machine
- EOMAT III/A: Menu selection (FLARE)
- KARRYFLARE: Refer to chart on machine
- Non-EOMAT-machines: check suitability

- Hold tube firmly
 - EOMAT: Press and hold start button
 - KARRYFLARE: Operate handpump until assembly pressure is reached
- ⚠ Keep hands clear off the working area
- ⚠ KARRYFLARE: Do not exceed max pressure 400 bar

- KARRYFLARE: Open valve on handpump
- Remove tube from machine
- Use die separator to free tube

Tube assembly

Triple-Lok® assembly instructions

Checking the flare



- Clean flare for inspection
- ⚠ Visual check sealing surface for cracks, burrs, scratches and pitting

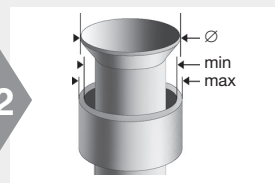

- Dimensional check of the flare
- Flare O.D. should not exceed outside sleeve diameter
- Flare O.D. should not be less than smaller diameter of front of sleeve
- When in doubt, measure

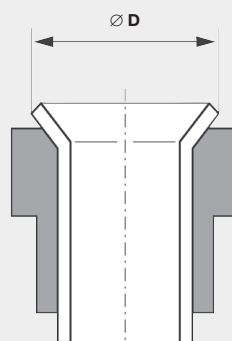

| Tube O.D. | | Ø D | |
|-----------|--------|------|------|
| mm | inch | Min. | Max. |
| 6 | 1/4" | 8.6 | 9.7 |
| 8 | 5/16" | 10.2 | 11.3 |
| 10 | 3/8" | 11.7 | 12.7 |
| 12 | 1/2" | 16.0 | 17.3 |
| 14 | | 19.3 | 20.2 |
| 15 | | 19.3 | 20.2 |
| 16 | 5/8" | 19.3 | 20.2 |
| 18 | | 23.4 | 24.7 |
| 20 | 3/4" | 23.4 | 24.7 |
| 22 | 7/8" | 26.5 | 27.8 |
| 25 | 1" | 29.7 | 31.0 |
| 28 | | 37.6 | 38.9 |
| 30 | | 37.6 | 38.9 |
| 32 | 1 1/4" | 37.6 | 38.9 |
| 35 | | 43.2 | 45.3 |
| 38 | 1 1/2" | 43.2 | 45.3 |
| 42 | | 52.0 | 54.8 |
| 50 | 2" | 59.2 | 61.2 |

Installation

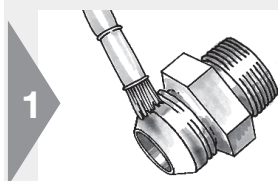

- Steel fittings: No lubrication
- ⚠ Stainless steel fittings: Lubrication required
- Use EO-NIROMONT special high-performance lubricant for stainless steel fittings

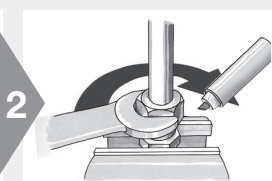

- Thread nut onto body
- Tighten to full metal contact (wrench tight)
- Mark body and nut as quality check
- Tighten with spanner the number of flats indicated
- ⚠ The body must be held rigid

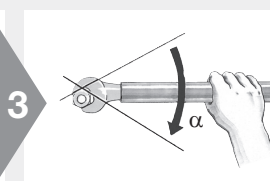

- Use spanner extension for larger fittings (28 mm)

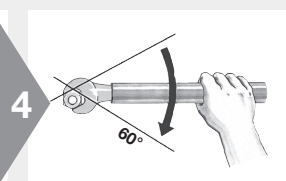

- 1 flat = 60°

Tightening recommendation

| Metric tube [mm] | Inch tube [Inch] | SAE thread | recommended | | | | reference | |
|------------------|------------------|------------|-------------------------------------|--------|---|--------|------------------------------|-----------------|
| | | | α flats from wrench tight for steel | | α flats from wrench tight for stainless steel | | Assembly torque Nm -0% + 10% | |
| | | | Tube | Swivel | Tube | Swivel | Steel | Stainless steel |
| 6 | 1/4" | 7/16-20 | 2 | 2 | 2 | 2 | 18 | 30 |
| 8 | 3/8" | 1/2-20 | 2 | 2 | 2 | 2 | 20 | 40 |
| 10 | 3/8" | 9/16-18 | 2 | 1.5 | 1.5 | 1 | 30 | 60 |
| 12 | 1/2" | 3/4-16 | 2 | 1.5 | 1.5 | 1 | 57 | 115 |
| 14 | 5/8" | 7/8-14 | 1.5 | 1.5 | 1.5 | 1 | 81 | 145 |
| 15 | 5/8" | 7/8-14 | 1.5 | 1.5 | 1.5 | 1 | 81 | 145 |
| 16 | 5/8" | 7/8-14 | 1.5 | 1.5 | 1.5 | 1 | 81 | 145 |
| 18 | 3/4" | 1 1/16-12 | 1.5 | 1.25 | 1.25 | 1 | 114 | 180 |
| 20 | 3/4" | 1 1/16-12 | 1.5 | 1.25 | 1.25 | 1 | 114 | 180 |
| 22 | | 1 3/16-12 | 1.5 | 1.25 | 1 | 1 | 136 | 225 |
| 25 | 1" | 1 5/16-12 | 1.5 | 1 | 1 | 1 | 160 | 255 |
| 28 | 1 1/4" | 1 5/8-12 | 1 | 1 | 1 | 1 | 228 | 295 |
| 30 | 1 1/4" | 1 5/8-12 | 1 | 1 | 1 | 1 | 228 | 295 |
| 32 | 1 1/4" | 1 5/8-12 | 1 | 1 | 1 | 1 | 228 | 295 |
| 35 | 1 1/2" | 1 7/8-12 | 1 | 1 | 1 | 1 | 265 | 345 |
| 38 | 1 1/2" | 1 7/8-12 | 1 | 1 | 1 | 1 | 265 | 345 |
| 42 | | 2 1/4-12 | 1 | 1 | 1 | 1 | 340 | 400 |

Checking instructions for O-Lok®/Triple-Lok® tools



Tools for Parflange® machines

- ⚠ Use of damaged, worn or non-suitable tooling may result in fitting failure and damage of machine
- ⚠ Tools must be checked regularly, at least after 50 assemblies
- ⚠ Worn tools must be replaced
- ⚠ Use only genuine Parker tools
- ⚠ Tools must always be kept clean and lubricated

1



- Clean pin for checking

2



- Visual check:
Surface must be free of wear and damage

3

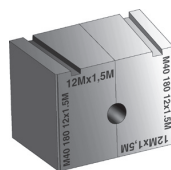

- Clean die halves for checking
- ⚠ Do not disassemble
- Fixing pins must not be loose or damaged

4

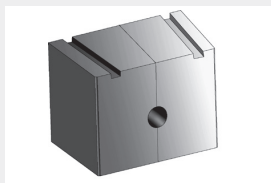

- Visual check:
Grip surface must be clean and free of wear
- Use wire-brush to remove metal particles from grip surface

E

Adjustment of Parflange® dies

- Parflange® dies can be adjusted to correct deviations of flare diameter
- ⚠ Re-adjustment of dies will not help if general machine setting is incorrect or components are damaged (worn tube-stop, lose screw connections)

1

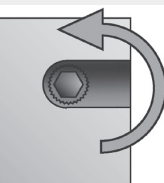

- To reduce the flare diameter, turn the screws anti-clockwise
- ⚠ Re-adjust both screws simultaneously

2

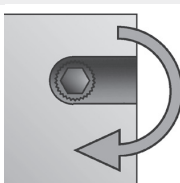

- To increase the flare diameter, turn the screws clockwise
- ⚠ Re-adjust both screws simultaneously
- 1 click = approx. 0.05 mm \varnothing

3

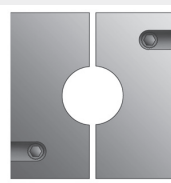

- Adjust the screws in small stages
- Then check flare diameter
- Lock screws to prevent misadjustment
- ⚠

Tube assembly

Ferulok® assembly instruction

Tube preparation



- Cut and deburr thoroughly
- Do not assemble under tension

1

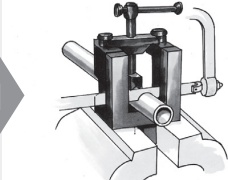

- Cut tube squarely
- max ±1° deviation

⚠ Do not use pipe cutters

- EO tube-cutting tool (AV) for manual cutting

2

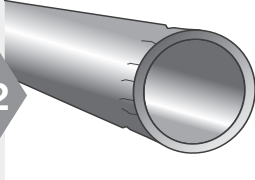

- Don't deform tube end at cutting or bending
- Marks or scratches can result in leakage
- Thin wall and soft tubes are very sensitive

3

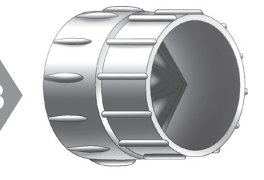

- Remove internal and external burrs
- max. chamfer 0.3 mm x 45°

Ferrule Preset

Prior to final installation the Ferulok® fitting requires a pre-setting operation that creates a bite by the ferrule into the outer surface of the tubing. Pre-setting can be accomplished by two different methods: hydraulically, using a Hyferset tool or a Hydra-Tool, or manually, using a hardened Ferruleset tool or the fitting body.

Pre-setting using Ferulset tool or fitting body

Ferulset pre-setting tools are made from hardened steel and are recommended over the fitting body because they can be used repeatedly to perform the pre-set operation. The fitting body can only be used once for pre-setting and should be used during final installation with the pre-set tube line. The following steps are required for proper pre-set of the ferrule using the Feruleset tool or fitting body.

1



- Lubricate thread and cone of Ferrulset tool (or fitting body)

2

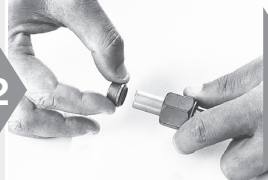

- Slip nut and ferrule over deburred tube end. Be sure the long, straight end of the ferrule points toward tube end

3



- Lubricate ferrule with system fluid or a compatible lubricant

4



- Bottom tube end firmly on internal shoulder of Ferrulset tool (or fitting body)

5



- Manually screw nut onto Ferrulset tool or fitting body until finger tight

6

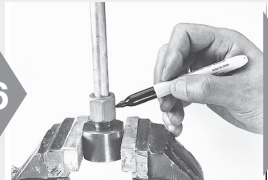

- Make reference mark on nut and tube

7



- Hold tube steady against internal shoulder of Ferrulset tool or fitting body and tighten nut an additional **1 3/4 turns**

8



- Loosen nut and check for proper pre-set. Use the following inspection criteria.

Ferulok® assembly instruction

Pre-setting with Hyferset Tool or Hydra-Tool

Pre-setting with hydraulic equipment (Hyferset or Hydra-tool) is preferred for fittings larger than size 8 or large production quantities in any size.

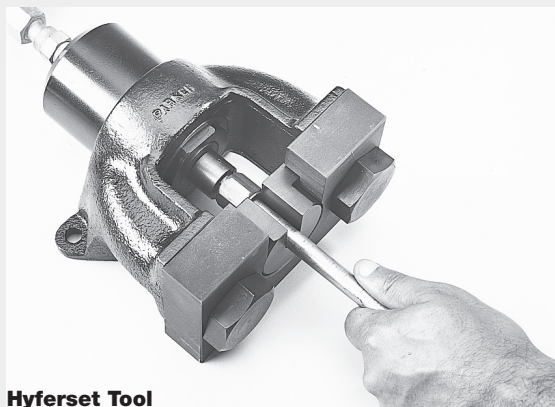

Hyferset Tool

E

Pre-set inspection

All Ferulok fitting presets must be disassembled and inspected for correct ferrule pre-set before final installation. The following detailed inspection procedures must be followed regardless of the method used to pre-set the ferrule to the tube. (Refer to the figure below for the following five inspection points.

1. A ridge of metal (A) has been raised above the tube surface to a height of at least 50 % of the ferrule's leading edge, completely around the tube.
2. While the leading edge of the ferrule may be coined flat (B) there is a slight bow to the balance of the pilot section (C).
3. The tail or back end of the ferrule is snug against the tube (D).
4. There is a slight indentation around the end of the tube (E) that indicates the tube was bottomed in the tool or fitting during pre-setting.
5. Avoid rotating the ferrule. Steel ferrules should not be capable of moving back and forth along the tube beyond the bite area (a stainless steel ferrule will move more than steel because of its spring back characteristics).

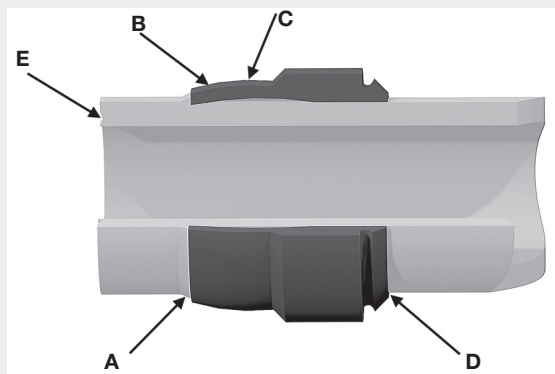

Installation

If the fitting body was used for pre-setting the ferrule, complete the final installation with the **same** fitting body. Following the pre-setting and inspection, select the compatible fitting body and lubricate the threads. Tighten the nut until a sudden and noticeable wrench resistance is achieved. Then wrench an additional 1/6 to 1/4 turn to complete the final assembly. Final assembly of swivel nut fittings is achieved by turning the nut 3/4 turn from wrench resistance position.

Ferulok® assembly instruction

Hydra-tool Pre-setting pressures for Ferulok® fittings¹⁾²⁾³⁾

| Tube Size | Wall Thickness - Steel | | | | | | | Wall Thickness Stainless Steel | | | | | | |
|-----------|------------------------|-------|-------|-------|-------|-------|-------|--------------------------------|-------|-------|-------|-------|-------|-------|
| | 0.035 | 0.049 | 0.065 | 0.083 | 0.095 | 0.109 | 0.120 | 0.035 | 0.049 | 0.065 | 0.083 | 0.095 | 0.109 | 0.120 |
| 4 | 300 | 300 | 500 | 600 | 600 | 600 | | 300 | 300 | 500 | 700 | 700 | 700 | |
| 6 | 300 | 500 | 600 | 700 | 700 | 700 | 700 | 300 | 500 | 700 | 700 | 700 | 700 | 800 |
| 8 | | 500 | 700 | 800 | 900 | 1.000 | 1.000 | | 600 | 700 | 1.000 | 1.000 | 1.100 | 1.100 |
| 10 | | | 700 | 900 | 1.000 | 1.100 | 1.100 | | | 800 | 1.000 | 1.100 | 1.300 | 1.300 |
| 12 | | | 900 | 1.000 | 1.100 | 1.100 | 1.300 | | | 1.000 | 1.100 | 1.300 | 1.300 | 1.500 |
| 14 | | | 1.000 | 1.100 | 1.100 | 1.300 | 1.500 | | | 1.000 | 1.300 | 1.300 | 1.500 | 1.600 |
| 16 | | | | 1.100 | 1.300 | 1.500 | 1.600 | | | | 1.500 | 1.500 | 1.600 | 1.600 |
| 20 | | | | | 1.500 | 1.600 | 1.800 | | | | | 1.600 | 2.000 | 2.000 |
| 24 | | | | | 1.800 | 2.000 | 2.300 | | | | | 2.100 | 2.300 | 2.300 |
| 32 | | | | | 2.800 | 2.900 | 3.300 | | | | | 3.100 | 3.300 | 3.300 |

1. These values are provided as a guide only and normally will produce a satisfactory bite.
2. Ferulok® pre-setting dies are positive stop dies. Use of above pressures is optional.
3. For wall thicknesses greater than those listed, contact the Tube Fittings Division.

Hyferset Pre-setting for Ferulok® fittings¹⁾

| Tube Size | Wall thickness - Steel | | | | | | | Wall thickness - Stainless Steel | | | | | | |
|-----------|------------------------|-------|-------|-------|-------|-------|--------|----------------------------------|-------|-------|-------|-------|--------|--------|
| | 0.035 | 0.049 | 0.065 | 0.083 | 0.095 | 0.109 | 0.120 | 0.035 | 0.049 | 0.065 | 0.083 | 0.095 | 0.109 | 0.120 |
| 4 | 800 | 900 | 1400 | 1800 | 1.800 | 1.800 | | 900 | 1.000 | 1.500 | 2.000 | 2.000 | 2.000 | |
| 6 | 900 | 1.400 | 800 | 2.000 | 2.000 | 2.000 | 2.200 | 1.000 | 1.500 | 2.000 | 2.000 | 2.000 | 2.000 | 2.500 |
| 8 | | 1.600 | 2.000 | 2.500 | 2.700 | 3.000 | 3.200 | | 1.800 | 2.200 | 3.000 | 3.000 | 3.500 | 3.500 |
| 10 | | | 2.200 | 2.700 | 3.000 | 3.500 | 3.500 | | | 2.500 | 3.000 | 3.500 | 4.000 | 4.000 |
| 12 | | | 2.700 | 3.000 | 3.500 | 3.500 | 4.000 | | | 3.000 | 3.500 | 4.000 | 4.000 | 4.500 |
| 14 | | | 3.000 | 3.500 | 3.500 | 4.000 | 4.500 | | | 3.000 | 4.000 | 4.000 | 4.500 | 5.000 |
| 16 | | | | 3.500 | 4.000 | 4.500 | 5.000 | | | | 4.500 | 4.500 | 5.000 | 5.000 |
| 18 | | | | 4.000 | 4.500 | 4.500 | 5.000 | | | | 4.500 | 5.000 | 5.000 | 5.500 |
| 20 | | | | | 4.500 | 5.000 | 5.500 | | | | | 5.000 | 6.000 | 6.000 |
| 24 | | | | | 5.500 | 6.000 | 7.000 | | | | | 6.500 | 7.000 | 7.000 |
| 28 | | | | | 7.000 | 7.500 | 8.000 | | | | | 7.500 | 8.000 | 8.500 |
| 32 | | | | | 8.500 | 9.000 | 10.000 | | | | | 9.500 | 10.000 | 10.000 |

1. Ferulok® pre-setting dies are positive stop dies. Use of above pressures is optional.



Fitting assembly

Fitting assembly

Table of contents

| | |
|---------------------------------------|-----|
| Port connections M | F4 |
| Port connections BSPP | F5 |
| Port connections UNF | F6 |
| Port connections TAPER | F7 |
| Adjustable fittings with locknut..... | F8 |
| EO swivels | F9 |
| Triple-Lok® / O-Lok® swivels | F10 |
| Flanges | F11 |
| Replacement / DA..... | F12 |
| Tube bending | F13 |
| Tube line fabrication guide..... | F14 |



Fitting assembly

Port connections

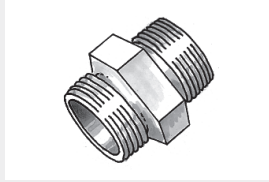

Assembly of metric straight port connections

- Metric Thread
DIN ISO 6149-2/3
ISO 9974-2/3
DIN 3859-T2

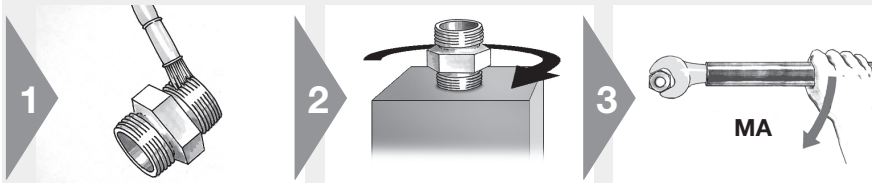

- ⚠ Threads of stainless steel fittings must be lubricated
- EO-NIROMONT is a special high-performance lubricant for stainless steel fittings
- Screw in until handtight
- Then tighten according to chart

Assembly torques for zinc plated steel fittings with metric thread in ports made of steel

| Product | Tube O.D. | Straight male stud fittings with port tapping | | | | | | Non return valves RHV/RHZ Form E with ED-sealing | EO Banjo fittings | | | Adjustable ends | | Blanking plugs | | |
|------------------|-----------|---|---------------------------|------------------|------------------------|----------------------------|---------------------------------------|--|-------------------|-----|-----|------------------------------------|-------------------------|--------------------------------------|--|----|
| | | Thread size T | Form A for sealing washer | Form B with face | Form E with ED-sealing | Form F with O-Ring-sealing | Form G with O-Ring and retaining ring | | WH/TH | SWE | DSW | ISO 9974 O-Ring and retaining ring | DIN ISO 6149-2/3 O-Ring | oiled VSTI-ED Form E with ED-sealing | oiled VSTI-OR Form F with O-Ring-sealing | |
| Series | | mm | Nm | Nm | Nm | Nm | Nm | Nm | Nm | Nm | Nm | Nm | Nm | Nm | Nm | Nm |
| EO L Triple-Lok® | 6 | M 10x1.0 | 9 | 18 | 18 | 15 | 18 | 18 | 18 | 25 | 30 | 18 | 15 | 12 | 18 | |
| | 8 | M 12x1.5 | 20 | 30 | 25 | 25 | 35 | 25 | 45 | 40 | 25 | 25 | 25 | 30 | | |
| | 10 | M 14x1.5 | 35 | 45 | 45 | 35 | 45 | 35 | 55 | 55 | 50 | 40 | 35 | 40 | | |
| | 12 | M 16x1.5 | 45 | 65 | 55 | 40 | 55 | 50 | 80 | 65 | 65 | 55 | 40 | 50 | | |
| | 15 | M 18x1.5 | 55 | 80 | 70 | 45 | 70 | 70 | 100 | 90 | 85 | 70 | 45 | 65 | | |
| | 18 | M 22x1.5 | 65 | 140 | 125 | 60 | 160 | 125 | 140 | 130 | 130 | 90 | 60 | 90 | | |
| | 22 | M 26x1.5 | 90 | 190 | 180 | 100* | 250 | 145 | 320 | 140 | 190 | 180 | 100 | 135 | | |
| | 28 | M 33x2.0 | 150 | 340 | 310 | 160 | 310 | 210 | 360 | | 245 | 310 | 160 | 225 | | |
| | 35 | M 42x2.0 | 240 | 500 | 450 | 210 | 450 | 360 | 540 | | 305 | 450 | 210 | 360 | | |
| 42 | M 48x2.0 | 290 | 630 | 540 | 260 | 540 | 540 | 700 | | 365 | 540 | 260 | 360 | | | |
| EO S O-Lok® | 6 | M 12x1.5 | 20 | 35 | 35 | 35 | | 35 | 45 | 40 | 40 | 35 | 35 | 25 | 35 | |
| | 8 | M 14x1.5 | 35 | 55 | 45 | 45 | | 45 | 55 | 50 | 45 | 45 | 45 | 35 | 45 | |
| | 10 | M 16x1.5 | 45 | 70 | 70 | 55 | | 55 | 80 | 65 | 65 | 55 | 55 | 50 | 55 | |
| | 12 | M 18x1.5 | 55 | 110 | 90 | 70 | | 70 | 100 | 90 | 85 | 70 | 70 | 65 | 70 | |
| | 14 | M 20x1.5 | 55 | 150 | 125 | 80 | | 100 | 125 | 120 | 105 | 90 | 90 | 80 | 80 | |
| | 16 | M 22x1.5 | 65 | 170 | 135 | 100 | | 125 | 135 | 130 | 130 | 90 | 100 | 90 | 100 | |
| | 20 | M 27x2.0 | 90 | 270 | 180 | 170 | | 135 | 320 | 150 | 200 | 190 | 170 | 120 | 170 | |
| | 25 | M 33x2.0 | 150 | 410 | 310 | 310 | | 210 | 360 | | 245 | 310 | 310 | 225 | 310 | |
| | 30 | M 42x2.0 | 240 | 540 | 450 | 330 | | 360 | 540 | | 305 | 450 | 330 | 360 | 330 | |
| | 38 | M 48x2.0 | 290 | 700 | 540 | 420 | | 540 | 700 | | 365 | 540 | 420 | 360 | 420 | |

Tolerance of tightening torques listed in above table: +10 %
Note: Lubricate stud with hydraulic oil before screwing in! *Thread M 27.0

⚠ Assembly in ports made of materials, which are strongly differing in strength and friction from steel, usually requires modified torques.

A reduction of torque is always required, when the turning angle from fingertight to the recommended torque is more than 30°!

In this case it is recommended to reduce the torque:

| Port material | Hardness | Torque reduction by |
|--|----------|---------------------|
| Steel, with use of high performance lubrication (e.g. additive to hydraulic oil) | All | 10 % |
| Ductile cast iron (e.g. GGG 50) | All | 10 % |
| Aluminium | HB 150 | 15 % |
| | HB 125 | 20 % |
| | HB 100 | 30 % |
| | < HB 100 | 35 % |

Port connections

Assembly of BSPP straight port connections

- BSPP Thread G
ISO 1179-I
DIN 3859-T2

⚠ Threads of stainless steel fittings must be lubricated

- EO-NIROMONT is a special high-performance lubricant for stainless steel fittings

• Screw in until handtight

• Then tighten according to chart

Assembly torques for zinc plated steel fittings with BSPP thread in ports according to ISO 1179 made of steel

| Product Series | Tube O.D. | Thread size T | Straight male stud fittings with port tapping | | | | Non-return valves RHV/RHZ Form E with ED-sealing Nm | EO Banjo fittings | | | Adjustable ends ISO 1179-3 O-Ring and retaining-ring Nm | Blanking plugs oiled VSTI-ED Form E with ED-sealing Nm ⚠ |
|------------------|-----------|---------------|---|-----------------------------|---------------------------|--|--|-------------------|---------|---------|--|---|
| | | | Form A for sealing washer Nm | Form B with cutting-face Nm | Form E with ED-sealing Nm | Form G with O-Ring and retaining ring Nm | | WH/TH Nm | SWVE Nm | DSWV Nm | | |
| EO L Triple-Lok® | 6 | G 1/8 A | 9 | 18 | 18 | 18 | 18 | 18 | 20 | 25 | 18 | 13 |
| | 8 | G 1/4 A | 35 | 35 | 35 | 35 | 35 | 45 | 45 | 50 | 35 | 30 |
| | 10 | G 1/4 A | 35 | 35 | 35 | 35 | 35 | 45 | 45 | 50 | 35 | (30) |
| | 12 | G 3/8 A | 45 | 70 | 70 | 70 | 50 | 70 | 70 | 70 | 6 | 60 |
| | 15 | G 1/2 A | 55 | 140 | 90 | 90 | 85 | 120 | 100 | 110 | 90 | 80 |
| | 18 | G 1/2 A | 65 | 100 | 90 | 90 | 65 | 120 | 100 | 110 | 9 | (80) |
| | 22 | G 3/4 A | 90 | 180 | 180 | 180 | 140 | 230 | 140 | 185 | 180 | 140 |
| | 28 | G 1 A | 150 | 330 | 310 | 310 | 190 | 320 | | 255 | 310 | 200 |
| | 35 | G 1 1/4 A | 240 | 540 | 450 | 450 | 360 | 540 | | 315 | 450 | 400 |
| 42 | G 1 1/2 A | 290 | 630 | 540 | 540 | 540 | 700 | | 365 | 540 | 450 | |
| EO S O-Lok® | 6 | G 1/8 A | | | | | | | | | 25 | 13 |
| | 6 | G 1/4 A | 35 | 55 | 40 | | 45 | 45 | 45 | 50 | 40 | 30 |
| | 8 | G 1/4 A | 35 | 55 | 40 | | 45 | 45 | 45 | 50 | 40 | (30) |
| | 10 | G 3/8 A | 45 | 90 | 80 | | 60 | 70 | 70 | 70 | 60 | 60 |
| | 12 | G 3/8 A | 45 | 90 | 80 | | 60 | 70 | 70 | 70 | 60 | (60) |
| | 14 | G 1/2 A | 65 | 150 | 115 | | 145 | 120 | 100 | 110 | 90 | 80 |
| | 16 | G 1/2 A | 65 | 130 | 115 | | 100 | 120 | 100 | 110 | 90 | (80) |
| | 20 | G 3/4 A | 90 | 270 | 180 | | 145 | 230 | 145 | 185 | 180 | 140 |
| | 25 | G 1 A | 150 | 340 | 310 | | 260 | 320 | | 255 | 310 | 200 |
| | 30 | G 1 1/4 A | 240 | 540 | 450 | | 360 | 540 | | 315 | 450 | 400 |
| | 38 | G 1 1/2 A | 290 | 700 | 540 | | 540 | 700 | | 365 | 540 | 450 |

Tolerance of tightening torques listed in above table: +10 %
Note: Lubricate stud with hydraulic oil before screwing in.

| Port material | Hardness | Torque reduction by |
|--|----------|---------------------|
| Steel, with use of high performance lubrication (e.g. additive to hydraulic oil) | All | 10 % |
| Ductile cast iron (e.g. GGG 50) | All | 10 % |
| Aluminium | HB 150 | 15 % |
| | HB 125 | 20 % |
| | HB 100 | 30 % |
| | < HB 100 | 35 % |

⚠ Assembly in ports made of materials, which are strongly differing in strength and friction from steel, usually requires modified torques.

A reduction of torque is always required, when the turning angle from fingertight to the recommended torque is more than 30°!

In this case it is recommended to reduce the torque:

Fitting assembly

Port connections

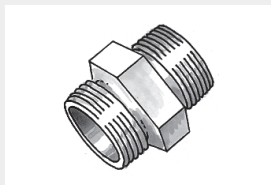
Assembly of SAE straight port connections

- UN/UNF thread
ISO 11926-2/3

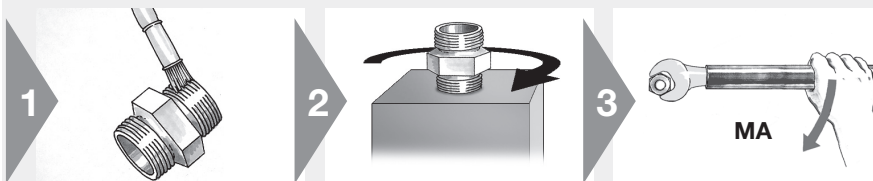

⚠ Threads of stainless steel fittings must be lubricated

- EO-NIROMONT is a special high-performance lubricant for stainless steel fittings

- Screw in until handtight

- Then tighten according to chart

Assembly torques for zinc plated steel fittings with UNF thread in ports according to ISO 11926 made of steel

| Product | Thread size T ISO 11926 | Series | |
|---------------------|-------------------------------|---|--|
| | | EO / Triple-Lok® and O-Lok® Assembly torque non-adjustable end with O-ring sealing Nm | Assembly torque adjustable end with O-ring sealing Nm |
| Series | inch | | |
| EO L Triple-Lok® | 7/16-20 UN(F) | 23 | 18 |
| | 1/2-20 UN(F) | 28 | 28 |
| | 9/16-18 UN(F) | 34 | 34 |
| | 3/4-16 UN(F) | 60 | 55 |
| | 7/8-14 UN(F) | 115 | 80 |
| | 1 1/16-12 UN(F) | 140 | 100 |
| | 1 5/16-12 UN(F) | 210 | 150 |
| | 1 5/8-12 UN(F) | 290 | 290 |
| | 1 7/8-12 UN(F) | 325 | 325 |
| EO S O-Lok® | 7/16-20 UN(F) | 35 | 20 |
| | 1/2-20 UN(F) | 40 | 40 |
| | 9/16-18 UN(F) | 46 | 46 |
| | 3/4-16 UN(F) | 80 | 80 |
| | 7/8-14 UN(F) | 135 | 135 |
| | 1 1/16-12 UN(F) | 185 | 185 |
| | 1 5/16-12 UN(F) | 270 | 270 |
| | 1 5/8-12 UN(F) | 340 | 340 |
| | 1 7/8-12 UN(F) | 415 | 415 |

Tolerance of tightening torques listed in above table: + 10 %

Note: Lubricate stud with hydraulic oil before screwing in!

⚠ Assembly in ports made of materials, which are strongly differing in strength and friction from steel, usually requires modified torques.

A reduction of torque is always required, when the turning angle from fingertight to the recommended torque is more than 30°!

In this case it is recommended to reduce the torque:

| Port material | Hardness | Torque reduction by |
|--|----------|---------------------|
| Steel, with use of high performance lubrication (e.g. additive to hydraulic oil) | All | 10 % |
| Ductile cast iron (e.g. GGG 50) | All | 10 % |
| Aluminium | HB 150 | 15 % |
| | HB 125 | 20 % |
| | HB 100 | 30 % |
| | < HB 100 | 35 % |

Port connections

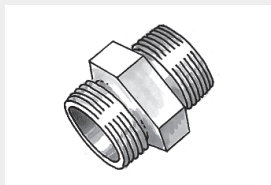

Assembly of tapered thread port connections

- NPT / NPTF thread
ANSI / ASME B 1.20.1 – 1983

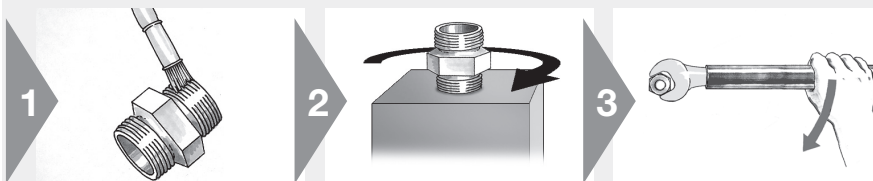

⚠ Threads of stainless steel fittings must be lubricated

- EO-NIROMONT is a special high-performance lubricant for stainless steel fittings

- Apply teflon tape (1.5 layer) to the taper stud end and screw in handtight

- Then tighten according to chart

Tightening of NPT / NPTF thread

| Größe | Thread T NPT/F | Assembly TFFT Turns |
|-------|----------------------|---------------------------|
| 4 | 1/8-27 NPT/F | 2.0-3.0 |
| 6 | 1/4-18 NPT/F | 2.0-3.0 |
| 8 | 3/8-18 NPT/F | 2.0-3.0 |
| 10 | 1/2-14 NPT/F | 2.0-3.0 |
| 12 | 3/4-14 NPT/F | 2.0-3.0 |
| 16 | 1-11.5 NPT/F | 1.5-2.5 |
| 20 | 1 1/4 -11.5 NPT/F | 1.5-2.5 |
| 24 | 1 1/2-11.5 NPT/F | 1.5-2.5 |

In the EO fitting range only **NPT** threads are manufactured.

In the **Triple-Lok®** and **O-Lok®** fitting range for **steel**

NPTF threads are used, and NPT for stainless steel components. estell.

F

Fitting assembly

Adjustable fittings with locknut

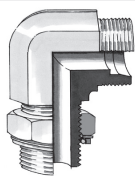
Assembly of the orientable joint

(EO: e.g. WEE, VEE, TEE, LEE - Triple-Lok® / O-Lok®: C4, V4, S4, R4)

⚠ Assembly steps must be done in right order

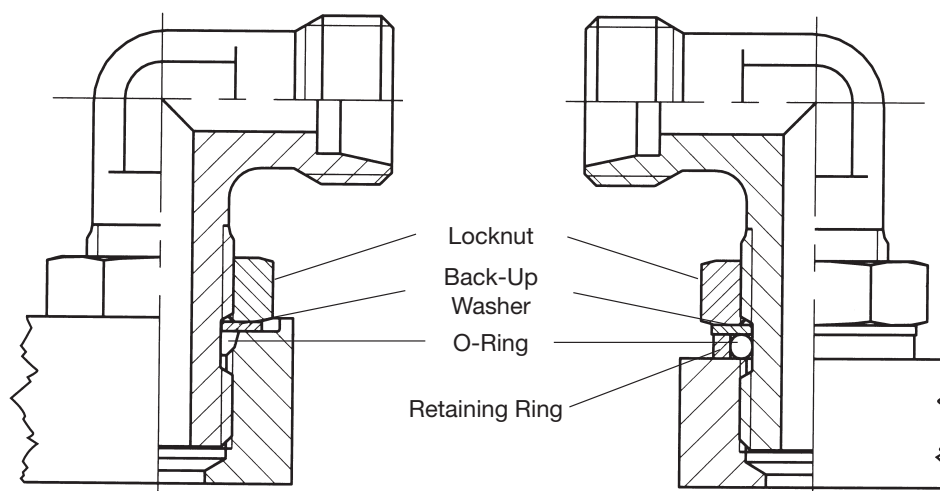
 • Fitting *without* Retaining Ring for ISO 6149 or UN/UNF ports

 • Fitting *with* Retaining Ring for BSPP or Metric Parallel ports with wide or **SMALL** spot faces

1



• Screw back locknut as far as possible

⚠ O-ring and back-up washer in the non-threaded section should be placed nearest to the locknut

- Lubricate the O-ring
- With BSPP and metric parallel version slip retaining ring over the O-ring



2

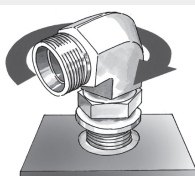

• Screw the fitting in the port by hand until retaining ring or back-up washers bottom



3

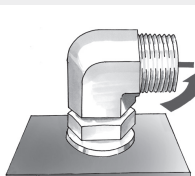

• To adjust direction, turn back to a maximum of one full turn

4

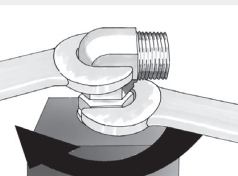

- Screw locknut handtight
- Assemble locknut until wrenchtight
- Hold body in desired position and tighten locknut



EO swivels

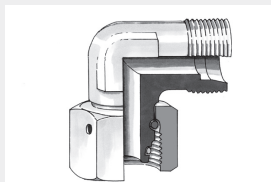

Assembly of EO swivel nut fittings

(e.g. EW, ET, EL, EGE, RED, VKA, SKA)

- Final assembly of swivel nut fittings must be made in appropriate fittings

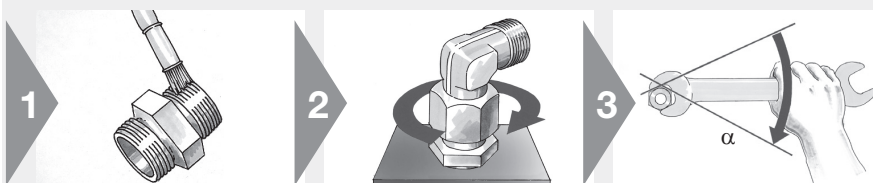

- 1
- ⚠ Threads of stainless steel fittings must be lubricated
 - EO-NIROMONT is a special high-performance lubricant for stainless steel fittings

- 2
- Screw on nut by hand until handtight

- 3
- ⚠ Then tighten fitting firmly by $\frac{1}{4}$ turn ($1\frac{1}{2}$ flats)

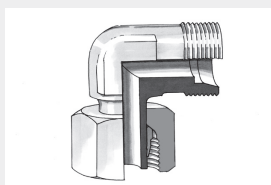
F

Final assembly of factory pre-assembled EO-standpipe fittings

(e.g. EVW, EVT, EVL, EVGE, KOR)

- For all fittings delivered pre-assembled from the factory the final assembly is performed in the appropriate fitting body

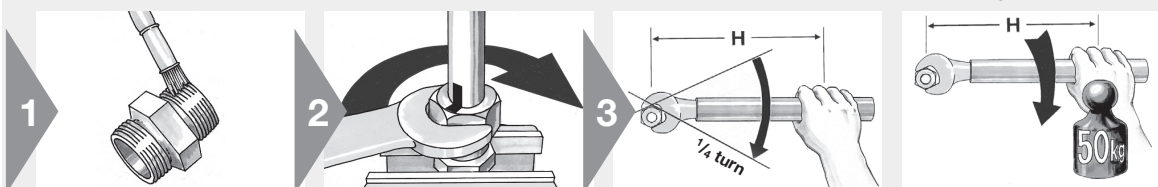

- 1
- ⚠ Threads of stainless steel fittings must be lubricated
 - EO-NIROMONT is a special high-performance lubricant for stainless steel fittings

- 2
- Assemble fitting until wrench tight (without spanner extension)
 - ⚠ Mark position of nut

- 3
- ⚠ Then tighten fitting firmly by $\frac{1}{4}$ turn ($1\frac{1}{2}$ flats)
 - ⚠ Recommended to use spanner extension for sizes over 20 mm O.D. (see chart)
 - ⚠ The body must be hold rigid

Spanner length

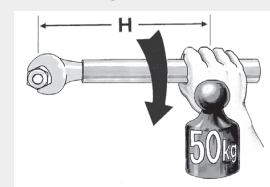

| Size | Spanner length H [mm] |
|-----------|-----------------------|
| 18-L 16-S | 300 |
| 22-L | 400 |
| 28-L 20-S | 500 |
| 35-L 25-S | 900 |
| 42-L 30-S | 1200 |
| 38-S | 1500 |

Fitting assembly

Triple-Lok® / O-Lok® swivels

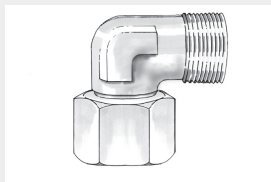
Assembly of Triple-Lok® and O-Lok® swivel nut fittings

e.g.: Triple-Lok®: C6MX, V6MX, R6MX, S6MX, BBMTX
 O-Lok®: C6MLO, V6MLO, S6MLO, R6MLO, AOEL6

- Final assembly of swivel nut fittings must be made in appropriate fittings

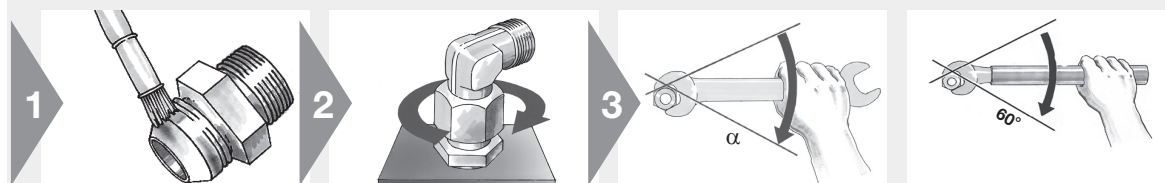

⚠ Threads of stainless steel fittings must be lubricated

- EO-NIROMONT is a special high-performance lubricant for stainless steel fittings

- Screw on nut by hand until handtight

⚠ Then tighten according to chart
 The body must be hold rigid

- one flat = 60°

Assembly torques for O-Lok® and Triple-Lok® swivel nut fittings
O-Lok®

| Size | Metric tube mm | Inch tube inch | Thread UN/UNF | Nm ¹⁾ | FFWR |
|------|----------------|----------------|---------------|------------------|------|
| 4 | 6 | 1/4" | 9/16-18 | 25 | 1/2 |
| 6 | 8 | 5/16" | 11/16-16 | 40 | 1/2 |
| 6 | 10 | 5/16" | 11/16-16 | 55 | 1/2 |
| 8 | 12 | 1/2" | 13/16-16 | 55 | 1/2 |
| 10 | 14, 15, 16 | 5/8" | 1-14 | 115 | 1/2 |
| 12 | 18, 20 | 3/4" | 1 3/16-12 | 130 | 1/2 |
| 16 | 22, 25 | 1" | 1 7/16-12 | 150 | 1/2 |
| 20 | 28, 30, 32 | 1 1/4" | 1 11/16-12 | 190 | 1/2 |
| 24 | 35, 38 | 1 1/2" | 2-12 | 245 | 1/2 |
| 32 | 50 | 2" | 2 1/2-12 | 490 | 1/2 |

Triple-Lok®

| Size | Metric tube mm | Inch tube inch | Thread UN/UNF | Nm ¹⁾ | FFFT |
|------|----------------|----------------|---------------|------------------|-------|
| 4 | 6 | 1/4" | 7/17-20 | 15 | 2 |
| 5 | 8 | 5/16" | 1/2-20 | 20 | 2 |
| 6 | 10 | 3/8" | 9/16-18 | 45 | 1 1/4 |
| 8 | 12 | 1/2" | 3/4-16 | 60 | 1 |
| 10 | 14, 15, 16 | 5/8" | 7/8-14 | 75 | 1 |
| 12 | 18, 20 | 3/4" | 1 1/16-12 | 100 | 1 |
| 16 | 22, 25 | 7/8" | 1 5/16-12 | 150 | 1 |
| 20 | 30, 32 | 1 1/4" | 1 5/8-12 | 180 | 1 |
| 24 | 38 | 1 1/2" | 1 7/8-12 | 200 | 1 |
| 28 | 42 | 1 3/4" | 2 1/4-12 | 220 | 1 |
| 32 | | 2" | 2 1/2-12 | 250 | 1 |

Assembly torques shown in chart are for **non-lubricated carbon steel zinc plated components**.
 For stainless steel fittings, lubricate all mating surfaces and tighten to upper end of torque tolerance.
 Recommended assembly torques are for connections consisting of all Parker manufactured components.

¹⁾ Tolerance of tightening torques max. +10 %

Flanges

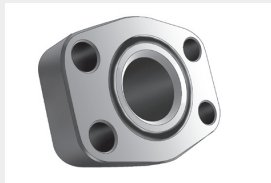

Assembly of flanges

- SAE flange adapters
- SAE 4 bolt flanges
- Gear pump flanges
- ISO 6164 Square flanges

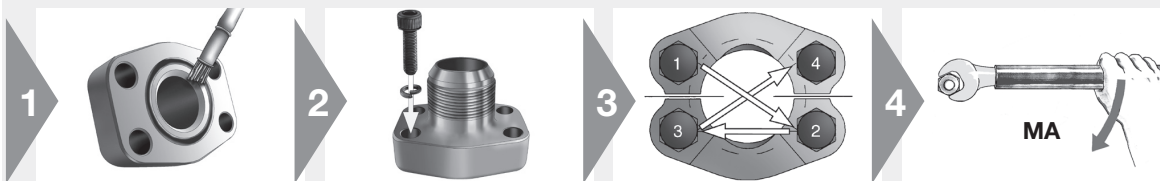

- Make sure sealing surfaces are free of burrs, nicks, scratches or any contamination
- Lubricate the O-ring with system fluid or compatible lubricant
- Parker recommends to lubricate the bolts on contact surface (head) and lower third of thread (MOLYKOTE G-RAPID PLUS) just before use to avoid any contamination

- Position flange or flange adapter with clamp halves
- Placement of the spring washer on the bolt and connect both to the flange (only for gear pump flanges)

- Hand tighten bolts
- Torque bolts in diagonal sequence in small increments to the appropriate torque level listed in chart

- Tighten bolts according to chart

F

Torques for bolts, see page N8!

Fitting assembly

Replacement of an EO Bite type connection

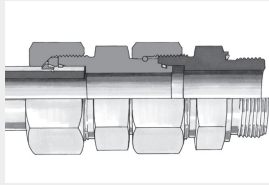
Distance piece adapter DA

- EO distance piece adapters allow replacement of bite type connections on existing pipework easily or retrofitting using EO-2
- The existing tubes can be re-used

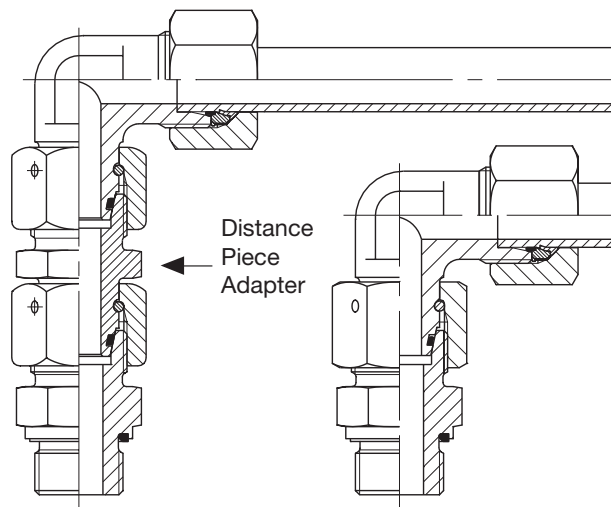

- Use as an extension for stacked assemblies

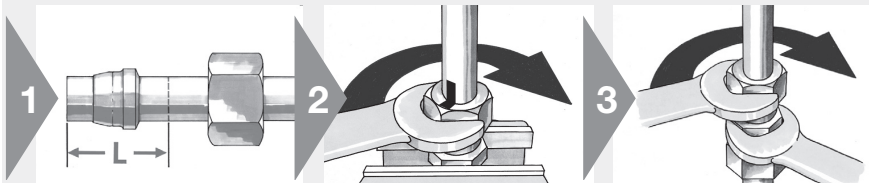

- Cut length L off tube-end (see "DA" chapter I)
 - Scrap obsolete nut

- Assemble new EO-2 functional nut or EO PSR/DPR and nut

- Thread on
 - Then tighten distance piece adapter onto tube-end



The body must be hold rigid

Tube bending

Instructions for EO hand-bending equipment

- For on-site piping jobs
- Not for mass production



BAV 6/12



BAV 6/18



BAV 20/25

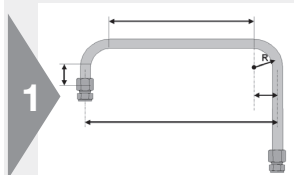

- ⚠ Think the whole process through and plan each individual step before starting
 - ⚠ First bend and then cut ends to length
 - Gather all dimensions like minimum straight lengths, extra length for flaring, bending radius, tube lengths for bows, etc.

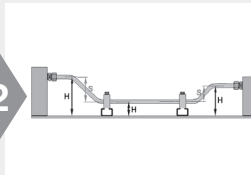

- Consider steps
- Plan for clamping

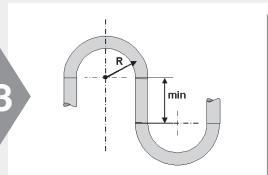

- Check bending equipment specifications for limitations

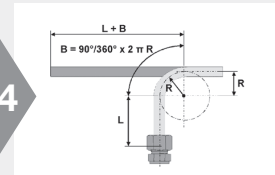

- Start with first elbow
- Leave tube-end longer if in doubt

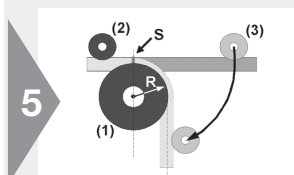

- ⚠ Mark start of bend on tube (S)
 - Adjust tube between bending roll (1), clamping roll (2) and pressure roll (3)
 - Bend tube by pulling lever

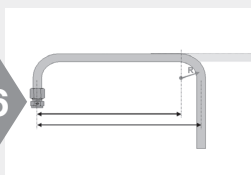

- Check bend angle
- Correct angle if necessary
- Gather all dimensions for next bending operation

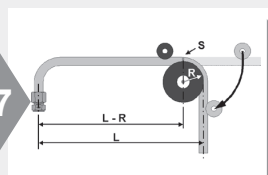

- ⚠ Mark start of bend on tube
 - Continue bending
 - Check and correct each result before starting next bend

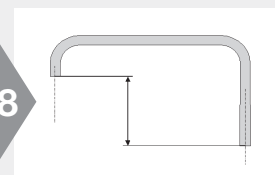

- After the last bend, check tube for angles and dimensions
- Now cut both tube-ends to correct length
- Make sure that tube fits without tension

F

Fitting assembly

Tube line fabrication guide for leak free systems

Every hydraulic, pneumatic and lubrication system requires some form of tube fabrication and fitting installation for completion. Proper fabrication and installation are essential for the overall efficiency, leak free performance, and general appearance of any system.

After sizing the tube lines and selecting the appropriate style of fitting, consider the following in the design of your system:

1. Accessibility of joints
2. Proper routing of lines
3. Adequate tube line supports
4. Available fabricating tools

- Keep tube lines away from components that require regular maintenance:

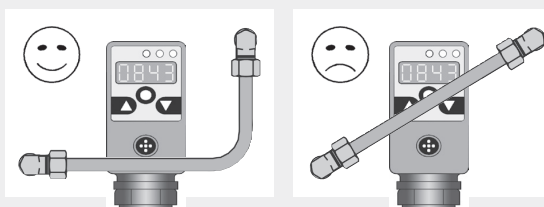

- Right-angled – parallel – clear
- Have a neat appearance and allow for easy trouble-shooting, maintenance and repair:

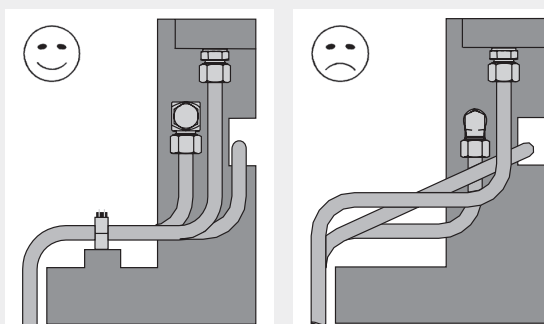

- Example for tube to hose connection:

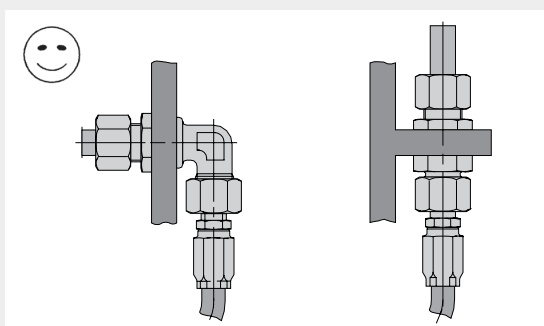

Tube line fabrication guide for leak free systems

- Do not use tube lines to support other tubes
- Always fix tubes onto a rigid point with tube clamps
- Do not use cable channels to support tubes

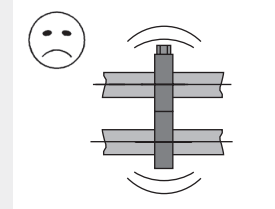
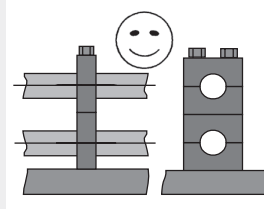

- Use appropriate tube clamps:

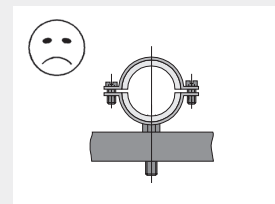
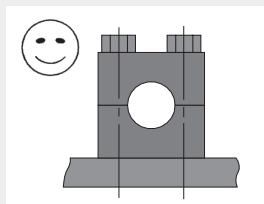

- Avoid excessive strain on joint:
A strained joint will eventually leak

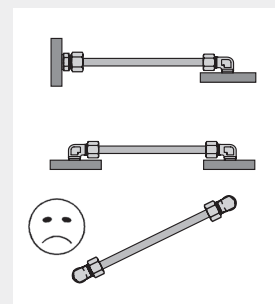
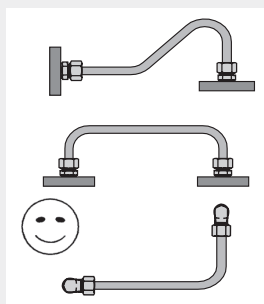

- Allow for expansion effects

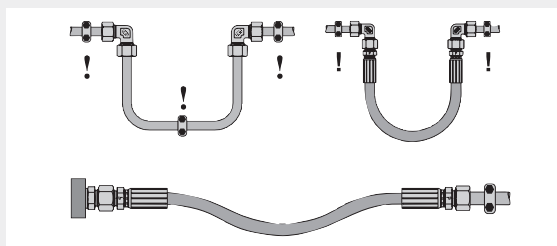

- Avoid short tube length:
⚠ Short tube lengths increase chance of fatigue fractures
- Use adapter GZR or swivel connector for swivel fittings instead of short tube lengths

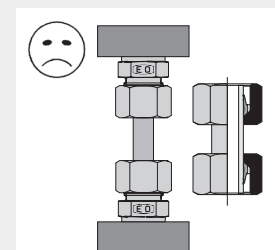
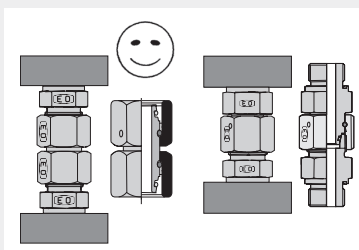

F

Fitting assembly

Tube line fabrication guide for leak free systems

- Support against actuating forces:

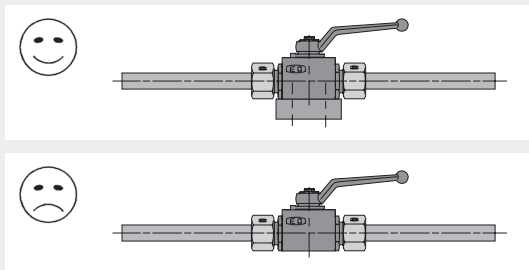
Recommended tools for tube line fabrication:
Cutting:

EO Tube cutting tool AV

EO Combined tube bending and cutting tool BAV

Tube cutters:

Steel: Type Kloskut;

Stainless Steel: Type 635 B-EX,

Type 218 B-SS Tru-Kut Sawing Vice

Deburring:

Parker deburring tool no. 226 DEBURR

Bending:

EO Combined tube bending and cutting tool BAV

EO Tube bending tool BV 6/18, BV 20/25

EO Tube bending tool BVP (programmable)

Tube lines have to be supported in certain distances:

Use sufficient tube clamps to support weight

Use sufficient tube clamps to protect joints from vibration

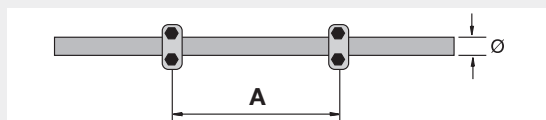

| ∅ [mm] | A [m] |
|---------------|-------|
| 6.0 – 12.7 | 1.0 |
| 12.7 – 22.0 | 1.2 |
| 22.0 – 32.0 | 1.5 |
| 32.0 – 38.0 | 2.0 |
| 38.0 – 57.0 | 2.7 |
| 57.0 – 75.0 | 3.0 |
| 75.0 – 76.1 | 3.5 |
| 76.1 – 88.9 | 3.7 |
| 88.9 – 102.0 | 4.0 |
| 102.0 – 114.0 | 4.5 |
| 114.0 – 168.0 | 5.0 |
| 168.0 – 219.0 | 6.0 |
| 219.0 – 324.0 | 6.7 |
| 324.0 – 356.0 | 7.0 |
| 356.0 – 406.0 | 7.5 |

The clamp pitches corresponding to respective outside pipe diameters are standard for static loads.

Vibration has to be eliminated near by the connectors:

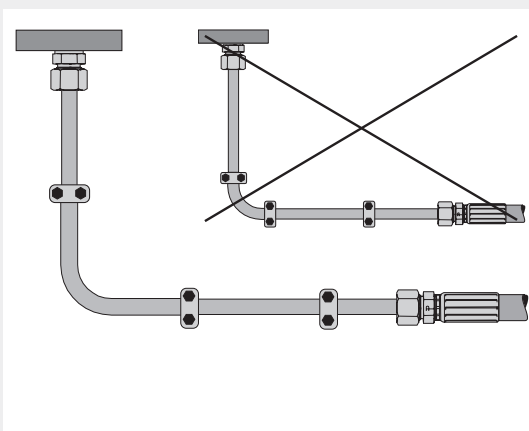

Allow expansion and contraction. Do not hamper expansion and contraction near by tube bends.

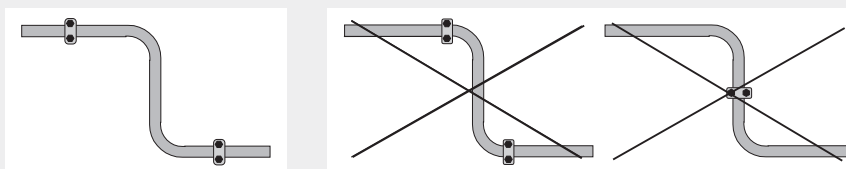



Trouble shooting guide

Trouble shooting

| DPR/PSR Problem | Probable cause | Suggested solution |
|---|---|--|
| Leak | Insufficiently tightened, shallow bite | Tighten the nut according to correct number of turns, direct assembly only for maintenance/repair |
| | | Use correct spanners and spanner extensions especially for larger sizes and stainless steel fittings, use of recommended pre-assembly machines |
| | | Mark nut and body to indicate correct assembly |
| | | Use recommended lubrication |
| | | Use of pre-assembly machines e.g. EO-KARRYMAT, EOMAT ECO, EOMAT UNI |
| | | Pre-assemble joints away from installation to ensure proper bite |
| | | Check visible collar |
| | Tube not bottomed into fitting shoulder | Cut tube to correct length |
| | | Observe min. straight length before tube bend |
| | | Use hacksaw and guide not a plumbing – style tube cutter |
| Carefully deburr tube end – no heavy chamfers | | |
| Push tube firmly into cone | | |
| Check visible collar | | |
| Damaged fitting | Check for damage, replace damaged parts | |
| | Handle all components carefully | |
| Contamination between sealing surfaces | Keep all components clean | |
| Hidden crack | Check for cracks, replace if necessary | |
| Mismatch of components | Select all components according to system application and product specification | |
| | Use genuine Parker components | |
| Phantom leak, from assembly lubricant | Carefully identify proper source of leak | |
| | Don't over use lubricant | |
| Tube fractured behind the nut | Fatigue failure of tube under vibration | Review final tightening process, undertightening reduces vibration resistance |
| | | Stress free installation |
| | | Proper use of clamps |
| | | Bulkhead connection and hose to isolate joints from vibration |
| | | Make sure that operating conditions (pressure, corrosion, temperature, pressure peaks ...) do not exceed fitting performance |
| Crack | Insufficiently tightened, shallow bite | Tighten the nut according to correct number of turns |
| | | Use correct spanners and spanner extensions especially for larger sizes and stainless steel fittings |
| | | Mark nut and body to indicate correct assembly |
| | | Use recommended lubrication |
| | | Pre-assemble joints away from installation to ensure proper bite |
| | | Check visible collar |

Trouble shooting

| DPR/PSR Problem | Probable cause | Suggested solution |
|---|--|---|
| Crack | Severe working conditions | Make sure that operating conditions (pressure, corrosion, temperature, pressure peaks, ...) do not exceed fitting performance |
| Tube blow out | Standpipe fitting, improper final assembly | Use swivel nut fitting |
| | Cold welded threads on stainless steel fittings | Use "EODUR" stainless steel fittings from Parker (with silver plated nut threads) and always lubricate threads with EO Niromont fluid (not hydraulic oil) |
| | Use of worn or unsuitable pre-assembly tools | Check tools regularly and replace worn tools |
| | | Keep tooling clean and oiled plus check cone regularly with "KONU" cone templates every 50 assemblies |
| | Tube not bottomed into fitting shoulder | Cut tube to correct length |
| | | Observe min. straight length before tube bend |
| | | Use hacksaw and guide not a plumbing – style tube cutter |
| | | Carefully deburr tube end – no heavy chamfers |
| | Severe working conditions | Push tube firmly into cone |
| | | Check visible collar |
| Ring installed in wrong direction | Make sure that operating conditions (pressure, corrosion, temperature, pressure peaks, flow rate, ...) do not exceed fitting performance | |
| | Check visible collar | |
| | Install ring in proper orientation | |
| Steel ring used on stainless steel tube | Use pre-assembled fitting or EO-2 | |
| | Always check assembly before final installation | |
| Stainless steel fitting not pre-assembled | Use stainless steel bite rings for stainless steel tube, preassembly necessary | |
| | Pre-assemble joint away from installation | |
| Fitting body used as preassembly tool | Use specified preassembly tools/machines | |
| | Use specified preassembly tools, machine preset preferred | |
| Short tube end fracture | Fatigue failure | Use swivel nut adapter (GZ ...) |



| EO-2 Problem | Probable cause | Suggested solution |
|---|--|--|
| Leak | Insufficiently tightened, shallow bite | Use of pre-assembly machines e.g. EO-KARRYMAT, EOMAT ECO, EOMAT UNI |
| | Insufficiently tightened | Use correct spanners and spanner extensions especially for larger sizes and stainless steel fittings |
| | | Use recommended lubrication |
| | | Pre-assemble joints away from installation to ensure proper bite |
| | | Use original EO pre-assembly tools |
| Tube not bottomed into fitting shoulder | Check closed gap | |
| | Cut tube to correct length | |
| | | Observe min. straight length before tube bend |

Trouble shooting

| EO-2 Problem | Probable cause | Suggested solution |
|--|---|---|
| Leak | Tube not bottomed into fitting shoulder | Use hacksaw and guide not a plumbing – style tube cutter |
| | | Use EO-2 MOK for big sizes |
| | | Carefully deburr tube end – no heavy chamfers |
| | | Push tube firmly into cone |
| | Damaged fitting | Check for damage |
| | | Handle all components carefully |
| | Damage to fitting cone | Make sure tube is bottomed at assembly |
| | Contamination between sealing surfaces | Keep all components clean |
| | Hidden crack | Check for cracks, replace if necessary |
| Mismatch of components | Select all components according to system application and product specification | |
| | Use genuine Parker components | |
| Phantom leak from assembly lubricant | Carefully identify proper source of leak | |
| | Don't over use lubricant | |
| Sealing ring (DOZ) missing | Use plugs for transport of preassembled tubes. Check assembly before final installation | |
| Tube fractured behind the nut | Fatigue failure of tube under vibration | Stress free installation |
| | | Proper use of clamps |
| | | Bulkhead connection and hose to isolate joints from vibration |
| | Severe working conditions | Make sure that operating conditions (pressure, corrosion, temperature, pressure peaks ...) do not exceed fitting performance |
| Crack | Insufficiently tightened | Use correct spanners and spanner extensions especially for larger sizes and stainless steel fittings |
| | | Use recommended lubrication |
| | | Pre-assemble joints away from installation to ensure proper bite |
| | | Use original EO preassembly tools |
| | | Check closed gap |
| Tube blow out | Cold welded threads on stainless steel fittings | Use "EODUR" stainless fittings from Parker (with silver plated nut threads) and always lubricate threads with EO Niromont fluid (not hydraulic oil) |
| | | |
| | Tube not bottomed into fitting shoulder | Cut tube to correct length |
| | | Observe min. straight length before tube bend |
| | | Use hacksaw and guide not a plumbing – style tube cutter |
| | | Carefully deburr tube end – no heavy chamfers |
| | | Push tube firmly into cone |
| | | Use EO-2 MOK for big sizes |
| | Severe working conditions | Make sure that operating conditions (pressure, corrosion, temperature, pressure peaks, flow rate ...) do not exceed fitting performance |
| | Fitting undertightened | Tighten the nut until cap between retaining and sealing ring is closed |
| Use correct spanners and spanner extensions especially for larger sizes and stainless steel fittings | | |

Trouble shooting

| EO-2 Problem | Probable cause | Suggested solution |
|-------------------------|------------------------|---|
| Tube blow out | Fitting undertightened | Mark nut and body to indicate correct assembly Use recommended lubrication Pre-assemble joints away from installation to assure proper bite |
| | FM ... steel is used | Use exclusively FM stainless steel with stainless steel on stainless steel tube, for combination of steel fitting/stainless steel tube use FM ... SSA nut |
| Short tube end fracture | Fatigue failure | Use swivel nut adapter (GZ...) |

| EO-2-FORM Problem | Probable cause | Suggested solution |
|---|--|---|
| Leak | Insufficiently tightened, shallow bite | Use correct spanners and spanner extensions especially for larger sizes and stainless steel fittings |
| | Damaged fitting | Check for damage Handle all components carefully |
| | Damage of fitting cone | Make sure tube is bottomed at assembly |
| | Contamination between sealing surfaces | Keep all components clean |
| | Hidden crack | Check for cracks, replace if necessary |
| | Mismatch of components | Select all components according to system application and product specification Use genuine Parker components |
| | Phantom leak from assembly lubricant | Carefully identify proper source of leak Don't over use lubricant |
| | Sealing ring (DOZ) missing | Use plugs for transport of preassembled tubes. Check assembly before final installation |
| | Incorrect tube forming | Check assembly before installation |
| | | Use correct tool according to tube diameter, wall thickness and material |
| Regularly check tools for wear and damage | | |
| Replace damaged tooling Use specified lubricant LUBSS on forming process | | |
| Misalignment | Stress free installation. Flanged tube end needs contact to stud ends before final tightening. Check length and bends of tubing to ensure this | |
| Crack | Fatigue failure of tube under vibration | Stress free installation Proper use of clamps Bulkhead connection and hose to isolate joints from vibration |
| | | Severe working conditions |



Trouble shooting

| O-Lok® Problem | Probable cause | Suggested solution |
|-------------------------------|--|---|
| Leak | Damaged Trap-Seal | Hold sealing surfaces together until nut is firmly tightened |
| | Missing Trap-Seal | Use genuine Parker O-Lok® fittings with Trap-Seal groove (CORG) |
| | Extruded Trap-Seal | Ensure proper alignment |
| | | Tightened to proper torque |
| | | Use genuine Parker O-Lok® fittings with Trap-Seal groove (CORG) |
| | Pinched Trap-Seal due to air bleeding | Use bleed valves (PNLOBA/FNLBA) or test points EMA and hose for bleeding |
| | Phantom leak from assembly lubricant | Carefully identify proper source of leak |
| | | Don't over use lubricant |
| | Uvertightening | Use correct spanners and spanner extensions especially for larger sizes and stainless steel fittings. Use recommended torque or FFFT method |
| Damaged fitting | Check for damage | |
| | Handle all components carefully | |
| | Poor surface quality of flange | Spiral marks can be avoided by proper deburring of tubes, particular the tube I.D. Clean tools, remove metal particles from pin |
| Hidden crack | Check for cracks, replace if necessary | |
| Tube fractured behind the nut | Fatigue failure of tube under vibration | Stress free installation |
| | | Proper use of clamps |
| | | Bulkhead connection and hose to isolate joints from vibration |
| Severe working conditions | Make sure that operating conditions (pressure, corrosion, temperature, pressure peaks ...) do not exceed fitting performance | |
| Crack | Fatigue failure of tube under vibration | Stress free installation |
| | | Proper use of clamps |
| | | Bulkhead connection and hose to isolate joints from vibration |
| | Severe working conditions | Make sure that operating conditions (pressure, corrosion, temperature, pressure peaks ...) do not exceed fitting performance |

| Triple-Lok® Problem | Probable cause | Suggested solution |
|--------------------------------------|--|---|
| Leak | Damaged fitting | Check for damage |
| | | Handle all components carefully |
| | Contamination between sealing surfaces | Keep all components clean |
| | Hidden crack | Check for cracks, replace if necessary |
| | Mismatch of components | Select all components according to system application and product specification |
| | | Use genuine Parker components |
| Phantom leak from assembly lubricant | Carefully identify proper source of leak | |
| | Don't over use lubricant | |

Trouble shooting

| Triple-Lok® Problem | Probable cause | Suggested solution |
|--------------------------------|---|---|
| Leak | Undertightening | Use correct spanners and spanner extensions especially for larger sizes and stainless steel fittings. Use recommended torque or FFFT method |
| | Scratches in Tube ID and flare area | Use Parflange process to improve surface quality |
| Tube fractured behind the nut | Fatigue failure of tube under vibration | Stress free installation |
| | | Proper use of clamps |
| Crack | Fatigue failure of tube under vibration | Bulkhead connection and hose to isolate joints from vibration |
| | | Stress free installation |
| | | Proper use of clamps |
| | Severe working conditions | Make sure that operating conditions (pressure, corrosion, temperature, pressure peaks ...) do not exceed fitting performance |



| Weld nipples Problem | Probable cause | Suggested solution |
|---------------------------------|--|--|
| Leak | Misalignment | Stress free installation |
| | | Fix weld nipple to tube in application before finishing the welding |
| | Damaged O-ring | Inspect O-ring before final installation. Make sure that O-ring is not twisted at installation lubricate O-ring |
| | Missing O-ring | Assemble proper O-ring |
| | Extruded O-ring | Ensure proper alignment |
| | Pinched O-ring due to air bleeding | Use bleed valves (PNLOBA/FNLBA) or test points EMA and hose for bleeding |
| | Phantom leak from assembly lubricant | Carefully identify proper source of leak |
| | | Don't over use lubricant |
| Undertightening | Use correct spanners and spanner extensions especially for larger sizes and stainless steel fittings | |
| Tube fractured behind the nut | Fatigue failure of tube under vibration | Check for damage |
| | | Handle all components carefully |
| | Severe working conditions | Make sure that operating conditions (pressure, corrosion, temperature, pressure peaks ...) do not exceed fitting performance |
| Crack | Fatigue failure of tube under vibration | Stress free installation |
| | | Proper use of clamps |
| | | Bulkhead connection and hose to isolate joints from vibration |
| | Severe working conditions | Make sure that operating conditions (pressure, corrosion, temperature, pressure peaks ...) do not exceed fitting performance |

Trouble shooting

| Flanges connection Problem | Probable cause | Suggested solution | |
|-----------------------------------|---|--|--|
| Leak | Misalignment | Stress free installation | |
| | Damaged O-ring | Inspect O-ring before final installation. Make sure that O-ring is not twisted at installation lubricate O-ring | |
| | Missing O-ring | Assemble proper O-ring | |
| | Extruded O-ring | | Ensure proper alignment |
| | | | Tightened bolts to recommended torque |
| | Pinched O-ring due to air bleeding | Use bleed valves (PNLOBA/FNLBA) or test points EMA and hose for bleeding | |
| | Phantom leak from assembly lubricant | | Carefully identify proper source of leak |
| | | | Don't over use lubricant |
| | Undertightening | Use correct spanners and spanner extensions especially for larger sizes and stainless steel fittings | |
| Tube fractured behind the nut | Fatigue failure of tube under vibration | Stress free installation | |
| | | Proper use of clamps | |
| | | Bulkhead connection and hose to isolate joints from vibration | |
| | Severe working conditions | Make sure that operating conditions (pressure, corrosion, temperature, pressure peaks ...) do not exceed fitting performance | |
| Crack | Fatigue failure of tube under vibration | Stress free installation | |
| | | Proper use of clamps | |
| | | Bulkhead connection and hose to isolate joints from vibration | |
| | | Severe working conditions | Make sure that operating conditions (pressure, corrosion, temperature, pressure peaks ...) do not exceed fitting performance |

| Leaks from ports Problem | Probable cause | Suggested solution | |
|---------------------------------------|---|--|--|
| Leak | O-ring sealing is missing/damaged | Replace with new O-ring | |
| | Fitting not tightened properly, Undertightening | | Retighten to appropriate specification |
| | | | Use correct spanners and spanner extensions especially for larger sizes and stainless steel fittings |
| | Undertightened at initial assembly | | Use recommended lubrication |
| | | | |
| | Adjustable stud not assembled properly | | Repeat with appropriate assembly torque |
| | O-ring pinched | | Proper assembly procedure |
| | Fitting vibrates loose | | Redesign system |
| | | | Clamping/Check the assembly torque |
| Threads damaged | | Stressed joints | |
| Use of tapered threads (NPT/BSPT/+++) | | Replace fitting | |
| | | Use fittings with soft sealing O-ring/ED sealing | |

Trouble shooting

| Leaks from ports Problem | Probable cause | Suggested solution |
|-----------------------------|--|--|
| Leak | Port stud end Form B | Sealing edge Form B is damaged replace fitting |
| | Sealing surface is damaged | Rework sealing surface |
| Fitting vibrates loose | Undertightened at initial assembly | Tighten the nut according to correct torque |
| | | Use correct spanners and spanner extensions especially for larger sizes and stainless steel fittings |
| | Torsion forces on assembly | Use clamps or bulkhead fittings to isolate twisting hose Avoid stress at initial assembly |
| Fractured stud | Severe overtightening | Do not exceed specified tightening instructions |
| | Fatigue failure of tube under vibration | Stress free installation |
| | | Proper use of clamps |
| | | Bulkhead connection and hose to isolate joints from vibration |
| Severe working conditions | Make sure that operating conditions (pressure, corrosion, temperature, pressure peaks ...) do not exceed fitting performance | |



| Triple-Lok® 1025/50 Problem | Probable cause | Suggested solution |
|--|-------------------------------------|---|
| Tube slips in die during flanging or flaring | Tube undersized | Use tube within tolerance |
| | Die grip surface dirty | Clean with solvent |
| | Die grip surface worn | (do not use any wire brush) Replace Die |
| Flange/flare diameter too small | Tube slipped in die | See problem "Tube slips in die..." |
| | Incorrect pin | Use correct pin for tube size |
| | Die needs adjustment/incorrect die. | Contact Parker Rep./Use correct die |
| | Tube was not inserted to tube stop | Insert tube to tube stop |
| Flange/flare diameter too large | Tube forced against tube stop | Do not force tube against tube stop |
| | Die needs adjustment/incorrect die | Contact Parker Rep./Use correct die |
| | Incorrect pin and/or tube wall | Use correct pin for tube size |
| Flange/flare out of round | Tube not cut squarely | Cut tube squarely, within $\pm 1^\circ$ |
| | Tube not supported properly | Support tube in line with dies |
| | Obstruction in die holder | Clean and remove debris |
| | Tube wall thickness varies | Use good quality tube |
| | Incorrect pin and/or tube wall | Use correct pin for tube size |
| Cracked flange/flare | Poor tube quality | Use recommended quality tube |
| | Too hard tube | Use recommended quality tube |
| | Heavy chatter during deburring | Eliminate chatter in deburring |
| Scored, pitted flange/ flare surface | Improper/lack of lubrication on pin | Use recommended lubricant |
| | Tube not properly deburred | Deburr and remove filings |
| | Tube not properly cleaned | Clean to remove filings |
| | Pin not cleaned | Keep pin clean but lubricated |

Trouble shooting

| O-Lok® 1025/50 Problem | Probable cause | Suggested solution |
|-------------------------------------|---|---|
| Flange/flare diameter too large | Tube forced against tube stop | Do not force tube against Tube stop |
| | Die needs adjustment/ | Contact Parker |
| | Incorrect die | Use correct die |
| | Incorrect pin and/or tube wall | Use correct pin for tube size |
| | Sleeve not located properly in die | Locate sleeve in die cavity correctly |
| Flange/flare not round | Tube not cut squarely | Cut tube squarely, within $\pm 1^\circ$ |
| | Tube not supported properly | Support tube in line with dies |
| | Obstruction in die holder | Clean and remove debris |
| | Tube wall thickness varies | Use good quality tube |
| | Incorrect pin and/or tube wall | Use correct pin for tube size |
| Cracked flange/flare | Poor tube quality | Use recommended quality tube |
| | Tube too hard | Use recommended quality tube |
| | Heavy chatter during deburring | Eliminate chatter in deburring |
| Scored, pitted flange/flare surface | Improper/lack of lubrication on pin | Use recommended lubricant |
| | Tube not properly deburred | Deburr tube and remove filings |
| | Tube not properly cleaned | Clean tube to remove filings |
| | Pin not cleaned | Keep pin clean and lubricated |
| Flange pin breaks during flanging | Incorrect pin and/or tube wall/ or wrong pin for tube material | Use correct pin for tube size/material |





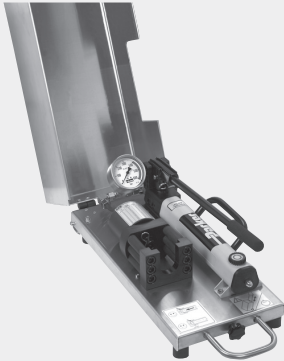







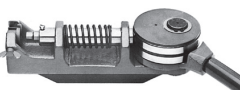





Assembly tooling

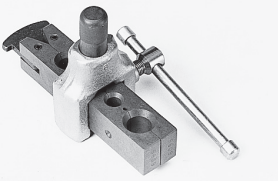
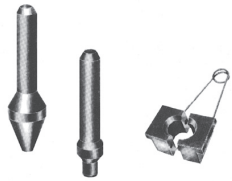













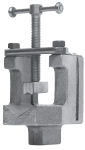

Assembly tooling

Index

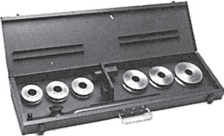
| | | | |
|--|---|--|--|
| <p>Manual assembly tools for EO/EO-2</p> |  <p>VOMO p. H5</p> |  <p>KONU p. H6</p> |  <p>AKL p. H7</p> |
| <p>Manual assembly devices</p> |  <p>HVM-B p. H9</p> |  <p>EO-KARRYMAT p. H11</p> | |
| <p>Assembly machines for EO/EO-2, Triple-Lok®</p> |  <p>EOMAT ECO p. H13</p> |  <p>EOMAT UNI p. H15</p> |  <p>EOMAT PRO p. H21</p> |
| <p>Forming machines for EO2-FORM, EO-3®</p> |  <p>EO2-FORM F3 p. H24</p> |  <p>EO2-FORM PRO22 p. H24</p> |  <p>EO-KARRYFORM p. H25</p> |
| <p>Flaring tools for Triple-Lok®</p> |  <p>1004/210A p. H32</p> |  <p>Impact flarer p. H33</p> |  <p>KARRYFLARE p. H34</p> |
| <p>Parflange® Machines for O-Lok®/Triple-Lok®</p> |  <p>Parflare ECO p. H35</p> |  <p>Parflange® 1025 p. H39</p> |  <p>Parflange® 50 p. H41</p>  <p>Parflange® 50 PRO p. H43</p> |

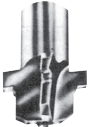
Assembly tooling

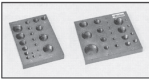
Index

| | | | |
|---|---|--|--|
| Lubricants |  <p>EO-NIROMONT p. H49</p> |  <p>LUBSS p. H49</p> | |
| Cutting, bending and deburring tools |  <p>AV 6/42 p. H50</p> |  <p>BAV 6/12 p. H51</p> |  <p>IN-EX 226 p. H51</p> |
| Tube bending tools |  <p>BV 6/18 p. H52</p> |  <p>BV 20/25 p. H53</p> | |
| Hand-tools |  <p>Par-Lok wrench p. H54</p> |  <p>WZK - Tool box p. H55</p> | |
| O-Ring assembly tools for O-Lok® |  <p>O-Lok® CORG p. H56</p> |  <p>O-Ring Pick p. H56</p> | |
| Port manufacturing tools |  <p>Counterbore p. H57</p> |  <p>Thread taps p. H57</p> | |
| Thread identification |  <p>Thread ID kit p. H59</p> |  <p>Portboard p. H59</p> |  <p>Sample case p. H60</p> |



Assembly tooling

Parker tube fabricating equipment

Equipment described in this section is designed to make strong, accurate tubing systems easier and more dependable. Every time you make up a tubing circuit, you want to be sure you get strong dependable joints, accurate kink-free bends and a neat system that will stand up to years of hard service. You want to fabricate the system with the least effort and risk of errors.

Parker tube fabricating equipment is designed to help you get all these benefits. Parker has been leading the way in use of tubing and in fittings design for over 60 years. All this experience has shown Parker engineers a host of ways to make tube fabricating equipment more efficient and trouble free. You'll find them all in the equipment featured here – from improvements that help you make accurate concentric flares, to bender designs that make kink-free bending easier. They'll all help you get better tubing systems with less work and less risk of mistakes in fabrication.

Machine selection

Parker offers a variety of assembly devices and machines for different products and different applications. Refer to overview in chapter E for machine recommendation.

Disposal of old equipment

The HPCE electrically driven assembly machines are large stationary industrial tools within the meaning of the Electrical and Electronic Equipment Act (EC Directive 2002/96/EC/“WEEE Directive”). This equipment is not usually used in private households but in industry. Within the scope of the Electrical Act, industrial users are responsible for the professional disposal of old equipment.

Service

Assembly machines and standard tooling for HPCE connectors are available from stock for immediate service. Both purchasing and leasing are possible depending on machine type and volume of business. For limited projects, assembly equipment can be provided on a rental basis via our certified distributor network. Special “demo”-equipment is available for sales presentations and fairs.

Technical support

HPCE machine service procedures ensure that reliable machine function and fitting performance is achieved when using genuine Parker assembly equipment. All machines come with detailed operating manuals. Parker distributors and sales representatives are trained to give advice on operation and application. Experienced application engineers at HPCE are available when it comes to special application of HPCE assembly equipment. In case of machine malfunction, spare machines can be provided on short notice so that production can continue. In the meantime, damaged machinery is checked and repaired at the HPCE machine repair facility. Well trained and experienced engineers take personal care that the

machines return properly repaired and tested. HPCE also offers a machine maintenance and calibration service. Standard spare parts like oil filters can be ordered from stock.

Repair procedure

Please contact your Parker Service Center for problem solving/repair. Your correspondent will organise the repair and arrange a spare machine if required. Please do not send in machines without notice to your sales correspondent. To assure optimum service, all machine shipments must include a documentation with information about: Machine type, serial number, purchase data, problem description, contact name, phone number and complete address for return.



Experienced engineers support proper operation of HPCE assembly machinery

Tool lifetime

Assembly tools are subject of wear and must be regularly (max. 50 assemblies) cleaned and checked (Checking instructions see chapter E). Worn out tools can cause dangerous assembly failures and must be replaced in time. Maximum lifetime can be achieved by following factors:

- Regular cleaning and checking
- Clean and corrosion-protected storage
- Proper de-burring and cleaning of tube end
- Proper tool selection and operation
- Use of specified lubricant

Manual assembly tools for EO/EO-2

VOMO – Pre-assembly tools for EO/EO-2 tube connections

Simple but essential tool for the manual presetting of EO-fittings.

The use of a VOMO assures that the bite ring securely cuts into the tube without damage on the inner fitting cone.

Pre-assembly using VOMO or EOMAT must be done for all connections of:

- EO-2 with large tube dimensions (Tube O.D. 30 mm and above)
- EO-Progressive Stop Ring/Progressive Ring with stainless steel tube or standpipe fittings (E.g.: “BE”-type hose fitting).

For proper use, see EO assembly instructions. VOMO tools wear out and then may cause assembly failures. VOMO’s must be checked regularly with “KONU” cone-templates (max. after 50 assemblies) and replaced when damaged or worn out.

Specifications:

Material: hardened tool steel

Sizes: 4 LL – 12 LL,
6 L – 42 L,
6 S – 38 S

Pre-assembly of: EO-2 and Progressive Stop Ring PSR/EO progressive Ring DPR

Economic production qty: Max. 10 assemblies per day.

Features, advantages and benefits of pre-assembly tools:

1. **Marking notch** – A special ridge engraves a circular mark onto the tube end to verify that it was properly bottomed at assembly. Failures caused by improper tube cutting or bottoming in VOMO can be recognised before final installation.
2. **Flexible** – A VOMO can be used anywhere to assure safe fitting assembly – even at assembly sites where EOMAT machines are not available.
3. **Safe** – Hazardous blowout of incorrect assembled standpipe hose fittings or stainless steel tube can be avoided by VOMO-assembly.



4. **Efficient** – There is no doubt that VOMO-presetting contributes to save time and effort in bite-type assembly. The small investment pays back immediately.
5. **Special** – VOMO tools are specifically designed and manufactured to match EO-fitting standards.
6. **Tool lifetime** – Assembly tools are subject of wear and must be regularly (max. 50 assemblies) cleaned and checked (Checking instructions see chapter E). Worn out tools can cause dangerous assembly failures and must be replaced in time. Maximum lifetime can be achieved by following factors:
 - Regular cleaning and checking
 - Clean and corrosion-protected storage
 - Proper de-burring and cleaning of tube end
 - Proper tool selection and operation
 - Use of specified lubricant



| Series | Tube O.D. mm | Pre-assembly tools Order code | Cone-templates Order code |
|--------|--------------|-------------------------------|---------------------------|
| LL | 04 | VOMO04LLX | KONU04LL |
| | 06 | VOMO06LLX | KONU06LL |
| | 08 | VOMO08LLX | KONU08LL |
| | 10 | VOMO10LLX | KONU10LL |
| | 12 | VOMO12LLX | KONU12LL |
| L | 06 | VOMO06LX | KONU06L ¹⁾ |
| | 08 | VOMO08LX | KONU08L ¹⁾ |
| | 10 | VOMO10LX | KONU10L ¹⁾ |
| | 12 | VOMO12LX | KONU12L ¹⁾ |
| | 15 | VOMO15LX | KONU15L |
| | 18 | VOMO18LX | KONU18L |
| | 22 | VOMO22LX | KONU22L |
| | 28 | VOMO28LX | KONU28L |
| | 35 | VOMO35LX | KONU35L |
| | 42 | VOMO42LX | KONU42L |
| S | 06 | VOMO06SX | KONU06L ¹⁾ |
| | 08 | VOMO08SX | KONU08L ¹⁾ |
| | 10 | VOMO10SX | KONU10L ¹⁾ |
| | 12 | VOMO12SX | KONU12L ¹⁾ |
| | 14 | VOMO14SX | KONU14S |
| | 16 | VOMO16SX | KONU16S |
| | 20 | VOMO20SX | KONU20S |
| | 25 | VOMO25SX | KONU25S |
| | 30 | VOMO30SX | KONU30S |
| | 38 | VOMO38SX | KONU38S |

1) Cone-templates for tube O.D.6 to 12 mm are identical in series L and S.

Assembly tooling

KONU – Cone-template for tools VOMO/MOK/MOSI

Cone-templates are essential for monitoring wear on pre-assembly tools like VOMO, MOK or MOS.

KONU must be regularly used to prevent fitting failures caused by worn out or damaged tools (DIN 3859-2: max. each 50th assembly).

For proper use see EO assembly instructions, Chapter E.

Specifications:

Material: hardened tool steel

Sizes: 4 LL – 12 LL,
6 L – 42 L,
6 S – 38 S
(Sizes 6 L – 12 L
are identical to 6 S – 12 S)



Features, advantages and benefits of cone-templates:

- Special** – KONU are high precision cone-templates specifically designed and manufactured to match EO standards.
- Maintenance tool** – A leaking fitting can be easily checked and replaced if worn-out.

| Tube O.D. mm | Cone gauges Order code |
|--------------|------------------------|
| 04-LL | KONU04LL |
| 06-LL | KONU06LL |
| 08-LL | KONU08LL |
| 10-LL | KONU10LL |
| 12-LL | KONU12LL |
| 06-L | KONU06L ¹⁾ |
| 08-L | KONU08L ¹⁾ |
| 10-L | KONU10L ¹⁾ |
| 12-L | KONU12L ¹⁾ |
| 15-L | KONU15L |
| 18-L | KONU18L |
| 22-L | KONU22L |
| 28-L | KONU28L |
| 35-L | KONU35L |
| 42-L | KONU42L |
| 06-S | KONU06S ¹⁾ |
| 08-S | KONU08S ¹⁾ |
| 10-S | KONU10S ¹⁾ |
| 12-S | KONU12S ¹⁾ |
| 14-S | KONU14S |
| 16-S | KONU16S |
| 20-S | KONU20S |
| 25-S | KONU25S |
| 30-S | KONU30S |
| 38-S | KONU38S |

¹⁾ Cone-templates for tube o.d. 6 to 12 are identical in series L and S.

Selection guide: Checking equipment for EO assembly

Performance of EO tube connections is depending on perfect condition of pre-assembly tools and proper assembly process.

Cone-templates KONU for monitoring MOK/VOMO tool wear and AKL gauges for checking result of PSR preassembly are available.

KONU – Cone-template for EO pre-assembly tools

Limitations

Cone-template KONU detect wear and deformation of pre-assembly tools like VOMO, MOK or MOS. But it does not indicate failures on completed assemblies.

Cone-template KONU will not detect all possible failures of pre-assembly tools. Pre-assembly tools must be scrapped when they show visual wear or cracks, even if KONU check is OK.

| | KONU | AKL |
|--|---|--|
| | | |
| Function | Checking of preassembly tools | Checking of PSR assemblies |
| Will detect: Deformed MOK/VOMO | Yes, compared to template | Yes, if relevant for PSR performance |
| Will detect: Visual damage and cracks of MOK/VOMO | No | Yes, if relevant for PSR performance |
| Will detect: Assembly failures like: tube end not bottomed, underassembly of PSR | No | Yes, if relevant for PSR performance |
| Will detect: Insufficient bite of PSR | No Visual check required | No Visual check required |
| Application | Expert template for trained and experienced engineers in workshop | Gauge for production of PSR assemblies |

Application

KONU is expert tooling for trained and experienced engineers. For practical

monitoring of assembly result in production, distance gauge AKL are recommended.

Distance Gauge for Assembly AKL



Distance Gauges AKL

Distance gauges AKL are suitable for checking the pre-assembly result of Progressive Rings PSR. They are used on pre-assembled tubes before final installation. The green LED lights up, when none of the following failures is detected:

- Excessive wear of preassembly tools MOK
- Excessive assembly force / pressure setting
- Tube end by far not bottomed in assembly tool MOK.

Therefore, assembly check by cone-template KONU can be void. Use of distance gauges AKL does not replace the check of the bite (visible collar in front of Progressive Ring).

Specification

| | |
|------------------|--|
| Function: | Distance gauge with LED indication |
| For checking of: | Machine pre-assembly of Parker EO Progressive Ring PSR |
| Series: | LL/L/S |
| Tube-OD: | 4–38/42 mm |
| Dimensions: | Length: approx. 130–160 mm Front diameter: approx. 30–52 mm |
| Power: | 2 × Battery AA – Mignon – LR6 (included) |
| Scope of supply: | Distance gauge with LED indication, batteries, master piece and instructions in a plastic case |

Ordering

| Size | Order code | Size | Order code | Size | Order code |
|--------|------------|------|------------|------|------------|
| 04-LL | AKL04LL | 10-L | AKL10L | 10-S | AKL10S |
| 06-LL | AKL06LL | 12-L | AKL12L | 12-S | AKL12S |
| 08-LL | AKL08LL | 15-L | AKL15L | 14-S | AKL14S |
| 10-LL | AKL10LL | 18-L | AKL18L | 16-S | AKL16S |
| 12-LL | AKL12LL | 22-L | AKL22L | 20-S | AKL20S |
| 06-L/S | AKL06LS | 28-L | AKL28L | 25-S | AKL25S |
| 08-L/S | AKL08LS | 35-L | AKL35L | 30-S | AKL30S |
| | | 42-L | AKL42L | 38-S | AKL38S |

Features, Advantages & Benefits of distance gauge AKL

1. Clear – In contrast to the visual evaluation, the simple good/bad decision is obvious, even for less experienced operators.
2. Economical – The distance gauges AKL are fast in application. The production process is not slowed down noticeably compared with other testing methods.
3. Result-oriented – In the comparison to examining the tools with the AKL teachings the assembly result is examined. Thus also the failure opportunity “Tube by far not bottomed” is detected.
4. Practical – The gauges are light, handy, easy, and can be fastened with an eye. Standard batteries are used, so that a long life span is reached.
5. Safe – The measuring head consists of high-grade steel and is not adjustable or detachable. A master piece for regular functional testing is shipped with each AKL gauge.
6. Innovative – For customers of prefabricated hydraulic tubes, so far it was not easy to inspect the assembly quality of incoming goods. Thus incorrect assemblies, which are caused by use of worn pre-assembly tools, remained often undiscovered. With the distance gauges AKL an efficient and effective inspection of incoming goods can be accomplished, allowing pro-active quality management together with the tube supplier.

Limitations

- Distance gauges AKL are suitable only for the inspection of machine pre-assembly. After final tightening of the connection, a failure might be indicated, even if the Progressive Ring was properly assembled by the pre-assembly machine.
- Distance gauges AKL are designed for the use with Progressive Rings PSR. Parker does not take responsibility for the function with other bite type fittings. Distance gauges AKL are not suitable for

checking EO-2 and EO2-FORM connections.

- Use of distance gauges AKL does not replace the check of the bite (visible collar in front of Progressive Ring).

Function

Distance gauges AKL are suitable for checking the effect of worn tools on pre-assembly result of Progressive Rings PSR. They are used on pre-assembled tubes before final installation. The distance gauges AKL particularly detects the position of the Progressive Ring PSR in relation to the tube end. Shining of the green LED indicates that the assembly cone can be further used. Flicker of the green LED is quite possible, since the installed tube in the gauge can have some clearance. If the wear of the assembly tool reaches 0,1 mm on the cone, the LED shines no longer and indicates that the tool is worn. These defective tube assemblies must not be installed and the worn assembly tool must be replaced. The inspection has to take place regularly, at the latest after 50 assemblies. Then, assembly tool check by cone-template KONU can be void.

Operation

- Shining of the green LED indicates that the assembly cone can be further used
- If the LED doesn't shine, the assembly must not be used

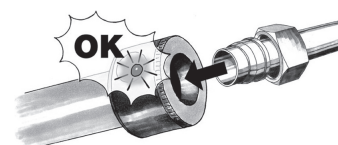

Applications

- Mass production of hydraulic tube assemblies for mobile hydraulics, automotive and agricultural vehicles
- Commercial tube manipulators for hydraulic tube assemblies
- Inspection of incoming tube assemblies at the final installation plant

Assembly tooling

Manual assembly devices for EO/EO-2 tube connections

Machine selection guide

Manual assembly devices are available to reduce assembly time and effort. High assembly quality and consistency assures reliable fitting performance. EO assembly devices are manually operated and do not need any external power supply.

Due to the low weight, easy handling and simple but reliable design, the EO assembly devices are the ideal tool for tube preparation of small quantities.

For efficient mass production, manual devices are not suitable, therefore EOMAT machines are recommended.



Features, advantages and benefits

1. **Flexible** – Manual assembly devices are portable and do not need any power supply. Therefore they are ideal for on-site tube assembly, repair and plant maintenance.
2. **Economic** – Manual assembly devices close the gap in between manual fitting pre-assembly in a vice and the EOMAT technology. The devices contribute to save time and effort in bite type assembly. The little investment pays back immediately.
3. **Controlled assembly** – After pre-assembly, the tube joint can be easily inspected before final installation. Therefore, this manda-

tory step in fitting assembly is less likely to be forgotten.

4. **Special** – Each device has been especially developed for the efficient use in a certain application. The HVM-B is a handy tool for the quick pre-assembly of EO Progressive rings onto soft steel tube. The EO-KARRYMAT is a real problem solver when it comes to on-site assembly of medium to large EO-Progressive rings and EO-2 fittings onto steel and stainless steel tube.

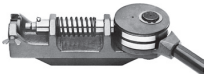
How to select the ideal assembly device for your application:

| | HVM-B | EO-KARRYMAT |
|---|---|---|
| |  |  |
| Assembly method EO-2: PSR/DPR/D: Triple-Lok®: | not suitable Stroke controlled not suitable | Pressure controlled Pressure controlled not suitable |
| Tube specification Material: Outside diameter/mm: Min. U-bend: Wall thickness: | Steel 4–15 mm 25 mm no limitation | Steel, Stainless Steel 6–42 mm 66 mm no limitation |
| Tool specification | Special assembly cones MOSI and plates HL | Standard assembly cones MOK and plates GHP |
| Operation drive | Lever with eccentric cam | Handpump |
| Process control | Assembly stroke determined by tool geometry | Pressure control according to selection chart |
| Preassembly is equal to EO-2: PSR: D/DPR: | – 1 turn 1 turn | Gap closed 1½ turn 1¼ turn |
| Performance Overall cycle time: Economic production quantity: | 10 secs. max. 20 assemblies per day | 30–60 secs. max. 50 assemblies per day |
| Application | Simple tool for quick pre-assembly of small dimension EO-Progressive rings onto steel tubes | Most efficient for one-site assembly of medium to large DPR- and EO-2 connections onto any suitable tube material. Repair jobs and hydraulic services |

HVM-B Pre-assembly tool

This pre-installation tool is a simple tool for a quick and safe pre-assembly of EO-Progressive Stop Ring/Progressive ring. The tool is very handy and can be used at any site provided a vice is available. Suitable for LL, L and S series and tube sizes from 4 to 15 mm O.D.

Attention:

- ⚠ **Not suitable for EO-2 assembly.**
- ⚠ **Not suitable for stainless steel progressive ring assembly.**
- ⚠ **Final assembly of ½ turn in fitting body required.**
- ⚠ **Not suitable for tube OD larger 15 mm**

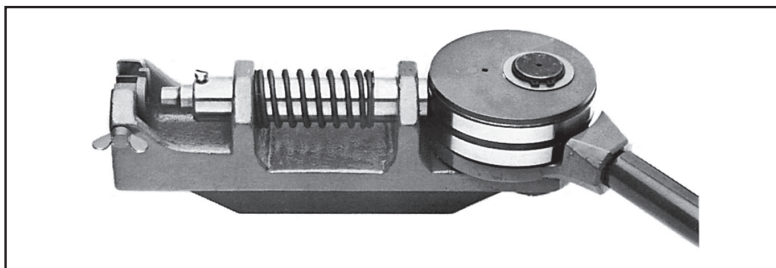

| Type | Order code |
|---|------------|
| HVM-B pre-assembly tool device for mount in vice, without tools | HVMBKPLX |

Specifications:

For pre-assembly of: EO Progressive Stop Ring (PSR)/Progressive Ring (DPR)

Pre-assembly equals: 1 turn of nut

For assembly check and fitting installation see assembly instructions chapter E.

Tube O.D.: 4 to 15 mm

Min. U-bend: 25 mm

Series: LL, L and S

Tube and

fitting material: Steel

Weight: approx. 7.0 kg (without tools)

Economic production quantity: max. 20 ass./day

Features, advantages and benefits of pre-assembly tool:

1. **Special** – HVM-B is designed and manufactured to match EO-DPR standards.
2. **Vice mounted** – For easy workshop use, the HVM-B can be clamped into any vice.
3. **Flexible** – A HVM-B can be used anywhere to assure safe fitting assembly – even at assembly sites where EOMAT technology is not available.
4. **Efficient** – There is no doubt that HVM-B-presetting contributes to save time and effort in bite-type assembly. The small investment pays back immediately.

| Series | Tube O.D. mm | Tube location plate Order code | Assembly cone Order code | Cone-template Order code |
|--------|--------------|--------------------------------|--------------------------|--------------------------|
| LL | 4 | HL04X | MOSI04LLX | KONU04LL |
| | 6 | HL06X | MOSI06LLX | KONU06LL |
| | 8 | HL08X | MOSI08LLX | KONU08LL |
| | 10 | HL10X | MOSI10LLX | KONU10LL |
| | 12 | HL12X | MOSI12LLX | KONU12LL |
| L | 6 | HL06X | MOSI06LX | KONU06L ¹⁾ |
| | 8 | HL08X | MOSI08LX | KONU08L ¹⁾ |
| | 10 | HL10X | MOSI10LX | KONU10L ¹⁾ |
| | 12 | HL12X | MOSI12LX | KONU12L ¹⁾ |
| | 15 | HL15X | MOSI15LX | KONU15L |
| S | 6 | HL06X | MOSI06SX | KONU06L ¹⁾ |
| | 8 | HL08X | MOSI08SX | KONU08L ¹⁾ |
| | 10 | HL10X | MOSI10SX | KONU10L ¹⁾ |
| | 12 | HL12X | MOSI12SX | KONU12L ¹⁾ |
| | 14 | HL14X | MOSI14SX | KONU14S |

1) Cone-templates for tube o.d. 6 to 12 are identical in series L and S.

Assembly tooling

HVM-B Pre-assembly tool

1

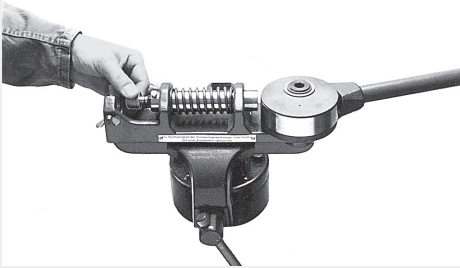

2



3

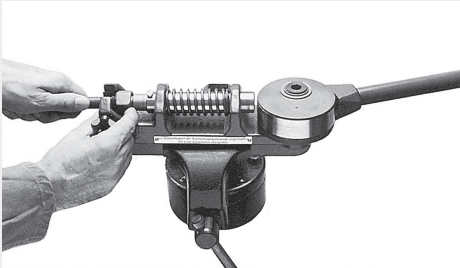

4



5

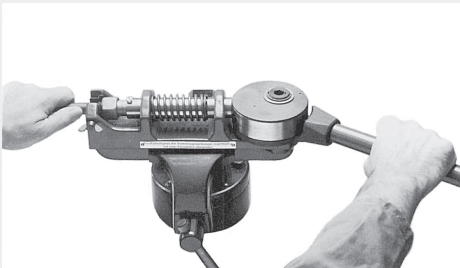

How to use

- Clamp HVM-B into vice.
- Select required assembly cone (MOSI) and insert.
- The assembly cones are marked with tube O.D. and series (e.g. 10-L).

- Insert the tube location plate – HL – of corresponding size and fasten with screw.
- The tube location plates are marked with tube O.D. (e.g. “10”).

- Slip nut “M” and Progressive Stop Ring PSR/Progressive ring “DPR” (or cutting ring “D”) over tube end and insert into pre-assembly tool.
- Nut position must be in front of tube location plate – HL – !

- Hold tube against stop in the assembly cone.

- Pull lever to turn the eccentric cam (Pre-assembly).

Attention

 For assembly check and final assembly see PSR/DPR instructions.

Attention:

 At final assembly nut must be tightened by ½ turn.

EO-KARRYMAT portable pre-assembly device for EO tube connections

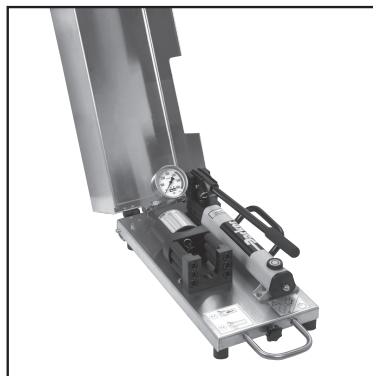

The EO-KARRYMAT is a dependable device for safe and efficient bite-type presetting. It allows pre-assembly of even large dimension steel and stainless steel tube at assembly sites where EOMAT technology is not available.

The EO-KARRYMAT consists of a hydraulic drive and a handpump. The hydraulic assembly pressure can be read on a gauge. The EO-KARRYMAT comes as one unit with all components firmly attached to a practical carrying frame.

Specifications:

For pre-assembly of: EO PSR/DPR and EO-2

Pre-assembly equals:

EO Progressive Stop

Ring (PSR): 1½ turns of nut

EO Progressive

ring (DPR): 1¼ turns of nut

EO-2 "Gap closed"

! For assembly check and fitting installation see assembly instructions chapter E.

Tube O.D.: 6 to 42 mm

Min. U-bend: 66 mm

Series: L and S

Tube and

fitting material: Steel and stainless steel

Total cycle time: approx 30–60 sec.

Weight: approx. 28 kg

Economic

production

quantity: max. 20 assemblies per day

Oil: HLP23–1.22 (filled before delivery)

| Type | Order code |
|---|------------------|
| EO-KARRYMAT assembly device complete device including handpump and carrying case, including operation manual. Tools (assembly cone MOK and backing plate GHP) must be ordered separately. | EOKARRYMAT |
| Promotion leaflet UK/DE | 4044-DE/UK |
| Spare parts | |
| Handpump | 82C-2HP |
| Pressure gauge | EOKARRYMAT/MANO |
| Pressure chart sticker | EOKARRYMAT/CHART |
| Cover hinge | EOKARRYMAT/HINGE |
| Assembly head | EOKARRYMAT/BLOCK |

Features, advantages and benefits of EO-KARRYMAT:







- 1. Ideal** – Weighing 28 kg, the EO-KARRYMAT is portable and does not need any power supply. Therefore the EO-KARRYMAT is the ideal tool for on-site tube assembly, repair and plant maintenance.
- 2. Economic** – The EO-KARRYMAT closes the gap in between manual fitting pre-assembly in a vice and the EOMAT technology. EO-KARRYMAT assembly is far less hard work as manual assembly but it achieves the dependent assembly result of the EOMAT assembly machine.
- 3. "Must" for stainless steel** – As direct assembly of stainless steel tubes in bite type fittings results in failure, a special pre-assembly process is mandatory according to ISO 8483 / DIN 3859 and all manufacturers instructions. The EO-KARRYMAT fulfils this requirement.
- 4. Dependable** – The use of the EO-KARRYMAT is far less demanding than manual fitting assembly using wrenches. It helps to prevent failures caused by insufficient fitting assembly which is most critical on large dimension steel and stainless steel tube.
- 5. Controlled assembly** – After pre-assembly, the tube joint can be easily inspected before final assembly. Therefore, this mandatory step in fitting assembly is less likely to be forgotten.
- 6. Special** – The EO-KARRYMAT has been especially developed for the efficient on-site assembly of EO Progressive ring and EO-2 fittings.

The tools are designed to allow safe assembly of even large dimension steel and stainless steel tubes without excessive hard work.

H

The applications:

- Repair workshops
- Mobile repair service
- Plant maintenance in process engineering, paper production, power plants, offshore exploration, industrial production
- On-site assembly of tubing systems

| Tube O.D. | EO-2 | PSR/DPR |
|---|---|---|
|  |  |  |
| Ø [mm] | P [bar] | P [bar] |
| 6 | 45 | 30 |
| 8 | 55 | 40 |
| 10 | 65 | 50 |
| 12 | 75 | 60 |
| 14 | 95 | 70 |
| 15 | 95 | 70 |
| 16 | 110 | 90 |
| 18 | 110 | 90 |
| 20 | 160 | 120 |
| 22 | 120 | 110 |
| 25 | 210 | 160 |
| 28 | 160 | 140 |
| 30 | 300 | 200 |
| 35 | 250 | 180 |
| 38 | 350 | 280 |
| 42 | 300 | 230 |
|  |  |  |
| Installation | min. 60° max. 90° | ~ 30° |

Assembly tooling

Assembly machines for EO/EO-2 and Triple-Lok®

Machine selection guide

EOMAT assembly is much more cost efficient than manual assembly of EO-fittings. Assembly time and effort are greatly reduced. Proper and consistent pre-assembly support safe and leakfree fitting performance.

EOMAT machines are specifically designed to match EO-2, EO PSR/DPR rings and Triple Lok® standards. Assembly is achieved with high precision and repeatability.

EOMAT machines are available in several versions to serve individual applications. All machines are designed for reliable workshop use even under severe construction site working conditions. Tool handling and machine operation are simple.



How to select the ideal EOMAT machine for your application:

Features, advantage and benefits:

- 1. Universal** – Assembly of EO-2, EO PSR/DPR rings and 37° flaring for Triple-Lok® can be done with just 1 machine.
- 2. Efficient** – With a cycle time of some 12 to 15 seconds the EOMAT machine greatly saves assembly time and effort. The investment pays back quickly.
- 3. Safe** – Proper pre-assembly greatly reduces the danger of leaking fittings or even hazardous tube blow out.

- 4. Strong** – Even 37° flaring of larger sized stainless steel tube is done within few seconds.
- 5. Flexible** – All tube dimensions from 6 to 42 mm can be used. All common tube materials are covered, even plastic tube (EO-2 and PSR/DPR only).
- 6. Marking notch** – A special ridge makes a circular mark onto the tube end to verify that it was properly bottomed at assembly. Failures caused by improper tube cutting or bottoming in MOK can be recognised before final installation.
- 7. Reliable** – For more than 20 years, hundreds of EOMAT machines have operated under heavy duty workshop conditions.

Selection chart EOMAT Pre assembly and Flaring machines

| | EOMAT ECO | EOMAT UNI | EOMAT PRO |
|--|--|---|--|
| Assembly method: EO-2 D/PSR/DPR Triple-Lok® | Pressure controlled Pressure controlled –  | Pressure controlled Pressure controlled Conventional 37° flaring  | Pressure controlled Stroke controlled –  |
| Tube specification: Material Outside diameter Min. U-bend | Steel, Stainless Steel 6–42 mm 75 mm | Steel, Stainless Steel 6–42 mm 65 mm | Steel, Stainless Steel, copper, nylon PRO22 / PRO42: 4–22/4–42 mm PRO22 / PRO42: approx. 35/70 mm |
| Wall thickness: EO-2/PSR/DPR Triple Lok® | No limitation not applicable | No limitation 6×1 to 38×4 or 42×3 mm (Tube O.D. × wall thickness) | No limitation – |
| Operation: Setting | Manual pressure adjustment according to selection chart Depending on: Assembly type; Tube dimension; Tube material Pressure gauge | Manual pressure adjustment according to selection chart Depending on: Assembly type; Tube dimension; Tube material Pressure gauge | Tool detection and automatic adjustment Manual adjustment of pressure is possible |
| Process control | No | No | PLC with display Warning light and message displayed if deviations in assembly process occur |
| Error detection: | No | No | Memory options for custom application on MOK transponderchip |
| Memory function | No | No | Warning light and message displayed |
| Oil temperature control | No | No | Available |
| Foot operating switch | Not available | Not available | Available |
| Performance | 1 Phase/230 V | 1 Phase/230 V | 400 V, 50 Hz, 3-phase |
| Overall cycle time (sec.): EO-2 presetting PSR/DPR presetting 37° flaring | 20 25 – | 12 15 15 | PRO22 / PRO42: approx. 8/10 seconds PRO22 / PRO42: approx. 10/12 seconds – |
| Economic production quantity: | max. 50 assemblies per day | max. 300 assemblies per day | 100 or more assemblies per day |
| Continuous operating: | 50 % | 80 % | 100 % |
| Weight | approx. 30 kg | approx. 66 kg | approx. 90 kg |
| Application | Portable machine for repair and workshops | Universal assembly machine for workshop | Cost-effective commercial production |

EOMAT ECO Mobile assembly machine for EO-2 and PSR hydraulic fittings

H

The EOMAT ECO is a portable machine for the assembly of EO-2 and EO Progressive Ring fittings.

This electro-hydraulic unit is simple to operate; the assembly pressure is set on the digital display. The equipment is simple to use, robust and easy to move.

The EOMAT ECO is an ideal piece of equipment for hydraulic service engineers.

Technical data

Application: assembly of Parker EO-2 and PSR Progressive Ring fittings
assembly of cutting ring fittings to DIN EN ISO 8434-1

Process: pressure-controlled press operation through assembly tools

Drive: electro-hydraulic

Assembly corresponds to: EO-2: gap closed PSR: 1 1/2 turns of the nut

Tube material: steel and stainless steel Tube

diameters: 6 to 42 mm
Series: L and S
Min. U-bend: 75 mm
Speed: working stroke 15 to 20 secs, total cycle time approx. 20 to 25 secs
Dimensions: L 750 x W 360 x H 300 mm
Weight: 30 kg
Electrical: 230V 1-phase
power rating: 50 Hz 700 W

Operation:

for detailed assembly instructions, see our fittings technology technical handbook, chapter E. For safety information, see machine operating manual.

1. Install assembly cone and backing plate

2. Set the setting pressure on the display in accordance with the chart
3. Insert tube complete with nut and ring
4. Operate START button and keep pressed
5. Hold the tube firmly during the assembly operation and press against the stop
6. The assembly operation is complete when the cylinder has travelled back to its starting position
7. Assembly inspection and final assembly should proceed in accordance with the operating manual.

Performance:

Economic production quantity: max. 100 assemblies per day.

| Type | Order code |
|---|--|
| EOMAT ECO basic machine Ready to operate, including operating manual Without tools, no separate assembly fixture required | EOMATECO230V |
| Bulletin | 4046 via Parker catalogue service EMDC |
| Operating manual UK/DE/FR/IT/ES | EOMATECO/MANUAL |
| Pressure chart sticker | EOMATECO/CHART |
| Standard preventive maintenance | EOMATECO/INSPECTION |

Setting pressures

| | EOMAT ECO | | |
|-----------|------------------|------------------|--|
| Tube-O.D. | EO-2 | PSR/DPR | |
| | | | |
| Ø (mm) | P (bar) | P (bar) | |
| 6 | 25 | 20 | |
| 8 | 35 | 25 | |
| 10 | 40 | 35 | |
| 12 | 45 | 40 | |
| 14 | 60 | 45 | |
| 15 | 60 | 45 | |
| 16 | 70 | 60 | |
| 18 | 70 | 60 | |
| 20 | 105 | 75 | |
| 22 | 75 | 70 | |
| 25 | 135 | 105 | |
| 28 | 105 | 90 | |
| 30 | 190 | 130 | |
| 35 | 160 | 115 | |
| 38 | 210 | 180 | |
| 42 | 190 | 145 | |
| | Installation | Installation | |

The stated values are guidelines. The results of pre-assembly should therefore be thoroughly checked.

EOMAT UNI assembly and flaring machine

General

The EOMAT UNI is an electro-hydraulic machine for the assembly of:

EO-2 EO PSR/DPR and Triple-Lok® 37° flared tube fittings.

Compared to manual assembly it greatly reduces assembly time, effort and cost and also guarantees leakfree performance of constant high-quality fitting assemblies.

Common tube materials such as steel (ST 37.4 NBK, ST 52.4 NBK), stainless steel (1.4571/1.4541/316Ti or similar) and copper can be pre-assembled.

The tool range covers all metric tube sizes from 4 to 42 mm outer diameter. The required operating pressure is variable and set at the LED-Display. The unit may therefore be used for a variety of different applications. The tooling for either EO-2/PSR/DPR pre-assembly or tube flaring may be manually replaced, without the use of tools.

Technical data

Tube diameters: 6–42 mm

Min. U-bend: 65 mm

Series: L and S

Oil:

Esso Nuto H 32 or equal, 3.5L
(Reference oil change, see label on unit)

Operating pressure:

Variable from 15 to 200 bar

Dimensions:

L 515 mm, W 535 mm, H 285 mm

Performance:

Overall cycletime: 12–15 sec.

Economic production quantity:
max. 300 assemblies per day

Hydraulic pump:

1.2 kW – 3.7 l/min

Electrical connection:

220–240 V / 1~ / 50 Hz / 9.5 A

Connection cable:

5 m – Earth plug

Weight: 66 kg

We reserve the right to make modifications in the course of further technical development.

Features, advantages and benefits:

- Universal** – Assembly of EO-2, EO-PSR/DPR and 37° flaring for Triple-Lok® can be done with just 1 machine.
- Efficient** – With a cycle time of some 15 seconds the EOMAT UNI greatly saves assembly time and effort. The investment pays back quickly.
- Safe** – Proper pre-assembly greatly reduces the danger of leaking fittings or even hazardous tube blow out.
- Strong** – Even 37° flaring of larger sized stainless steel tube is done within few seconds.
- Flexible** – All tube dimensions from 4 to 42 mm can be pre-assembled. All common tube materials are covered.
- Workshop tool** – At 66 kg, the EOMAT UNI can be brought to an assembly site.
- Marking ridge** – All MOK tools feature a special ridge in the bottom surface which is designed to make a circular groove into the tube-end at assembly. No mark indicates that the tube-end has not been properly bottomed at assembly.
- Reliable** – For more than 20 years, hundreds of machines are operated under heavy duty workshop conditions.

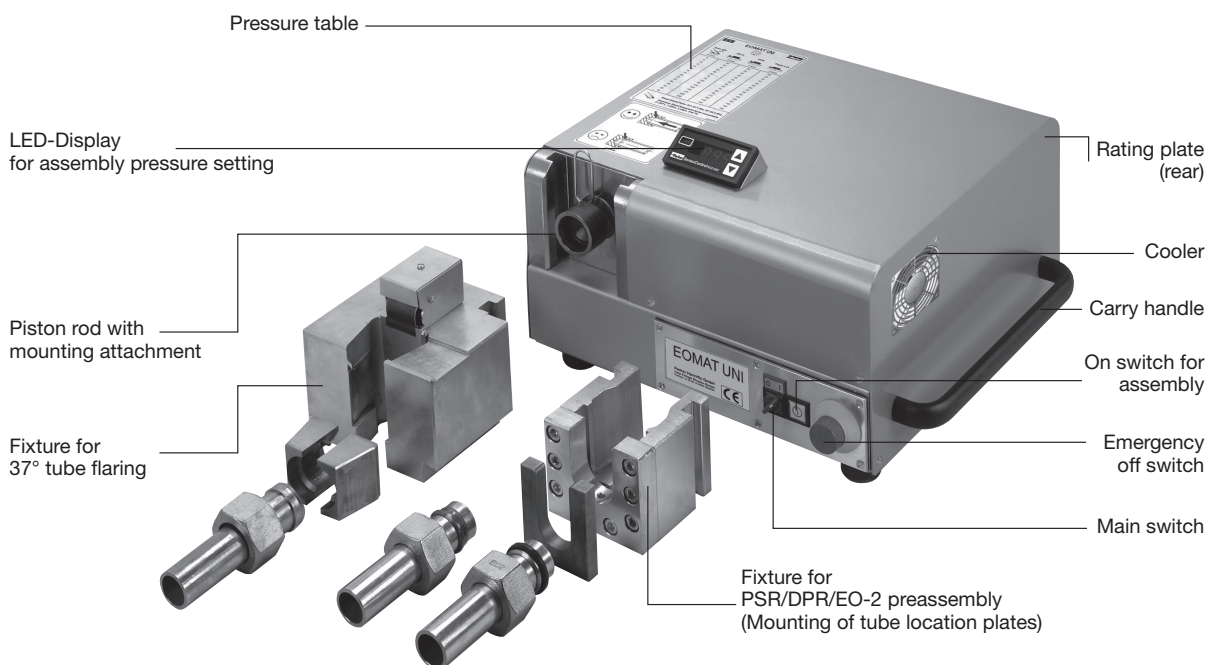
H

Assembly tooling

EOMAT UNI assembly and flaring machine

**Basic operation for EO-2
Functional nuts**

See EO-2 instructions for fitting assembly

1. Adjust EO-2 pressure according to chart (A)
2. Insert the pre-assembly fixture in the tool mounting (weight approx. 5.5 kg).
3. Select the assembly cone (MOK) and backing plate (GHP) in accordance with the tube size and type.
4. Place and lock the assembly cone in the tool holder. Place the backing plate in the slot in the fixture.
5. Slide the EO-2 functional nut onto the tube, which has been cut off square and deburred.
6. Place the tube with the EO-2 functional nut in the pre-assembly fixture between backing plate and assembly cone.
7. Press the tube against the stop in the assembly cone. Hold the tube in this position. Press and hold the start button until the pre-assembly process is complete.
8. Take the assembled tube connection out of the location plate. See EO-2 assembly instruction (chapter E) for assembly check and installation instructions.
9. Check assembly result before final installation.

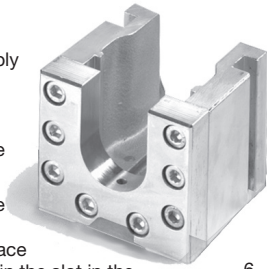
**Basic operation
for EO PSR/DPR ferrules**

See PSR/DPR instructions for fitting assembly

1. Adjust PSR/DPR pressure according to chart (A)
2. Insert the pre-assembly fixture in the tool mounting (weight approx. 5.5 kg).
3. Select the assembly cone (MOK) and backing plate (GHP) in accordance with the tube size and type. Check the assembly cone using a cone-template.
4. Place the assembly cone in the tool holder. Place the backing plate in the slot in the fixture.
5. Oil the ring, nut and assembly cone.
6. Slide the nut and ring onto the tube, which has been cut off square and deburred.
7. Place the tube with nut and progressive ring or cutting ring in the pre-assembly fixture between backing plate and assembly cone.
8. Press the tube against the stop in the assembly cone. Hold the tube in this position. Press and hold the start button until the pre-assembly process is completed.
9. Take the pre-assembled tube out of the backing plate. See EO PSR/DPR assembly instruction (chapter E) for assembly check and installation instructions.
10. Check assembly result before final installation.

**Basic operation for 37° tube
flaring**

See Triple-Lok® instructions for fitting assembly

1. Adjust Triple-Lok® pressure according to chart (A)
2. Insert the tube flaring fixture in the toolmounting (weight approx. 19.5 kg).
3. Lubricate the flaring pin.
4. Insert the flaring die set corresponding to the tube size.
5. Push the nut and support sleeve onto the tube.
6. Push the tube through the flaring die hole to the stop plate. To prevent misalignment, longer tubes are to be supported during the flaring process.
7. Press and hold START button until flaring process is completed.
8. Lift the tube with the flaring die upwards out of the fixture.
9. To release the tube, place the flaring die set in the opening provided in the fixture and tilt the tube to one side.
10. Check assembly result before final installation.

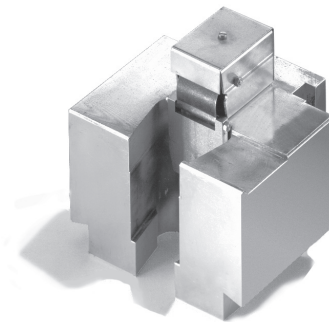
Important!

Only proceed with pre-assembly when a tube with nut and cutting ring has been placed in the fixture (failure to observe this can result in damage to the tools). Longer tubes are to be suitably supported during pre-assembly. The assembly cones are to be regularly checked for correct dimensions using the cone-template and should be replaced when necessary.

Caution: do not reach into the working area of the pre-assembly fixture while it is operating!

Important!

Do not drive the flaring pin into the flaring die without a tube in position. The roughened surface of the flaring die must be absolutely free of oil and grease to prevent the tube from slipping.

Caution: do not reach into the working area of the flaring fixture while it is operating!

EOMAT UNI assembly and flaring machine

Pressure setting chart A

| | | EOMAT UNI | | | |
|----------------------|---|--------------------|------------------------|--|--|
| | | | | | |
| Tube-O.D. | EO-2 | PSR/DPR | Triple-Lok® | | |
| Ø (mm) | P (bar) | P (bar) | P (bar) | | |
| 6 | 30 | 25 | 20 | | |
| 8 | 35 | 30 | 25 | | |
| 10 | 45 | 35 | 35 | | |
| 12 | 50 | 40 | 35 | | |
| 14 | 60 | 50 | 45 | | |
| 15 | 60 | 50 | 60 | | |
| 16 | 70 | 55 | 60 | | |
| 18 | 70 | 55 | 70 | | |
| 20 | 100 | 80 | 95 | | |
| 22 | 80 | 75 | 95 | | |
| 25 | 130 | 100 | 105 | | |
| 28 | 100 | 90 | 125 | | |
| 30 | 180 | 125 | 135 | | |
| 35 | 150 | 110 | 155 | | |
| 38 | 200 | 170 | 165 | | |
| 42 | 180 | 140 | 185 | | |
| | | | | | |
| | Steel (ST 37.4 NBK, ST 52.4 NBK, ...) | | | | |
| | Stainless Steel (ST 1.4571, 1.4541, 1.4301, 316 Ti, ...) | | | | |

H

The given values are a guide. The results of pre-assembly and/or tube flaring are therefore always to be checked. For detailed instructions on tube preparation, tool selection, assembly check and final installation see chapter E.

Assembly tooling

EOMAT UNI assembly and flaring machine

Ordering

| Type | Order code |
|---|------------------------------|
| EOMAT UNI Basic machine Ready to use, including operation manual Filled with hydraulic oil Without EO assembly fixture/Flaring fixture Without tools for EO-assembly/37° flaring Basic machine 230 V, 1 Phase, 50 Hz Rental (monthly usage) | EOMATUNI230V EOMATRENTFEE |
| Fixture for PSR/DPR/EO-2 assembly | EOMATSCHNEIDRX |
| 37° Flaring fixture for Triple-Lok® including flaring pin | EOMATBOERDELBX |
| EOMAT UNI promotion leaflet UK | 4042/UK |
| EOMAT UNI promotion leaflet DE | 4042/DE |
| EOMAT UNI operating manual UK/DE/FR/IT | EOMATUNI/MANUAL |
| Standard preventive maintenance | EOMATUNI/INSPECTION |

Assembly fixtures, tools, cone-templates, and lubricant must be ordered separately

Assembly tools for PSR/DPR/EO-2 see page H19.

37° flaring tools for Triple-Lok® see page H37.

Spare parts

| Type | Order code |
|--------------------------------------|----------------|
| Fixing clip for MOK | EOMAT/CLIP |
| 37° flaring pin | EOMAT/FLAREPIN |
| O-ring for flaring pin | EOMAT/0212500 |
| Tube stop assembly for flaring block | EOMAT/0213800 |
| Pressure chart sticker | EOMATUNI/CHART |
| Spring for flaring block | EOMAT/0213500 |

EO PSR/DPR and EO-2 assembly tools for EO-KARRYMAT/EOMAT ECO/EOMAT UNI

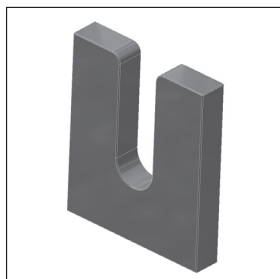

Assembly cone MOK



Tube locating plate GHP

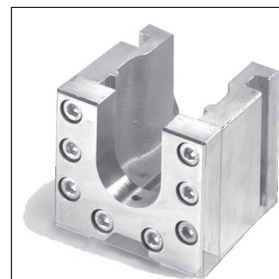

Cone-template KONU for MOK



Assembly fixture must be installed on EOMAT UNI II/III

| Size | | Order code | | | | |
|-----------|-----------|-----------------------------------|---|----------------------|-----------------------------|-----------------------|
| Series | Tube-O.D. | Assembly cones for EO PSR/DPR MOK | Assembly cones for EO-2 ³⁾ MOK | Backing plates GHP | Distance control gauges AKL | Cone-templates KONU |
| LL | 4 | MOK04LLX | as MOK for PSR/DPR | GHP04X | AKL04LL | KONU04LL |
| | 6 | MOK06LLX | | GHP06X | AKL06LL | KONU06LL |
| | 8 | MOK08LLX | | GHP08X | AKL08LL | KONU08LL |
| | 10 | MOK10LLX | | GHP10X | AKL10LL | KONU10LL |
| | 12 | MOK12LLX | | GHP12X | AKL12LL | KONU12LL |
| L | 6 | MOK06LX | MOKEO206L | GHP06X ¹⁾ | AKL06LS | KONU06L ¹⁾ |
| | 8 | MOK08LX | MOKEO208L | GHP08X ¹⁾ | AKL08LS | KONU08L ¹⁾ |
| | 10 | MOK10LX | MOKEO210L | GHP10X ¹⁾ | AKL10L | KONU10L ¹⁾ |
| | 12 | MOK12LX | MOKEO212L | GHP12X ¹⁾ | AKL12L | KONU12L ¹⁾ |
| | 15 | MOK15LX | MOKEO215L | GHP15X | AKL15L | KONU15L |
| | 18 | MOK18LX | MOKEO218L | GHP18X | AKL18L | KONU18L |
| | 22 | MOK22LX | MOKEO222L | GHP22X | AKL22L | KONU22L |
| | 28 | MOK28LX | MOKEO228L | GHP28X | AKL28L | KONU28L |
| | 35 | MOK35LX | MOKEO235L | GHP35X ²⁾ | AKL35L | KONU35L |
| 42 | MOK42LX | MOKEO242L | GHP42X ²⁾ | AKL42L | KONU42L | |
| S | 6 | MOK06SX | MOKEO206S | GHP06X ¹⁾ | AKL06LS | KONU06L ¹⁾ |
| | 8 | MOK08SX | MOKEO208S | GHP08X ¹⁾ | AKL08LS | KONU08L ¹⁾ |
| | 10 | MOK10SX | MOKEO210S | GHP10X ¹⁾ | AKL10S | KONU10L ¹⁾ |
| | 12 | MOK12SX | MOKEO212S | GHP12X ¹⁾ | AKL12S | KONU12L ¹⁾ |
| | 14 | MOK14SX | MOKEO214S | GHP14X | AKL14S | KONU14S |
| | 16 | MOK16SX | MOKEO216S | GHP16X | AKL16S | KONU16S |
| | 20 | MOK20SX | MOKEO220S | GHP20X | AKL20S | KONU20S |
| | 25 | MOK25SX | MOKEO225S | GHP25X | AKL25S | KONU25S |
| | 30 | MOK30SX | MOKEO230S | GHP30X | AKL30S | KONU30S |
| 38 | MOK38SX | MOKEO238S | GHP38X | AKL38S | KONU38S | |



Flaring tools see KARRYFLARE

1) Backing plates, cone-templates and flaring die sets for series L and S for tube outer diameter 6, 8, 10 and 12 are the same.

 2) **Note:** Two-part backing plates for tube OD 35 and 42.

3) Special MOK for easy tube insertion. MOK for EO-2 are marked with groove.

Tool mounting rack

Practical rack for storing 10 pieces each assembly cone MOK and backing plate GHP.

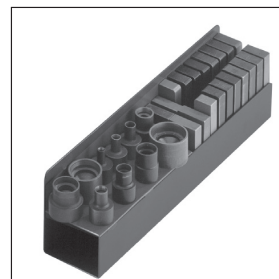

| Type | Order code |
|------------------------------------|-------------------|
| Tool mounting rack for GHP and MOK | EOMATWERKZGAUFN.X |

Tool lifetime

Assembly tools are subject of wear and must be regularly (max. 50 assemblies) cleaned and checked (Checking instructions see chapter E). Worn out tools can cause dangerous assembly failures and must be replaced in time. Maximum lifetime can be achieved by following factors:

- Regular cleaning and checking
- Clean and corrosion-protected storage
- Proper de-burring and cleaning of tube end
- Proper tool selection and operation
- Use of specified lubricant
- MOK EO-2 don't wear out

Assembly tooling

Ferulok assembly tools for EO-KARRYMAT/EOMAT ECO/EOMAT UNI



Assembly cone

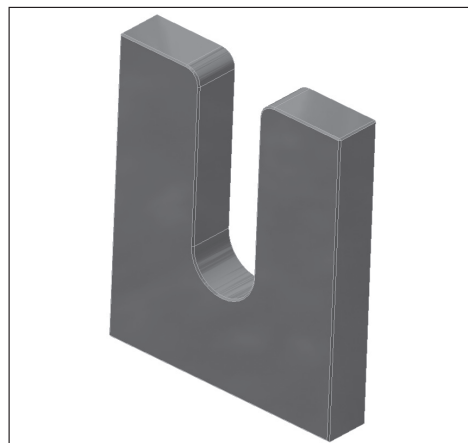

Back-up plate

| Size | | Order code | |
|-----------|----------------|---------------|---------------|
| Dash size | Tube-O.D. inch | Back-up plate | Assembly cone |
| 4 | 1/4 | 975867-4 | 976521-4 |
| 6 | 3/8 | 975867-6 | 976521-6 |
| 8 | 1/2 | 975867-8 | 976521-8 |
| 10 | 5/8 | 975867-10 | 976521-10 |
| 12 | 3/4 | 975867-12 | 976521-12 |
| 14 | 7/8 | 975867-14 | 976521-14 |
| 16 | 1 | 975867-16 | 976521-16 |
| 20 | 1 1/4 | 975867-20 | 976521-20 |
| 24 | 1 1/2 | 975867-24 | 976521-24 |
| 32 | 2 | 975867-32 | 976521-32 |

Assembly tools for inch tube bite type FERULOK.
Machine setting according to correspondent size EO DPR.

EOMAT PRO – Economic assembly machine for EO-2 and progressive ring fittings



The EOMAT PRO is a powerful machine for economical and safe tube installations. The device is designed for installation of Parker EO-2 and progressive ring fittings to DIN EN ISO 8483-1 (DIN 2352) with common tube materials (steel, stainless steel, copper, nylon). The EOMAT PRO is fast and quiet. It permits the assembly of very tight and complex tube bends. Automatic tool detection guarantees short set-up times and prevents errors due to setting the device incorrectly. Unlike conventional cutting ring assembly devices, the EOMAT PRO is stroke-controlled and produces accurate and reproducible assembly results.

The EOMAT PRO can be used in automatic or manual mode. In automatic mode, the settings are read from a transponder chip in the tool. The operator cannot change the device settings in automatic mode.

In the display the tube diameter and the type of installation (EO-2 or progressive ring) will be shown.

There is also a useful piece counter which can be reset by the operator.

Other messages can appear about the assembly cones – for example, notifications about routine checks and tool lifetime. If there is a significant, implausible variation, the display will show an error message. If universal MOK tools are used with universal parameters, this means that only implausible gross deviations will be displayed.

Adaptive assembly cones (MOK-RW) permit the operator to control and set the installation parameters and limits in a few simple steps. In this way the tool is optimized for the specific installation. These individual parameters deliver the best results for the tube material, wall thickness and lubricant used. The device will show slight deviations from the nominal values with a red warning light and a prompt in the display to check the installation. It is therefore possible to detect connections that have been incorrectly installed, check them and remove from the process if needed (e.g. the ring was mounted the wrong way around).

Automatic tool detection, the stored installation values and the display of error messages (red warning light and display) cannot be deactivated in automatic mode by the operator.

In manual mode, different installation values can be set. Manual mode is activated using a key switch. The key is supplied with every device.

The device comes in two versions:

- The quick EOMAT PRO22 for tube sizes up to 20-S/22-L. It has a compact assembly head for tight tube bends.
- The powerful EOMAT PRO42 with a robust assembly head for all sizes up to 38-S/42-L.

Technical data

| | |
|------------------------|--|
| Application: | Economical mass production of Parker EO tube connections Installation of Parker EO-2 and progressive stop ring (PSR) fittings Installation of cutting ring fittings in accordance with DIN EN ISO 8434-1 |
| Process: | Automatic mode PSR: Stroke-controlled assembly with plausibility check Manual mode and EO-2: Pressure-controlled assembly without error detection |
| Installation requires: | EO-2: Gap to be closed PSR: 1½ turns of the union nut Other products: See the manufacturer's documentation |
| Tube material: | Steel, stainless steel, copper, nylon |
| Tube specification: | All permitted tubes for use with Parker EO couplings |
| Tube diameter: | EOMAT PRO22: 4 to 22 mm (except for EO-2 – 20-S) EOMAT PRO42: 4 to 42 mm |
| Range: | LL, L and S |
| Min. U-bend: | EOMAT PRO22: approx. 35 mm EOMAT PRO42: approx. 70 mm |
| Tool Identification: | Uses RFID technology, the transponder is in the MOK assembly cone |
| Error detection: | Plausibility check of the installation parameters after installation |
| Display: | Text messages and warning light |
| Available languages: | German, English, French, Spanish, Italian |
| Display: | Automatic mode: Type of fitting, tube diameter and range Manual mode: Pressure set Piece counter (resettable) |
| Error messages: | “Check installation result” in the case of non-plausible installation parameters. Reminder to check the tool after every 50 uses. Reminder to change the tool when the end of its lifetime is reached. Warnings about critical hydraulic oil level and temperature. |



Assembly tooling

| | |
|-------------------------------|--|
| Speed: | EOMAT PRO 22: ca 1.0 s stroke distance, ca 8–10 s total cycle time EOMAT PRO 42: ca 2.0 s stroke distance, ca 10–12 s total cycle time |
| Economic production quantity: | above 100 assemblies per day |
| Operating duration: | 100% |
| Noise: | Less than 75 dB (A) |
| Ambient temperature: | 0 °C to +40 °C |
| Storage temperature: | –25 °C to +60 °C |
| Parameters: | No condensing humidity |
| Dimensions: | L 620 mm×W 735 mm×H 340 mm |
| Weight: | 90 kg |
| Operational resources: | Esso Hydraulic Oil Nuto H32 or equivalent (filled for delivery) |
| Electrical power: | 400 V 3-phase 50 Hz 1100 W |
| Cable: | 5 m cable with CEE 16 A phase-inverter plug |
| Tools: | EOMAT PRO 22: MOK PRO assembly cones and MOS compact rear supports EOMAT PRO 42: MOK PRO assembly cones and GHP standard backing plates |
| Lubricant: | EO-NIROMONT |
| Test equipment: | AKL distance gauges |

3. Fit the tube with the union nut and ring
4. Press and hold the START button
5. Hold the tube securely through the whole assembly process and push it into the limit stop
6. The assembly process is finished when the cylinder moves back to the starting position
7. Assembly inspection and final assembly is done according to the assembly instructions (see chapter E)

Tool lifetime

Assembly tools are subject to wear, and must be periodically (at least every 50 assemblies) cleaned and inspected (inspection instructions, see chapter E) Worn tools can cause dangerous assembly failures, and need to be replaced in good time. High tool life can be achieved by:

- Regular cleaning and lubrication
- Store protected from dirt and corrosion
- Careful trimming and cleaning of the tube ends
- Proper tool selection and operation
- Use of the recommended lubricant

The MOK PRO assembly cones are made from wear-resistant tool steel, and are therefore suited to mass production. After this lifespan is reached, the display will show that a tool change is needed. The worn tool should be **replaced**, it will no longer work in automatic mode. Worn assembly cones can be used after the end of their expected lifespan in manual mode with care.

EOMAT PRO – features, advantages and benefits

- Low unit costs due to its fast and efficient hydraulic drive
- Compact assembly head for tight and complex bends
- Long lifespan of the assembly tools
- Settings are automatically read from the tool
- Stroke-control achieves a consistently good fitting result
- In automatic mode the operator cannot adjust the installation parameters
- A display showing the number of pieces processed and any error messages
- Adaptive tools for optimal installation parameters and the best possible error detection
- Oil volume and the heat capacity is designed to cope with mass assembly under continuous or shift working patterns
- The foot switch allows the operator a high degree of flexibility

Operation

Detailed installation instructions and safety information can be found in the operation manual

1. Insert the assembly cone and backing plate
2. In automatic mode, the display shows the mounting type and dimensions

| Machine/Item | Order code |
|---|---|
| EOMAT PRO machine , ready to use, with key for selection switch Auto/Manual, with operation manual, filled with hydraulic oil, without tooling and accessories | |
| EOMAT PRO22 Tube-OD 4–22 mm 400 V, 50 Hz, 3 Phase Renting (monthly rate) Leasing (2 year hire purchase) | EOMATPRO22400V EOMATPRORENTFEE EOMATPROLEASEFEE |
| EOMAT PRO42 Tube-OD 4–42 mm 400 V, 50 Hz, 3 Phase Renting (monthly hire rate) Leasing (2 year hire purchase) | EOMATPRO42400V EOMATPRORENTFEE EOMATPROLEASEFEE |
| Accessoires/Item | |
| EO-NIROMONT Liquid lubricant in a brush-in-cap can (250 cc) | EONIROMONTAPPLICATOR |
| Foot switch | FOOTSWITCHSAFETYKIT |
| Fixing clamp for MOK | EOMATPRO/CLIP |
| Spare key for selection switch | EOMATPRO/KEY |
| EOMAT PRO promotion leaflet UK | 4043 via Parker Catalogueservice EMDC |
| Operation manual UK/DE/FR/IT/ES | EOMATPRO/MANUAL |
| Standard preventive maintenance | EOMATPRO/INSPECTION |

Assembly tools for EO fittings

| Size | | Tool order code | | | | | | |
|-----------|--------------|---|--|--|---|---|--|--|
| Series | Pipe OD (mm) | Adaptive assembly cone for progressive ring | Standard assembly cone for progressive ring | Standard assembly cone for EO-2 | Backing plate for EOMAT PRO42 | Compact backing plate for EOMAT PRO22 | Distance gauge only for progressive ring | Cone template for assembly cone |
| LL | 04 | MOK04LLPRORW | MOK04LLPRO | - | GHP04X | GHP04PRO | AKL04LL | KONU04LL |
| | 06 | MOK06LLPRORW | MOK06LLPRO | - | GHP06X | GHP06PRO | AKL06LL | KONU06LL |
| | 08 | MOK08LLPRORW | MOK08LLPRO | - | GHP08X | GHP08PRO | AKL08LL | KONU08LL |
| | 10 | MOK10LLPRORW | MOK10LLPRO | - | GHP10X | GHP10PRO | AKL10LL | KONU10LL |
| | 12 | MOK12LLPRORW | MOK12LLPRO | - | GHP12X | GHP12PRO | AKL12LL | KONU12LL |
| L | 06 | MOK06LPRORW | MOK06LPRO | MOKEO206LPRO | GHP06X | GHP06PRO | AKL06LS | KONU06L |
| | 08 | MOK08LPRORW | MOK08LPRO | MOKEO208LPRO | GHP08X | GHP08PRO | AKL08LS | KONU08L |
| | 10 | MOK10LPRORW | MOK10LPRO | MOKEO210LPRO | GHP10X | GHP10PRO | AKL10LL | KONU10L |
| | 12 | MOK12LPRORW | MOK12LPRO | MOKEO212LPRO | GHP12X | GHP12PRO | AKL12LL | KONU12L |
| | 15 | MOK15LPRORW | MOK15LPRO | MOKEO215LPRO | GHP15X | GHP15PRO | AKL15L | KONU15L |
| | 18 | MOK18LPRORW | MOK18LPRO | MOKEO218LPRO | GHP18X | GHP18PRO | AKL18L | KONU18L |
| | 22 | MOK22LPRORW | MOK22LPRO | MOKEO222LPRO | GHP22X | GHP22PRO | AKL22L | KONU22L |
| | 28 | MOK28LPRORW | MOK28LPRO | MOKEO228LPRO | GHP28X | - | AKL28L | KONU28L |
| | 35 | MOK35LPRORW | MOK35LPRO | MOKEO235LPRO | GHP35X | - | AKL35L | KONU35L |
| 42 | MOK42LPRORW | MOK42LPRO | MOKEO242LPRO | GHP42X | - | AKL42L | KONU42L | |
| S | 06 | MOK06SPRORW | MOK06SPRO | MOKEO206SPRO | GHP06X | GHP06PRO | AKL06LS | KONU06L |
| | 08 | MOK08SPRORW | MOK08SPRO | MOKEO208SPRO | GHP08X | GHP08PRO | AKL08LS | KONU08L |
| | 10 | MOK10SPRORW | MOK10SPRO | MOKEO210SPRO | GHP10X | GHP10PRO | AKL10S | KONU10L |
| | 12 | MOK12SPRORW | MOK12SPRO | MOKEO212SPRO | GHP12X | GHP12PRO | AKL12S | KONU12L |
| | 14 | MOK14SPRORW | MOK14SPRO | MOKEO214SPRO | GHP14X | GHP14PRO | AKL14S | KONU14S |
| | 16 | MOK16SPRORW | MOK16SPRO | MOKEO216SPRO | GHP16X | GHP16PRO | AKL16S | KONU16S |
| | 20 | MOK20SPRORW | MOK20SPRO | MOKEO220SPRO | GHP20X | GHP20PRO | AKL20S | KONU20S |
| | 25 | MOK25SPRORW | MOK25SPRO | MOKEO225SPRO | GHP25X | - | AKL25S | KONU25S |
| | 30 | MOK30SPRORW | MOK30SPRO | MOKEO230SPRO | GHP30X | - | AKL30S | KONU30S |
| 38 | MOK38SPRORW | MOK38SPRO | MOKEO238SPRO | GHP38X | - | AKL38S | KONU38S | |
| | | Programmable with individual parameters for plausibility checks | Programmed with universal parameters without effective error detection | Programmed with universal parameters without effective error detection | Also suitable for EO-KARRYMAT and all EOMAT devices from Parker | Only suitable for the EOMAT PRO 22 device from Parker | To check the assembly result of Parker EO Progressive rings (not for EO-2) | To check wear of MOK assembly cones for progressive rings (not MOK EO-2) |

Assembly tooling

The WorkCenter F3

All aboard

The WorkCenter F3 is completely automatic in operation and has been designed for practical workshop application. Opening

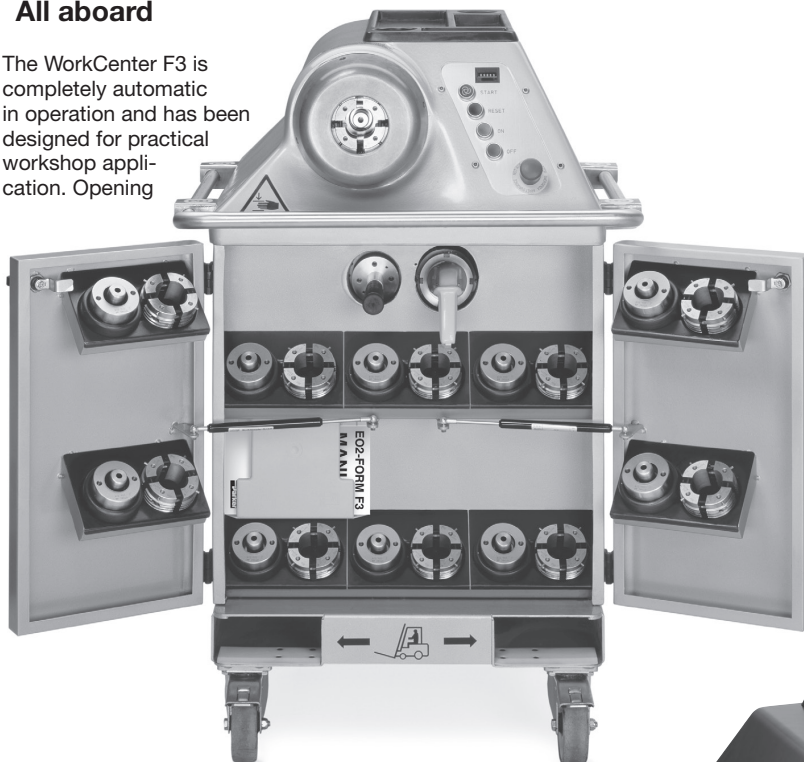

the doors turns the machine into a totally equipped WorkCenter. The tool storage area is located in the front – the tools are neatly laid out and easily viewed. No other workbenches or tool racks are required. Special convenient-to-handle tools make the machine set-ups and tool changes easier. Thanks to automatic tool recognition, the operator has only to press the start button, whereupon the tube is formed into the correct shape in one pass. This means that EO2-FORM connections are extremely simple to manufacture. The WorkCenter F3 is so reliable because of its powerful hydraulic drive and robust forming tools.

- Workshop machine for universal use
- 6 to 38/42 mm tube OD
- Cycle time approx. 20 seconds
- Especially advantageous for: Hydraulic presses, cranes and lifts, heavy machinery, shipbuilding, offshore and hydraulic steelworks

The WorkCenter PRO22

Mass production without tears

The WorkCenter PRO22 is based on proven EO2-FORM technology and was specially designed for the economic production of EO2-FORM tube fittings. Compared with the WorkCenter F3, the PRO22 production machine works considerably more efficiently and can machine tighter tube bends. Because of its powerful drive and efficient cooling, continuous mass production on a shift-work basis is provided for. In addition, the machine is especially quiet and vibration-free in operation. Small to

medium tubes from 6 to 22 mm can be accommodated on the new machine. The compact assembly head enables even tight tube bends to be machined.

- Production machine for economical and fail-safe manufacturing
- 6 to 22 mm tube OD
- Cycle time approx. 6 seconds
- Advantageous for applications such as: manufacturers of agricultural machinery, construction machines, trucks, fork lift trucks and other mass-produced hydraulic equipment



EO-KARRYFORM

Lightweight. Portable. Cost Saving.

With the portable EO-KARRYFORM forming machine tear-out resistant tube connectors in steel and stainless steel can be done directly at the point of installation.

The EO-KARRYFORM can produce tubes with outside diameters ranging from six to 42 mm. The EO-KARRYFORM consists of a hydraulic drive unit in a mobile trolley and a forming

cylinder, which can be safely connected by means of Parker hydraulic hoses and quick couplings. The tools, consisting of clamping dies and forming pins plus insertion tools, are transportable separately in a dedicated tool box. This lightweight machine, weighs approximately 135 kg, allowing it to be quickly and safely transported in, for example, a suitable van to the assembly point.

The EO-KARRYFORM concept is cost saving because F3 and PRO22

WorkCenter tools can also be used for forming processes. Cycle time is approximately 20 seconds and the smallest 180° elbow is 115 mm. This new machine can be easily deployed for both mobile service on-site directly at the assembly point, and also for conventional workshop operation.

- Portable machine for the production of tear-out tube connections
- 6 to 38/42 mm tube OD
- Cycle time approx. 20 seconds
- Beneficial for: Workshops, directly at the assembly point

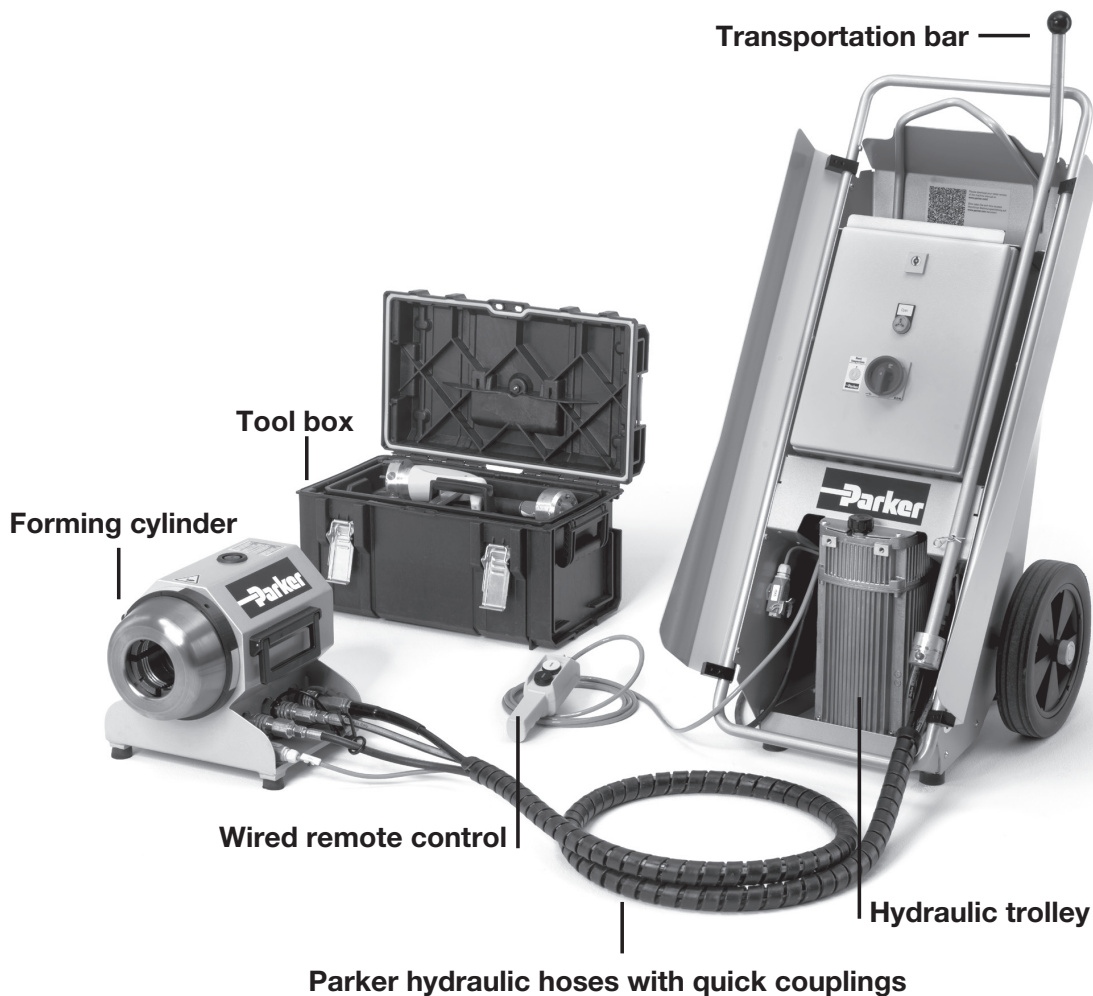
H

Assembly tooling

WorkCenter F3, PRO22 and EO-KARRYFORM

| Technical Data | |
|---------------------------------|--|
| Machine | WorkCenter F3, PRO22 and EO-KARRYFORM |
| Designated use | Cold forming of tube ends for tube connections |
| Method | Axial swaging |
| Suitable for | EO tube fittings to DIN EN ISO 8434-1 Hose Connections to DIN 71550 |
| Tube specification | |
| Steel tubing | E235 / ST37.4; E355 / ST52.4 |
| Stainless steel tubing | 1.4571 |
| Other materials | CuNiFe, duplex and others on request |
| Boiler tube | Tubes for turbine construction on request |
| Tools | |
| Forming die sets | "MF3" single part forming die sets, one type for each tube OD |
| Forming pin | "BF3" forming pin with inner mandrel, one type each per tube OD, wall thickness and material |
| Function | |
| Tool change | Manual |
| Setting | WorkCenter: Automatic tool recognition and pressure setting EO-KARRYFORM: Pressure setting acc. to pressure table |
| Tube clamping | Hydraulic |
| Forming | Hydraulic |
| Controls | Automatic sequence: after pressing START button: Clamp – form – withdraw – unclamp |
| Environmental conditions | |
| Working temperature | WorkCenter: +10 ... +50°C EO-KARRYFORM: +10 ... +40°C |
| Relative humidity | Msc. 90%, non-condensing |

| Type | WorkCenter F3 | WorkCenter PRO22 | EO-KARRYFORM |
|------------------------------|--|---|---|
| Specifications | | | |
| Type | Universal workshop machine | Powerful production machine | Portable forming machine |
| Design | WorkCenter | WorkCenter | Portable machine for repair and workshop tasks |
| Application | Alternative to welding | Efficient mass production | Alternative to welding |
| Weight | Approx. 330 kg | Approx. 375 kg | Hydraulic drive unit: 69 kg Forming cylinder: 67.5 kg Tool box: approx. 10 kg |
| Dimensions (LxBxH) | 660 x 800 (open: 1,300)x1,150 | 660 x 800 (open: 1,300)x1,200 | Drive Unit: 500 x 600 x 1200 Forming cylinder: 330 x 420 x 325 Tool box: 335 x 550 x 310 Length of hydraulic hoses: 3150 |
| Electrical supply | 400 V, 50 Hz, 3 phase 230 V, 50 Hz, 3 phase 440 V, 60 Hz, 3 phase | 400 V, 50 Hz, 3 phase | 230 V, 50 Hz, 1 phase |
| Electric motor drive rating | 4 kW | 4 kW | 1.1 kW |
| Oil cooler | Optional | Standard | — |
| Performance data | | | |
| Steel tube | 6x1 ... 38x7/42x4 | 6x1 ... 20x2/22x2 | 6x1 ... 38x5/42x4 |
| Stainless steel tube | 6x1 ... 38x5/42x3 | 6x1 ... 20x2/22x2 | 6x1 ... 38x4/42x3 |
| Minimum width U-bend | Approx. 135 mm | Approx. 100 mm | Approx. 115 mm |
| Cycle time | 15–20 sec. | Ca. 6 sec. | 15–20 sec. |
| Economic production quantity | Max. 100 formings/hour Max. 200 forming/hour (with oil cooler) | Max. 600 formings/hour | Max. 100 formings/hour |
| Applications | Ideal for project and workshop tasks, small batches and on-site installations. Tubes of all sizes. | Economic mass production of small to medium tube dimensions | Ideal for repair, installation projects and workshop tasks for small batches. Tubes of all sizes. |

Features, advantages and benefits

1. **Process / Product concept** – The EO2-FORM technology is not a stand-alone machine or a new fitting system. It is a product extension of the EO-2 range which has existed since 1993. Exactly the same, proven seal elements are used.
2. **Workcenter concept** – All tools, handling devices, lubricants and the operator manual are well organised inside the machine. Once the doors are opened, the machine turns into a stand-alone workcenter for tube preparation. On the top shelf, there are practical compartments for rules, pens, lubricant and standard EO-boxes with nuts and sealing rings. No additional workbenches or shelves for tooling are required.
3. **Easy operation** – One single START-button is all that needs to be operated to run a forming cycle completely. No “zero position” or “reset” activities have to be performed in-between two forming cycles. For efficient mass production, a foot switch is available. A label on the machine head shows all operation steps in pictograms and all important dimensions in charts.
4. **Easy tool change** – An ergonomic, pistol-like device allows quick and easy change of the one-piece clamping die set without opening the forming head or even touching the tools. Another handle speeds up the setup process of the forming pin in the bayonet mechanism.
5. **Easy handling** – Standard tools and one set of EO-2 sealing rings are suitable for all common hydraulic tube dimensions. No special sleeves are required for thin wall or small diameter tube.
6. **Well organised** – All tools and accessories are well organised in a practical compartment inside the machine housing. Nothing gets dirty, lost or confused.
7. **Easy transport** – The machine is equipped with heavy duty wheels so that it can be moved around by one person without hard work or additional equipment. Special attachments for crane and forklift truck transport are standard. A reeling serves as handle, protection and attachment for fixing belts when transported by truck. Tools and all accessories are safely and cleanly stored inside.
8. **Easy logistics** – EO2-FORM uses the same components as EO-2. Special sets of nuts and sealing rings can be ordered with one part number (FORM ...). This reduces ordering effort and contributes to achieve availability with optimum inventory.
9. **Stainless steel capabilities** – Forming pins for stainless steel tubes are specially designed for optimum forming results and surface coated for maximum lifetime. All forming pins for stainless steel tube are marked with a blue dot. Clamping dies can be used for both, steel and stainless steel tube.
10. **Approved functional system** – EO2-FORM has been on market for years. It is approved for use in shipbuilding, offshore industry, hydraulic water lock systems, press and crane manufacturing, heavy mobile equipment and general machine building. EO2-FORM is tested and approved from authorities like German Lloyd, DNV or from end-users like Daimler-Chrysler.
11. **Cost saving** – Compared to welding or brazing, EO2-FORM are much less time consuming. Special tube preparation and finishing are not necessary. Cold forming uses only a fraction of the energy needed for brazing or welding.
12. **Superior vibration resistance** – The process achieves a smooth structural transformation of the tube wall. There are no sharp edges or notches to reduce the vibration resistance.
13. **Superior mechanical strength** – The working contact area of the EO2-FORM connection is the flat front surface of the metal support ring which is made of heat-treated, high-strength steel or stainless steel. This provides superior mechanical strength without settling, loosening or need for re-tightening.
14. **Universal** – The WorkCenter can cold-form all common steel and stainless steel tube materials for hydraulic pipework. Even exotic materials such as Cu-NiFe or Duplex can be formed. The tools cover metric tube sizes from 6 to 42 mm OD.
15. **Short tube ends** – The compact clamping device and special dies are suitable for machining complex tube bends.
16. **Noise/energy loss reduction** – The process results in a smooth inner contour of the tube. Minimum pressure drop, heat and noise is created. No hidden corners allow the accumulation of air, dirt or other sources of trouble.
17. **Clean** – The process is environmental clean and safe. As no heat is used, hazards from fumes or heat do not occur.
18. **Zinc plated tubing** – The process allows the use of zinc-plated tubing. The costs of cleaning or painting are saved.
19. **Quality** – Tube clamping and tool functions are fully automated. Proper joint geometry and seal dimensions are achieved by using standard EO-2 sealing rings. Therefore high and consistent quality is achieved without manual adjustment.
20. **Proven Technology** – Since 1993, millions of EO-2 fittings have operated worldwide under heavy duty conditions, providing leak-free hydraulic systems.
21. **No restrictions** – The process allows to use EO-2 elastomeric sealing technology even for applications where bite-type connectors are not permitted by safety standards, for example hydraulic presses, cranes, lifts or ship canal systems locks.



Assembly tooling

WorkCenter for EO2-FORM high pressure tube connections

| Machine Type | Order code F3 | Order code PRO22 | Order code EO-KARRYFORM |
|---|--|---|--|
| WorkCenter basic unit for forming tube ends, ready to operate with magnetic gripper, holder and operator's handbook, but without tools, packed in a special transportation box | | | |
| Universal F3 WorkCenter Tube OD 6–38/42 mm 400 V, 50 Hz, 3 phase 230 V, 50 Hz, 3 phase 440 V, 60 Hz, 3 phase Rental (monthly usage) Leasing (24 leasing rate) | EO2FORMF3400V EO2FORMF3230V EO2FORMF3440V EO2FORMF3RENTFEE EO2FORMF3LEASEFEE | EO2FORM400VPRO EO2FORMPRORENTFEE EO2FORMPROLEASEFEE | |
| Mobile transportable device Tube OD 6-38/42 mm 230 V, 50 Hz, 1 phase Rental (monthly usage) Leasing (24 leasing rate) | | | EOKARRYFORM230V EOKARRYFORMRENTFEE EOKARRYFORMLEASEFEE |
| Accessories Type | Order code F3 | Order code PRO22 | Order code EO-KARRYFORM |
| Lubrication for forming pin: EO-NIROMONT Liquid lubricant in a brush-in-cap (250 cc) 0.25 L bottle EO-NIROMONT 1L re-fill pack EO-NIROMONT | EONIROMONTAPPLICATOR EONIROMONTFLUCESS LUBSS | EONIROMONTAPPLICATOR EONIROMONTFLUCESS LUBSS | EONIROMONTAPPLICATOR EONIROMONTFLUCESS LUBSS |
| Oil cooler kit | F3/COOLERKIT | included | — |
| Foot switch | F3/FOOTSWITCH | F3/FOOTSWITCH | F3/FOOTSWITCH |
| Magnetic gripper for forming pin | F3/PINHOLDER | F3/PINHOLDER | F3/PINHOLDER |
| Holder for forming die set | F3/DIEHOLDER | F3/DIEHOLDER | F3/DIEHOLDER |
| Clamping segments for die set | F3/DIECLAMP | F3/DIECLAMP | F3/DIECLAMP |
| Clamping segment spring Ø 8 mm | F3/DIECLAMPSPRING8 | F3/DIECLAMPSPRING8 | F3/DIECLAMPSPRING8 |
| Clamping segment spring Ø 12 mm | F3/DIECLAMPSPRING12 | F3/DIECLAMPSPRING12 | F3/DIECLAMPSPRING12 |
| Operation manual: UK, DE, FR, IT, SWE | 4033 | EO2FORMPRO/MANUAL | 4034 |
| Standard preventive maintenance | EO2FORMF3/INSPECTION | EO2FORMF3/INSPECTION | EOKARRYFORM/INSPECTION |

WorkCenter are shipped in special containers which should be kept for future transports to avoid damage. Please don't dispose the transport boxes!

| Machine housing Type | Order code F3 | Order code PRO22 | Order code EO-KARRYFORM |
|---|------------------|------------------|-------------------------|
| Top machine cover | F3/HEADCOVER | F3PRO/08836014 | — |
| Top tray | F3/TOPTRAY | F3/TOPTRAY | — |
| Door lock for tool compartment | F3/DOORLOCK | F3/DOORLOCK | — |
| Door hinge | F3/DOORHINGE | F3/DOORHINGE | — |
| Shock absorber for doors | F3/DOORSRING | F3/DOORSRING | — |
| Tool tray for inner tool compartment (top), 6x | F3/TOOLTRAYIN | F3/TOOLTRAYIN | — |
| Tool tray for inner tool compartment (bottom), 6x | F3/0883611 | F3/0883611 | — |
| Tool tray for tool compartment in doors, 2x | F3/TOOLTRAYDOOR | F3/TOOLTRAYDOOR | — |
| Die insert for tool tray (use screw M6) | F3/TOOLTRAYPIN | F3/TOOLTRAYPIN | — |
| Holder for magnetic gripper | F3/PINHOLDERTRAY | F3/PINHOLDERTRAY | — |
| Holder for holder | F3/DIEHOLDERTRAY | F3/DIEHOLDERTRAY | — |
| Plastic guide for forklift (use screw M6) | F3/FORKGUIDE | F3/FORKGUIDE | — |
| Front wheel with lock | F3/FRONTWHEEL | F3/FRONTWHEEL | — |
| Rear wheel | F3/BACKWHEEL | F3/BACKWHEEL | — |



| Sticker Type | Order code F3 | Order code PRO22 | Order code EO-KARRYFORM |
|----------------------------|-------------------|----------------------|-------------------------|
| Door label | F3/STICKERPARKER | F3PRO/STICKERPARKER | — |
| Short instructions on side | F3/STICKERINSTRUC | F3PRO/STICKERINSTRUC | — |
| Lubrication on front | F3/STICKERLUB | F3/STICKERLUB | — |
| Crane attachment (1 piece) | F3/STICKERCRANE | F3/STICKERCRANE | — |
| Forklift on front | F3/STICKERFORK | F3/STICKERFORK | — |

| Operation panel Type | Order code F3 | Order code PRO22 | Order code EO-KARRYFORM |
|------------------------------------|-----------------|------------------|-------------------------|
| Front panel counter | F3/FRONTCOUNTER | F3/FRONTCOUNTER | — |
| “START” switch (black with symbol) | F3/STARTSWITCH | F3/STARTSWITCH | — |
| “RESET” switch (blue) | F3/RESETSWITCH | F3/RESETSWITCH | — |
| “ON” switch (green) | F3/ONSWITCH | F3/ONSWITCH | — |
| “OFF” switch (red) | F3/OFFSWITCH | F3/OFFSWITCH | — |
| Emergency stop switch (red) | F3/STOPSWITCH | F3/STOPSWITCH | — |

| Tool Components Type | Order code F3 | Order code PRO22 | Order code EO-KARRYFORM |
|---|---------------|------------------|-------------------------|
| Bayonet bolt for forming pin | F2/PINBOLT | F2/PINBOLT | F2/PINBOLT |
| Screw for clamping die segments | F3/DIESCREW | F3/DIESCREW | F3/DIESCREW |
| Spare part kit for clamping die set (4x Pin Ø4, 4x Spring Ø8, 4x Spring Ø12, 4x Screws) | F3/DIEKIT | F3/DIEKIT | F3/DIEKIT |



WorkCenter for EO2-FORM high pressure tube connections

| Clamping die set MF3EO2 | | | Forming pin BF3EO2 | | |
|-------------------------|--|--|--------------------------------------|--|--|
| Tube O.D. Ø | Clamping dies for steel tubes Order code | Clamping dies for stainless steel tubes Order code | Ø x s | Forming pin for steel tubes Order code | Forming pin for stainless steel tubes Order code ¹⁾²⁾ |
| 06-L/S | MF3EO2P306 | MF3EO2P306 | 06x1.0 06x1.5 06x2.0 | BF3EO206X1S BF3EO206X1.5S BF3EO206X2S | BF3EO206X1SS BF3EO206X1.5SS |
| 08-L/S | MF3EO2P308 | MF3EO2P308 | 08x1.0 08x1.5 08x2.0 08x2.5 | BF3EO208X1S BF3EO208X1.5S BF3EO208X2S BF3EO208X2.5S | BF3EO208X1SS BF3EO208X1.5SS |
| 10-L | MF3EO2P310 | MF3EO2P310 | 10x1.0 10x1.5 10x2.0 | BF3EO210LX1S BF3EO210LX1.5S BF3EO210LX2S | BF3EO210LX1SS BF3EO210LX1.5SS BF3EO210LX2SS |
| 10-S | MF3EO2P310 | MF3EO2P310 | 10x1.5 10x2.0 10x3.0 | BF3EO210SX1.5S BF3EO210SX2S BF3EO210SX3S | BF3EO210SX1.5SS BF3EO210SX2SS |
| 12-L | MF3EO2P312 | MF3EO2P312 | 12x1.5 12x2.0 | BF3EO212LX1.5S BF3EO212LX2S | BF3EO212LX1.5SS BF3EO212LX2SS |
| 12-S | MF3EO2P312 | MF3EO2P312 | 12x1.5 12x2.0 12x3.0 | BF3EO212SX1.5S BF3EO212SX2S BF3EO212SX3S | BF3EO212SX1.5SS BF3EO212SX2SS |
| 15-L | MF3EO2P315 | MF3EO2P315 | 15x1.0 15x1.5 15x2.0 | BF3EO215X1S BF3EO215X1.5S BF3EO215X2S | BF3EO215X1.5SS BF3EO215X2SS |
| 16-S | MF3EO2P316 | MF3EO2P316SS | 16x2.0 16x2.5 16x3.0 | BF3EO216X2S BF3EO216X2.5S BF3EO216X3S | BF3EO216X2SS BF3EO216X2.5SS BF3EO216X3SS |

Assembly tooling

WorkCenter for EO2-FORM high pressure tube connections

| Tube O.D. Ø | Clamping dies for steel tubes Order code | Clamping dies for stainless steel tubes Order code | Ø × s | Forming pin for steel tubes Order code | Forming pin for stainless steel tubes Order code ¹⁾²⁾ |
|-------------|---|---|--------------------------------------|--|---|
| 18-L | MF3EO2P318 | MF3EO2P318SS | 18×1.5 18×2.0 | BF3EO218X1.5S BF3EO218X2S | BF3EO218X1.5SS BF3EO218X2SS |
| 20-S | MF3EO2P320 | MF3EO2P320SS | 20×2.0 20×2.5 20×3.0 20×3.5 | BF3EO220X2S BF3EO220X2.5S BF3EO220X3S BF3EO220X3.5S | BF3EO220X2SS BF3EO220X2.5SS BF3EO220X3SS BF3EO220X3.5SS |
| 22-L | MF3EO2P322 | MF3EO2P322SS | 22×1.5 22×2.0 | BF3EO222X1.5S BF3EO222X2S | BF3EO222X1.5SS BF3EO222X2SS |
| 25-S | MF3EO2P325 | MF3EO2P325SS | 25×2.0 25×2.5 25×3.0 25×4.0 | BF3EO225X2S BF3EO225X2.5S BF3EO225X3S BF3EO225X4S | BF3EO225X2SS BF3EO225X2.5SS BF3EO225X3SS BF3EO225X4SS |
| 28-L | MF3EO2P328 | MF3EO2P328SS | 28×2.0 28×2.5 28×3.0 | BF3EO228X2S BF3EO228X2.5S BF3EO228X3S | BF3EO228X2SS BF3EO228X2.5SS |
| 30-S | MF3EO2P330 | MF3EO2P330SS | 30×2.5 30×3.0 30×4.0 30×5.0 | BF3EO230X3S BF3EO230X4S BF3EO230X5S | BF3EO230X3SS BF3EO230X4SS BF3EO230X5SS |
| 35-L | MF3EO2P335 | MF3EO2P335SS | 35×2.0 35×2.5 35×3.0 | BF3EO235X2S BF3EO235X3S | BF3EO235X2SS BF3EO235X2.5SS BF3EO235X3SS |
| 38-S | MF3EO2P338 | MF3EO2P338SS | 38×3.0 38×4.0 38×5.0 38×6/7 | BF3EO238X3S BF3EO238X4S BF3EO238X5S BF3EO238X6+7S | BF3EO238X3SS BF3EO238X4SS BF3EO238X5SS BF3EO238X6+7SS |
| 42-L | MF3EO2P342 | MF3EO2P342SS | 42×2.0 42×3.0 | BF3EO242X2S BF3EO242X3S | BF3EO242X2SS BF3EO242X3SS |

Tools for hose connection DIN 71550

| Tube O.D. Ø | Clamping dies for steel and stainless steel tubes Order code | Ø × s | Forming pin for steel tubes Order code | Forming pin for stainless steel tubes Order code ¹⁾²⁾ |
|-------------|---|------------------|---|---|
| 10 | MF3EO2P310 | 10×1.5 | BF3DIN7155010X1.5S | |
| 12 | MF3EO2P312 | 12×1.5 | BF3DIN7155012X1.5S | BF3DIN7155012X1.5SS |
| 15 | MF3EO2P315 | 15×2.0 | BF3DIN7155015X2S | |
| 18 | MF3EO2P318 | 18×1.5 | BF3DIN7155018X1.5S | |
| 20 | MF3EO2P320 | 20×2.5 | BF3DIN7155020X2.5S | |
| 22 | MF3EO2P322 | 22×1.5 | BF3DIN7155022X1.5S | BF3DIN7155022X1.5SS |
| 25 | MF3EO2P325 | 25×2.0 | BF3DIN7155025X2S | BF3DIN7155025X2SS |
| 28 | MF3EO2P328 | 28×1.5 28×2.0 | BF3DIN7155028X1.5S | BF3DIN7155028X1.5SS BF3DIN7155028X2SS |
| 30 | MF3EO2P330 | 30×1.5 | | BF3DIN7155030X1.5SS |
| 32 | MF3EO2P332 | 32×1.5 | BF3DIN7155032X1.5S | |
| 35 | MF3EO2P335 | 35×2.0 | | BF3DIN7155035X2SS |

Tool compatibility:
Italic = Tools for EO2-FORM F3 WorkCenter
Regular = Tools for EO2-FORM F3 and PRO22 WorkCenter
Tool lifetime

Assembly tools are subject of wear and must be regularly (max. 50 assemblies) cleaned and checked (Checking instructions see chapter E). Worn out tools can cause dangerous assembly failures and must be replaced in time. Maximum lifetime can be achieved by following factors:

Please select clamping die and forming pin according to tube dimension and material.

- 1) All forming pins for stainless steel tubing are marked with a blue dot on front surface.
- 2) Stainless steel tools are TiN coated.
Clamping die sets which are only used for stainless steel tubes should be marked with the blue dot sticker to avoid use with steel tube.
 - Regular cleaning and checking
 - Clean and corrosion-protected storage
 - Proper de-burring and cleaning of tube end
 - Proper tool selection and operation
 - Use of specified lubricant

Flaring tools for Triple-Lok® tubes

Flaring tool selection guide



Manual flaring devices are available for on-site assembly and field repair of Triple-Lok® tube connections.

Manual flaring tools range from simple impact flarers to handpump-operated workshop devices. Flaring result and fitting performance depends strongly on the skill and effort of operator. Hand flaring tools are not recommended for efficient industrial production.

Features, advantages and benefits of hand flaring tools

- 1. Flexible** – Manual flaring tools are portable and do not need any power supply. Therefore they are ideal for on-site assembly and field repair.
- 2. Special** – Each device has been especially developed to match Parker Triple-Lok® standards. The tube connections will fit properly without rework.

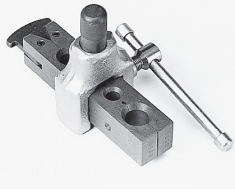
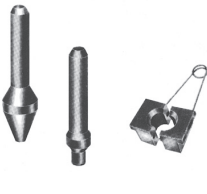
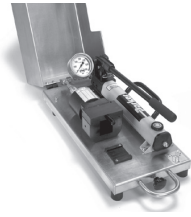
How to select the ideal flaring device for your application:

| | Hand flaring tools 1004/210A | Impact flaring tool | KARRYFLARE | Parflare ECO |
|---|--|--|---|--|
| |  |  |  |  |
| Assembly method Triple-Lok® O-Lok® | impact flaring not suitable | impact flaring not suitable | conventional flaring not suitable | conventional flaring not suitable |
| Tube specification Material | copper, steel | copper, steel, stainless steel | steel, stainless steel | steel, stainless steel |
| Dimension metric tube | 6 to 16 mm (1004) | 6 to 38/42 mm | 6 to 38/42 mm | 6 to 38/42 mm |
| Dimension inch tube | 1/8" to 5/8" (210A) | 1/4" to 1 1/2" | 1/4" to 1 1/2" | 1/4" to 1 1/2" |
| Min. U-bend | depending on vice | depending on vice | 65 mm | 70 mm |
| Tools Clamping dies | one device | vice block | Flaring die M15 ... (same dies used EOMAT) | Flaring die M15 ... (same dies used EOMAT) |
| Flaring pin | integral part of device | pin plus hammer | integral part of device | integral part of device |
| Operation Flaring | hammer impact | hammer impact | handpump | electro-hydraulic |
| Process control | manual | manual | pressure according to chart | pressure according to chart |
| Tube clamping | manual clamping | manual | automatic clamping | automatic clamping |
| Specifications Design | flaring device for use in vice | Hand tools for use in vice | portable desktop | portable desktop |
| Weight | approx. 1.5 kg | – | approx. 29 kg | approx. 30 kg |
| Dimension (W×L×H) | – | – | 750×360×260 mm | 750×360×300 mm |
| Performance Overall cycle time | approx. 1–3 min | approx. 1–3 min | approx. 30–60 sec. | approx. 15–20 sec. |
| Economic production quantity: | 10 flarings per week | 10 flarings per week | max. 50 flarings per day | max. 100 flarings per day |
| Quality | dependant on operator | dependant on operator | controlled process | controlled process |
| Application | on-site repair jobs only; Limited to small dimensions. Limited to single assemblies, not for industrial production, emergency repairs until industrial flared tube is available for replacement. | | Efficient for on-site flaring of small quantities not for mass production | portable machine for repair and workshop |

Assembly tooling

Manual flaring tools for Triple-Lok® tubes

These 37° flaring tools are for use with copper, aluminum alloy, and thin wall steel or stainless steel tubes. A vice block is clamped together with the tube end into a vice. Flaring pin is used with a hammer. Separate tooling sets for each tube size in metric and inch dimensions are available.

These hand tools are suitable for small on-site repair jobs. They are not suitable for thick-wall tubing and industrial production. A rigid vice must be available at the assembly site.

Features, advantages and benefits

1. **Light** – Hand flaring tools can be used at any assembly site where a proper workshop is not available
2. **Quick** – Hand flaring tools can be used for temporary repair until a proper spare tube has been made by machine

Applications

- Field repair of agricultural and construction vehicles
- Small, local repair workshops
- Mobile repair service

Combination impact flarer 1004 for small dimension metric tube

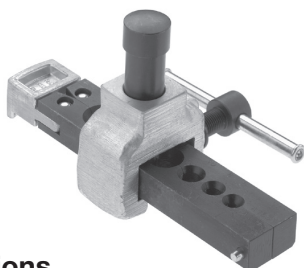

Specifications

Design: Hand flaring tool for small on-site repair jobs

Operation: Flaring pin Impact

37° Flaring: Triple-Lok® connection – ISO 8434-2/ SAE J514

Tube material: copper, aluminum and low carbon steel

Tube diameter: 6 to 16 mm metric tube

Wall thickness: max 15% of tube O.D.

Requirements: Rigid vice and hammer

Performance: Overall cycle time 1–3 min

Economic production quantity: 10 flarings per week

Operation

1. Clamp tube end flush in block halves
2. Clean and lubricate tube end and flaring pin
3. Form the flare by a few sharp hammer blows
4. Release vice and unclamp tube

See chapter E for detailed instructions on Triple-Lok® assembly

Ordering

| Type | Order code |
|--|----------------------|
| Combination impact flarer Complete device including Combination dies and pin | 1004-74M |
| EO-NIROMONT Liquid lubricant in a brush-in-cap can (250 cc) | EONIROMONTAPPLICATOR |

Combination impact flarer 210A for small dimension inch tube

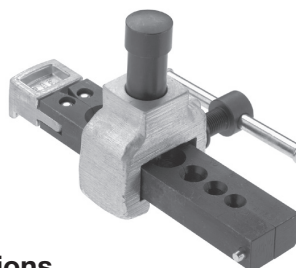

Specifications

Design: Hand flaring tools for small on-site repair jobs

Operation: Flaring pin Impact

37° Flaring: Triple-Lok® connection – ISO 8434-2/ SAE J514

Tube material: copper, aluminum and low carbon steel

Tube diameter: 1/8" to 5/8" inch

Wall thickness: max 15 % of tube-O.D.

Requirements: Rigid vice and hammer

Performance: Overall cycle time 1–3 min

Economic production quantity: 10 flarings per week

Operation

1. Clamp tube end flush in block halves
2. Clean and lubricate tube end and flaring pin
3. Form the flare by a few sharp hammer blows
4. Release vice and unclamp tube

See chapter E for detailed instructions on Triple-Lok® assembly

Ordering

| Type | Order code |
|--|----------------------|
| Combination impact flarer Complete device including Combination dies and pin | 210A |
| EO-NIROMONT Liquid lubricant in a brush-in-cap can (250 cc) | EONIROMONTAPPLICATOR |

Impact flaring tools for metric and inch tube

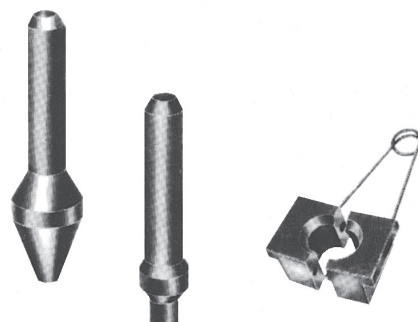

Specifications

Design: Hand flaring tools for small on-site repair jobs

Operation: Impact flaring pin

37° Flaring: Triple-Lok® connection – ISO 8434-2/SAE J514

Tube material: copper, aluminum, steel and stainless steel tube

Tube diameter: 6 to 38 mm/1/4" to 1 1/2"

Wall thickness: max 15% of tube-O.D., max 10% of tube O.D. for tubes larger 20 mm tube O.D.

Requirements: Rigid vice and hammer

Performance: Overall cycle time 1–3 min

Economic production quantity: 10 flarings per week

Operation

1. Clamp tube end flush in block halves
2. Clean and lubricate tube end and flaring pin
3. Form the flare by a few sharp hammer blows
4. Use pre-flaring pin for tube O.D. 20 mm/3/4" and larger
5. Release vice and unclamp tube

See chapter E for detailed instructions on Triple-Lok® assembly

H

| Tools for metric tube | | | |
|-----------------------|----------------------------------|-----------------------|--------------------------|
| Tube-O.D. mm | Pre-flaring pin Order code | Flaring Order code | Vice block Order code |
| 06 | | P17408 | M27406 |
| 08 | | P17408 | M05742 |
| 10 | | P17408 | M27410 |
| 12 | | P17414 | M27412 |
| 14 | | P17414 | M27414 |
| 15 | | P17414 | M27415 |
| 16 | | P17414 | M27416 |
| 18 | | P17418 | M27418 |
| 20 | P1E | P17418 | M27420 |
| 22 | P1E | P17422 | M14742 |
| 25 | P1E | P17422 | M27425 |
| 30 | P1E | P17432 | M27430 |
| 32 | P1E | P17432 | M27432 |
| 38 | P1E | P17438 | M24742 |

| Tools for inch tube | | | |
|---------------------|----------------------------------|-----------------------|--------------------------|
| Tube-O.D. inch | Pre-flaring pin Order code | Flaring Order code | Vice block Order code |
| 1/4" | | P17408 | M04742 |
| 5/16" | | P17408 | M05742 |
| 3/8" | | P17408 | M06742 |
| 1/2" | | P17414 | M08742 |
| 5/8" | | P17414 | M10742 |
| 3/4" | P1E | P17418 | M12742 |
| 7/8" | P1E | P17422 | M14742 |
| 1" | P1E | P17422 | M16742 |
| 1 1/4" | P1E | P17432 | M20742 |
| 1 1/2" | P1E | P17438 | M24742 |

| Type | Order code |
|-----------------------------|--------------------|
| Tool lubricant 0.25L bottle | EONIROMONTFLUCESSX |

Assembly tooling

KARRYFLARE Portable flaring device for Triple-Lok®

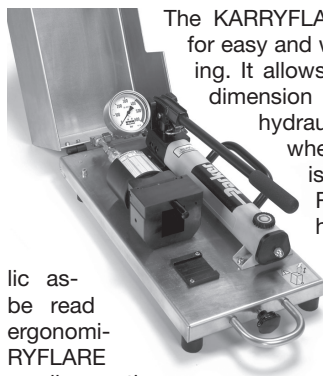

lic as-
be read
ergonomi-
RYFLARE
small quanti-
installation.

It is practical, simple to operate, reliable and easy to transport. The KARRYFLARE comes as one unit with all components firmly attached to a practical carrying frame.

The KARRYFLARE is a portable device for easy and workmanlike 37° tube flaring. It allows the flaring of even large dimension steel and stainless steel hydraulic tube at assembly sites where Parflange® technology is not available. The KARRYFLARE consists of a hydraulic flaring unit and a hand pump. The hydraulic assembly pressure can be read on a gauge which is ergonomically located. The KARRYFLARE is ideal for tube flaring of hydraulic fittings and on-site tube installation.

Technical data

Application: 37° flaring of hydraulic tube
Flare dimensions and geometry according to ISO 8434 / SAE J514

For Parker Triple-Lok® hydraulic fittings
Tube outer diameter: 6 to 38 mm / ¼ to 1 ½"
Maximum capacity: 38 × 4 mm / 1 ½ × 0.120"
With special flaring pin up to 42 mm tube O.D.

Tube material: steel and stainless steel

Minimum width U-bend: 70 mm

Weight: approx. 29 kg

Dimensions: approx. L 750 mm × W 360 mm × H 260 mm

Hydraulic oil: H-LP32-1.2 liter

Ordering

KARRYFLARE device and accessories

| Description | Order code |
|--|----------------------|
| KARRYFLARE Manual flaring device KarryFlare including handpump, carrying case and manual tank filled with hydraulic oil, 37° flaring pin installed. Flaring dies "M15" must be ordered separately. | KARRYFLARE |
| Accessoires | |
| Tool lubricant 0.25L bottle | EONIROMONTFLUESSX |
| EO-NIROMONT Liquid lubricant in a brush-in-cap can (250 cc) | EONIROMONTAPPLICATOR |
| Promotion leaflet | LEAF/4049-D1/UK/DE |
| Spare parts | |
| Flaring bloc, complete | KARRYFLARE/BLOC |
| Standard Flaring pin 6–38 mm, with O-ring | KARRYFLARE/FPIN |
| Special Flaring pin 42 mm, with O-ring | KARRYFLARE/FPIN42 |
| Tube stop with guide | KARRYFLARE/TSTOPKPL |
| Pressure chart sticker | KARRYFLARE/CHART |

Performance

Cycle time: 30–60 sec.

Economic production quantity: max 50 flarings per day

Features, advantages and benefits

1. Flexible on-site tube flaring
2. Simple operation
3. KARRYFLARE is portable and does not require any power supply
4. Flaring quality is comparable to EOMAT
5. Saves time and effort compared to manual impact flaring
6. Safe and consistent result
7. All elements are ergonomically located
8. Robust, light metal transport box
9. Telescopic handle and wheels for convenient trolley transport
10. Uses "M15" flaring dies (EOMAT/1015)

Applications

- Assembly of 37° flare fittings in small quantities
- On-site repair of agricultural vehicles and mobile construction equipment
- Repair workshops and plant maintenance
- Mobile repair service

| KARRYFLARE | | |
|------------------------------------|-------|--------------------------|
| Tube-O.D. Ø [mm] – Ø [Inch] | | Triple-Lok®, P [bar] |
| 6 | 1/4 | 35 |
| 8 | 5/16 | 45 |
| 10 | 3/8 | 60 |
| 12 | 1/2 | 60 |
| 14 | | 80 |
| 15 | | 100 |
| 16 | 5/8 | 100 |
| 18 | | 120 |
| 20 | 3/4 | 160 |
| 22 | | 160 |
| 25 | 1 | 180 |
| 28 | | 215 |
| 30 | 1 1/4 | 230 |
| 35 | | 270 |
| 38 | 1 1/2 | 280 |
| 42 | | 320 |

Parflare ECO

Mobile flaring machine for Triple-Lok® hydraulic fittings



Parflare ECO Economical – Simple – Safe

A full fledged Triple-Lok® fitting flaring machine at an economical price. The Parflare ECO is a mobile machine that flares tubes to 37° for Parker Triple-Lok® hydraulic fittings. This electro-hydraulic machine is simple to operate, with the flaring pressure being set via a digital display. The machine is simple to use, rugged and easy to transport. Because of these features, the Parflare ECO is the ideal machine for hydraulic service technicians.

Application areas:

For the repair and maintenance of hydraulic tubing systems in both workshop and field operations.

Advantages for the service technician:

- professional flaring
- energy and time savings due to the electric drive
- simple operation
- portable and light
- rugged and mobile

Purchasing advantages:

- inexpensive
- economical mode of operation
- existing tooling can be used
- unbeatable price-to-performance ratio

The machine is perfectly suited to regular use, but not to high volume production.

| Technical Data | |
|---------------------------------|--|
| Application: | Flaring tubes for Parker Triple-Lok® hydraulic connectors |
| Procedure: | Axial forming with flaring pin |
| Flaring: | 37° to DIN EN ISO 8434-2 |
| Tube material: | Steel and stainless steel tubing |
| Tube diameter: | 6 to 42 mm / ¼" to 1 ½" |
| Minimum width U-bend: | 70 mm |
| Speed: | 15 to 20 sec. cycle time/approx. 20 to 30 sec. total cycle time |
| Economical production quantity: | max. 100 assemblies per day |
| Dimensions (L×W×H): | 750×300×360 mm |
| Weight: | 30 kg |
| Continuous operating | 50 % |
| Electrical power rating: | EU Version: 230 V single phase 50 Hz 700 W US Version: 110 V single phase 60 Hz 700 W |

| Type | Order code |
|---|--|
| Parflare ECO basic machine, ready to operate, including operator's handbook, KARRYFLARE/FPIN installed, "M15" flaring dies must be ordered separately | EU Version: PARFLAREECO230V US Version: PARFLAREECO110V |
| Brochure | BUL/4048/DE via Parker catalogue Service EMDC |
| Operator's handbook UK/DE/FR/IT/ES | PARFLAREECO/MANUAL |
| Standard preventive maintenance | PARFLAREECO/INSP |
| Pressure chart sticker | PARFLAREECO/CHART |
| Standard flaring pin 6–38 mm, with O-ring | KARRYFLARE/FPIN |
| Special flaring pin 42 mm, with O-ring | KARRYFLARE/FPIN42 |

Operation:

For detailed assembly instructions, see our fittings technology handbook, chapter E. For safety information, see machine operating manual.

1. Insert die valves and close cover
2. Set the recommended flaring pressure in accordance with the chart on the display
3. Insert tube with retaining nut and sleeve
4. Push START button and keep depressed
5. Keep a firm hold of the tube throughout the complete flaring procedure
6. The flaring procedure is finished when the cylinder has returned back to its start position
7. Flaring inspection and final assembly should be in accordance with the assembly handbook

Tool lifetime

Assembly tools are subject to wear and must be regularly (max. 50 assemblies) cleaned and checked (Checking instructions see chapter E). Worn out tools can cause dangerous assembly failures and must be replaced in time. Maximum lifetime can be achieved by following factors:

- Regular cleaning and checking
- Clean and corrosion-protected storage
- Proper de-burring and cleaning of tube end
- Proper tool selection and operation
- Use of specified lubricant

Parflare ECO mobile flaring machine for Triple-Lok® hydraulic fittings

Pressure chart

| Parflare ECO | | |
|--|-------------------------------|----------------------------|
| Tube-O.D. Ø (mm) | Tube-O.D. Ø (inch) | Triple-Lok® P (bar) |
| 6 | 1/4 | 20 |
| 8 | 5/16 | 25 |
| 10 | 3/8 | 35 |
| 12 | 1/2 | 35 |
| 14 | | 45 |
| 15 | | 60 |
| 16 | 5/8 | 60 |
| 18 | 3/4 | 70 |
| 20 | | 95 |
| 22 | 1 | 95 |
| 25 | 1 1/4 | 110 |
| 28 | | 130 |
| 30 | 1 1/2 | 140 |
| 35 | | 165 |
| 38 | | 180 |
| 42 | | 200 |

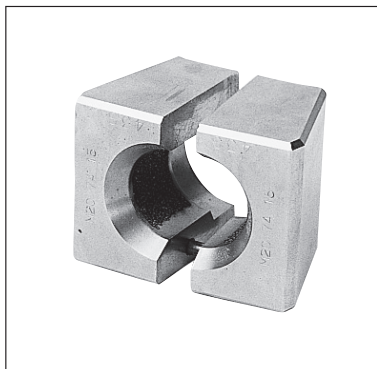
37° flaring tools for KARRYFLARE device and PARFLARE ECO, EOMAT UNI, II and III

Flaring die set M1574

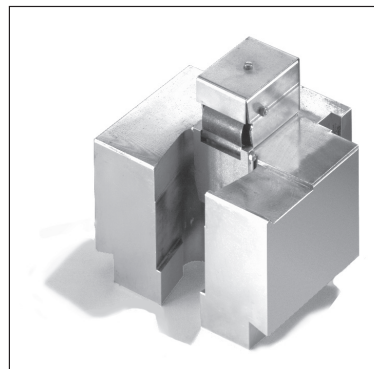

Flaring fixture must be installed on EOMAT UNI II/III

H

| Flaring dies for metric tube | |
|------------------------------|------------|
| Tube O.D. mm | Order code |
| 6 | M157406-1 |
| 8 | M157408-1 |
| 10 | M157410-1 |
| 12 | M157412 |
| 14 | M157414 |
| 15 | M157415 |
| 16 | M157416 |
| 18 | M157418 |
| 20 | M157420 |
| 22 | M157422 |
| 25 | M157425 |
| 28 | M157428 |
| 30 | M157430 |
| 32 | M157432 |
| 35 | M157435 |
| 38 | M157438 |
| 38x6 | |
| 42 | M157442 |

| Flaring dies for inch tube | |
|----------------------------|------------|
| Tube O.D. inch | Order code |
| 3/16" | M037415-1 |
| 1/4" | M047415-1 |
| 5/16" | M157408-1 |
| 3/8" | M067415-1 |
| 1/2" | M087415 |
| 5/8" | M107415 |
| 3/4" | M127415 |
| 7/8" | M147415 |
| 1" | M167415 |
| 1 1/4" | M207415 |
| 1 1/2" | M157438 |

Flaring diameters acc. to ISO 8434-2/SAE J514 for Triple-Lok®. Not suitable for metric flare adapters.

The flaring pin for the KARRYFLARE and Parflare ECO is integrated in the device. For the EOMAT UNI the flaring pins are in the EOMAT flaring fixture (EOMATBOERDELBX).

Flaring dies are **not** interchangeable with Parflange® tools for 1025/1040/50-machines.

Tool lifetime

Assembly tools are subject of wear and must be regularly (max. 50 assemblies) cleaned and checked (Checking instructions see chapter E). Worn out tools can cause dangerous assembly failures and must be replaced in time. A Maximum lifetime can be achieved by following factors:

- Regular cleaning and checking
- Clean and corrosion-protected storage
- Proper de-burring and cleaning of tube end
- Proper tool selection and operation
- Use of specified lubricant

Assembly machines for O-Lok® and Triple-Lok®

Parflange® machine selection guide

Parflange® 1025 and Parflange® 50 are orbital flaring machines designed to cold-form high pressure tube connections. The unique feature of the Parflange® process is that the deformation of the tube end is achieved by rolling rather than by just pushing a tool into the tube end. The Parflange® machine smoothly compresses the tube material and achieves a high strength joint with a polished surface of the tube end. O-Lok® sleeves are firmly fixed onto the tube end, resulting in a very rigid high-pressure tube connection.



Features, advantages and benefits

1. **Superior sealing performance** – The Parflange® process achieves a sealing surface of unique surface quality and mechanical strength.
2. **Superior vibration resistance** – Unlike conventional flaring, the Parflange® process results in a rigid connection of the O-Lok® sleeve on the tube-end. Parflange®/O-Lok® connections perform much better under reversed bending stress conditions.
3. **Easy to use** – No programming or adjustments necessary. High quality results are consistently achieved without manual adjustments.
4. **Cost saving** – Compared to brazing or welding, orbital flanging is much less time consuming. Special tube preparation and finishing are not necessary. Flanging uses only a fraction

of the energy needed for brazing or welding.

5. **Clean** – The Parflange® process is environmental clean and safe. As no heat or chemicals are used, hazards from fumes or heat do not occur.
6. **Zinc plated tubing**. The Parflange® process allows the use of zinc-plated tubing. The cost for cleaning, post process plating or painting is saved.
7. **Process/Product concept** – Parflange® machines are especially designed to match Parker O-Lok® and Triple-Lok® standards. Machine, tools and products are fine-tuned for reliable performance.
8. **Proven technology** – For more than 10 years, hundreds of Parflange® machines have operated worldwide under heavy duty workshop conditions.

How to select the ideal Parflange® Machine for your application:

| Machine selection chart | Parflange® 1025 | | Parflange® 50 | |
|---|---|--|--|---|
| |  | |  | |
| Assembly method Triple-Lok® O-Lok® | Orbital flaring 37° Orbital flanging 90° | | Orbital flaring 37° Orbital flanging 90° | |
| Tube specification Material Dimension metric tube Dimension inch tube Min. U-bend | Steel, Stainless Steel 6 to 25x4 mm (Steel)/25x2,5 mm Stainless Steel O-Lok® ¹⁾ 1/4" to 1"x0.120 (Steel)/1"x0.095 Stainless Steel O-Lok® ¹⁾ 6 mm to 42 mm / 1/4" to 2" Triple-Lok® 140 mm | | Steel, Stainless Steel 6 to 50 mm 1/4" to 2" 120 mm | |
| Tools Clamping dies Flaring/flanging pin | special Parflange® tools M40 ... (old: M30 ...) B30 ... | | special Parflange® tools M40 ... B30 ... | |
| Operation Setting Standard sleeve feeding Optional sleeve feeding Tube clamping Flanging/Flaring Process control | automatic adjustment manual loading not available manual clamping automatic drive semi automatic | | automatic adjustment manual loading (BASIC) O-Lok® sleeve feeder (PRO) hydraulic clamping automatic drive fully automatic | |
| Specifications Design Weight Dimension (LxWxH) | desktop approx. 85 kg 670x390x460 mm | | BASIC stand-alone approx. 380 kg 840x700x1035 mm | PRO stand-alone approx. 410 kg 840x700x2030 mm |
| Performance Version Voltage Overall cycle time Continuous operating Economic production quantity | 1.5 kW 400 V 3 Phase approx. 50 secs. 80 % max. 100 per day | 1.1 kW 230 V 1 Phase approx. 60 secs. 80 % max. 50 per day | 4.5 kW 400 V 3 Phase approx. 15 secs. 100 % max. 500 per day | 4.5 kW 400 V 3 Phase approx. 15 secs. 100 % max. 1200 per day |
| Application | Ideal for projects and workshop use and maintenance High quality result No mass production | on-site repair jobs where 3phase power supply is not available | Efficient production machine for low-cost and high-quality assembly | Efficient mass production machine for low-cost and high-quality assembly |

¹⁾ Other sizes on request.

Parflange® 1025 workshop machine for O-Lok® and Triple-Lok®

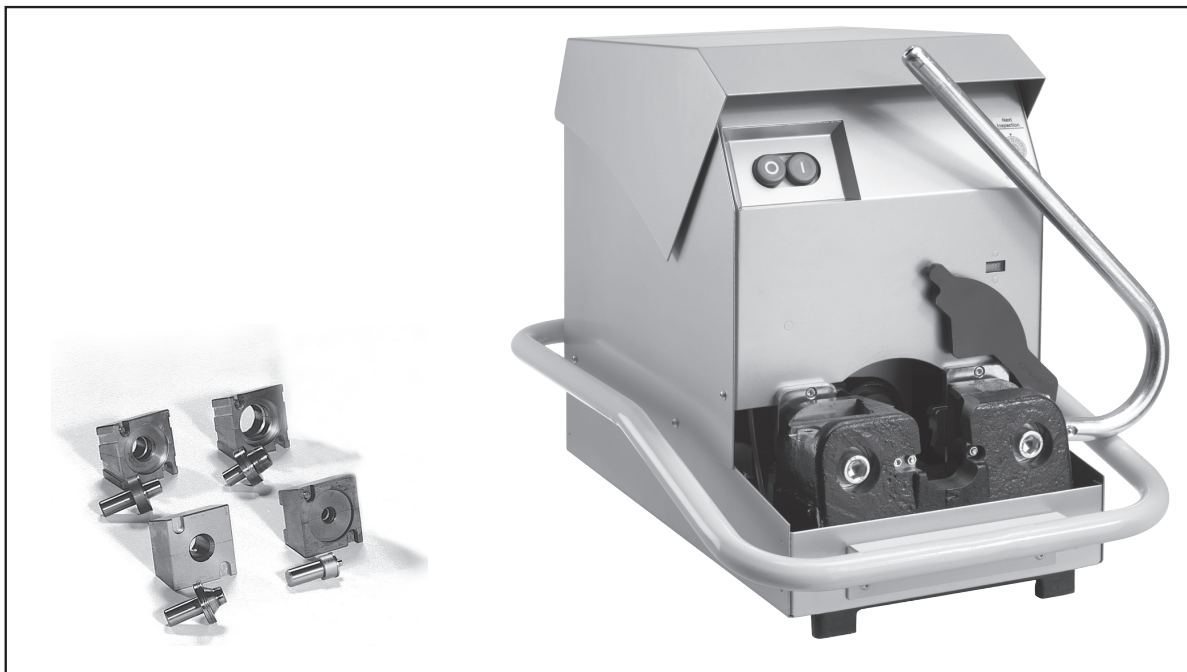
H

The Parflange® 1025 machine is designed to cold-form high pressure tube connections for O-Lok® and Triple-Lok® connection. It uses the Parflange® orbital flaring process. The Parflange® 1025 machine smoothly compresses the tube material and achieves a high strength joint with a polished surface of the tube end. O-Lok® and SAE flange sleeves are firmly fixed onto the tube end, resulting in a very rigid high-pressure tube connection.

The 1025 is the smallest machine of the Parflange® machine programme. It is recommended for low-volume assembly jobs of small to medium tube dimensions. Maximum tube capacity is 25 x 4 mm/1" (steel tube) and 25 x 2.5 mm/1" Parker tube 1.4571 (tube made from other material has to be checked). Its advantage is the quick and easy change of tooling and the simple operation without manual adjustments or programming. The machine is transportable so that it can be moved to any assembly site with electrical power supply.

The Parflange® 1025 comes ready to be used. Parflange® tools are purchased separately. For each tube dimension, special clamping dies and Parflange® pins are required.

Specifications

| | |
|----------------|--|
| Purpose: | 180° flanging for O-Lok® and 37° flaring for Triple-Lok® |
| Process: | Orbital flaring and flanging according to Parflange® process |
| Design: | Desktop machine for workshop use |
| Tube material: | steel and stainless steel tube |
| Tube diameter: | metric: 6 to 25 mm Inch: ¼ to 1" |

Maximum capacity: 6 to 25x4 mm (Steel)/25x2,5 mm Stainless Steel O-Lok®¹⁾
 1/4" to 1"x0.120 (Steel)/1"x0.095 Stainless Steel O-Lok®¹⁾
 6 mm to 42 mm / 1/4" to 2" Triple-Lok®

Min. U-bend: 140 mm
 Tube specification: fully annealed seamless cold drawn or welded precision tube

Performance:
 Overall cycle time 1.5 kW: 50 sec; 1.1 kW: 60 sec
 Economic production quantity 1.5 kW: max. 100; 1.1 kW: max. 50
 Operation: Manual clamping, automatic flanging/flaring

Continuous operating: 80 %
 Cycle time: approx. 15 to 20 secs.
 Tools: Flaring pin B30 or B40 ... and clamping dies M40 ...

Tool clamping: Manual, by eccentric lever
 Tool lubrication: Automatic lubrication device
 Lubricant: EO-NIROMONT LUBSS (filled when delivered)

Hydraulic oil: HLP 23 0.5L (filled when delivered)
 Installation: rigid workbench and electrical power supply required

Dimensions: 670x390x460 mm
 Weight: 85 kg

¹⁾ Other sizes on request.

Assembly tooling

Features, advantages and benefits

1. **Superior sealing performance** – The Parflange® process achieves a sealing surface of unique surface quality and mechanical strength.
2. **Superior vibration resistance** – Unlike conventional flaring, the Parflange® process results in a rigid connection of the O-Lok® sleeve on the tube-end. Parflange®/O-Lok® connections perform much better under reversed bending stress conditions.
3. **Easy to use** – No programming or adjustments necessary. High quality results are consistently achieved without manual adjustments.
4. **Quality** – Machine setting, tool control and even lubrication are fully automated so that high and consistent quality results are achieved without manual adjustments.
5. **Small bending radii** – The compact clamping device and special dies are suitable for flanging short tube ends.
6. **Cost saving** – Compared to brazing or welding, orbital flanging is much less time consuming. Special tube preparation and finishing are not necessary. Flanging uses only a fraction of the energy needed for brazing or welding.
7. **Clean** – The Parflange® process is environmental clean and safe. As no heat or chemicals are used, hazards from fumes or heat do not occur.
8. **Zinc plated tubing** – The Parflange® process allows the use of zinc-plated tubing. The cost for cleaning or painting can be saved.
9. **High tool lifetime** – The Parflange® 1025 machine is equipped with an automatic lubrication device. The tools will not wear rapidly if the operator does not lubricate regularly.
10. **Process/Product concept** – Parflange® machines are especially designed to match Parker O-Lok® and Triple-Lok® standards. Machine, tools and products are fine-tuned for reliable performance.
11. **Proven technology** – Since more than 10 years, hundreds of Parflange® machines have operated worldwide under heavy duty workshop conditions.

Applications

Workshop use, project work, plant maintenance, on-site assembly.

Not for efficient mass production

Ordering

| Type | Order code |
|---|-----------------|
| Parflange® 1025 Basic machine Ready to use, including operating manual, Filled with hydraulic oil and lubricant Without Parflange® tools | |
| Basic machine 400 V, 3 Phase, 50 Hz | 1025-380VTRI50 |
| Basic machine 230 V, 1 Phase, 50 Hz | 1025-220VMONO50 |
| Rental (monthly usage) | 1025RENTFEE |
| 1025 promotion leaflet UK | 4390/UK |
| 1025 promotion leaflet DE | 4390/DE |
| 1025 operating manual UK/DE/FR/IT | 4390-B5 |
| Standard preventive maintenance | 1025/INSPECTION |

Parflange® machines are shipped in a special container which should be kept for all transports to avoid damage.

Spare parts

| Type | Order code |
|---|---------------|
| Tool lubricant qty: 1L EO-NIROMONT | LUBSS |
| Drive belt | 1025/028Polyv |
| Came guide and with screw | 1025/0281031 |
| Hydraulic tank seal kit | 1025/0281042 |
| Lubrication kit | 1025/0281200 |
| Retrofit Kit: Oilsump for the Parflange 1025 to catch rest lubricant | 1025/OILSUMP |

Parflange® 50 WorkCenter



Bins can be stored on top platforms



Easy refill of tool lubricant

The Parflange® 50 WorkCenter is the top-of-the-range machine for orbital flaring & flanging of O-Lok® and Triple-Lok® tube assemblies. It combines the practical EO2-FORM F3 WorkCenter concept with the proven Parflange® technology.

Due to the robust design and the precise process control, the Parflange® 50 WorkCenter achieves consistent high quality results and high productivity. Machine housing, cycle programming and all operating elements are designed for good ergonomics, optimum workflow and highest security. The compact Parflange unit and the compact housing allow the forming of small and complex tube bends. Maximum tool lifetime is achieved by the automatic lubrication system as well as easy visibility and accessibility of the tooling area. The integrated tool compartments and designated space for bins for nuts and sleeves make it comfortable and efficient to work with the Parflange® 50.

Parflange® advantages over brazing or welding

Faster and lower cost – 9 to 12 times the speed of comparable induction brazing.

Flexibility – Small batch quantities are practical due to short tool change times.

Simple tube preparation – The Parflange® process does not require any special pre- or post-flange cleaning of the tube and sleeve.

Safety – Unlike brazing, the Parflange® process does not require any flux, braze alloy, post braze cleaner or rust inhibitor. An environmentally safe lubricant applied to the flanging pin is the only additive associated with the Parflange®.

Environment – The Parflange® process is environmentally clean and safe. It does not require open flame or any form of heating. Additionally, there is no emission of hazardous fumes, as is typical with welding and brazing.

Energy – The Parflange® process uses only a fraction of the energy needed for welding or brazing.

Corrosion resistance – The Parflange® process accommodates the use of plated or unplated components (i.e. tube and sleeve). Thus, the high costs of electro-plating assemblies after fabrication is eliminated by using pre-plated tube.

Excellent surface quality – The Parflange® process eliminates the potential leak path present at the braze or weld joint.

Features and benefits

- Cost saving** – Compared to welding or brazing, orbital flanging is much less time consuming. Special tube preparation and finishing are not necessary. Flanging uses only a fraction of the energy needed for brazing or welding.
- Zinc plated tubing** – The Parflange® process allows the use of zinc-plated tubing. The cost for cleaning post process plating, or painting can be saved.
- High tool lifetime** – The Parflange® 50 machine is equipped with an automatic lubrication device. The operator does not have to lubricate the tools ensure long pin life.
- Use of existing tools** – All existing Parflange® tools (M40 dies

and B30/B40 pins) fit into the new machine generation.

- WorkCenter concept** – When the doors are opened, the machine body turns into a WorkCenter for production of O-Lok® and Triple-Lok® tube assemblies. All tools are available for rapid and convenient machine setup and tool change.
- Low-cost mass production** – The machine can be ordered with an automated sleeve feeder. The Parflange® 50 then is the perfect solution for low-cost mass production.
- Universal** – The Parflange® 50 can do 37° flaring for Triple-Lok® connectors and flange tubes for O-Lok® fittings (ORFS). Parflange® tools cover metric tube from 6 to 50 mm O.D. and inch tube from 1/4 to 2" O.D.
- Flange Seal** – The Parflange® 50 is also capable for the innovative Flange Seal connection, which contributes to reduce component cost and assembly time.
- Heavy duty** – The rigid machine design allows use for mass production of even large stainless steel tube connections.
- Process/Product concept** – Parflange® machines are especially designed to match O-Lok®, Triple-Lok® and SAE-flange standards. Machine, tools and products are fine-tuned for reliable performance.
- Superior sealing performance** – The Parflange® process achieves a sealing surface of unique surface quality and mechanical strength.
- Superior vibration resistance** – Unlike conventional flaring, the Parflange® process results in a rigid connection of the O-Lok® sleeve on the tube-end. Parflange®/O-Lok® connections perform much better under reversed bending stress conditions.
- Efficient** – The short cycle time and the automatic process allow efficient mass production.
- Quality** – Tube clamping, tool control and even lubrication is fully automated so that high and consistent quality results are achieved without manual adjustments.
- Easy to use** – The clamping and flanging process is fully automated. Manual tool manipulation is not required. The process is initiated by pushing the tube end into the tooling.
- Bin holder** – The top surface is designed to store two standard bins for fitting nuts and Parflange® sleeves. Everything is easy to reach for the operator.
- Illuminated tooling area** – Insertion of Parflange® sleeves and condition monitoring of tools is easy.
- Practical lubricant refill** – The container for tool lubricant is easily accessible by a hatch on the machine side.
- Side drawer** – Chips, dirt and dropped components like Parflange® sleeves can be removed by a small drawer. This allows to keep the working area clear and avoid jamming of moving parts.
- Clean** – The Parflange® process is environmentally clean and safe. As no heat or chemicals are used, hazards from fumes or heat do not occur.
- Perfect for project work** – After finishing a piping project, the machine can be put aside. Tools don't get lost and dirty. For the next project, the machine just needs to be transported to the new side and unfolded into the WorkCenter. This is particularly useful for piping projects in shipyards, paper mills, offshore platforms or steel mills.
- Ready to go** – The Parflange® WorkCenter is delivered including all necessary details like electrical plug, operator manual, short instruction pictograms on machine housing and dimensional charts for tube preparation.
- New Generation** – The Parflange® 50 WorkCenter replaces the Parflange® 1040 machine, which has been successful in the market for more than 12 years.

H

Assembly tooling

Parflange® 50 BASIC WorkCenter
Technical description 50 BASIC WorkCenter:

The Parflange® 50 is a production WorkCenter for orbital flaring and flanging of high pressure tube connections. The unique feature of the Parflange® process is that the deformation of the tube end is achieved by rolling rather than by just pushing a tool into the tube end.

The Parflange® machine smoothly compresses the tube material and achieves a high strength joint with a polished surface of the tube end.

O-Lok® sleeves are firmly fixed onto the tube end, resulting in a robust and vibration-resistant tube connection.

The Parflange® 50 is the heavy-duty, mass production WorkCenter of the Parflange® machine programme.

It is recommended for industrial production of all sizes Triple-Lok® and O-Lok® tube connections.

Maximum tube capacity is 50 mm/2" tube O.D.

The powerful drive and the fast, automatic process allow short cycle times for efficient production. Its advantage is the quick and easy change of tooling and the simple operation without manual adjustments or programming. Tube clamping and tool lubrication are done automatically.

The Parflange® 50 comes ready to be used. Parflange® tools have to be purchased separately. For each tube dimension, special clamping dies and Parflange® pins are required. The machine can be moved on wheels, by forklift truck and crane. For basic use, just an electrical power supply is required.

Machine specification 50 BASIC WorkCenter:

| | |
|-----------------------|---|
| Purpose: | 90° Flanging for O-Lok® and 37° Flaring for Triple-Lok® |
| Process: | Orbital flaring and flanging according to Parflange® process |
| Design: | WorkCenter for industrial production |
| Tube material: | Steel and stainless steel tube |
| Tube diameter: | Metric: 6 to 50 mm Inch: 1/4" to 2" |
| Min. U-bend: | 120 mm |
| Maximum capacity: | Steel tube (ST 37, ST 52, ...) Metric: 38x5/50x3 mm (tube O.D. x wall thickness) Inch: 2"x0.120 Stainless steel tube (1.4571, 316, ...) Metric: 38x4 mm Inch: 1 1/2"x0.156 |
| Tube specification: | Fully annealed seamless cold drawn or welded and redrawn precision tube |
| Operation: | Automatic clamping, automatic flanging/flaring |
| Continuous operating: | 100 % |

| | |
|-------------------------------|---|
| Speed: | 5–8 sec. flanging time/15–20 sec. total cycle time |
| Economic production quantity: | max. 500 flarings per day |
| Tools: | Flaring pin B30 ... or B40 ... Clamping dies M40 ... |
| Tool compartments: | 10 die sets, 10 pins |
| Tool clamping: | Automatic |
| Tool lubrication: | Automatic lubrication device |
| Lubricant: | EO-NIROMONT (filled when delivered) |
| Hydraulic oil: | HLP 46 (filled when delivered) |
| Installation: | Electrical power |
| Dimensions (LxWxH): | 840x700x1035 mm |
| Platform for bins: | 2 platforms, 300x500 mm, max. 5 kg each |
| Weight: | 380 kg |
| Electrical power: | 400 V, 3 Phase, 50 Hz, 4.5 kW |
| Transport options: | On wheels, by forklift truck, lifting attachments |



Parflange® 50 PRO WorkCenter

Technical description 50 Pro WorkCenter:

For industrial mass production of O-Lok® connections, special machines Parflange® 50 PRO with O-Lok® sleeve feeder are available. This sleeve feeding device increases the productivity, particularly of high volume – single tube dimension jobs.

In “Feeder ON – mode”, O-Lok® sleeves just need to be inserted into feeder rails. First cycle start is initiated by manually closing the safety cover. Then, all following cycles are started by pushing the tube into the pre-clamped dies. All other machine activities, like tube clamping, flanging, tube release, insertion of O-Lok® sleeves into dies, pre-clamping of dies and the operation of safety cover run fully automatic. The operator just is handling the tubes and refilling the sleeve-feeder from times to times with O-Lok® sleeves.

In “Feeder OFF – mode”, the Parflange® 50 PRO operates like the Parflange® 50 BASIC without O-Lok® sleeve feeder. This mode is useful for maximum size flexibility and Triple-Lok® assembly. For quick changeover and safety reasons, the O-Lok® sleeve feeder is just switched OFF but not be removed from the Parflange® 50 PRO WorkCenter.

For operation of O-Lok® PRO machines, compressed air supply is required, even when sleeve feeder is not used.

H

Machine specification 50 PRO WorkCenter:

Specific differences of Parflange® 50 Pro versus Parflange® 50 Basic

| | | | |
|-------------------------------|---|---------------|---|
| Design: | Parflange® 50 with additional O-Lok® sleeve feeder | Feeder: | Feeder is delivered in separate box and must be firmly attached to machine. Feeder can be switched ON and OFF but must not be removed. |
| Normal Operation: | Same as Parflange® 50 Basic when feeder is switched off | Feeder rails: | Feeder rail kits must be ordered separately for each O-Lok® sleeve size. |
| Feeder Operation: | Work-cycle is initiated by inserting tube end Automatic clamping, automatic flanging/flaring Automatic insertion of O-Lok® sleeves into dies Automatic operation of safety cover Automatic pre-clamping of dies | Feeder setup: | Installation of matching rail kit by knurled nuts and adjustment of scale wheel according to chart |
| Manual operation: | like Parflange® 50 Basic | Installation: | Electrical power, for feeder type machines: compressed air supply (6 bar) |
| Cycle time: | 5–8 sec. flanging time/approx. 15 to 20 sec. total cycle time | Dimensions: | 700x840x2030 mm |
| Economic production quantity: | max. 1200 flarings per day | Weight: | 410 kg |
| Tools: | Same tools as Parflange® 50 BASIC | | |



Assembly tooling

Parflange® 50 Ordering

| Type | Order code |
|--|--|
| Parflange® 50 Basic machine Ready to use, including operation manual, filled with hydraulic oil and lubricant Without Parflange® tools Basis machine Europe version (not prepared for O-Lok® sleeve feeder) | |
| Purchase: EU-Version US-Version | 1050EU400VBASIC 1050US440V60HZBASIC |
| Leasing (2 year hire purchase) | 1050BASICLEASEFEE |
| Rent (monthly) | 1050BASICRENTFEE |

 Parflange®
50 BASIC

| Type | Order code |
|---|------------------------------------|
| Parflange® 50 Pro machine Europe version including O-Lok® sleeve feeder without feeder rails | |
| Purchase: EU-Version US-Version | 1050EU400VPRO 1050US440V60HZPRO |
| Leasing (2 year hire purchase) | 1050PROLEASEFEE |
| Rent (monthly) | not available |

 Parflange®
50 PRO for mass
production
of O-Lok®
assemblies

| Sleeve feeder rails for Parflange® 50 Pro | Tube O.D. | Order code |
|---|--------------------|-------------|
| O-Lok® sleeve feeding rail | 6 mm/¼" | 1050/RAIL04 |
| O-Lok® sleeve feeding rail | 8, 10 mm/³/₈" | 1050/RAIL06 |
| O-Lok® sleeve feeding rail | 12 mm/½" | 1050/RAIL08 |
| O-Lok® sleeve feeding rail | 14, 15, 16 mm/⁵/₈" | 1050/RAIL10 |
| O-Lok® sleeve feeding rail | 18, 20 mm/¾" | 1050/RAIL12 |
| O-Lok® sleeve feeding rail | 22, 25 mm/1" | 1050/RAIL16 |
| O-Lok® sleeve feeding rail | 28, 30, 32 mm/1¼" | 1050/RAIL20 |
| O-Lok® sleeve feeding rail | 35, 38 mm/1½" | 1050/RAIL24 |

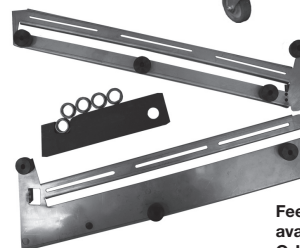
 Feeder rail kits are
available for each
O-Lok® size

| | |
|------------------------------------|--|
| 50 promotion leaflet | 4391-1 via Parker catalogue service EMDC |
| 50 operating manual UK/DE/FR/IT/ES | 1050/MANUAL |
| Standard preventive maintenance | 1050/INSPECTION |

| | |
|---|------------------|
| Tool lubricant refill qty: 1L EO-NIROMONT | LUBSS |
| Replacement cartridge for spindle lubrication | 1050/22900001801 |

 High-Performance lubricant
for Parflange®

Parflange® machines and feeders are shipped in special containers which should be kept for future transports to avoid damage. Please don't dispose the transport boxes!!!

Tooling for Parflange® machines

Machine and tool selection



Parflange® 1025



Parflange® 50

H

Parflange® 1025 machines flanging capacity for O-Lok®

| Tube material | 220 V 1.1 kW | 380 V 1.5 kW |
|----------------------------|--------------------------|------------------|
| | Max. tube size mm (inch) | |
| Steel ST37 | 25x4 (1"x0.120) | 25x4 (1"x0.120) |
| Stainless steel 304L/316L* | 25x2.5 (1"x0.95) | 25x2.5 (1"x0.95) |
| Steel ST52 | 25x4 (1"x0.120) | 25x4 (1"x0.120) |

Parflange® 50 machines flanging capacity for O-Lok®

| Tube material | Max. tube size mm (inch) |
|----------------------------|--------------------------|
| Steel ST37 | 38x5/50x3 (2x0.120) |
| Steel ST52 | 38x4 (1 1/2x0.156) |
| Stainless steel 304L/316L* | 38x4 (1 1/2x0.156) |

Parflange® 1025 machines flaring capacity for Triple-Lok®

| Tube material | Elect. power of machine | |
|------------------------------------|----------------------------|----------------------------|
| | 220 V 1.1 kW | 380 V 1.5 kW |
| Max. tube size mm (inch) | | |
| Steel ST37 | 38x4/42x3 (1 1/2x0.120) | 38x4/42x3 (1 1/2x0.120) |
| Steel ST52 | 38x4/42x3 (1 1/2x0.120) | 38x4/42x3 (1 1/2x0.120) |
| Stainless steel 304L/316L* | 38x4/42x3 (1 1/2x0.120) | 38x4/42x3 (1 1/2x0.120) |
| Stainless steel Duplex (or PW 400) | 38x3.6 | 38x3.6 |

Parflange® 50 machines flaring capacity for Triple-Lok®

| Tube material | Elect. power of machine |
|------------------------------------|-------------------------|
| | 220/380 V 4.5 kW |
| Max. tube size mm (inch) | |
| Steel TU 37 B | 38x4/42x3 (1 1/2x0.120) |
| Steel TU 52 B | 38x4/42x3 (1 1/2x0.120) |
| Stainless steel 304L/316L* | 38x4/42x3 (1 1/2x0.120) |
| Stainless steel Duplex (or PW 400) | 38x3.6 |

* Parflange® tools for stainless steel tubes have different dimensions and are specially coated. These tools are marked with suffix "SS".

Assembly tooling

Parflange® tool identification

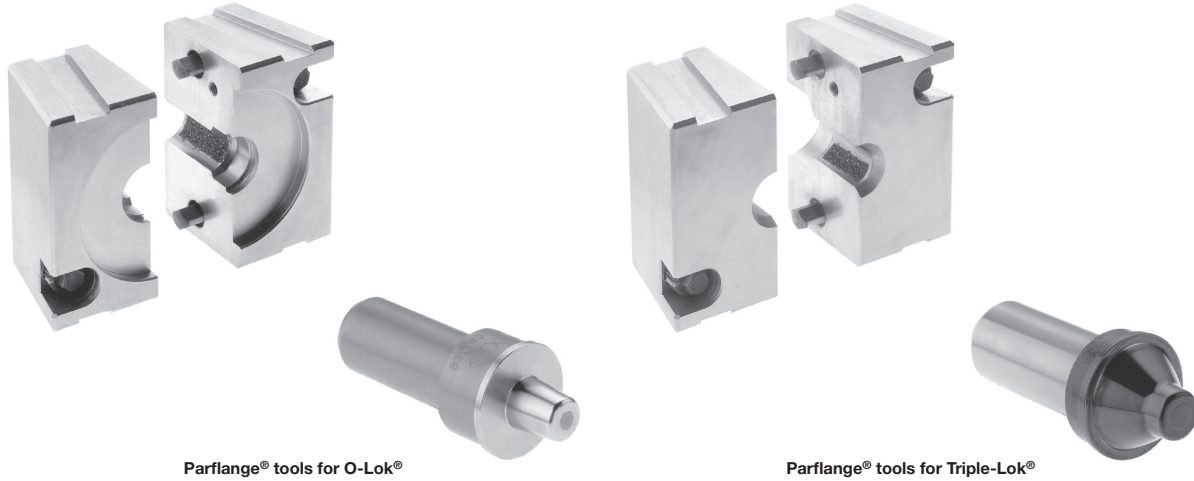

Parflange® tools for O-Lok®

Parflange® tools for Triple-Lok®

Tooling for metric tubing

Metric die numbering system

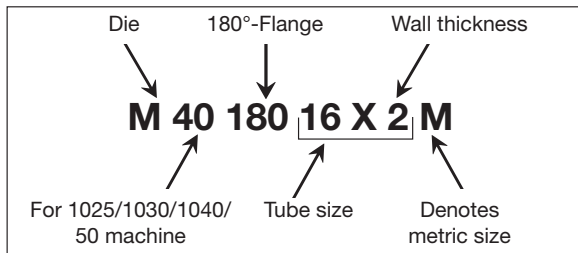

Metric pin numbering system

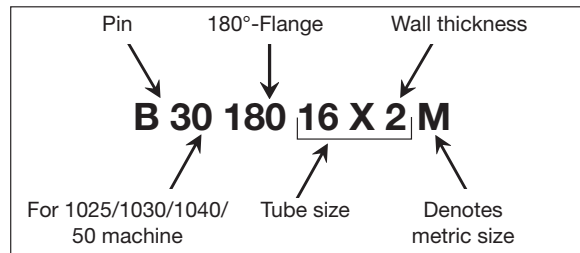

Tooling for inch tubing

Die numbering system

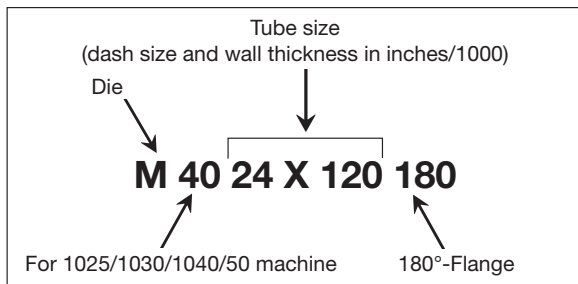

Pin numbering system

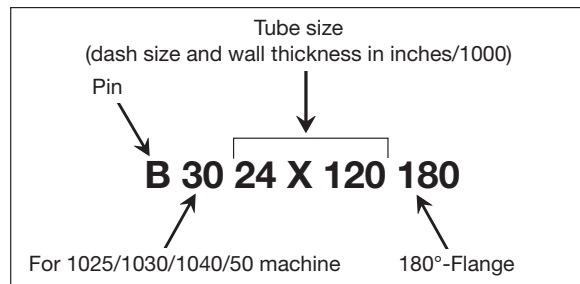

Parflange® tools for stainless steel tubes have different dimensions and are specially coated. These tools are marked with suffix "SS".

Tool lifetime

Assembly tools are subject of wear and must be regularly (max. 50 assemblies) cleaned and checked (Checking instructions see chapter E). Worn out tools can cause dangerous assembly failures and must be replaced in time. Maximum lifetime can be achieved by following factors:

- Regular cleaning and checking

- Clean and corrosion-protected storage
- Proper de-burring and cleaning of tube end
- Proper tool selection and operation
- Use of specified lubricant

Parflange® tools for O-Lok®

Parflange® tooling – Order codes for Parflange® 50/1040/1030/1025

90°-Flange-tool-selection (Metric tube)

| Tube size mm | Steel tube | | Stainless steel tube | |
|-----------------|--------------------------|--------------------------|--------------------------|--------------------------|
| | Flange pin Order code | Flange die Order code | Flange pin Order code | Flange die Order code |
| 06×1.0 | B3018006X1M | M4018006X1M | | |
| 06×1.5 | B3018006X1.5M | M4018006X1.5M | | |
| 08×1.0 | B3018008X1M | M4018008X1M | B3018008X1MSS | M4018008X1MSS |
| 08×1.5 | B3018008X1.5M | M4018008X1.5M | B3018008X1.5MSS | M4018008X1.5MSS |
| 10×1.0 | B3018010X1M | M4018010X1M | B3018010X1MSS | M4018010X1MSS |
| 10×1.5 | B3018010X1.5M | M4018010X1.5M | B3018010X1.5MSS | M4018010X1.5MSS |
| 10×2.0 | B3018010X2M | M4018010X2M | | |
| 12×1.0 | B3018012X1M | M4018012X1M | B3018012X1MSS | M4018012X1MSS |
| 12×1.5 | B3018012X1.5M | M4018012X1.5M | B3018012X1.5MSS | M4018012X1.5MSS |
| 12×2.0 | B3018012X2M | M4018012X2M | | |
| 15×1.0 | | | B3018015X1MSS | M4018015X1MSS |
| 15×1.5 | B3018015X1.5M | M4018015X1.5M | | |
| 15×2.0 | B3018015X2M | M4018015X2M | | |
| 16×1.5 | B3018016X1.5M | M4018016X1.5M | B3018016X1.5MSS | M4018016X1.5MSS |
| 16×2.0 | B3018016X2M | M4018016X2M | B3018016X2MSS | M4018016X2MSS |
| 16×2.5 | B3018016X2.5M | M4018016X2.5M | | |
| 18×1.5 | B3018018X1.5M | M4018018X1.5M | | |
| 18×2.0 | B3018018X2M | M4018018X2M | | |
| 20×2.0 | B3018020X2M | M4018020X2M | B3018020X2MSS | M4018020X2MSS |
| 20×2.5 | B3018020X2.5M | M4018020X2.5M | | |
| 20×3.0 | B3018020X3M | M4018020X3M | | |
| 22×2.0 | B3018022X2M | M4018022X2M | | |
| 22×2.5 | B3018022X2.5M | M4018022X2.5M | | |
| 25×2.5 | B3018025X2.5M | M4018025X2.5M | B3018025X2.5MSS | M4018025X2.5MSS |
| 25×3.0 | B3018025X3M | M4018025X3M | | |
| 28×2.0 | B3018028X2M | M4018028X2M | | |
| 28×2.5 | B3018028X2.5M | M4018028X2.5M | | |
| 30×2.0 | B3018030X2M | M4018030X2M | | |
| 30×3.0 | B3018030X3M | M4018030X3M | B3018030X3MSS | M4018030X3MSS |
| 30×4.0 | B3018030X4M | M4018030X4M | | |
| 32×3.0 | B3018032X3M | M4018032X3M | | |
| 32×4.0 | B3018032X4M | M4018032X4M | | |
| 35×3.0 | B3018035X3M | M4018035X3M | | |
| 38×3.0 | B3018038X3M | M4018038X3M | | |
| 38×4.0 | B3018038X4M | M4018038X4M | | |

Bold = Standard dimensions
Regular = Non standard dimensions

Tools for tube dimensions which are not listed must be inquired at Parker.

90°-Flange-tool-selection (Inch tube)

| Tube size inch | Steel tube | |
|-------------------|--------------------------|--------------------------|
| | Flange pin Order code | Flange die Order code |
| 1/4×0.035 | B3004X035180 | M4004X035180 |
| 1/4×0.049 | B3004X049180 | M4004X049180 |
| 3/8×0.035 | B3006X035180 | M4006X035180 |
| 3/8×0.049 | B3006X049180 | M4006X049180 |
| 3/8×0.065 | B3006X065180 | M4006X065180 |
| 1/2×0.035 | B3008X035180 | M4008X035180 |
| 1/2×0.049 | B3008X049180 | M4008X049180 |
| 1/2×0.065 | B3008X065180 | M4008X065180 |
| 5/8×0.065 | B3010X065180 | M4010X065180 |
| 5/8×0.083 | B3010X083180 | M4010X083180 |
| 3/4×0.065 | B3012X065180 | M4012X065180 |
| 3/4×0.083 | B3012X083180 | M4012X083180 |
| 3/4×0.095 | B3012X095180 | M4012X095180 |
| 3/4×0.120 | B3012X120180 | M4012X120180 |
| 1×0.065 | B3016X065180 | M4016X065180 |
| 1×0.095 | B3016X095180 | M4016X095180 |
| 1 1/4×0.120 | B3020X120180 | M4020X120180 |

Further tools for Inch tubing are available from Parker TFD Columbus!

Tool lifetime

Assembly tools are subject of wear and must be regularly (max. 50 assemblies) cleaned and checked (Checking instructions see chapter E). Worn out tools can cause dangerous assembly failures and must be replaced in time. Maximum lifetime can be achieved by following factors:

- Regular cleaning and checking
- Clean and corrosion-protected storage
- Proper de-burring and cleaning of tube end
- Proper tool selection and operation
- Use of specified lubricant

Assembly tooling

Parflange® tools for Triple-Lok®

Metric tube

| Tube size mm | Steel tube | | Stainless steel tube | |
|----------------------------|--|--|----------------------------------|--------------------------------------|
| | Flare pin Order code | Flare die Order code | Flare pin Order code | Flare die Order code |
| 06x1.0 06x1.5 | B3007406X1M B3007406X1.5M | M4007406M M4007406M | B3007406X1MSS | M4007406M |
| 08x1.0 08x1.5 | B3007408X1M B3007408X1.5M | M4007408M M4007408M | B3007408X1MSS B3007408X1.5MSS | M4007408M M4007408M |
| 10x1.0 10x1.5 | B3007410X1M B3007410X1.5M | M4007410M M4007410M | B3007410X1MSS B3007410X1.5MSS | M4007410M M4007410M |
| 12x1.0 12x1.5 12x2.0 | B3007412X1M B3007412X1.5M B3007412X2M | M4007412M M4007412M M4007412M | B3007412X1.5MSS | M4007412M |
| 15x1.5 15x2.0 | B3007415X1.5M B3007415X2M | M4007415M M4007415M | B3007415X1.5MSS | M4007415M |
| 16x1.5 16x2.0 | B3007416X1.5M B3007416X2M | M4007416M M4007416M | B3007416X2MSS | M4007416M |
| 18x1.5 18x2.0 | B3007418X1.5M B3007418X2M | M4007418M M4007418M | B3007418X1.5MSS | M4007418M |
| 20x2.0 20x2.5 | B3007420X2M B3007420X2.5M | M4007420M M4007420M | B3007420X2MSS B3007420X2.5MSS | M4007420M M4007420M |
| 22x1.5 22x2.0 22x2.5 | B3007422X1.5M B3007422X2M B3007422X2.5M | M4007422M M4007422M M4007422M | B3007422X1.5MSS | M4007422M |
| 25x2.5 25x3.0 | B3007425X2M B3007425X3M | M4007425M M4007425M | B3007425X2.5MSS | M4007425M |
| 28x2.0 28x2.5 | B3007428X2M B3007428X2.5M | M4007428M M4007428M | | |
| 30x3.0 | B3007430X3M | M4007430M | B3007430X3MSS | M4007430M |
| 32x3.0 | B3007432X3M | M4007432M | | |
| 35x3.0 | B3007435X3M | M4007435M | | |
| 38x3.0 38x4.0 | B3007438X3M B3007438X4M | M4007438M M4007438M | B3007438X4MSS | M4007438M |
| 42x3.0 42x4.0 | B3007442X3M B3007442X4M | M4007442M M4007442M | | |

Bold = Standard dimensions
 Regular = Non standard dimensions
 Tools for tube dimensions which are not listed must be inquired at Parker.

Inch tube

| Tube size inch | Steel tube | |
|-------------------|--------------------------|--------------------------|
| | Flange pin Order code | Flange die Order code |
| 1/4x0.049 | B3004X049074 | M4004074 |
| 3/8x0.049 | B3006X049074 | M4006074 |
| 3/8x0.065 | B3006X065074 | M4006074 |
| 1/2x0.065 | B3008X065074 | M4008074 |
| 5/8x0.065 | B3010X065074 | M4010074 |
| 5/8x0.095 | B3010X095074 | M4010074 |
| 3/4x0.095 | B3012X095074 | M4012074 |
| 1x0.109 | B3016X109074 | M4016074 |
| 1 1/4x0.120 | B3020X120074 | M4020074 |

Further tools for Inch tubing are available from Parker TFD Columbus!

Tool lifetime

Assembly tools are subject of wear and must be regularly (max. 50 assemblies) cleaned and checked (Checking instructions see chapter E). Worn out tools can cause dangerous assembly failures and must be replaced in time. Maximum lifetime can be achieved by following factors:

- Regular cleaning and checking
- Clean and corrosion-protected storage
- Proper de-burring and cleaning of tube end
- Proper tool selection and operation
- Use of specified lubricant

Lubricants

EO-NIROMONT lubricant for fitting assembly

EO-NIROMONT lubricant for flaring and forming tools

EO-NIROMONT are high performance lubricants specifically designed for the assembly of tube connections. They facilitate tightening using a low-torque when assembling joints by hand. In machine assembly, the use of EO-NIROMONT ensures that maximum tool-life is achieved. In forming processes, such as Parflange® or EO2-FORM, smooth and error-free sealing surfaces can be produced. Special additives prevent cold welding when working with stainless steel.

As opposed to when using Parker high performance lubricants, experience shows that the use of standard commercially available lubricants tend to lead to problems such as cold welding of forming tools, particularly when processing stainless steel tube. Parker high performance lubricants – EO-NIROMONT – are offered in different containers and viscosities so that you can purchase the appropriate product in a suitable container to meet your needs:

Liquid lubricant, plastic bottle (item: EONIROMONTFLUOSSX)

Parker high performance lubricant for the lubrication of threads, progressive rings and for all cold forming processes like Parflange® or EO2-FORM. The handy plastic bottle means that it can be applied directly where the lubrication is needed. EO-NIROMONT liquid should always be available at every assembly point where hydraulic connections are being made.

Liquid lubricant, refill package (Item: LUBSS)

Parker high performance lubricant for all cold forming processes like Parflange® or EO2-FORM. Its viscosity means that it is for use in automatic lubrication devices installed in Parflange machines. Absolutely essential for mechanical cold forming of stainless steel tubes.

Paste lubricant, tin

(Item: EONIROMONTPASTX)

Parker high performance lubricant for the lubrication of the threads of the pre-assembly tool VOMO. The paste is economical and provides durable thread lubrication. Not suited for use with forming tools, as dust and swarf will stick to it.

Liquid lubricant in a brush-in-cap can (item: EONIROMONTAPPLICATOR)

Thanks to a brush built into the screw cap, the practical EO-NIROMONT APPLICATOR enables the Parker high-performance lubricant to be applied accurately on the component. The plastic bottle can be used to refill the brush-in-cap can practically.

Features, advantages and benefits of NIROMONT lubricant:

1. **Highly effective** – EO-NIROMONT dramatically reduces assembly effort. This helps to prevent fitting failure resulting from insufficient assembly.
2. **Cost saving** – Tools in assembly machines will last much longer, resulting in high-quality tube forming with excellent sealing surface.
3. **No cold welding** – Cold welding of stainless steel threads is impossible when EO-Niromont is properly applied.
4. **Liquid** – Penetrates even small gaps.
5. **Paste** – Stays in place for a while. Ideal for application on pre-assembly tools.
6. **Compatible** – EO-NIROMONT and LUBSS do not effect fitting surfaces or seal materials.

Ordering

| Type | Order code |
|---|----------------------|
| EO-NIROMONT Assembly lubricant paste (100 g ⊕) | EONIROMONTPASTX |
| EO-NIROMONT Assembly lubricant liquid (250 cc) | EONIROMONTFLUOSSX |
| EO-NIROMONT Liquid lubricant in a brush-in-cap can (250 cc) | EONIROMONTAPPLICATOR |
| EO-NIROMONT Forming tool lubricant refill (1 L) | LUBSS |



EO-NIROMONT



EO-NIROMONT APPLICATOR



LUBSS



Assembly tooling

Cutting and bending tools

AV 6/42 – Tube saw square

Provides a neat and quick method of cutting tube at right angles. The exact cut is achieved by hardened guides. We recommend using deeper-section sawblades that cut in both directions for best results. The AV 6/42 can be used in a vice or just be clamped onto the tube for cutting.

Specifications:

Tube. O.D.: 6–42 mm
Weight: approx. 0.7 kg

| Type | Order code |
|-------------------------------|-------------|
| Tube cutting tool without saw | AV06/42KPLX |
| Spare hardened guides | AV06/4208X |

Features, advantages and benefits of tube saw square:

1. **Square cut** – Exact tube preparation greatly reduces leakage caused by assembly failures.
2. **Contour clamping** – Tube is not distorted by clamping.
3. **No vice required** – For workshop application AV 6/42 can simply be clamped onto the tube without using a vice or other attachment.
4. **Replaceable guides** – Worn out guides can easily be replaced to maintain neat cutting result.
5. **Light** – At only 0.7 kg, the AV 6/42 should be carried in the toolbox of every hydraulic tube fitter.

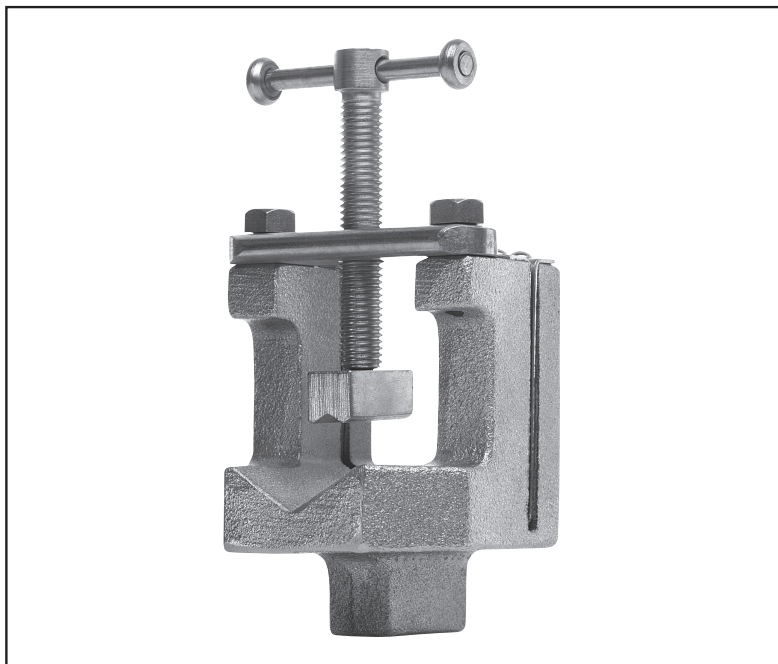

Cutting and bending tools

BAV 6/12 – Combined tube bending and cutting tool

The BAV 6/12 is a workshop device for neat tube cutting and simple but exact bending of small dimension EO-tube. Relatively small bending radii can be achieved.

The exact cut is achieved with hardened guides and using sawblades which are notched on both sides. The BAV 6/12 can be used in a vice or just be clamped onto a workbench.

Specifications:

Tube. OD: 6–12 mm

Weight: approx. 2 kg

| Type | Order code |
|--|----------------|
| Combined tube bending and cutting tool including 3 bending rolls for 6 to 12 mm tube and bending lever | BAV06/12KPLX |
| Spare Parts | |
| Spare hardened guide | BAV06/1206X |
| Bending roll 6/8 mm | BAV06/1209X |
| Bending roll 10 mm | BAV06/1210X |
| Bending roll 12 mm | BAV06/1211X |
| Fixing roll | BAV06/1207X |
| Lever complete | BAV06/1220KPLX |

| Bending dimensions in mm | | | |
|--------------------------|-------|----|----|
| Rolls for tube O.D. | 6/8 | 10 | 12 |
| Bending radius | 19/20 | 25 | 26 |

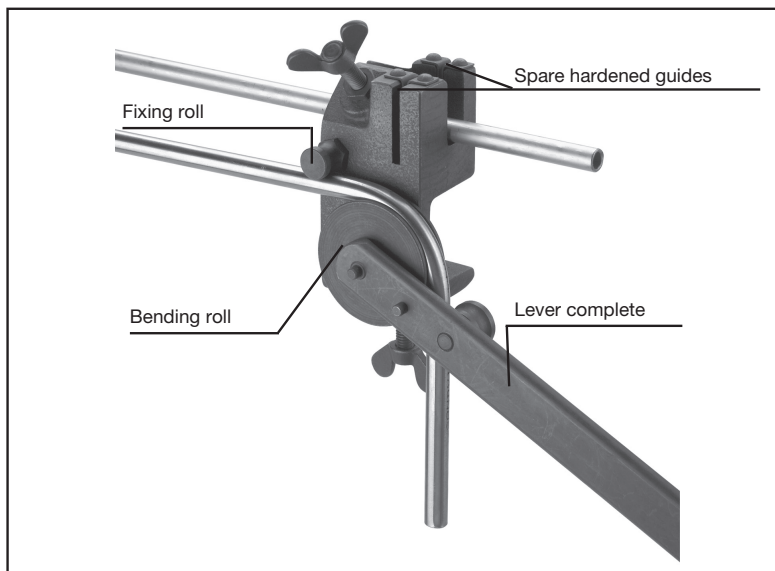

Features, advantages and benefits of combined tube bending and cutting tool:

- Bending and cutting** – The BAV 6/12 is a light multi-purpose tool for all small dimension tube assemblies.
- Square cut** – Exact tube preparation greatly reduces leakage caused by assembly failures.
- No vice required** – For workshop application BAV 6/12 can simply be clamped onto a workbench.
- Small bending radii** – Compact tube bends allow tight assemblies.
- Light** – At only 2 kg, the BAV 6/12 can be easily brought to the assembly site.
- Optimised bending roller contour** – Special shape of bending roller allows small bends without tube flattening.

In-Ex tube deburring tool 226

Material: Plastic, aluminum with hardened steel blades

Tube-O.D.: 4 to 42 mm

| Type | Order code |
|--|------------|
| Tube deburrer plastic, 4-38 mm, 3 blades | 226B |
| Tube deburrer aluminium, 10-54 mm, many blades | 226Z |

Features, advantages and benefits of In-Ex tube deburring tool 226:

- Proper deburring** – Exact tube preparation greatly reduces leakage

caused by assembly failures.



H51

Catalogue 4100/UK

Assembly tooling

Cutting and bending tools

BV 6/18 – Tube bending tool

The BV 6/18 is a flexible bending device for simple but exact bending of EO-tube up to 18 mm tube O.D. The high quality bending results are achieved by 6 interchangeable bending rollers.

The fixing roll can be individually adjusted to produce a precise bend transition.

Specifications:

Tube-O.D.: 6–18 mm

Weight: approx. 4 kg

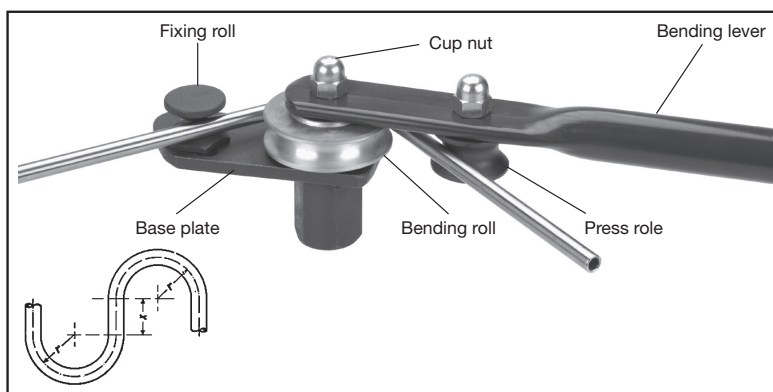

| Type | Order code |
|---|---------------|
| Tube bending tool complete device including 6 bending rolls for 6 to 18 mm tube and bending lever | BV06/18KPLX |
| Spare Parts | |
| Bending roll 6/8 mm | BV06/1812X |
| Bending roll 10/12 mm | BV06/1803X |
| Bending roll 14 mm | BV06/1804X |
| Bending roll 15 mm | BV06/1805X |
| Bending roll 16 mm | BV06/1806X |
| Bending roll 18 mm | BV06/1807X |
| Fixing roll | BV06/1802X |
| Lever complete | BV06/1808KPLX |

| Bending dimensions in mm | | |
|--------------------------|------|-----|
| Rolls for tube O.D. | r | ≈ X |
| 6 | 33.0 | 35 |
| 8 | 34.0 | 35 |
| 10 | 35.5 | 35 |
| 12 | 36.5 | 35 |
| 14 | 36.5 | 35 |
| 15 | 44.0 | 38 |
| 16 | 44.0 | 38 |
| 18 | 51.5 | 42 |

Features, advantages and benefits of tube-bending tool:

1. **Vice mounted** – For easy workshop use, the BV can be clamped into a vice.
2. **Small bending radii** – Compact tube bends allow tight assemblies.
3. **Light** – At only 4 kg, the BV 6/18 can be easily brought to each assembly site.
4. **Optimised bending roller contour** – Special shape of bending roller allows small bends without tube flattening.

BV 20/25 – Tube bending tool

The BV 20/25 allows bending of medium size tube at the assembly site. The bending lever shows two universal studs. A bar extension can either be ordered or locally made.

Specifications:

Tube-O.D.: 20–25 mm
 3 bending segments: 20, 22, 25 mm
 Bending radius: $r = 86,5$ mm
 $x = 52$ mm
 Weight: approx. 15 kg (with-out bar extension)

| Type | Order code |
|---|---------------|
| BV 20/25 Tube bending tool bending device including 3 bending segments for tube O.D. 20 to 25 mm including bending lever without bar extension tube | BV20/25KPLX |
| Spare Parts | |
| Bending segment 20 mm | BV20/2501X |
| Bending segment 22 mm | BV20/2502X |
| Bending segment 25 mm | BV20/2503X |
| Fixing arm | BV20/2505X |
| Lever complete | BV20/2506KPLX |
| Bar extension tube | BV20/2510X |

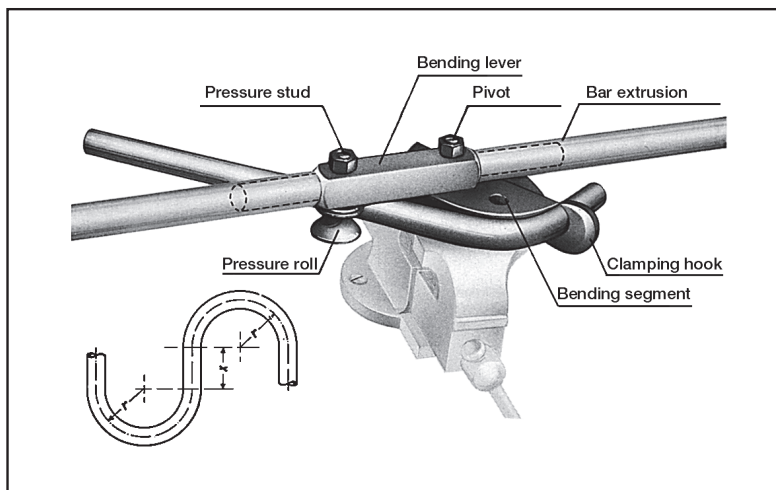
H

Features, advantages and benefits of tube-bending tool:

- Rigid design** – The solid design and the bar extension allow manual bending without heating the tube.
- Optimised bending roller contour** – Special shape of bending roller allows small bends without tube flattening.
- Shaped clamping** – Tube is not distorted by clamping.
- Small bending radii** – Compact tube bends allow for compact assemblies.
- Vice mounted** – For easy workshop use, the BV can be clamped into a vice.

Assembly tooling

Hand-tools

Par-Lok wrench

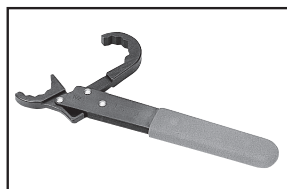

Par-Lok wrench

360° Snap-action ratchet wrench for inch sizes from 3/8" to 2 1/4" across flats. Inch sizes meet US government specifications and are listed as NSN-5120-00-474-7227.

Easy fitting assembly

Easy access ratchet wrench speeds fittings installation in tight locations. Rugged, snap-action jaws can be opened over tube lines, locked onto fitting hex and ratcheted within 1/8 turn. Full six point contact prevents fitting distortion common with wrench slippage. Ideal for tube line installations where compact runs required multiple fittings make-up, disassembly and remakes.

Specifications

Par-Lok wrenches are available individually. Par-Lok jaws are constructed from drop-forged, high carbon steel material with a black conversion coat finish. Par-Lok handles are made from heavy gauge steel material, heat treated and with a corrosion resistant black finish. Solid stainless steel rivets and tempered jaw springs are designed into every wrench for maximum strength.

Features, advantages and benefits of Par-Lok wrench:

1. **360°** – No slipping and hexagon damage.
2. **Snap-mechanism** – Ideal for tube fitting assembly.
3. **Light** – Par-Lok wrenches belong in the standard toolbox of each fitting engineer.

| Inch Sizes | | | |
|------------|------------|----------|------------|
| Hex Size | Order code | Hex Size | Order code |
| 3/8 | 860062-6 | 1 1/8 | 860062-18 |
| 7/16 | 860062-7 | 1 1/4 | 860062-20 |
| 1/2 | 860062-8 | 1 3/8 | 860062-22 |
| 9/16 | 860062-9 | 1 1/2 | 860062-24 |
| 5/8 | 860062-10 | 1 5/8 | 860062-26 |
| 1 1/16 | 860062-11 | 1 7/8 | 860062-30 |
| 3/4 | 860062-12 | 2 | 860062-32 |
| 1 3/16 | 860062-13 | 2 1/4 | 860062-36 |
| 7/8 | 860062-14 | | |
| 1 5/16 | 860062-15 | | |
| 1 | 860062-16 | | |

WZK – Tool boxes

Tools which are regularly used for tube preparation and bending are available in organized tool boxes. Two sets are available:

Features, advantages and benefits:

1. **Well organised** – Nothing gets dirty, damaged, lost or forgotten.
2. **Practical** – In one box you take everything to the assembly site.
3. **Rigid** – The solid metal box is suitable for daily workshop use.

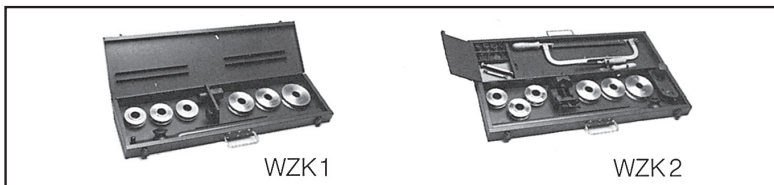

| Type | Content | Order code |
|--------------|--|------------|
| Toolbox WZK1 | BV6/18 tube bending tool | WZK1KOMPLX |
| Toolbox WZK2 | BV6/18 tube Bending tool, AV6/42 tube saw square, Hacksaw, Flat file, Deburring tool, fixture for assembly cones VOMO* and cone-template KONU* | WZK2KOMPLX |

*VOMO/KONU are not part of the delivery.

H

Assembly tooling

O-ring assembly tools

CORG O-ring installation tool for O-Lok®

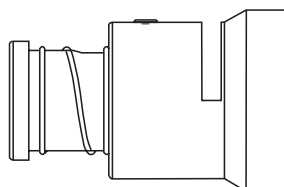

Parker's CORG Assembly Tools are designed to facilitate the installation of the O-ring into the half-dovetail groove of the O-ring face seal fitting. They are available in sizes –4 to –32 (6 mm to 50 mm/1/4" to 2" tube).

Ordering

| CORG tool Order code | Fitting size | O-ring size |
|----------------------|--------------|-------------|
| CORG-4 | – 4 | 2-011 |
| CORG-6 | – 6 | 2-012 |
| CORG-8 | – 8 | 2-014 |
| CORG-10 | –10 | 2-016 |
| CORG-12 | –12 | 2-018 |
| CORG-16 | –16 | 2-021 |
| CORG-20 | –20 | 2-025 |
| CORG-24 | –24 | 2-029 |
| CORG-32 | –32 | 2-135 |

Operation

See chapter F "Fitting assembly" for detailed instructions

The CORG assembly tool is easy to use and can be operated in just a few steps:

1. Insert the O-ring into the slot located on the side of the tool.
2. Position the open end of the tool over the ORFS end of the fitting.
3. With the fitting end bottomed inside the tool, push the piston of the tool until the O-ring is released into the fitting groove.

O-ring pick for O-Lok®

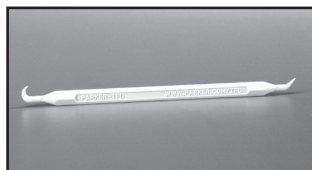

O-ring pick

A plastic O-ring pick to allow easy removal of O-rings without causing damage to the fitting.

Ordering

| Type | Order code |
|----------------------------|------------|
| Plastic O-ring pick device | O-RINGPICK |

Features, advantages and benefits of O-Ring installation tools

1. **Special** – O-ring installation tools are especially designed for O-Lok® fittings with CORG groove. O-rings are not torn or damaged at assembly.
2. **Cost saving** – O-ring installation tools are easy to use and save time and cost when O-rings need to be assembled.

Port cutting tools

Counterbore tools and thread taps for metric ports

For manufacturing metric ports to ISO 6149 (Details see chapter D).

These tools allow correct manufacturing of metric port connections. Counterbore tools are made of high speed tool steel (HSS).

Ordering counterbore tools

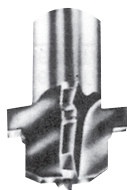

| ISO 6149 Port size | Order code |
|--------------------------|----------------------------------|
| | Large Spot face ¹⁾ |
| M 08×1.0 | R1449A |
| M 10×1.0 | R1450A |
| M 12×1.5 | R1451A |
| M 14×1.5 | R1452A |
| M 16×1.5 | R1453A |
| M 18×1.5 | R1454A |
| M 22×1.5 | R1455A |
| M 27×2.0 | R1456A |
| M 33×2.0 | R1457A |
| M 42×2.0 | R1458A |
| M 48×2.0 | R1459A |

1) with ID-groove

H

Counterbore tools and thread taps for straight SAE thread ports

For manufacturing UNF ports to SAE J 1926-1 (details see chapter D)

These tools allow correct manufacturing of UNF port connections. Counterbore tools and thread taps are made of high speed tool steel (HSS).

counterbore tools

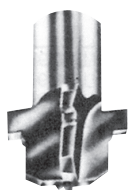

| Use with UNF thread size | SAE dash size | Order code |
|--------------------------------|---------------------|---------------|
| 5/16-24 | 2 | Y-34730 |
| 3/8-24 | 3 | Y-34731 |
| 7/16-20 | 4 | Y-34732 |
| 1/2-20 | 5 | Y-34733 |
| 9/16-18 | 6 | Y-34734 |
| 3/4-16 | 8 | Y-34735 |
| 7/8-14 | 10 | Y-34736 |
| 1 1/16-12 | 12 | Y-34737 |
| 1 3/16-12 | 14 | Y-34738 |
| 1 5/16-12 | 16 | Y-34739 |
| 1 5/8-12 | 29 | Y-34740 |
| 1 7/8-12 | 24 | Y-34741 |
| 2 1/2-12 | 32 | Y-34743 |

thread taps

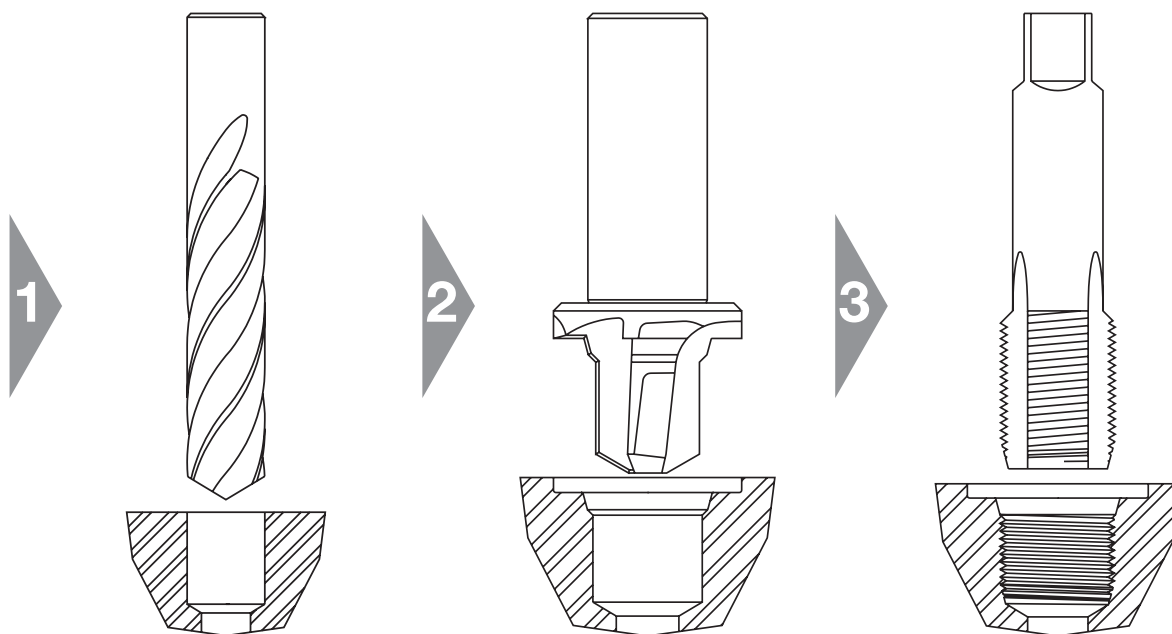

| Use with UNF thread size | SAE dash size | Order code |
|--------------------------------|---------------------|------------------|
| 5/16-24 | 2 | 5/16X24 UNF-2B |
| 3/8-24 | 3 | 3/8X24 UNF-2B |
| 7/16-20 | 4 | 7/16X20 UNF-2B |
| 1/2-20 | 5 | 1/2X20 UNF-2B |
| 9/16-18 | 6 | 9/16X18 UNF-2B |
| 3/4-16 | 8 | 3/4X16 UNF-2B |
| 7/8-14 | 10 | 7/8X14 UNF-2B |
| 1 1/16-12 | 12 | 1 1/16X12 UNF-2B |
| 1 3/16-12 | 14 | 1 3/16X12 UNF-2B |
| 1 5/16-12 | 16 | 1 5/16X12 UNF-2B |
| 1 5/8-12 | 29 | 1 5/8X12 UNF-2B |
| 1 7/8-12 | 24 | 1 7/8X12 UNF-2B |
| 2 1/2-12 | 32 | 2 1/2X12 UNF-2B |

Operation of port cutting tools

1. Pilot hole drilling
2. Port counterboring
3. Thread tapping
Note:

All dimensions must be according to relevant standards. See chapter D for details.

It is necessary to create a spotface surface which is flat and perpendicular to the port. Smooth finish to prevent leakage or O-ring extrusion.

Parker counterbore tools are made from high speed tool steel (HSS). Regular HSS port tapping tools are intended for workshop use and repair.

Maximum lifetime of Parker counterbores can be achieved by:

- use for cutting mild steel or aluminium only
- staying within recommended cutting speed for HSS / port material
- sufficient lubrication and cooling
- workshop use and repair only

For serial production of hydraulic ports, these Parker workshop tools are not suitable.

For production, Parker generally recommends to use hard carbide alloy.

Thread identification

Thread identification kit

The thread identification tools are beneficial in the assistance of the identification of international threads such as:

- European threads
(Metric, BSPP, BSPT threads) and
- U.S. threads
(NPT and SAE straight threads UNF)

The Thread Identification Kit is equipped with a set of calipers, thread profiles, and an instruction booklet.

The components of the thread ID Kit are no high precision gauges but simple instruments for workshop use.

Ordering

| Type | Order code |
|---------------------------|------------|
| Thread identification kit | MIK-1 |

Attention: The kit is only available in english!

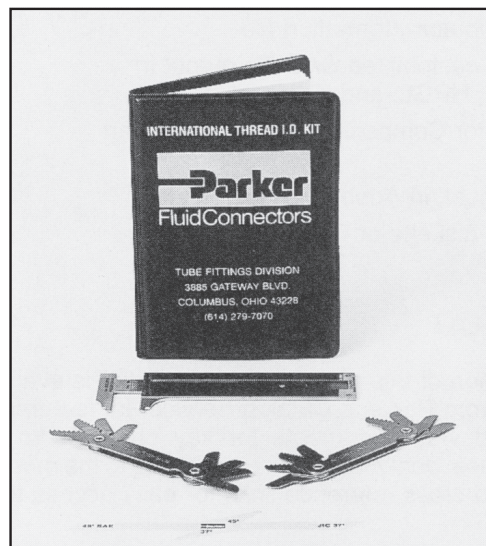
H

Portboard

Portboards are suitable for thread identification of male stud connectors. The two portboards are machined with female threads for quick and easy identification by simply screwing the appropriate male port end.

- European
(Metric, BSPP/BSPT threads)
- U.S.
(NPT and SAE straight threads UNF)

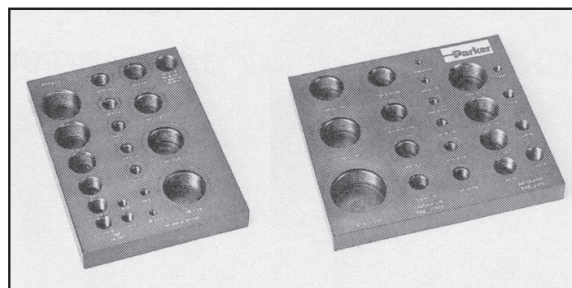

Ordering

| Type | Order code |
|--|-------------|
| Portboard for NPT and SAE straight threads | PORTBOARD A |
| Portboard for Metric and BSPP/BSPT threads | PORTBOARD B |

Assembly tooling

Sample case for product presentation

This sample case assists in product presentation. A sample of all HPCE tube fitting systems is included as part of the contents. Individual samples of necessary components such as nuts and rings are provided. All components are clearly arranged in stable, high-quality cases.

Features, advantages and benefits

1. **Valuable sales assistance** - with this sample case you can clearly demonstrate the function and the special features, advantages, and benefits of the Parker HPCE-fitting components.
2. **Practical** - the sample case is incredibly light and can easily be taken on any customer visit. Distributors use the case as a sales aid in stores.
3. **Efficient** - the case can be used quick and with little effort
4. **Durable** - the components in the case are made entirely of stainless steel, are robust, and shine just as much after years of use as they did when they were new.
5. **Dry Technology** - the sample case is a practical and powerful sales aid. The components of all fitting types-whether a cutting ring system or *Dry Technology* - are arranged clearly.



Ordering

| Type | Order code |
|------------------|-----------------|
| HPCE sample case | TFDE-SAMPLECASE |







EO[®] Ermeto Original
DIN fittings



DIN fittings

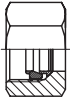
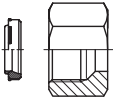

Visual index

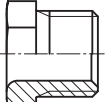
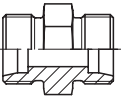
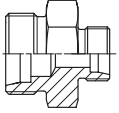
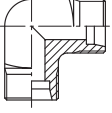
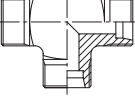
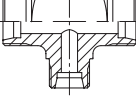
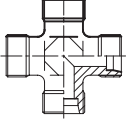
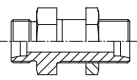
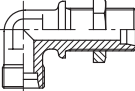
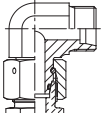
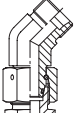
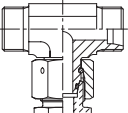
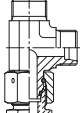
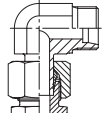
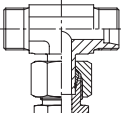
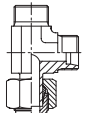
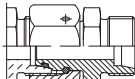
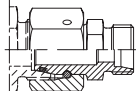
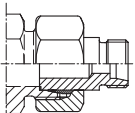
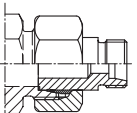
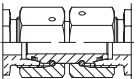
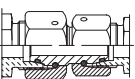
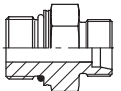
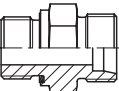
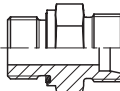
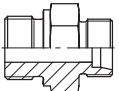
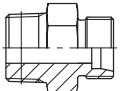
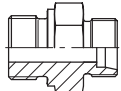
| | | | | | | |
|---------------------|---|---|---|--|---|--|
| Fitting components |  FM p. 110 |  FORM p. 112 |  M p. 114 |  D p. 115 |  PSR p. 115 |  DPR p. 116 |
| |  S p. 117 | | | | | |
| Tube to tube |  G p. 118 |  GR p. 119 |  W p. 120 |  T p. 121 |  TR p. 122 |  K p. 124 |
| |  SV p. 125 | |  WSV p. 126 | | | |
| Tube to swivel |  EW p. 127 |  EV p. 128 |  ET p. 129 |  EL p. 130 |  EVW p. 131 |  EVT p. 132 |
| |  EVL p. 133 |  DA p. 134 |  RED p. 135 |  KOR (Steel/Brass) p. 139 |  KOR (Stainless steel) p. 142 | |
| Swivel to swivel |  GZ p. 144 | |  GZR p. 145 | | | |
| Male stud connector |  GEO p. 147 |  GE-M-ED p. 148 |  GE-R-ED p. 149 |  GE-R p. 151 |  GE-R(KEG) p. 153 |  GE-M p. 154 |

Visual index

| | | | | | | |
|---------------------|------------------------------------|------------------------------------|----------------------------------|----------------------------------|-----------------------------------|-----------------------------------|
| Male stud connector | <p>GE-M(KEG) p. 155</p> | <p>GE-UNF/UN p. 156</p> | <p>GE-NPT p. 157</p> | <p>EGEO p. 159</p> | <p>EGE-M-ED p. 160</p> | <p>EGE-R-ED p. 161</p> |
| | <p>EVGE-M-ED p. 162</p> | <p>EVGE-R-ED p. 163</p> | <p>EGE-NPT p. 164</p> | | | |
| Swivel adjustable | <p>EW-M-ED p. 165</p> | <p>EW-R-ED p. 166</p> | <p>EV-M-ED p. 167</p> | <p>EV-R-ED p. 168</p> | <p>ET-M-ED p. 169</p> | <p>ET-R-ED p. 170</p> |
| | <p>EL-M-ED p. 171</p> | <p>EL-R-ED p. 172</p> | <p>EVW-M p. 173</p> | <p>EVW-R p. 174</p> | <p>EVT-M p. 175</p> | <p>EVT-R p. 176</p> |
| | <p>EVL-M p. 177</p> | <p>EVL-R p. 178</p> | | | | |
| Locknut adjustable | <p>WEE-R p. 179</p> | <p>WEE-OR p. 180</p> | <p>WEE-M p. 180</p> | <p>WEE-UNF p. 180</p> | <p>TEE-OR p. 180</p> | <p>TEE-M p. 180</p> |
| | <p>TEE-R p. 180</p> | <p>TEE-UNF p. 180</p> | <p>LEE-OR p. 180</p> | <p>LEE-M p. 180</p> | <p>LEE-R p. 180</p> | <p>LEE-UNF p. 180</p> |
| | <p>VEE-OR p. 180</p> | <p>VEE-M p. 180</p> | <p>VEE-R p. 180</p> | <p>VEE-UNF p. 180</p> | | |









DIN fittings

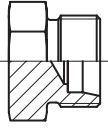
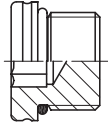
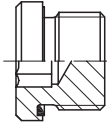
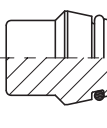
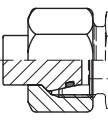
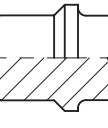
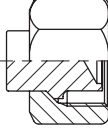

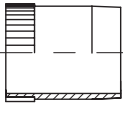
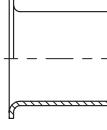
Visual index

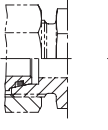
| | | | | | | |
|------------------------|-------------------------------------|-------------------------------------|-------------------------------------|-------------------------------------|-------------------------------------|--------------------------------------|
| Banjo fittings | <p>WH-M-KDS p. 181</p> | <p>WH-M p. 182</p> | <p>WH-R-KDS p. 183</p> | <p>WH-R p. 184</p> | <p>TH-M-KDS p. 185</p> | <p>TH-M p. 186</p> |
| | <p>TH-R-KDS p. 187</p> | <p>TH-R p. 188</p> | <p>SWVE-M-KDS p. 189</p> | <p>SWVE-R-KDS p. 190</p> | | |
| Non adjustable | <p>WE-NPT p. 191</p> | <p>WE-M(KEG) p. 192</p> | <p>WE-M p. 193</p> | <p>WE-R p. 194</p> | <p>WE-R (KEG) p. 195</p> | <p>TE-M p. 196</p> |
| | <p>TE-R p. 197</p> | <p>TE-R (KEG) p. 198</p> | <p>TE-M(KEG) p. 199</p> | <p>LE-M p. 1100</p> | <p>LE-R p. 1101</p> | <p>LE-R (KEG) p. 1102</p> |
| | <p>LE-M(KEG) p. 1103</p> | | | | | |
| Tube to female | <p>GAI-M p. 1104</p> | <p>GAI-R p. 1105</p> | <p>GAI-NPT p. 1106</p> | | | |
| Port reducers | <p>RI-ED p. 1107</p> | <p>RI p. 1108</p> | | | | |
| Pressure gauge adapter | <p>MAV p. 1109</p> | <p>MAVE p. 1110</p> | | | | |

Visual index

| | | | | | | |
|------------|--|---|---|---|--|---|
| Plugs |  <p>ROV p. I111</p> |  <p>VSTI M-OR p. I112</p> |  <p>VSTI M/R-ED p. I113</p> |  <p>VKA p. I114</p> |  <p>VKAM p. I115</p> |  <p>BUZ p. I116</p> |
| |  <p>BUZM p. I117</p> | | | | | |
| Components |  <p>GM p. I118</p> |  <p>VH p. I119</p> |  <p>E p. I120</p> |  <p>DOZ p. I121</p> |  <p>ED p. I122</p> |  <p>OR p. I123</p> |
| |  <p>DKI p. I125</p> |  <p>KDS p. I126</p> |  <p>KD p. I127</p> |  <p>DKA p. I128</p> | | |



DIN fittings

How to order



DIN fittings

GE-R-ED Male stud connector

Male BSPP thread – ED-seal (ISO 1179) / EO 24° cone end

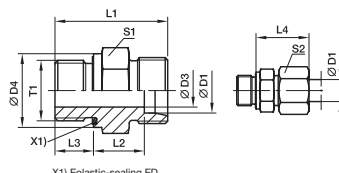

X1) Elastic-sealing ED

| Series | D1 | T1 | D3 | D4 | L1 | L2 | L3 | L4 | S1 | S2 | Weight g/1 piece | Order code* | CF | 71 | MS |
|------------------|----|-----------|----|----|------|------|------|----|----|----|------------------|------------------------|-----|-----|-----|
| LL ²⁾ | 04 | G 1/8 A | 3 | 14 | 20.0 | 9.5 | 6.5 | 19 | 14 | 10 | 10 | GE04LLREDOMD | 100 | 100 | 63 |
| | 06 | G 1/8 A | 4 | 14 | 20.0 | 8.0 | 6.5 | 20 | 14 | 12 | 11 | GE06LLREDOMD | 100 | 100 | 63 |
| L ³⁾ | 06 | G 1/8 A | 4 | 14 | 23.5 | 8.5 | 8.0 | 23 | 14 | 14 | 13 | GE06LR1/4EDOMD | 500 | 315 | 200 |
| | 06 | G 1/4 A | 4 | 19 | 29.0 | 10.0 | 12.0 | 25 | 19 | 14 | 28 | GE06LR3/4EDOMD | 500 | 315 | 200 |
| | 06 | G 3/8 A | 4 | 22 | 30.5 | 11.5 | 12.0 | 26 | 22 | 14 | 44 | GE06LR3/8EDOMD | 420 | 315 | 200 |
| | 06 | G 1/2 A | 4 | 27 | 33.0 | 12.0 | 14.0 | 27 | 27 | 14 | 61 | GE06LR1/2EDOMD | 400 | 315 | 200 |
| | 08 | G 1/4 A | 6 | 19 | 29.0 | 10.0 | 12.0 | 25 | 19 | 17 | 27 | GE08LR1/4EDOMD | 500 | 315 | 200 |
| | 08 | G 1/8 A | 4 | 14 | 24.5 | 9.5 | 8.0 | 24 | 14 | 17 | 16 | GE08LR1/8EDOMD | 500 | 315 | 200 |
| | 08 | G 3/8 A | 6 | 22 | 30.5 | 11.5 | 12.0 | 26 | 22 | 17 | 45 | GE08LR3/8EDOMD | 420 | 315 | 200 |
| | 08 | G 1/2 A | 6 | 27 | 33.0 | 12.0 | 14.0 | 27 | 27 | 17 | 74 | GE08LR1/2EDOMD | 400 | 315 | 200 |
| | 10 | G 1/4 A | 6 | 19 | 30.0 | 11.0 | 12.0 | 26 | 19 | 19 | 29 | GE10LR1/4EDOMD | 500 | 315 | 200 |
| | 10 | G 1/8 A | 4 | 14 | 25.5 | 10.5 | 8.0 | 25 | 17 | 19 | 21 | GE10LR1/8EDOMD | 500 | 315 | 200 |
| | 10 | G 3/8 A | 8 | 22 | 31.5 | 12.5 | 12.0 | 27 | 22 | 19 | 43 | GE10LR3/8EDOMD | 420 | 315 | 200 |
| | 10 | G 1/2 A | 8 | 27 | 34.0 | 13.0 | 14.0 | 28 | 27 | 19 | 71 | GE10LR1/2EDOMD | 400 | 315 | 200 |
| | 12 | G 3/8 A | 9 | 22 | 31.5 | 12.5 | 12.0 | 27 | 22 | 22 | 41 | GE12LR1/4EDOMD | 400 | 315 | 200 |
| | 12 | G 1/8 A | 4 | 14 | 26.5 | 11.5 | 8.0 | 26 | 19 | 22 | 26 | GE12LR1/8EDOMD | 420 | 315 | 200 |
| | 12 | G 1/4 A | 6 | 19 | 31.0 | 12.0 | 12.0 | 27 | 19 | 22 | 32 | GE12LR3/4EDOMD | 400 | 315 | 200 |
| | 12 | G 1/2 A | 10 | 27 | 34.0 | 13.0 | 14.0 | 28 | 27 | 22 | 51 | GE12LR1/2EDOMD | 315 | 200 | 100 |
| | 12 | G 3/4 A | 10 | 32 | 37.0 | 14.0 | 16.0 | 29 | 32 | 22 | 71 | GE12LR3/8EDOMD | 160 | 100 | 100 |
| | 15 | G 1/2 A | 11 | 27 | 35.0 | 14.0 | 14.0 | 29 | 27 | 27 | 77 | GE15LR1/2EDOMD | 315 | 200 | 100 |
| | 15 | G 3/8 A | 9 | 22 | 32.5 | 13.5 | 12.0 | 29 | 24 | 27 | 77 | GE15LR3/8EDOMD | 315 | 200 | 100 |
| | 15 | G 3/4 A | 12 | 32 | 38.0 | 15.0 | 16.0 | 30 | 32 | 27 | 113 | GE15LR1/4EDOMD | 160 | 100 | 100 |
| | 18 | G 1/2 A | 14 | 27 | 36.0 | 14.5 | 14.0 | 31 | 27 | 32 | 77 | GE18LR1/2EDOMD | 400 | 315 | 200 |
| | 18 | G 3/8 A | 9 | 22 | 33.5 | 14.0 | 12.0 | 30 | 27 | 32 | 66 | GE18LR3/4EDOMD | 400 | 315 | 200 |
| | 18 | G 3/4 A | 15 | 32 | 38.0 | 14.5 | 16.0 | 31 | 32 | 32 | 110 | GE18LR1/4EDOMD | 250 | 160 | 100 |
| | 22 | G 3/8 A | 18 | 32 | 40.0 | 16.5 | 16.0 | 33 | 32 | 36 | 102 | GE22LR1/4EDOMD | 250 | 160 | 100 |
| | 22 | G 1/2 A | 14 | 27 | 36.0 | 16.5 | 14.0 | 33 | 32 | 36 | 91 | GE22LR1/2EDOMD | 250 | 160 | 100 |
| | 22 | G 1 A | 19 | 40 | 43.0 | 17.5 | 18.0 | 34 | 41 | 36 | 189 | GE22LR1/4EDOMD | 250 | 160 | 100 |
| | 28 | G 1 A | 23 | 40 | 43.0 | 17.5 | 18.0 | 34 | 41 | 41 | 170 | GE28LR1/4EDOMD | 250 | 160 | 100 |
| | 28 | G 3/4 A | 18 | 32 | 41.0 | 17.5 | 16.0 | 34 | 41 | 41 | 159 | GE28LR3/4EDOMD | 250 | 160 | 100 |
| | 28 | G 1 1/4 A | 24 | 50 | 46.0 | 18.5 | 20.0 | 35 | 50 | 41 | 316 | GE28LR11/4EDOMD | 250 | 160 | 100 |
| | 35 | G 1 1/4 A | 30 | 50 | 48.0 | 17.5 | 20.0 | 39 | 50 | 50 | 272 | GE35LR1/4EDOMD | 250 | 160 | 100 |
| | 35 | G 1 A | 23 | 40 | 46.0 | 17.5 | 18.0 | 39 | 46 | 50 | 226 | GE35LR1/2EDOMD | 250 | 160 | 100 |
| | 35 | G 1 1/2 A | 30 | 55 | 52.0 | 19.5 | 22.0 | 41 | 55 | 50 | 423 | GE35LR11/2EDOMD | 250 | 160 | 100 |
| | 42 | G 1 1/2 A | 36 | 55 | 52.0 | 19.0 | 22.0 | 42 | 55 | 60 | 343 | GE42LR1/4EDOMD | 250 | 160 | 100 |
| | 42 | G 1 A | 23 | 40 | 48.0 | 19.0 | 18.0 | 42 | 55 | 60 | 324 | GE42LR1/2EDOMD | 250 | 160 | 100 |
| | 42 | G 1 1/4 A | 30 | 50 | 48.0 | 19.0 | 20.0 | 42 | 55 | 60 | 348 | GE42LR11/4EDOMD | 250 | 160 | 100 |

¹⁾ Pressure shown = item deliverable

²⁾ LL = very light series; ³⁾ L = light series

PN (bar) = PN (MPa) / 10

Delivery without nut and ring. Information on ordering complete fittings or alternative sealing materials see page 17.

*Please add the suffixes below according to the material/surface required.

| | | |
|---------------------------------|---------------|---|
| Material | GE18LREDOMDCF | Standard sealing material (no additional suffix needed) |
| Steel, zinc plated, Cr(VI)-free | GE18LREDOMD71 | NBR |
| Stainless Steel | GE18LREDOMDMS | VIT |
| Brass | | NBR |

The right way to order made easy!

Step 1 Selecting order code

- 1.1 All fitting sizes available in our fitting program are clearly listed in the index at the front of this catalogue.
- 1.2 Open the catalogue at the corresponding page containing detailed information of the product of your choice.
- 1.3 Select the required fitting size! The basic order code is printed in bold type on the right-hand side of the table of dimensions.

Example: **GE16SREDOMD**

Step 2 Selecting material, surface and sealing-material

Now simply add the corresponding code for the surface and material variant of the product you require to the basic order code. This code is contained in the table printed at the bottom of every page.

2.1 Alternative sealing material

Example: Cr(VI)-free steel fitting with ED-seal in FKM material.
GE16SRED+OMD+VIT+CF = GE16SREDVITOMDCF

Example: Stainless steel fitting with ED-seal in NBR material (e. g. Perbunan).
GE16SREDOMD+NBR+71 = GE16SREDNBROMD71

Step 3 When ordering fittings complete with nuts and rings

- 3.1. Metal sealed cutting rings PSR/DPR/D: For these types please delete the 'OMD' or 'X' suffixes.
 Example: **GE16SREDCF**
- 3.2. Soft sealed EO-2 functional nut: For these types please delete the 'OMD' or 'X' suffixes and add a 'Z' before the series suffix (LL, L, S)
 Example: **order with EO-2 functional nut**
GE16(+Z)SREDCF = GE16ZSREDCF

Perbunan = registered trademark of Bayer





How to order EO-Fittings:

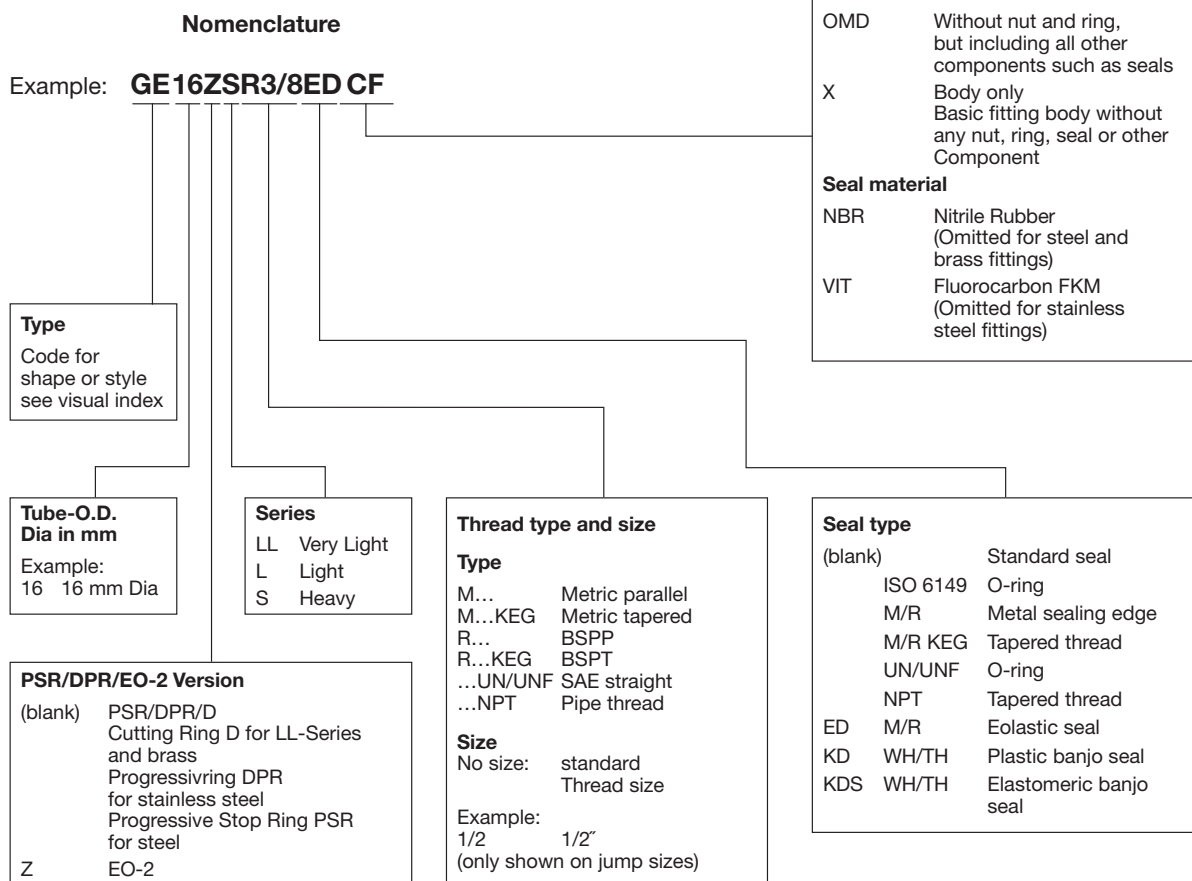

| Examples | |
|----------------|--|
| Order code | Description |
| GE12ZSR1/2EDCF | Straight male stud, EO-2, 20 mm tube O.D., heavy series, G 1/2 BSPP, Eolastic seal, complete with nut and ring, Cr(VI)-free steel fitting, all seals NBR |
| GE12LR71X | Straight male stud, 12 mm tube O.D., light series, G 3/8 BSPP, metal seal type B, stainless steel fitting, body only |
| EVT08LOMDMS | Adjustable standpipe branch tee, 8 mm tube O.D., light series, brass fitting without nut and ring, standpipe preassembled with nut and ring. |
| EL38VITOMDCF | Adjustable swivel nut run tee 38 mm tube O.D., heavy series, zinc-plated steel fitting without nut and ring. Swivel nut end with FKM seal |
| DOZ04LL | Spare seal for EO-2 joints, 4 mm O.D., very light series, steel with nitrile rubber seal |

Perbunan = registered trademark of Bayer



Codes for fittings/styles shapes

| | |
|------------|--|
| BUZ | Blanking plug for cones |
| D | Cutting ring – EO 24° cone end |
| DA | Distance piece adapter – EO 24° DKO swivel/EO 24° cone end |
| DKA | Sealing ring for banjo fittings WH/TH and SWVE |
| DKI | Sealing ring for pressure gauge connectors |
| DOZ | EO-2 Soft sealing ring |
| DPR | Progressive ring – EO 24° cone end |
| E | Tube/hose insert for plastic tubing |
| ED | Eolastic soft seal (for BSPP and metric parallel threads) |
| EGE-M-ED | Swivel connector – Male metric thread – ED-seal (ISO 9974)/EO 24° DKO swivel |
| EGE-NPT | Swivel connector – Male NPT thread (SAE J476)/EO 24° DKO swivel |
| EGEO | Swivel connector – Male metric thread – O-ring (ISO 6149)/EO 24° DKO swivel |
| EGE-R-ED | Swivel connector – Male BSPP thread – ED-seal (ISO 1179)/EO 24° DKO swivel |
| EL | Swivel nut run tee – EO 24° cone end/EO 24° DKO swivel |
| EL-M-ED | Assembled adjustable swivel run tee – EO 24° cone end/Male metric thread – ED-seal (ISO 9974) |
| EL-R-ED | Assembled adjustable swivel run tee – EO 24° cone end/Male BSPP thread – ED-seal (ISO 1179) |
| ET | Swivel nut branch tee – EO 24° cone end/EO 24° DKO swivel |
| ET-M-ED | Assembled adjustable swivel branch tee – EO 24° cone end/Male metric thread – ED-seal (ISO 9974) |
| ET-R-ED | Assembled adjustable swivel branch tee – EO 24° cone end/Male BSPP thread – ED-seal (ISO 1179) |
| EV | Swivel nut 45° elbow – EO 24° cone end/EO 24° DKO swivel |
| EVGE-M-ED | Standpipe connector – Male metric thread – ED (ISO 9974)/EO standpipe adjustable |
| EVGE-R-ED | Standpipe connector – Male BSPP thread – ED-seal (ISO 1179)/EO standpipe adjustable |
| EVL | Standpipe run tee – EO 24° cone end/EO stand pipe adjustable |
| EVL-M | Assembled adjustable standpipe run tee – EO 24° cone end/Male metric thread – metal sealing edge (ISO 9974) |
| EVL-R | Assembled adjustable standpipe run tee – EO 24° cone end/Male BSPP thread – metal sealing edge (ISO 1179) |
| EV-M-ED | Assembled adjustable swivel 45° elbow – EO 24° cone end/Male metric thread – ED-seal (ISO 9974) |
| EV-R-ED | Assembled adjustable swivel 45° elbow – EO 24° cone end/Male BSPP thread – ED-seal (ISO 1179) |
| EVT | Standpipe branch tee – EO 24° cone end/EO stand pipe adjustable |
| EVT-M | Assembled adjustable standpipe branch tee – EO 24° cone end/Male metric thread – metal sealing edge (ISO 9974) |
| EVT-R | Assembled adjustable standpipe branch tee – EO 24° cone end/Male BSPP thread – metal sealing edge (ISO 1179) |
| EVW | Standpipe elbow – EO 24° cone end/EO stand pipe adjustable |
| EVW-M | Assembled adjustable standpipe elbow – EO 24° cone end/Male metric thread – metal sealing edge (ISO 9974) |
| EVW-R | Assembled adjustable standpipe elbow – EO 24° cone end/Male BSPP thread – metal sealing edge (ISO 1179) |
| EW | Swivel nut elbow – EO 24° cone end/EO 24° DKO swivel |
| EW-M-ED | Assembled adjustable swivel elbow – EO 24° cone end/Male metric thread – ED-seal (ISO 9974) |
| EW-R-ED | Assembled adjustable swivel elbow – EO 24° cone end/Male BSPP thread – ED-seal (ISO 1179) |
| FM | EO2 Functional nut |
| FORM | EO2-FORM Set |
| G | Union – EO 24° cone end |
| GAI-M | Female connector – Female metric thread (ISO 9974-1)/EO 24° cone end |
| GAI-NPT | Female connector – Female NPT thread (SAE 476)/EO 24° cone end |
| GAI-R | Female connector – Female BSPP thread (ISO 1179-1)/EO 24° cone end |
| GE-M | Male stud connector – Male metric thread – metal sealing edge (ISO 9974)/EO 24° cone end |
| GE-M (KEG) | Male stud connector – Male short metric taper thread (DIN 3852-1, type C)/EO 24° cone end |
| GE-M-ED | Male stud connector – Male metric thread – ED (ISO 9974)/EO 24° cone end |
| GE-NPT | Male stud connector – Male NPT thread (SAE J476)/EO 24° cone end |
| GEO | Male stud connector – Male metric thread – O-ring (ISO 6149)/EO 24° cone end |
| GE-R | Male stud connector – Male BSPP thread – metal sealing edge (ISO 1179)/EO 24° cone end |
| GE-R (KEG) | Male stud connector – Male short BSP taper thread (DIN 3852-2, type C)/EO 24° cone end |
| GE-R-ED | Male stud connector – Male BSPP thread – ED-seal (ISO 1179)/EO 24° cone end |
| GE-UNF/UN | Male stud connector – Male UNF/UN thread – O-ring (ISO 11926)/EO 24° cone end |
| GM | Locknut for bulkheads SV and WSV |
| GR | Straight reducer – EO 24° cone end |
| GZ | Swivel union – EO 24° DKO swivel |
| GZR | Swivel reducer – EO 24° DKO swivel |
| K | Union cross – EO 24° cone end |



Codes for fittings/styles shapes

| | |
|-------------|--|
| KD | Soft sealing ring for banjo fittings WH/TH from stainless steel |
| KDS | Soft sealing ring for banjo fittings SWVE, WH and TH from steel |
| KOR | Tube end reducer – Steel and Brass – EO stand pipe adjustable/EO 24° cone end |
| LEE | Adjustable locknut run tee – EO 24° cone end/Adjustable thread |
| LE-M | Male stud run tee – EO 24° cone end/Male metric thread – metal sealing edge (ISO 9974) |
| LE-M (KEG) | Male stud run tee – EO 24° cone end/Male short metric taper thread (DIN 3852-1, Form C) |
| LE-R | Male stud run tee – EO 24° cone end/Male BSPP thread – metal sealing edge (ISO 1179) |
| LE-R (KEG) | Male stud run tee – EO 24° cone end/Male short BSP taper thread (DIN 3852-2, type C) |
| M | Nut- EO 24° Cone end |
| MAV | Pressure gauge connector – Female BSPP thread/EO 24° cone end |
| MAVE | Pressure gauge swivel connector – Female BSPP thread/EO 24° DKO swivel |
| OR | O-ring |
| PSR | Progressive stop ring – EO 24° cone end |
| RED | Tube end reducer – EO 24° DKO swivel/EO 24° cone end |
| RI | Thread reducer/expander – Male BSPP thread – metal sealing edge (ISO 1179)/Female BSPP thread (ISO 1179-1) |
| RI-ED | Thread reducer/expander – Male BSPP thread – ED-seal (ISO 1179)/Female BSPP thread (ISO 1179-1) |
| ROV | Blanking plug for tube ends – EO 24° cone end |
| S | Sleeve screw – for threaded ports according to DIN 3854 |
| SV | Bulkhead union – EO 24° cone end |
| SWVE-M | Metric male stud banjo elbow – EO 24° cone end/Metric male stud with metal seal ring |
| SWVE-M-KDS | Metric male stud banjo elbow – EO 24° cone end/Metric male stud with soft seal ring |
| SWVE-R | BSPP male stud banjo elbow – EO 24° cone end/BSPP male stud with metal seal ring |
| SWVE-R-KDS | BSPP male stud banjo elbow – EO 24° cone end/BSPP male stud with soft seal ring |
| T | Union T – EO 24° cone end |
| TEE | Adjustable locknut branch tee – EO 24° cone end/Adjustable thread |
| TE-M | Male stud branch tee – EO 24° cone end/Male metric thread – metal sealing edge (ISO 9974) |
| TE-M (KEG) | Male stud branch tee – EO 24° cone end/Male short metric taper thread (DIN 3852-1, type C) |
| TE-R | Male stud branch tee – EO 24° cone end/Male BSPP thread – metal sealing edge (ISO 1179) |
| TE-R (KEG) | Male stud branch tee – EO 24° cone end/Male short BSP taper thread (DIN 3852-2, type C) |
| TH-M | High pressure banjo tee – EO 24° cone end/Male metric thread with metal sealing ring |
| TH-M-KDS | High pressure banjo tee – EO 24° cone end/Male metric thread with soft seal ring |
| TH-R | High pressure banjo tee – EO 24° cone end/Male BSPP thread with metal sealing ring |
| TH-R-KDS | High pressure banjo tee – EO 24° cone end/Male BSPP thread with soft seal ring |
| TR | Tee Reducer – EO 24° cone end |
| VEE | Adjustable locknut 45° elbow – EO 24° cone end/Adjustable thread |
| VH | Support sleeve for thin-walled metal tubing |
| VKA | Blanking plug for cones – EO 24° DKO swivel |
| VKAM | Blanking plug with nut for cone – EO 24° DKO swivel |
| VSTI M/R-ED | Blanking plug for ports – Male metric thread – ED-seal (ISO 9974) – Male BSPP thread – ED-seal (ISO 1179) |
| VSTI M-OR | Blanking plug for ports – Male metric thread – O-ring (ISO 6149) |
| W | Union elbow – EO 24° cone end |
| WEE | Adjustable locknut elbow – EO 24° cone end/Adjustable thread |
| WE-M | Male stud elbow – EO 24° cone end/Male metric thread – metal sealing edge (ISO 9974) |
| WE-M (KEG) | Male stud elbow – EO 24° cone end/Male short metric taper thread (DIN 3852-1, type C) |
| WE-NPT | Male stud elbow – EO 24° cone end/Male NPT thread (SAE J476) |
| WE-R | Male stud elbow – EO 24° cone end/Male BSPP thread – metal sealing edge (ISO 1179) |
| WE-R (KEG) | Male stud elbow – EO 24° cone end/Male short BSP taper thread (DIN 3852-2, type C) |
| WH-M | High pressure banjo elbow – EO 24° cone end/Male metric thread with metal sealing ring |
| WH-M-KDS | High pressure banjo elbow – EO 24° cone end/Male metric thread with soft seal ring |
| WH-R | High pressure banjo elbow – EO 24° cone end/Male BSPP thread with metal sealing ring |
| WH-R-KDS | High pressure banjo elbow – EO 24° cone end/Male BSPP thread with soft seal ring |
| WSV | Bulkhead elbow – EO 24° cone end |

FM EO2-Functional nut

for steel tubes

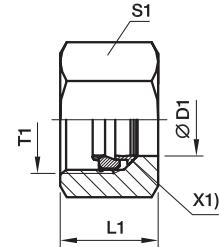

X1) Retaining ring

| Series | D1 | T1 | L1 | S1 | Order code | | | | Weight g/1 piece |
|--------|----------|----------|------|----------------|--|-------------------|---|----------|---------------------|
| | | | | | FM...CF Steel, zinc plated Cr(VI) free passiv. +Sealing Sealing NBR | PN (bar) | FM...VITCF Steel, zinc plated Cr(VI) free passiv. +Sealing Sealing FKM | PN (bar) | |
| LL | 04 | M 08×1.0 | 11.0 | 10 | FM04LLCF | 100 | — | 100 | 5 |
| | 06 | M 10×1.0 | 11.5 | 12 | — | — | — | — | 6 |
| L | 06 | M 12×1.5 | 14.5 | 14 | FM06LCF | 500 | FM06LVITCF | 500 | 12 |
| | 08 | M 14×1.5 | 14.5 | 17 | FM08LCF | 500 | FM08LVITCF | 500 | 17 |
| | 10 | M 16×1.5 | 15.5 | 19 | FM10LCF | 500 | FM10LVITCF | 500 | 22 |
| | 12 | M 18×1.5 | 15.5 | 22 | FM12LCF | 400 | FM12LVITCF | 400 | 30 |
| | 15 | M 22×1.5 | 17.0 | 27 | FM15LCF | 400 | FM15LVITCF | 400 | 48 |
| | 18 | M 26×1.5 | 18.0 | 32 | FM18LCF | 400 | FM18LVITCF | 400 | 70 |
| | 22 | M 30×2.0 | 20.0 | 36 | FM22LCF | 250 | FM22LVITCF | 250 | 94 |
| | 28 | M 36×2.0 | 21.0 | 41 | FM28LCF | 250 | FM28LVITCF | 250 | 106 |
| | 35 | M 45×2.0 | 24.0 | 50 | FM35LCF | 250 | FM35LVITCF | 250 | 160 |
| | 42 | M 52×2.0 | 24.0 | 60 | FM42LCF | 250 | FM42LVITCF | 250 | 244 |
| S | 06 | M 14×1.5 | 16.5 | 17 | FM06SCF | 800 | FM06SVITCF | 800 | 20 |
| | 08 | M 16×1.5 | 16.5 | 19 | FM08SCF | 800 | FM08SVITCF | 800 | 23 |
| | 10 | M 18×1.5 | 17.5 | 22 | FM10SCF | 800 | FM10SVITCF | 800 | 37 |
| | 12 | M 20×1.5 | 17.5 | 24 | FM12SCF | 630 | FM12SVITCF | 630 | 39 |
| | 16 | M 24×1.5 | 20.5 | 30 | FM16SCF | 630 | FM16SVITCF | 630 | 72 |
| | 20 | M 30×2.0 | 24.0 | 36 | FM20SCF | 420 | FM20SVITCF | 420 | 121 |
| | 25 | M 36×2.0 | 27.0 | 46 | FM25SCF | 420 | FM25SVITCF | 420 | 221 |
| | 30 | M 42×2.0 | 29.0 | 50 | FM30SCF | 420 | FM30SVITCF | 420 | 248 |
| 38 | M 52×2.0 | 32.5 | 60 | FM38SCF | 420 | FM38SVITCF | 420 | 367 | |

$$\frac{\text{PN (bar)}}{10} = \text{PN (MPa)}$$



FM EO2-Functional nut

for stainless steel tubes

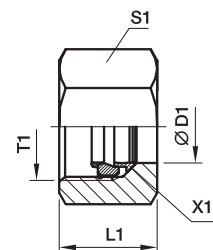

X1) Retaining ring

| Series | D1 | T1 | L1 | S1 | Order code | | | | | | | | Weight g/1 piece |
|--------|----|----------|------|----|----------------------------|----------|-------------------------------|----------|--|----------|---|----------|---------------------|
| | | | | | FM...71 Stainless Steel | | FM...NBR71 Stainless Steel | | FM...SSA Steel, zinc plated Cr(VI) free passiv. +Sealing, Retaining ring: Stainless Steel | | FM...VITSSA Steel, zinc plated Cr(VI) free passiv. +Sealing, Retaining ring: Stainless Steel | | |
| | | | | | Sealing FKM | PN (bar) | Sealing NBR | PN (bar) | Sealing NBR | PN (bar) | Sealing FKM | PN (bar) | |
| LL | 04 | M 08×1.0 | 11.0 | 10 | — | — | — | — | FM04LLSSA | 100 | — | — | 5 |
| | 06 | M 10×1.0 | 11.5 | 12 | — | — | — | — | FM06LLSSA | 100 | — | — | 6 |
| L | 06 | M 12×1.5 | 14.5 | 14 | FM06L71 | 315 | FM06LNBR71 | 315 | FM06LSSA | 315 | FM06LVITSSA | 315 | 12 |
| | 08 | M 14×1.5 | 14.5 | 17 | FM08L71 | 315 | FM08LNBR71 | 315 | FM08LSSA | 315 | FM08LVITSSA | 315 | 17 |
| | 10 | M 16×1.5 | 15.5 | 19 | FM10L71 | 315 | FM10LNBR71 | 315 | FM10LSSA | 315 | FM10LVITSSA | 315 | 22 |
| | 12 | M 18×1.5 | 15.5 | 22 | FM12L71 | 315 | FM12LNBR71 | 315 | FM12LSSA | 315 | FM12LVITSSA | 315 | 30 |
| | 15 | M 22×1.5 | 17.0 | 27 | FM15L71 | 315 | FM15LNBR71 | 315 | FM15LSSA | 315 | FM15LVITSSA | 315 | 48 |
| | 18 | M 26×1.5 | 18.0 | 32 | FM18L71 | 315 | FM18LNBR71 | 315 | FM18LSSA | 315 | FM18LVITSSA | 315 | 70 |
| | 22 | M 30×2.0 | 20.0 | 36 | FM22L71 | 160 | FM22LNBR71 | 160 | FM22LSSA | 160 | FM22LVITSSA | 160 | 94 |
| | 28 | M 36×2.0 | 21.0 | 41 | FM28L71 | 160 | FM28LNBR71 | 160 | FM28LSSA | 160 | FM28LVITSSA | 160 | 106 |
| | 35 | M 45×2.0 | 24.0 | 50 | FM35L71 | 160 | FM35LNBR71 | 160 | FM35LSSA | 160 | FM35LVITSSA | 160 | 160 |
| | 42 | M 52×2.0 | 24.0 | 60 | FM42L71 | 160 | FM42LNBR71 | 160 | FM42LSSA | 160 | FM42LVITSSA | 160 | 244 |
| S | 06 | M 14×1.5 | 16.5 | 17 | FM06S71 | 630 | FM06SNBR71 | 630 | FM06SSSA | 630 | FM06SVITSSA | 630 | 20 |
| | 08 | M 16×1.5 | 16.5 | 19 | FM08S71 | 630 | FM08SNBR71 | 630 | FM08SSSA | 630 | FM08SVITSSA | 630 | 23 |
| | 10 | M 18×1.5 | 17.5 | 22 | FM10S71 | 630 | FM10SNBR71 | 630 | FM10SSSA | 630 | FM10SVITSSA | 630 | 37 |
| | 12 | M 20×1.5 | 17.5 | 24 | FM12S71 | 630 | FM12SNBR71 | 630 | FM12SSSA | 630 | FM12SVITSSA | 630 | 39 |
| | 16 | M 24×1.5 | 20.5 | 30 | FM16S71 | 400 | FM16SNBR71 | 400 | FM16SSSA | 400 | FM16SVITSSA | 400 | 72 |
| | 20 | M 30×2.0 | 24.0 | 36 | FM20S71 | 400 | FM20SNBR71 | 400 | FM20SSSA | 400 | FM20SVITSSA | 400 | 121 |
| | 25 | M 36×2.0 | 27.0 | 46 | FM25S71 | 400 | FM25SNBR71 | 400 | FM25SSSA | 400 | FM25SVITSSA | 400 | 221 |
| | 30 | M 42×2.0 | 29.0 | 50 | FM30S71 | 400 | FM30SNBR71 | 400 | FM30SSSA | 400 | FM30SVITSSA | 400 | 248 |
| | 38 | M 52×2.0 | 32.5 | 60 | FM38S71 | 315 | FM38SNBR71 | 315 | FM38SSSA | 315 | FM38SVITSSA | 315 | 367 |

$\frac{\text{PN (bar)}}{10} = \text{PN (MPa)}$

EO2-FORM Set

for steel tubes

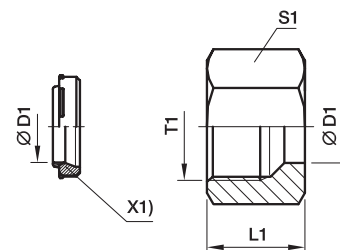

X1) Sealing (DOZ)

| Series | D1 | T1 | L1 | S1 | Order code | | PN (bar) | Weight g/1 piece |
|--------|----------|----------|------|------------------|---|--|-------------|---------------------|
| | | | | | FORM...CF Steel, zinc plated Cr(VI) free +Seal NBR | FORM...VITCF Steel, zinc plated Cr(VI) free +Seal FKM | | |
| L | 06 | M 12×1.5 | 14.5 | 14 | FORM06LCF | FORM06LVITCF | 500 | 11 |
| | 08 | M 14×1.5 | 14.5 | 17 | FORM08LCF | FORM08LVITCF | 500 | 16 |
| | 10 | M 16×1.5 | 15.5 | 19 | FORM10LCF | FORM10LVITCF | 500 | 20 |
| | 12 | M 18×1.5 | 15.5 | 22 | FORM12LCF | FORM12LVITCF | 400 | 27 |
| | 15 | M 22×1.5 | 17.0 | 27 | FORM15LCF | FORM15LVITCF | 400 | 45 |
| | 18 | M 26×1.5 | 18.0 | 32 | FORM18LCF | FORM18LVITCF | 400 | 67 |
| | 22 | M 30×2.0 | 20.0 | 36 | FORM22LCF | FORM22LVITCF | 250 | 88 |
| | 28 | M 36×2.0 | 21.0 | 41 | FORM28LCF | FORM28LVITCF | 250 | 99 |
| | 35 | M 45×2.0 | 24.0 | 50 | FORM35LCF | FORM35LVITCF | 250 | 162 |
| | 42 | M 52×2.0 | 24.0 | 60 | FORM42LCF | FORM42LVITCF | 250 | 233 |
| S | 06 | M 14×1.5 | 16.5 | 17 | FORM06SCF | FORM06SVITCF | 800 | 19 |
| | 08 | M 16×1.5 | 16.5 | 19 | FORM08SCF | FORM08SVITCF | 800 | 22 |
| | 10 | M 18×1.5 | 17.5 | 22 | FORM10SCF | FORM10SVITCF | 800 | 34 |
| | 12 | M 20×1.5 | 17.5 | 24 | FORM12SCF | FORM12SVITCF | 630 | 38 |
| | 16 | M 24×1.5 | 20.5 | 30 | FORM16SCF | FORM16SVITCF | 630 | 71 |
| | 20 | M 30×2.0 | 24.0 | 36 | FORM20SCF | FORM20SVITCF | 420 | 115 |
| | 25 | M 36×2.0 | 27.0 | 46 | FORM25SCF | FORM25SVITCF | 420 | 216 |
| | 30 | M 42×2.0 | 29.0 | 50 | FORM30SCF | FORM30SVITCF | 420 | 242 |
| 38 | M 52×2.0 | 32.5 | 60 | FORM38SCF | FORM38SVITCF | 420 | 366 | |



E02-FORM Set

for stainless steel tubes

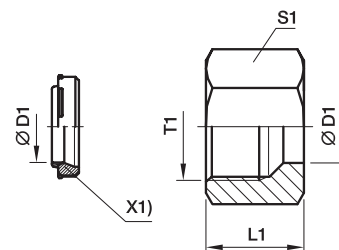

X1) Sealing (DOZ)

| Series | D1 | T1 | L1 | S1 | Order code | | | | PN (bar) | Weight g/1 piece |
|--------|----|----------|------|----|---|--|--|--|----------|------------------|
| | | | | | FORM...71 Stainless Steel Sealing FKM | FORM...NBR71 Stainless Steel Sealing NBR | FORM...CF Steel, zinc plated Cr(VI) free +Seal NBR | FORM...VITCF Steel, zinc Cr(VI) free +Seal FKM | | |
| L | 06 | M 12×1.5 | 14.5 | 14 | FORM06L71 | FORM06LNBR71 | FORM06LCF | FORM06LVITCF | 315 | 11 |
| | 08 | M 14×1.5 | 14.5 | 17 | FORM08L71 | FORM08LNBR71 | FORM08LCF | FORM08LVITCF | 315 | 16 |
| | 10 | M 16×1.5 | 15.5 | 19 | FORM10L71 | FORM10LNBR71 | FORM10LCF | FORM10LVITCF | 315 | 21 |
| | 12 | M 18×1.5 | 15.5 | 22 | FORM12L71 | FORM12LNBR71 | FORM12LCF | FORM12LVITCF | 315 | 27 |
| | 15 | M 22×1.5 | 17.0 | 27 | FORM15L71 | FORM15LNBR71 | FORM15LCF | FORM15LVITCF | 315 | 46 |
| | 18 | M 26×1.5 | 18.0 | 32 | FORM18L71 | FORM18LNBR71 | FORM18LCF | FORM18LVITCF | 315 | 68 |
| | 22 | M 30×2.0 | 20.0 | 36 | FORM22L71 | FORM22LNBR71 | FORM22LCF | FORM22LVITCF | 160 | 89 |
| | 28 | M 36×2.0 | 21.0 | 41 | FORM28L71 | FORM28LNBR71 | FORM28LCF | FORM28LVITCF | 160 | 101 |
| | 35 | M 45×2.0 | 24.0 | 50 | FORM35L71 | FORM35LNBR71 | FORM35LCF | FORM35LVITCF | 160 | 165 |
| | 42 | M 52×2.0 | 24.0 | 60 | FORM42L71 | FORM42LNBR71 | FORM42LCF | FORM42LVITCF | 160 | 237 |
| S | 06 | M 14×1.5 | 16.5 | 17 | FORM06S71 | FORM06SNBR71 | FORM06SCF | FORM06SVITCF | 630 | 19 |
| | 08 | M 16×1.5 | 16.5 | 19 | FORM08S71 | FORM08SNBR71 | FORM08SCF | FORM08SVITCF | 630 | 22 |
| | 10 | M 18×1.5 | 17.5 | 22 | FORM10S71 | FORM10SNBR71 | FORM10SCF | FORM10SVITCF | 630 | 35 |
| | 12 | M 20×1.5 | 17.5 | 24 | FORM12S71 | FORM12SNBR71 | FORM12SCF | FORM12SVITCF | 630 | 39 |
| | 16 | M 24×1.5 | 20.5 | 30 | FORM16S71 | FORM16SNBR71 | FORM16SCF | FORM16SVITCF | 400 | 71 |
| | 20 | M 30×2.0 | 24.0 | 36 | FORM20S71 | FORM20SNBR71 | FORM20SCF | FORM20SVITCF | 400 | 117 |
| | 25 | M 36×2.0 | 27.0 | 46 | FORM25S71 | FORM25SNBR71 | FORM25SCF | FORM25SVITCF | 400 | 219 |
| | 30 | M 42×2.0 | 29.0 | 50 | FORM30S71 | FORM30SNBR71 | FORM30SCF | FORM30SVITCF | 400 | 246 |
| | 38 | M 52×2.0 | 32.5 | 60 | FORM38S71 | FORM38SNBR71 | FORM38SCF | FORM38SVITCF | 315 | 372 |

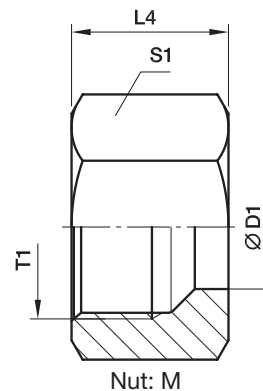
M Nut · EO 24° Cone end

| Series | D1 ⊕ ± | T1 | L4 | S1 | Weight g/1 piece | Order code* | PN (bar) ¹⁾ | | |
|------------------|--------------|----------|------|----|---------------------|--------------|------------------------|-----|-----|
| | | | | | | | CF | 71 | MS |
| LL ²⁾ | 04 | M 08×1.0 | 11.0 | 10 | 4 | M04LL | 100 | 100 | 63 |
| | 06 | M 10×1.0 | 11.5 | 12 | 6 | M06LL | 100 | 100 | 63 |
| | 08 | M 12×1.0 | 12.0 | 14 | 7 | M08LL | 100 | 100 | 63 |
| | 10 | M 14×1.0 | 12.5 | 17 | 11 | M10LL | 100 | 100 | 63 |
| | 12 | M 16×1.0 | 13.0 | 19 | 13 | M12LL | 100 | 100 | 63 |
| L ³⁾ | 06 | M 12×1.5 | 14.5 | 14 | 10 | M06L | 500 | 315 | 200 |
| | 08 | M 14×1.5 | 14.5 | 17 | 15 | M08L | 500 | 315 | 200 |
| | 10 | M 16×1.5 | 15.5 | 19 | 18 | M10L | 500 | 315 | 200 |
| | 12 | M 18×1.5 | 15.5 | 22 | 25 | M12L | 400 | 315 | 200 |
| | 15 | M 22×1.5 | 17.0 | 27 | 42 | M15L | 400 | 315 | 200 |
| | 18 | M 26×1.5 | 18.0 | 32 | 62 | M18L | 400 | 315 | 200 |
| | 22 | M 30×2.0 | 20.0 | 36 | 82 | M22L | 250 | 160 | 100 |
| | 28 | M 36×2.0 | 21.0 | 41 | 89 | M28L | 250 | 160 | 100 |
| | 35 | M 45×2.0 | 24.0 | 50 | 137 | M35L | 250 | 160 | 100 |
| | 42 | M 52×2.0 | 24.0 | 60 | 216 | M42L | 250 | 160 | 100 |
| S ⁴⁾ | 06 | M 14×1.5 | 16.5 | 17 | 17 | M06S | 800 | 630 | 400 |
| | 08 | M 16×1.5 | 16.5 | 19 | 20 | M08S | 800 | 630 | 400 |
| | 10 | M 18×1.5 | 17.5 | 22 | 31 | M10S | 800 | 630 | 400 |
| | 12 | M 20×1.5 | 17.5 | 24 | 34 | M12S | 630 | 630 | 400 |
| | 16 | M 24×1.5 | 20.5 | 30 | 66 | M16S | 630 | 400 | 250 |
| | 20 | M 30×2.0 | 24.0 | 36 | 102 | M20S | 420 | 400 | 250 |
| | 25 | M 36×2.0 | 27.0 | 46 | 202 | M25S | 420 | 400 | 250 |
| | 30 | M 42×2.0 | 29.0 | 50 | 219 | M30S | 420 | 400 | 250 |
| | 38 | M 52×2.0 | 32.5 | 60 | 339 | M38S | 420 | 315 | 200 |

¹⁾ Pressure shown = item deliverable

²⁾ LL = very light series; ³⁾ L = light series; ⁴⁾ S = heavy series

$$\frac{\text{PN (bar)}}{10} = \text{PN (MPa)}$$

*Please add the **suffixes** below according to the material/surface required.

| Order code suffixes | | |
|---------------------------------|-----------------------------|------------|
| Material | Suffix surface and material | Example |
| Steel, zinc plated, Cr(VI)-free | CFX | M16SCFX |
| Stainless Steel | EODURX | M16SEODURX |
| Brass | MSX | M16SMSX |



D Cutting ring · PSR Progressive stop ring

for EO 24° cone end

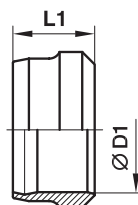
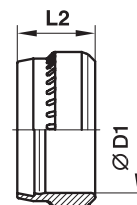

 Cutting ring:
D

 Progressive stop ring:
PSR

| Series | D1 | L1 | Cutting ring D Order code | | | | | Progressive stop ring PSR Order code | | | | Weight g/1 pc. |
|--------|----|------|--------------------------------------|-------------|-----------------|-------------|-----------------|--|------|--------------------------------------|-------------|-------------------|
| | | | Steel, zinc plated Cr(VI) free | PN (bar) | Stainless Steel | PN (bar) | Brass | PN (bar) | L2 | Steel, zinc plated Cr(VI) free | PN (bar) | |
| LL | 04 | 6.0 | D04LLX | 100 | D04LL71X | 100 | D04LLMSX | 63 | — | — | — | 0.3 |
| | 06 | 7.0 | D06LLX | 100 | D06LL71X | 100 | D06LLMSX | 63 | — | — | — | 0.8 |
| | 08 | 7.0 | D08LLX | 100 | D08LL71X | 100 | D08LLMSX | 63 | — | — | — | 1.0 |
| | 10 | 7.0 | D10LLX | 100 | D10LL71X | 100 | D10LLMSX | 63 | — | — | — | 1.3 |
| | 12 | 7.5 | D12LLX | 100 | D12LL71X | 100 | D12LLMSX | 63 | — | — | — | 1.6 |
| L | 06 | 9.5 | — | — | — | — | D06LMSX | 200 | 9.5 | PSR06LX | 500 | 1.7 |
| | 08 | 9.0 | — | — | — | — | D08LMSX | 200 | 9.5 | PSR08LX | 500 | 2.2 |
| | 10 | 10.0 | — | — | — | — | D10LMSX | 200 | 10.0 | PSR10LX | 500 | 3.1 |
| | 12 | 10.0 | — | — | — | — | D12LMSX | 200 | 10.0 | PSR12LX | 400 | 3.5 |
| | 15 | 10.0 | — | — | — | — | D15LMSX | 200 | 10.0 | PSR15LX | 400 | 4.5 |
| | 18 | 10.0 | — | — | — | — | D18LMSX | 200 | 10.0 | PSR18LX | 400 | 5.5 |
| | 22 | 10.5 | — | — | — | — | D22LMSX | 100 | 10.5 | PSR22LX | 250 | 7.3 |
| | 28 | 10.5 | — | — | — | — | D28LMSX | 100 | 10.5 | PSR28LX | 250 | 9.4 |
| | 35 | 13.0 | — | — | — | — | D35LMSX | 100 | 13.0 | PSR35LX | 250 | 20.0 |
| | 42 | 13.5 | — | — | — | — | D42LMSX | 100 | 13.0 | PSR42LX | 250 | 23.0 |
| S | 06 | 9.5 | — | — | — | — | D06LMSX | 400 | 9.5 | PSR06LX | 800 | 1.7 |
| | 08 | 9.0 | — | — | — | — | D08LMSX | 400 | 9.5 | PSR08LX | 800 | 3.2 |
| | 10 | 10.0 | — | — | — | — | D10LMSX | 400 | 10.0 | PSR10LX | 800 | 3.1 |
| | 12 | 10.0 | — | — | — | — | D12LMSX | 400 | 10.0 | PSR12LX | 630 | 3.5 |
| | 16 | 10.5 | — | — | — | — | D16SMSX | 250 | 10.0 | PSR16SX | 630 | 5.6 |
| | 20 | 12.5 | — | — | — | — | D20SMSX | 250 | 13.0 | PSR20SX | 420 | 11.4 |
| | 25 | 12.5 | — | — | — | — | D25SMSX | 250 | 13.0 | PSR25SX | 420 | 13.3 |
| | 30 | 13.0 | — | — | — | — | D30SMSX | 250 | 13.0 | PSR30SX | 420 | 19.3 |
| | 38 | 13.5 | — | — | — | — | D38SMSX | 200 | 13.0 | PSR38SX | 420 | 22.5 |

$$\frac{\text{PN (bar)}}{10} = \text{PN (MPa)}$$

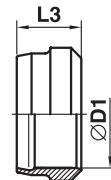
DPR Progressive ring

for EO 24° cone end



Progressive ring: DPR

| Series | D1 | L3 | Progressive ring DPR Order code | | PN (bar) | Weight g/1 piece | |
|--------|--------|------|--|---------------------|--------------|---------------------|-----|
| | | | Stainless Steel | Stainless Steel SPH | | | |
| L | 06 | 9.0 | DPR06L71X | DPR06LSPH71X | 315 | 1.7 | |
| | 08 | 9.0 | DPR08L71X | DPR08LSPH71X | 315 | 2.2 | |
| | 10 | 9.5 | DPR10L71X | DPR10LSPH71X | 315 | 3.1 | |
| | 12 | 9.8 | DPR12L71X | DPR12LSPH71X | 315 | 3.5 | |
| | 15 | 9.5 | DPR15L71X | DPR15LSPH71X | 315 | 4.5 | |
| | 18 | 9.5 | DPR18L71X | DPR18LSPH71X | 315 | 5.5 | |
| | 22 | 10.5 | DPR22L71X | DPR22LSPH71X | 160 | 7.3 | |
| | 28 | 11.0 | DPR28L71X | DPR28LSPH71X | 160 | 9.4 | |
| | 35 | 13.5 | DPR35L71X | DPR35LSPH71X | 160 | 20.0 | |
| | 42 | 13.5 | DPR42L71X | DPR42LSPH71X | 160 | 23.0 | |
| | S | 06 | 9.0 | DPR06L71X | DPR06LSPH71X | 630 | 1.7 |
| | | 08 | 9.0 | DPR08L71X | DPR08LSPH71X | 630 | 3.2 |
| 10 | | 9.5 | DPR10L71X | DPR10LSPH71X | 630 | 3.1 | |
| 12 | | 9.8 | DPR12L71X | DPR12LSPH71X | 630 | 3.5 | |
| 16 | | 9.5 | DPR16S71X | DPR16SSPH71X | 400 | 5.6 | |
| 20 | | 12.5 | DPR20S71X | DPR20SSPH71X | 400 | 11.4 | |
| 25 | | 12.5 | DPR25S71X | DPR25SSPH71X | 400 | 13.3 | |
| 30 | | 12.5 | DPR30S71X | DPR30SSPH71X | 400 | 19.3 | |
| 38 | | 13.0 | DPR38S71X | DPR38SSPH71X | 315 | 22.5 | |

$$\frac{\text{PN (bar)}}{10} = \text{PN (MPa)}$$



S Sleeve screw

for threaded ports according to DIN 3854

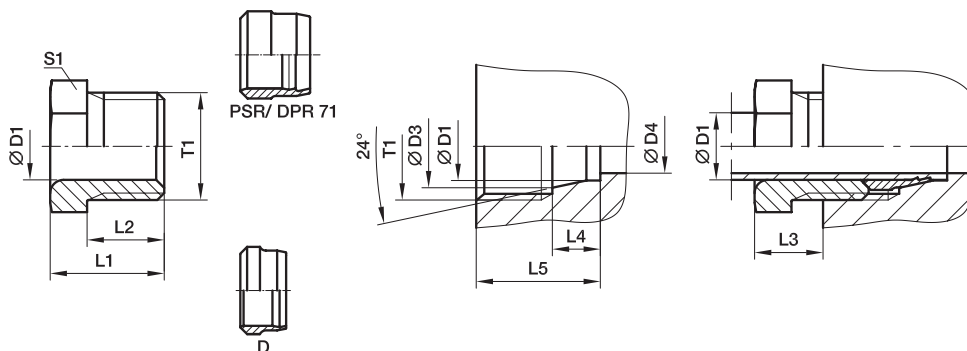

| Series | D1 | T1 | D3 | D4 | L1 | L2 | L3 | L4 | L5 | S1 | Weight g/1 piece | Order code* | PN (bar) ¹⁾ | |
|------------------|----|----------|------|------|----|------|----|-----|------|----|---------------------|--------------|------------------------|-----|
| | | | | | | | | | | | | | CF | 71 |
| LL ²⁾ | 04 | M 08x1.0 | 5.0 | 3.0 | 12 | 8.0 | 6 | 4.0 | 12.5 | 8 | 3 | S04LL | 100 | 100 |
| | 06 | M 10x1.0 | 7.5 | 4.5 | 13 | 9.0 | 7 | 5.5 | 14.5 | 10 | 4 | S06LL | 100 | 100 |
| | 08 | M 12x1.0 | 9.5 | 6.0 | 14 | 9.5 | 7 | 5.5 | 14.5 | 12 | 6 | S08LL | 100 | 100 |
| L ³⁾ | 06 | M 12x1.5 | 8.1 | 4.0 | 16 | 11.5 | 10 | 7.0 | 18.5 | 12 | 9 | S06L | 315 | 315 |
| | 08 | M 14x1.5 | 10.1 | 6.0 | 16 | 11.5 | 10 | 7.0 | 18.5 | 14 | 11 | S08L | 315 | 315 |
| | 10 | M 16x1.5 | 12.3 | 8.0 | 17 | 11.5 | 10 | 7.0 | 18.5 | 17 | 15 | S10L | 315 | 315 |
| | 12 | M 18x1.5 | 14.3 | 10.0 | 18 | 12.0 | 10 | 7.0 | 19.0 | 19 | 19 | S12L | 315 | 315 |

¹⁾ Pressure shown = item deliverable

²⁾ LL = very light series; ³⁾ L = light series

PN (bar) = PN (MPa)
10

*Please add the **suffixes** below according to the material/surface required.

| Order code suffixes | | |
|---------------------------------|-----------------------------|---------|
| Material | Suffix surface and material | Example |
| Steel, zinc plated, Cr(VI)-free | CFX | S10LCFX |
| Stainless Steel | 71X | S10L71X |

DIN fittings



Index

G Union

EO 24° cone end

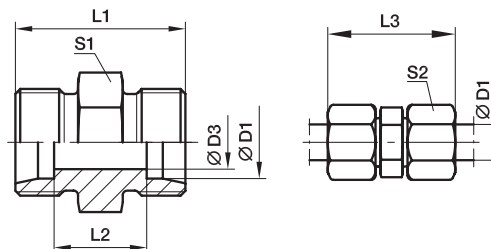

| Series | D1 | D3 | L1 | L2 | L3 | S1 | S2 | Weight g/1 piece | Order code* | PN (bar) ¹⁾ | | | |
|------------------|-----------------|------|-----|----|----|----|----|---------------------|--------------|------------------------|-----|-----|-----|
| | | | | | | | | | | CF | 71 | MS | |
| LL ²⁾ | 04 | 3.0 | 20 | 12 | 31 | 9 | 10 | 5 | G04LL | 100 | 100 | 63 | |
| | 06 | 4.5 | 20 | 9 | 32 | 11 | 12 | 7 | G06LL | 100 | 100 | 63 | |
| | 08 | 6.0 | 23 | 12 | 35 | 12 | 14 | 10 | G08LL | 100 | 100 | 63 | |
| | 10 | 8.0 | 23 | 12 | 35 | 14 | 17 | 13 | G10LL | 100 | 100 | 63 | |
| | 12 | 10.0 | 23 | 11 | 35 | 17 | 19 | 16 | G12LL | 100 | 100 | 63 | |
| L ³⁾ | 06 | 4.0 | 24 | 10 | 39 | 12 | 14 | 12 | G06L | 500 | 315 | 200 | |
| | 08 | 6.0 | 25 | 11 | 40 | 14 | 17 | 16 | G08L | 500 | 315 | 200 | |
| | 10 | 8.0 | 27 | 13 | 42 | 17 | 19 | 23 | G10L | 500 | 315 | 200 | |
| | 12 | 10.0 | 28 | 14 | 43 | 19 | 22 | 28 | G12L | 400 | 315 | 200 | |
| | 15 | 12.0 | 30 | 16 | 46 | 24 | 27 | 51 | G15L | 400 | 315 | 200 | |
| | 18 | 15.0 | 31 | 16 | 48 | 27 | 32 | 69 | G18L | 400 | 315 | 200 | |
| | 22 | 19.0 | 35 | 20 | 52 | 32 | 36 | 90 | G22L | 250 | 160 | 100 | |
| | 28 | 24.0 | 36 | 21 | 54 | 41 | 41 | 137 | G28L | 250 | 160 | 100 | |
| | 35 | 30.0 | 41 | 20 | 63 | 46 | 50 | 214 | G35L | 250 | 160 | 100 | |
| | 42 | 36.0 | 43 | 21 | 66 | 55 | 60 | 296 | G42L | 250 | 160 | 100 | |
| | S ⁴⁾ | 06 | 4.0 | 30 | 16 | 45 | 14 | 17 | 26 | G06S | 800 | 630 | 400 |
| | | 08 | 5.0 | 32 | 18 | 47 | 17 | 19 | 37 | G08S | 800 | 630 | 400 |
| 10 | | 7.0 | 32 | 17 | 49 | 19 | 22 | 44 | G10S | 800 | 630 | 400 | |
| 12 | | 8.0 | 34 | 19 | 51 | 22 | 24 | 60 | G12S | 630 | 630 | 400 | |
| 16 | | 12.0 | 38 | 21 | 57 | 27 | 30 | 90 | G16S | 630 | 400 | 250 | |
| 20 | | 16.0 | 44 | 23 | 66 | 32 | 36 | 143 | G20S | 420 | 400 | 250 | |
| 25 | | 20.0 | 50 | 26 | 74 | 41 | 46 | 251 | G25S | 420 | 400 | 250 | |
| 30 | | 25.0 | 54 | 27 | 80 | 46 | 50 | 330 | G30S | 420 | 400 | 250 | |
| 38 | | 32.0 | 61 | 29 | 90 | 55 | 60 | 545 | G38S | 420 | 315 | 200 | |

¹⁾ Pressure shown = item deliverable

²⁾ LL = very light series; ³⁾ L = light series; ⁴⁾ S = heavy series

PN (bar) = PN (MPa)
10

Delivery without nut and ring. Information on ordering complete fittings see page 17.

| Order code suffixes | | |
|---------------------------------|-----------------------------|---------|
| Material | Suffix surface and material | Example |
| Steel, zinc plated, Cr(VI)-free | CFX | G16SCFX |
| Stainless Steel | 71X | G16S71X |
| Brass | MSX | G16SMSX |

*Please add the **suffixes** below according to the material/surface required.



GR Straight reducer

EO 24° cone end

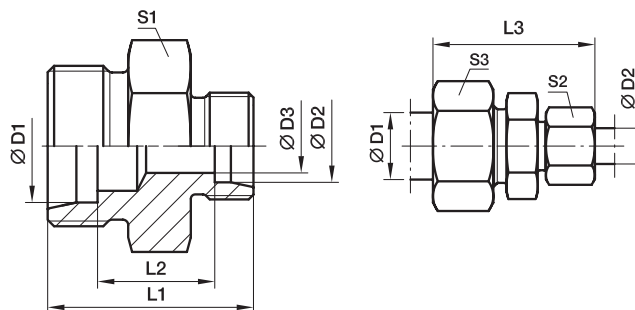

| Series | D1 | D2 | D3 | L1 | L2 | L3 | S1 | S2 | S3 | Weight g/1 piece | Order code* | PN (bar) ¹⁾ | | |
|------------------|-----------------|----|------|-----|------|------|----|----|----|---------------------|-------------|------------------------|-----|-----|
| | | | | | | | | | | | | CF | 71 | MS |
| LL ²⁾ | 06 | 04 | 3.0 | 20 | 10.5 | 32 | 11 | 10 | 12 | 7 | GR06/04LL | 100 | 100 | 63 |
| | 08 | 04 | 3.0 | 22 | 12.5 | 34 | 12 | 10 | 14 | 9 | GR08/04LL | 100 | 100 | 63 |
| | 08 | 06 | 4.5 | 22 | 11.0 | 34 | 12 | 12 | 14 | 11 | GR08/06LL | 100 | 100 | 63 |
| L ³⁾ | 08 | 06 | 4.0 | 25 | 11.0 | 40 | 14 | 14 | 17 | 16 | GR08/06L | 500 | 315 | 200 |
| | 10 | 06 | 4.0 | 26 | 12.0 | 41 | 17 | 14 | 19 | 21 | GR10/06L | 500 | 315 | 200 |
| | 10 | 08 | 6.0 | 26 | 12.0 | 41 | 17 | 17 | 19 | 21 | GR10/08L | 500 | 315 | 200 |
| | 12 | 06 | 4.0 | 27 | 13.0 | 42 | 19 | 14 | 22 | 26 | GR12/06L | 400 | 315 | 200 |
| | 12 | 08 | 6.0 | 27 | 13.0 | 42 | 19 | 17 | 22 | 26 | GR12/08L | 400 | 315 | 200 |
| | 12 | 10 | 8.0 | 28 | 14.0 | 43 | 19 | 19 | 22 | 29 | GR12/10L | 400 | 315 | 200 |
| | 15 | 10 | 8.0 | 29 | 15.0 | 45 | 24 | 19 | 27 | 46 | GR15/10L | 400 | 315 | 200 |
| | 15 | 12 | 10.0 | 29 | 15.0 | 45 | 24 | 22 | 27 | 45 | GR15/12L | 400 | 315 | 200 |
| | 18 | 10 | 8.0 | 30 | 15.5 | 46 | 27 | 19 | 32 | 65 | GR18/10L | 400 | 315 | 200 |
| | 18 | 12 | 10.0 | 30 | 15.5 | 46 | 27 | 22 | 32 | 64 | GR18/12L | 400 | 315 | 200 |
| | 18 | 15 | 12.0 | 31 | 16.5 | 48 | 27 | 27 | 32 | 65 | GR18/15L | 400 | 315 | 200 |
| | 22 | 12 | 10.0 | 32 | 17.5 | 48 | 32 | 22 | 36 | 80 | GR22/12L | 250 | 160 | 100 |
| | 22 | 15 | 12.0 | 33 | 18.5 | 50 | 32 | 27 | 36 | 89 | GR22/15L | 250 | 160 | 100 |
| | 22 | 18 | 15.0 | 33 | 18.0 | 50 | 32 | 32 | 36 | 89 | GR22/18L | 250 | 160 | 100 |
| | 28 | 18 | 15.0 | 34 | 19.0 | 52 | 41 | 32 | 41 | 142 | GR28/18L | 250 | 160 | 100 |
| | 28 | 22 | 19.0 | 36 | 21.0 | 54 | 41 | 36 | 41 | 139 | GR28/22L | 250 | 160 | 100 |
| | 35 | 22 | 19.0 | 39 | 21.0 | 59 | 46 | 36 | 50 | 202 | GR35/22L | 250 | 160 | 100 |
| | 35 | 28 | 24.0 | 39 | 21.0 | 59 | 46 | 41 | 50 | 206 | GR35/28L | 250 | 160 | 100 |
| | 42 | 35 | 30.0 | 43 | 21.5 | 66 | 55 | 50 | 60 | 330 | GR42/35L | 250 | 160 | 100 |
| | S ⁴⁾ | 08 | 06 | 4.0 | 32 | 18.0 | 47 | 17 | 17 | 19 | 35 | GR08/06S | 800 | 630 |
| 10 | | 06 | 4.0 | 32 | 17.5 | 48 | 19 | 17 | 22 | 41 | GR10/06S | 800 | 630 | 400 |
| 10 | | 08 | 5.0 | 32 | 17.5 | 48 | 19 | 19 | 22 | 42 | GR10/08S | 800 | 630 | 400 |
| 12 | | 06 | 4.0 | 34 | 19.5 | 50 | 22 | 17 | 24 | 56 | GR12/06S | 630 | 630 | 400 |
| 12 | | 08 | 5.0 | 34 | 19.5 | 50 | 22 | 19 | 24 | 57 | GR12/08S | 630 | 630 | 400 |
| 12 | | 10 | 7.0 | 34 | 19.0 | 51 | 22 | 22 | 24 | 59 | GR12/10S | 630 | 630 | 400 |
| 16 | | 10 | 7.0 | 36 | 20.0 | 54 | 27 | 22 | 30 | 80 | GR16/10S | 630 | 400 | 250 |
| 16 | | 12 | 8.0 | 36 | 20.0 | 54 | 27 | 24 | 30 | 87 | GR16/12S | 630 | 400 | 250 |
| 16 | | 14 | 10.0 | 36 | 21.5 | 57 | 27 | 27 | 30 | 79 | GR16/14S | 630 | 400 | 250 |
| 20 | | 10 | 7.0 | 40 | 22.0 | 60 | 32 | 22 | 36 | 129 | GR20/10S | 420 | 400 | 250 |
| 20 | | 12 | 8.0 | 40 | 22.0 | 60 | 32 | 24 | 36 | 131 | GR20/12S | 420 | 400 | 250 |
| 20 | | 16 | 12.0 | 42 | 23.0 | 63 | 32 | 30 | 36 | 134 | GR20/16S | 420 | 400 | 250 |
| 25 | | 16 | 12.0 | 46 | 25.5 | 68 | 41 | 30 | 46 | 236 | GR25/16S | 420 | 400 | 250 |
| 25 | | 20 | 16.0 | 48 | 25.5 | 71 | 41 | 36 | 46 | 235 | GR25/20S | 420 | 400 | 250 |
| 30 | | 20 | 16.0 | 50 | 26.0 | 74 | 46 | 36 | 50 | 299 | GR30/20S | 420 | 400 | 250 |
| 30 | | 25 | 20.0 | 52 | 26.5 | 77 | 46 | 46 | 50 | 317 | GR30/25S | 420 | 400 | 250 |
| 38 | | 30 | 25.0 | 59 | 29.5 | 87 | 55 | 50 | 60 | 522 | GR38/30S | 420 | 315 | 200 |

¹⁾ Pressure shown = item deliverable

²⁾ LL = very light series; ³⁾ L = light series; ⁴⁾ S = heavy series

$$\frac{\text{PN (bar)}}{10} = \text{PN (MPa)}$$
Delivery without nut and ring. Information on ordering complete fittings see page 17.

 *Please add the **suffixes** below according to the material/surface required.

| Order code suffixes | | |
|---------------------------------|-----------------------------|-------------|
| Material | Suffix surface and material | Example |
| Steel, zinc plated, Cr(VI)-free | CFX | GR16/12SCFX |
| Stainless Steel | 71X | GR16/12S71X |
| Brass | MSX | GR16/12SMSX |

DIN fittings

W Union elbow

EO 24° cone end

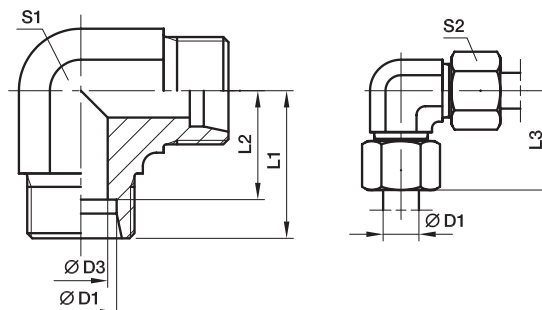

| Series | D1 | D3 | L1 | L2 | L3 | S1 | S2 | Weight g/1 piece | Order code* | PN (bar) ¹⁾ | | |
|------------------|--------|------|----|------|----|-----|----|---------------------|--------------|------------------------|-----|-----|
| | | | | | | | | | | CF | 71 | MS |
| LL ²⁾ | 04 | 3.0 | 15 | 11.0 | 21 | 9 | 10 | 13 | W04LL | 100 | 100 | 63 |
| | 06 | 4.5 | 15 | 9.5 | 21 | 9 | 12 | 15 | W06LL | 100 | 100 | 63 |
| | 08 | 6.0 | 17 | 11.5 | 23 | 12 | 14 | 23 | W08LL | 100 | 100 | 63 |
| | 10 | 8.0 | 18 | 12.5 | 24 | 12 | 17 | 32 | W10LL | 100 | 100 | 63 |
| | 12 | 10.0 | 19 | 13.0 | 25 | 14 | 19 | 41 | W12LL | 100 | 100 | 63 |
| L ³⁾ | 06 | 4.0 | 19 | 12.0 | 27 | 12 | 14 | 29 | W06L | 500 | 315 | 200 |
| | 08 | 6.0 | 21 | 14.0 | 29 | 12 | 17 | 43 | W08L | 500 | 315 | 200 |
| | 10 | 8.0 | 22 | 15.0 | 30 | 14 | 19 | 54 | W10L | 500 | 315 | 200 |
| | 12 | 10.0 | 24 | 17.0 | 32 | 19 | 22 | 80 | W12L | 400 | 315 | 200 |
| | 15 | 12.0 | 28 | 21.0 | 36 | 19 | 27 | 81 | W15L | 400 | 315 | 200 |
| | 18 | 15.0 | 31 | 23.5 | 40 | 24 | 32 | 140 | W18L | 400 | 315 | 200 |
| | 22 | 19.0 | 35 | 27.5 | 44 | 27 | 36 | 178 | W22L | 250 | 160 | 100 |
| | 28 | 24.0 | 38 | 30.5 | 47 | 36 | 41 | 340 | W28L | 250 | 160 | 100 |
| | 35 | 30.0 | 45 | 34.5 | 56 | 41 | 50 | 458 | W35L | 250 | 160 | 100 |
| | 42 | 36.0 | 51 | 40.0 | 63 | 50 | 60 | 776 | W42L | 250 | 160 | 100 |
| S ⁴⁾ | 06 | 4.0 | 23 | 16.0 | 31 | 12 | 17 | 52 | W06S | 800 | 630 | 400 |
| | 08 | 5.0 | 24 | 17.0 | 32 | 14 | 19 | 74 | W08S | 800 | 630 | 400 |
| | 10 | 7.0 | 25 | 17.5 | 34 | 19 | 22 | 97 | W10S | 800 | 630 | 400 |
| | 12 | 8.0 | 29 | 21.5 | 38 | 19* | 24 | 137 | W12S | 630 | 630 | 400 |
| | 16 | 12.0 | 33 | 24.5 | 43 | 24 | 30 | 162 | W16S | 630 | 400 | 250 |
| | 20 | 16.0 | 37 | 26.5 | 48 | 27 | 36 | 221 | W20S | 420 | 400 | 250 |
| | 25 | 20.0 | 42 | 30.0 | 54 | 36 | 46 | 424 | W25S | 420 | 400 | 250 |
| | 30 | 25.0 | 49 | 35.5 | 62 | 41 | 50 | 603 | W30S | 420 | 400 | 250 |
| | 38 | 32.0 | 57 | 41.0 | 72 | 50 | 60 | 1010 | W38S | 420 | 315 | 200 |

1) Pressure shown = item deliverable

2) LL = very light series; 3) L = light series; 4) S = heavy series

*S1 = 17 in 1.4571

$$\frac{\text{PN (bar)}}{10} = \text{PN (MPa)}$$

Delivery without nut and ring. Information on ordering complete fittings see page I7.

 *Please add the **suffixes** below according to the material/surface required.

| Order code suffixes | | |
|---------------------------------|-----------------------------|---------|
| Material | Suffix surface and material | Example |
| Steel, zinc plated, Cr(VI)-free | CFX | W16SCFX |
| Stainless Steel | 71X | W16S71X |
| Brass | MSX | W16SMSX |



T Union tee

EO 24° cone end

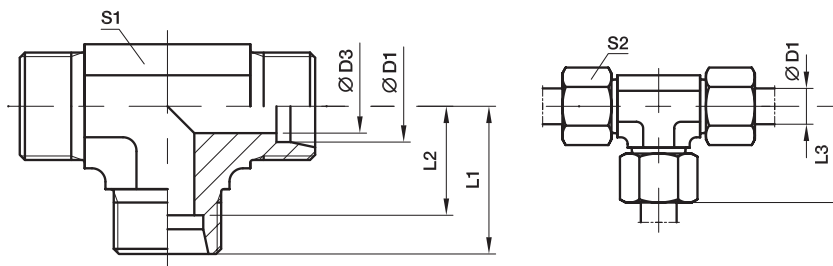

| Series | D1 ⊕ | D3 | L1 | L2 | L3 | S1 | S2 | Weight g/1 piece | Order code* | PN (bar) ¹⁾ | | |
|------------------|-----------------|------|-----|------|------|-----|----|---------------------|--------------|------------------------|-----|-----|
| | | | | | | | | | | CF | 71 | MS |
| LL ²⁾ | 04 | 3.0 | 15 | 11.0 | 21 | 9 | 10 | 19 | T04LL | 100 | 100 | 63 |
| | 06 | 4.5 | 15 | 9.5 | 21 | 9 | 12 | 20 | T06LL | 100 | 100 | 63 |
| | 08 | 6.0 | 17 | 11.5 | 23 | 12 | 14 | 27 | T08LL | 100 | 100 | 63 |
| | 10 | 8.0 | 18 | 12.5 | 24 | 12 | 17 | 39 | T10LL | 100 | 100 | 63 |
| | 12 | 10.0 | 21 | 15.0 | 27 | 14 | 19 | 45 | T12LL | 100 | 100 | 63 |
| L ³⁾ | 06 | 4.0 | 19 | 12.0 | 27 | 12 | 14 | 37 | T06L | 500 | 315 | 200 |
| | 08 | 6.0 | 21 | 14.0 | 29 | 12 | 17 | 53 | T08L | 500 | 315 | 200 |
| | 10 | 8.0 | 22 | 15.0 | 30 | 14 | 19 | 48 | T10L | 500 | 315 | 200 |
| | 12 | 10.0 | 24 | 17.0 | 32 | 17 | 22 | 65 | T12L | 400 | 315 | 200 |
| | 15 | 12.0 | 28 | 21.0 | 36 | 19 | 27 | 106 | T15L | 400 | 315 | 200 |
| | 18 | 15.0 | 31 | 23.5 | 40 | 24 | 32 | 179 | T18L | 400 | 315 | 200 |
| | 22 | 19.0 | 35 | 27.5 | 44 | 27 | 36 | 225 | T22L | 250 | 160 | 100 |
| | 28 | 24.0 | 38 | 30.5 | 47 | 36 | 41 | 396 | T28L | 250 | 160 | 100 |
| | 35 | 30.0 | 45 | 34.5 | 56 | 41 | 50 | 567 | T35L | 250 | 160 | 100 |
| | 42 | 36.0 | 51 | 40.0 | 63 | 50 | 60 | 905 | T42L | 250 | 160 | 100 |
| | S ⁴⁾ | 06 | 4.0 | 23 | 16.0 | 31 | 12 | 17 | 68 | T06S | 800 | 630 |
| 08 | | 5.0 | 24 | 17.0 | 32 | 14 | 19 | 70 | T08S | 800 | 630 | 400 |
| 10 | | 7.0 | 25 | 17.5 | 34 | 17 | 22 | 91 | T10S | 800 | 630 | 400 |
| 12 | | 8.0 | 29 | 21.5 | 38 | 19* | 24 | 117 | T12S | 630 | 630 | 400 |
| 16 | | 12.0 | 33 | 24.5 | 43 | 24 | 30 | 202 | T16S | 630 | 400 | 250 |
| 20 | | 16.0 | 37 | 26.5 | 48 | 27 | 36 | 289 | T20S | 420 | 400 | 250 |
| 25 | | 20.0 | 42 | 30.0 | 54 | 36 | 46 | 545 | T25S | 420 | 400 | 250 |
| 30 | | 25.0 | 49 | 35.5 | 62 | 41 | 50 | 758 | T30S | 420 | 400 | 250 |
| 38 | | 32.0 | 57 | 41.0 | 72 | 50 | 60 | 1264 | T38S | 420 | 315 | 200 |

1) Pressure shown = item deliverable

2) LL = very light series; 3) L = light series; 4) S = heavy series

*S1 = 17 in 1.4571

$\frac{PN \text{ (bar)}}{10} = PN \text{ (MPa)}$

Delivery without nut and ring. Information on ordering complete fittings see page 17.

*Please add the **suffixes** below according to the material/surface required.

| Order code suffixes | | |
|---------------------------------|-----------------------------|---------|
| Material | Suffix surface and material | Example |
| Steel, zinc plated, Cr(VI)-free | CFX | T16SCFX |
| Stainless Steel | 71X | T16S71X |
| Brass | MSX | T16SMSX |

TR Tee Reducer

EO 24° cone end

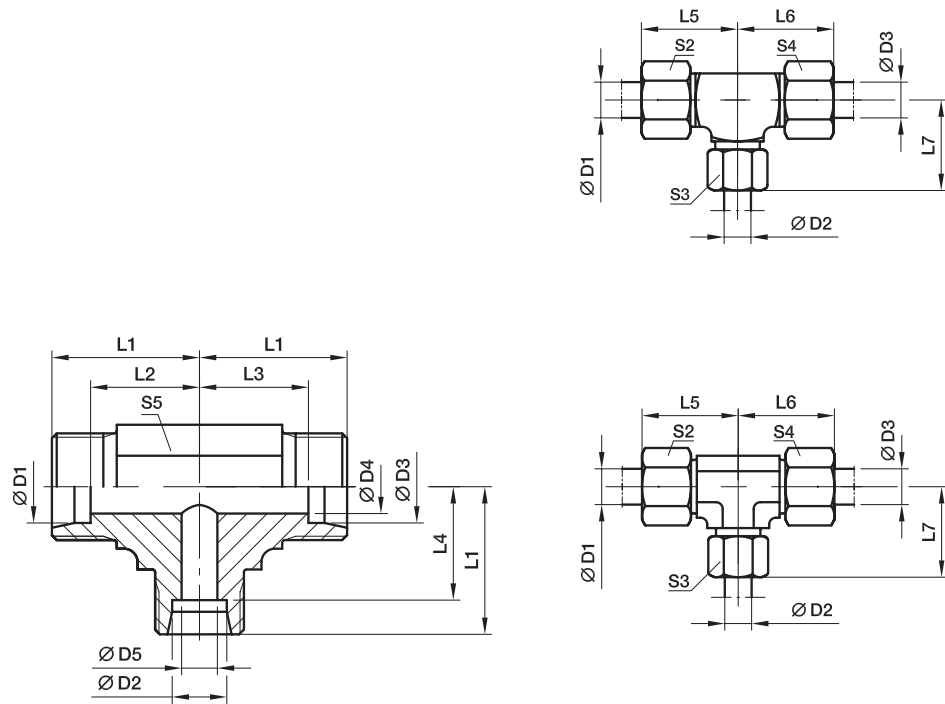

| Series | D1 | D2 | D3 | D4 | D5 | L1 | L2 | L3 | L4 | L5 | L6 | L7 | S2 | S3 | S4 | S5 | Weight g/1 piece | Order code* | PN (bar) ¹⁾ | | |
|------------------|----|----|------|------|----|------|------|------|------|----|----|----|----|----|----|-----|---------------------|--------------|------------------------|-----|-----|
| | ⊕ | ⊕ | ⊕ | | | | | | | | | | | | | | | | CF | 71 | MS |
| LL ³⁾ | 04 | 08 | 04 | 3.0 | 6 | 17 | 13.0 | 13.0 | 11.5 | 23 | 23 | 23 | 10 | 14 | 10 | 12 | 27 | TR04/08/04LL | 100 | 100 | 63 |
| | 06 | 04 | 06 | 4.5 | 3 | 15 | 9.5 | 9.5 | 11.0 | 21 | 21 | 21 | 12 | 10 | 12 | 9 | 18 | TR06/04/06LL | 100 | 100 | 63 |
| L ³⁾ | 06 | 08 | 06 | 4.0 | 6 | 21 | 14.0 | 14.0 | 14.0 | 29 | 29 | 29 | 14 | 17 | 14 | 12 | 54 | TR06/08/06L | 500 | 315 | 200 |
| | 08 | 06 | 08 | 6.0 | 4 | 21 | 14.0 | 14.0 | 14.0 | 29 | 29 | 29 | 17 | 14 | 17 | 12 | 53 | TR08/06/08L | 500 | 315 | 200 |
| | 06 | 10 | 06 | 4.0 | 8 | 22 | 15.0 | 15.0 | 15.0 | 30 | 30 | 30 | 14 | 19 | 14 | 14 | 53 | TR06/10/06L | 500 | 315 | 200 |
| | 08 | 10 | 08 | 6.0 | 8 | 22 | 15.0 | 15.0 | 15.0 | 30 | 30 | 30 | 17 | 19 | 17 | 14 | 50 | TR08/10/08L | 500 | 315 | 200 |
| | 10 | 06 | 10 | 8.0 | 4 | 22 | 15.0 | 15.0 | 15.0 | 30 | 30 | 30 | 19 | 14 | 19 | 14 | 46 | TR10/06/10L | 500 | 315 | 200 |
| | 10 | 08 | 10 | 8.0 | 6 | 22 | 15.0 | 15.0 | 15.0 | 30 | 30 | 30 | 19 | 17 | 19 | 14 | 43 | TR10/08/10L | 500 | 315 | 200 |
| | 10 | 10 | 06 | 4.0 | 8 | 22 | 15.0 | 15.0 | 15.0 | 30 | 30 | 30 | 19 | 19 | 14 | 14 | 49 | TR10/10/06L | 500 | 315 | 200 |
| | 08 | 12 | 08 | 6.0 | 10 | 24 | 17.0 | 17.0 | 17.0 | 32 | 32 | 32 | 17 | 22 | 17 | 17 | 67 | TR08/12/08L | 400 | 315 | 200 |
| | 12 | 06 | 12 | 10.0 | 4 | 24 | 17.0 | 17.0 | 17.0 | 32 | 32 | 32 | 22 | 14 | 22 | 17 | 66 | TR12/06/12L | 400 | 315 | 200 |
| | 12 | 08 | 08 | 6.0 | 6 | 24 | 17.0 | 17.0 | 17.0 | 32 | 32 | 32 | 22 | 17 | 17 | 17 | 66 | TR12/08/08L | 400 | 315 | 200 |
| | 12 | 08 | 12 | 10.0 | 6 | 24 | 17.0 | 17.0 | 17.0 | 32 | 32 | 32 | 22 | 17 | 22 | 17 | 68 | TR12/08/12L | 400 | 315 | 200 |
| | 12 | 10 | 10 | 8.0 | 8 | 24 | 17.0 | 17.0 | 17.0 | 32 | 32 | 32 | 22 | 19 | 19 | 17 | 67 | TR12/10/10L | 400 | 315 | 200 |
| | 12 | 10 | 12 | 10.0 | 8 | 24 | 17.0 | 17.0 | 17.0 | 32 | 32 | 32 | 22 | 19 | 22 | 17 | 67 | TR12/10/12L | 400 | 315 | 200 |
| | 12 | 12 | 10 | 8.0 | 10 | 24 | 17.0 | 17.0 | 17.0 | 32 | 32 | 32 | 22 | 22 | 19 | 17 | 64 | TR12/12/10L | 400 | 315 | 200 |
| | 10 | 15 | 10 | 8.0 | 12 | 28 | 21.0 | 21.0 | 21.0 | 36 | 36 | 36 | 19 | 27 | 19 | 19 | 105 | TR10/15/10L | 400 | 315 | 200 |
| | 12 | 15 | 12 | 10.0 | 12 | 28 | 21.0 | 21.0 | 21.0 | 36 | 36 | 36 | 22 | 27 | 22 | 19 | 102 | TR12/15/12L | 400 | 315 | 200 |
| | 15 | 06 | 15 | 12.0 | 4 | 28 | 21.0 | 21.0 | 21.0 | 36 | 36 | 36 | 27 | 14 | 27 | 19 | 107 | TR15/06/15L | 400 | 315 | 200 |
| | 15 | 10 | 15 | 12.0 | 8 | 28 | 21.0 | 21.0 | 21.0 | 36 | 36 | 36 | 27 | 19 | 27 | 19 | 105 | TR15/10/15L | 400 | 315 | 200 |
| | 15 | 12 | 12 | 10.0 | 10 | 28 | 21.0 | 21.0 | 21.0 | 36 | 36 | 36 | 27 | 22 | 22 | 19 | 101 | TR15/12/12L | 400 | 315 | 200 |
| | 15 | 12 | 15 | 12.0 | 10 | 28 | 21.0 | 21.0 | 21.0 | 36 | 36 | 36 | 27 | 22 | 27 | 19 | 105 | TR15/12/15L | 400 | 315 | 200 |
| | 15 | 15 | 12 | 10.0 | 12 | 28 | 21.0 | 21.0 | 21.0 | 36 | 36 | 36 | 27 | 27 | 22 | 19 | 103 | TR15/15/12L | 400 | 315 | 200 |
| | 12 | 18 | 12 | 10.0 | 15 | 31 | 24.0 | 24.0 | 23.5 | 39 | 39 | 40 | 22 | 32 | 22 | 24 | 177 | TR12/18/12L | 400 | 315 | 200 |
| | 18 | 10 | 10 | 8.0 | 8 | 31 | 23.5 | 24.0 | 24.0 | 40 | 39 | 39 | 32 | 19 | 19 | 24 | 173 | TR18/10/10L | 400 | 315 | 200 |
| | 18 | 10 | 18 | 15.0 | 8 | 31 | 23.5 | 23.5 | 24.0 | 40 | 40 | 39 | 32 | 19 | 32 | 24 | 182 | TR18/10/18L | 400 | 315 | 200 |
| 18 | 12 | 18 | 15.0 | 10 | 31 | 23.5 | 23.5 | 24.0 | 40 | 40 | 39 | 32 | 22 | 32 | 24 | 174 | TR18/12/18L | 400 | 315 | 200 | |



TR Tee Reducer

EO 24° cone end

| Series | D1 | D2 | D3 | D4 | D5 | L1 | L2 | L3 | L4 | L5 | L6 | L7 | S2 | S3 | S4 | S5 | Weight g/1 piece | Order code* | PN (bar) ¹⁾ | | |
|-----------------|----|----|------|------|----|------|------|------|------|----|----|----|----|----|----|-----|---------------------|-------------|------------------------|-----|-----|
| | ⊕ | ⊕ | ⊕ | | | | | | | | | | | | | | | | CF | 71 | MS |
| L ³⁾ | 18 | 15 | 18 | 15.0 | 12 | 31 | 23.5 | 23.5 | 24.0 | 40 | 40 | 39 | 32 | 27 | 32 | 24 | 179 | TR18/15/18L | 400 | 315 | 200 |
| | 18 | 18 | 10 | 8.0 | 15 | 31 | 23.5 | 24.0 | 23.5 | 40 | 39 | 40 | 32 | 32 | 19 | 24 | 171 | TR18/18/10L | 400 | 315 | 200 |
| | 22 | 10 | 22 | 19.0 | 8 | 35 | 27.5 | 27.5 | 28.0 | 44 | 44 | 43 | 36 | 19 | 36 | 27 | 232 | TR22/10/22L | 250 | 160 | 100 |
| | 22 | 12 | 22 | 19.0 | 10 | 35 | 27.5 | 27.5 | 28.0 | 44 | 44 | 43 | 36 | 22 | 36 | 27 | 229 | TR22/12/22L | 250 | 160 | 100 |
| | 22 | 15 | 15 | 12.0 | 12 | 35 | 27.5 | 28.0 | 28.0 | 44 | 43 | 43 | 36 | 27 | 27 | 27 | 240 | TR22/15/15L | 250 | 160 | 100 |
| | 22 | 15 | 22 | 19.0 | 12 | 35 | 27.5 | 27.5 | 28.0 | 44 | 44 | 43 | 36 | 27 | 36 | 27 | 233 | TR22/15/22L | 250 | 160 | 100 |
| | 22 | 18 | 18 | 15.0 | 15 | 35 | 27.5 | 27.5 | 27.5 | 44 | 44 | 44 | 36 | 32 | 32 | 27 | 236 | TR22/18/18L | 250 | 160 | 100 |
| | 22 | 18 | 22 | 19.0 | 15 | 35 | 27.5 | 27.5 | 27.5 | 44 | 44 | 44 | 36 | 32 | 36 | 27 | 239 | TR22/18/22L | 250 | 160 | 100 |
| | 22 | 22 | 18 | 15.0 | 19 | 35 | 27.5 | 27.5 | 27.5 | 44 | 44 | 44 | 36 | 36 | 32 | 27 | 228 | TR22/22/18L | 250 | 160 | 100 |
| | 28 | 10 | 28 | 24.0 | 8 | 38 | 30.5 | 30.5 | 31.0 | 47 | 47 | 46 | 41 | 19 | 41 | 36 | 412 | TR28/10/28L | 250 | 160 | 100 |
| | 28 | 12 | 28 | 24.0 | 10 | 38 | 30.5 | 30.5 | 31.0 | 47 | 47 | 46 | 41 | 22 | 41 | 36 | 408 | TR28/12/28L | 250 | 160 | 100 |
| | 28 | 15 | 28 | 24.0 | 12 | 38 | 30.5 | 30.5 | 31.0 | 47 | 47 | 46 | 41 | 27 | 41 | 36 | 423 | TR28/15/28L | 250 | 160 | 100 |
| | 28 | 18 | 28 | 24.0 | 15 | 38 | 30.5 | 30.5 | 30.5 | 47 | 47 | 47 | 41 | 32 | 41 | 36 | 421 | TR28/18/28L | 250 | 160 | 100 |
| | 28 | 22 | 22 | 19.0 | 19 | 38 | 30.5 | 30.5 | 30.5 | 47 | 47 | 47 | 41 | 36 | 36 | 36 | 412 | TR28/22/22L | 250 | 160 | 100 |
| | 28 | 22 | 28 | 24.0 | 19 | 38 | 30.5 | 30.5 | 30.5 | 47 | 47 | 47 | 41 | 36 | 41 | 36 | 415 | TR28/22/28L | 250 | 160 | 100 |
| S ⁴⁾ | 10 | 06 | 10 | 7.0 | 4 | 25 | 17.5 | 17.5 | 18.0 | 34 | 34 | 33 | 22 | 17 | 22 | 17 | 103 | TR10/06/10S | 800 | 630 | 400 |
| | 12 | 08 | 08 | 5.0 | 5 | 29 | 21.5 | 22.0 | 22.0 | 38 | 37 | 37 | 24 | 19 | 19 | 19* | 107 | TR12/08/08S | 630 | 630 | 400 |
| | 12 | 08 | 12 | 8.0 | 5 | 29 | 21.5 | 21.5 | 22.0 | 38 | 38 | 37 | 24 | 19 | 24 | 19* | 105 | TR12/08/12S | 630 | 630 | 400 |
| | 12 | 10 | 12 | 8.0 | 7 | 29 | 21.5 | 21.5 | 21.5 | 38 | 38 | 38 | 24 | 22 | 24 | 19* | 114 | TR12/10/12S | 630 | 630 | 400 |
| | 12 | 16 | 12 | 8.0 | 12 | 33 | 25.5 | 25.5 | 24.5 | 42 | 42 | 43 | 24 | 30 | 24 | 24 | 190 | TR12/16/12S | 630 | 400 | 250 |
| | 16 | 06 | 16 | 12.0 | 4 | 33 | 24.5 | 24.5 | 26.0 | 43 | 43 | 41 | 30 | 17 | 30 | 24 | 176 | TR16/06/16S | 630 | 400 | 250 |
| | 16 | 08 | 16 | 12.0 | 5 | 33 | 24.5 | 24.5 | 26.0 | 43 | 43 | 41 | 30 | 19 | 30 | 24 | 208 | TR16/08/16S | 630 | 400 | 250 |
| | 16 | 10 | 16 | 12.0 | 7 | 33 | 24.5 | 24.5 | 25.5 | 43 | 43 | 42 | 30 | 22 | 30 | 24 | 210 | TR16/10/16S | 630 | 400 | 250 |
| | 16 | 12 | 16 | 12.0 | 8 | 33 | 24.5 | 24.5 | 25.5 | 43 | 43 | 42 | 30 | 24 | 30 | 24 | 386 | TR16/12/16S | 630 | 400 | 250 |
| | 16 | 20 | 16 | 12.0 | 16 | 37 | 28.5 | 28.5 | 26.5 | 47 | 47 | 48 | 30 | 36 | 30 | 27 | 296 | TR16/20/16S | 420 | 400 | 250 |
| | 20 | 10 | 20 | 16.0 | 7 | 37 | 26.5 | 26.5 | 29.5 | 48 | 48 | 46 | 36 | 22 | 36 | 27 | 553 | TR20/10/20S | 420 | 400 | 250 |
| | 20 | 12 | 20 | 16.0 | 8 | 37 | 26.5 | 26.5 | 29.5 | 48 | 48 | 46 | 36 | 24 | 36 | 27 | 306 | TR20/12/20S | 420 | 400 | 250 |
| | 20 | 16 | 20 | 16.0 | 12 | 37 | 26.5 | 26.5 | 28.5 | 48 | 48 | 47 | 36 | 30 | 36 | 27 | 285 | TR20/16/20S | 420 | 400 | 250 |
| | 20 | 25 | 20 | 16.0 | 20 | 42 | 31.5 | 31.5 | 30.0 | 53 | 53 | 54 | 36 | 46 | 36 | 36 | 544 | TR20/25/20S | 420 | 400 | 250 |
| | 25 | 16 | 25 | 20.0 | 12 | 42 | 30.0 | 30.0 | 33.5 | 54 | 54 | 52 | 46 | 30 | 46 | 36 | 556 | TR25/16/25S | 420 | 400 | 250 |
| 25 | 20 | 25 | 20.0 | 16 | 42 | 30.0 | 30.0 | 31.5 | 54 | 54 | 53 | 46 | 36 | 46 | 36 | 544 | TR25/20/25S | 420 | 400 | 250 | |
| 25 | 30 | 25 | 20.0 | 25 | 49 | 37.0 | 37.0 | 35.5 | 61 | 61 | 62 | 46 | 50 | 46 | 41 | 791 | TR25/30/25S | 420 | 400 | 250 | |

¹⁾ Pressure shown = item deliverable

²⁾ LL = very light series; ³⁾ L = light series; ⁴⁾ S = heavy series

*S5 = 17 in 1.4571

$\frac{PN \text{ (bar)}}{10} = PN \text{ (MPa)}$

Delivery without nut and ring. Information on ordering complete fittings see page 17.

*Please add the suffixes below according to the material/surface required.

| Order code suffixes | | |
|---------------------------------|-----------------------------|----------------|
| Material | Suffix surface and material | Example |
| Steel, zinc plated, Cr(VI)-free | CFX | TR16/12/16SCFX |
| Stainless Steel | 71X | TR16/12/16S71X |
| Brass | MSX | TR16/12/16SMSX |

K Union cross

EO 24° cone end

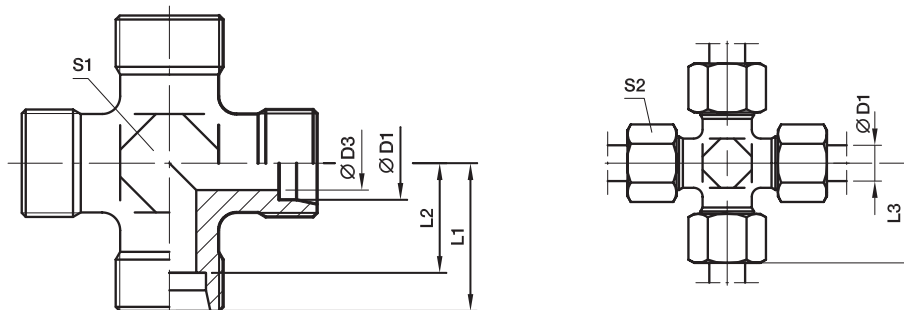

| Series | D1 | D3 | L1 | L2 | L3 | S1 | S2 | Weight g/1 piece | Order code* | PN (bar) ¹⁾ | | |
|------------------|----|------|----|------|----|----|----|---------------------|--------------|------------------------|-----|-----|
| | | | | | | | | | | CF | 71 | MS |
| LL ²⁾ | 04 | 3.0 | 15 | 11.0 | 21 | 9 | 10 | 13 | K04LL | 100 | 100 | 63 |
| | 06 | 4.5 | 15 | 9.5 | 21 | 9 | 12 | 14 | K06LL | 100 | 100 | 63 |
| | 08 | 6.0 | 17 | 11.5 | 23 | 12 | 14 | 24 | K08LL | 100 | 100 | 63 |
| L ³⁾ | 06 | 4.0 | 19 | 12.0 | 27 | 12 | 14 | 35 | K06L | 315 | 315 | 200 |
| | 08 | 6.0 | 21 | 14.0 | 29 | 12 | 17 | 40 | K08L | 315 | 315 | 200 |
| | 10 | 8.0 | 22 | 15.0 | 30 | 14 | 19 | 52 | K10L | 315 | 315 | 200 |
| | 12 | 10.0 | 24 | 17.0 | 32 | 17 | 22 | 69 | K12L | 315 | 315 | 200 |
| | 15 | 12.0 | 28 | 21.0 | 36 | 19 | 27 | 130 | K15L | 315 | 315 | 200 |
| | 18 | 15.0 | 31 | 23.5 | 40 | 24 | 32 | 188 | K18L | 315 | 315 | 200 |
| | 22 | 19.0 | 35 | 27.5 | 44 | 27 | 36 | 251 | K22L | 160 | 160 | 100 |
| | 28 | 24.0 | 38 | 30.5 | 47 | 36 | 41 | 392 | K28L | 160 | 160 | 100 |
| | 35 | 30.0 | 45 | 34.5 | 56 | 41 | 50 | 618 | K35L | 160 | 160 | 100 |
| | 42 | 36.0 | 51 | 40.0 | 63 | 50 | 60 | 905 | K42L | 160 | 160 | 100 |
| S ⁴⁾ | 06 | 4.0 | 23 | 16.0 | 31 | 12 | 17 | 58 | K06S | 630 | 630 | 400 |
| | 08 | 5.0 | 24 | 17.0 | 32 | 14 | 19 | 82 | K08S | 630 | 630 | 400 |
| | 10 | 7.0 | 25 | 17.5 | 34 | 17 | 22 | 97 | K10S | 630 | 630 | 400 |
| | 12 | 8.0 | 29 | 21.5 | 38 | 17 | 24 | 146 | K12S | 630 | 630 | 400 |
| | 16 | 12.0 | 33 | 24.5 | 43 | 24 | 30 | 220 | K16S | 400 | 400 | 250 |
| | 20 | 16.0 | 37 | 26.5 | 48 | 27 | 36 | 339 | K20S | 315 | 315 | 200 |
| | 25 | 20.0 | 42 | 30.0 | 54 | 36 | 46 | 576 | K25S | 315 | 315 | 200 |
| | 30 | 25.0 | 49 | 35.5 | 62 | 41 | 50 | 843 | K30S | 315 | 315 | 200 |
| | 38 | 32.0 | 57 | 41.0 | 72 | 50 | 60 | 1350 | K38S | 315 | 315 | 200 |

¹⁾ Pressure shown = item deliverable

²⁾ LL = very light series; ³⁾ L = light series; ⁴⁾ S = heavy series

PN (bar) = PN (MPa)
10

Delivery without nut and ring. Information on ordering complete fittings see page I7.

*Please add the **suffixes** below according to the material/surface required.

| Order code suffixes | | |
|---------------------------------|-----------------------------|---------|
| Material | Suffix surface and material | Example |
| Steel, zinc plated, Cr(VI)-free | CFX | K16SCFX |
| Stainless Steel | 71X | K16S71X |
| Brass | MSX | K16SMSX |



SV Bulkhead union

EO 24° cone end

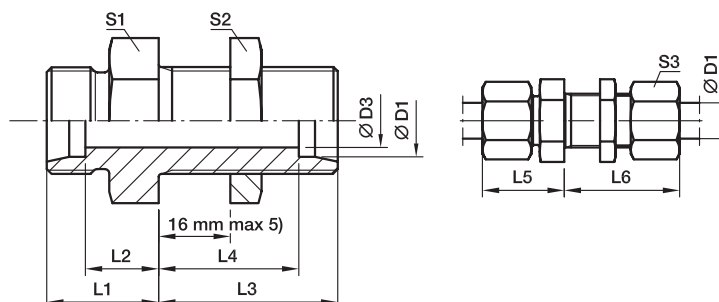

| Series | D1 | D3 | L1 | L2 | L3 | L4 | L5 | L6 | S1 | S2 | S3 | Weight g/1 piece | Order code* | PN (bar) ¹⁾ | | |
|-----------------|----|----|------|------|------|------|----|----|----|----|------|---------------------|-------------|------------------------|-----|-----|
| | | | | | | | | | | | | | | CF | 71 | MS |
| L ³⁾ | 06 | 4 | 14 | 7.0 | 34 | 27.0 | 22 | 42 | 17 | 17 | 14 | 39 | SV06LOMD | 500 | 315 | 200 |
| | 08 | 6 | 15 | 8.0 | 34 | 27.0 | 23 | 42 | 19 | 19 | 17 | 50 | SV08LOMD | 500 | 315 | 200 |
| | 10 | 8 | 17 | 10.0 | 35 | 28.0 | 25 | 43 | 22 | 22 | 19 | 67 | SV10LOMD | 500 | 315 | 200 |
| | 12 | 10 | 17 | 10.0 | 36 | 29.0 | 25 | 44 | 24 | 24 | 22 | 78 | SV12LOMD | 400 | 315 | 200 |
| | 15 | 12 | 19 | 12.0 | 38 | 31.0 | 27 | 46 | 27 | 30 | 27 | 128 | SV15LOMD | 400 | 315 | 200 |
| | 18 | 15 | 21 | 13.5 | 40 | 32.5 | 30 | 49 | 32 | 36 | 32 | 198 | SV18LOMD | 400 | 315 | 200 |
| | 22 | 19 | 24 | 16.5 | 42 | 34.5 | 33 | 51 | 36 | 41 | 36 | 254 | SV22LOMD | 250 | 160 | 100 |
| | 28 | 24 | 26 | 18.5 | 43 | 35.5 | 35 | 52 | 41 | 46 | 41 | 335 | SV28LOMD | 250 | 160 | 100 |
| | 35 | 30 | 29 | 18.5 | 47 | 36.5 | 40 | 58 | 50 | 55 | 50 | 546 | SV35LOMD | 250 | 160 | 160 |
| | 42 | 36 | 30 | 19.0 | 47 | 36.0 | 42 | 59 | 60 | 65 | 60 | 758 | SV42LOMD | 250 | 160 | 160 |
| S ⁴⁾ | 06 | 4 | 19 | 12.0 | 36 | 29.0 | 27 | 44 | 19 | 19 | 17 | 65 | SV06SOMD | 800 | 630 | 400 |
| | 08 | 5 | 20 | 13.0 | 36 | 29.0 | 28 | 44 | 22 | 22 | 19 | 87 | SV08SOMD | 800 | 630 | 400 |
| | 10 | 7 | 22 | 14.5 | 37 | 29.5 | 31 | 46 | 24 | 24 | 22 | 112 | SV10SOMD | 800 | 630 | 400 |
| | 12 | 8 | 22 | 14.5 | 38 | 30.5 | 31 | 47 | 27 | 27 | 24 | 141 | SV12SOMD | 630 | 630 | 400 |
| | 16 | 12 | 25 | 16.5 | 40 | 31.5 | 35 | 50 | 32 | 32 | 30 | 201 | SV16SOMD | 630 | 400 | 250 |
| | 20 | 16 | 28 | 17.5 | 44 | 33.5 | 39 | 55 | 41 | 41 | 36 | 462 | SV20SOMD | 420 | 400 | 250 |
| | 25 | 20 | 32 | 20.0 | 47 | 35.0 | 44 | 59 | 46 | 46 | 46 | 492 | SV25SOMD | 420 | 400 | 250 |
| | 30 | 25 | 35 | 21.5 | 51 | 37.5 | 48 | 64 | 50 | 50 | 50 | 631 | SV30SOMD | 420 | 400 | 250 |
| 38 | 32 | 38 | 22.0 | 53 | 37.0 | 53 | 68 | 65 | 65 | 60 | 1083 | SV38SOMD | 420 | 315 | | |

¹⁾ Pressure shown = item deliverable

³⁾ L = light series; ⁴⁾ S = heavy series

⁵⁾ Bulkhead thickness min.

06–18 L and 06–16 S = 3 mm

22–42 L and 20–38 S = 4 mm

PN (bar)
10 = PN (MPa)

Delivery without nut and ring. Information on ordering complete fittings see page 17.

*Please add the suffixes below according to the material/surface required.

| Order code suffixes | | |
|---------------------------------|-----------------------------|------------|
| Material | Suffix surface and material | Example |
| Steel, zinc plated, Cr(VI)-free | CF | SV16SOMDCF |
| Stainless Steel | 71 | SV16SOMD71 |
| Brass | MS | SV16SOMDMS |

WSV Bulkhead elbow

EO 24° cone end

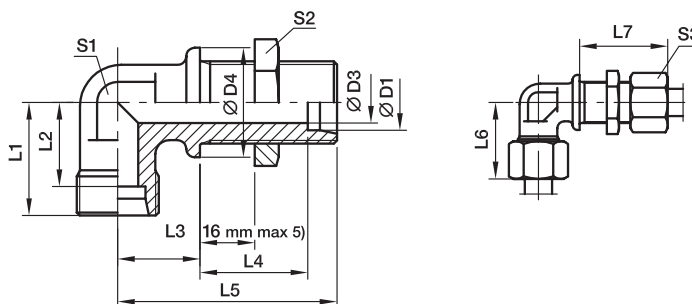

| Series | D1 | D3 | D4 | L1 | L2 | L3 | L4 | L5 | L6 | L7 | S1 | S2 | S3 | Weight g/1 piece | Order code* | PN (bar) ¹⁾ | | |
|-----------------|----|----|----|------|------|------|------|----|----|----|----|----|------|---------------------|-------------|------------------------|-----|-----|
| | | | | | | | | | | | | | | | | CF | 71 | MS |
| L ³⁾ | 06 | 4 | 17 | 19 | 12.0 | 14 | 27.0 | 48 | 27 | 42 | 12 | 17 | 14 | 51 | WSV06LOMD | 315 | 315 | 200 |
| | 08 | 6 | 19 | 21 | 14.0 | 17 | 27.0 | 51 | 29 | 42 | 12 | 19 | 17 | 61 | WSV08LOMD | 315 | 315 | 200 |
| | 10 | 8 | 22 | 22 | 15.0 | 18 | 28.0 | 53 | 30 | 43 | 14 | 22 | 19 | 78 | WSV10LOMD | 315 | 315 | 200 |
| | 12 | 10 | 24 | 24 | 17.0 | 20 | 29.0 | 56 | 32 | 44 | 17 | 24 | 22 | 85 | WSV12LOMD | 315 | 315 | 200 |
| | 15 | 12 | 27 | 28 | 21.0 | 23 | 31.0 | 61 | 36 | 46 | 19 | 30 | 27 | 150 | WSV15LOMD | 315 | 315 | 200 |
| | 18 | 15 | 32 | 31 | 23.5 | 24 | 32.5 | 64 | 40 | 49 | 24 | 36 | 32 | 238 | WSV18LOMD | 315 | 315 | 200 |
| | 22 | 19 | 36 | 35 | 27.5 | 30 | 34.5 | 72 | 44 | 51 | 27 | 41 | 36 | 327 | WSV22LOMD | 160 | 160 | |
| | 28 | 24 | 42 | 38 | 30.5 | 34 | 35.5 | 77 | 47 | 52 | 36 | 46 | 41 | 482 | WSV28LOMD | 160 | 160 | |
| | 35 | 30 | 50 | 45 | 34.5 | 39 | 36.5 | 86 | 56 | 58 | 41 | 55 | 50 | 729 | WSV35LOMD | 160 | 160 | |
| | 42 | 36 | 60 | 51 | 40.0 | 43 | 36.0 | 90 | 63 | 59 | 50 | 65 | 60 | 1091 | WSV42LOMD | 160 | 160 | |
| S ⁴⁾ | 06 | 4 | 19 | 23 | 16.0 | 17 | 29.0 | 53 | 31 | 44 | 12 | 19 | 17 | 72 | WSV06SOMD | 630 | 630 | |
| | 08 | 5 | 22 | 24 | 17.0 | 18 | 29.0 | 54 | 32 | 44 | 14 | 22 | 19 | 99 | WSV08SOMD | 630 | 630 | |
| | 10 | 7 | 24 | 25 | 17.5 | 20 | 29.5 | 57 | 34 | 46 | 17 | 24 | 22 | 128 | WSV10SOMD | 630 | 630 | |
| | 12 | 8 | 27 | 29 | 21.5 | 21 | 30.5 | 59 | 38 | 47 | 17 | 27 | 24 | 168 | WSV12SOMD | 630 | 630 | |
| | 16 | 12 | 30 | 33 | 24.5 | 24 | 31.5 | 64 | 43 | 50 | 24 | 32 | 30 | 249 | WSV16SOMD | 400 | 400 | |
| | 20 | 16 | 36 | 37 | 26.5 | 30 | 33.5 | 74 | 48 | 55 | 27 | 41 | 36 | 390 | WSV20SOMD | 400 | 400 | |
| | 25 | 20 | 42 | 42 | 30.0 | 34 | 35.0 | 81 | 54 | 59 | 36 | 46 | 46 | 618 | WSV25SOMD | 400 | 400 | |
| | 30 | 25 | 50 | 49 | 35.5 | 39 | 37.5 | 90 | 62 | 64 | 41 | 50 | 50 | 889 | WSV30SOMD | 400 | 400 | |
| 38 | 32 | 60 | 57 | 41.0 | 43 | 37.0 | 96 | 72 | 68 | 50 | 65 | 60 | 1337 | WSV38SOMD | 315 | 315 | | |

¹⁾ Pressure shown = item deliverable

³⁾ L = light series; ⁴⁾ S = heavy series

⁵⁾ Bulkhead thickness min.

06-18 L and 06-16 S = 3 mm

22-42 L and 20-38 S = 4 mm

PN (bar) = PN (MPa)
10

Delivery without nut and ring. Information on ordering complete fittings see page 17.

*Please add the suffixes below according to the material/surface required.

| Order code suffixes | | |
|---------------------------------|-----------------------------|-------------|
| Material | Suffix surface and material | Example |
| Steel, zinc plated, Cr(VI)-free | CF | WSV16SOMDCF |
| Stainless Steel | 71 | WSV16SOMD71 |
| Brass | MS | WSV18LOMDMS |



EW Swivel nut elbow

EO 24° cone end / EO 24° DKO swivel

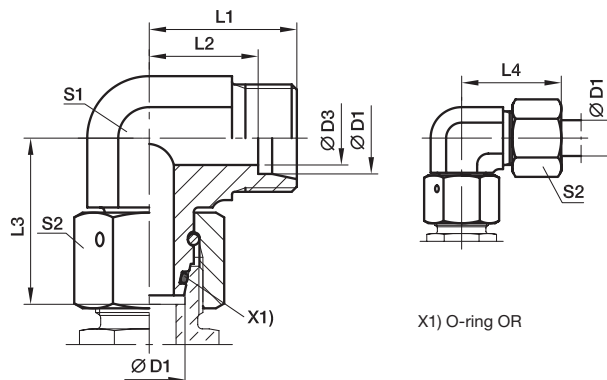

| Series | D1 | D3 | L1 | L2 | L3 | L4 | S1 | S2 | Weight g/1 piece | Order code* | PN (bar) ¹⁾ | |
|-----------------|----|----|----|------|------|----|----|----|---------------------|-----------------|------------------------|-----|
| | | | | | | | | | | | CF | 71 |
| L ³⁾ | 06 | 4 | 19 | 12.0 | 26.0 | 27 | 12 | 14 | 34 | EW06LOMD | 500 | 315 |
| | 08 | 6 | 21 | 14.0 | 27.5 | 29 | 12 | 17 | 43 | EW08LOMD | 500 | 315 |
| | 10 | 8 | 22 | 15.0 | 29.0 | 30 | 14 | 19 | 58 | EW10LOMD | 500 | 315 |
| | 12 | 10 | 24 | 17.0 | 29.5 | 32 | 17 | 22 | 81 | EW12LOMD | 400 | 315 |
| | 15 | 12 | 28 | 21.0 | 32.5 | 36 | 19 | 27 | 128 | EW15LOMD | 400 | 315 |
| | 18 | 15 | 31 | 23.5 | 35.5 | 40 | 24 | 32 | 197 | EW18LOMD | 400 | 315 |
| | 22 | 19 | 35 | 27.5 | 38.5 | 44 | 27 | 36 | 258 | EW22LOMD | 250 | 160 |
| | 28 | 24 | 38 | 30.5 | 41.5 | 47 | 36 | 41 | 370 | EW28LOMD | 250 | 160 |
| | 35 | 30 | 45 | 34.5 | 51.0 | 56 | 41 | 50 | 593 | EW35LOMD | 250 | 160 |
| | 42 | 36 | 51 | 40.0 | 56.0 | 63 | 50 | 60 | 993 | EW42LOMD | 250 | 160 |
| S ⁴⁾ | 06 | 4 | 23 | 16.0 | 27.0 | 31 | 12 | 17 | 48 | EW06SOMD | 800 | 630 |
| | 08 | 5 | 24 | 17.0 | 27.5 | 32 | 14 | 19 | 65 | EW08SOMD | 800 | 630 |
| | 10 | 6 | 25 | 17.5 | 30.0 | 34 | 17 | 22 | 92 | EW10SOMD | 800 | 630 |
| | 12 | 8 | 29 | 21.5 | 31.0 | 38 | 17 | 24 | 107 | EW12SOMD | 630 | 630 |
| | 16 | 12 | 33 | 24.5 | 36.5 | 43 | 24 | 30 | 212 | EW16SOMD | 630 | 400 |
| | 20 | 16 | 37 | 26.5 | 44.5 | 48 | 27 | 36 | 309 | EW20SOMD | 420 | 400 |
| | 25 | 20 | 42 | 30.0 | 50.0 | 54 | 36 | 46 | 547 | EW25SOMD | 420 | 400 |
| | 30 | 25 | 49 | 35.5 | 55.0 | 62 | 41 | 50 | 744 | EW30SOMD | 420 | 400 |
| | 38 | 32 | 57 | 41.0 | 63.0 | 72 | 50 | 60 | 1222 | EW38SOMD | 420 | 315 |

¹⁾ Pressure shown = item deliverable

³⁾ L = light series; ⁴⁾ S = heavy series

PN (bar) = PN (MPa)
10

Delivery without nut and ring. Information on ordering complete fittings or alternative sealing materials see page 17.

*Please add the **suffixes** below according to the material/surface required.

| Order code suffixes | | | |
|---------------------------------|-----------------------------|------------|---|
| Material | Suffix surface and material | Example | Standard sealing material (no additional suffix needed) |
| Steel, zinc plated, Cr(VI)-free | CF | EW16SOMDCF | NBR |
| Stainless Steel | 71 | EW16SOMD71 | VIT |

EV Swivel nut 45° elbow

EO 24° cone end / EO 24° DKO swivel

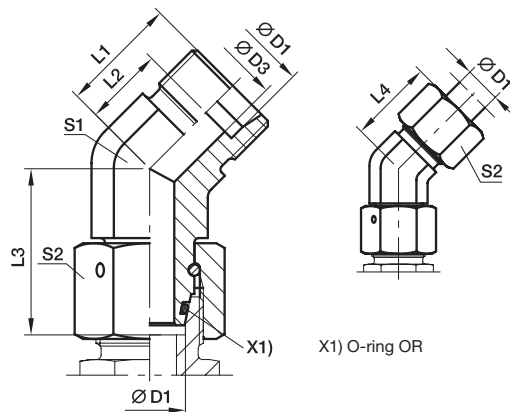

| Series | D1 | D3 | L1 | L2 | L3 | L4 | S1 | S2 | Weight g/1 piece | Order code* | PN (bar) ¹⁾ | |
|-----------------|----|----|------|------|------|----|----|----|---------------------|-----------------|------------------------|-----|
| | | | | | | | | | | | CF | 71 |
| L ³⁾ | 06 | 4 | 16.0 | 9.0 | 26.0 | 24 | 14 | 14 | 37 | EV06LOMD | 315 | 315 |
| | 08 | 6 | 19.0 | 12.0 | 27.5 | 27 | 14 | 17 | 49 | EV08LOMD | 315 | 315 |
| | 10 | 8 | 19.0 | 12.0 | 29.0 | 27 | 19 | 19 | 77 | EV10LOMD | 315 | 315 |
| | 12 | 10 | 21.0 | 14.0 | 29.5 | 29 | 19 | 22 | 86 | EV12LOMD | 315 | 315 |
| | 15 | 12 | 24.0 | 17.0 | 32.5 | 32 | 22 | 27 | 144 | EV15LOMD | 315 | 315 |
| | 18 | 15 | 24.0 | 16.5 | 35.5 | 33 | 27 | 32 | 210 | EV18LOMD | 315 | 315 |
| | 22 | 19 | 26.0 | 18.5 | 38.5 | 35 | 30 | 36 | 270 | EV22LOMD | 160 | 160 |
| | 28 | 24 | 30.5 | 23.0 | 41.5 | 40 | 36 | 41 | 385 | EV28LOMD | 160 | 160 |
| | 35 | 30 | 37.0 | 26.5 | 51.0 | 48 | 50 | 50 | 805 | EV35LOMD | 160 | 160 |
| | 42 | 36 | 37.0 | 26.0 | 56.0 | 49 | 50 | 60 | 887 | EV42LOMD | 160 | 160 |
| S ⁴⁾ | 06 | 4 | 16.0 | 9.0 | 27.0 | 24 | 14 | 17 | 50 | EV06SOMD | 630 | 630 |
| | 08 | 5 | 19.0 | 12.0 | 27.5 | 27 | 19 | 19 | 80 | EV08SOMD | 630 | 630 |
| | 10 | 7 | 21.0 | 13.5 | 30.0 | 30 | 19 | 22 | 95 | EV10SOMD | 630 | 630 |
| | 12 | 8 | 24.0 | 16.5 | 31.0 | 33 | 22 | 24 | 137 | EV12SOMD | 630 | 630 |
| | 16 | 12 | 24.0 | 15.5 | 36.5 | 34 | 27 | 30 | 217 | EV16SOMD | 400 | 400 |
| | 20 | 16 | 26.5 | 16.0 | 44.5 | 38 | 30 | 36 | 313 | EV20SOMD | 400 | 400 |
| | 25 | 20 | 30.5 | 18.5 | 50.0 | 43 | 36 | 46 | 529 | EV25SOMD | 400 | 400 |
| | 30 | 25 | 37.0 | 23.5 | 55.0 | 50 | 50 | 50 | 940 | EV30SOMD | 400 | 400 |
| | 38 | 32 | 37.0 | 21.0 | 63.0 | 52 | 50 | 60 | 1055 | EV38SOMD | 315 | 315 |

¹⁾ Pressure shown = item deliverable

³⁾ L = light series; ⁴⁾ S = heavy series

$\frac{PN(\text{bar})}{10} = PN(\text{MPa})$

Delivery without nut and ring. Information on ordering complete fittings or alternative sealing materials see page 17.

*Please add the **suffixes** below according to the material/surface required.

| Order code suffixes | | | |
|---------------------------------|-----------------------------|------------|---|
| Material | Suffix surface and material | Example | Standard sealing material (no additional suffix needed) |
| Steel, zinc plated, Cr(VI)-free | CF | EV16SOMDCF | NBR |
| Stainless Steel | 71 | EV16SOMD71 | VIT |



ET Swivel nut branch tee

EO 24° cone end / EO 24° DKO swivel

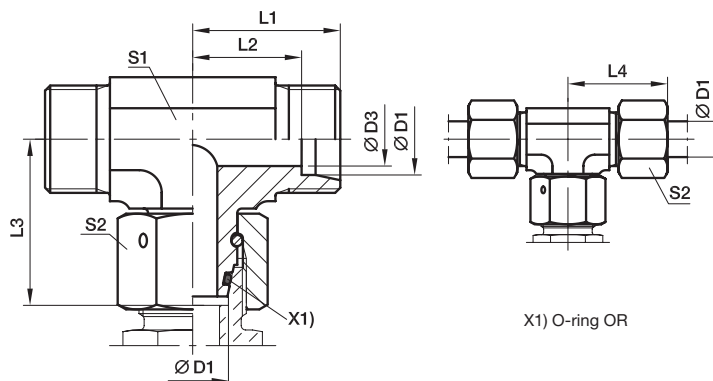

| Series | D1 | D3 | L1 | L2 | L3 | L4 | S1 | S2 | Weight g/1 piece | Order code* | PN (bar) ¹⁾ | |
|-----------------|----|----|----|------|------|----|----|----|---------------------|-----------------|------------------------|-----|
| | | | | | | | | | | | CF | 71 |
| L ³⁾ | 06 | 4 | 19 | 12.0 | 26.0 | 27 | 12 | 14 | 42 | ET06LOMD | 500 | 315 |
| | 08 | 6 | 21 | 14.0 | 27.5 | 29 | 12 | 17 | 53 | ET08LOMD | 500 | 315 |
| | 10 | 8 | 22 | 15.0 | 29.0 | 30 | 14 | 19 | 71 | ET10LOMD | 500 | 315 |
| | 12 | 10 | 24 | 17.0 | 29.5 | 32 | 17 | 22 | 97 | ET12LOMD | 400 | 315 |
| | 15 | 12 | 28 | 21.0 | 32.5 | 36 | 19 | 27 | 159 | ET15LOMD | 400 | 315 |
| | 18 | 15 | 31 | 23.5 | 35.5 | 40 | 24 | 32 | 239 | ET18LOMD | 400 | 315 |
| | 22 | 19 | 35 | 27.5 | 38.5 | 44 | 27 | 36 | 308 | ET22LOMD | 250 | 160 |
| | 28 | 24 | 38 | 30.5 | 41.5 | 47 | 36 | 41 | 449 | ET28LOMD | 250 | 160 |
| | 35 | 30 | 45 | 34.5 | 51.0 | 56 | 41 | 50 | 679 | ET35LOMD | 250 | 160 |
| | 42 | 36 | 51 | 40.0 | 56.0 | 63 | 50 | 60 | 1131 | ET42LOMD | 250 | 160 |
| S ⁴⁾ | 06 | 4 | 23 | 16.0 | 27.0 | 31 | 12 | 17 | 63 | ET06SOMD | 800 | 630 |
| | 08 | 5 | 24 | 17.0 | 27.5 | 32 | 14 | 19 | 79 | ET08SOMD | 800 | 630 |
| | 10 | 6 | 25 | 17.5 | 30.0 | 34 | 17 | 22 | 113 | ET10SOMD | 800 | 630 |
| | 12 | 8 | 29 | 21.5 | 31.0 | 38 | 17 | 24 | 136 | ET12SOMD | 630 | 630 |
| | 16 | 12 | 33 | 24.5 | 36.5 | 43 | 24 | 30 | 239 | ET16SOMD | 630 | 400 |
| | 20 | 16 | 37 | 26.5 | 44.5 | 48 | 27 | 36 | 388 | ET20SOMD | 420 | 400 |
| | 25 | 20 | 42 | 30.0 | 50.0 | 54 | 36 | 46 | 652 | ET25SOMD | 420 | 400 |
| | 30 | 25 | 49 | 35.5 | 55.0 | 62 | 41 | 50 | 905 | ET30SOMD | 420 | 400 |
| | 38 | 32 | 57 | 41.0 | 63.0 | 72 | 50 | 60 | 1462 | ET38SOMD | 420 | 315 |

¹⁾ Pressure shown = item deliverable

³⁾ L = light series; ⁴⁾ S = heavy series

PN (bar) / 10 = PN (MPa)

Delivery without nut and ring. Information on ordering complete fittings or alternative sealing materials see page 17.

| Order code suffixes | | | |
|---------------------------------|-----------------------------|------------|---|
| Material | Suffix surface and material | Example | Standard sealing material (no additional suffix needed) |
| Steel, zinc plated, Cr(VI)-free | CF | ET16SOMDCF | NBR |
| Stainless Steel | 71 | ET16SOMD71 | VIT |

*Please add the **suffixes** below according to the material/surface required.



EL Swivel nut run tee

EO 24° cone end / EO 24° DKO swivel

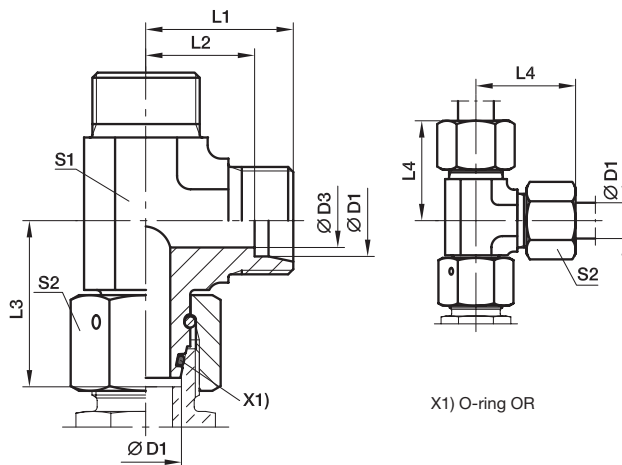

| Series | D1 | D3 | L1 | L2 | L3 | L4 | S1 | S2 | Weight g/1 piece | Order code* | PN (bar) ¹⁾ | |
|-----------------|----|----|----|------|------|----|----|----|---------------------|-------------|------------------------|-----|
| | | | | | | | | | | | CF | 71 |
| L ³⁾ | 06 | 4 | 19 | 12.0 | 26.0 | 27 | 12 | 14 | 44 | EL06LOMD | 500 | 315 |
| | 08 | 6 | 21 | 14.0 | 27.5 | 29 | 12 | 17 | 53 | EL08LOMD | 500 | 315 |
| | 10 | 8 | 22 | 15.0 | 29.0 | 30 | 14 | 19 | 68 | EL10LOMD | 500 | 315 |
| | 12 | 10 | 24 | 17.0 | 29.5 | 32 | 17 | 22 | 95 | EL12LOMD | 400 | 315 |
| | 15 | 12 | 28 | 21.0 | 32.5 | 36 | 19 | 27 | 151 | EL15LOMD | 400 | 315 |
| | 18 | 15 | 31 | 23.5 | 35.5 | 40 | 24 | 32 | 233 | EL18LOMD | 400 | 315 |
| | 22 | 19 | 35 | 27.5 | 38.5 | 44 | 27 | 36 | 309 | EL22LOMD | 250 | 160 |
| | 28 | 24 | 38 | 30.5 | 41.5 | 47 | 36 | 41 | 436 | EL28LOMD | 250 | 160 |
| | 35 | 30 | 45 | 34.5 | 51.0 | 56 | 41 | 50 | 666 | EL35LOMD | 250 | 160 |
| | 42 | 36 | 51 | 40.0 | 56.0 | 63 | 50 | 60 | 1163 | EL42LOMD | 250 | 160 |
| S ⁴⁾ | 06 | 4 | 23 | 16.0 | 27.0 | 31 | 12 | 17 | 65 | EL06SOMD | 800 | 630 |
| | 08 | 5 | 24 | 17.0 | 27.5 | 32 | 14 | 19 | 84 | EL08SOMD | 800 | 630 |
| | 10 | 6 | 25 | 17.5 | 30.0 | 34 | 17 | 22 | 118 | EL10SOMD | 800 | 630 |
| | 12 | 8 | 29 | 21.5 | 31.0 | 38 | 17 | 24 | 136 | EL12SOMD | 630 | 630 |
| | 16 | 12 | 33 | 24.5 | 36.5 | 43 | 24 | 30 | 260 | EL16SOMD | 630 | 400 |
| | 20 | 16 | 37 | 26.5 | 44.5 | 48 | 27 | 36 | 375 | EL20SOMD | 420 | 400 |
| | 25 | 20 | 42 | 30.0 | 50.0 | 54 | 36 | 46 | 655 | EL25SOMD | 420 | 400 |
| | 30 | 25 | 49 | 35.5 | 55.0 | 62 | 41 | 50 | 906 | EL30SOMD | 420 | 400 |
| | 38 | 32 | 57 | 41.0 | 63.0 | 72 | 50 | 60 | 1472 | EL38SOMD | 420 | 315 |

¹⁾ Pressure shown = item deliverable

³⁾ L = light series; ⁴⁾ S = heavy series

PN (bar)
10 = PN (MPa)

Delivery without nut and ring. Information on ordering complete fittings or alternative sealing materials see page 17.

| Order code suffixes | | | |
|---------------------------------|-----------------------------|------------|---|
| Material | Suffix surface and material | Example | Standard sealing material (no additional suffix needed) |
| Steel, zinc plated, Cr(VI)-free | CF | EL16SOMDCF | NBR |
| Stainless Steel | 71 | EL16SOMD71 | VIT |

*Please add the **suffixes** below according to the material/surface required.



EVW Standpipe elbow

EO 24° cone end / EO stand pipe adjustable

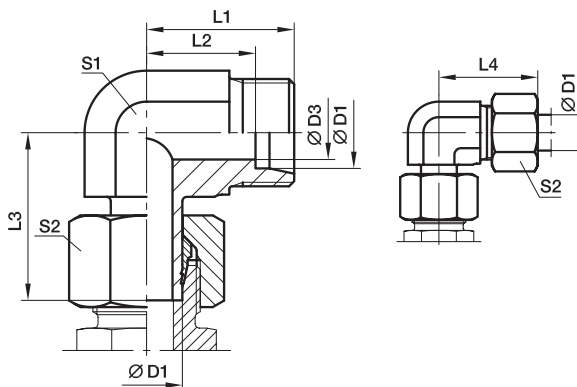

With pre-assembled nut and progressive ring for connection.
Final assembly (in appropriate body) at least 1/4 turn beyond the point of clearly perceptible resistance.

| Series | D1 | D3 | L1 | L2 | L3 | L4 | S1 | S2 | Weight g/1 piece | Order code* | PN (bar) ¹⁾ | | |
|-----------------|----|----|----|------|------|----|----|----|---------------------|------------------|------------------------|-----|-----|
| | | | | | | | | | | | CF | 71 | MS |
| L ³⁾ | 06 | 4 | 19 | 12.0 | 26.0 | 27 | 12 | 14 | 32 | EVW06LOMD | 315 | 315 | 200 |
| | 08 | 6 | 21 | 14.0 | 27.5 | 29 | 12 | 17 | 40 | EVW08LOMD | 315 | 315 | 200 |
| | 10 | 8 | 22 | 15.0 | 29.0 | 30 | 14 | 19 | 54 | EVW10LOMD | 315 | 315 | 200 |
| | 12 | 10 | 24 | 17.0 | 29.5 | 32 | 17 | 22 | 76 | EVW12LOMD | 315 | 315 | 200 |
| | 15 | 12 | 28 | 21.0 | 32.5 | 36 | 19 | 27 | 119 | EVW15LOMD | 315 | 315 | 200 |
| | 18 | 15 | 31 | 23.5 | 35.5 | 40 | 24 | 32 | 192 | EVW18LOMD | 315 | 315 | 200 |
| | 22 | 19 | 35 | 27.5 | 38.5 | 44 | 27 | 36 | 355 | EVW22LOMD | 160 | 160 | 100 |
| | 28 | 24 | 38 | 30.5 | 42.0 | 47 | 36 | 41 | 514 | EVW28LOMD | 160 | 160 | 100 |
| | 35 | 30 | 45 | 34.5 | 51.0 | 56 | 41 | 50 | 536 | EVW35LOMD | 160 | 160 | 100 |
| | 42 | 36 | 51 | 40.0 | 60.0 | 63 | 50 | 60 | 977 | EVW42LOMD | 160 | 160 | 100 |
| S ⁴⁾ | 06 | 4 | 23 | 16.0 | 27.0 | 31 | 12 | 17 | 44 | EVW06SOMD | 630 | 630 | 400 |
| | 08 | 5 | 24 | 17.0 | 27.5 | 32 | 14 | 19 | 63 | EVW08SOMD | 630 | 630 | 400 |
| | 10 | 7 | 25 | 17.5 | 31.0 | 34 | 17 | 22 | 95 | EVW10SOMD | 630 | 630 | 400 |
| | 12 | 8 | 29 | 21.5 | 31.0 | 38 | 17 | 24 | 110 | EVW12SOMD | 630 | 630 | 400 |
| | 16 | 12 | 33 | 24.5 | 37.5 | 43 | 24 | 30 | 211 | EVW16SOMD | 400 | 400 | 250 |
| | 20 | 16 | 37 | 26.5 | 44.5 | 48 | 27 | 36 | 306 | EVW20SOMD | 400 | 400 | 250 |
| | 25 | 20 | 42 | 30.0 | 50.0 | 54 | 36 | 46 | 558 | EVW25SOMD | 400 | 400 | 250 |
| | 30 | 25 | 49 | 35.5 | 55.0 | 62 | 41 | 50 | 724 | EVW30SOMD | 400 | 400 | 250 |
| | 38 | 32 | 57 | 41.0 | 66.5 | 72 | 50 | 60 | 1307 | EVW38SOMD | 315 | 315 | 200 |

¹⁾ Pressure shown = item deliverable

³⁾ L = light series; ⁴⁾ S = heavy series

PN (bar)
10 = PN (MPa)

The use of the swivel nut fitting EW is to be preferred (see page I27).

Delivery without nut and ring. Information on ordering complete fittings see page I7.

*Please add the **suffixes** below according to the material/surface required.

| Order code suffixes | | |
|---------------------------------|-----------------------------|-------------|
| Material | Suffix surface and material | Example |
| Steel, zinc plated, Cr(VI)-free | CF | EVW16SOMDCF |
| Stainless Steel | 71 | EVW16SOMD71 |
| Brass | MS | EVW16SOMDMS |

DIN fittings

EVT Standpipe branch tee

EO 24° cone end / EO stand pipe adjustable

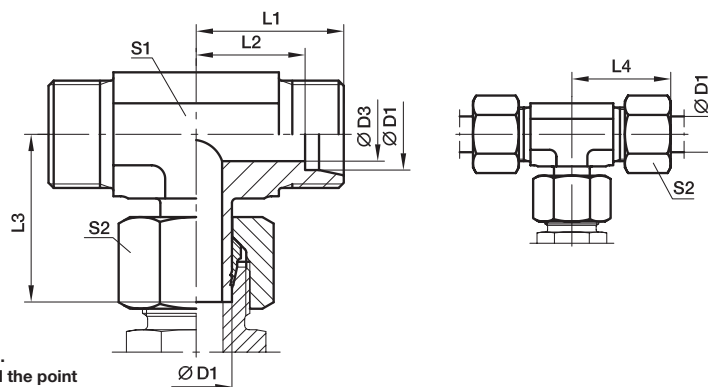

With pre-assembled nut and progressive ring for connection.
Final assembly (in appropriate body) at least 1/4 turn beyond the point of clearly perceptible resistance.

| Series | D1 | D3 | L1 | L2 | L3 | L4 | S1 | S2 | Weight g/1 piece | Order code* | PN (bar) ¹⁾ | | |
|-----------------|----|----|----|------|------|----|----|----|---------------------|------------------|------------------------|-----|-----|
| | | | | | | | | | | | CF | 71 | MS |
| L ³⁾ | 06 | 4 | 19 | 12.0 | 26.0 | 27 | 12 | 14 | 37 | EVT06LOMD | 315 | 315 | 200 |
| | 08 | 6 | 21 | 14.0 | 27.5 | 29 | 12 | 17 | 49 | EVT08LOMD | 315 | 315 | 200 |
| | 10 | 8 | 22 | 15.0 | 29.0 | 30 | 14 | 19 | 66 | EVT10LOMD | 315 | 315 | 200 |
| | 12 | 10 | 24 | 17.0 | 30.5 | 32 | 17 | 22 | 93 | EVT12LOMD | 315 | 315 | 200 |
| | 15 | 12 | 28 | 21.0 | 32.5 | 36 | 19 | 27 | 146 | EVT15LOMD | 315 | 315 | 200 |
| | 18 | 15 | 31 | 23.5 | 35.5 | 40 | 24 | 32 | 201 | EVT18LOMD | 315 | 315 | 200 |
| | 22 | 19 | 35 | 27.5 | 38.5 | 44 | 27 | 36 | 274 | EVT22LOMD | 160 | 160 | |
| | 28 | 24 | 38 | 30.5 | 43.5 | 47 | 36 | 41 | 441 | EVT28LOMD | 160 | 160 | |
| | 35 | 30 | 45 | 34.5 | 54.5 | 56 | 41 | 50 | 633 | EVT35LOMD | 160 | 160 | |
| | 42 | 36 | 51 | 40.0 | 60.0 | 63 | 50 | 60 | 1129 | EVT42LOMD | 160 | 160 | |
| S ⁴⁾ | 06 | 4 | 23 | 16.0 | 27.0 | 31 | 12 | 17 | 61 | EVT06SOMD | 630 | 630 | |
| | 08 | 5 | 24 | 17.0 | 29.0 | 32 | 14 | 19 | 44 | EVT08SOMD | 630 | 630 | |
| | 10 | 7 | 25 | 17.5 | 31.0 | 34 | 17 | 22 | 84 | EVT10SOMD | 630 | 630 | |
| | 12 | 8 | 29 | 21.5 | 33.0 | 38 | 17 | 24 | 131 | EVT12SOMD | 630 | 630 | |
| | 16 | 12 | 33 | 24.5 | 37.5 | 43 | 24 | 30 | 240 | EVT16SOMD | 400 | 400 | |
| | 20 | 16 | 37 | 26.5 | 44.5 | 48 | 27 | 36 | 345 | EVT20SOMD | 400 | 400 | |
| | 25 | 20 | 42 | 30.0 | 50.5 | 54 | 36 | 46 | 647 | EVT25SOMD | 400 | 400 | |
| | 30 | 25 | 49 | 35.5 | 56.5 | 62 | 41 | 50 | 873 | EVT30SOMD | 400 | 400 | |
| | 38 | 32 | 57 | 41.0 | 66.5 | 72 | 50 | 60 | 1361 | EVT38SOMD | 315 | 315 | |

¹⁾ Pressure shown = item deliverable

³⁾ L = light series; ⁴⁾ S = heavy series

$\frac{PN(\text{bar})}{10} = PN(\text{MPa})$

The use of the swivel nut fitting ET is to be preferred (see page I29).

Delivery without nut and ring. Information on ordering complete fittings see page I7.

*Please add the suffixes below according to the material/surface required.

| Order code suffixes | | |
|---------------------------------|-----------------------------|-------------|
| Material | Suffix surface and material | Example |
| Steel, zinc plated, Cr(VI)-free | CF | EVT16SOMDCF |
| Stainless Steel | 71 | EVT16SOMD71 |
| Brass | MS | EVT18LOMDMS |



EVL standpipe run tee

EO 24° cone end / EO stand pipe adjustable

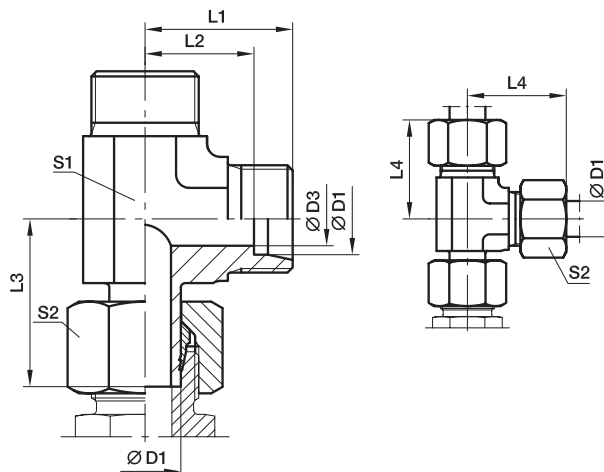

With pre-assembled nut and progressive ring for connection.
Final assembly (in appropriate body) at least 1/4 turn beyond the point of clearly perceptible resistance.

| Series | D1 | D3 | L1 | L2 | L3 | L4 | S1 | S2 | Weight g/1 piece | Order code* | PN (bar) ¹⁾ | | |
|-----------------|----|----|----|------|------|----|----|----|---------------------|------------------|------------------------|-----|-----|
| | | | | | | | | | | | CF | 71 | MS |
| L ³⁾ | 06 | 4 | 19 | 12.0 | 26.0 | 27 | 12 | 14 | 40 | EVL06LOMD | 315 | 315 | 200 |
| | 08 | 6 | 21 | 14.0 | 27.5 | 29 | 12 | 17 | 50 | EVL08LOMD | 315 | 315 | 200 |
| | 10 | 8 | 22 | 15.0 | 29.0 | 30 | 14 | 19 | 64 | EVL10LOMD | 315 | 315 | 200 |
| | 12 | 10 | 24 | 17.0 | 30.5 | 32 | 17 | 22 | 93 | EVL12LOMD | 315 | 315 | 200 |
| | 15 | 12 | 28 | 21.0 | 32.5 | 36 | 19 | 27 | 147 | EVL15LOMD | 315 | 315 | 200 |
| | 18 | 15 | 31 | 23.5 | 35.5 | 40 | 24 | 32 | 229 | EVL18LOMD | 315 | 315 | 200 |
| | 22 | 19 | 35 | 27.5 | 39.0 | 44 | 27 | 36 | 296 | EVL22LOMD | 160 | 160 | |
| | 28 | 24 | 38 | 30.5 | 43.5 | 47 | 36 | 41 | 416 | EVL28LOMD | 160 | 160 | |
| | 35 | 30 | 45 | 34.5 | 54.5 | 56 | 41 | 50 | 661 | EVL35LOMD | 160 | 160 | |
| | 42 | 36 | 51 | 40.0 | 60.0 | 63 | 50 | 60 | 1105 | EVL42LOMD | 160 | 160 | |
| S ⁴⁾ | 06 | 4 | 23 | 16.0 | 27.0 | 31 | 12 | 17 | 57 | EVL06SOMD | 630 | 630 | |
| | 08 | 5 | 24 | 17.0 | 29.0 | 32 | 14 | 19 | 84 | EVL08SOMD | 630 | 630 | |
| | 10 | 7 | 25 | 17.5 | 32.0 | 34 | 17 | 22 | 116 | EVL10SOMD | 630 | 630 | |
| | 12 | 8 | 29 | 21.5 | 33.0 | 38 | 17 | 24 | 137 | EVL12SOMD | 630 | 630 | |
| | 16 | 12 | 33 | 24.5 | 37.5 | 43 | 24 | 30 | 259 | EVL16SOMD | 400 | 400 | |
| | 20 | 16 | 37 | 26.5 | 44.5 | 48 | 27 | 36 | 371 | EVL20SOMD | 400 | 400 | |
| | 25 | 20 | 42 | 30.0 | 50.5 | 54 | 36 | 46 | 647 | EVL25SOMD | 400 | 400 | |
| | 30 | 25 | 49 | 35.5 | 56.5 | 62 | 41 | 50 | 906 | EVL30SOMD | 400 | 400 | |
| | 38 | 32 | 57 | 41.0 | 66.5 | 72 | 50 | 60 | 1549 | EVL38SOMD | 315 | 315 | |

¹⁾ Pressure shown = item deliverable

³⁾ L = light series; ⁴⁾ S = heavy series

PN (bar)
10 = PN (MPa)

The use of the swivel nut fitting EL is to be preferred (see page I30).

Delivery without nut and ring. Information on ordering complete fittings see page I7.

*Please add the suffixes below according to the material/surface required.

| Order code suffixes | | |
|---------------------------------|-----------------------------|-------------|
| Material | Suffix surface and material | Example |
| Steel, zinc plated, Cr(VI)-free | CF | EVL16SOMDCF |
| Stainless Steel | 71 | EVL16SOMD71 |
| Brass | MS | EVL18LOMDMS |

DA Distance piece adapter

EO 24° DKO swivel / EO 24° cone end

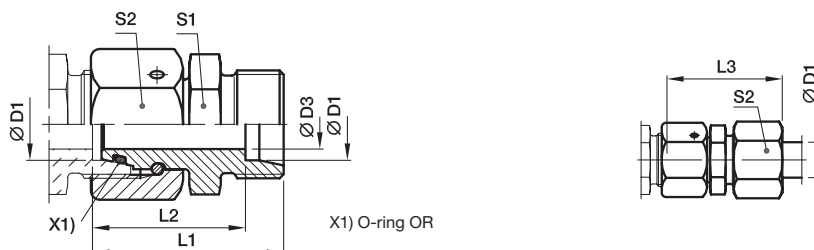

| Series | D1 | D3 | L1 | L2 | L3 | S1 | S2 | Weight g/1 piece | Order code* | PN (bar) ¹⁾ | | |
|-----------------|----|------|------|----|----|----|----|---------------------|-----------------|------------------------|-----|-----|
| | | | | | | | | | | CF | 71 | MS |
| L ³⁾ | 06 | 2,5 | 43.0 | 36 | 51 | 12 | 14 | 33 | DA06LOMD | 500 | 315 | 200 |
| | 08 | 4.0 | 43.0 | 36 | 51 | 14 | 17 | 46 | DA08LOMD | 500 | 315 | 200 |
| | 10 | 6.0 | 43.0 | 36 | 51 | 17 | 19 | 60 | DA10LOMD | 500 | 315 | 200 |
| | 12 | 8.0 | 43.0 | 36 | 51 | 19 | 22 | 75 | DA12LOMD | 400 | 315 | 200 |
| | 15 | 10.0 | 43.0 | 36 | 51 | 24 | 27 | 118 | DA15LOMD | 400 | 315 | 200 |
| | 18 | 13.0 | 43.5 | 36 | 52 | 27 | 32 | 153 | DA18LOMD | 400 | 315 | 200 |
| | 22 | 17.0 | 47.5 | 40 | 56 | 32 | 36 | 210 | DA22LOMD | 250 | 160 | 100 |
| | 28 | 22.0 | 47.5 | 40 | 57 | 41 | 41 | 279 | DA28LOMD | 250 | 160 | 100 |
| | 35 | 28.0 | 60.5 | 50 | 72 | 46 | 50 | 468 | DA35LOMD | 250 | 160 | 100 |
| | 42 | 34.0 | 71.0 | 60 | 83 | 55 | 60 | 802 | DA42LOMD | 250 | 160 | 100 |
| S ⁴⁾ | 06 | 2.5 | 43.0 | 36 | 51 | 14 | 17 | 48 | DA06SOMD | 800 | 630 | 400 |
| | 08 | 4.0 | 43.0 | 36 | 51 | 17 | 19 | 64 | DA08SOMD | 800 | 630 | 400 |
| | 10 | 6.0 | 43.5 | 36 | 52 | 19 | 22 | 81 | DA10SOMD | 800 | 630 | 400 |
| | 12 | 8.0 | 43.5 | 36 | 52 | 22 | 24 | 97 | DA12SOMD | 630 | 630 | 400 |
| | 16 | 11.0 | 48.5 | 40 | 58 | 27 | 30 | 166 | DA16SOMD | 630 | 400 | 250 |
| | 20 | 14.0 | 56.5 | 46 | 68 | 32 | 36 | 265 | DA20SOMD | 420 | 400 | 250 |
| | 25 | 18.0 | 62.0 | 50 | 74 | 41 | 46 | 466 | DA25SOMD | 420 | 400 | 250 |
| | 30 | 23.0 | 69.5 | 56 | 83 | 46 | 50 | 601 | DA30SOMD | 420 | 400 | 250 |
| | 38 | 30.0 | 76.0 | 60 | 91 | 55 | 60 | 871 | DA38SOMD | 420 | 315 | 200 |

¹⁾ Pressure shown = item deliverable

³⁾ L = light series; ⁴⁾ S = heavy series

$$\frac{\text{PN (bar)}}{10} = \text{PN (MPa)}$$
Delivery without nut and ring. Information on ordering complete fittings or alternative sealing materials see page 17.

 *Please add the **suffixes** below according to the material/surface required.

| Order code suffixes | | | |
|---------------------------------|-----------------------------|------------|---|
| Material | Suffix surface and material | Example | Standard sealing material (no additional suffix needed) |
| Steel, zinc plated, Cr(VI)-free | CF | DA16SOMDCF | NBR |
| Stainless Steel | 71 | DA16SOMD71 | VIT |
| Brass | MS | DA16SOMDMS | NBR |

RED Tube end reducer

EO 24° DKO swivel / EO 24° cone end

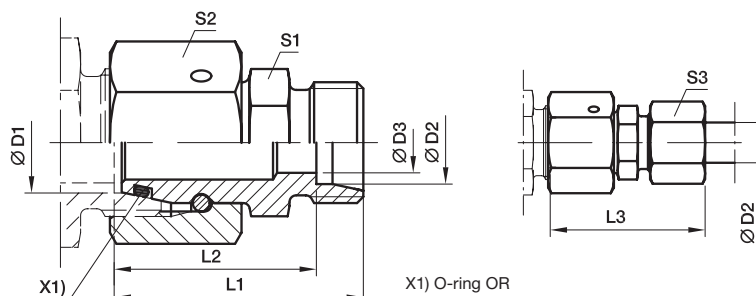

| Series 2) 3) 4) | D1 | D2 | D3 | L1 | L2 | L3 | S1 | S2 | S3 | Weight g/1 piece | Order code* | PN (bar) ¹⁾ | |
|--------------------|----|----|------|------|------|------|----|----|----|---------------------|-----------------------|------------------------|-----|
| | ⌀ | ⌀ | | | | | | | | | | CF | 71 |
| L/LL | 06 | 04 | 2.5 | 28.5 | 24.5 | 34.0 | 9 | 14 | 10 | 17 | RED06L/04LLOMD | 100 | 100 |
| L | 08 | 06 | 4.0 | 30.5 | 23.5 | 38.0 | 12 | 17 | 14 | 29 | RED08/06LOMD | 500 | 315 |
| L | 10 | 06 | 4.0 | 32.0 | 25.0 | 40.0 | 14 | 19 | 14 | 36 | RED10/06LOMD | 500 | 315 |
| L | 10 | 08 | 6.0 | 32.0 | 25.0 | 40.0 | 14 | 19 | 17 | 38 | RED10/08LOMD | 500 | 315 |
| L | 12 | 06 | 4.0 | 32.0 | 25.0 | 40.0 | 17 | 22 | 14 | 49 | RED12/06LOMD | 400 | 315 |
| L | 12 | 08 | 6.0 | 32.0 | 25.0 | 40.0 | 17 | 22 | 17 | 49 | RED12/08LOMD | 400 | 315 |
| L | 12 | 10 | 8.0 | 33.0 | 26.0 | 41.0 | 17 | 22 | 19 | 51 | RED12/10LOMD | 400 | 315 |
| L | 15 | 06 | 4.0 | 35.5 | 28.5 | 43.0 | 19 | 27 | 14 | 81 | RED15/06LOMD | 400 | 315 |
| L | 15 | 08 | 6.0 | 35.5 | 28.5 | 43.0 | 19 | 27 | 17 | 85 | RED15/08LOMD | 400 | 315 |
| L | 15 | 10 | 8.0 | 36.5 | 29.5 | 44.0 | 19 | 27 | 19 | 83 | RED15/10LOMD | 400 | 315 |
| L | 15 | 12 | 10.0 | 36.5 | 29.5 | 44.0 | 19 | 27 | 22 | 83 | RED15/12LOMD | 400 | 315 |
| L | 18 | 06 | 4.0 | 35.0 | 28.0 | 43.0 | 24 | 32 | 14 | 109 | RED18/06LOMD | 400 | 315 |
| L | 18 | 08 | 6.0 | 35.0 | 28.0 | 43.0 | 24 | 32 | 17 | 111 | RED18/08LOMD | 400 | 315 |
| L | 18 | 10 | 8.0 | 36.0 | 29.0 | 44.0 | 24 | 32 | 19 | 110 | RED18/10LOMD | 400 | 315 |
| L | 18 | 12 | 10.0 | 36.0 | 29.0 | 44.0 | 24 | 32 | 22 | 110 | RED18/12LOMD | 400 | 315 |
| L | 18 | 15 | 12.0 | 37.0 | 30.0 | 45.0 | 24 | 32 | 27 | 115 | RED18/15LOMD | 400 | 315 |
| L/S | 18 | 16 | 12.0 | 40.0 | 31.5 | 49.5 | 27 | 32 | 30 | 138 | RED18L/16SOMD | 400 | 315 |
| L | 22 | 06 | 4.0 | 39.0 | 32.0 | 47.0 | 27 | 36 | 14 | 158 | RED22/06LOMD | 250 | 160 |
| L | 22 | 08 | 6.0 | 39.0 | 32.0 | 47.0 | 27 | 36 | 17 | 158 | RED22/08LOMD | 250 | 160 |
| L | 22 | 10 | 8.0 | 40.0 | 33.0 | 48.0 | 27 | 36 | 19 | 159 | RED22/10LOMD | 250 | 160 |
| L | 22 | 12 | 10.0 | 40.0 | 33.0 | 48.0 | 27 | 36 | 22 | 157 | RED22/12LOMD | 250 | 160 |
| L | 22 | 15 | 12.0 | 41.0 | 34.0 | 49.0 | 27 | 36 | 27 | 164 | RED22/15LOMD | 250 | 160 |
| L/S | 22 | 16 | 12.0 | 43.0 | 34.5 | 52.5 | 27 | 36 | 30 | 173 | RED22L/16SOMD | 250 | 160 |
| L | 22 | 18 | 15.0 | 41.0 | 33.5 | 50.0 | 27 | 36 | 32 | 167 | RED22/18LOMD | 250 | 160 |
| L/S | 22 | 20 | 16.0 | 45.0 | 34.5 | 56.0 | 32 | 36 | 36 | 203 | RED22L/20SOMD | 250 | 160 |
| L | 28 | 06 | 4.0 | 41.0 | 34.0 | 49.0 | 32 | 41 | 14 | 219 | RED28/06LOMD | 250 | 160 |
| L | 28 | 08 | 6.0 | 41.0 | 34.0 | 49.0 | 32 | 41 | 17 | 221 | RED28/08LOMD | 250 | 160 |
| L | 28 | 10 | 8.0 | 42.0 | 35.0 | 50.0 | 32 | 41 | 19 | 213 | RED28/10LOMD | 250 | 160 |
| L | 28 | 12 | 10.0 | 42.0 | 35.0 | 50.0 | 32 | 41 | 22 | 213 | RED28/12LOMD | 250 | 160 |
| L | 28 | 15 | 12.0 | 43.0 | 36.0 | 51.0 | 32 | 41 | 27 | 218 | RED28/15LOMD | 250 | 160 |
| L/S | 28 | 16 | 12.0 | 45.0 | 36.5 | 54.5 | 32 | 41 | 30 | 227 | RED28L/16SOMD | 250 | 160 |
| L | 28 | 18 | 15.0 | 43.0 | 35.5 | 52.0 | 32 | 41 | 32 | 220 | RED28/18LOMD | 250 | 160 |
| L | 28 | 22 | 19.0 | 45.0 | 37.5 | 54.0 | 32 | 41 | 36 | 222 | RED28/22LOMD | 250 | 160 |
| L/S | 28 | 25 | 20.0 | 50.0 | 38.0 | 62.0 | 41 | 41 | 46 | 300 | RED28L/25SOMD | 250 | 160 |
| L | 35 | 06 | 4.0 | 44.0 | 37.0 | 52.0 | 41 | 50 | 14 | 318 | RED35/06LOMD | 250 | 160 |
| L | 35 | 08 | 6.0 | 44.0 | 37.0 | 52.0 | 41 | 50 | 17 | 318 | RED35/08LOMD | 250 | 160 |
| L | 35 | 10 | 8.0 | 45.0 | 38.0 | 53.0 | 41 | 50 | 19 | 318 | RED35/10LOMD | 250 | 160 |
| L | 35 | 12 | 10.0 | 45.0 | 38.0 | 53.0 | 41 | 50 | 22 | 324 | RED35/12LOMD | 250 | 160 |
| L | 35 | 15 | 12.0 | 46.0 | 39.0 | 54.0 | 41 | 50 | 27 | 328 | RED35/15LOMD | 250 | 160 |
| L | 35 | 18 | 15.0 | 46.0 | 38.5 | 55.0 | 41 | 50 | 32 | 328 | RED35/18LOMD | 250 | 160 |
| L | 35 | 22 | 19.0 | 48.0 | 40.5 | 57.0 | 41 | 50 | 36 | 331 | RED35/22LOMD | 250 | 160 |

DIN fittings

RED Tube end reducer

EO 24° DKO swivel / EO 24° cone end

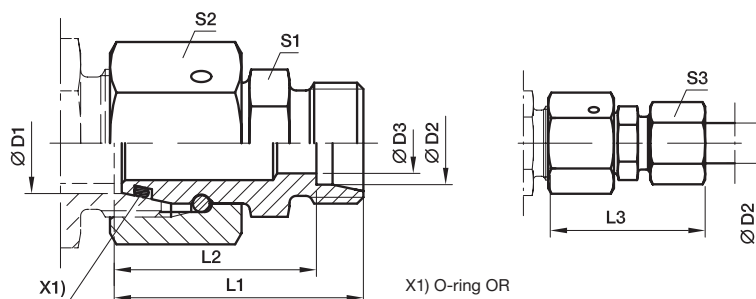

| Series ²⁾ ³⁾ ⁴⁾ | D1 | D2 | D3 | L1 | L2 | L3 | S1 | S2 | S3 | Weight g/1 piece | Order code* | PN (bar) ¹⁾ | |
|---|--------|--------|------|------|------|------|----|----|----|---------------------|----------------------|------------------------|-----|
| | | | | | | | | | | | | CF | 71 |
| L/S | 35 | 25 | 20.0 | 52.0 | 40.0 | 64.0 | 41 | 50 | 46 | 366 | RED35L/25SOMD | 250 | 160 |
| L | 35 | 28 | 24.0 | 48.0 | 40.5 | 57.0 | 41 | 50 | 41 | 327 | RED35/28LOMD | 250 | 160 |
| L/S | 35 | 30 | 25.0 | 55.0 | 41.5 | 68.0 | 46 | 50 | 50 | 435 | RED35L/30SOMD | 250 | 160 |
| L | 42 | 10 | 8.0 | 48.5 | 41.5 | 56.0 | 50 | 60 | 19 | 537 | RED42/10LOMD | 250 | 160 |
| L | 42 | 12 | 10.0 | 48.5 | 41.5 | 56.0 | 50 | 60 | 22 | 538 | RED42/12LOMD | 250 | 160 |
| L | 42 | 15 | 12.0 | 49.5 | 42.5 | 58.0 | 50 | 60 | 27 | 534 | RED42/15LOMD | 250 | 160 |
| L | 42 | 18 | 15.0 | 49.5 | 42.0 | 58.0 | 50 | 60 | 32 | 544 | RED42/18LOMD | 250 | 160 |
| L | 42 | 22 | 19.0 | 51.5 | 44.0 | 60.0 | 50 | 60 | 36 | 543 | RED42/22LOMD | 250 | 160 |
| L | 42 | 28 | 24.0 | 51.5 | 44.0 | 61.0 | 50 | 60 | 41 | 539 | RED42/28LOMD | 250 | 160 |
| L/S | 42 | 30 | 25.0 | 57.5 | 44.0 | 70.5 | 50 | 60 | 50 | 588 | RED42L/30SOMD | 250 | 160 |
| L | 42 | 35 | 30.0 | 53.5 | 43.0 | 65.0 | 50 | 60 | 50 | 541 | RED42/35LOMD | 250 | 160 |
| L/S | 42 | 38 | 32.0 | 61.5 | 45.5 | 76.0 | 55 | 60 | 60 | 701 | RED42L/38SOMD | 250 | 160 |

¹⁾ Pressure shown = item deliverable

²⁾ LL = very light series; ³⁾ L = light series; ⁴⁾ S = heavy series

$$\frac{\text{PN (bar)}}{10} = \text{PN (MPa)}$$

Delivery without nut and ring. Information on ordering complete fittings or alternative sealing materials see page I7.

 *Please add the **suffixes** below according to the material/surface required.

| Order code suffixes | | | |
|---------------------------------|-----------------------------|----------------|---|
| Material | Suffix surface and material | Example | Standard sealing material (no additional suffix needed) |
| Steel, zinc plated, Cr(VI)-free | CF | RED18/15LOMDCF | NBR |
| Stainless Steel | 71 | RED18/15LOMD71 | VIT |

RED Tube end reducer

EO 24° DKO swivel / EO 24° cone end

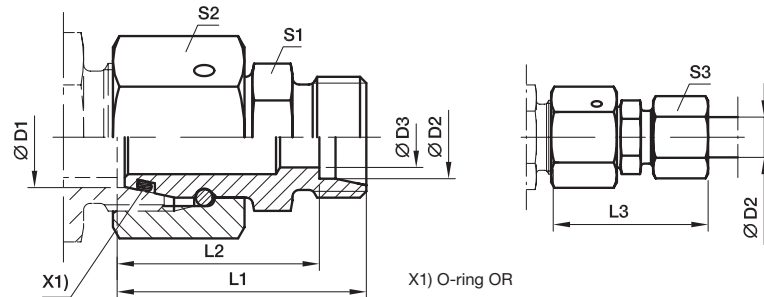

| Series 3) 4) | D1 | D2 | D3 | L1 | L2 | L3 | S1 | S2 | S3 | Weight g/1 piece | Order code* | PN (bar) ¹⁾ | |
|-----------------|--------|--------|----|------|------|----|----|----|----|---------------------|---------------|------------------------|-----|
| | | | | | | | | | | | | CF | 71 |
| S | 08 | 06 | 4 | 34.0 | 27.0 | 42 | 14 | 19 | 17 | 42 | RED08/06SOMD | 800 | 630 |
| S | 10 | 06 | 4 | 34.5 | 27.5 | 42 | 17 | 22 | 17 | 55 | RED10/06SOMD | 800 | 630 |
| S | 10 | 08 | 5 | 34.5 | 27.5 | 42 | 17 | 22 | 19 | 58 | RED10/08SOMD | 800 | 630 |
| S | 12 | 06 | 4 | 36.0 | 29.0 | 44 | 17 | 24 | 17 | 66 | RED12/06SOMD | 630 | 630 |
| S | 12 | 08 | 5 | 36.0 | 29.0 | 44 | 17 | 24 | 19 | 68 | RED12/08SOMD | 630 | 630 |
| S | 12 | 10 | 7 | 37.0 | 29.5 | 46 | 19 | 24 | 22 | 75 | RED12/10SOMD | 630 | 630 |
| S | 16 | 06 | 4 | 39.0 | 32.0 | 47 | 22 | 30 | 17 | 112 | RED16/06SOMD | 630 | 400 |
| S | 16 | 08 | 5 | 39.0 | 32.0 | 47 | 22 | 30 | 19 | 114 | RED16/08SOMD | 630 | 400 |
| S | 16 | 10 | 7 | 39.0 | 31.5 | 48 | 22 | 30 | 22 | 115 | RED16/10SOMD | 630 | 400 |
| S | 16 | 12 | 8 | 39.0 | 31.5 | 48 | 22 | 30 | 24 | 118 | RED16/12SOMD | 630 | 400 |
| S/L | 16 | 15 | 11 | 39.0 | 32.0 | 47 | 24 | 30 | 27 | 120 | RED16S/15LOMD | 400 | 315 |
| S | 20 | 06 | 4 | 43.0 | 36.0 | 51 | 27 | 36 | 17 | 172 | RED20/06SOMD | 420 | 400 |
| S | 20 | 08 | 5 | 43.0 | 36.0 | 51 | 27 | 36 | 19 | 174 | RED20/08SOMD | 420 | 400 |
| S | 20 | 10 | 7 | 43.0 | 35.5 | 52 | 27 | 36 | 22 | 174 | RED20/10SOMD | 420 | 400 |
| S | 20 | 12 | 8 | 43.0 | 35.5 | 52 | 27 | 36 | 24 | 177 | RED20/12SOMD | 420 | 400 |
| S/L | 20 | 15 | 12 | 43.0 | 36.0 | 51 | 27 | 36 | 27 | 173 | RED20S/15LOMD | 400 | 315 |
| S | 20 | 16 | 12 | 45.0 | 36.5 | 55 | 27 | 36 | 30 | 182 | RED20/16SOMD | 420 | 400 |
| S/L | 20 | 18 | 14 | 43.0 | 35.5 | 51 | 27 | 36 | 32 | 178 | RED20S/18LOMD | 400 | 315 |
| S | 25 | 06 | 4 | 45.5 | 38.5 | 53 | 32 | 46 | 17 | 294 | RED25/06SOMD | 420 | 400 |
| S | 25 | 08 | 5 | 45.5 | 38.5 | 53 | 32 | 46 | 19 | 295 | RED25/08SOMD | 420 | 400 |
| S | 25 | 10 | 7 | 45.5 | 38.0 | 54 | 32 | 46 | 22 | 296 | RED25/10SOMD | 420 | 400 |
| S | 25 | 12 | 8 | 45.5 | 38.0 | 54 | 32 | 46 | 24 | 299 | RED25/12SOMD | 420 | 400 |
| S | 25 | 16 | 12 | 47.5 | 39.0 | 57 | 32 | 46 | 30 | 304 | RED25/16SOMD | 420 | 400 |
| S/L | 25 | 18 | 15 | 45.5 | 38.0 | 54 | 32 | 46 | 32 | 299 | RED25S/18LOMD | 400 | 315 |
| S | 25 | 20 | 16 | 49.5 | 39.0 | 61 | 32 | 46 | 36 | 315 | RED25/20SOMD | 420 | 400 |
| S/L | 25 | 22 | 18 | 47.5 | 40.0 | 56 | 32 | 46 | 36 | 304 | RED25S/22LOMD | 250 | 160 |
| S | 30 | 06 | 4 | 51.0 | 44.0 | 59 | 41 | 50 | 17 | 412 | RED30/06SOMD | 420 | 400 |
| S | 30 | 08 | 5 | 51.0 | 44.0 | 59 | 41 | 50 | 19 | 404 | RED30/08SOMD | 420 | 400 |
| S | 30 | 10 | 7 | 51.0 | 43.5 | 60 | 41 | 50 | 22 | 405 | RED30/10SOMD | 420 | 400 |
| S | 30 | 12 | 8 | 51.0 | 43.5 | 60 | 41 | 50 | 24 | 405 | RED30/12SOMD | 420 | 400 |
| S | 30 | 16 | 12 | 53.0 | 44.5 | 63 | 41 | 50 | 30 | 412 | RED30/16SOMD | 420 | 400 |
| S | 30 | 20 | 16 | 55.0 | 44.5 | 66 | 41 | 50 | 36 | 421 | RED30/20SOMD | 420 | 400 |
| S/L | 30 | 22 | 19 | 53.0 | 45.5 | 61 | 41 | 50 | 36 | 406 | RED30S/22LOMD | 250 | 160 |
| S | 30 | 25 | 20 | 57.0 | 45.0 | 69 | 41 | 50 | 46 | 439 | RED30/25SOMD | 420 | 400 |
| S/L | 30 | 28 | 23 | 53.0 | 45.5 | 62 | 41 | 50 | 41 | 406 | RED30S/28LOMD | 250 | 160 |
| S | 38 | 06 | 4 | 54.5 | 47.5 | 62 | 50 | 60 | 17 | 556 | RED38/06SOMD | 420 | 315 |
| S | 38 | 08 | 5 | 54.5 | 47.5 | 62 | 50 | 60 | 19 | 581 | RED38/08SOMD | 420 | 315 |
| S | 38 | 10 | 7 | 54.5 | 47.0 | 63 | 50 | 60 | 22 | 579 | RED38/10SOMD | 420 | 315 |
| S | 38 | 12 | 8 | 54.5 | 47.0 | 63 | 50 | 60 | 24 | 577 | RED38/12SOMD | 420 | 315 |
| S | 38 | 16 | 12 | 56.5 | 48.0 | 66 | 50 | 60 | 30 | 580 | RED38/16SOMD | 420 | 315 |

DIN fittings

RED Tube end reducer

EO 24° DKO swivel / EO 24° cone end

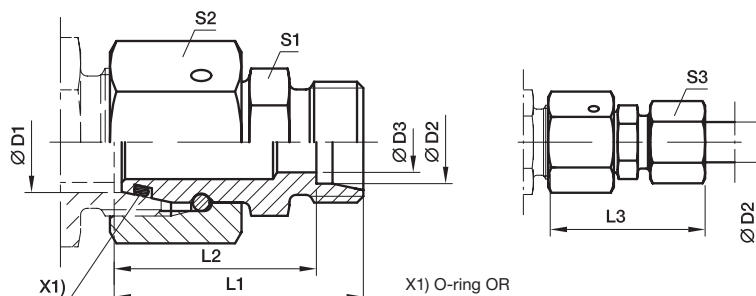

| Series 3) 4) | D1 | D2 | D3 | L1 | L2 | L3 | S1 | S2 | S3 | Weight g/1 piece | Order code* | PN (bar) ¹⁾ | |
|-----------------|----|----|----|------|------|----|----|----|----|---------------------|---------------|------------------------|-----|
| | | | | | | | | | | | | CF | 71 |
| S | 38 | 20 | 16 | 58.5 | 48.0 | 70 | 50 | 60 | 36 | 601 | RED38/20SOMD | 420 | 315 |
| S | 38 | 25 | 20 | 60.5 | 48.5 | 73 | 50 | 60 | 46 | 615 | RED38/25SOMD | 420 | 315 |
| S/L | 38 | 28 | 24 | 56.5 | 49.0 | 65 | 50 | 60 | 41 | 573 | RED38S/28LOMD | 250 | 160 |
| S | 38 | 30 | 25 | 62.5 | 49.0 | 76 | 50 | 60 | 50 | 625 | RED38/30SOMD | 420 | 315 |
| S/L | 38 | 35 | 30 | 58.5 | 48.0 | 69 | 50 | 60 | 50 | 588 | RED38S/35LOMD | 250 | 160 |

1) Pressure shown = item deliverable

3) L = light series; 4) S = heavy series

$$\frac{\text{PN (bar)}}{10} = \text{PN (MPa)}$$
Delivery without nut and ring. Information on ordering complete fittings or alternative sealing materials see page 17.

 *Please add the **suffixes** below according to the material/surface required.

| Order code suffixes | | | |
|---------------------------------|-----------------------------|----------------|---|
| Material | Suffix surface and material | Example | Standard sealing material (no additional suffix needed) |
| Steel, zinc plated, Cr(VI)-free | CF | RED16/12SOMDCF | NBR |
| Stainless Steel | 71 | RED16/12SOMD71 | VIT |

KOR Tube end reducer – Steel and Brass

EO stand pipe adjustable / EO 24° cone end

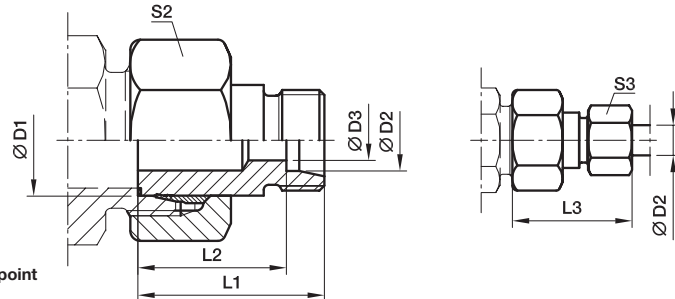

With pre-assembled nut and progressive ring for connection.
Final assembly (in appropriate body) at least 1/4 turn beyond the point of clearly perceptible resistance.

| Series 2) 3) | D1 | D2 | D3 | L1 | L2 | L3 | S2 | S3 | Weight g/1 piece | Order code* | PN (bar) ¹⁾ | |
|-----------------|----|----|------|------|------|----|----|----|---------------------|----------------|------------------------|-----|
| | ⌀ | ⌀ | | | | | | | | | CF | MS |
| LL | 06 | 04 | 3.0 | 28.5 | 24.5 | 34 | 12 | 10 | 16 | KOR06/04LLOMD | 100 | |
| LL | 08 | 04 | 3.0 | 28.5 | 24.5 | 34 | 14 | 10 | 16 | KOR08/04LLOMD | 100 | |
| LL | 08 | 06 | 4.5 | 23.0 | 17.5 | 29 | 14 | 12 | 14 | KOR08/06LLOMD | 100 | |
| L/LL | 06 | 04 | 3.0 | 28.5 | 24.5 | 34 | 14 | 10 | 16 | KOR06L/04LLOMD | 100 | |
| L/LL | 08 | 04 | 3.0 | 28.5 | 24.5 | 34 | 17 | 10 | 16 | KOR08L/04LLOMD | 100 | |
| L | 08 | 06 | 4.0 | 30.5 | 23.5 | 38 | 17 | 14 | 27 | KOR08/06LOMD | 315 | 200 |
| L/LL | 10 | 04 | 3.0 | 28.5 | 24.5 | 34 | 19 | 10 | 32 | KOR10L/04LLOMD | 100 | |
| L | 10 | 06 | 4.0 | 30.5 | 23.5 | 38 | 19 | 14 | 34 | KOR10/06LOMD | 315 | 200 |
| L | 10 | 08 | 6.0 | 30.5 | 23.5 | 38 | 19 | 17 | 35 | KOR10/08LOMD | 315 | 200 |
| L/LL | 12 | 04 | 3.0 | 28.5 | 24.5 | 34 | 22 | 10 | 41 | KOR12L/04LLOMD | 100 | |
| L | 12 | 06 | 4.0 | 30.5 | 23.5 | 38 | 22 | 14 | 45 | KOR12/06LOMD | 315 | 200 |
| L | 12 | 08 | 6.0 | 30.5 | 23.5 | 38 | 22 | 17 | 45 | KOR12/08LOMD | 315 | 200 |
| L | 12 | 10 | 8.0 | 31.5 | 24.5 | 39 | 22 | 19 | 46 | KOR12/10LOMD | 315 | 200 |
| L | 15 | 06 | 4.0 | 30.5 | 23.5 | 38 | 27 | 14 | 68 | KOR15/06LOMD | 315 | 200 |
| L | 15 | 08 | 6.0 | 30.5 | 23.5 | 38 | 27 | 17 | 69 | KOR15/08LOMD | 315 | 200 |
| L | 15 | 10 | 8.0 | 31.5 | 24.5 | 39 | 27 | 19 | 70 | KOR15/10LOMD | 315 | 200 |
| L | 15 | 12 | 10.0 | 31.5 | 24.5 | 39 | 27 | 22 | 70 | KOR15/12LOMD | 315 | 200 |
| L | 18 | 06 | 4.0 | 31.5 | 24.5 | 39 | 32 | 14 | 100 | KOR18/06LOMD | 315 | 200 |
| L | 18 | 08 | 6.0 | 31.5 | 24.5 | 39 | 32 | 17 | 102 | KOR18/08LOMD | 315 | 200 |
| L | 18 | 10 | 8.0 | 32.5 | 25.5 | 40 | 32 | 19 | 102 | KOR18/10LOMD | 315 | 200 |
| L | 18 | 12 | 10.0 | 32.5 | 25.5 | 40 | 32 | 22 | 101 | KOR18/12LOMD | 315 | 200 |
| L | 18 | 15 | 12.0 | 33.5 | 26.5 | 42 | 32 | 27 | 106 | KOR18/15LOMD | 315 | 200 |
| L | 22 | 06 | 4.0 | 32.5 | 25.5 | 40 | 36 | 14 | 137 | KOR22/06LOMD | 160 | 100 |
| L | 22 | 08 | 6.0 | 32.5 | 25.5 | 40 | 36 | 17 | 136 | KOR22/08LOMD | 160 | 100 |
| L | 22 | 10 | 8.0 | 33.5 | 26.5 | 41 | 36 | 19 | 138 | KOR22/10LOMD | 160 | 100 |
| L | 22 | 12 | 10.0 | 33.5 | 26.5 | 41 | 36 | 22 | 138 | KOR22/12LOMD | 160 | 100 |
| L | 22 | 15 | 12.0 | 34.5 | 27.5 | 43 | 36 | 27 | 143 | KOR22/15LOMD | 160 | 100 |
| L | 22 | 18 | 15.0 | 34.5 | 27.0 | 43 | 36 | 32 | 143 | KOR22/18LOMD | 160 | 100 |
| L | 28 | 06 | 4.0 | 33.5 | 26.5 | 41 | 41 | 14 | 177 | KOR28/06LOMD | 160 | 100 |
| L | 28 | 08 | 6.0 | 33.5 | 26.5 | 41 | 41 | 17 | 179 | KOR28/08LOMD | 160 | 100 |
| L | 28 | 10 | 8.0 | 34.5 | 27.5 | 42 | 41 | 19 | 180 | KOR28/10LOMD | 160 | 100 |
| L | 28 | 12 | 10.0 | 34.5 | 27.5 | 42 | 41 | 22 | 180 | KOR28/12LOMD | 160 | 100 |
| L | 28 | 15 | 12.0 | 35.5 | 28.5 | 44 | 41 | 27 | 185 | KOR28/15LOMD | 160 | 100 |
| L | 28 | 18 | 15.0 | 35.5 | 28.0 | 44 | 41 | 32 | 184 | KOR28/18LOMD | 160 | 100 |
| L | 28 | 22 | 19.0 | 37.5 | 30.0 | 46 | 41 | 36 | 188 | KOR28/22LOMD | 160 | 100 |
| L | 35 | 06 | 4.0 | 38.5 | 31.5 | 46 | 50 | 14 | 302 | KOR35/06LOMD | 160 | |
| L | 35 | 08 | 6.0 | 38.5 | 31.5 | 46 | 50 | 17 | 306 | KOR35/08LOMD | 160 | |
| L | 35 | 10 | 8.0 | 39.5 | 32.5 | 47 | 50 | 19 | 305 | KOR35/10LOMD | 160 | 100 |
| L | 35 | 12 | 10.0 | 39.5 | 32.5 | 47 | 50 | 22 | 304 | KOR35/12LOMD | 160 | 100 |
| L | 35 | 15 | 12.0 | 40.5 | 33.5 | 49 | 50 | 27 | 308 | KOR35/15LOMD | 160 | 100 |
| L | 35 | 18 | 15.0 | 40.5 | 33.0 | 49 | 50 | 32 | 316 | KOR35/18LOMD | 160 | 100 |
| L | 35 | 22 | 19.0 | 42.5 | 35.0 | 51 | 50 | 36 | 310 | KOR35/22LOMD | 160 | 100 |
| L | 35 | 28 | 24.0 | 42.5 | 35.0 | 52 | 50 | 41 | 305 | KOR35/28LOMD | 160 | 100 |

DIN fittings

KOR Tube end reducer – Steel and Brass

EO stand pipe adjustable / EO 24° cone end

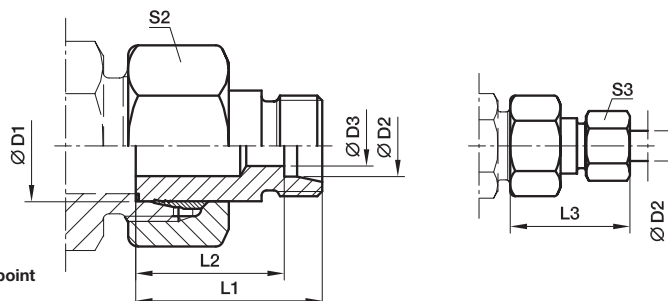

With pre-assembled nut and progressive ring for connection.
Final assembly (in appropriate body) at least 1/4 turn beyond the point of clearly perceptible resistance.

| Series 2) 3) | D1 | D2 | D3 | L1 | L2 | L3 | S2 | S3 | Weight g/1 piece | Order code* | PN (bar) ¹⁾ | |
|-----------------|--------|--------|------|------|------|----|----|----|---------------------|---------------------|------------------------|-----|
| | | | | | | | | | | | CF | MS |
| L | 42 | 10 | 8.0 | 40.5 | 33.5 | 48 | 60 | 19 | 455 | KOR42/10LOMD | 160 | |
| L | 42 | 12 | 10.0 | 40.5 | 33.5 | 48 | 60 | 22 | 438 | KOR42/12LOMD | 160 | |
| L | 42 | 15 | 12.0 | 41.5 | 34.5 | 50 | 60 | 27 | 438 | KOR42/15LOMD | 160 | 100 |
| L | 42 | 18 | 15.0 | 41.5 | 34.0 | 50 | 60 | 32 | 449 | KOR42/18LOMD | 160 | 100 |
| L | 42 | 22 | 19.0 | 43.5 | 36.0 | 52 | 60 | 36 | 461 | KOR42/22LOMD | 160 | 100 |
| L | 42 | 28 | 24.0 | 43.5 | 36.0 | 53 | 60 | 41 | 443 | KOR42/28LOMD | 160 | 100 |
| L | 42 | 35 | 30.0 | 45.5 | 35.0 | 57 | 60 | 50 | 444 | KOR42/35LOMD | 160 | 100 |

1) Pressure shown = item deliverable

2) LL = very light series; 3) L = light series

 $\frac{\text{PN (bar)}}{10} = \text{PN (MPa)}$

The use of the swivel nut fitting RED is to be preferred (see page I35).

Delivery without nut and ring. Information on ordering complete fittings see page I7.

*Please add the **suffixes** below according to the material/surface required.

| Order code suffixes | | |
|---------------------------------|-----------------------------|----------------|
| Material | Suffix surface and material | Example |
| Steel, zinc plated, Cr(VI)-free | CF | KOR18/15LOMDCF |
| Brass | MS | KOR18/15LOMDMS |



KOR Tube end reducer – Steel and Brass

EO stand pipe adjustable / EO 24° cone end

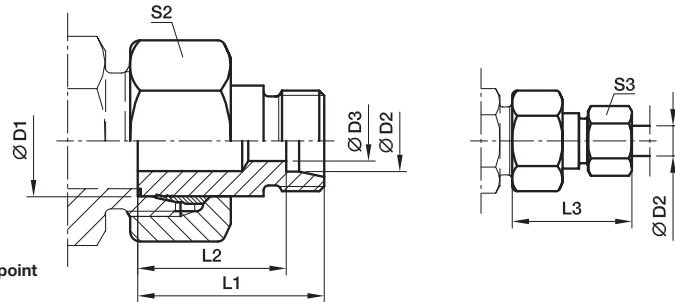

With pre-assembled nut and progressive ring for connection.
Final assembly (in appropriate body) at least 1/4 turn beyond the point of clearly perceptible resistance.

| Series | D1 ⌀ | D2 ⌀ | D3 | L1 | L2 | L3 | S2 | S3 | Weight g/1 piece | Order code* | PN (bar) ¹⁾ | |
|-----------------|---------|---------|----|----|------|----|----|----|---------------------|--------------|------------------------|-----|
| | | | | | | | | | | | CF | MS |
| S ⁴⁾ | 08 | 06 | 4 | 32 | 25.0 | 40 | 19 | 17 | 37 | KOR08/06SOMD | 630 | 400 |
| | 10 | 06 | 4 | 33 | 26.0 | 41 | 22 | 17 | 53 | KOR10/06SOMD | 630 | 400 |
| | 10 | 08 | 5 | 33 | 26.0 | 41 | 22 | 19 | 55 | KOR10/08SOMD | 630 | 400 |
| | 12 | 06 | 4 | 34 | 27.0 | 42 | 24 | 17 | 61 | KOR12/06SOMD | 630 | 400 |
| | 12 | 08 | 5 | 34 | 27.0 | 42 | 24 | 19 | 63 | KOR12/08SOMD | 630 | 400 |
| | 12 | 10 | 7 | 34 | 26.5 | 43 | 24 | 22 | 64 | KOR12/10SOMD | 630 | 400 |
| | 16 | 06 | 4 | 36 | 29.0 | 44 | 30 | 17 | 106 | KOR16/06SOMD | 400 | 250 |
| | 16 | 08 | 5 | 36 | 29.0 | 44 | 30 | 19 | 108 | KOR16/08SOMD | 400 | 250 |
| | 16 | 10 | 7 | 36 | 28.5 | 45 | 30 | 22 | 114 | KOR16/10SOMD | 400 | 250 |
| | 16 | 12 | 8 | 36 | 28.5 | 45 | 30 | 24 | 115 | KOR16/12SOMD | 400 | 250 |
| | 20 | 06 | 4 | 41 | 34.0 | 49 | 36 | 17 | 175 | KOR20/06SOMD | 400 | 250 |
| | 20 | 08 | 5 | 41 | 34.0 | 49 | 36 | 19 | 177 | KOR20/08SOMD | 400 | 250 |
| | 20 | 10 | 7 | 41 | 33.5 | 50 | 36 | 22 | 178 | KOR20/10SOMD | 400 | 250 |
| | 20 | 12 | 8 | 41 | 33.5 | 50 | 36 | 24 | 180 | KOR20/12SOMD | 400 | 250 |
| | 20 | 16 | 12 | 43 | 34.5 | 53 | 36 | 30 | 182 | KOR20/16SOMD | 400 | 250 |
| | 25 | 06 | 4 | 44 | 37.0 | 52 | 46 | 17 | 306 | KOR25/06SOMD | 400 | 250 |
| | 25 | 08 | 5 | 44 | 37.0 | 52 | 46 | 19 | 311 | KOR25/08SOMD | 400 | 250 |
| | 25 | 10 | 7 | 44 | 36.5 | 53 | 46 | 22 | 313 | KOR25/10SOMD | 400 | 250 |
| | 25 | 12 | 8 | 44 | 36.5 | 53 | 46 | 24 | 317 | KOR25/12SOMD | 400 | 250 |
| | 25 | 16 | 12 | 45 | 36.5 | 55 | 46 | 30 | 315 | KOR25/16SOMD | 400 | 250 |
| | 25 | 20 | 16 | 48 | 37.5 | 59 | 46 | 36 | 328 | KOR25/20SOMD | 400 | 250 |
| | 30 | 06 | 4 | 46 | 39.0 | 54 | 50 | 17 | 373 | KOR30/06SOMD | 400 | 250 |
| | 30 | 08 | 5 | 46 | 39.0 | 54 | 50 | 19 | 376 | KOR30/08SOMD | 400 | 250 |
| | 30 | 10 | 7 | 46 | 38.5 | 55 | 50 | 22 | 376 | KOR30/10SOMD | 400 | 250 |
| | 30 | 12 | 8 | 46 | 38.5 | 55 | 50 | 24 | 377 | KOR30/12SOMD | 400 | 250 |
| | 30 | 16 | 12 | 48 | 39.5 | 58 | 50 | 30 | 381 | KOR30/16SOMD | 400 | 250 |
| | 30 | 20 | 16 | 50 | 39.5 | 61 | 50 | 36 | 386 | KOR30/20SOMD | 400 | 250 |
| | 30 | 25 | 20 | 52 | 40.0 | 64 | 50 | 46 | 406 | KOR30/25SOMD | 400 | 250 |
| | 38 | 06 | 4 | 50 | 43.0 | 58 | 60 | 17 | 571 | KOR38/06SOMD | 315 | 200 |
| | 38 | 08 | 5 | 50 | 43.0 | 58 | 60 | 19 | 567 | KOR38/08SOMD | 315 | 200 |
| | 38 | 10 | 7 | 50 | 42.5 | 59 | 60 | 22 | 571 | KOR38/10SOMD | 315 | 200 |
| | 38 | 12 | 8 | 50 | 42.5 | 59 | 60 | 24 | 571 | KOR38/12SOMD | 315 | 200 |
| | 38 | 16 | 12 | 52 | 43.5 | 62 | 60 | 30 | 580 | KOR38/16SOMD | 315 | 200 |
| | 38 | 20 | 16 | 54 | 43.5 | 65 | 60 | 36 | 593 | KOR38/20SOMD | 315 | 200 |
| | 38 | 25 | 20 | 56 | 44.0 | 68 | 60 | 46 | 605 | KOR38/25SOMD | 315 | 200 |
| | 38 | 30 | 25 | 58 | 44.5 | 71 | 60 | 50 | 614 | KOR38/30SOMD | 315 | 200 |

1) Pressure shown = item deliverable

4) S = heavy series

PN (bar) = PN (MPa) / 10

The use of the swivel nut fitting RED is to be preferred (see page I35).

Delivery without nut and ring. Information on ordering complete fittings see page I7.

*Please add the suffixes below according to the material/surface required.

| Order code suffixes | | |
|---------------------------------|-----------------------------|----------------|
| Material | Suffix surface and material | Example |
| Steel, zinc plated, Cr(VI)-free | CF | KOR16/10SOMDCF |
| Brass | MS | KOR16/10SOMDMS |



KOR Tube end reducer – Stainless steel

EO stand pipe adjustable / EO 24° cone end

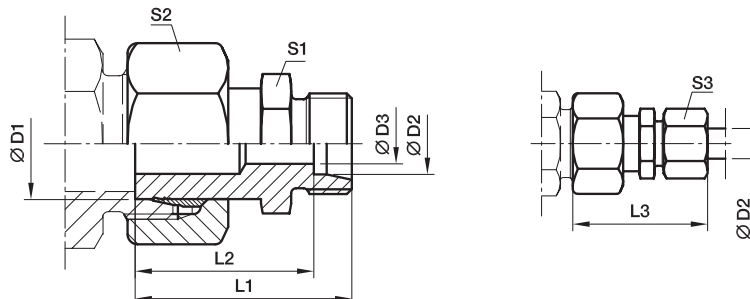

With pre-assembled nut and progressive ring for connection.
Final assembly (in appropriate body) at least 1/4 turn beyond the point of clearly perceptible resistance.

| Series | D1 | D2 | D3 | L1 | L2 | L3 | S1 | S2 | S3 | Weight g/1 piece | Order code* | PN (bar) ¹⁾ |
|-----------------|----|----|------|------|------|----|----|----|-----|---------------------|----------------|------------------------|
| | | | | | | | | | | | | 71 |
| L ³⁾ | 08 | 06 | 4 | 33.5 | 26.5 | 41 | 12 | 17 | 14 | 32 | KOR08/06LOMD71 | 315 |
| | 10 | 06 | 4 | 34.5 | 27.5 | 42 | 12 | 19 | 14 | 39 | KOR10/06LOMD71 | 315 |
| | 10 | 08 | 6 | 35.5 | 28.5 | 43 | 14 | 19 | 17 | 40 | KOR10/08LOMD71 | 315 |
| | 12 | 06 | 4 | 36.5 | 29.5 | 44 | 14 | 22 | 14 | 49 | KOR12/06LOMD71 | 315 |
| | 12 | 08 | 6 | 36.5 | 29.5 | 44 | 14 | 22 | 17 | 53 | KOR12/08LOMD71 | 315 |
| | 12 | 10 | 8 | 37.5 | 30.5 | 45 | 17 | 22 | 19 | 55 | KOR12/10LOMD71 | 315 |
| | 15 | 06 | 4 | 37.0 | 30.0 | 45 | 17 | 27 | 14 | 79 | KOR15/06LOMD71 | 315 |
| | 15 | 08 | 6 | 37.0 | 30.0 | 45 | 17 | 27 | 17 | 78 | KOR15/08LOMD71 | 315 |
| | 15 | 10 | 8 | 38.0 | 31.0 | 46 | 17 | 27 | 19 | 85 | KOR15/10LOMD71 | 315 |
| | 15 | 12 | 10 | 39.0 | 32.0 | 47 | 19 | 27 | 22 | 84 | KOR15/12LOMD71 | 315 |
| | 18 | 06 | 4 | 37.5 | 30.5 | 45 | 19 | 32 | 14 | 112 | KOR18/06LOMD71 | 315 |
| | 18 | 08 | 6 | 37.5 | 30.5 | 45 | 19 | 32 | 17 | 113 | KOR18/08LOMD71 | 315 |
| | 18 | 10 | 8 | 38.5 | 31.5 | 46 | 19 | 32 | 19 | 113 | KOR18/10LOMD71 | 315 |
| | 18 | 12 | 10 | 38.5 | 31.5 | 46 | 19 | 32 | 22 | 122 | KOR18/12LOMD71 | 315 |
| | 18 | 15 | 12 | 39.5 | 32.5 | 48 | 24 | 32 | 27 | 131 | KOR18/15LOMD71 | 315 |
| | 22 | 06 | 4 | 38.5 | 31.5 | 46 | 24 | 36 | 14 | 154 | KOR22/06LOMD71 | 160 |
| | 22 | 08 | 6 | 38.5 | 31.5 | 46 | 24 | 36 | 17 | 155 | KOR22/08LOMD71 | 160 |
| | 22 | 10 | 8 | 39.5 | 32.5 | 47 | 24 | 36 | 19 | 156 | KOR22/10LOMD71 | 160 |
| | 22 | 12 | 10 | 39.5 | 32.5 | 47 | 24 | 36 | 22 | 157 | KOR22/12LOMD71 | 160 |
| | 22 | 15 | 12 | 40.5 | 33.5 | 49 | 24 | 36 | 27 | 160 | KOR22/15LOMD71 | 160 |
| | 22 | 18 | 15 | 41.5 | 34.0 | 50 | 27 | 36 | 32 | 173 | KOR22/18LOMD71 | 160 |
| | 28 | 06 | 4 | 41.0 | 34.0 | 49 | 30 | 41 | 14 | 220 | KOR28/06LOMD71 | 160 |
| | 28 | 08 | 6 | 41.0 | 34.0 | 49 | 30 | 41 | 17 | 217 | KOR28/08LOMD71 | 160 |
| | 28 | 10 | 8 | 42.0 | 35.0 | 50 | 30 | 41 | 19 | 211 | KOR28/10LOMD71 | 160 |
| | 28 | 12 | 10 | 42.0 | 35.0 | 50 | 30 | 41 | 22 | 219 | KOR28/12LOMD71 | 160 |
| | 28 | 15 | 12 | 43.0 | 36.0 | 51 | 30 | 41 | 27 | 188 | KOR28/15LOMD71 | 160 |
| | 28 | 18 | 15 | 43.0 | 35.5 | 52 | 30 | 41 | 32 | 218 | KOR28/18LOMD71 | 160 |
| | 28 | 22 | 19 | 45.0 | 37.5 | 54 | 32 | 41 | 36 | 228 | KOR28/22LOMD71 | 160 |
| | 35 | 06 | 4 | 48.5 | 41.5 | 56 | 36 | 50 | 14 | 307 | KOR35/06LOMD71 | 160 |
| | 35 | 08 | 6 | 48.5 | 41.5 | 56 | 36 | 50 | 17 | 313 | KOR35/08LOMD71 | 160 |
| | 35 | 10 | 8 | 49.5 | 42.5 | 57 | 36 | 50 | 19 | 370 | KOR35/10LOMD71 | 160 |
| | 35 | 12 | 10 | 49.5 | 42.5 | 57 | 36 | 50 | 22 | 371 | KOR35/12LOMD71 | 160 |
| | 35 | 15 | 12 | 50.5 | 43.5 | 59 | 36 | 50 | 27 | 380 | KOR35/15LOMD71 | 160 |
| | 35 | 18 | 15 | 50.5 | 43.0 | 59 | 36 | 50 | 32 | 382 | KOR35/18LOMD71 | 160 |
| | 35 | 22 | 19 | 52.5 | 45.0 | 61 | 36 | 50 | 36 | 380 | KOR35/22LOMD71 | 160 |
| | 35 | 28 | 24 | 52.5 | 45.0 | 62 | 41 | 50 | 41 | 400 | KOR35/28LOMD71 | 160 |
| 42 | 10 | 8 | 52.5 | 45.5 | 60 | 46 | 60 | 19 | 551 | KOR42/10LOMD71 | 160 | |
| 42 | 12 | 10 | 52.5 | 45.5 | 60 | 46 | 60 | 22 | 551 | KOR42/12LOMD71 | 160 | |
| 42 | 15 | 12 | 53.5 | 46.5 | 62 | 46 | 60 | 27 | 687 | KOR42/15LOMD71 | 160 | |
| 42 | 18 | 15 | 53.5 | 46.0 | 62 | 46 | 60 | 32 | 555 | KOR42/18LOMD71 | 160 | |
| 42 | 22 | 19 | 55.5 | 48.0 | 64 | 46 | 60 | 36 | 568 | KOR42/22LOMD71 | 160 | |
| 42 | 28 | 24 | 55.5 | 48.0 | 65 | 46 | 60 | 41 | 559 | KOR42/28LOMD71 | 160 | |
| 42 | 35 | 30 | 57.5 | 47.0 | 69 | 46 | 60 | 50 | 588 | KOR42/35LOMD71 | 160 | |

¹⁾ Pressure shown = item deliverable

³⁾ L = light series

$\frac{PN \text{ (bar)}}{10} = PN \text{ (MPa)}$

The use of the swivel nut fitting RED is to be preferred (see page I35).

Delivery without nut and ring. Information on ordering complete fittings see page I7.

KOR Tube end reducer – Stainless steel

EO stand pipe adjustable / EO 24° cone end

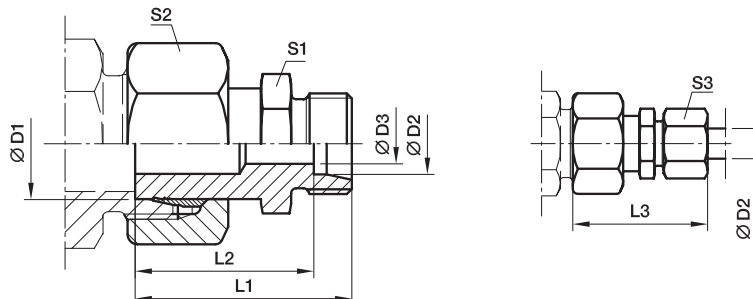

With pre-assembled nut and progressive ring for connection.
Final assembly (in appropriate body) at least 1/4 turn beyond the point of clearly perceptible resistance.

| Series | D1 | D2 | D3 | L1 | L2 | L3 | S1 | S2 | S3 | Weight g/1 piece | Order code* | PN (bar) ¹⁾ 71 |
|-----------------|----|----|------|------|------|----|----|----|-----|---------------------|----------------|------------------------------|
| S ⁴⁾ | 08 | 06 | 4 | 36.5 | 29.5 | 44 | 14 | 19 | 17 | 16 | KOR08/06SOMD71 | 630 |
| | 10 | 06 | 4 | 38.5 | 31.5 | 46 | 14 | 22 | 17 | 16 | KOR10/06SOMD71 | 630 |
| | 10 | 08 | 5 | 38.5 | 31.5 | 46 | 17 | 22 | 19 | 14 | KOR10/08SOMD71 | 630 |
| | 12 | 06 | 4 | 38.5 | 31.5 | 46 | 14 | 24 | 17 | 16 | KOR12/06SOMD71 | 630 |
| | 12 | 08 | 5 | 38.5 | 31.5 | 46 | 17 | 24 | 19 | 16 | KOR12/08SOMD71 | 630 |
| | 12 | 10 | 7 | 39.5 | 32.0 | 48 | 19 | 24 | 22 | 27 | KOR12/10SOMD71 | 630 |
| | 16 | 06 | 4 | 41.0 | 34.0 | 49 | 17 | 30 | 17 | 44 | KOR16/06SOMD71 | 400 |
| | 16 | 08 | 5 | 41.0 | 34.0 | 49 | 17 | 30 | 19 | 45 | KOR16/08SOMD71 | 400 |
| | 16 | 10 | 7 | 42.0 | 34.5 | 51 | 19 | 30 | 22 | 46 | KOR16/10SOMD71 | 400 |
| | 16 | 12 | 8 | 42.0 | 34.5 | 51 | 22 | 30 | 24 | 68 | KOR16/12SOMD71 | 400 |
| | 20 | 06 | 4 | 46.0 | 39.0 | 54 | 22 | 36 | 17 | 70 | KOR20/06SOMD71 | 400 |
| | 20 | 08 | 5 | 46.0 | 39.0 | 54 | 22 | 36 | 19 | 70 | KOR20/08SOMD71 | 400 |
| | 20 | 10 | 7 | 46.0 | 38.5 | 55 | 22 | 36 | 22 | 100 | KOR20/10SOMD71 | 400 |
| | 20 | 12 | 8 | 46.0 | 38.5 | 55 | 22 | 36 | 24 | 101 | KOR20/12SOMD71 | 400 |
| | 20 | 16 | 12 | 49.0 | 40.5 | 59 | 27 | 36 | 30 | 101 | KOR20/16SOMD71 | 400 |
| | 25 | 06 | 4 | 50.5 | 43.5 | 58 | 27 | 46 | 17 | 106 | KOR25/06SOMD71 | 400 |
| | 25 | 08 | 5 | 50.5 | 43.5 | 58 | 27 | 46 | 19 | 136 | KOR25/08SOMD71 | 400 |
| | 25 | 10 | 7 | 50.5 | 43.0 | 59 | 27 | 46 | 22 | 136 | KOR25/10SOMD71 | 400 |
| | 25 | 12 | 8 | 50.5 | 43.0 | 59 | 27 | 46 | 24 | 138 | KOR25/12SOMD71 | 400 |
| | 25 | 16 | 12 | 52.5 | 44.0 | 62 | 27 | 46 | 30 | 143 | KOR25/16SOMD71 | 400 |
| | 25 | 20 | 16 | 54.5 | 44.0 | 66 | 32 | 46 | 36 | 143 | KOR25/20SOMD71 | 400 |
| | 30 | 06 | 4 | 53.0 | 46.0 | 61 | 32 | 50 | 17 | 177 | KOR30/06SOMD71 | 400 |
| | 30 | 08 | 5 | 53.0 | 46.0 | 61 | 32 | 50 | 19 | 179 | KOR30/08SOMD71 | 400 |
| | 30 | 10 | 7 | 53.0 | 45.5 | 62 | 32 | 50 | 22 | 180 | KOR30/10SOMD71 | 400 |
| | 30 | 12 | 8 | 53.0 | 45.5 | 62 | 32 | 50 | 24 | 180 | KOR30/12SOMD71 | 400 |
| | 30 | 16 | 12 | 55.0 | 46.5 | 65 | 32 | 50 | 30 | 184 | KOR30/16SOMD71 | 400 |
| | 30 | 20 | 16 | 57.0 | 46.5 | 68 | 32 | 50 | 36 | 188 | KOR30/20SOMD71 | 400 |
| | 30 | 25 | 20 | 60.0 | 48.0 | 72 | 41 | 50 | 46 | 302 | KOR30/25SOMD71 | 400 |
| | 38 | 06 | 4 | 60.0 | 53.0 | 68 | 41 | 60 | 17 | 306 | KOR38/06SOMD71 | 315 |
| | 38 | 08 | 5 | 60.0 | 53.0 | 68 | 41 | 60 | 19 | 305 | KOR38/08SOMD71 | 315 |
| | 38 | 10 | 7 | 60.0 | 52.5 | 69 | 41 | 60 | 22 | 304 | KOR38/10SOMD71 | 315 |
| | 38 | 12 | 8 | 60.0 | 52.5 | 69 | 41 | 60 | 24 | 308 | KOR38/12SOMD71 | 315 |
| 38 | 16 | 12 | 62.0 | 53.5 | 72 | 41 | 60 | 30 | 310 | KOR38/16SOMD71 | 315 | |
| 38 | 20 | 16 | 64.0 | 53.5 | 75 | 41 | 60 | 36 | 305 | KOR38/20SOMD71 | 315 | |
| 38 | 25 | 20 | 66.0 | 54.0 | 78 | 41 | 60 | 46 | 455 | KOR38/25SOMD71 | 315 | |
| 38 | 30 | 25 | 69.0 | 55.5 | 82 | 46 | 60 | 50 | 438 | KOR38/30SOMD71 | 315 | |

1) Pressure shown = item deliverable

4) S = heavy series

$\frac{PN \text{ (bar)}}{10} = PN \text{ (MPa)}$

The use of the swivel nut fitting RED is to be preferred (see page I35).

Delivery without nut and ring. Information on ordering complete fittings see page I7.

DIN fittings

GZ Swivel union

EO 24° DKO swivel

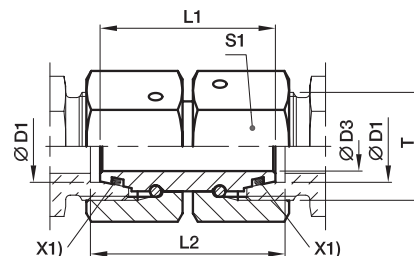

X1) O-ring OR

| Series | D1 ⊕ | T | D3 | L1 | L2 | S1 | Weight g/1 piece | Order code* | PN (bar) ¹⁾ | |
|-----------------|----------|----------|------|----|----|-----|---------------------|--------------|------------------------|-----|
| | | | | | | | | | CF | 71 |
| L ³⁾ | 06 | M 12×1.5 | 2.5 | 33 | 33 | 14 | 28 | GZ06L | 500 | 315 |
| | 08 | M 14×1.5 | 4.0 | 33 | 33 | 17 | 41 | GZ08L | 500 | 315 |
| | 10 | M 16×1.5 | 6.0 | 34 | 34 | 19 | 53 | GZ10L | 500 | 315 |
| | 12 | M 18×1.5 | 8.0 | 34 | 34 | 22 | 71 | GZ12L | 400 | 315 |
| | 15 | M 22×1.5 | 10.0 | 39 | 39 | 27 | 129 | GZ15L | 400 | 315 |
| | 18 | M 26×1.5 | 13.0 | 36 | 38 | 32 | 165 | GZ18L | 400 | 315 |
| | 22 | M 30×2.0 | 17.0 | 42 | 44 | 36 | 243 | GZ22L | 250 | 160 |
| | 28 | M 36×2.0 | 22.0 | 46 | 48 | 41 | 319 | GZ28L | 250 | 160 |
| | 35 | M 45×2.0 | 28.0 | 48 | 52 | 50 | 449 | GZ35L | 250 | 160 |
| 42 | M 52×2.0 | 34.0 | 52 | 57 | 60 | 737 | GZ42L | 250 | 160 | |
| S ⁴⁾ | 06 | M 14×1.5 | 2.5 | 32 | 33 | 17 | 41 | GZ06S | 800 | 630 |
| | 08 | M 16×1.5 | 4.0 | 33 | 34 | 19 | 54 | GZ08S | 800 | 630 |
| | 10 | M 18×1.5 | 6.0 | 33 | 35 | 22 | 74 | GZ10S | 800 | 630 |
| | 12 | M 20×1.5 | 8.0 | 36 | 38 | 24 | 95 | GZ12S | 630 | 630 |
| | 16 | M 24×1.5 | 11.0 | 39 | 42 | 30 | 172 | GZ16S | 630 | 400 |
| | 20 | M 30×2.0 | 14.0 | 44 | 48 | 36 | 261 | GZ20S | 420 | 400 |
| | 25 | M 36×2.0 | 18.0 | 46 | 53 | 46 | 477 | GZ25S | 420 | 400 |
| | 30 | M 42×2.0 | 23.0 | 52 | 62 | 50 | 605 | GZ30S | 420 | 400 |
| | 38 | M 52×2.0 | 30.0 | 52 | 67 | 60 | 826 | GZ38S | 420 | 315 |

¹⁾ Pressure shown = item deliverable

³⁾ L = light series; ⁴⁾ S = heavy series

$$\frac{\text{PN (bar)}}{10} = \text{PN (MPa)}$$

Information on ordering complete fittings or alternative sealing materials see page I7.

 *Please add the **suffixes** below according to the material/surface required.

| Order code suffixes | | | |
|---------------------------------|-----------------------------|---------|---|
| Material | Suffix surface and material | Example | Standard sealing material (no additional suffix needed) |
| Steel, zinc plated, Cr(VI)-free | CF | GZ16SCF | NBR |
| Stainless Steel | 71 | GZ16S71 | VIT |



GZR Swivel reducer

EO 24° DKO swivel

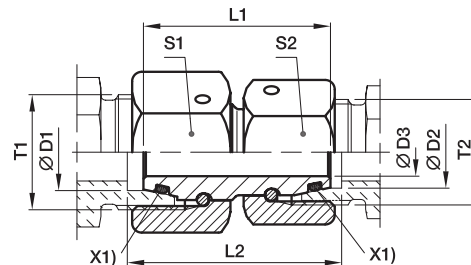

X1) O-ring OR

| Series 3) 4) | D1 | D2 | T1 | T2 | D3 | L1 | L2 | S1 | S2 | Weight g/1 piece | Order code* | PN (bar) ¹⁾ | |
|-----------------|----|----|----------|----------|------|------|------|----|----|---------------------|-------------------|---------------------------|-----|
| | | | | | | | | | | | | CF | 71 |
| L/S | 06 | 06 | M 14×1.5 | M 12×1.5 | 2.5 | 32.5 | 33.0 | 17 | 14 | 34 | GZR06L/06S | 500 | 500 |
| L | 08 | 06 | M 14×1.5 | M 12×1.5 | 2.5 | 33.0 | 33.0 | 17 | 14 | 36 | GZR08/06L | 500 | 500 |
| L/S | 08 | 08 | M 16×1.5 | M 14×1.5 | 4.0 | 32.5 | 34.0 | 19 | 17 | 48 | GZR08L/08S | 500 | 500 |
| L | 10 | 06 | M 16×1.5 | M 12×1.5 | 2.5 | 34.0 | 34.0 | 19 | 14 | 44 | GZR10/06L | 500 | 500 |
| L | 10 | 08 | M 16×1.5 | M 14×1.5 | 4.0 | 34.0 | 34.0 | 19 | 17 | 50 | GZR10/08L | 500 | 500 |
| L/S | 10 | 10 | M 18×1.5 | M 16×1.5 | 6.0 | 34.0 | 34.5 | 22 | 19 | 63 | GZR10L/10S | 500 | 500 |
| L | 12 | 06 | M 18×1.5 | M 12×1.5 | 2.5 | 34.0 | 34.0 | 22 | 14 | 56 | GZR12/06L | 400 | 400 |
| L | 12 | 08 | M 18×1.5 | M 14×1.5 | 4.0 | 34.0 | 34.0 | 22 | 17 | 62 | GZR12/08L | 400 | 400 |
| L | 12 | 10 | M 18×1.5 | M 16×1.5 | 6.0 | 34.0 | 34.0 | 22 | 19 | 65 | GZR12/10L | 400 | 400 |
| L/S | 12 | 12 | M 20×1.5 | M 18×1.5 | 8.0 | 36.5 | 37.5 | 24 | 22 | 85 | GZR12L/12S | 400 | 400 |
| L | 15 | 08 | M 22×1.5 | M 14×1.5 | 4.0 | 39.0 | 39.0 | 27 | 17 | 98 | GZR15/08L | 400 | 400 |
| L | 15 | 10 | M 22×1.5 | M 16×1.5 | 6.0 | 39.0 | 39.0 | 27 | 19 | 101 | GZR15/10L | 400 | 400 |
| L | 15 | 12 | M 22×1.5 | M 18×1.5 | 8.0 | 39.0 | 39.0 | 27 | 22 | 108 | GZR15/12L | 400 | 400 |
| L | 18 | 10 | M 26×1.5 | M 16×1.5 | 6.0 | 37.0 | 37.5 | 32 | 19 | 125 | GZR18/10L | 400 | 400 |
| L | 18 | 12 | M 26×1.5 | M 18×1.5 | 8.0 | 36.5 | 37.5 | 32 | 22 | 132 | GZR18/12L | 400 | 400 |
| L | 18 | 15 | M 26×1.5 | M 22×1.5 | 10.0 | 38.5 | 38.5 | 32 | 27 | 155 | GZR18/15L | 400 | 400 |
| L/S | 18 | 16 | M 26×1.5 | M 24×1.5 | 11.0 | 39.0 | 39.0 | 32 | 30 | 177 | GZR18L/16S | 400 | 400 |
| L | 22 | 12 | M 30×2.0 | M 18×1.5 | 8.0 | 42.5 | 43.5 | 36 | 22 | 195 | GZR22/12L | 250 | 250 |
| L | 22 | 15 | M 30×2.0 | M 22×1.5 | 10.0 | 42.5 | 43.5 | 36 | 27 | 215 | GZR22/15L | 250 | 250 |
| L | 22 | 18 | M 30×2.0 | M 26×1.5 | 13.0 | 42.0 | 44.0 | 36 | 32 | 228 | GZR22/18L | 250 | 250 |
| L/S | 22 | 20 | M 30×2.0 | M 30×2.0 | 14.0 | 44.0 | 47.0 | 36 | 36 | 266 | GZR22L/20S | 250 | 250 |
| L | 28 | 15 | M 36×2.0 | M 22×1.5 | 10.0 | 46.5 | 47.5 | 41 | 27 | 143 | GZR28/15L | 250 | 250 |
| L | 28 | 18 | M 36×2.0 | M 26×1.5 | 13.0 | 39.5 | 48.0 | 41 | 32 | 311 | GZR28/18L | 250 | 250 |
| L | 28 | 22 | M 36×2.0 | M 30×2.0 | 17.0 | 46.0 | 46.0 | 41 | 36 | 309 | GZR28/22L | 250 | 250 |
| L/S | 28 | 25 | M 36×2.0 | M 36×2.0 | 18.0 | 46.0 | 50.5 | 41 | 46 | 419 | GZR28L/25S | 250 | 250 |
| L | 35 | 18 | M 45×2.0 | M 26×1.5 | 13.0 | 48.0 | 51.0 | 50 | 32 | 430 | GZR35/18L | 250 | 250 |
| L | 35 | 22 | M 45×2.0 | M 30×2.0 | 17.0 | 48.0 | 51.0 | 50 | 36 | 429 | GZR35/22L | 250 | 250 |
| L | 35 | 28 | M 45×2.0 | M 36×2.0 | 22.0 | 48.0 | 51.0 | 50 | 41 | 415 | GZR35/28L | 250 | 250 |
| L/S | 35 | 30 | M 45×2.0 | M 42×2.0 | 23.0 | 52.0 | 59.0 | 50 | 50 | 577 | GZR35L/30S | 250 | 250 |
| L | 42 | 22 | M 52×2.0 | M 30×2.0 | 17.0 | 52.0 | 55.5 | 60 | 36 | 653 | GZR42/22L | 250 | 250 |
| L | 42 | 28 | M 52×2.0 | M 36×2.0 | 22.0 | 52.0 | 55.5 | 60 | 41 | 648 | GZR42/28L | 250 | 250 |
| L | 42 | 35 | M 52×2.0 | M 45×2.0 | 28.0 | 52.0 | 56.5 | 60 | 50 | 662 | GZR42/35L | 250 | 250 |
| L/S | 42 | 38 | M 52×2.0 | M 52×2.0 | 30.0 | 52.0 | 62.0 | 60 | 60 | 822 | GZR42L/38S | 250 | 250 |
| S | 08 | 06 | M 16×1.5 | M 14×1.5 | 2.5 | 33.0 | 34.0 | 19 | 17 | 49 | GZR08/06S | 800 | 800 |
| S | 10 | 06 | M 18×1.5 | M 14×1.5 | 2.5 | 33.0 | 34.5 | 22 | 17 | 60 | GZR10/06S | 800 | 800 |
| S | 10 | 08 | M 18×1.5 | M 16×1.5 | 4.0 | 33.0 | 34.5 | 22 | 19 | 66 | GZR10/08S | 800 | 800 |
| S | 12 | 06 | M 20×1.5 | M 14×1.5 | 2.5 | 36.0 | 37.5 | 24 | 17 | 77 | GZR12/06S | 630 | 630 |
| S | 12 | 08 | M 20×1.5 | M 16×1.5 | 4.0 | 36.0 | 37.5 | 24 | 19 | 82 | GZR12/08S | 630 | 630 |
| S | 12 | 10 | M 20×1.5 | M 18×1.5 | 6.0 | 36.0 | 38.0 | 24 | 22 | 89 | GZR12/10S | 630 | 630 |
| S | 16 | 10 | M 24×1.5 | M 18×1.5 | 6.0 | 39.0 | 41.5 | 30 | 22 | 138 | GZR16/10S | 630 | 630 |
| S | 16 | 12 | M 24×1.5 | M 20×1.5 | 8.0 | 39.0 | 41.5 | 30 | 24 | 143 | GZR16/12S | 630 | 630 |
| S/L | 16 | 15 | M 24×1.5 | M 22×1.5 | 10.0 | 39.5 | 41.5 | 30 | 27 | 153 | GZR16S/15L | 400 | 400 |
| S | 20 | 12 | M 30×2.0 | M 20×1.5 | 8.0 | 44.0 | 47.0 | 36 | 24 | 204 | GZR20/12S | 420 | 420 |

GZR Swivel reducer

EO 24° DKO swivel

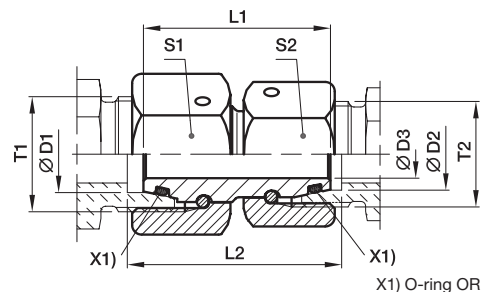

| Series 3) 4) | D1 | D2 | T1 | T2 | D3 | L1 | L2 | S1 | S2 | Weight g/1 piece | Order code* | PN (bar) ¹⁾ | |
|-----------------|----|----|----------|----------|------|----|------|----|----|---------------------|-------------------|---------------------------|-----|
| | | | | | | | | | | | | CF | 71 |
| S | 20 | 16 | M 30×2.0 | M 24×1.5 | 11.0 | 44 | 47.5 | 36 | 30 | 232 | GZR20/16S | 420 | 420 |
| S/L | 20 | 18 | M 30×2.0 | M 26×1.5 | 13.0 | 44 | 47.0 | 36 | 32 | 224 | GZR20S/18L | 400 | 400 |
| S | 25 | 16 | M 36×2.0 | M 24×1.5 | 11.0 | 46 | 51.0 | 46 | 30 | 224 | GZR25/16S | 420 | 420 |
| S | 25 | 20 | M 36×2.0 | M 30×2.0 | 14.0 | 46 | 51.5 | 46 | 36 | 364 | GZR25/20S | 420 | 420 |
| S/L | 25 | 22 | M 36×2.0 | M 30×2.0 | 17.0 | 46 | 50.5 | 46 | 36 | 475 | GZR25S/22L | 250 | 250 |
| S | 30 | 16 | M 42×2.0 | M 24×1.5 | 11.0 | 52 | 58.5 | 50 | 30 | 475 | GZR30/16S | 420 | 420 |
| S | 30 | 20 | M 42×2.0 | M 30×2.0 | 14.0 | 52 | 59.0 | 50 | 36 | 500 | GZR30/20S | 420 | 420 |
| S | 30 | 25 | M 42×2.0 | M 36×2.0 | 18.0 | 52 | 60.5 | 50 | 46 | 589 | GZR30/25S | 420 | 420 |
| S/L | 30 | 28 | M 42×2.0 | M 36×2.0 | 22.0 | 52 | 58.0 | 50 | 41 | 476 | GZR30S/28L | 250 | 250 |
| S | 38 | 20 | M 52×2.0 | M 30×2.0 | 14.0 | 52 | 61.5 | 60 | 36 | 671 | GZR38/20S | 420 | 420 |
| S | 38 | 25 | M 52×2.0 | M 36×2.0 | 18.0 | 52 | 63.0 | 60 | 46 | 759 | GZR38/25S | 420 | 420 |
| S | 38 | 30 | M 52×2.0 | M 42×2.0 | 23.0 | 52 | 64.5 | 60 | 50 | 767 | GZR38/30S | 420 | 420 |
| S/L | 38 | 35 | M 52×2.0 | M 45×2.0 | 28.0 | 52 | 61.5 | 60 | 50 | 662 | GZR38S/35L | 250 | 250 |

1) Pressure shown = item deliverable

3) L = light series; 4) S = heavy series

$$\frac{\text{PN (bar)}}{10} = \text{PN (MPa)}$$
Information on ordering complete fittings or alternative sealing materials see page 17.

| Order code suffixes | | | |
|---------------------------------|-----------------------------|-------------|---|
| Material | Suffix surface and material | Example | Standard sealing material (no additional suffix needed) |
| Steel, zinc plated, Cr(VI)-free | CF | GZR16/12SCF | NBR |
| Stainless steel | 71 | GZR16/12S71 | VIT |

 *Please add the **suffixes** below according to the material/surface required.



GEO Male stud connector

Male metric thread – O-ring (ISO 6149) / EO 24° cone end

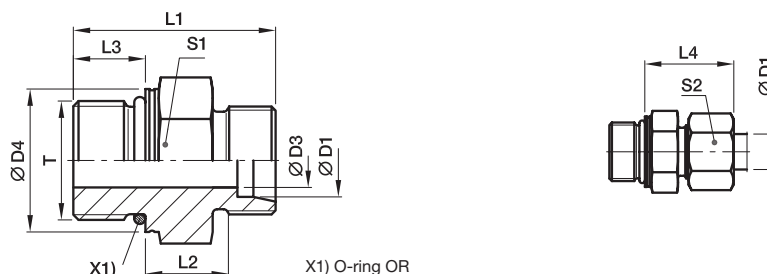

| Series | D1 | T | D3 | D4 | L1 | L2 | L3 | L4 | S1 | S2 | Weight g/1 piece | Order code* | PN (bar) ¹⁾ | |
|------------------|----------|----------|------|------|------|------|------|------|-----|-----|---------------------|-----------------|------------------------|-----|
| | | | | | | | | | | | | | CF | 71 |
| LL ²⁾ | 04 | M 08×1.0 | 3.0 | 10.8 | 20.0 | 9.5 | 6.5 | 19.0 | 11* | 10 | 8 | GEO04LLMOMD | 100 | 100 |
| | 04 | M 10×1.0 | 3.0 | 12.8 | 20.0 | 9.5 | 6.5 | 19.0 | 13 | 10 | 11 | GEO04LLM10X1OMD | 100 | |
| | 06 | M 10×1.0 | 4.5 | 12.8 | 20.0 | 8.0 | 6.5 | 19.5 | 13 | 12 | 10 | GEO06LLMOMD | 100 | |
| L ³⁾ | 06 | M 10×1.0 | 4.5 | 14.0 | 25.0 | 8.5 | 8.5 | 23.0 | 14 | 14 | 15 | GEO06LMOMD | 500 | 315 |
| | 08 | M 12×1.5 | 6.0 | 17.0 | 28.0 | 10.0 | 11.0 | 25.0 | 17 | 17 | 23 | GEO08LMOMD | 500 | 315 |
| | 10 | M 14×1.5 | 7.5 | 19.0 | 29.0 | 11.0 | 11.0 | 26.0 | 19 | 19 | 28 | GEO10LMOMD | 500 | 315 |
| | 12 | M 16×1.5 | 9.0 | 22.0 | 31.0 | 12.5 | 11.5 | 27.0 | 22 | 22 | 40 | GEO12LMOMD | 400 | 315 |
| | 15 | M 18×1.5 | 11.0 | 24.0 | 33.0 | 13.5 | 12.5 | 29.0 | 24 | 27 | 56 | GEO15LMOMD | 400 | 315 |
| | 18 | M 22×1.5 | 14.0 | 27.0 | 35.0 | 14.5 | 13.0 | 31.0 | 27 | 32 | 80 | GEO18LMOMD | 400 | 315 |
| | 22 | M 27×2.0 | 18.0 | 32.0 | 40.0 | 16.5 | 16.0 | 33.0 | 32 | 36 | 104 | GEO22LM27X2OMD | 250 | 160 |
| | 28 | M 33×2.0 | 23.0 | 41.0 | 41.0 | 17.5 | 16.0 | 34.0 | 41 | 41 | 171 | GEO28LMOMD | 250 | 160 |
| | 35 | M 42×2.0 | 30.0 | 50.0 | 44.0 | 17.5 | 16.0 | 39.0 | 50 | 50 | 278 | GEO35LMOMD | 250 | 160 |
| | 42 | M 48×2.0 | 36.0 | 55.0 | 47.5 | 19.0 | 17.5 | 42.0 | 55 | 60 | 340 | GEO42LMOMD | 250 | 160 |
| S ⁴⁾ | 06 | M 12×1.5 | 4.0 | 17.0 | 31.0 | 13.0 | 11.0 | 28.0 | 17 | 17 | 29 | GEO06SMOMD | 800 | 630 |
| | 08 | M 14×1.5 | 6.0 | 19.0 | 33.0 | 15.0 | 11.0 | 30.0 | 19 | 19 | 41 | GEO08SMOMD | 800 | 630 |
| | 10 | M 16×1.5 | 7.0 | 22.0 | 35.0 | 15.0 | 12.5 | 31.0 | 22 | 22 | 55 | GEO10SMOMD | 800 | 630 |
| | 12 | M 18×1.5 | 9.0 | 24.0 | 38.5 | 17.0 | 14.0 | 33.0 | 24 | 24 | 73 | GEO12SMOMD | 630 | 630 |
| | 16 | M 22×1.5 | 12.0 | 27.0 | 42.0 | 18.5 | 15.0 | 37.0 | 27 | 30 | 102 | GEO16SMOMD | 630 | 400 |
| | 20 | M 27×2.0 | 15.0 | 32.0 | 49.5 | 20.5 | 18.5 | 42.0 | 32 | 36 | 169 | GEO20SMOMD | 420 | 400 |
| | 25 | M 33×2.0 | 20.0 | 41.0 | 53.5 | 23.0 | 18.5 | 47.0 | 41 | 46 | 274 | GEO25SMOMD | 420 | 400 |
| | 30 | M 42×2.0 | 26.0 | 50.0 | 56.0 | 23.5 | 19.0 | 50.0 | 50 | 50 | 412 | GEO30SMOMD | 420 | 400 |
| 38 | M 48×2.0 | 32.0 | 55.0 | 63.5 | 26.0 | 21.5 | 57.0 | 55 | 60 | 580 | GEO38SMOMD | 420 | 315 | |

1) Pressure shown = item deliverable

2) LL = very light series; 3) L = light series; 4) S = heavy series

PN (bar)
10 = PN (MPa)

Delivery without nut and ring. Information on ordering complete fittings see page 17.

*S1=SW12 in 1.4571

| Order code suffixes | | | |
|---------------------------------|-----------------------------|--------------|---|
| Material | Suffix surface and material | Example | Standard sealing material (no additional suffix needed) |
| Steel, zinc plated, Cr(VI)-free | CF | GEO16SMOMDCF | NBR |
| Stainless Steel | 71 | GEO16SMOMD71 | VIT |

*Please add the suffixes below according to the material/surface required.

DIN fittings

GE-M-ED Male stud connector

Male metric thread – ED (ISO 9974) / EO 24° cone end

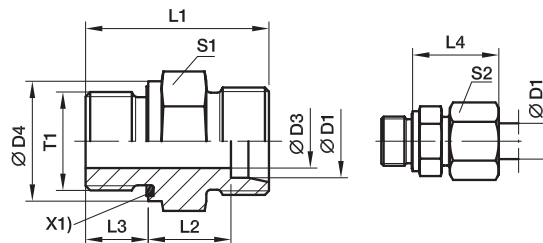

X1) Eolastic-sealing ED

| Series | D1 | T1 | D3 | D4 | L1 | L2 | L3 | L4 | S1 | S2 | Weight g/1 piece | Order code* | PN (bar) ¹⁾ | |
|-----------------|----------|----------|----|------|------|------|----|----|----|-----|---------------------|--------------------------|------------------------|-----|
| | | | | | | | | | | | | | CF | 71 |
| L ³⁾ | 06 | M 10×1.0 | 4 | 14 | 23.5 | 8.5 | 8 | 23 | 14 | 14 | 13 | GE06LMEDOMD | 500 | 315 |
| | 08 | M 12×1.5 | 6 | 17 | 29.0 | 10.0 | 12 | 25 | 17 | 17 | 22 | GE08LMEDOMD | 500 | 315 |
| | 10 | M 14×1.5 | 7 | 19 | 30.0 | 11.0 | 12 | 26 | 19 | 19 | 29 | GE10LMEDOMD | 500 | 315 |
| | 10 | M 12×1.5 | 6 | 17 | 30.0 | 11.0 | 12 | 26 | 17 | 19 | 23 | GE10LM12X1.5EDOMD | 315 | 315 |
| | 10 | M 16×1.5 | 8 | 22 | 31.5 | 12.5 | 12 | 27 | 22 | 19 | 40 | GE10LM16X1.5EDOMD | 420 | 315 |
| | 10 | M 18×1.5 | 8 | 24 | 31.5 | 12.5 | 12 | 27 | 24 | 19 | 50 | GE10LM18X1.5EDOMD | 400 | 315 |
| | 10 | M 22×1.5 | 8 | 27 | 35.0 | 14.0 | 14 | 29 | 27 | 19 | 80 | GE10LM22X1.5EDOMD | 400 | 315 |
| | 12 | M 16×1.5 | 9 | 22 | 31.5 | 12.5 | 12 | 27 | 22 | 22 | 40 | GE12LMEDOMD | 400 | 315 |
| | 12 | M 14×1.5 | 7 | 19 | 30.0 | 11.0 | 12 | 26 | 19 | 22 | 30 | GE12LM14X1.5EDOMD | 400 | 315 |
| | 12 | M 18×1.5 | 10 | 24 | 31.5 | 12.5 | 12 | 27 | 24 | 22 | 47 | GE12LM18X1.5EDOMD | 400 | 315 |
| | 12 | M 22×1.5 | 10 | 27 | 35.0 | 14.0 | 14 | 29 | 27 | 22 | 75 | GE12LM22X1.5EDOMD | 400 | 315 |
| | 15 | M 18×1.5 | 11 | 24 | 32.5 | 13.5 | 12 | 29 | 24 | 27 | 51 | GE15LMEDOMD | 400 | 315 |
| | 15 | M 16×1.5 | 9 | 22 | 32.0 | 13.0 | 12 | 28 | 24 | 27 | 64 | GE15LM16X1.5EDOMD | 400 | 315 |
| | 15 | M 22×1.5 | 12 | 27 | 36.0 | 15.0 | 14 | 30 | 27 | 27 | 77 | GE15LM22X1.5EDOMD | 400 | 315 |
| | 18 | M 22×1.5 | 14 | 27 | 36.0 | 14.5 | 14 | 31 | 27 | 32 | 74 | GE18LMEDOMD | 400 | 315 |
| | 18 | M 18×1.5 | 11 | 24 | 33.5 | 14.0 | 12 | 30 | 27 | 32 | 68 | GE18LM18X1.5EDOMD | 400 | 315 |
| | 22 | M 26×1.5 | 18 | 32 | 40.0 | 16.5 | 16 | 33 | 32 | 36 | 103 | GE22LMEDOMD | 250 | 160 |
| | 22 | M 22×1.5 | 14 | 32 | 38.0 | 16.5 | 14 | 33 | 32 | 36 | 97 | GE22LM22X1.5EDOMD | 250 | 160 |
| 28 | M 33×2.0 | 23 | 40 | 43.0 | 17.5 | 18 | 34 | 41 | 41 | 168 | GE28LMEDOMD | 250 | 160 | |
| 35 | M 42×2.0 | 30 | 50 | 48.0 | 17.5 | 20 | 39 | 50 | 50 | 281 | GE35LMEDOMD | 250 | 160 | |
| 42 | M 48×2.0 | 36 | 55 | 52.0 | 19.0 | 22 | 42 | 55 | 60 | 356 | GE42LMEDOMD | 250 | 160 | |
| S ⁴⁾ | 06 | M 12×1.5 | 4 | 17 | 32.0 | 13.0 | 12 | 28 | 17 | 17 | 30 | GE06SMEDOMD | 800 | 630 |
| | 08 | M 14×1.5 | 5 | 19 | 34.0 | 15.0 | 12 | 30 | 19 | 19 | 42 | GE08SMEDOMD | 800 | 630 |
| | 10 | M 16×1.5 | 7 | 22 | 34.5 | 15.0 | 12 | 31 | 22 | 22 | 54 | GE10SMEDOMD | 800 | 630 |
| | 12 | M 18×1.5 | 8 | 24 | 36.5 | 17.0 | 12 | 33 | 24 | 24 | 71 | GE12SMEDOMD | 630 | 630 |
| | 12 | M 14×1.5 | 5 | 19 | 36.0 | 16.5 | 12 | 33 | 22 | 24 | 60 | GE12SM14X1.5EDOMD | 630 | 630 |
| | 12 | M 22×1.5 | 8 | 27 | 39.0 | 17.5 | 14 | 34 | 27 | 24 | 102 | GE12SM22X1.5EDOMD | 630 | 400 |
| | 16 | M 22×1.5 | 12 | 27 | 41.0 | 18.5 | 14 | 37 | 27 | 30 | 95 | GE16SMEDOMD | 630 | 400 |
| | 16 | M 18×1.5 | 8 | 24 | 38.5 | 18.0 | 12 | 36 | 27 | 30 | 88 | GE16SM18X1.5EDOMD | 630 | 400 |
| | 20 | M 27×2.0 | 16 | 32 | 47.0 | 20.5 | 16 | 42 | 32 | 36 | 150 | GE20SMEDOMD | 420 | 400 |
| | 25 | M 33×2.0 | 20 | 40 | 53.0 | 23.0 | 18 | 47 | 41 | 46 | 264 | GE25SMEDOMD | 420 | 400 |
| 30 | M 42×2.0 | 25 | 50 | 57.0 | 23.5 | 20 | 50 | 50 | 50 | 422 | GE30SMEDOMD | 420 | 400 | |
| 38 | M 48×2.0 | 32 | 55 | 64.0 | 26.0 | 22 | 57 | 55 | 60 | 569 | GE38SMEDOMD | 420 | 315 | |

1) Pressure shown = item deliverable

3) L = light series; 4) S = heavy series

$$\frac{\text{PN (bar)}}{10} = \text{PN (MPa)}$$
Delivery without nut and ring. Information on ordering complete fittings or alternative sealing materials see page 17.

*Please add the below according to the material/surface required.

| Order code suffixes | | | |
|---------------------------------|-----------------------------|---------------|---|
| Material | Suffix surface and material | Example | Standard sealing material (no additional suffix needed) |
| Steel, zinc plated, Cr(VI)-free | CF | GE16SMEDOMDCF | NBR |
| Stainless Steel | 71 | GE16SMEDOMD71 | VIT |



GE-R-ED Male stud connector

Male BSPP thread – ED-seal (ISO 1179) / EO 24° cone end

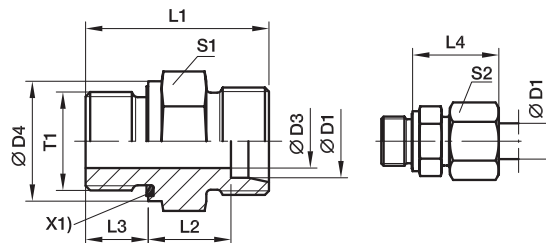

X1) Elastoc-sealing ED

| Series | D1 | T1 | D3 | D4 | L1 | L2 | L3 | L4 | S1 | S2 | Weight g/1 piece | Order code* | PN (bar) ¹⁾ | | |
|------------------|-----------|-----------|----|------|------|------|------|----|----|-----|---------------------|-----------------|------------------------|-----|-----|
| | | | | | | | | | | | | | CF | 71 | MS |
| LL ²⁾ | 04 | G 1/8 A | 3 | 14 | 20.0 | 9.5 | 6.5 | 19 | 14 | 10 | 10 | GE04LLREDOMD | 100 | 100 | 63 |
| | 06 | G 1/8 A | 4 | 14 | 20.0 | 8.0 | 6.5 | 20 | 14 | 12 | 11 | GE06LLREDOMD | 100 | 100 | 63 |
| L ³⁾ | 06 | G 1/8 A | 4 | 14 | 23.5 | 8.5 | 8.0 | 23 | 14 | 14 | 13 | GE06LREDOMD | 500 | 315 | 200 |
| | 06 | G 1/4 A | 4 | 19 | 29.0 | 10.0 | 12.0 | 25 | 19 | 14 | 28 | GE06LR1/4EDOMD | 500 | 315 | 200 |
| | 06 | G 3/8 A | 4 | 22 | 30.5 | 11.5 | 12.0 | 26 | 22 | 14 | 44 | GE06LR3/8EDOMD | 420 | 315 | 200 |
| | 06 | G 1/2 A | 4 | 27 | 33.0 | 12.0 | 14.0 | 27 | 27 | 14 | 61 | GE06LR1/2EDOMD | 400 | 315 | 200 |
| | 08 | G 1/4 A | 6 | 19 | 29.0 | 10.0 | 12.0 | 25 | 19 | 17 | 27 | GE08LREDOMD | 500 | 315 | 200 |
| | 08 | G 1/8 A | 4 | 14 | 24.5 | 9.5 | 8.0 | 24 | 14 | 17 | 16 | GE08LR1/8EDOMD | 500 | 315 | 200 |
| | 08 | G 3/8 A | 6 | 22 | 30.5 | 11.5 | 12.0 | 26 | 22 | 17 | 45 | GE08LR3/8EDOMD | 420 | 315 | 200 |
| | 08 | G 1/2 A | 6 | 27 | 33.0 | 12.0 | 14.0 | 27 | 27 | 17 | 74 | GE08LR1/2EDOMD | 400 | 315 | 200 |
| | 10 | G 1/4 A | 6 | 19 | 30.0 | 11.0 | 12.0 | 26 | 19 | 19 | 29 | GE10LREDOMD | 500 | 315 | 200 |
| | 10 | G 1/8 A | 4 | 14 | 25.5 | 10.5 | 8.0 | 25 | 17 | 19 | 21 | GE10LR1/8EDOMD | 500 | 315 | 200 |
| | 10 | G 3/8 A | 8 | 22 | 31.5 | 12.5 | 12.0 | 27 | 22 | 19 | 43 | GE10LR3/8EDOMD | 420 | 315 | 200 |
| | 10 | G 1/2 A | 8 | 27 | 34.0 | 13.0 | 14.0 | 28 | 27 | 19 | 71 | GE10LR1/2EDOMD | 400 | 315 | 200 |
| | 12 | G 3/8 A | 9 | 22 | 31.5 | 12.5 | 12.0 | 27 | 22 | 22 | 41 | GE12LREDOMD | 420 | 315 | 200 |
| | 12 | G 1/8 A | 4 | 14 | 26.5 | 11.5 | 8.0 | 26 | 19 | 22 | 26 | GE12LR1/8EDOMD | 420 | 315 | 200 |
| | 12 | G 1/4 A | 6 | 19 | 31.0 | 12.0 | 12.0 | 27 | 19 | 22 | 31 | GE12LR1/4EDOMD | 400 | 315 | 200 |
| | 12 | G 1/2 A | 10 | 27 | 34.0 | 13.0 | 14.0 | 28 | 27 | 22 | 67 | GE12LR1/2EDOMD | 400 | 315 | 200 |
| | 12 | G 3/4 A | 10 | 32 | 37.0 | 14.0 | 16.0 | 29 | 32 | 22 | 118 | GE12LR3/4EDOMD | 250 | 160 | 100 |
| | 15 | G 1/2 A | 11 | 27 | 35.0 | 14.0 | 14.0 | 29 | 27 | 27 | 72 | GE15LREDOMD | 400 | 315 | 200 |
| | 15 | G 3/8 A | 9 | 22 | 32.5 | 13.5 | 12.0 | 29 | 24 | 27 | 54 | GE15LR3/8EDOMD | 400 | 315 | 200 |
| | 15 | G 3/4 A | 12 | 32 | 38.0 | 15.0 | 16.0 | 30 | 32 | 27 | 116 | GE15LR3/4EDOMD | 250 | 160 | 100 |
| | 18 | G 1/2 A | 14 | 27 | 36.0 | 14.5 | 14.0 | 31 | 27 | 32 | 71 | GE18LREDOMD | 400 | 315 | 200 |
| | 18 | G 3/8 A | 9 | 22 | 33.5 | 14.0 | 12.0 | 30 | 27 | 32 | 66 | GE18LR3/8EDOMD | 400 | 315 | 200 |
| | 18 | G 3/4 A | 15 | 32 | 38.0 | 14.5 | 16.0 | 31 | 32 | 32 | 110 | GE18LR3/4EDOMD | 250 | 160 | 100 |
| | 22 | G 3/4 A | 18 | 32 | 40.0 | 16.5 | 16.0 | 33 | 32 | 36 | 102 | GE22LREDOMD | 250 | 160 | 100 |
| | 22 | G 1/2 A | 14 | 27 | 38.0 | 16.5 | 14.0 | 33 | 32 | 36 | 91 | GE22LR1/2EDOMD | 250 | 160 | 100 |
| | 22 | G 1 A | 19 | 40 | 43.0 | 17.5 | 18.0 | 34 | 41 | 36 | 189 | GE22LR1EDOMD | 250 | 160 | 100 |
| | 28 | G 1 A | 23 | 40 | 43.0 | 17.5 | 18.0 | 34 | 41 | 41 | 170 | GE28LREDOMD | 250 | 160 | 100 |
| | 28 | G 3/4 A | 18 | 32 | 41.0 | 17.5 | 16.0 | 34 | 41 | 41 | 159 | GE28LR3/4EDOMD | 250 | 160 | 100 |
| | 28 | G 1 1/4 A | 24 | 50 | 46.0 | 18.5 | 20.0 | 35 | 50 | 41 | 316 | GE28LR11/4EDOMD | 250 | 160 | 100 |
| | 35 | G 1 1/4 A | 30 | 50 | 48.0 | 17.5 | 20.0 | 39 | 50 | 50 | 272 | GE35LREDOMD | 250 | 160 | 100 |
| | 35 | G 1 A | 23 | 40 | 46.0 | 17.5 | 18.0 | 39 | 46 | 50 | 226 | GE35LR1EDOMD | 250 | 160 | 100 |
| | 35 | G 1 1/2 A | 30 | 55 | 52.0 | 19.5 | 22.0 | 41 | 55 | 50 | 423 | GE35LR11/2EDOMD | 250 | 160 | 100 |
| 42 | G 1 1/2 A | 36 | 55 | 52.0 | 19.0 | 22.0 | 42 | 55 | 60 | 343 | GE42LREDOMD | 250 | 160 | 100 | |
| 42 | G 1 A | 23 | 40 | 48.0 | 19.0 | 18.0 | 42 | 55 | 60 | 324 | GE42LR1EDOMD | 250 | 160 | 100 | |
| 42 | G 1 1/4 A | 30 | 50 | 50.0 | 19.0 | 20.0 | 42 | 55 | 60 | 348 | GE42LR11/4EDOMD | 250 | 160 | 100 | |

¹⁾ Pressure shown = item deliverable

²⁾ LL = very light series; ³⁾ L = light series

$$\frac{\text{PN (bar)}}{10} = \text{PN (MPa)}$$

Delivery without nut and ring. Information on ordering complete fittings or alternative sealing materials see page 17.

*Please add the **suffixes** below according to the material/surface required.

| Order code suffixes | | | |
|---------------------------------|-----------------------------|---------------|---|
| Material | Suffix surface and material | Example | Standard sealing material (no additional suffix needed) |
| Steel, zinc plated, Cr(VI)-free | CF | GE18LREDOMDCF | NBR |
| Stainless Steel | 71 | GE18LREDOMD71 | VIT |
| Brass | MS | GE18LREDOMDMS | NBR |



GE-R-ED Male stud connector

Male BSPP thread – ED-seal (ISO 1179) / EO 24° cone end

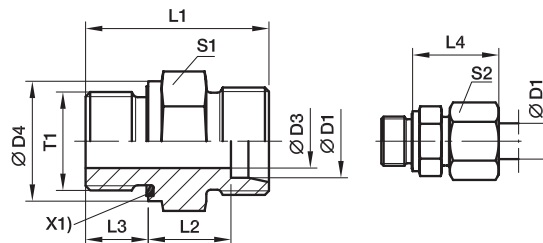

X1) Elastoc-sealing ED

| Series | D1 | T1 | D3 | D4 | L1 | L2 | L3 | L4 | S1 | S2 | Weight g/1 piece | Order code* | PN (bar) ¹⁾ | | |
|-----------------|-----------|-----------|----|------|------|------|----|----|----|-----|---------------------|-----------------|------------------------|-----|-----|
| | | | | | | | | | | | | | CF | 71 | MS |
| S ⁴⁾ | 06 | G 1/4 A | 4 | 19 | 32.0 | 13.0 | 12 | 28 | 19 | 17 | 35 | GE06SREDOMD | 800 | 630 | 400 |
| | 06 | G 1/8 A | 4 | 14 | 27.5 | 12.5 | 8 | 27 | 14 | 17 | 21 | GE06SR1/8EDOMD | 500 | 315 | |
| | 06 | G 3/8 A | 4 | 22 | 34.5 | 15.5 | 12 | 30 | 22 | 17 | 52 | GE06SR3/8EDOMD | 630 | 630 | |
| | 06 | G 1/2 A | 4 | 27 | 39.0 | 18.0 | 14 | 33 | 27 | 17 | 83 | GE06SR1/2EDOMD | 630 | 400 | |
| | 08 | G 1/4 A | 5 | 19 | 34.0 | 15.0 | 12 | 30 | 19 | 19 | 41 | GE08SREDOMD | 800 | 630 | 400 |
| | 08 | G 3/8 A | 5 | 22 | 34.5 | 15.5 | 12 | 30 | 22 | 19 | 57 | GE08SR3/8EDOMD | 800 | 630 | |
| | 08 | G 1/2 A | 5 | 27 | 39.0 | 18.0 | 14 | 33 | 27 | 19 | 89 | GE08SR1/2EDOMD | 630 | 400 | |
| | 10 | G 3/8 A | 7 | 22 | 34.5 | 15.0 | 12 | 31 | 22 | 22 | 55 | GE10SREDOMD | 800 | 630 | 400 |
| | 10 | G 1/4 A | 5 | 19 | 34.0 | 14.5 | 12 | 31 | 19 | 22 | 42 | GE10SR1/4EDOMD | 800 | 630 | |
| | 10 | G 1/2 A | 7 | 27 | 39.0 | 17.5 | 14 | 34 | 27 | 22 | 97 | GE10SR1/2EDOMD | 630 | 630 | |
| | 12 | G 3/8 A | 8 | 22 | 36.5 | 17.0 | 12 | 33 | 22 | 24 | 62 | GE12SREDOMD | 630 | 630 | 400 |
| | 12 | G 1/4 A | 5 | 19 | 36.0 | 16.5 | 12 | 33 | 22 | 24 | 61 | GE12SR1/4EDOMD | 630 | 630 | |
| | 12 | G 1/2 A | 8 | 27 | 39.0 | 17.5 | 14 | 34 | 27 | 24 | 99 | GE12SR1/2EDOMD | 630 | 630 | |
| | 16 | G 1/2 A | 12 | 27 | 41.0 | 18.5 | 14 | 37 | 27 | 30 | 91 | GE16SREDOMD | 630 | 400 | 250 |
| | 16 | G 3/8 A | 8 | 22 | 38.5 | 18.0 | 12 | 36 | 27 | 30 | 83 | GE16SR3/8EDOMD | 630 | 400 | |
| | 16 | G 3/4 A | 12 | 32 | 45.0 | 20.5 | 16 | 39 | 32 | 30 | 152 | GE16SR3/4EDOMD | 420 | 400 | |
| | 20 | G 3/4 A | 16 | 32 | 47.0 | 20.5 | 16 | 42 | 32 | 36 | 149 | GE20SREDOMD | 420 | 400 | 250 |
| | 20 | G 1/2 A | 12 | 27 | 45.0 | 20.5 | 14 | 42 | 32 | 36 | 142 | GE20SR1/2EDOMD | 420 | 400 | |
| | 20 | G 1 A | 16 | 40 | 51.0 | 22.5 | 18 | 44 | 41 | 36 | 265 | GE20SR1EDOMD | 420 | 400 | |
| | 20 | G 1 1/4 A | 16 | 50 | 53.0 | 22.5 | 20 | 44 | 50 | 36 | 404 | GE20SR11/4EDOMD | 420 | 400 | |
| | 25 | G 1 A | 20 | 40 | 53.0 | 23.0 | 18 | 47 | 41 | 46 | 266 | GE25SREDOMD | 420 | 400 | 250 |
| | 25 | G 1/2 A | 12 | 27 | 49.0 | 23.0 | 14 | 47 | 41 | 46 | 228 | GE25SR1/2EDOMD | 420 | 400 | |
| | 25 | G 3/4 A | 16 | 32 | 51.0 | 23.0 | 16 | 47 | 41 | 46 | 255 | GE25SR3/4EDOMD | 420 | 400 | |
| | 25 | G 1 1/4 A | 20 | 50 | 55.0 | 23.0 | 20 | 47 | 50 | 46 | 411 | GE25SR11/4EDOMD | 420 | 400 | |
| | 25 | G 1 1/2 A | 20 | 55 | 60.0 | 26.0 | 22 | 50 | 55 | 46 | 549 | GE25SR11/2EDOMD | 315 | 315 | |
| | 30 | G 1 1/4 A | 25 | 50 | 57.0 | 23.5 | 20 | 50 | 50 | 50 | 418 | GE30SREDOMD | 420 | 400 | 250 |
| | 30 | G 1 A | 20 | 40 | 55.0 | 23.5 | 18 | 50 | 46 | 50 | 344 | GE30SR1EDOMD | 420 | 400 | |
| | 30 | G 1 1/2 A | 25 | 55 | 62.0 | 26.5 | 22 | 53 | 55 | 50 | 530 | GE30SR11/2EDOMD | 315 | 315 | |
| 38 | G 1 1/2 A | 32 | 55 | 64.0 | 26.0 | 22 | 57 | 55 | 60 | 563 | GE38SREDOMD | 420 | 315 | 200 | |
| 38 | G 1 1/4 A | 25 | 50 | 62.0 | 26.0 | 20 | 57 | 55 | 60 | 575 | GE38SR11/4EDOMD | 420 | 315 | | |

¹⁾ Pressure shown = item deliverable

⁴⁾ S = heavy series

$$\frac{\text{PN (bar)}}{10} = \text{PN (MPa)}$$

Delivery without nut and ring. Information on ordering complete fittings or alternative sealing materials see page 17.

*Please add the suffixes below according to the material/surface required

| Order code suffixes | | | |
|---------------------------------|-----------------------------|---------------|---|
| Material | Suffix surface and material | Example | Standard sealing material (no additional suffix needed) |
| Steel, zinc plated, Cr(VI)-free | CF | GE16SREDOMDCF | NBR |
| Stainless Steel | 71 | GE16SREDOMD71 | VIT |
| Brass | MS | GE16SREDOMDMS | NBR |



GE-R Male stud connector

Male BSPP thread – metal sealing edge (ISO 1179) / EO 24° cone end

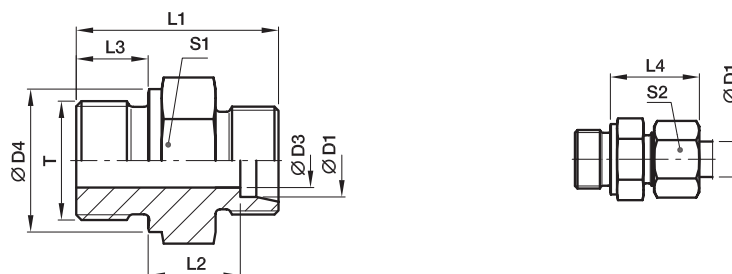

| Series | D1 | T | D3 | D4 | L1 | L2 | L3 | L4 | S1 | S2 | Weight g/1 piece | Order code* | PN (bar) ¹⁾ | | |
|-----------------|-----------|---------|----|------|------|------|------|------|----|-----|---------------------|-------------|------------------------|-----|-----|
| | | | | | | | | | | | | | CF | 71 | MS |
| L ³⁾ | 06 | G 1/8 A | 4 | 14 | 23.5 | 8.5 | 8 | 23.0 | 14 | 14 | 14 | GE06LR | 315 | 315 | 200 |
| | 06 | G 1/4 A | 4 | 18 | 29.0 | 10.0 | 12 | 25.0 | 19 | 14 | 60 | GE06LR1/4 | 315 | 315 | 200 |
| | 06 | G 3/8 A | 4 | 22 | 30.5 | 11.5 | 12 | 26.0 | 22 | 14 | 45 | GE06LR3/8 | 315 | 315 | 200 |
| | 06 | G 1/2 A | 4 | 26 | 33.0 | 12.0 | 14 | 27.0 | 27 | 14 | 60 | GE06LR1/2 | 315 | 315 | |
| | 08 | G 1/4 A | 6 | 18 | 29.0 | 10.0 | 12 | 25.0 | 19 | 17 | 26 | GE08LR | 315 | 315 | 200 |
| | 08 | G 1/8 A | 4 | 14 | 24.5 | 8.5 | 8 | 23.0 | 14 | 17 | 16 | GE08LR1/8 | 315 | 315 | |
| | 08 | G 3/8 A | 6 | 22 | 30.5 | 11.5 | 12 | 26.0 | 22 | 17 | 44 | GE08LR3/8 | 315 | 315 | 200 |
| | 08 | G 1/2 A | 6 | 26 | 33.0 | 12.0 | 14 | 27.0 | 27 | 17 | 74 | GE08LR1/2 | 315 | 315 | 200 |
| | 10 | G 1/4 A | 6 | 18 | 30.0 | 11.0 | 12 | 26.0 | 19 | 19 | 31 | GE10LR | 315 | 315 | 200 |
| | 10 | G 1/8 A | 4 | 14 | 25.5 | 10.5 | 8 | 25.0 | 17 | 19 | 21 | GE10LR1/8 | 315 | 315 | |
| | 10 | G 3/8 A | 8 | 22 | 31.5 | 12.5 | 12 | 27.0 | 22 | 19 | 44 | GE10LR3/8 | 315 | 315 | 200 |
| | 10 | G 1/2 A | 8 | 26 | 34.0 | 13.0 | 14 | 28.0 | 27 | 19 | 72 | GE10LR1/2 | 315 | 315 | 200 |
| | 12 | G 3/8 A | 9 | 22 | 31.5 | 12.5 | 12 | 27.0 | 22 | 22 | 43 | GE12LR | 315 | 315 | 200 |
| | 12 | G 1/8 A | 4 | 14 | 26.5 | 11.5 | 8 | 26.0 | 19 | 22 | 27 | GE12LR1/8 | 315 | 315 | |
| | 12 | G 1/4 A | 6 | 18 | 31.0 | 12.0 | 12 | 27.0 | 19 | 22 | 32 | GE12LR1/4 | 315 | 315 | 200 |
| | 12 | G 1/2 A | 10 | 26 | 34.0 | 13.0 | 14 | 28.0 | 27 | 22 | 67 | GE12LR1/2 | 315 | 315 | 200 |
| | 12 | G 3/4 A | 10 | 32 | 37.0 | 14.0 | 16 | 29.0 | 32 | 22 | 120 | GE12LR3/4 | 315 | 315 | |
| | 15 | G 1/2 A | 11 | 26 | 35.0 | 14.0 | 14 | 29.0 | 27 | 27 | 72 | GE15LR | 250 | 250 | 160 |
| | 15 | G 3/8 A | 9 | 22 | 32.5 | 13.5 | 12 | 29.0 | 24 | 27 | 56 | GE15LR3/8 | 250 | 250 | 160 |
| | 15 | G 3/4 A | 12 | 32 | 38.0 | 15.0 | 16 | 30.0 | 32 | 27 | 118 | GE15LR3/4 | 250 | 250 | |
| 18 | G 1/2 A | 14 | 26 | 36.0 | 14.5 | 14 | 31.0 | 27 | 32 | 72 | GE18LR | 250 | 250 | 160 | |
| 18 | G 3/8 A | 9 | 22 | 33.5 | 14.0 | 12 | 29.5 | 27 | 32 | 69 | GE18LR3/8 | 250 | 250 | | |
| 18 | G 3/4 A | 15 | 32 | 38.0 | 14.5 | 16 | 30.0 | 32 | 32 | 112 | GE18LR3/4 | 250 | 250 | | |
| 22 | G 3/4 A | 18 | 32 | 40.0 | 16.5 | 16 | 33.0 | 32 | 36 | 103 | GE22LR | 160 | 160 | 100 | |
| 22 | G 1/2 A | 14 | 26 | 38.0 | 16.5 | 14 | 33.0 | 32 | 36 | 91 | GE22LR1/2 | 160 | 160 | 100 | |
| 22 | G 1 A | 19 | 39 | 43.0 | 17.5 | 18 | 33.5 | 41 | 36 | 184 | GE22LR1 | 160 | 160 | | |
| 28 | G 1 A | 23 | 39 | 43.0 | 17.5 | 18 | 34.0 | 41 | 41 | 168 | GE28LR | 160 | 160 | 100 | |
| 28 | G 1/2 A | 14 | 26 | 39.0 | 17.5 | 14 | 34.0 | 41 | 41 | 141 | GE28LR1/2 | 160 | 160 | | |
| 28 | G 3/4 A | 18 | 32 | 41.0 | 17.5 | 16 | 34.0 | 41 | 41 | 156 | GE28LR3/4 | 160 | 160 | | |
| 28 | G 1 1/4 A | 24 | 50 | 46.0 | 18.3 | 20 | 35.0 | 50 | 41 | 314 | GE28LR11/4 | 160 | 160 | | |
| 35 | G 1 1/4 A | 30 | 49 | 48.0 | 17.5 | 20 | 39.0 | 50 | 50 | 276 | GE35LR | 160 | 160 | 100 | |
| 35 | G 1/2 A | 14 | 26 | 42.0 | 17.5 | 14 | 39.0 | 46 | 50 | 194 | GE35LR1/2 | 160 | 160 | | |
| 35 | G 3/4 A | 18 | 32 | 44.0 | 17.5 | 16 | 39.0 | 46 | 50 | 202 | GE35LR3/4 | 160 | 160 | | |
| 35 | G 1 A | 23 | 39 | 46.0 | 17.5 | 18 | 39.0 | 46 | 50 | 234 | GE35LR1 | 160 | 160 | | |
| 35 | G 1 1/2 A | 30 | 55 | 52.0 | 19.5 | 22 | 41.0 | 55 | 50 | 355 | GE35LR11/2 | 160 | 160 | | |
| 42 | G 1 1/2 A | 36 | 55 | 52.0 | 19.0 | 22 | 42.0 | 55 | 60 | 349 | GE42LR | 160 | 160 | 100 | |
| 42 | G 1 A | 23 | 39 | 48.0 | 19.0 | 18 | 42.0 | 55 | 60 | 327 | GE42LR1 | 160 | 160 | | |
| 42 | G 1 1/4 A | 30 | 49 | 50.0 | 19.0 | 20 | 42.0 | 55 | 60 | 336 | GE42LR11/4 | 160 | 160 | | |

¹⁾ Pressure shown = item deliverable

³⁾ L = light series

PN (bar) = PN (MPa)
10

Delivery without nut and ring. Information on ordering complete fittings see page I7.

*Please add the **suffixes** below according to the material/surface required.

| Order code suffixes | | |
|---------------------------------|-----------------------------|-----------|
| Material | Suffix surface and material | Example |
| Steel, zinc plated, Cr(VI)-free | CFX | GE18LRCFX |
| Stainless Steel | 71X | GE18LR71X |
| Brass | MSX | GE18LRMSX |



DIN fittings



Index

GE-R Male stud connector

Male BSPP thread – metal sealing edge (ISO 1179) / EO 24° cone end

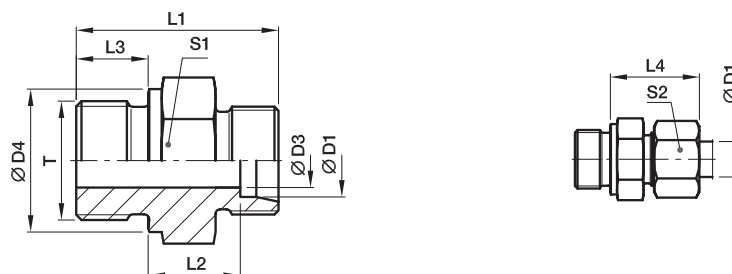

| Series | D1 | T | D3 | D4 | L1 | L2 | L3 | L4 | S1 | S2 | Weight g/1 piece | Order code* | PN (bar) ¹⁾ | | |
|-----------------|----|-----------|----|----|------|------|----|----|----|----|---------------------|-------------|------------------------|-----|-----|
| | | | | | | | | | | | | | CF | 71 | MS |
| S ⁴⁾ | 06 | G 1/4 A | 4 | 18 | 32.0 | 13.0 | 12 | 28 | 19 | 17 | 35 | GE06SR | 400 | 400 | 250 |
| | 06 | G 1/8 A | 3 | 14 | 27.5 | 12.5 | 8 | 27 | 14 | 17 | 22 | GE06SR1/8 | 400 | 400 | |
| | 06 | G 3/8 A | 4 | 22 | 34.5 | 15.5 | 12 | 30 | 22 | 17 | 57 | GE06SR3/8 | 400 | 400 | |
| | 06 | G 1/2 A | 4 | 26 | 39.0 | 18.0 | 14 | 33 | 27 | 17 | 83 | GE06SR1/2 | 400 | 400 | |
| | 08 | G 1/4 A | 5 | 18 | 34.0 | 15.0 | 12 | 30 | 19 | 19 | 41 | GE08SR | 400 | 400 | 250 |
| | 08 | G 3/8 A | 5 | 22 | 34.5 | 15.5 | 12 | 30 | 22 | 19 | 59 | GE08SR3/8 | 400 | 400 | |
| | 08 | G 1/2 A | 5 | 26 | 39.0 | 18.0 | 14 | 33 | 27 | 19 | 100 | GE08SR1/2 | 400 | 400 | |
| | 10 | G 3/8 A | 7 | 22 | 34.5 | 15.0 | 12 | 31 | 22 | 22 | 56 | GE10SR | 400 | 400 | 250 |
| | 10 | G 1/4 A | 5 | 18 | 34.0 | 14.5 | 12 | 31 | 19 | 22 | 43 | GE10SR1/4 | 400 | 400 | |
| | 10 | G 1/2 A | 7 | 26 | 39.0 | 17.5 | 14 | 34 | 27 | 22 | 97 | GE10SR1/2 | 400 | 400 | |
| | 12 | G 3/8 A | 8 | 22 | 36.5 | 17.0 | 12 | 33 | 22 | 24 | 62 | GE12SR | 400 | 400 | 250 |
| | 12 | G 1/4 A | 5 | 18 | 36.0 | 16.5 | 12 | 33 | 22 | 24 | 57 | GE12SR1/4 | 400 | 400 | |
| | 12 | G 1/2 A | 8 | 26 | 39.0 | 17.5 | 14 | 34 | 27 | 24 | 57 | GE12SR1/2 | 400 | 400 | |
| | 16 | G 1/2 A | 12 | 26 | 41.0 | 18.5 | 14 | 37 | 27 | 30 | 92 | GE16SR | 400 | 400 | 250 |
| | 16 | G 3/8 A | 8 | 22 | 38.5 | 18.0 | 12 | 36 | 27 | 30 | 83 | GE16SR3/8 | 400 | 400 | |
| | 16 | G 3/4 A | 12 | 32 | 45.0 | 20.5 | 16 | 39 | 32 | 30 | 157 | GE16SR3/4 | 400 | 400 | |
| | 20 | G 3/4 A | 16 | 32 | 47.0 | 20.5 | 16 | 42 | 32 | 36 | 151 | GE20SR | 400 | 400 | 250 |
| | 20 | G 1/2 A | 12 | 26 | 45.0 | 20.5 | 14 | 42 | 32 | 36 | 142 | GE20SR1/2 | 400 | 400 | |
| | 20 | G 1 A | 16 | 39 | 51.0 | 22.5 | 18 | 44 | 41 | 36 | 273 | GE20SR1 | 250 | 250 | |
| | 20 | G 1 1/4 A | 16 | 49 | 53.0 | 22.5 | 20 | 44 | 50 | 36 | 387 | GE20SR11/4 | 160 | 160 | |
| | 25 | G 1 A | 20 | 39 | 53.0 | 23.0 | 18 | 47 | 41 | 46 | 267 | GE25SR | 250 | 250 | 160 |
| | 25 | G 3/4 A | 16 | 32 | 51.0 | 23.0 | 16 | 47 | 41 | 46 | 245 | GE25SR3/4 | 250 | 250 | |
| | 25 | G 1 1/4 A | 20 | 49 | 55.0 | 23.0 | 20 | 47 | 50 | 46 | 422 | GE25SR11/4 | 160 | 160 | |
| | 30 | G 1 1/4 A | 25 | 49 | 57.0 | 23.5 | 20 | 50 | 50 | 50 | 422 | GE30SR | 160 | 160 | 100 |
| | 30 | G 1 A | 20 | 39 | 55.0 | 23.5 | 18 | 50 | 46 | 50 | 337 | GE30SR1 | 160 | 160 | |
| | 38 | G 1 1/2 A | 32 | 55 | 64.0 | 26.0 | 22 | 57 | 55 | 60 | 560 | GE38SR | 160 | 160 | 100 |
| | 38 | G 1 1/4 A | 25 | 49 | 62.0 | 26.0 | 20 | 57 | 55 | 60 | 578 | GE38SR11/4 | 160 | 160 | |

¹⁾ Pressure shown = item deliverable

⁴⁾ S = heavy series

$\frac{PN \text{ (bar)}}{10} = PN \text{ (MPa)}$

Delivery without nut and ring. Information on ordering complete fittings see page I7.

*Please add the **suffixes** below according to the material/surface required.

| Order code suffixes | | |
|---------------------------------|-----------------------------|-----------|
| Material | Suffix surface and material | Example |
| Steel, zinc plated, Cr(VI)-free | CFX | GE16SRCFX |
| Stainless Steel | 71X | GE16SR71X |
| Brass | MSX | GE16SRMSX |



GE-R(KEG) Male stud connector

Male short BSPT taper thread (DIN 3852-2, type C) / EO 24° cone end

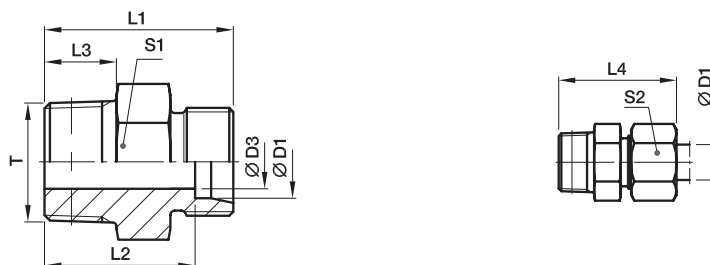

| Series | D1 | T | D3 | L1 | L2 | L3 | L4 | S1 | S2 | Weight g/1 piece | Order code* | PN (bar) ¹⁾ | | |
|------------------|--------------|--------------|------|------|------|----|----|-----|-----|---------------------|---------------|------------------------|-----|-----|
| | | | | | | | | | | | | CF | 71 | MS |
| LL ²⁾ | 04 | R 1/8 tap. | 3.0 | 20 | 16.0 | 8 | 26 | 11* | 10 | 8 | GE04LLR | 100 | 100 | 63 |
| | 06 | R 1/8 tap. | 4.5 | 20 | 14.5 | 8 | 26 | 11* | 12 | 8 | GE06LLR | 100 | 100 | 63 |
| | 08 | R 1/8 tap. | 6.0 | 22 | 16.5 | 8 | 28 | 12 | 14 | 10 | GE08LLR | 100 | 100 | 63 |
| | 08 | R 1/4 tap. | 6.0 | 26 | 20.5 | 12 | 32 | 14 | 14 | 18 | GE08LLR1/4 | 100 | 100 | 63 |
| | 10 | R 1/4 tap. | 8.0 | 26 | 20.5 | 12 | 32 | 14 | 17 | 15 | GE10LLR | 100 | | 63 |
| | 12 | R 1/4 tap. | 8.0 | 26 | 20.0 | 12 | 32 | 17 | 19 | 18 | GE12LLR | 100 | | 63 |
| | 12 | R 3/8 tap. | 10.0 | 26 | 20.0 | 12 | 32 | 17 | 19 | 23 | GE12LLR3/8 | 100 | | 63 |
| L ³⁾ | 06 | R 1/8 tap. | 4.0 | 22 | 15.0 | 8 | 30 | 12 | 14 | 11 | GE06LR1/8KEG | 315 | 315 | |
| | 06 | R 1/4 tap. | 4.0 | 27 | 20.0 | 12 | 35 | 17 | 14 | 24 | GE06LR1/4KEG | 315 | 315 | 200 |
| | 08 | R 1/8 tap. | 4.0 | 23 | 16.0 | 8 | 31 | 14 | 17 | 15 | GE08LR1/8KEG | 315 | 315 | 200 |
| | 08 | R 1/4 tap. | 6.0 | 27 | 20.0 | 12 | 35 | 17 | 17 | 22 | GE08LR1/4KEG | 315 | 315 | |
| | 10 | R 1/4 tap. | 7.0 | 28 | 21.0 | 12 | 36 | 17 | 19 | 24 | GE10LR1/4KEG | 315 | 315 | |
| | 12 | R 1/4 tap. | 7.0 | 29 | 22.0 | 12 | 37 | 19 | 22 | 53 | GE12LR1/4KEG | 315 | 315 | 200 |
| | 12 | R 3/8 tap. | 9.0 | 29 | 22.0 | 12 | 37 | 19 | 22 | 33 | GE12LR3/8KEG | 315 | 315 | |
| | 12 | R 1/2 tap. | 10.0 | 31 | 24.0 | 14 | 39 | 24 | 22 | 53 | GE12LR1/2KEG | 315 | 315 | 200 |
| | 15 | R 3/8 tap. | 9.0 | 30 | 23.0 | 12 | 38 | 24 | 27 | 49 | GE15LR3/8KEG | 315 | 315 | 200 |
| | 15 | R 1/2 tap. | 11.0 | 32 | 25.0 | 14 | 40 | 24 | 27 | 59 | GE15LR1/2KEG | 315 | 315 | |
| | 18 | R 1/2 tap. | 14.0 | 33 | 25.5 | 14 | 42 | 27 | 32 | 64 | GE18LR1/2KEG | 315 | 315 | |
| | 22 | R 3/4 tap. | 17.0 | 37 | 29.5 | 16 | 46 | 32 | 36 | 99 | GE22LR3/4KEG | 160 | 160 | |
| | 28 | R 1 tap. | 23.0 | 40 | 32.5 | 18 | 49 | 41 | 41 | 154 | GE28LR1KEG | 160 | 160 | |
| | 35 | R 1 1/4 tap. | 30.0 | 45 | 34.5 | 20 | 56 | 46 | 50 | 238 | GE35LR11/4KEG | 160 | 160 | |
| 42 | R 1 1/2 tap. | 36.0 | 49 | 38.0 | 22 | 61 | 55 | 60 | 335 | GE42LR11/2KEG | 160 | 160 | | |

¹⁾ Pressure shown = item deliverable

²⁾ LL = very light series; ³⁾ L = light series

PN (bar) = PN (MPa) / 10

Delivery without nut and ring. Information on ordering complete fittings see page 17.

^{*)} S1 = 12 for 1.4571

| Order code suffixes | | |
|---------------------------------|-----------------------------|-----------------|
| Material | Suffix surface and material | Example |
| Steel, zinc plated, Cr(VI)-free | CFX | GE06LR1/4KEGCFX |
| Stainless Steel | 71X | GE06LR1/4KEG71X |
| Brass | MSX | GE06LR1/4KEGMSX |

*Please add the suffixes below according to the material/surface required.

DIN fittings

GE-M Male stud connector

Male metric thread – metal sealing edge (ISO 9974) / EO 24° cone end

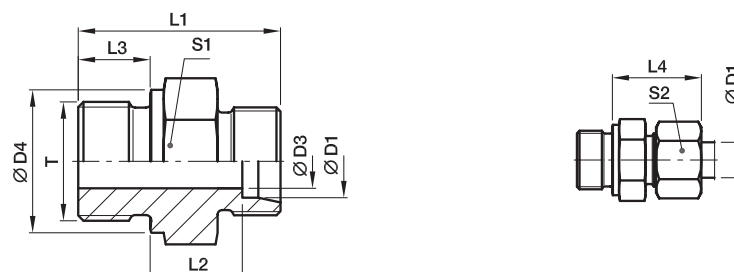

| Series | D1 | T | D3 | D4 | L1 | L2 | L3 | L4 | S1 | S2 | Weight g/1 piece | Order code* | PN (bar) ¹⁾ | | |
|-----------------|----------|----------|----|------|------|------|----|----|----|-----|---------------------|---------------------|------------------------|-----|-----|
| | | | | | | | | | | | | | CF | 71 | MS |
| L ³⁾ | 06 | M 10×1.0 | 4 | 14 | 23.5 | 8.5 | 8 | 23 | 14 | 14 | 13 | GE06LM | 315 | 315 | 200 |
| | 08 | M 12×1.5 | 6 | 17 | 29.0 | 10.0 | 12 | 25 | 17 | 17 | 22 | GE08LM | 315 | 315 | 200 |
| | 10 | M 14×1.5 | 7 | 19 | 30.0 | 11.0 | 12 | 26 | 19 | 19 | 31 | GE10LM | 315 | 315 | 200 |
| | 10 | M 10×1.0 | 4 | 14 | 25.5 | 10.5 | 8 | 25 | 17 | 19 | 20 | GE10LM10X1 | 315 | 315 | |
| | 10 | M 12×1.5 | 6 | 17 | 30.0 | 11.0 | 12 | 26 | 17 | 19 | 25 | GE10LM12X1.5 | 315 | 315 | |
| | 10 | M 16×1.5 | 8 | 21 | 31.5 | 12.0 | 12 | 27 | 22 | 19 | 41 | GE10LM16X1.5 | 315 | 315 | |
| | 10 | M 18×1.5 | 8 | 23 | 31.5 | 12.5 | 12 | 27 | 24 | 19 | 50 | GE10LM18X1.5 | 315 | 315 | |
| | 10 | M 22×1.5 | 8 | 27 | 35.0 | 14.0 | 14 | 29 | 27 | 19 | 72 | GE10LM22X1.5 | 315 | 315 | |
| | 12 | M 14×1.5 | 7 | 19 | 30.0 | 11.0 | 12 | 26 | 19 | 22 | 30 | GE12LM14X1.5 | 315 | 315 | |
| | 12 | M 16×1.5 | 9 | 21 | 31.5 | 12.5 | 12 | 27 | 22 | 22 | 40 | GE12LM | 315 | 315 | |
| | 12 | M 18×1.5 | 10 | 23 | 31.5 | 12.5 | 12 | 27 | 24 | 22 | 47 | GE12LM18X1.5 | 315 | 315 | |
| | 12 | M 22×1.5 | 10 | 27 | 35.0 | 14.0 | 14 | 29 | 27 | 22 | 76 | GE12LM22X1.5 | 315 | 315 | |
| | 15 | M 16×1.5 | 9 | 21 | 32.0 | 13.0 | 12 | 28 | 24 | 27 | 50 | GE15LM16X1.5 | 250 | 250 | |
| | 15 | M 18×1.5 | 11 | 23 | 32.5 | 13.5 | 12 | 29 | 24 | 27 | 52 | GE15LM | 250 | 250 | 160 |
| | 15 | M 22×1.5 | 12 | 27 | 36.0 | 15.0 | 14 | 30 | 27 | 27 | 77 | GE15LM22X1.5 | 250 | 250 | |
| | 18 | M 18×1.5 | 11 | 23 | 33.5 | 14.0 | 12 | 30 | 27 | 32 | 68 | GE18LM18X1.5 | 250 | 250 | |
| | 18 | M 22×1.5 | 14 | 27 | 36.0 | 14.5 | 14 | 31 | 27 | 32 | 77 | GE18LM | 250 | 250 | 160 |
| | 22 | M 22×1.5 | 14 | 27 | 38.0 | 16.5 | 14 | 33 | 32 | 36 | 92 | GE22LM22X1.5 | 160 | 160 | |
| | 22 | M 26×1.5 | 18 | 31 | 40.0 | 16.5 | 16 | 33 | 32 | 36 | 102 | GE22LM | 160 | 160 | 100 |
| | 28 | M 33×2.0 | 23 | 39 | 43.0 | 17.5 | 18 | 34 | 41 | 41 | 168 | GE28LM | 160 | 160 | 100 |
| 35 | M 42×2.0 | 30 | 49 | 48.0 | 17.5 | 20 | 39 | 50 | 50 | 280 | GE35LM | 160 | 160 | 100 | |
| 42 | M 48×2.0 | 36 | 55 | 52.0 | 19.0 | 22 | 42 | 55 | 60 | 354 | GE42LM | 160 | 160 | 100 | |
| S ⁴⁾ | 06 | M 12×1.5 | 4 | 17 | 32.0 | 13.0 | 12 | 28 | 17 | 17 | 30 | GE06SM | 400 | 400 | 250 |
| | 06 | M 14×1.5 | 4 | 19 | 34.0 | 15.0 | 12 | 30 | 19 | 17 | 42 | GE06SM14X1.5 | 400 | 400 | |
| | 08 | M 14×1.5 | 5 | 19 | 34.0 | 15.0 | 12 | 30 | 19 | 19 | 43 | GE08SM | 400 | 400 | 250 |
| | 10 | M 16×1.5 | 7 | 21 | 34.5 | 15.0 | 12 | 31 | 22 | 22 | 54 | GE10SM | 400 | 400 | 250 |
| | 12 | M 18×1.5 | 8 | 23 | 36.5 | 17.0 | 12 | 33 | 24 | 24 | 72 | GE12SM | 400 | 400 | 250 |
| | 12 | M 14×1.5 | 5 | 19 | 36.0 | 16.5 | 12 | 33 | 22 | 24 | 60 | GE12SM14X1.5 | 400 | 400 | |
| | 12 | M 22×1.5 | 8 | 27 | 39.0 | 17.5 | 14 | 34 | 27 | 24 | 103 | GE12SM22X1.5 | 400 | 400 | |
| | 16 | M 18×1.5 | 8 | 23 | 38.5 | 18.0 | 12 | 36 | 27 | 30 | 88 | GE16SM18X1.5 | 400 | 400 | |
| | 16 | M 22×1.5 | 12 | 27 | 41.0 | 18.5 | 14 | 37 | 27 | 30 | 97 | GE16SM | 400 | 400 | 250 |
| | 20 | M 27×2.0 | 16 | 32 | 47.0 | 20.5 | 16 | 42 | 32 | 36 | 155 | GE20SM | 400 | 400 | 250 |
| | 25 | M 33×2.0 | 20 | 39 | 53.0 | 23.0 | 18 | 47 | 41 | 46 | 268 | GE25SM | 250 | 250 | 160 |
| | 30 | M 42×2.0 | 25 | 49 | 57.0 | 23.5 | 20 | 50 | 50 | 50 | 421 | GE30SM | 160 | 160 | 100 |
| | 38 | M 48×2.0 | 32 | 55 | 64.0 | 26.0 | 22 | 57 | 55 | 60 | 568 | GE38SM | 160 | 160 | 100 |

1) Pressure shown = item deliverable

3) L = light series; 4) S = heavy series

$$\frac{\text{PN (bar)}}{10} = \text{PN (MPa)}$$
Delivery without nut and ring. Information on ordering complete fittings see page 17.

 *Please add the **suffixes** below according to the material/surface required.

| Order code suffixes | | |
|---------------------------------|-----------------------------|-----------|
| Material | Suffix surface and material | Example |
| Steel, zinc plated, Cr(VI)-free | CFX | GE16SMCFX |
| Stainless Steel | 71X | GE16SM71X |
| Brass | MSX | GE16SMMSX |



GE-M(KEG) Male stud connector

Male short metric taper thread (DIN 3852-1, type C) / EO 24° cone end

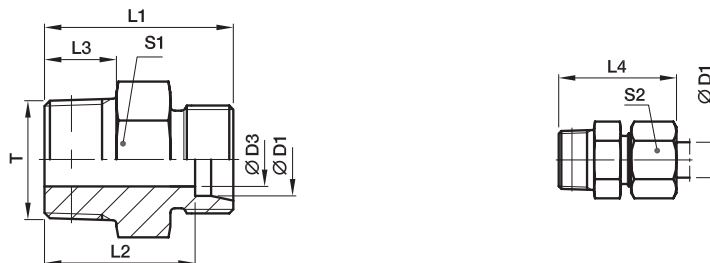

| Series | D1 | T | D3 | L1 | L2 | L3 | L4 | S1 | S2 | Weight g/1 piece | Order code* | PN (bar) ¹⁾ | | |
|------------------|----|---------------|-----|----|------|----|----|-----|----|---------------------|----------------------|------------------------|-----|----|
| | | | | | | | | | | | | CF | 71 | MS |
| LL ²⁾ | 04 | M 06×1.0 tap. | 2.0 | 20 | 16.0 | 8 | 26 | 9* | 10 | 5 | GE04LLM6X1KEG | 100 | | |
| | 04 | M 08×1.0 tap. | 3.0 | 20 | 16.0 | 8 | 26 | 10* | 10 | 7 | GE04LLM | 100 | 100 | 63 |
| | 06 | M 10×1.0 tap. | 4.5 | 20 | 14.5 | 8 | 26 | 11* | 12 | 9 | GE06LLM | 100 | 100 | 63 |
| | 06 | M 08×1.0 tap. | 3.5 | 20 | 14.5 | 8 | 26 | 11* | 12 | 9 | GE06LLM8X1KEG | 100 | | |
| | 08 | M 10×1.0 tap. | 6.0 | 22 | 16.5 | 8 | 28 | 12* | 14 | 10 | GE08LLM | 100 | 100 | 63 |

¹⁾ Pressure shown = item deliverable

²⁾ LL = very light series

$\frac{PN \text{ (bar)}}{10} = PN \text{ (MPa)}$

Delivery without nut and ring. Information on ordering complete fittings see page 17.

*S1=SW12 in 1.4571

| Order code suffixes | | |
|---------------------------------|-----------------------------|------------|
| Material | Suffix surface and material | Example |
| Steel, zinc plated, Cr(VI)-free | CFX | GE06LLMCFX |
| Stainless Steel | 71X | GE06LLM71X |
| Brass | MSX | GE06LLMMSX |

*Please add the **suffixes** below according to the material/surface required.

DIN fittings

GE-UNF/UN Male stud connector

Male UNF/UN thread – O-ring (ISO 11926) / EO 24° cone end

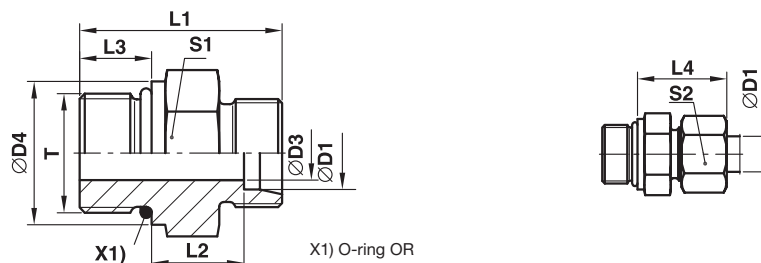

| Series | D1 | T | D3 | D4 | L1 | L2 | L3 | L4 | S1 | S2 | Weight g/1 piece | Order code* | PN (bar) ¹⁾ | |
|-----------------|---------------|----------------|------|------|------|------|------|----|----|-----|---------------------|-----------------|------------------------|-----|
| | | | | | | | | | | | | | CF | 71 |
| L ³⁾ | 08 | 7/16-20UNF-2A | 5.0 | – | 26 | 10.0 | 9.0 | 25 | 17 | 17 | 21 | GE08L7/16UNFOMD | 315 | 315 |
| | 10 | 7/16-20UNF-2A | 5.0 | – | 27 | 11.0 | 9.0 | 26 | 17 | 19 | 23 | GE10L7/16UNFOMD | 315 | 315 |
| | 12 | 9/16-18UNF-2A | 7.0 | – | 28 | 11.0 | 10.0 | 26 | 19 | 22 | 32 | GE12L9/16UNFOMD | 315 | 315 |
| | 12 | 3/4-16UNF-2A | 10.0 | – | 31 | 13.0 | 11.0 | 28 | 24 | 22 | 52 | GE12L3/4UNFOMD | 315 | 315 |
| | 12 | 7/8-14UNF-2A | 10.0 | – | 34 | 14.3 | 12.7 | 29 | 27 | 22 | 77 | GE12L7/8UNFOMD | 315 | 315 |
| | 15 | 3/4-16UNF-2A | 11.0 | – | 32 | 14.0 | 11.0 | 29 | 24 | 27 | 57 | GE15L3/4UNFOMD | 315 | 315 |
| | 15 | 7/8-14UNF-2A | 12.0 | – | 35 | 15.3 | 12.7 | 30 | 27 | 27 | 81 | GE15L7/8UNFOMD | 315 | 315 |
| | 18 | 3/4-16UNF-2A | 11.0 | 23.9 | 33 | 14.5 | 11.0 | 31 | 27 | 32 | 68 | GE18L3/4UNFOMD | 315 | 315 |
| | 18 | 7/8-14UNF-2A | 14.0 | – | 35 | 14.8 | 12.7 | 31 | 27 | 32 | 72 | GE18L7/8UNFOMD | 315 | 315 |
| | 22 | 7/8-14UNF-2A | 14.0 | 26.9 | 37 | 16.8 | 12.7 | 33 | 32 | 36 | 94 | GE22L7/8UNFOMD | 160 | 160 |
| | 22 | 1 1/16-12UN-2A | 18.0 | – | 39 | 16.5 | 15.0 | 33 | 32 | 36 | 103 | GE22L11/16UNOMD | 160 | 160 |
| | 22 | 1 5/16-12UN-2A | 19.0 | – | 40 | 17.5 | 15.0 | 34 | 41 | 36 | 163 | GE22L15/16UNOMD | 160 | 160 |
| | 28 | 1 1/16-12UN-2A | 18.0 | 33.3 | 40 | 17.5 | 15.0 | 34 | 41 | 41 | 152 | GE28L11/16UNOMD | 160 | 160 |
| | 28 | 1 5/16-12UN-2A | 23.0 | – | 40 | 17.5 | 15.0 | 34 | 41 | 41 | 163 | GE28L15/16UNOMD | 160 | 160 |
| | 35 | 1 5/16-12UN-2A | 23.0 | 39.6 | 43 | 17.5 | 15.0 | 39 | 46 | 50 | 222 | GE35L15/16UNOMD | 160 | 160 |
| | 35 | 1 5/8-12UN-2A | 29.0 | – | 43 | 17.5 | 15.0 | 39 | 50 | 50 | 257 | GE35L15/8UNOMD | 160 | 160 |
| 42 | 1 5/8-12UN-2A | 29.0 | 47.7 | 45 | 19.0 | 15.0 | 42 | 55 | 60 | 339 | GE42L15/8UNOMD | 160 | 160 | |
| S ⁴⁾ | 08 | 7/16-20UNF-2A | 4.0 | – | 31 | 13.0 | 11.0 | 30 | 17 | 19 | 33 | GE08S7/16UNFOMD | 630 | 630 |
| | 10 | 9/16-18UNF-2A | 6.0 | – | 32 | 12.5 | 12.0 | 31 | 19 | 22 | 42 | GE10S9/16UNFOMD | 630 | 630 |
| | 12 | 9/16-18UNF-2A | 6.0 | 19.0 | 32 | 12.5 | 12.0 | 31 | 22 | 24 | 50 | GE12S9/16UNFOMD | 630 | 630 |
| | 12 | 3/4-16UNF-2A | 8.0 | – | 36 | 14.5 | 14.0 | 34 | 24 | 24 | 73 | GE12S3/4UNFOMD | 630 | 630 |
| | 16 | 3/4-16UNF-2A | 10.0 | – | 35 | 12.5 | 14.0 | 34 | 24 | 30 | 90 | GE16S3/4UNFOMD | 400 | 400 |
| | 16 | 7/8-14UNF-2A | 12.0 | – | 40 | 15.5 | 16.0 | 37 | 27 | 30 | 95 | GE16S7/8UNFOMD | 400 | 400 |
| | 20 | 3/4-16UNF-2A | 10.0 | 23.9 | 42 | 17.5 | 14.0 | 42 | 32 | 36 | 132 | GE20S3/4UNFOMD | 400 | 400 |
| | 20 | 7/8-14UNF-2A | 12.0 | 26.9 | 44 | 17.5 | 16.0 | 42 | 32 | 36 | 141 | GE20S7/8UNFOMD | 400 | 400 |
| | 20 | 1 1/16-12UN-2A | 16.0 | – | 46 | 17.0 | 18.5 | 42 | 32 | 36 | 163 | GE20S11/16UNOMD | 400 | 400 |
| | 25 | 1 1/16-12UN-2A | 16.0 | 33.3 | 50 | 19.5 | 18.5 | 47 | 36 | 46 | 206 | GE25S11/16UNOMD | 400 | 400 |
| | 25 | 1 5/16-12UN-2A | 20.0 | – | 50 | 19.5 | 18.5 | 47 | 41 | 46 | 258 | GE25S15/16UNOMD | 400 | 400 |
| | 30 | 1 5/16-12UN-2A | 20.0 | 39.6 | 52 | 20.0 | 18.5 | 50 | 46 | 50 | 327 | GE30S15/16UNOMD | 400 | 400 |
| | 30 | 1 5/8-12UN-2A | 24.0 | – | 52 | 20.0 | 18.5 | 50 | 50 | 50 | 422 | GE30S15/8UNOMD | 400 | 400 |
| | 38 | 1 5/8-12UN-2A | 24.0 | 47.7 | 57 | 22.5 | 18.5 | 57 | 55 | 60 | 554 | GE38S15/8UNOMD | 315 | 315 |

1) Pressure shown = item deliverable

3) L = light series; 4) S = heavy series

$$\frac{PN \text{ (bar)}}{10} = PN \text{ (MPa)}$$
Delivery without nut and ring. Information on ordering complete fittings or alternative sealing materials see page 17.

 *Please add the **suffixes** below according to the material/surface required.

| Order code suffixes | | | |
|---------------------------------|-----------------------------|------------------|---|
| Material | Suffix surface and material | Example | Standard sealing material (no additional suffix needed) |
| Steel, zinc plated, Cr(VI)-free | CF | GE16S3/4UNFOMDCF | NBR |
| Stainless Steel | 71 | GE16S3/4UNFOMD71 | VIT |



GE-NPT Male stud connector

Male NPT thread (SAE J476) / EO 24° cone end

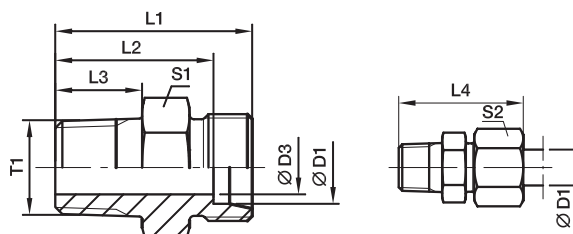

| Series | D1 | T1 | D3 | L1 | L2 | L3 | L4 | S1 | S2 | Weight g/1 piece | Order code* | PN (bar) ¹⁾ | | |
|------------------|----------------|------------|------|------|------|------|----|-----|-----|---------------------|--------------|------------------------|-----|-----|
| | | | | | | | | | | | | CF | 71 | MS |
| LL ²⁾ | 04 | 1/8-27 NPT | 3.0 | 22.0 | 18.0 | 10.0 | 28 | 11* | 10 | 9 | GE04LL1/8NPT | 100 | 100 | |
| | 06 | 1/8-27 NPT | 4.5 | 22.0 | 16.5 | 10.0 | 28 | 11* | 12 | 9 | GE06LL1/8NPT | 100 | 100 | 63 |
| | 08 | 1/8-27 NPT | 5.0 | 24.0 | 18.5 | 10.0 | 30 | 12 | 14 | 11 | GE08LL1/8NPT | 100 | 100 | 63 |
| L ³⁾ | 06 | 1/8-27 NPT | 4.0 | 24.0 | 17.0 | 10.0 | 32 | 12 | 14 | 12 | GE06L1/8NPT | 315 | 315 | 200 |
| | 06 | 1/4-18 NPT | 4.0 | 30.0 | 23.0 | 14.5 | 38 | 17 | 14 | 27 | GE06L1/4NPT | 315 | 315 | 200 |
| | 06 | 3/8-18 NPT | 4.0 | 30.0 | 23.0 | 14.5 | 38 | 19 | 14 | 32 | GE06L3/8NPT | 315 | 315 | |
| | 06 | 1/2-14 NPT | 4.0 | 36.0 | 29.0 | 19.5 | 44 | 22 | 14 | 53 | GE06L1/2NPT | 315 | 315 | |
| | 08 | 1/8-27 NPT | 4.0 | 25.0 | 18.0 | 10.0 | 33 | 14 | 17 | 16 | GE08L1/8NPT | 315 | 315 | |
| | 08 | 1/4-18 NPT | 6.0 | 30.0 | 23.0 | 14.5 | 38 | 17 | 17 | 25 | GE08L1/4NPT | 315 | 315 | 200 |
| | 08 | 3/8-18 NPT | 6.0 | 30.0 | 23.0 | 14.5 | 38 | 19 | 17 | 34 | GE08L3/8NPT | 315 | 315 | |
| | 08 | 1/2-14 NPT | 6.0 | 36.0 | 29.0 | 19.5 | 44 | 22 | 17 | 54 | GE08L1/2NPT | 315 | 315 | |
| | 10 | 1/8-27 NPT | 4.0 | 25.0 | 18.0 | 10.0 | 33 | 17 | 19 | 19 | GE10L1/8NPT | 315 | 315 | |
| | 10 | 1/4-18 NPT | 7.0 | 31.0 | 24.0 | 14.5 | 39 | 17 | 19 | 25 | GE10L1/4NPT | 315 | 315 | 200 |
| | 10 | 3/8-18 NPT | 7.0 | 32.0 | 25.0 | 14.5 | 40 | 19 | 19 | 40 | GE10L3/8NPT | 315 | 315 | |
| | 10 | 1/2-14 NPT | 8.0 | 37.0 | 30.0 | 19.5 | 45 | 22 | 19 | 54 | GE10L1/2NPT | 315 | 315 | |
| | 10 | 3/4-14 NPT | 8.0 | 38.0 | 31.0 | 19.5 | 46 | 30 | 19 | 93 | GE10L3/4NPT | 315 | 315 | |
| | 12 | 1/8-27 NPT | 4.0 | 26.0 | 19.0 | 10.0 | 34 | 19 | 22 | 52 | GE12L1/8NPT | 315 | 315 | |
| | 12 | 1/4-18 NPT | 7.0 | 32.0 | 25.0 | 14.5 | 40 | 19 | 22 | 31 | GE12L1/4NPT | 315 | 315 | 200 |
| | 12 | 3/8-18 NPT | 8.0 | 32.0 | 25.0 | 14.5 | 40 | 19 | 22 | 37 | GE12L3/8NPT | 315 | 315 | 200 |
| | 12 | 1/2-14 NPT | 10.0 | 37.0 | 30.0 | 19.5 | 45 | 22 | 22 | 62 | GE12L1/2NPT | 315 | 315 | 200 |
| | 15 | 3/8-18 NPT | 8.0 | 33.0 | 26.0 | 14.5 | 41 | 24 | 27 | 53 | GE15L3/8NPT | 315 | 315 | |
| | 15 | 1/2-14 NPT | 12.0 | 38.0 | 31.0 | 19.5 | 46 | 24 | 27 | 63 | GE15L1/2NPT | 315 | 315 | 200 |
| | 15 | 3/4-14 NPT | 12.0 | 39.0 | 32.0 | 19.5 | 47 | 30 | 27 | 112 | GE15L3/4NPT | 315 | 315 | |
| | 15 | 1-11.5 NPT | 12.0 | 45.0 | 38.0 | 24.5 | 53 | 36 | 27 | 158 | GE15L1NPT | 315 | 315 | |
| | 18 | 3/8-18 NPT | 8.0 | 34.0 | 26.5 | 14.5 | 43 | 27 | 32 | 69 | GE18L3/8NPT | 315 | 315 | |
| | 18 | 1/2-14 NPT | 12.0 | 39.0 | 31.5 | 19.5 | 48 | 27 | 32 | 79 | GE18L1/2NPT | 315 | 315 | 200 |
| | 18 | 3/4-14 NPT | 15.0 | 39.0 | 31.5 | 19.5 | 48 | 30 | 32 | 104 | GE18L3/4NPT | 315 | 315 | |
| | 18 | 1-11.5 NPT | 15.0 | 45.0 | 37.5 | 24.5 | 54 | 36 | 32 | 159 | GE18L1NPT | 315 | 315 | |
| | 22 | 3/8-18 NPT | 8.0 | 36.5 | 29.0 | 14.5 | 45 | 32 | 36 | 91 | GE22L3/8NPT | 160 | 160 | |
| | 22 | 1/2-14 NPT | 12.0 | 41.0 | 33.5 | 19.5 | 50 | 32 | 36 | 96 | GE22L1/2NPT | 160 | 160 | |
| | 22 | 3/4-14 NPT | 16.0 | 41.0 | 33.5 | 19.5 | 50 | 32 | 36 | 108 | GE22L3/4NPT | 160 | 160 | 100 |
| | 22 | 1-11.5 NPT | 19.0 | 47.0 | 39.5 | 24.5 | 56 | 36 | 36 | 174 | GE22L1NPT | 160 | 160 | |
| | 28 | 3/4-14 NPT | 16.0 | 42.0 | 34.5 | 19.5 | 51 | 41 | 41 | 157 | GE28L3/4NPT | 160 | 160 | |
| 28 | 1-11.5 NPT | 21.0 | 47.0 | 39.5 | 24.5 | 56 | 41 | 41 | 197 | GE28L1NPT | 160 | 160 | 100 | |
| 28 | 1 1/4-11.5 NPT | 24.0 | 49.0 | 41.5 | 25.0 | 58 | 46 | 41 | 266 | GE28L11/4NPT | 160 | 160 | | |
| 35 | 1-11.5 NPT | 22.0 | 50.0 | 39.5 | 24.5 | 61 | 46 | 50 | 280 | GE35L1NPT | 160 | 160 | | |
| 35 | 1 1/4-11.5 NPT | 28.0 | 51.0 | 40.5 | 25.0 | 62 | 46 | 50 | 285 | GE35L11/4NPT | 160 | 160 | | |
| 42 | 1 1/4-11.5 NPT | 28.0 | 53.0 | 42.0 | 25.0 | 65 | 55 | 60 | 382 | GE42L11/4NPT | 160 | 160 | | |
| 42 | 1 1/2-11.5 NPT | 36.0 | 53.0 | 42.0 | 26.0 | 65 | 55 | 60 | 377 | GE42L11/2NPT | 160 | 160 | | |

¹⁾ Pressure shown = item deliverable

²⁾ LL = very light series; ³⁾ L = light series

PN (bar) = PN (MPa)
10

Delivery without nut and ring. Information on ordering complete fittings see page 17.

*S1=SW12 in 1.4571

*Please add the **suffixes** below according to the material/surface required.

| Order code suffixes | | |
|---------------------------------|-----------------------------|----------------|
| Material | Suffix surface and material | Example |
| Steel, zinc plated, Cr(VI)-free | CFX | GE18L1/2NPTCFX |
| Stainless Steel | 71X | GE18L1/2NPT71X |
| Brass | MSX | GE18L1/2NPTMSX |



DIN fittings

GE-NPT Male stud connector

Male NPT thread (SAE J476) / EO 24° cone end

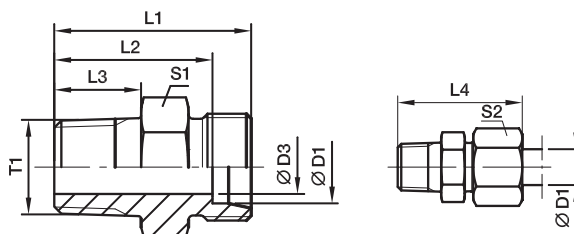

| Series | D1 | T1 | D3 | L1 | L2 | L3 | L4 | S1 | S2 | Weight g/1 piece | Order code* | PN (bar) ¹⁾ | | |
|-----------------|----------------|----------------|------------|------|------|------|------|----|-----|---------------------|--------------|------------------------|-----|-----|
| | | | | | | | | | | | | CF | 71 | MS |
| S ⁴⁾ | 06 | 1/8-27 NPT | 4 | 28 | 21.0 | 10.0 | 36 | 14 | 17 | 21 | GE06S1/8NPT | 630 | 630 | |
| | 06 | 1/4-18 NPT | 4 | 35 | 28.0 | 14.5 | 43 | 17 | 17 | 37 | GE06S1/4NPT | 630 | 630 | 400 |
| | 06 | 3/8-18 NPT | 4 | 33 | 26.0 | 14.5 | 41 | 19 | 17 | 40 | GE06S3/8NPT | 630 | 630 | |
| | 06 | 1/2-14 NPT | 4 | 42 | 35.0 | 19.5 | 50 | 22 | 17 | 71 | GE06S1/2NPT | 630 | 630 | |
| | 08 | 1/4-18 NPT | 5 | 35 | 28.0 | 14.5 | 43 | 17 | 19 | 38 | GE08S1/4NPT | 630 | 630 | 400 |
| | 08 | 3/8-18 NPT | 5 | 35 | 28.0 | 14.5 | 43 | 19 | 19 | 46 | GE08S3/8NPT | 630 | 630 | |
| | 08 | 1/2-14 NPT | 5 | 42 | 35.0 | 19.5 | 50 | 22 | 19 | 73 | GE08S1/2NPT | 630 | 630 | 400 |
| | 10 | 1/4-18 NPT | 5 | 35 | 27.5 | 14.5 | 44 | 19 | 22 | 45 | GE10S1/4NPT | 630 | 630 | |
| | 10 | 3/8-18 NPT | 7 | 35 | 27.5 | 14.5 | 44 | 19 | 22 | 49 | GE10S3/8NPT | 630 | 630 | 400 |
| | 10 | 1/2-14 NPT | 7 | 42 | 34.5 | 19.5 | 51 | 22 | 22 | 73 | GE10S1/2NPT | 630 | 630 | 400 |
| | 10 | 3/4-14 NPT | 7 | 44 | 36.5 | 19.5 | 53 | 30 | 22 | 125 | GE10S3/4NPT | 630 | 630 | |
| | 12 | 1/4-18 NPT | 5 | 37 | 29.5 | 14.5 | 46 | 22 | 24 | 57 | GE12S1/4NPT | 630 | 630 | |
| | 12 | 3/8-18 NPT | 8 | 37 | 29.5 | 14.5 | 46 | 22 | 24 | 62 | GE12S3/8NPT | 630 | 630 | 400 |
| | 12 | 1/2-14 NPT | 8 | 42 | 34.5 | 19.5 | 51 | 22 | 24 | 83 | GE12S1/2NPT | 630 | 630 | 400 |
| | 12 | 3/4-14 NPT | 8 | 44 | 36.5 | 19.5 | 53 | 30 | 24 | 126 | GE12S3/4NPT | 630 | 630 | |
| | | 16 | 3/8-18 NPT | 8 | 39 | 30.5 | 14.5 | 49 | 27 | 30 | 84 | GE16S3/8NPT | 400 | 400 |
| 16 | | 1/2-14 NPT | 12 | 44 | 39.5 | 19.5 | 58 | 27 | 30 | 97 | GE16S1/2NPT | 400 | 400 | 250 |
| 16 | | 3/4-14 NPT | 12 | 46 | 37.5 | 19.5 | 56 | 30 | 30 | 130 | GE16S3/4NPT | 400 | 400 | |
| 16 | | 1-11.5 NPT | 12 | 51 | 42.5 | 24.5 | 61 | 36 | 30 | 178 | GE16S1NPT | 400 | 400 | |
| 20 | | 1/2-14 NPT | 12 | 48 | 37.5 | 19.5 | 59 | 32 | 36 | 144 | GE20S1/2NPT | 400 | 400 | |
| 20 | | 3/4-14 NPT | 16 | 48 | 37.5 | 19.5 | 59 | 32 | 36 | 149 | GE20S3/4NPT | 400 | 400 | 250 |
| 20 | | 1-11.5 NPT | 16 | 55 | 44.5 | 24.5 | 66 | 36 | 36 | 243 | GE20S1NPT | 400 | 400 | |
| 25 | | 3/4-14 NPT | 16 | 52 | 40.0 | 19.5 | 64 | 41 | 46 | 240 | GE25S3/4NPT | 400 | 400 | |
| 25 | | 1-11.5 NPT | 20 | 57 | 45.0 | 24.5 | 69 | 41 | 46 | 278 | GE25S1NPT | 400 | 400 | |
| 25 | | 1 1/4-11.5 NPT | 20 | 58 | 46.0 | 25.0 | 70 | 46 | 46 | 396 | GE25S11/4NPT | 400 | 400 | |
| 25 | | 1 1/2-11.5 NPT | 20 | 61 | 49.0 | 26.0 | 73 | 50 | 46 | 469 | GE25S11/2NPT | 400 | 400 | |
| 30 | | 3/4-14 NPT | 16 | 54 | 40.5 | 19.5 | 67 | 46 | 50 | 307 | GE30S3/4NPT | 400 | 400 | |
| 30 | | 1-11.5 NPT | 20 | 59 | 45.5 | 24.5 | 72 | 46 | 50 | 343 | GE30S1NPT | 400 | 400 | 100 |
| 30 | | 1 1/4-11.5 NPT | 25 | 60 | 46.5 | 25.0 | 73 | 46 | 50 | 397 | GE30S11/4NPT | 400 | 400 | |
| 30 | | 1 1/2-11.5 NPT | 25 | 60 | 46.5 | 26.0 | 73 | 50 | 50 | 440 | GE30S11/2NPT | 400 | 400 | |
| 38 | | 1-11.5 NPT | 22 | 64 | 48.0 | 24.5 | 79 | 55 | 60 | 510 | GE38S1NPT | 315 | 315 | |
| 38 | 1 1/4-11.5 NPT | 25 | 65 | 49.0 | 25.0 | 80 | 55 | 60 | 535 | GE38S11/4NPT | 315 | 315 | | |
| 38 | 1 1/2-11.5 NPT | 32 | 65 | 49.0 | 26.0 | 80 | 55 | 60 | 571 | GE38S11/2NPT | 315 | 315 | | |

1) Pressure shown = item deliverable

4) S = heavy series

$$\frac{\text{PN (bar)}}{10} = \text{PN (MPa)}$$
Delivery without nut and ring. Information on ordering complete fittings see page I7.

 *Please add the **suffixes** below according to the material/surface required.

| Order code suffixes | | |
|---------------------------------|-----------------------------|----------------|
| Material | Suffix surface and material | Example |
| Steel, zinc plated, Cr(VI)-free | CFX | GE16S1/2NPTCFX |
| Stainless Steel | 71X | GE16S1/2NPT71X |
| Brass | MSX | GE16S1/2NPTMSX |



EGEO Swivel connector

Male metric thread – O-ring (ISO 6149) / EO 24° DKO swivel

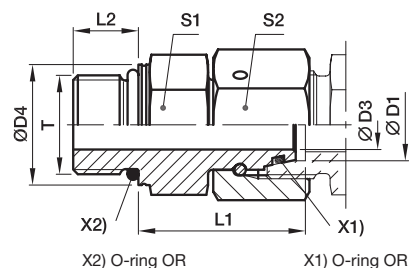

| Series | D1 | T | D3 | D4 | L1 | L2 | S1 | S2 | Weight g/1 piece | Order code* | PN (bar) ¹⁾ CF |
|-----------------|----------|----------|------|------|------|------|----|-----|---------------------|--------------|---------------------------------|
| L ³⁾ | 06 | M 10×1.0 | 2.5 | 13.8 | 24.5 | 8.5 | 14 | 14 | 29 | EGEO06LM | 500 |
| | 08 | M 12×1.5 | 4.0 | 16.8 | 26.5 | 11.0 | 17 | 17 | 43 | EGEO08LM | 500 |
| | 10 | M 14×1.5 | 6.0 | 18.8 | 27.5 | 11.0 | 19 | 19 | 57 | EGEO10LM | 500 |
| | 12 | M 16×1.5 | 8.0 | 21.8 | 30.5 | 11.5 | 22 | 22 | 85 | EGEO12LM | 400 |
| | 15 | M 18×1.5 | 10.0 | 23.8 | 31.5 | 12.5 | 24 | 27 | 115 | EGEO15LM | 400 |
| | 18 | M 22×1.5 | 13.0 | 26.8 | 31.5 | 13.0 | 27 | 32 | 152 | EGEO18LM | 400 |
| | 22 | M 27×2.0 | 17.0 | 31.8 | 32.5 | 16.0 | 32 | 36 | 207 | EGEO22LM27X2 | 250 |
| | 28 | M 33×2.0 | 22.0 | 40.8 | 35.0 | 16.0 | 41 | 41 | 294 | EGEO28LM | 250 |
| | 35 | M 42×2.0 | 28.0 | 49.8 | 42.5 | 16.0 | 50 | 50 | 516 | EGEO35LM | 250 |
| | 42 | M 48×2.0 | 34.0 | 54.8 | 46.5 | 17.5 | 55 | 60 | 718 | EGEO42LM | 250 |
| S ⁴⁾ | 06 | M 12×1.5 | 2.5 | 16.8 | 27.0 | 11.0 | 17 | 17 | 49 | EGEO06SM | 800 |
| | 08 | M 14×1.5 | 4.0 | 18.8 | 29.5 | 11.0 | 19 | 19 | 69 | EGEO08SM | 800 |
| | 10 | M 16×1.5 | 6.0 | 21.8 | 32.0 | 12.5 | 22 | 22 | 96 | EGEO10SM | 800 |
| | 12 | M 18×1.5 | 8.0 | 23.8 | 34.0 | 14.0 | 24 | 24 | 116 | EGEO12SM | 630 |
| | 16 | M 22×1.5 | 11.0 | 26.8 | 37.0 | 15.0 | 27 | 30 | 179 | EGEO16SM | 630 |
| | 20 | M 27×2.0 | 14.0 | 31.8 | 43.0 | 18.5 | 32 | 36 | 280 | EGEO20SM | 420 |
| | 25 | M 33×2.0 | 18.0 | 40.8 | 48.0 | 18.5 | 41 | 46 | 502 | EGEO25SM | 420 |
| | 30 | M 42×2.0 | 23.0 | 49.8 | 51.0 | 19.0 | 50 | 50 | 697 | EGEO30SM | 420 |
| 38 | M 48×2.0 | 30.0 | 54.8 | 60.0 | 21.5 | 55 | 60 | 965 | EGEO38SM | 420 | |

¹⁾ Pressure shown = item deliverable

³⁾ L = light series; ⁴⁾ S = heavy series

$\frac{PN \text{ (bar)}}{10} = PN \text{ (MPa)}$

Information on ordering alternative sealing materials see page 17.

*Please add the **suffixes** below according to the material/surface required.

| Order code suffixes | | | |
|---------------------------------|-----------------------------|------------|---|
| Material | Suffix surface and material | Example | Standard sealing material (no additional suffix needed) |
| Steel, zinc plated, Cr(VI)-free | CF | EGEO16SMCF | NBR |

DIN fittings

EGE-M-ED Swivel connector

Male metric thread – ED-seal (ISO 9974) / EO 24° DKO swivel

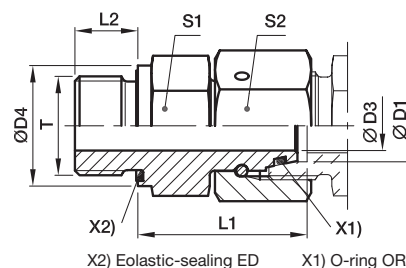

| Series | D1 | T | D3 | D4 | L1 | L2 | S1 | S2 | Weight g/1 piece | Order code* | PN (bar) ¹⁾ | |
|-----------------|----------|----------|------|------|------|----|----|-----|---------------------|------------------------|------------------------|-----|
| | | | | | | | | | | | CF | 71 |
| L ³⁾ | 06 | M 10×1.0 | 2.5 | 14 | 24.5 | 8 | 14 | 14 | 27 | EGE06LMED | 500 | 315 |
| | 08 | M 12×1.5 | 4.0 | 17 | 26.5 | 12 | 17 | 17 | 45 | EGE08LMED | 500 | 315 |
| | 10 | M 14×1.5 | 6.0 | 19 | 27.5 | 12 | 19 | 19 | 57 | EGE10LMED | 500 | 315 |
| | 12 | M 16×1.5 | 8.0 | 22 | 30.5 | 12 | 22 | 22 | 82 | EGE12LMED | 400 | 315 |
| | 12 | M 22×1.5 | 8.0 | 27 | 27.0 | 14 | 27 | 22 | 92 | EGE12LM22X1.5ED | 400 | 315 |
| | 15 | M 18×1.5 | 10.0 | 24 | 31.5 | 12 | 24 | 27 | 113 | EGE15LMED | 400 | 315 |
| | 15 | M 22×1.5 | 10.0 | 27 | 32.0 | 14 | 27 | 27 | 142 | EGE15LM22X1.5ED | 400 | 315 |
| | 18 | M 22×1.5 | 13.0 | 27 | 31.5 | 14 | 27 | 32 | 148 | EGE18LMED | 400 | 315 |
| | 22 | M 26×1.5 | 17.0 | 32 | 32.5 | 16 | 32 | 36 | 203 | EGE22LMED | 250 | 160 |
| | 28 | M 33×2.0 | 22.0 | 40 | 35.0 | 18 | 41 | 41 | 289 | EGE28LMED | 250 | 160 |
| S ⁴⁾ | 35 | M 42×2.0 | 28.0 | 50 | 42.5 | 20 | 50 | 50 | 511 | EGE35LMED | 250 | 160 |
| | 42 | M 48×2.0 | 34.0 | 55 | 46.5 | 22 | 55 | 60 | 711 | EGE42LMED | 250 | 160 |
| | 06 | M 12×1.5 | 2.5 | 17 | 27.0 | 12 | 17 | 17 | 47 | EGE06SMED | 800 | 630 |
| | 08 | M 14×1.5 | 4.0 | 19 | 29.5 | 12 | 19 | 19 | 65 | EGE08SMED | 800 | 630 |
| | 10 | M 16×1.5 | 6.0 | 22 | 32.0 | 12 | 22 | 22 | 91 | EGE10SMED | 800 | 630 |
| | 12 | M 18×1.5 | 8.0 | 24 | 34.0 | 12 | 24 | 24 | 112 | EGE12SMED | 630 | 630 |
| | 16 | M 22×1.5 | 11.0 | 27 | 37.0 | 14 | 27 | 30 | 174 | EGE16SMED | 630 | 400 |
| | 20 | M 27×2.0 | 14.0 | 32 | 43.0 | 16 | 32 | 36 | 274 | EGE20SMED | 420 | 400 |
| | 25 | M 33×2.0 | 18.0 | 40 | 48.0 | 18 | 41 | 46 | 497 | EGE25SMED | 420 | 400 |
| | 30 | M 42×2.0 | 23.0 | 50 | 51.0 | 20 | 50 | 50 | 691 | EGE30SMED | 420 | 400 |
| 38 | M 48×2.0 | 30.0 | 55 | 60.0 | 22 | 55 | 60 | 957 | EGE38SMED | 420 | 315 | |

1) Pressure shown = item deliverable

3) L = light series; 4) S = heavy series

$$\frac{\text{PN (bar)}}{10} = \text{PN (MPa)}$$

Information on ordering alternative sealing materials see page 17.

 *Please add the **suffixes** below according to the material/surface required

| Order code suffixes | | | |
|---------------------------------|-----------------------------|-------------|---|
| Material | Suffix surface and material | Example | Standard sealing material (no additional suffix needed) |
| Steel, zinc plated, Cr(VI)-free | CF | EGE16SMEDCF | NBR |
| Stainless Steel | 71 | EGE16SMED71 | VIT |



EGE-R-ED Swivel connector

Male BSPP thread – ED-seal (ISO 1179) / EO 24° DKO swivel

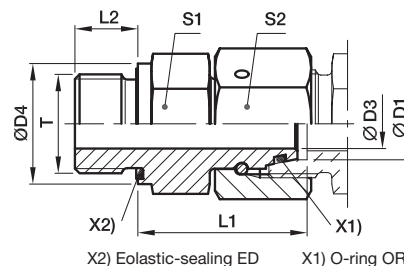

| Series | D1 | T | D3 | D4 | L1 | L2 | S1 | S2 | Weight g/1 piece | Order code* | PN (bar) ¹⁾ | |
|-----------------|-----------|-----------|------|------|------|----|----|-----|---------------------|---------------------|------------------------|-----|
| | | | | | | | | | | | CF | 71 |
| L ³⁾ | 06 | G 1/8 A | 2.5 | 14 | 24.5 | 8 | 14 | 14 | 27 | EGE06LRED | 500 | 315 |
| | 08 | G 1/4 A | 4.0 | 19 | 29.5 | 12 | 19 | 17 | 28 | EGE08LRED | 500 | 315 |
| | 10 | G 1/4 A | 6.0 | 19 | 27.5 | 12 | 19 | 19 | 54 | EGE10LRED | 500 | 315 |
| | 10 | G 3/8 A | 6.0 | 22 | 29.0 | 12 | 22 | 19 | 70 | EGE10LR3/8ED | 400 | 315 |
| | 12 | G 3/8 A | 8.0 | 22 | 34.0 | 12 | 22 | 22 | 95 | EGE12LRED | 400 | 315 |
| | 12 | G 1/4 A | 6.0 | 19 | 27.5 | 12 | 19 | 22 | 65 | EGE12LR1/4ED | 400 | 315 |
| | 12 | G 1/2 A | 8.0 | 27 | 29.5 | 14 | 27 | 22 | 114 | EGE12LR1/2ED | 400 | 315 |
| | 15 | G 1/2 A | 10.0 | 27 | 32.0 | 14 | 27 | 27 | 137 | EGE15LRED | 400 | 315 |
| | 18 | G 1/2 A | 13.0 | 27 | 31.5 | 14 | 27 | 32 | 143 | EGE18LRED | 400 | 315 |
| | 18 | G 3/4 A | 13.0 | 32 | 29.5 | 16 | 32 | 32 | 182 | EGE18LR3/4ED | 250 | 160 |
| | 22 | G 3/4 A | 17.0 | 32 | 32.5 | 16 | 32 | 36 | 200 | EGE22LRED | 250 | 160 |
| | 28 | G 1 A | 22.0 | 40 | 35.0 | 18 | 41 | 41 | 289 | EGE28LRED | 250 | 160 |
| | 35 | G 1 1/4 A | 28.0 | 50 | 42.5 | 20 | 50 | 50 | 500 | EGE35LRED | 250 | 160 |
| | 42 | G 1 1/2 A | 34.0 | 55 | 46.5 | 22 | 55 | 60 | 718 | EGE42LRED | 250 | 160 |
| S ⁴⁾ | 06 | G 1/4 A | 2.5 | 19 | 27.0 | 12 | 19 | 17 | 53 | EGE06SRED | 800 | 630 |
| | 08 | G 1/4 A | 4.0 | 19 | 29.5 | 12 | 19 | 19 | 64 | EGE08SRED | 800 | 630 |
| | 10 | G 3/8 A | 6.0 | 22 | 32.0 | 12 | 22 | 22 | 93 | EGE10SRED | 800 | 630 |
| | 12 | G 3/8 A | 8.0 | 22 | 34.0 | 12 | 22 | 24 | 100 | EGE12SRED | 630 | 630 |
| | 12 | G 1/4 A | 5.0 | 19 | 31.5 | 12 | 19 | 24 | 140 | EGE12SR1/4ED | 630 | 630 |
| | 12 | G 1/2 A | 8.0 | 27 | 35.0 | 14 | 27 | 24 | 140 | EGE12SR1/2ED | 630 | 630 |
| | 16 | G 1/2 A | 11.0 | 27 | 37.0 | 14 | 27 | 30 | 170 | EGE16SRED | 630 | 400 |
| | 20 | G 3/4 A | 14.0 | 32 | 43.0 | 16 | 32 | 36 | 273 | EGE20SRED | 420 | 400 |
| | 25 | G 1 A | 18.0 | 40 | 48.0 | 18 | 41 | 46 | 493 | EGE25SRED | 420 | 400 |
| | 30 | G 1 1/4 A | 23.0 | 50 | 51.0 | 20 | 50 | 50 | 691 | EGE30SRED | 420 | 400 |
| 38 | G 1 1/2 A | 30.0 | 55 | 60.0 | 22 | 55 | 60 | 934 | EGE38SRED | 420 | 315 | |

¹⁾ Pressure shown = item deliverable

³⁾ L = light series; ⁴⁾ S = heavy series

$\frac{PN \text{ (bar)}}{10} = PN \text{ (MPa)}$

Information on ordering alternative sealing materials see page 17.

*Please add the **suffixes** below according to the material/surface required.

| Order code suffixes | | | |
|---------------------------------|-----------------------------|-------------|---|
| Material | Suffix surface and material | Example | Standard sealing material (no additional suffix needed) |
| Steel, zinc plated, Cr(VI)-free | CF | EGE16SREDCF | NBR |
| Stainless Steel | 71 | EGE16SRED71 | VIT |



DIN fittings

EVGE-M-ED Standpipe connector

Male metric thread – ED (ISO 9974) / EO standpipe adjustable

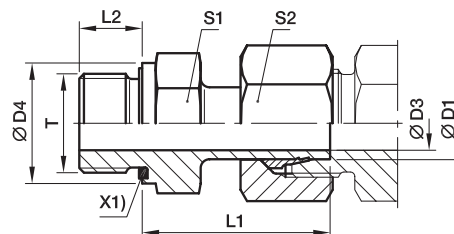

X1) Eolastic-sealing ED

Pre-assembled nut and ring.
Final assembly (in appropriate body) at least 1/4 turn beyond the point of clearly perceptible resistance.

| Series | D1 | T | D3 | D4 | L1 | L2 | S1 | S2 | Weight g/1 piece | Order code* | PN (bar) ¹⁾ | |
|-----------------|----|----------|------|----|------|----|----|----|---------------------|-------------|------------------------|-----|
| | | | | | | | | | | | CF | 71 |
| L ³⁾ | 06 | M 10×1.0 | 3.5 | 14 | 24.5 | 8 | 14 | 14 | 24 | EVGE06LMED | 315 | 315 |
| | 08 | M 12×1.5 | 5.5 | 17 | 26.5 | 12 | 17 | 17 | 38 | EVGE08LMED | 315 | 315 |
| | 10 | M 14×1.5 | 7.0 | 19 | 27.5 | 12 | 19 | 19 | 49 | EVGE10LMED | 315 | 315 |
| | 12 | M 16×1.5 | 9.0 | 22 | 30.0 | 12 | 22 | 22 | 67 | EVGE12LMED | 315 | 315 |
| | 15 | M 18×1.5 | 11.0 | 24 | 30.5 | 12 | 24 | 27 | 95 | EVGE15LMED | 315 | 315 |
| | 18 | M 22×1.5 | 14.0 | 27 | 31.5 | 14 | 27 | 32 | 137 | EVGE18LMED | 315 | 315 |
| | 22 | M 26×1.5 | 18.0 | 32 | 32.5 | 16 | 32 | 36 | 183 | EVGE22LMED | 160 | 160 |
| | 28 | M 33×2.0 | 23.0 | 40 | 35.0 | 18 | 41 | 41 | 264 | EVGE28LMED | 160 | 160 |
| | 35 | M 42×2.0 | 29.5 | 50 | 42.5 | 20 | 50 | 50 | 444 | EVGE35LMED | 160 | 160 |
| | 42 | M 48×2.0 | 35.5 | 55 | 46.5 | 22 | 55 | 60 | 614 | EVGE42LMED | 160 | 160 |
| S ⁴⁾ | 06 | M 12×1.5 | 3.5 | 17 | 27.0 | 12 | 17 | 17 | 43 | EVGE06SMED | 630 | 630 |
| | 08 | M 14×1.5 | 4.5 | 19 | 29.5 | 12 | 19 | 19 | 59 | EVGE08SMED | 630 | 630 |
| | 10 | M 16×1.5 | 6.5 | 22 | 32.0 | 12 | 22 | 22 | 82 | EVGE10SMED | 630 | 630 |
| | 12 | M 18×1.5 | 7.5 | 24 | 34.0 | 12 | 24 | 24 | 104 | EVGE12SMED | 630 | 630 |
| | 16 | M 22×1.5 | 11.5 | 27 | 37.0 | 14 | 27 | 30 | 162 | EVGE16SMED | 400 | 400 |
| | 20 | M 27×2.0 | 15.5 | 32 | 43.0 | 16 | 32 | 36 | 254 | EVGE20SMED | 400 | 400 |
| | 25 | M 33×2.0 | 18.0 | 40 | 48.0 | 18 | 41 | 46 | 493 | EVGE25SMED | 400 | 400 |
| | 30 | M 42×2.0 | 23.5 | 50 | 51.0 | 20 | 50 | 50 | 654 | EVGE30SMED | 400 | 400 |
| | 38 | M 48×2.0 | 29.0 | 55 | 60.0 | 22 | 55 | 60 | 962 | EVGE38SMED | 315 | 315 |

1) Pressure shown = item deliverable

3) L = light series; 4) S = heavy series

$$\frac{PN \text{ (bar)}}{10} = PN \text{ (MPa)}$$

The use of the swivel nut fitting EGE is to be preferred (see page I60).

Information on ordering alternative sealing materials see page I7.

| Order code suffixes | | | |
|---------------------------------|-----------------------------|--------------|---|
| Material | Suffix surface and material | Example | Standard sealing material (no additional suffix needed) |
| Steel, zinc plated, Cr(VI)-free | CF | EVGE16SMEDCF | NBR |
| Stainless Steel | 71 | EVGE16SMED71 | VIT |

*Please add the **suffixes** below according to the material/surface required.



EVGE-R-ED Standpipe connector

Male BSPP thread – ED-seal (ISO 1179) / EO standpipe adjustable

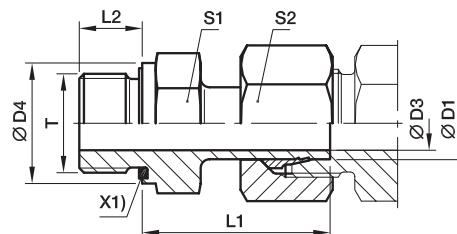

X1) Eolastic-sealing ED

Pre-assembled nut and ring.
Final assembly (in appropriate body) at least 1/4 turn beyond the point of clearly perceptible resistance.

| Series | D1 | T | D3 | D4 | L1 | L2 | S1 | S2 | Weight g/1 piece | Order code* | PN (bar) ¹⁾ | | | |
|-----------------|-----------------|-----------|---------|-----|------|------|----|----|---------------------|----------------------|------------------------|-----|-----|--|
| | | | | | | | | | | | CF | 71 | MS | |
| L ³⁾ | 06 | G 1/8 A | 3.5 | 14 | 24.5 | 8 | 14 | 14 | 24 | EVGE06LRED | 315 | 315 | 200 | |
| | 08 | G 1/4 A | 4.5 | 19 | 29.5 | 12 | 19 | 17 | 52 | EVGE08LRED | 315 | 315 | 200 | |
| | 10 | G 1/4 A | 7.0 | 19 | 27.5 | 12 | 19 | 19 | 47 | EVGE10LRED | 315 | 315 | 200 | |
| | 12 | G 3/8 A | 7.5 | 22 | 34.0 | 12 | 22 | 22 | 87 | EVGE12LRED | 315 | 315 | 200 | |
| | 12 | G 1/4 A | 7.0 | 19 | 28.5 | 12 | 19 | 22 | 61 | EVGE12LR1/4ED | 315 | | | |
| | 12 | G 1/2 A | 7.5 | 27 | 34.5 | 14 | 27 | 22 | 121 | EVGE12LR1/2ED | 315 | 315 | | |
| | 15 | G 1/2 A | 11.0 | 27 | 31.0 | 14 | 27 | 27 | 114 | EVGE15LRED | 315 | 315 | 200 | |
| | 18 | G 1/2 A | 14.0 | 27 | 31.5 | 14 | 27 | 32 | 132 | EVGE18LRED | 315 | 315 | 200 | |
| | 22 | G 3/4 A | 18.0 | 32 | 32.5 | 16 | 32 | 36 | 183 | EVGE22LRED | 160 | 160 | 100 | |
| | 28 | G 1 A | 23.0 | 40 | 35.0 | 18 | 41 | 41 | 262 | EVGE28LRED | 160 | 160 | | |
| | 35 | G 1 1/4 A | 29.5 | 50 | 42.5 | 20 | 50 | 50 | 436 | EVGE35LRED | 160 | 160 | | |
| | 42 | G 1 1/2 A | 35.5 | 55 | 46.5 | 22 | 55 | 60 | 615 | EVGE42LRED | 160 | 160 | | |
| | S ⁴⁾ | 06 | G 1/4 A | 3.5 | 19 | 27.0 | 12 | 19 | 17 | 48 | EVGE06SRED | 630 | 630 | |
| | | 08 | G 1/4 A | 4.5 | 19 | 29.5 | 12 | 19 | 19 | 57 | EVGE08SRED | 630 | 630 | |
| 10 | | G 3/8 A | 6.5 | 22 | 32.0 | 12 | 22 | 22 | 84 | EVGE10SRED | 630 | 630 | | |
| 12 | | G 3/8 A | 7.5 | 22 | 34.0 | 12 | 22 | 24 | 95 | EVGE12SRED | 630 | 630 | | |
| 12 | | G 1/2 A | 7.5 | 27 | 34.5 | 14 | 27 | 24 | 130 | EVGE12SR1/2ED | 630 | 630 | | |
| 16 | | G 1/2 A | 11.5 | 27 | 37.0 | 14 | 27 | 30 | 158 | EVGE16SRED | 400 | 400 | | |
| 16 | | G 3/4 A | 11.5 | 32 | 39.0 | 16 | 32 | 30 | 222 | EVGE16SR3/4ED | 400 | | | |
| 20 | | G 3/4 A | 15.5 | 32 | 43.0 | 16 | 32 | 36 | 254 | EVGE20SRED | 400 | 400 | | |
| 25 | | G 1 A | 18.0 | 40 | 48.0 | 18 | 41 | 46 | 485 | EVGE25SRED | 400 | 400 | | |
| 30 | | G 1 1/4 A | 23.5 | 50 | 51.0 | 20 | 50 | 50 | 661 | EVGE30SRED | 400 | 400 | | |
| 38 | | G 1 1/2 A | 29.0 | 55 | 60.0 | 22 | 55 | 60 | 962 | EVGE38SRED | 315 | 315 | | |

¹⁾ Pressure shown = item deliverable

³⁾ L = light series; ⁴⁾ S = heavy series

PN (bar) = PN (MPa) / 10

The use of the swivel nut fitting EGE is to be preferred (see page I61).

Information on ordering alternative sealing materials see page I7.

| Order code suffixes | | | |
|---------------------------------|-----------------------------|--------------|---|
| Material | Suffix surface and material | Example | Standard sealing material (no additional suffix needed) |
| Steel, zinc plated, Cr(VI)-free | CF | EVGE16SREDCF | NBR |
| Stainless Steel | 71 | EVGE16SRED71 | VIT |
| Brass | MS | EVGE16SREDMS | NBR |

*Please add the suffixes below according to the material/surface required.

DIN fittings

EGE-NPT Swivel connector

Male NPT thread (SAE J476) / EO 24° DKO swivel

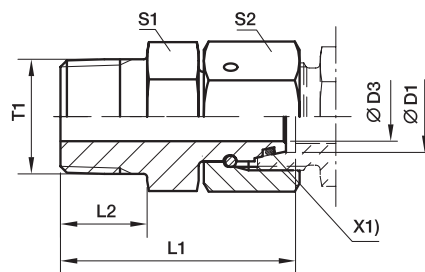

X1) O-ring OR

| Series | D1 | T1 | D3 | L1 | L2 | S1 | S2 | Weight g/1 piece | Order code* | PN (bar) ¹⁾ CF |
|-----------------|----|----------------|------|------|------|----|----|---------------------|----------------------|------------------------------|
| L ³⁾ | 06 | 1/8-27 NPT | 2.5 | 31.5 | 10.0 | 11 | 14 | 23 | EGE06L1/8NPT | 315 |
| | 08 | 1/4-18 NPT | 4.0 | 37.5 | 14.5 | 14 | 17 | 41 | EGE08L1/4NPT | 315 |
| | 10 | 1/4-18 NPT | 6.0 | 38.0 | 14.5 | 14 | 19 | 44 | EGE10L1/4NPT | 315 |
| | 12 | 3/8-18 NPT | 8.0 | 40.0 | 14.5 | 19 | 22 | 69 | EGE12L3/8NPT | 315 |
| | 15 | 1/2-14 NPT | 10.0 | 49.5 | 19.5 | 22 | 27 | 127 | EGE15L1/2NPT | 315 |
| | 18 | 1/2-14 NPT | 12.0 | 49.0 | 19.5 | 24 | 32 | 142 | EGE18L1/2NPT | 315 |
| | 22 | 3/4-14 NPT | 16.0 | 52.0 | 19.5 | 27 | 36 | 200 | EGE22L3/4NPT | 160 |
| | 28 | 1-11.5 NPT | 22.0 | 61.0 | 24.5 | 36 | 41 | 306 | EGE28L1NPT | 160 |
| | 35 | 1 1/4-11.5 NPT | 28.0 | 65.5 | 25.0 | 46 | 50 | 486 | EGE35L11/4NPT | 160 |
| | 42 | 1 1/2-11.5 NPT | 34.0 | 68.5 | 26.0 | 50 | 60 | 662 | EGE42L11/2NPT | 160 |
| S ⁴⁾ | 06 | 1/4-18 NPT | 2.5 | 37.5 | 14.5 | 14 | 17 | 42 | EGE06S1/4NPT | 630 |
| | 08 | 1/4-18 NPT | 4.0 | 38.0 | 14.5 | 14 | 19 | 47 | EGE08S1/4NPT | 630 |
| | 10 | 3/8-18 NPT | 6.0 | 40.5 | 14.5 | 19 | 22 | 75 | EGE10S3/8NPT | 630 |
| | 12 | 3/8-18 NPT | 8.0 | 42.0 | 14.5 | 19 | 24 | 81 | EGE12S3/8NPT | 630 |
| | 16 | 1/2-14 NPT | 11.0 | 51.0 | 19.5 | 22 | 30 | 145 | EGE16S1/2NPT | 400 |
| | 20 | 3/4-14 NPT | 14.0 | 54.0 | 19.5 | 27 | 36 | 221 | EGE20S3/4NPT | 400 |
| | 25 | 1-11.5 NPT | 18.0 | 63.5 | 24.5 | 36 | 46 | 422 | EGE25S1NPT | 400 |
| | 30 | 1 1/4-11.5 NPT | 23.0 | 70.5 | 25.0 | 46 | 50 | 628 | EGE30S11/4NPT | 400 |
| | 38 | 1 1/2-11.5 NPT | 30.0 | 73.5 | 26.0 | 50 | 60 | 770 | EGE38S11/2NPT | 315 |

1) Pressure shown = item deliverable

3) L = light series; 4) S = heavy series

 $\frac{PN \text{ (bar)}}{10} = PN \text{ (MPa)}$

Information on ordering alternative sealing materials see page 17.

| Order code suffixes | | | |
|---------------------------------|-----------------------------|----------------|---|
| Material | Suffix surface and material | Example | Standard sealing material (no additional suffix needed) |
| Steel, zinc plated, Cr(VI)-free | CF | EGE16S1/2NPTCF | NBR |

 *Please add the **suffixes** below according to the material/surface required.



EW-M-ED Assembled adjustable swivel elbow

EO 24° cone end / Male metric thread – ED-seal (ISO 9974)

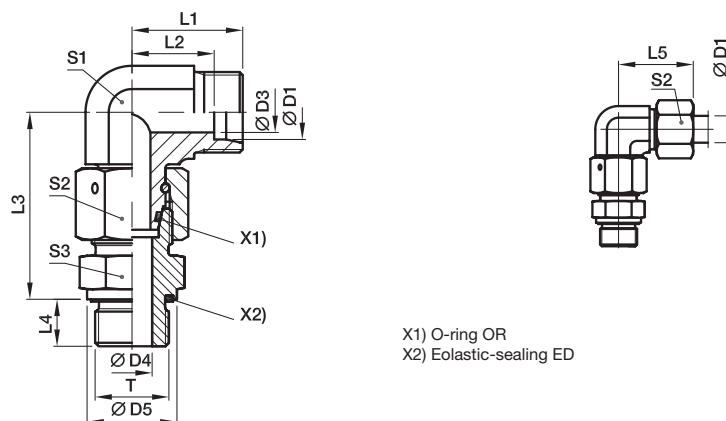

X1) O-ring OR
X2) Eolastic-sealing ED

| Series | D1 | T | D3 | D4 | D5 | L1 | L2 | L3 | L4 | L5 | S1 | S2 | S3 | Weight g/1 piece | Order code* | PN (bar) ¹⁾ | |
|-----------------|----|----------|----|----|----|----|------|------|----|----|----|----|----|---------------------|--------------------|------------------------|-----|
| | | | | | | | | | | | | | | | | CF | 71 |
| L ³⁾ | 06 | M 10×1.0 | 4 | 4 | 14 | 19 | 12.0 | 34.5 | 8 | 27 | 12 | 14 | 14 | 47 | EW06LMEDOMD | 500 | 315 |
| | 08 | M 12×1.5 | 6 | 6 | 17 | 21 | 14.0 | 37.5 | 12 | 29 | 12 | 17 | 17 | 69 | EW08LMEDOMD | 500 | 315 |
| | 10 | M 14×1.5 | 8 | 7 | 19 | 22 | 15.0 | 40.0 | 12 | 30 | 14 | 19 | 19 | 87 | EW10LMEDOMD | 500 | 315 |
| | 12 | M 16×1.5 | 10 | 9 | 22 | 24 | 17.0 | 42.0 | 12 | 32 | 17 | 22 | 22 | 111 | EW12LMEDOMD | 400 | 315 |
| | 15 | M 18×1.5 | 12 | 11 | 24 | 28 | 21.0 | 46.0 | 12 | 36 | 19 | 27 | 24 | 179 | EW15LMEDOMD | 400 | 315 |
| | 18 | M 22×1.5 | 15 | 14 | 27 | 31 | 23.5 | 50.0 | 14 | 40 | 24 | 32 | 27 | 272 | EW18LMEDOMD | 400 | 315 |
| | 22 | M 26×1.5 | 19 | 18 | 32 | 35 | 27.5 | 55.0 | 16 | 44 | 27 | 36 | 32 | 360 | EW22LMEDOMD | 250 | 160 |
| | 28 | M 33×2.0 | 24 | 23 | 40 | 38 | 30.5 | 59.0 | 18 | 47 | 36 | 41 | 41 | 538 | EW28LMEDOMD | 250 | 160 |
| | 35 | M 42×2.0 | 30 | 30 | 50 | 45 | 34.5 | 68.5 | 20 | 56 | 41 | 50 | 50 | 843 | EW35LMEDOMD | 250 | 160 |
| | 42 | M 48×2.0 | 36 | 36 | 55 | 51 | 40.0 | 75.0 | 22 | 63 | 50 | 60 | 55 | 1353 | EW42LMEDOMD | 250 | 160 |
| S ⁴⁾ | 06 | M 12×1.5 | 4 | 4 | 17 | 23 | 16.0 | 40.0 | 12 | 31 | 12 | 17 | 17 | 77 | EW06SMEDOMD | 800 | 630 |
| | 08 | M 14×1.5 | 5 | 5 | 19 | 24 | 17.0 | 42.5 | 12 | 32 | 14 | 19 | 19 | 107 | EW08SMEDOMD | 800 | 630 |
| | 10 | M 16×1.5 | 6 | 7 | 22 | 25 | 17.5 | 45.0 | 12 | 34 | 17 | 22 | 22 | 146 | EW10SMEDOMD | 800 | 630 |
| | 12 | M 18×1.5 | 8 | 8 | 24 | 29 | 21.5 | 48.0 | 12 | 38 | 17 | 24 | 24 | 178 | EW12SMEDOMD | 630 | 630 |
| | 16 | M 22×1.5 | 12 | 12 | 27 | 33 | 24.5 | 55.0 | 14 | 43 | 24 | 30 | 27 | 307 | EW16SMEDOMD | 630 | 400 |
| | 20 | M 27×2.0 | 16 | 16 | 32 | 37 | 26.5 | 65.0 | 16 | 48 | 27 | 36 | 32 | 459 | EW20SMEDOMD | 420 | 400 |
| | 25 | M 33×2.0 | 20 | 20 | 40 | 42 | 30.0 | 73.0 | 18 | 54 | 36 | 46 | 41 | 812 | EW25SMEDOMD | 420 | 400 |
| | 30 | M 42×2.0 | 25 | 25 | 50 | 49 | 35.5 | 78.5 | 20 | 62 | 41 | 50 | 50 | 1167 | EW30SMEDOMD | 420 | 400 |
| | 38 | M 48×2.0 | 32 | 32 | 55 | 57 | 41.0 | 89.0 | 22 | 72 | 50 | 60 | 55 | 1790 | EW38SMEDOMD | 420 | 315 |

¹⁾ Pressure shown = item deliverable

³⁾ L = light series; ⁴⁾ S = heavy series

$\frac{PN(\text{bar})}{10} = PN(\text{MPa})$

Delivery without nut and ring. Information on ordering complete fittings or alternative sealing materials see page 17.

| Order code suffixes | | | |
|---------------------------------|-----------------------------|---------------|---|
| Material | Suffix surface and material | Example | Standard sealing material (no additional suffix needed) |
| Steel, zinc plated, Cr(VI)-free | CF | EW16SMEDOMDCF | NBR |
| Stainless Steel | 71 | EW16SMEDOMD71 | VIT |

*Please add the **suffixes** below according to the material/surface required.

EW-R-ED Assembled adjustable swivel elbow

EO 24° cone end / Male BSPP thread – ED-seal (ISO 1179)

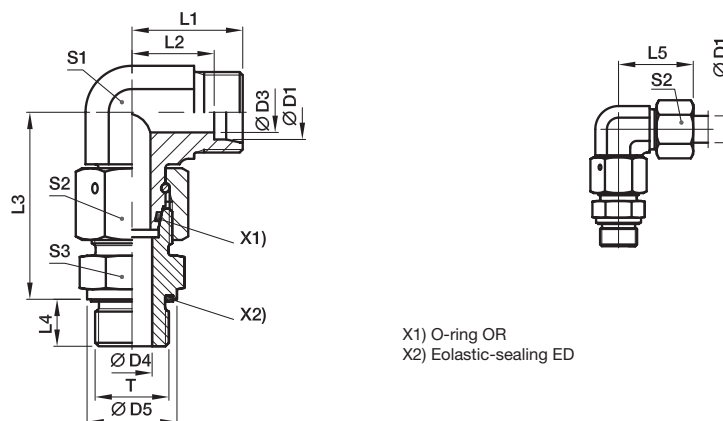

| Series | D1 | T | D3 | D4 | D5 | L1 | L2 | L3 | L4 | L5 | S1 | S2 | S3 | Weight g/1 piece | Order code* | PN (bar) ¹⁾ | |
|-----------------|----|-----------|----|----|----|----|------|------|----|----|----|----|----|---------------------|--------------------|------------------------|-----|
| | | | | | | | | | | | | | | | | CF | 71 |
| L ³⁾ | 06 | G 1/8 A | 4 | 4 | 14 | 19 | 12.0 | 34.5 | 8 | 27 | 12 | 14 | 14 | 47 | EW06LREDOMD | 500 | 315 |
| | 08 | G 1/4 A | 6 | 6 | 19 | 21 | 14.0 | 37.5 | 12 | 29 | 12 | 17 | 19 | 69 | EW08LREDOMD | 500 | 315 |
| | 10 | G 1/4 A | 8 | 6 | 19 | 22 | 15.0 | 40.0 | 12 | 30 | 14 | 19 | 19 | 87 | EW10LREDOMD | 500 | 315 |
| | 12 | G 3/8 A | 10 | 9 | 22 | 24 | 17.0 | 42.0 | 12 | 32 | 17 | 22 | 22 | 122 | EW12LREDOMD | 400 | 315 |
| | 15 | G 1/2 A | 12 | 11 | 27 | 28 | 21.0 | 46.5 | 14 | 36 | 19 | 27 | 27 | 199 | EW15LREDOMD | 400 | 315 |
| | 18 | G 1/2 A | 15 | 14 | 27 | 31 | 23.5 | 50.0 | 14 | 40 | 24 | 32 | 27 | 268 | EW18LREDOMD | 400 | 315 |
| | 22 | G 3/4 A | 19 | 18 | 32 | 35 | 27.5 | 55.0 | 16 | 44 | 27 | 36 | 32 | 360 | EW22LREDOMD | 250 | 160 |
| | 28 | G 1 A | 24 | 23 | 40 | 38 | 30.5 | 59.0 | 18 | 47 | 36 | 41 | 41 | 539 | EW28LREDOMD | 250 | 160 |
| | 35 | G 1 1/4 A | 30 | 30 | 50 | 45 | 34.5 | 68.5 | 20 | 56 | 41 | 50 | 50 | 834 | EW35LREDOMD | 250 | 160 |
| | 42 | G 1 1/2 A | 36 | 36 | 55 | 51 | 40.0 | 75.0 | 22 | 63 | 50 | 60 | 55 | 1341 | EW42LREDOMD | 250 | 160 |
| S ⁴⁾ | 06 | G 1/4 A | 4 | 4 | 19 | 23 | 16.0 | 40.0 | 12 | 31 | 12 | 17 | 19 | 83 | EW06SREDOMD | 800 | 630 |
| | 08 | G 1/4 A | 5 | 5 | 19 | 24 | 17.0 | 42.5 | 12 | 32 | 14 | 19 | 19 | 106 | EW08SREDOMD | 800 | 630 |
| | 10 | G 3/8 A | 6 | 7 | 22 | 25 | 17.5 | 45.0 | 12 | 34 | 17 | 22 | 22 | 148 | EW10SREDOMD | 800 | 630 |
| | 12 | G 3/8 A | 8 | 8 | 22 | 29 | 21.5 | 48.0 | 12 | 38 | 17 | 24 | 22 | 170 | EW12SREDOMD | 630 | 630 |
| | 16 | G 1/2 A | 12 | 12 | 27 | 33 | 24.5 | 55.0 | 14 | 43 | 24 | 30 | 27 | 303 | EW16SREDOMD | 630 | 400 |
| | 20 | G 3/4 A | 16 | 16 | 32 | 37 | 26.5 | 65.0 | 16 | 48 | 27 | 36 | 32 | 458 | EW20SREDOMD | 420 | 400 |
| | 25 | G 1 A | 20 | 20 | 40 | 42 | 30.0 | 73.0 | 18 | 54 | 36 | 46 | 41 | 813 | EW25SREDOMD | 420 | 400 |
| | 30 | G 1 1/4 A | 25 | 25 | 50 | 49 | 35.5 | 78.5 | 20 | 62 | 41 | 50 | 50 | 1163 | EW30SREDOMD | 420 | 400 |
| | 38 | G 1 1/2 A | 32 | 32 | 55 | 57 | 41.0 | 89.0 | 22 | 72 | 50 | 60 | 55 | 1784 | EW38SREDOMD | 420 | 315 |

1) Pressure shown = item deliverable

3) L = light series; 4) S = heavy series

PN (bar)
10 = PN (MPa)

Delivery without nut and ring. Information on ordering complete fittings or alternative sealing materials see page 17.

| Order code suffixes | | | |
|---------------------------------|-----------------------------|---------------|---|
| Material | Suffix surface and material | Example | Standard sealing material (no additional suffix needed) |
| Steel, zinc plated, Cr(VI)-free | CF | EW16SREDOMDCF | NBR |
| Stainless Steel | 71 | EW16SREDOMD71 | VIT |

*Please add the **suffixes** below according to the material/surface required.

EV-M-ED Assembled adjustable swivel 45° elbow

EO 24° cone end / Male metric thread – ED-seal (ISO 9974)

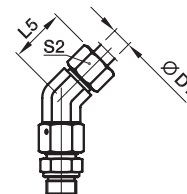
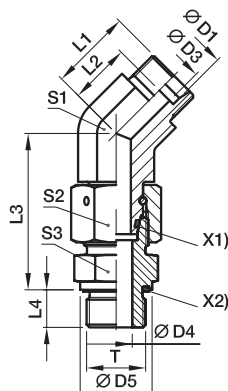
 X1) O-ring OR
 X2) Eolastic-sealing ED

| Series | D1 | T | D3 | D4 | D5 | L1 | L2 | L3 | L4 | L5 | S1 | S2 | S3 | Weight g/1 piece | Order code* | PN (bar) ¹⁾ | |
|-----------------|----|----------|----|----|----|------|------|------|----|----|----|----|----|---------------------|--------------------|------------------------|-----|
| | | | | | | | | | | | | | | | | CF | 71 |
| L ³⁾ | 06 | M 10×1.0 | 4 | 4 | 14 | 16.0 | 9.0 | 34.5 | 8 | 24 | 14 | 14 | 14 | 44 | EV06LMEDOMD | 315 | 315 |
| | 08 | M 12×1.5 | 6 | 6 | 17 | 19.0 | 12.0 | 37.5 | 12 | 27 | 14 | 17 | 17 | 62 | EV08LMEDOMD | 315 | 315 |
| | 10 | M 14×1.5 | 8 | 7 | 19 | 19.0 | 12.0 | 40.0 | 12 | 27 | 19 | 19 | 19 | 80 | EV10LMEDOMD | 315 | 315 |
| | 12 | M 16×1.5 | 10 | 9 | 22 | 21.0 | 14.0 | 42.0 | 12 | 29 | 19 | 22 | 22 | 110 | EV12LMEDOMD | 315 | 315 |
| | 15 | M 18×1.5 | 12 | 11 | 24 | 24.0 | 17.0 | 46.0 | 12 | 32 | 22 | 27 | 24 | 171 | EV15LMEDOMD | 315 | 315 |
| | 18 | M 22×1.5 | 15 | 14 | 27 | 24.0 | 16.5 | 50.0 | 14 | 33 | 27 | 32 | 27 | 245 | EV18LMEDOMD | 315 | 315 |
| | 22 | M 26×1.5 | 19 | 18 | 32 | 26.0 | 18.5 | 55.0 | 16 | 35 | 30 | 36 | 32 | 339 | EV22LMEDOMD | 160 | 160 |
| | 28 | M 33×2.0 | 24 | 23 | 40 | 30.5 | 23.0 | 59.0 | 18 | 40 | 36 | 41 | 41 | 517 | EV28LMEDOMD | 160 | 160 |
| | 35 | M 42×2.0 | 30 | 30 | 50 | 37.0 | 26.5 | 68.5 | 20 | 48 | 50 | 50 | 50 | 810 | EV35LMEDOMD | 160 | 160 |
| | 42 | M 48×2.0 | 36 | 36 | 55 | 37.0 | 26.0 | 75.0 | 22 | 49 | 50 | 60 | 55 | 1193 | EV42LMEDOMD | 160 | 160 |
| S ⁴⁾ | 06 | M 12×1.5 | 4 | 4 | 17 | 16.0 | 9.0 | 40.0 | 12 | 24 | 14 | 17 | 17 | 72 | EV06SMEDOMD | 630 | 630 |
| | 08 | M 14×1.5 | 5 | 5 | 19 | 19.0 | 12.0 | 42.5 | 12 | 27 | 19 | 19 | 19 | 102 | EV08SMEDOMD | 630 | 630 |
| | 10 | M 16×1.5 | 7 | 7 | 22 | 21.0 | 13.5 | 45.0 | 12 | 30 | 19 | 22 | 22 | 132 | EV10SMEDOMD | 630 | 630 |
| | 12 | M 18×1.5 | 8 | 8 | 24 | 24.0 | 16.5 | 48.0 | 12 | 33 | 22 | 24 | 24 | 173 | EV12SMEDOMD | 630 | 630 |
| | 16 | M 22×1.5 | 12 | 12 | 27 | 24.0 | 15.5 | 55.0 | 14 | 34 | 27 | 30 | 27 | 284 | EV16SMEDOMD | 400 | 400 |
| | 20 | M 27×2.0 | 16 | 16 | 32 | 26.5 | 16.0 | 65.0 | 16 | 38 | 30 | 36 | 32 | 435 | EV20SMEDOMD | 400 | 400 |
| | 25 | M 33×2.0 | 20 | 20 | 40 | 30.5 | 18.5 | 73.0 | 18 | 43 | 36 | 46 | 41 | 790 | EV25SMEDOMD | 400 | 400 |
| | 30 | M 42×2.0 | 25 | 25 | 50 | 37.0 | 23.5 | 78.5 | 20 | 50 | 50 | 50 | 50 | 1132 | EV30SMEDOMD | 400 | 400 |
| | 38 | M 48×2.0 | 32 | 32 | 55 | 37.0 | 21.0 | 89.0 | 22 | 52 | 50 | 60 | 55 | 1631 | EV38SMEDOMD | 315 | 315 |

1) Pressure shown = item deliverable

3) L = light series; 4) S = heavy series

 $\frac{\text{PN (bar)}}{10} = \text{PN (MPa)}$
Delivery without nut and ring. Information on ordering complete fittings or alternative sealing materials see page 17.

| Order code suffixes | | | |
|---------------------------------|-----------------------------|---------------|---|
| Material | Suffix surface and material | Example | Standard sealing material (no additional suffix needed) |
| Steel, zinc plated, Cr(VI)-free | CF | EV16SMEDOMDCF | NBR |
| Stainless Steel | 71 | EV16SMEDOMD71 | VIT |

 *Please add the **suffixes** below according to the material/surface required.

EV-R-ED Assembled adjustable swivel 45° elbow

EO 24° cone end / Male BSPP thread – ED-seal (ISO 1179)

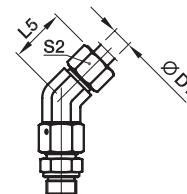
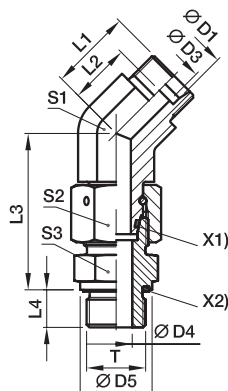

X1) O-ring OR
X2) Eolastic-sealing ED

| Series | D1 | T | D3 | D4 | D5 | L1 | L2 | L3 | L4 | L5 | S1 | S2 | S3 | Weight g/1 piece | Order code* | PN (bar) ¹⁾ | |
|-----------------|-----------|-----------|----|----|------|------|------|------|----|----|----|----|------|---------------------|--------------------|------------------------|-----|
| | | | | | | | | | | | | | | | | CF | 71 |
| L ³⁾ | 06 | G 1/8 A | 4 | 4 | 14 | 16.0 | 9.0 | 34.5 | 8 | 24 | 14 | 14 | 14 | 44 | EV06LREDOMD | 315 | 315 |
| | 08 | G 1/4 A | 6 | 6 | 19 | 19.0 | 12.0 | 37.5 | 12 | 27 | 14 | 17 | 19 | 67 | EV08LREDOMD | 315 | 315 |
| | 10 | G 1/4 A | 8 | 6 | 19 | 19.0 | 12.0 | 40.0 | 12 | 27 | 19 | 19 | 19 | 78 | EV10LREDOMD | 315 | 315 |
| | 12 | G 3/8 A | 10 | 9 | 22 | 21.0 | 14.0 | 42.0 | 12 | 29 | 19 | 22 | 22 | 112 | EV12LREDOMD | 315 | 315 |
| | 15 | G 1/2 A | 12 | 11 | 27 | 24.0 | 17.0 | 46.5 | 14 | 32 | 22 | 27 | 27 | 192 | EV15LREDOMD | 315 | 315 |
| | 18 | G 1/2 A | 15 | 14 | 27 | 24.0 | 16.5 | 50.0 | 14 | 33 | 27 | 32 | 27 | 242 | EV18LREDOMD | 315 | 315 |
| | 22 | G 3/4 A | 19 | 18 | 32 | 26.0 | 18.5 | 55.0 | 16 | 35 | 30 | 36 | 32 | 338 | EV22LREDOMD | 160 | 160 |
| | 28 | G 1 A | 24 | 23 | 40 | 30.5 | 23.0 | 59.0 | 18 | 40 | 36 | 41 | 41 | 518 | EV28LREDOMD | 160 | 160 |
| | 35 | G 1 1/4 A | 30 | 30 | 50 | 37.0 | 26.5 | 68.5 | 20 | 48 | 50 | 50 | 50 | 801 | EV35LREDOMD | 160 | 160 |
| 42 | G 1 1/2 A | 36 | 36 | 55 | 37.0 | 26.0 | 75.0 | 22 | 49 | 50 | 60 | 55 | 1181 | EV42LREDOMD | 160 | 160 | |
| S ⁴⁾ | 06 | G 1/4 A | 4 | 4 | 19 | 16.0 | 9.0 | 40.0 | 12 | 24 | 14 | 17 | 19 | 78 | EV06SREDOMD | 630 | 630 |
| | 08 | G 1/4 A | 5 | 5 | 19 | 19.0 | 12.0 | 42.5 | 12 | 27 | 19 | 19 | 19 | 101 | EV08SREDOMD | 630 | 630 |
| | 10 | G 3/8 A | 7 | 7 | 22 | 21.0 | 13.5 | 45.0 | 12 | 30 | 19 | 22 | 22 | 134 | EV10SREDOMD | 630 | 630 |
| | 12 | G 3/8 A | 8 | 8 | 22 | 24.0 | 16.5 | 48.0 | 12 | 33 | 22 | 24 | 22 | 165 | EV12SREDOMD | 630 | 630 |
| | 16 | G 1/2 A | 12 | 12 | 27 | 24.0 | 15.5 | 55.0 | 14 | 34 | 27 | 30 | 27 | 280 | EV16SREDOMD | 400 | 400 |
| | 20 | G 3/4 A | 16 | 16 | 32 | 26.5 | 16.0 | 65.0 | 16 | 38 | 30 | 36 | 32 | 434 | EV20SREDOMD | 400 | 400 |
| | 25 | G 1 A | 20 | 20 | 40 | 30.5 | 18.5 | 73.0 | 18 | 43 | 36 | 46 | 41 | 792 | EV25SREDOMD | 400 | 400 |
| | 30 | G 1 1/4 A | 25 | 25 | 50 | 37.0 | 23.5 | 78.5 | 20 | 50 | 50 | 50 | 50 | 1128 | EV30SREDOMD | 400 | 400 |
| | 38 | G 1 1/2 A | 32 | 32 | 55 | 37.0 | 21.0 | 89.0 | 22 | 52 | 50 | 60 | 55 | 1625 | EV38SREDOMD | 315 | 315 |

¹⁾ Pressure shown = item deliverable

³⁾ L = light series; ⁴⁾ S = heavy series

PN (bar) = PN (MPa) / 10

Delivery without nut and ring. Information on ordering complete fittings or alternative sealing materials see page 17.

*Please add the **suffixes** below according to the material/surface required.

| Order code suffixes | | | |
|---------------------------------|-----------------------------|---------------|---|
| Material | Suffix surface and material | Example | Standard sealing material (no additional suffix needed) |
| Steel, zinc plated, Cr(VI)-free | CF | EV16SREDOMDCF | NBR |
| Stainless Steel | 71 | EV16SREDOMD71 | VIT |

ET-M-ED Assembled adjustable swivel branch tee

EO 24° cone end / Male metric thread – ED-seal (ISO 9974)

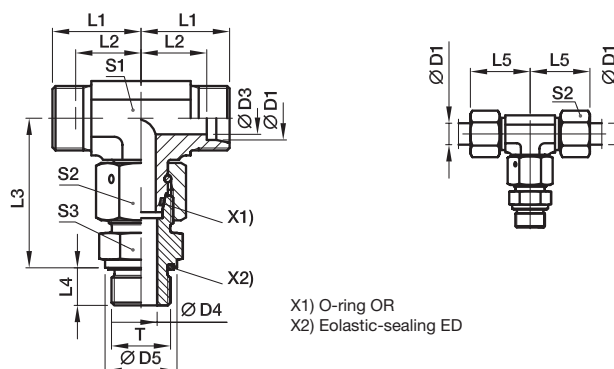

| Series | D1 | T | D3 | D4 | D5 | L1 | L2 | L3 | L4 | L5 | S1 | S2 | S3 | Weight g/1 piece | Order code* | PN (bar) ¹⁾ | |
|-----------------|----|----------|----|----|----|----|------|------|----|----|----|----|----|---------------------|--------------------|------------------------|-----|
| | | | | | | | | | | | | | | | | CF | 71 |
| L ³⁾ | 06 | M 10×1.0 | 4 | 4 | 14 | 19 | 12.0 | 34.5 | 8 | 27 | 12 | 14 | 14 | 55 | ET06LMEDOMD | 500 | 315 |
| | 08 | M 12×1.5 | 6 | 6 | 17 | 21 | 14.0 | 37.5 | 12 | 29 | 12 | 17 | 17 | 75 | ET08LMEDOMD | 500 | 315 |
| | 10 | M 14×1.5 | 8 | 7 | 19 | 22 | 15.0 | 40.0 | 12 | 30 | 14 | 19 | 19 | 98 | ET10LMEDOMD | 500 | 315 |
| | 12 | M 16×1.5 | 10 | 9 | 22 | 24 | 17.0 | 42.0 | 12 | 32 | 17 | 22 | 22 | 135 | ET12LMEDOMD | 400 | 315 |
| | 15 | M 18×1.5 | 12 | 11 | 24 | 28 | 21.0 | 46.0 | 12 | 36 | 19 | 27 | 24 | 203 | ET15LMEDOMD | 400 | 315 |
| | 18 | M 22×1.5 | 15 | 14 | 27 | 31 | 23.5 | 50.0 | 14 | 40 | 24 | 32 | 27 | 310 | ET18LMEDOMD | 400 | 315 |
| | 22 | M 26×1.5 | 19 | 18 | 32 | 35 | 27.5 | 55.0 | 16 | 44 | 27 | 36 | 32 | 377 | ET22LMEDOMD | 250 | 160 |
| | 28 | M 33×2.0 | 24 | 23 | 40 | 38 | 30.5 | 59.0 | 18 | 47 | 36 | 41 | 41 | 607 | ET28LMEDOMD | 250 | 160 |
| | 35 | M 42×2.0 | 30 | 30 | 50 | 45 | 34.5 | 68.5 | 20 | 56 | 41 | 50 | 50 | 929 | ET35LMEDOMD | 250 | 160 |
| | 42 | M 48×2.0 | 36 | 36 | 55 | 51 | 40.0 | 75.0 | 22 | 63 | 50 | 60 | 55 | 1478 | ET42LMEDOMD | 250 | 160 |
| S ⁴⁾ | 06 | M 12×1.5 | 4 | 4 | 17 | 23 | 16.0 | 40.0 | 12 | 31 | 12 | 17 | 17 | 92 | ET06SMEDOMD | 800 | 630 |
| | 08 | M 14×1.5 | 5 | 5 | 19 | 24 | 17.0 | 42.5 | 12 | 32 | 14 | 19 | 19 | 126 | ET08SMEDOMD | 800 | 630 |
| | 10 | M 16×1.5 | 6 | 7 | 22 | 25 | 17.5 | 45.0 | 12 | 34 | 17 | 22 | 22 | 167 | ET10SMEDOMD | 800 | 630 |
| | 12 | M 18×1.5 | 8 | 8 | 24 | 29 | 21.5 | 48.0 | 12 | 38 | 17 | 24 | 24 | 207 | ET12SMEDOMD | 630 | 630 |
| | 16 | M 22×1.5 | 12 | 12 | 27 | 33 | 24.5 | 55.0 | 14 | 43 | 24 | 30 | 27 | 352 | ET16SMEDOMD | 630 | 400 |
| | 20 | M 27×2.0 | 16 | 16 | 32 | 37 | 26.5 | 65.0 | 16 | 48 | 27 | 36 | 32 | 498 | ET20SMEDOMD | 420 | 400 |
| | 25 | M 33×2.0 | 20 | 20 | 40 | 42 | 30.0 | 73.0 | 18 | 54 | 36 | 46 | 41 | 916 | ET25SMEDOMD | 420 | 400 |
| | 30 | M 42×2.0 | 25 | 25 | 50 | 49 | 35.5 | 78.5 | 20 | 62 | 41 | 50 | 50 | 1328 | ET30SMEDOMD | 420 | 400 |
| | 38 | M 48×2.0 | 32 | 32 | 55 | 57 | 41.0 | 89.0 | 22 | 72 | 50 | 60 | 55 | 2031 | ET38SMEDOMD | 420 | 315 |

1) Pressure shown = item deliverable

3) L = light series; 4) S = heavy series

$$\frac{\text{PN (bar)}}{10} = \text{PN (MPa)}$$
Delivery without nut and ring. Information on ordering complete fittings or alternative sealing materials see page 17.

| Order code suffixes | | | |
|---------------------------------|-----------------------------|---------------|---|
| Material | Suffix surface and material | Example | Standard sealing material (no additional suffix needed) |
| Steel, zinc plated, Cr(VI)-free | CF | ET16SMEDOMDCF | NBR |
| Stainless Steel | 71 | ET16SMEDOMD71 | VIT |

 *Please add the **suffixes** below according to the material/surface required.

DIN fittings

ET-R-ED Assembled adjustable swivel branch tee

EO 24° cone end / Male BSPP thread – ED-seal (ISO 1179)

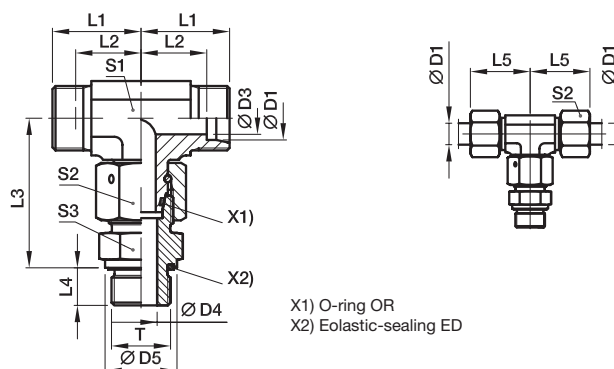

| Series | D1 | T | D3 | D4 | D5 | L1 | L2 | L3 | L4 | L5 | S1 | S2 | S3 | Weight g/1 piece | Order code* | PN (bar) ¹⁾ | |
|-----------------|-----------|-----------|----|----|----|------|------|------|----|----|----|----|------|---------------------|--------------------|------------------------|-----|
| | | | | | | | | | | | | | | | | CF | 71 |
| L ³⁾ | 06 | G 1/8 A | 4 | 4 | 14 | 19 | 12.0 | 34.5 | 8 | 27 | 12 | 14 | 14 | 55 | ET06LREDOMD | 500 | 315 |
| | 08 | G 1/4 A | 6 | 6 | 19 | 21 | 14.0 | 37.5 | 12 | 29 | 12 | 17 | 19 | 80 | ET08LREDOMD | 500 | 315 |
| | 10 | G 1/4 A | 8 | 6 | 19 | 22 | 15.0 | 40.0 | 12 | 30 | 14 | 19 | 19 | 98 | ET10LREDOMD | 500 | 315 |
| | 12 | G 3/8 A | 10 | 9 | 22 | 24 | 17.0 | 42.0 | 12 | 32 | 17 | 22 | 22 | 136 | ET12LREDOMD | 400 | 315 |
| | 15 | G 1/2 A | 12 | 11 | 27 | 28 | 21.0 | 46.5 | 14 | 36 | 19 | 27 | 27 | 224 | ET15LREDOMD | 400 | 315 |
| | 18 | G 1/2 A | 15 | 14 | 27 | 31 | 23.5 | 50.0 | 14 | 40 | 24 | 32 | 27 | 306 | ET18LREDOMD | 400 | 315 |
| | 22 | G 3/4 A | 19 | 18 | 32 | 35 | 27.5 | 55.0 | 16 | 44 | 27 | 36 | 32 | 423 | ET22LREDOMD | 250 | 160 |
| | 28 | G 1 A | 24 | 23 | 40 | 38 | 30.5 | 59.0 | 18 | 47 | 36 | 41 | 41 | 608 | ET28LREDOMD | 250 | 160 |
| | 35 | G 1 1/4 A | 30 | 30 | 50 | 45 | 34.5 | 68.5 | 20 | 56 | 41 | 50 | 50 | 920 | ET35LREDOMD | 250 | 160 |
| 42 | G 1 1/2 A | 36 | 36 | 55 | 51 | 40.0 | 75.0 | 22 | 63 | 50 | 60 | 55 | 1466 | ET42LREDOMD | 250 | 160 | |
| S ⁴⁾ | 06 | G 1/4 A | 4 | 4 | 19 | 23 | 16.0 | 40.0 | 12 | 31 | 12 | 17 | 19 | 98 | ET06SREDOMD | 800 | 630 |
| | 08 | G 1/4 A | 5 | 5 | 19 | 24 | 17.0 | 42.5 | 12 | 32 | 14 | 19 | 19 | 125 | ET08SREDOMD | 800 | 630 |
| | 10 | G 3/8 A | 6 | 7 | 22 | 25 | 17.5 | 45.0 | 12 | 34 | 17 | 22 | 22 | 169 | ET10SREDOMD | 800 | 630 |
| | 12 | G 3/8 A | 8 | 8 | 22 | 29 | 21.5 | 48.0 | 12 | 38 | 17 | 24 | 22 | 198 | ET12SREDOMD | 630 | 630 |
| | 16 | G 1/2 A | 12 | 12 | 27 | 33 | 24.5 | 55.0 | 14 | 43 | 24 | 30 | 27 | 348 | ET16SREDOMD | 630 | 400 |
| | 20 | G 3/4 A | 16 | 16 | 32 | 37 | 26.5 | 65.0 | 16 | 48 | 27 | 36 | 32 | 498 | ET20SREDOMD | 420 | 400 |
| | 25 | G 1 A | 20 | 20 | 40 | 42 | 30.0 | 73.0 | 18 | 54 | 36 | 46 | 41 | 918 | ET25SREDOMD | 420 | 400 |
| | 30 | G 1 1/4 A | 25 | 25 | 50 | 49 | 35.5 | 78.5 | 20 | 62 | 41 | 50 | 50 | 1324 | ET30SREDOMD | 420 | 400 |
| | 38 | G 1 1/2 A | 32 | 32 | 55 | 57 | 41.0 | 89.0 | 22 | 72 | 50 | 60 | 55 | 2025 | ET38SREDOMD | 420 | 315 |

1) Pressure shown = item deliverable

3) L = light series; 4) S = heavy series

 $\frac{\text{PN (bar)}}{10} = \text{PN (MPa)}$

Delivery without nut and ring. Information on ordering complete fittings or alternative sealing materials see page 17.

 *Please add the **suffixes** below according to the material/surface required

| Order code suffixes | | | |
|---------------------------------|-----------------------------|---------------|---|
| Material | Suffix surface and material | Example | Standard sealing material (no additional suffix needed) |
| Steel, zinc plated, Cr(VI)-free | CF | ET16SREDOMDCF | NBR |
| Stainless Steel | 71 | ET16SREDOMD71 | VIT |



EL-M-ED Assembled adjustable swivel run tee

EO 24° cone end / Male metric thread – ED-seal (ISO 9974)

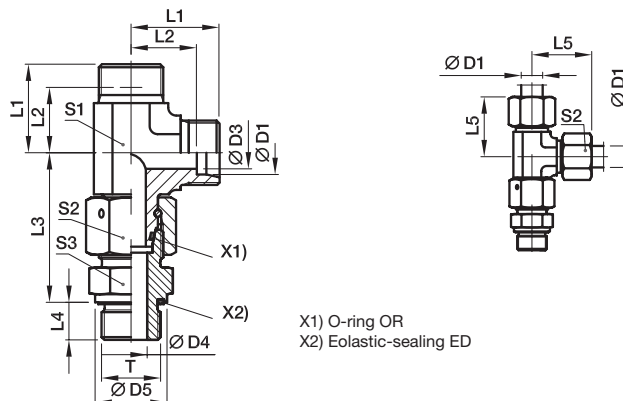

| Series | D1 | T | D3 | D4 | D5 | L1 | L2 | L3 | L4 | L5 | S1 | S2 | S3 | Weight g/1 piece | Order code* | PN (bar) ¹⁾ | |
|-----------------|----|----------|----|----|----|----|------|------|----|----|----|----|----|---------------------|--------------------|------------------------|-----|
| | | | | | | | | | | | | | | | | CF | 71 |
| L ³⁾ | 06 | M 10×1.0 | 4 | 4 | 14 | 19 | 12.0 | 34.5 | 8 | 27 | 12 | 14 | 14 | 55 | EL06LMEDOMD | 500 | 315 |
| | 08 | M 12×1.5 | 6 | 6 | 17 | 21 | 14.0 | 37.5 | 12 | 29 | 12 | 17 | 17 | 75 | EL08LMEDOMD | 500 | 315 |
| | 10 | M 14×1.5 | 8 | 7 | 19 | 22 | 15.0 | 40.0 | 12 | 30 | 14 | 19 | 19 | 97 | EL10LMEDOMD | 500 | 315 |
| | 12 | M 16×1.5 | 10 | 9 | 22 | 24 | 17.0 | 42.0 | 12 | 32 | 17 | 22 | 22 | 135 | EL12LMEDOMD | 400 | 315 |
| | 15 | M 18×1.5 | 12 | 11 | 24 | 28 | 21.0 | 46.0 | 12 | 36 | 19 | 27 | 24 | 201 | EL15LMEDOMD | 400 | 315 |
| | 18 | M 22×1.5 | 15 | 14 | 27 | 31 | 23.5 | 50.0 | 14 | 40 | 24 | 32 | 27 | 308 | EL18LMEDOMD | 400 | 315 |
| | 22 | M 26×1.5 | 19 | 18 | 32 | 35 | 27.5 | 55.0 | 16 | 44 | 27 | 36 | 32 | 404 | EL22LMEDOMD | 250 | 160 |
| | 28 | M 33×2.0 | 24 | 23 | 40 | 38 | 30.5 | 59.0 | 18 | 47 | 36 | 41 | 41 | 605 | EL28LMEDOMD | 250 | 160 |
| | 35 | M 42×2.0 | 30 | 30 | 50 | 45 | 34.5 | 68.5 | 20 | 56 | 41 | 50 | 50 | 947 | EL35LMEDOMD | 250 | 160 |
| | 42 | M 48×2.0 | 36 | 36 | 55 | 51 | 40.0 | 75.0 | 22 | 63 | 50 | 60 | 55 | 1497 | EL42LMEDOMD | 250 | 160 |
| S ⁴⁾ | 06 | M 12×1.5 | 4 | 4 | 17 | 23 | 16.0 | 40.0 | 12 | 31 | 12 | 17 | 17 | 91 | EL06SMEDOMD | 800 | 630 |
| | 08 | M 14×1.5 | 5 | 5 | 19 | 24 | 17.0 | 42.5 | 12 | 32 | 14 | 19 | 19 | 126 | EL08SMEDOMD | 800 | 630 |
| | 10 | M 16×1.5 | 6 | 7 | 22 | 25 | 17.5 | 45.0 | 12 | 34 | 17 | 22 | 22 | 169 | EL10SMEDOMD | 800 | 630 |
| | 12 | M 18×1.5 | 8 | 8 | 24 | 29 | 21.5 | 48.0 | 12 | 38 | 17 | 24 | 24 | 206 | EL12SMEDOMD | 630 | 630 |
| | 16 | M 22×1.5 | 12 | 12 | 27 | 33 | 24.5 | 55.0 | 14 | 43 | 24 | 30 | 27 | 354 | EL16SMEDOMD | 630 | 400 |
| | 20 | M 27×2.0 | 16 | 16 | 32 | 37 | 26.5 | 65.0 | 16 | 48 | 27 | 36 | 32 | 526 | EL20SMEDOMD | 420 | 400 |
| | 25 | M 33×2.0 | 20 | 20 | 40 | 42 | 30.0 | 73.0 | 18 | 54 | 36 | 46 | 41 | 919 | EL25SMEDOMD | 420 | 400 |
| | 30 | M 42×2.0 | 25 | 25 | 50 | 49 | 35.5 | 78.5 | 20 | 62 | 41 | 50 | 50 | 1328 | EL30SMEDOMD | 420 | 400 |
| | 38 | M 48×2.0 | 32 | 32 | 55 | 57 | 41.0 | 89.0 | 22 | 72 | 50 | 60 | 55 | 2039 | EL38SMEDOMD | 420 | 315 |

¹⁾ Pressure shown = item deliverable

³⁾ L = light series; ⁴⁾ S = heavy series

$\frac{PN \text{ (bar)}}{10} = PN \text{ (MPa)}$

Delivery without nut and ring. Information on ordering complete fittings or alternative sealing materials see page 17.

| Order code suffixes | | | |
|---------------------------------|-----------------------------|---------------|---|
| Material | Suffix surface and material | Example | Standard sealing material (no additional suffix needed) |
| Steel, zinc plated, Cr(VI)-free | CF | EL16SMEDOMDCF | NBR |
| Stainless Steel | 71 | EL16SMEDOMD71 | VIT |

*Please add the **suffixes** below according to the material/surface required.



EL-R-ED Assembled adjustable swivel run tee

EO 24° cone end / Male BSPP thread – ED-seal (ISO 1179)

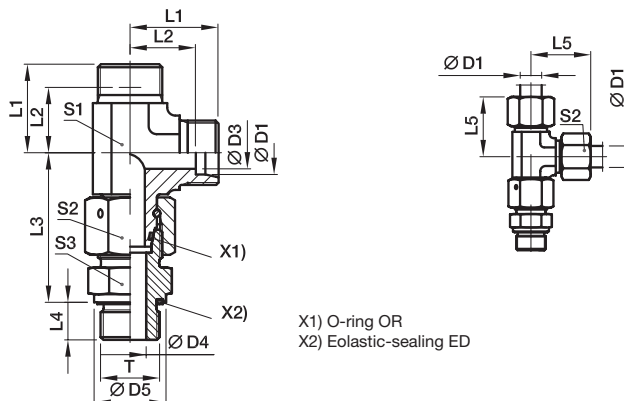

| Series | D1 | T | D3 | D4 | D5 | L1 | L2 | L3 | L4 | L5 | S1 | S2 | S3 | Weight g/1 piece | Order code* | PN (bar) ¹⁾ | |
|-----------------|----|-----------|----|----|----|----|------|------|----|----|----|----|----|---------------------|-------------|------------------------|-----|
| | | | | | | | | | | | | | | | | CF | 71 |
| L ³⁾ | 06 | G 1/8 A | 4 | 4 | 14 | 19 | 12.0 | 34.5 | 8 | 27 | 12 | 14 | 14 | 55 | EL06LREDOMD | 500 | 315 |
| | 08 | G 1/4 A | 6 | 6 | 19 | 21 | 14.0 | 37.5 | 12 | 29 | 12 | 17 | 19 | 80 | EL08LREDOMD | 500 | 315 |
| | 10 | G 1/4 A | 8 | 6 | 19 | 22 | 15.0 | 40.0 | 12 | 30 | 14 | 19 | 19 | 97 | EL10LREDOMD | 500 | 315 |
| | 12 | G 3/8 A | 10 | 9 | 22 | 24 | 17.0 | 42.0 | 12 | 32 | 17 | 22 | 22 | 137 | EL12LREDOMD | 400 | 315 |
| | 15 | G 1/2 A | 12 | 11 | 27 | 28 | 21.0 | 46.5 | 14 | 36 | 19 | 27 | 27 | 222 | EL15LREDOMD | 400 | 315 |
| | 18 | G 1/2 A | 15 | 14 | 27 | 31 | 23.5 | 50.0 | 14 | 40 | 24 | 32 | 27 | 304 | EL18LREDOMD | 400 | 315 |
| | 22 | G 3/4 A | 19 | 18 | 32 | 35 | 27.5 | 55.0 | 16 | 44 | 27 | 36 | 32 | 404 | EL22LREDOMD | 250 | 160 |
| | 28 | G 1 A | 24 | 23 | 40 | 38 | 30.5 | 59.0 | 18 | 47 | 36 | 41 | 41 | 606 | EL28LREDOMD | 250 | 160 |
| | 35 | G 1 1/4 A | 30 | 30 | 50 | 45 | 34.5 | 68.5 | 20 | 56 | 41 | 50 | 50 | 938 | EL35LREDOMD | 250 | 160 |
| | 42 | G 1 1/2 A | 36 | 36 | 55 | 51 | 40.0 | 75.0 | 22 | 63 | 50 | 60 | 55 | 1485 | EL42LREDOMD | 250 | 160 |
| S ⁴⁾ | 06 | G 1/4 A | 4 | 4 | 19 | 23 | 16.0 | 40.0 | 12 | 31 | 12 | 17 | 19 | 97 | EL06SREDOMD | 800 | 630 |
| | 08 | G 1/4 A | 5 | 5 | 19 | 24 | 17.0 | 42.5 | 12 | 32 | 14 | 19 | 19 | 125 | EL08SREDOMD | 800 | 630 |
| | 10 | G 3/8 A | 6 | 7 | 22 | 25 | 17.5 | 45.0 | 12 | 34 | 17 | 22 | 22 | 171 | EL10SREDOMD | 800 | 630 |
| | 12 | G 3/8 A | 8 | 8 | 22 | 29 | 21.5 | 48.0 | 12 | 38 | 17 | 24 | 22 | 198 | EL12SREDOMD | 630 | 630 |
| | 16 | G 1/2 A | 12 | 12 | 27 | 33 | 24.5 | 55.0 | 14 | 43 | 24 | 30 | 27 | 350 | EL16SREDOMD | 630 | 400 |
| | 20 | G 3/4 A | 16 | 16 | 32 | 37 | 26.5 | 65.0 | 16 | 48 | 27 | 36 | 32 | 524 | EL20SREDOMD | 420 | 400 |
| | 25 | G 1 A | 20 | 20 | 40 | 42 | 30.0 | 73.0 | 18 | 54 | 36 | 46 | 41 | 921 | EL25SREDOMD | 420 | 400 |
| | 30 | G 1 1/4 A | 25 | 25 | 50 | 49 | 35.5 | 78.5 | 20 | 62 | 41 | 50 | 50 | 1324 | EL30SREDOMD | 420 | 400 |
| | 38 | G 1 1/2 A | 32 | 32 | 55 | 57 | 41.0 | 89.0 | 22 | 72 | 50 | 60 | 55 | 2033 | EL38SREDOMD | 420 | 315 |

1) Pressure shown = item deliverable

3) L = light series; 4) S = heavy series

PN (bar) = PN (MPa) / 10

Delivery without nut and ring. Information on ordering complete fittings or alternative sealing materials see page 17.

| Order code suffixes | | | |
|---------------------------------|-----------------------------|---------------|---|
| Material | Suffix surface and material | Example | Standard sealing material (no additional suffix needed) |
| Steel, zinc plated, Cr(VI)-free | CF | EL16SREDOMDCF | NBR |
| Stainless Steel | 71 | EL16SREDOMD71 | VIT |

*Please add the suffixes below according to the material/surface required.



EVW-M Assembled adjustable standpipe elbow

EO 24° cone end / Male metric thread – metal sealing edge (ISO 9974)

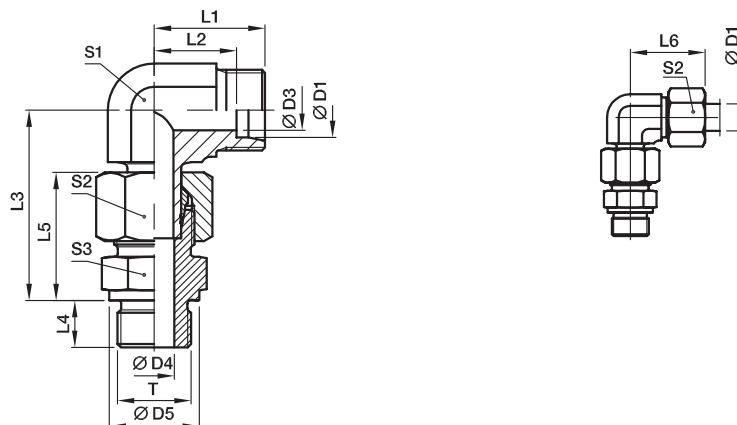

Pre-assembled, complete with straight male stud connector (with cutting face DIN 3852, type B). Final assembly (in appropriate body) at least 1/4 turn beyond the point of clearly perceptible resistance.

| Series | D1 | T | D3 | D4 | D5 | L1 | L2 | L3 | L4 | L5 | L6 | S1 | S2 | S3 | Weight g/1 piece | Order code* | PN (bar) ¹⁾ | |
|-----------------|----|----------|----|----|----|----|------|------|----|----|----|----|----|----|---------------------|-------------|------------------------|-----|
| | | | | | | | | | | | | | | | | | CF | 71 |
| L ³⁾ | 06 | M 10×1.0 | 4 | 4 | 14 | 19 | 12.0 | 34.5 | 8 | 23 | 27 | 12 | 14 | 14 | 41 | EVW06LMOMD | 315 | 315 |
| | 08 | M 12×1.5 | 6 | 6 | 17 | 21 | 14.0 | 37.5 | 12 | 25 | 29 | 12 | 17 | 17 | 63 | EVW08LMOMD | 315 | 315 |
| | 10 | M 14×1.5 | 8 | 7 | 19 | 22 | 15.0 | 40.0 | 12 | 26 | 30 | 14 | 19 | 19 | 83 | EVW10LMOMD | 315 | 315 |
| | 12 | M 16×1.5 | 10 | 9 | 21 | 24 | 17.0 | 42.0 | 12 | 27 | 32 | 17 | 22 | 22 | 107 | EVW12LMOMD | 315 | 315 |
| | 15 | M 18×1.5 | 12 | 11 | 23 | 28 | 21.0 | 46.0 | 12 | 29 | 36 | 19 | 27 | 24 | 170 | EVW15LMOMD | 250 | 250 |
| | 18 | M 22×1.5 | 15 | 14 | 27 | 31 | 23.5 | 50.0 | 14 | 31 | 40 | 24 | 32 | 27 | 265 | EVW18LMOMD | 250 | 250 |
| | 22 | M 26×1.5 | 19 | 18 | 31 | 35 | 27.5 | 55.0 | 16 | 33 | 44 | 27 | 36 | 32 | 355 | EVW22LMOMD | 160 | 160 |
| | 28 | M 33×2.0 | 24 | 23 | 39 | 38 | 30.5 | 59.5 | 18 | 34 | 47 | 36 | 41 | 41 | 514 | EVW28LMOMD | 160 | 160 |
| | 35 | M 42×2.0 | 30 | 30 | 49 | 45 | 34.5 | 68.5 | 20 | 39 | 56 | 41 | 50 | 50 | 791 | EVW35LMOMD | 160 | 160 |
| | 42 | M 48×2.0 | 36 | 36 | 55 | 51 | 40.0 | 79.0 | 22 | 42 | 63 | 50 | 60 | 55 | 1153 | EVW42LMOMD | 160 | 160 |
| S ⁴⁾ | 06 | M 12×1.5 | 4 | 4 | 17 | 23 | 16.0 | 40.0 | 12 | 28 | 31 | 12 | 17 | 17 | 73 | EVW06SMOMD | 400 | 400 |
| | 08 | M 14×1.5 | 5 | 5 | 19 | 24 | 17.0 | 42.5 | 12 | 30 | 32 | 14 | 19 | 19 | 100 | EVW08SMOMD | 400 | 400 |
| | 10 | M 16×1.5 | 7 | 7 | 21 | 25 | 17.5 | 46.0 | 12 | 31 | 34 | 17 | 22 | 22 | 133 | EVW10SMOMD | 400 | 400 |
| | 12 | M 18×1.5 | 8 | 8 | 23 | 29 | 21.5 | 48.0 | 12 | 33 | 38 | 17 | 24 | 24 | 174 | EVW12SMOMD | 400 | 400 |
| | 16 | M 22×1.5 | 12 | 12 | 27 | 33 | 24.5 | 56.0 | 14 | 37 | 43 | 24 | 30 | 27 | 309 | EVW16SMOMD | 400 | 400 |
| | 20 | M 27×2.0 | 16 | 16 | 32 | 37 | 26.5 | 65.0 | 16 | 42 | 48 | 27 | 36 | 32 | 429 | EVW20SMOMD | 400 | 400 |
| | 25 | M 33×2.0 | 20 | 20 | 39 | 42 | 30.0 | 73.0 | 18 | 47 | 54 | 36 | 46 | 41 | 826 | EVW25SMOMD | 250 | 250 |
| | 30 | M 42×2.0 | 25 | 25 | 49 | 49 | 35.5 | 78.5 | 20 | 50 | 62 | 41 | 50 | 50 | 1132 | EVW30SMOMD | 160 | 160 |
| | 38 | M 48×2.0 | 32 | 32 | 55 | 57 | 41.0 | 92.5 | 22 | 57 | 72 | 50 | 60 | 55 | 1874 | EVW38SMOMD | 160 | 160 |

¹⁾ Pressure shown = item deliverable

³⁾ L = light series; ⁴⁾ S = heavy series

$\frac{\text{PN (bar)}}{10} = \text{PN (MPa)}$

Delivery without nut and ring. Information on ordering complete fittings see page I7.

*Please add the **suffixes** below according to the material/surface required.

| Order code suffixes | | |
|---------------------------------|-----------------------------|--------------|
| Material | Suffix surface and material | Example |
| Steel, zinc plated, Cr(VI)-free | CF | EVW16SMOMDCF |
| Stainless Steel | 71 | EVW16SMOMD71 |

EVW-R Assembled adjustable standpipe elbow

EO 24° cone end / Male BSPP thread – metal sealing edge (ISO 1179)

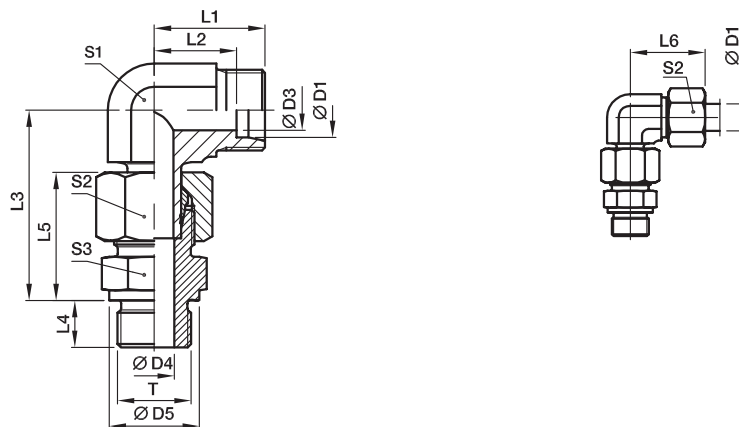

Pre-assembled, complete with straight male stud connector (with cutting face DIN 3852, type B). Final assembly (in appropriate body) at least 1/4 turn beyond the point of clearly perceptible resistance.

| Series | D1 | T | D3 | D4 | D5 | L1 | L2 | L3 | L4 | L5 | L6 | S1 | S2 | S3 | Weight g/1 piece | Order code* | PN (bar) ¹⁾ | |
|-----------------|----|-----------|----|----|----|----|------|------|----|----|----|----|----|----|---------------------|-------------------|------------------------|-----|
| | | | | | | | | | | | | | | | | | CF | 71 |
| L ³⁾ | 06 | G 1/8 A | 4 | 4 | 14 | 19 | 12.0 | 34.5 | 8 | 23 | 27 | 12 | 14 | 14 | 47 | EVW06LROMD | 315 | 315 |
| | 08 | G 1/4 A | 6 | 6 | 18 | 21 | 14.0 | 37.5 | 12 | 25 | 29 | 12 | 17 | 19 | 68 | EVW08LROMD | 315 | 315 |
| | 10 | G 1/4 A | 8 | 6 | 18 | 22 | 15.0 | 40.0 | 12 | 26 | 30 | 14 | 19 | 19 | 84 | EVW10LROMD | 315 | 315 |
| | 12 | G 3/8 A | 10 | 9 | 22 | 24 | 17.0 | 42.0 | 12 | 27 | 32 | 17 | 22 | 22 | 118 | EVW12LROMD | 315 | 315 |
| | 15 | G 1/2 A | 12 | 11 | 26 | 28 | 21.0 | 46.5 | 14 | 29 | 36 | 19 | 27 | 27 | 191 | EVW15LROMD | 250 | 250 |
| | 18 | G 1/2 A | 15 | 14 | 26 | 31 | 23.5 | 50.0 | 14 | 31 | 40 | 24 | 32 | 27 | 260 | EVW18LROMD | 250 | 250 |
| | 22 | G 3/4 A | 19 | 18 | 32 | 35 | 27.5 | 55.0 | 16 | 33 | 44 | 27 | 36 | 32 | 355 | EVW22LROMD | 160 | 160 |
| | 28 | G 1 A | 24 | 23 | 39 | 38 | 30.5 | 59.5 | 18 | 34 | 47 | 36 | 41 | 41 | 542 | EVW28LROMD | 160 | 160 |
| | 35 | G 1 1/4 A | 30 | 30 | 49 | 45 | 34.5 | 68.5 | 20 | 39 | 56 | 41 | 50 | 50 | 832 | EVW35LROMD | 160 | 160 |
| | 42 | G 1 1/2 A | 36 | 36 | 55 | 51 | 40.0 | 79.0 | 22 | 42 | 63 | 50 | 60 | 55 | 1303 | EVW42LROMD | 160 | 160 |
| S ⁴⁾ | 06 | G 1/4 A | 4 | 4 | 18 | 23 | 16.0 | 40.0 | 12 | 28 | 31 | 12 | 17 | 19 | 79 | EVW06SROMD | 400 | 400 |
| | 08 | G 1/4 A | 5 | 5 | 18 | 24 | 17.0 | 42.5 | 12 | 30 | 32 | 14 | 19 | 19 | 98 | EVW08SROMD | 400 | 400 |
| | 10 | G 3/8 A | 7 | 7 | 22 | 25 | 17.5 | 46.0 | 12 | 31 | 34 | 17 | 22 | 22 | 148 | EVW10SROMD | 400 | 400 |
| | 12 | G 3/8 A | 8 | 8 | 22 | 29 | 21.5 | 48.0 | 12 | 33 | 38 | 17 | 24 | 22 | 169 | EVW12SROMD | 400 | 400 |
| | 16 | G 1/2 A | 12 | 12 | 26 | 33 | 24.5 | 56.0 | 14 | 37 | 43 | 24 | 30 | 27 | 304 | EVW16SROMD | 400 | 400 |
| | 20 | G 3/4 A | 16 | 16 | 32 | 37 | 26.5 | 65.0 | 16 | 42 | 48 | 27 | 36 | 32 | 428 | EVW20SROMD | 400 | 400 |
| | 25 | G 1 A | 20 | 20 | 39 | 42 | 30.0 | 73.0 | 18 | 47 | 54 | 36 | 46 | 41 | 825 | EVW25SROMD | 250 | 250 |
| | 30 | G 1 1/4 A | 25 | 25 | 49 | 49 | 35.5 | 78.5 | 20 | 50 | 62 | 41 | 50 | 50 | 1134 | EVW30SROMD | 160 | 160 |
| | 38 | G 1 1/2 A | 32 | 32 | 55 | 57 | 41.0 | 92.5 | 22 | 57 | 72 | 50 | 60 | 55 | 1713 | EVW38SROMD | 160 | 160 |

1) Pressure shown = item deliverable

3) L = light series; 4) S = heavy series

PN (bar) = PN (MPa) / 10

Delivery without nut and ring. Information on ordering complete fittings see page I7.

*Please add the suffixes below according to the material/surface required.

| Order code suffixes | | |
|---------------------------------|-----------------------------|--------------|
| Material | Suffix surface and material | Example |
| Steel, zinc plated, Cr(VI)-free | CF | EVW16SROMDCF |
| Stainless Steel | 71 | EVW16SROMD71 |



EVT-M Assembled adjustable standpipe branch tee

EO 24° cone end / Male metric thread – metal sealing edge (ISO 9974)

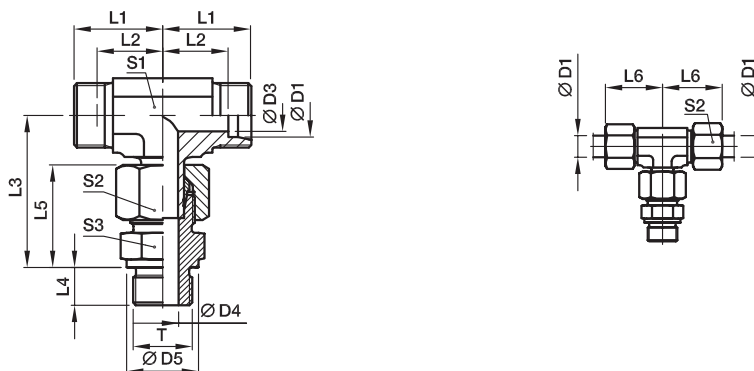

Pre-assembled, complete with straight male stud connector (with cutting face). Final assembly (in appropriate body) at least 1/4 turn beyond the point of clearly perceptible resistance.

| Series | D1 | T | D3 | D4 | D5 | L1 | L2 | L3 | L4 | L5 | L6 | S1 | S2 | S3 | Weight g/1 piece | Order code* | PN (bar) ¹⁾ | |
|-----------------|----|----------|----|----|----|----|------|------|----|----|----|----|----|----|---------------------|-------------------|------------------------|-----|
| | | | | | | | | | | | | | | | | | CF | 71 |
| L ³⁾ | 06 | M 10×1.0 | 4 | 4 | 14 | 19 | 12.0 | 34.5 | 8 | 23 | 27 | 12 | 14 | 14 | 48 | EVT06LMOMD | 315 | 315 |
| | 08 | M 12×1.5 | 6 | 6 | 17 | 21 | 14.0 | 37.5 | 12 | 25 | 29 | 12 | 17 | 17 | 68 | EVT08LMOMD | 315 | 315 |
| | 10 | M 14×1.5 | 8 | 7 | 19 | 22 | 15.0 | 40.0 | 12 | 26 | 30 | 14 | 19 | 19 | 88 | EVT10LMOMD | 315 | 315 |
| | 12 | M 16×1.5 | 10 | 9 | 21 | 24 | 17.0 | 43.0 | 12 | 27 | 32 | 17 | 22 | 22 | 116 | EVT12LMOMD | 315 | 315 |
| | 15 | M 18×1.5 | 12 | 11 | 23 | 28 | 21.0 | 46.0 | 12 | 29 | 36 | 19 | 27 | 24 | 185 | EVT15LMOMD | 250 | 250 |
| | 18 | M 22×1.5 | 15 | 14 | 27 | 31 | 23.5 | 50.0 | 14 | 31 | 40 | 24 | 32 | 27 | 272 | EVT18LMOMD | 250 | 250 |
| | 22 | M 26×1.5 | 19 | 18 | 31 | 35 | 27.5 | 55.5 | 16 | 33 | 44 | 27 | 36 | 32 | 367 | EVT22LMOMD | 160 | 160 |
| | 28 | M 33×2.0 | 24 | 23 | 39 | 38 | 30.5 | 61.0 | 18 | 34 | 47 | 36 | 41 | 41 | 565 | EVT28LMOMD | 160 | 160 |
| | 35 | M 42×2.0 | 30 | 30 | 49 | 45 | 34.5 | 72.0 | 20 | 39 | 56 | 41 | 50 | 50 | 905 | EVT35LMOMD | 160 | 160 |
| | 42 | M 48×2.0 | 36 | 36 | 55 | 51 | 40.0 | 79.0 | 22 | 42 | 63 | 50 | 60 | 55 | 1282 | EVT42LMOMD | 160 | 160 |
| S ⁴⁾ | 06 | M 12×1.5 | 4 | 4 | 17 | 23 | 16.0 | 40.0 | 12 | 28 | 31 | 12 | 17 | 17 | 85 | EVT06SMOMD | 400 | 400 |
| | 08 | M 14×1.5 | 5 | 5 | 19 | 24 | 17.0 | 44.0 | 12 | 30 | 32 | 14 | 19 | 19 | 118 | EVT08SMOMD | 400 | 400 |
| | 10 | M 16×1.5 | 7 | 7 | 21 | 25 | 17.5 | 47.0 | 12 | 31 | 34 | 17 | 22 | 22 | 149 | EVT10SMOMD | 400 | 400 |
| | 12 | M 18×1.5 | 8 | 8 | 23 | 29 | 21.5 | 50.0 | 12 | 33 | 38 | 17 | 24 | 24 | 200 | EVT12SMOMD | 400 | 400 |
| | 16 | M 22×1.5 | 12 | 12 | 27 | 33 | 24.5 | 55.0 | 14 | 37 | 43 | 24 | 30 | 27 | 327 | EVT16SMOMD | 400 | 400 |
| | 20 | M 27×2.0 | 16 | 16 | 32 | 37 | 26.5 | 65.0 | 16 | 42 | 48 | 27 | 36 | 32 | 482 | EVT20SMOMD | 400 | 400 |
| | 25 | M 33×2.0 | 20 | 20 | 39 | 42 | 30.0 | 73.5 | 18 | 47 | 54 | 36 | 46 | 41 | 906 | EVT25SMOMD | 250 | 250 |
| | 30 | M 42×2.0 | 25 | 25 | 49 | 49 | 35.5 | 80.0 | 20 | 50 | 62 | 41 | 50 | 50 | 1274 | EVT30SMOMD | 160 | 160 |
| | 38 | M 48×2.0 | 32 | 32 | 55 | 57 | 41.0 | 92.5 | 22 | 57 | 72 | 50 | 60 | 55 | 1928 | EVT38SMOMD | 160 | 160 |

¹⁾ Pressure shown = item deliverable

³⁾ L = light series; ⁴⁾ S = heavy series

$\frac{\text{PN (bar)}}{10} = \text{PN (MPa)}$

Delivery without nut and ring. Information on ordering complete fittings see page I7.

*Please add the **suffixes** below according to the material/surface required.

| Order code suffixes | | |
|---------------------------------|-----------------------------|--------------|
| Material | Suffix surface and material | Example |
| Steel, zinc plated, Cr(VI)-free | CF | EVT16SMOMDCF |
| Stainless Steel | 71 | EVT16SMOMD71 |

DIN fittings

EVT-R Assembled adjustable standpipe branch tee

EO 24° cone end / Male BSPP thread – metal sealing edge (ISO 1179)

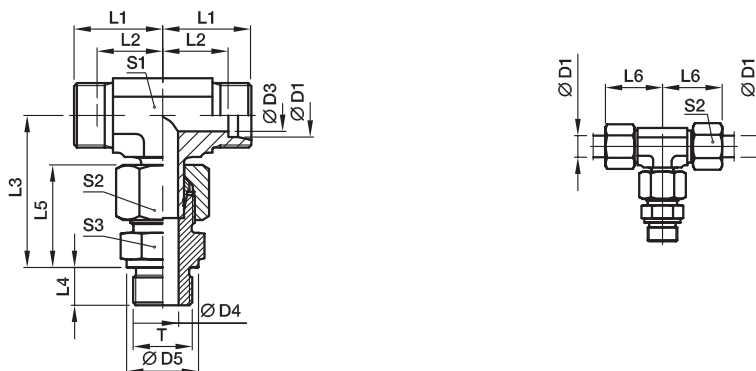

Pre-assembled, complete with straight male stud connector (with cutting face). Final assembly (in appropriate body) at least 1/4 turn beyond the point of clearly perceptible resistance.

| Series | D1 | T | D3 | D4 | D5 | L1 | L2 | L3 | L4 | L5 | L6 | S1 | S2 | S3 | Weight g/1 piece | Order code* | PN (bar) ¹⁾ | |
|-----------------|----|-----------|----|----|----|----|------|------|----|----|----|----|----|----|---------------------|-------------------|------------------------|-----|
| | | | | | | | | | | | | | | | | | CF | 71 |
| L ³⁾ | 06 | G 1/8 A | 4 | 4 | 14 | 19 | 12.0 | 34.5 | 8 | 23 | 27 | 12 | 14 | 14 | 48 | EVT06LROMD | 315 | 315 |
| | 08 | G 1/4 A | 6 | 6 | 18 | 21 | 14.0 | 37.5 | 12 | 25 | 29 | 12 | 17 | 19 | 73 | EVT08LROMD | 315 | 315 |
| | 10 | G 1/4 A | 8 | 6 | 18 | 22 | 15.0 | 40.0 | 12 | 26 | 30 | 14 | 19 | 19 | 85 | EVT10LROMD | 315 | 315 |
| | 12 | G 3/8 A | 10 | 9 | 22 | 24 | 17.0 | 43.0 | 12 | 27 | 32 | 17 | 22 | 22 | 118 | EVT12LROMD | 315 | 315 |
| | 15 | G 1/2 A | 12 | 11 | 26 | 28 | 21.0 | 46.5 | 14 | 29 | 36 | 19 | 27 | 27 | 206 | EVT15LROMD | 250 | 250 |
| | 18 | G 1/2 A | 15 | 14 | 26 | 31 | 23.5 | 50.0 | 14 | 31 | 40 | 24 | 32 | 27 | 267 | EVT18LROMD | 250 | 250 |
| | 22 | G 3/4 A | 19 | 18 | 32 | 35 | 27.5 | 55.5 | 16 | 33 | 44 | 27 | 36 | 32 | 367 | EVT22LROMD | 160 | 160 |
| | 28 | G 1 A | 24 | 23 | 39 | 38 | 30.5 | 61.0 | 18 | 34 | 47 | 36 | 41 | 41 | 565 | EVT28LROMD | 160 | 160 |
| | 35 | G 1 1/4 A | 30 | 30 | 49 | 45 | 34.5 | 72.0 | 20 | 39 | 56 | 41 | 50 | 50 | 901 | EVT35LROMD | 160 | 160 |
| | 42 | G 1 1/2 A | 36 | 36 | 55 | 51 | 40.0 | 79.0 | 22 | 42 | 63 | 50 | 60 | 55 | 1277 | EVT42LROMD | 160 | 160 |
| S ⁴⁾ | 06 | G 1/4 A | 4 | 4 | 18 | 23 | 16.0 | 40.0 | 12 | 28 | 31 | 12 | 17 | 19 | 90 | EVT06SROMD | 400 | 400 |
| | 08 | G 1/4 A | 5 | 5 | 18 | 24 | 17.0 | 44.0 | 12 | 30 | 32 | 14 | 19 | 19 | 116 | EVT08SROMD | 400 | 400 |
| | 10 | G 3/8 A | 7 | 7 | 22 | 25 | 17.5 | 47.0 | 12 | 31 | 34 | 17 | 22 | 22 | 151 | EVT10SROMD | 400 | 400 |
| | 12 | G 3/8 A | 8 | 8 | 22 | 29 | 21.5 | 50.0 | 12 | 33 | 38 | 17 | 24 | 22 | 190 | EVT12SROMD | 400 | 400 |
| | 16 | G 1/2 A | 12 | 12 | 26 | 33 | 24.5 | 55.0 | 14 | 37 | 43 | 24 | 30 | 27 | 322 | EVT16SROMD | 400 | 400 |
| | 20 | G 3/4 A | 16 | 16 | 32 | 37 | 26.5 | 65.0 | 16 | 42 | 48 | 27 | 36 | 32 | 500 | EVT20SROMD | 400 | 400 |
| | 25 | G 1 A | 20 | 20 | 39 | 42 | 30.0 | 73.5 | 18 | 47 | 54 | 36 | 46 | 41 | 905 | EVT25SROMD | 250 | 250 |
| | 30 | G 1 1/4 A | 25 | 25 | 49 | 49 | 35.5 | 80.0 | 20 | 50 | 62 | 41 | 50 | 50 | 1275 | EVT30SROMD | 160 | 160 |
| | 38 | G 1 1/2 A | 32 | 32 | 55 | 57 | 41.0 | 92.5 | 22 | 57 | 72 | 50 | 60 | 55 | 1920 | EVT38SROMD | 160 | 160 |

¹⁾ Pressure shown = item deliverable

³⁾ L = light series; ⁴⁾ S = heavy series

$\frac{\text{PN (bar)}}{10} = \text{PN (MPa)}$

Delivery without nut and ring. Information on ordering complete fittings see page I7.

*Please add the **suffixes** below according to the material/surface required.

| Order code suffixes | | |
|---------------------------------|-----------------------------|--------------|
| Material | Suffix surface and material | Example |
| Steel, zinc plated, Cr(VI)-free | CF | EVT16SROMDCF |
| Stainless Steel | 71 | EVT16SROMD71 |



EVL-M Assembled adjustable standpipe run tee

EO 24° cone end / Male metric thread – metal sealing edge (ISO 9974)

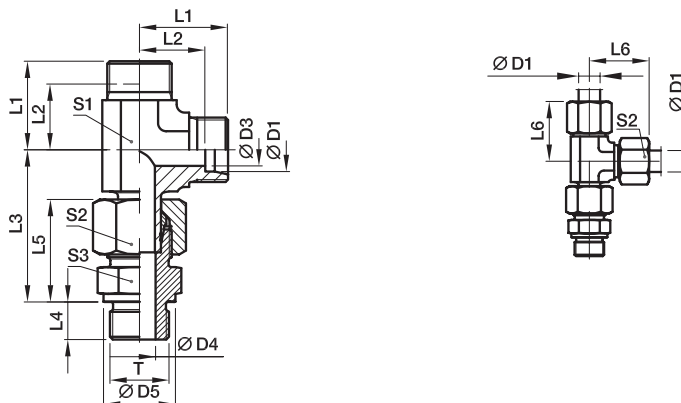

Pre-assembled, complete with straight male stud connector (with cutting face). Final assembly (in appropriate body) at least 1/4 turn beyond the point of clearly perceptible resistance.

| Series | D1 | T | D3 | D4 | D5 | L1 | L2 | L3 | L4 | L5 | L6 | S1 | S2 | S3 | Weight g/1 piece | Order code* | PN (bar) ¹⁾ | |
|-----------------|----|----------|----|----|----|----|------|------|----|----|----|----|----|----|---------------------|-------------------|------------------------|-----|
| | | | | | | | | | | | | | | | | | CF | 71 |
| L ³⁾ | 06 | M 10×1.0 | 4 | 4 | 14 | 19 | 12.0 | 34.5 | 8 | 23 | 27 | 12 | 14 | 14 | 48 | EVL06LMOMD | 315 | 315 |
| | 08 | M 12×1.5 | 6 | 6 | 17 | 21 | 14.0 | 37.5 | 12 | 25 | 29 | 12 | 17 | 17 | 73 | EVL08LMOMD | 315 | 315 |
| | 10 | M 14×1.5 | 8 | 7 | 19 | 22 | 15.0 | 40.0 | 12 | 26 | 30 | 14 | 19 | 19 | 89 | EVL10LMOMD | 315 | 315 |
| | 12 | M 16×1.5 | 10 | 9 | 21 | 24 | 17.0 | 43.0 | 12 | 27 | 32 | 17 | 22 | 22 | 118 | EVL12LMOMD | 315 | 315 |
| | 15 | M 18×1.5 | 12 | 11 | 23 | 28 | 21.0 | 46.0 | 12 | 29 | 36 | 19 | 27 | 24 | 186 | EVL15LMOMD | 250 | 250 |
| | 18 | M 22×1.5 | 15 | 14 | 27 | 31 | 23.5 | 50.0 | 14 | 31 | 40 | 24 | 32 | 27 | 269 | EVL18LMOMD | 250 | 250 |
| | 22 | M 26×1.5 | 19 | 18 | 31 | 35 | 27.5 | 55.5 | 16 | 33 | 44 | 27 | 36 | 32 | 364 | EVL22LMOMD | 160 | 160 |
| | 28 | M 33×2.0 | 24 | 23 | 39 | 38 | 30.5 | 61.0 | 18 | 34 | 47 | 36 | 41 | 41 | 556 | EVL28LMOMD | 160 | 160 |
| | 35 | M 42×2.0 | 30 | 30 | 49 | 45 | 34.5 | 72.0 | 20 | 39 | 56 | 41 | 50 | 50 | 900 | EVL35LMOMD | 160 | 160 |
| | 42 | M 48×2.0 | 36 | 36 | 55 | 51 | 40.0 | 79.0 | 22 | 42 | 63 | 50 | 60 | 55 | 1323 | EVL42LMOMD | 160 | 160 |
| S ⁴⁾ | 06 | M 12×1.5 | 4 | 4 | 17 | 23 | 16.0 | 40.0 | 12 | 28 | 31 | 12 | 17 | 17 | 85 | EVL06SMOMD | 400 | 400 |
| | 08 | M 14×1.5 | 5 | 5 | 19 | 24 | 17.0 | 44.0 | 12 | 30 | 32 | 14 | 19 | 19 | 119 | EVL08SMOMD | 400 | 400 |
| | 10 | M 16×1.5 | 7 | 7 | 21 | 25 | 17.5 | 47.0 | 12 | 31 | 34 | 17 | 22 | 22 | 151 | EVL10SMOMD | 400 | 400 |
| | 12 | M 18×1.5 | 8 | 8 | 23 | 29 | 21.5 | 50.0 | 12 | 33 | 38 | 17 | 24 | 24 | 202 | EVL12SMOMD | 400 | 400 |
| | 16 | M 22×1.5 | 12 | 12 | 27 | 33 | 24.5 | 56.0 | 14 | 37 | 43 | 24 | 30 | 27 | 326 | EVL16SMOMD | 400 | 400 |
| | 20 | M 27×2.0 | 16 | 16 | 32 | 37 | 26.5 | 65.0 | 16 | 42 | 48 | 27 | 36 | 32 | 481 | EVL20SMOMD | 400 | 400 |
| | 25 | M 33×2.0 | 20 | 20 | 39 | 42 | 30.0 | 73.5 | 18 | 47 | 54 | 36 | 46 | 41 | 904 | EVL25SMOMD | 250 | 250 |
| | 30 | M 42×2.0 | 25 | 25 | 49 | 49 | 35.5 | 80.0 | 20 | 50 | 62 | 41 | 50 | 50 | 1263 | EVL30SMOMD | 160 | 160 |
| | 38 | M 48×2.0 | 32 | 32 | 55 | 57 | 41.0 | 92.5 | 22 | 57 | 72 | 50 | 60 | 55 | 1936 | EVL38SMOMD | 160 | 160 |

¹⁾ Pressure shown = item deliverable

³⁾ L = light series; ⁴⁾ S = heavy series

$\frac{\text{PN (bar)}}{10} = \text{PN (MPa)}$

Delivery without nut and ring. Information on ordering complete fittings see page 17.

*Please add the **suffixes** below according to the material/surface required.

| Order code suffixes | | |
|---------------------------------|-----------------------------|--------------|
| Material | Suffix surface and material | Example |
| Steel, zinc plated, Cr(VI)-free | CF | EVL16SMOMDCF |
| Stainless Steel | 71 | EVL16SMOMD71 |

DIN fittings

EVL-R Assembled adjustable standpipe run tee

EO 24° cone end / Male BSPP thread – metal sealing edge (ISO 1179)

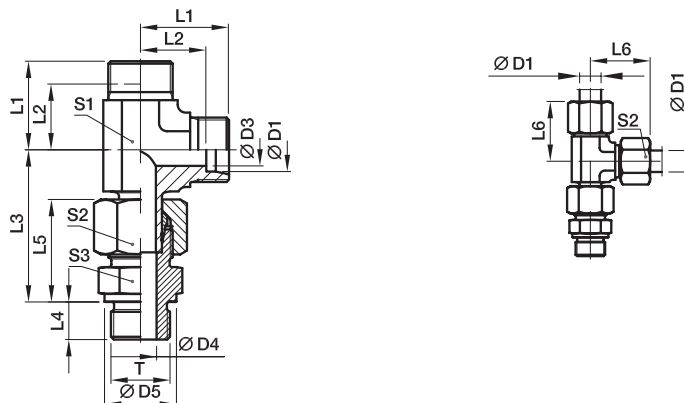

Pre-assembled, complete with straight male stud connector (with cutting face). Final assembly (in appropriate body) at least 1/4 turn beyond the point of clearly perceptible resistance.

| Series | D1 | T | D3 | D4 | D5 | L1 | L2 | L3 | L4 | L5 | L6 | S1 | S2 | S3 | Weight g/1 piece | Order code* | PN (bar) ¹⁾ | |
|-----------------|----|-----------|----|----|----|----|------|------|----|----|----|----|----|----|---------------------|-------------------|------------------------|-----|
| | | | | | | | | | | | | | | | | | CF | 71 |
| L ³⁾ | 06 | G 1/8 A | 4 | 4 | 14 | 19 | 12.0 | 34.5 | 8 | 23 | 27 | 12 | 14 | 14 | 48 | EVL06LROMD | 315 | 315 |
| | 08 | G 1/4 A | 6 | 6 | 18 | 21 | 14.0 | 37.5 | 12 | 25 | 29 | 12 | 17 | 19 | 73 | EVL08LROMD | 315 | 315 |
| | 10 | G 1/4 A | 8 | 6 | 18 | 22 | 15.0 | 40.0 | 12 | 26 | 30 | 14 | 19 | 19 | 87 | EVL10LROMD | 315 | 315 |
| | 12 | G 3/8 A | 10 | 9 | 22 | 24 | 17.0 | 43.0 | 12 | 27 | 32 | 17 | 22 | 22 | 120 | EVL12LROMD | 315 | 315 |
| | 15 | G 1/2 A | 12 | 11 | 26 | 28 | 21.0 | 46.5 | 14 | 29 | 36 | 19 | 27 | 27 | 207 | EVL15LROMD | 250 | 250 |
| | 18 | G 1/2 A | 15 | 14 | 26 | 31 | 23.5 | 50.0 | 14 | 31 | 40 | 24 | 32 | 27 | 264 | EVL18LROMD | 250 | 250 |
| | 22 | G 3/4 A | 19 | 18 | 32 | 35 | 27.5 | 55.5 | 16 | 33 | 44 | 27 | 36 | 32 | 365 | EVL22LROMD | 160 | 160 |
| | 28 | G 1 A | 24 | 23 | 39 | 38 | 30.5 | 61.0 | 18 | 34 | 47 | 36 | 41 | 41 | 556 | EVL28LROMD | 160 | 160 |
| | 35 | G 1 1/4 A | 30 | 30 | 49 | 45 | 34.5 | 72.0 | 20 | 39 | 56 | 41 | 50 | 50 | 895 | EVL35LROMD | 160 | 160 |
| | 42 | G 1 1/2 A | 36 | 36 | 55 | 51 | 40.0 | 79.0 | 22 | 42 | 63 | 50 | 60 | 55 | 1318 | EVL42LROMD | 160 | 160 |
| S ⁴⁾ | 06 | G 1/4 A | 4 | 4 | 18 | 23 | 16.0 | 40.0 | 12 | 28 | 31 | 12 | 17 | 19 | 90 | EVL06SROMD | 400 | 400 |
| | 08 | G 1/4 A | 5 | 5 | 18 | 24 | 17.0 | 44.0 | 12 | 30 | 32 | 14 | 19 | 19 | 117 | EVL08SROMD | 400 | 400 |
| | 10 | G 3/8 A | 7 | 7 | 22 | 25 | 17.5 | 47.0 | 12 | 31 | 34 | 17 | 22 | 22 | 153 | EVL10SROMD | 400 | 400 |
| | 12 | G 3/8 A | 8 | 8 | 22 | 29 | 21.5 | 50.0 | 12 | 33 | 38 | 17 | 24 | 22 | 192 | EVL12SROMD | 400 | 400 |
| | 16 | G 1/2 A | 12 | 12 | 26 | 33 | 24.5 | 56.0 | 14 | 37 | 43 | 24 | 30 | 27 | 321 | EVL16SROMD | 400 | 400 |
| | 20 | G 3/4 A | 16 | 16 | 32 | 37 | 26.5 | 65.0 | 16 | 42 | 48 | 27 | 36 | 32 | 480 | EVL20SROMD | 400 | 400 |
| | 25 | G 1 A | 20 | 20 | 39 | 42 | 30.0 | 73.5 | 18 | 47 | 54 | 36 | 46 | 41 | 903 | EVL25SROMD | 250 | 250 |
| | 30 | G 1 1/4 A | 25 | 25 | 49 | 49 | 35.5 | 80.0 | 20 | 50 | 62 | 41 | 50 | 50 | 1265 | EVL30SROMD | 160 | 160 |
| | 38 | G 1 1/2 A | 32 | 32 | 55 | 57 | 41.0 | 92.5 | 22 | 57 | 72 | 50 | 60 | 55 | 1928 | EVL38SROMD | 160 | 160 |

¹⁾ Pressure shown = item deliverable

³⁾ L = light series; ⁴⁾ S = heavy series

$\frac{\text{PN (bar)}}{10} = \text{PN (MPa)}$

Delivery without nut and ring. Information on ordering complete fittings see page I7.

*Please add the **suffixes** below according to the material/surface required.

| Order code suffixes | | |
|---------------------------------|-----------------------------|--------------|
| Material | Suffix surface and material | Example |
| Steel, zinc plated, Cr(VI)-free | CF | EVL16SROMDCF |
| Stainless Steel | 71 | EVL16SROMD71 |

WEE-R Adjustable locknut elbow

EO 24° cone end / Adjustable BSPP thread – O-ring + retaining ring (ISO 1179)

for ports with small or wide spot face;
differences in D5 in Stainless Steel are only for ports with wide spot face
(e.g. WEE16SRBOMD71)

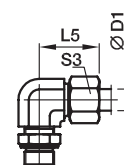
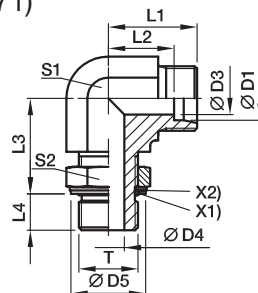

X1) O-ring OR
X2) retaining ring

| Series | D1 | T | D3 | D4 | D5 ⁵⁾ | D5 ⁶⁾ | L1 | L2 | L3 | L4 | L5 | S1 | S2 | S3 | Weight g/1 piece | Order code* | PN (bar) ¹⁾ | |
|------------------|-----------|-----------|------|------|------------------|------------------|------|------|------|------|----|----|----|------|---------------------|-------------|------------------------|-----|
| | | | | | | | | | | | | | | | | | CF | 71 |
| LL ²⁾ | 04 | G 1/8 A | 3.0 | 4.5 | 15 | | 15 | 11.3 | 20 | 7.1 | 21 | 12 | 14 | 10 | 27 | WEE04LLROMD | 100 | |
| | 06 | G 1/8 A | 4.5 | 4.5 | 15 | | 15 | 11.3 | 20 | 7.1 | 21 | 12 | 14 | 12 | 27 | WEE06LLROMD | 100 | |
| L ³⁾ | 06 | G 1/8 A | 4.0 | 4.5 | 15 | 15.0 | 21 | 14.0 | 19 | 7.0 | 29 | 14 | 14 | 14 | 40 | WEE06LROMD | 315 | 315 |
| | 08 | G 1/4 A | 6.0 | 7.5 | 20 | 19.5 | 23 | 16.0 | 23 | 9.0 | 31 | 14 | 19 | 17 | 59 | WEE08LROMD | 315 | 315 |
| | 10 | G 1/4 A | 8.0 | 7.5 | 20 | 19.5 | 24 | 17.0 | 25 | 9.0 | 32 | 19 | 19 | 19 | 82 | WEE10LROMD | 315 | 315 |
| | 12 | G 3/8 A | 10.0 | 10.0 | 23 | 23.5 | 26 | 19.0 | 28 | 9.0 | 34 | 19 | 22 | 22 | 96 | WEE12LROMD | 250 | 250 |
| | 15 | G 1/2 A | 12.0 | 12.5 | 28 | 28.5 | 28 | 21.0 | 30 | 13.0 | 36 | 22 | 27 | 27 | 149 | WEE15LROMD | 250 | 250 |
| | 18 | G 1/2 A | 15.0 | 12.5 | 28 | 28.5 | 31 | 24.0 | 36 | 13.0 | 40 | 27 | 27 | 32 | 221 | WEE18LROMD | 250 | 250 |
| | 22 | G 3/4 A | 19.0 | 15.5 | 33 | 34.5 | 35 | 28.0 | 36 | 13.0 | 44 | 30 | 36 | 36 | 310 | WEE22LROMD | 160 | 160 |
| | 28 | G 1 A | 24.0 | 21.5 | 41 | 43.5 | 38 | 31.0 | 44 | 15.0 | 47 | 36 | 41 | 41 | 455 | WEE28LROMD | 160 | 160 |
| | 35 | G 1 1/4 A | 30.0 | 27.5 | 51 | 52.5 | 48 | 38.0 | 50 | 15.0 | 59 | 50 | 50 | 50 | 1043 | WEE35LROMD | 160 | 160 |
| | 42 | G 1 1/2 A | 36.0 | 33.0 | 56 | 60.0 | 49 | 38.0 | 52 | 15.0 | 61 | 50 | 55 | 60 | 994 | WEE42LROMD | 160 | 160 |
| S ⁴⁾ | 06 | G 1/4 A | 4.0 | 7.5 | 20 | 19.5 | 22 | 15.0 | 23 | 9.0 | 30 | 14 | 19 | 17 | 56 | WEE06SROMD | 315 | 315 |
| | 08 | G 1/4 A | 5.0 | 7.5 | 20 | 19.5 | 24 | 17.0 | 27 | 9.0 | 32 | 19 | 19 | 19 | 88 | WEE08SROMD | 315 | 315 |
| | 10 | G 3/8 A | 7.0 | 10.0 | 23 | 23.5 | 25 | 18.0 | 29 | 9.0 | 34 | 19 | 22 | 22 | 98 | WEE10SROMD | 250 | 250 |
| | 12 | G 3/8 A | 8.0 | 10.0 | 23 | 23.5 | 29 | 22.0 | 29 | 9.0 | 38 | 22 | 22 | 24 | 128 | WEE12SROMD | 250 | 250 |
| | 16 | G 1/2 A | 12.0 | 12.5 | 28 | 28.5 | 33 | 25.0 | 36 | 13.0 | 43 | 27 | 27 | 30 | 234 | WEE16SROMD | 250 | 250 |
| | 20 | G 3/4 A | 16.0 | 15.5 | 33 | 34.5 | 38 | 28.0 | 39 | 12.0 | 49 | 30 | 36 | 36 | 344 | WEE20SROMD | 250 | 250 |
| | 25 | G 1 A | 20.0 | 21.5 | 41 | 43.5 | 42 | 30.0 | 44 | 14.0 | 54 | 36 | 41 | 46 | 533 | WEE25SROMD | 250 | 250 |
| | 30 | G 1 1/4 A | 25.0 | 27.5 | 51 | 52.5 | 49 | 36.0 | 49 | 15.0 | 62 | 50 | 50 | 50 | 1085 | WEE30SROMD | 160 | 160 |
| 38 | G 1 1/2 A | 32.0 | 33.0 | 56 | 60.0 | 50 | 34.0 | 55 | 15.0 | 65 | 50 | 55 | 60 | 1116 | WEE38SROMD | 160 | 160 | |

1) Pressure shown = item deliverable

2) LL = very light series; 3) L = light series; 4) S = heavy series

PN (bar) = PN (MPa)
10

Delivery without nut and ring. Information on ordering complete fittings or alternative sealing materials see page 17.

5) Steel; 6) Stainless Steel

*Please add the suffixes below according to the material/surface required.

| Order code suffixes | | | |
|---------------------------------|-----------------------------|---------------|---|
| Material | Suffix surface and material | Example | Standard sealing material (no additional suffix needed) |
| Steel, zinc plated, Cr(VI)-free | CF | WEE16SROMDCF | NBR |
| Stainless Steel | 71 | WEE16SRBOMD71 | VIT |

Adjustable locknut elbow, branch tee, run tee or 45° elbow

On customer request!

WEE Adjustable locknut elbow EO 24° cone end/Adjustable thread

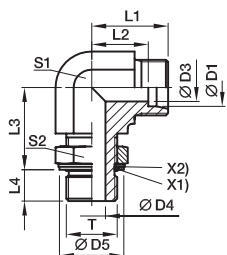

| T | Order code | Surface |
|---|--------------|---------|
| metric thread – O-ring + retaining ring | WEE...MOMD | CF |
| metric thread – O-ring (ISO 6149) | WEE...MOROMD | CF |
| UN/UNF thread – O-ring (ISO 11926) | WEE...UNFOMD | CF |

TEE Adjustable locknut branch tee EO 24° cone end/Adjustable thread

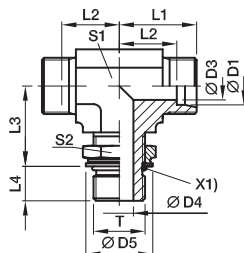

| T | Order code | Surface |
|---|--------------|---------|
| metric thread – O-ring + retaining ring | TEE...MOMD | CF |
| metric thread – O-ring (ISO 6149) | TEE...MOROMD | CF |
| UN/UNF thread – O-ring (ISO 11926) | TEE...UNFOMD | CF |
| BSP thread – O-ring + retaining ring (ISO 1179) | TEE...ROMD | CF |

LEE Adjustable locknut run tee EO 24° cone end/Adjustable thread

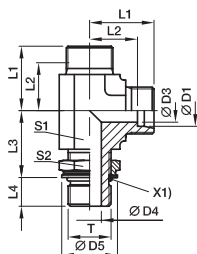

| T | Order code | Surface |
|---|--------------|---------|
| metric thread – O-ring + retaining ring | LEE...MOMD | CF |
| metric thread – O-ring (ISO 6149) | LEE...MOROMD | CF |
| UN/UNF thread – O-ring (ISO 11926) | LEE...UNFOMD | CF |
| BSP thread – O-ring + retaining ring (ISO 1179) | LEE...ROMD | CF |

VEE Adjustable locknut 45° elbow EO 24° cone end/Adjustable thread

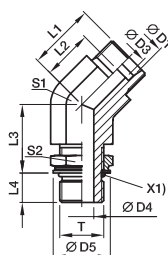

| T | Order code | Surface |
|---|--------------|---------|
| metric thread – O-ring + retaining ring | VEE...MOMD | CF |
| metric thread – O-ring (ISO 6149) | VEE...MOROMD | CF |
| UN/UNF thread – O-ring (ISO 11926) | VEE...UNFOMD | CF |
| BSP thread – O-ring + retaining ring (ISO 1179) | VEE...ROMD | CF |



WH-M-KDS High pressure banjo elbow

EO 24° cone end / Male metric thread with soft seal ring

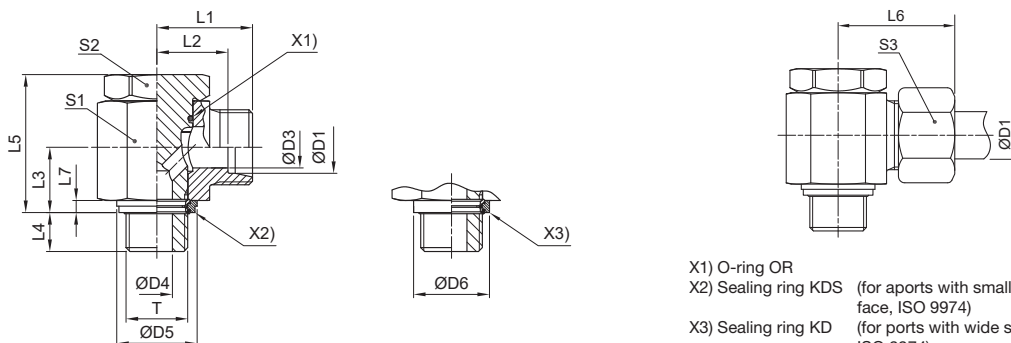

- X1) O-ring OR
- X2) Sealing ring KDS (for apertures with small spot face, ISO 9974)
- X3) Sealing ring KD (for apertures with wide spot face, ISO 9974)

| Series | D1 | T | D3 | D4 | D5 KDS | D6 KD | L1 | L2 | L3 | L4 | L5 | L6 | L7 | S1 | S2 | S3 | Weight g/1 piece | Order code* | PN (bar ¹⁾) | |
|-----------------|----------|----------|------|------|--------|-------|------|------|------|------|------|-----|-----|-----|----|------|------------------|--------------|-------------------------|-----|
| | | | | | | | | | | | | | | | | | | | CF | 71 |
| L ³⁾ | 06 | M 10×1.0 | 4 | 4.5 | 14.9 | 17.0 | 19.0 | 12.0 | 10.5 | 8 | 24.0 | 27 | 2.5 | 17 | 17 | 14 | 54 | WH06LMKDSOMD | 315 | 315 |
| | 08 | M 12×1.5 | 6 | 6.0 | 17.0 | 22.0 | 21.5 | 14.5 | 14.0 | 12 | 30.0 | 29 | 3.0 | 22 | 19 | 17 | 97 | WH08LMKDSOMD | 315 | 315 |
| | 10 | M 14×1.5 | 8 | 6.0 | 18.9 | 22.5 | 22.5 | 15.5 | 14.0 | 12 | 30.0 | 30 | 3.0 | 22 | 19 | 19 | 104 | WH10LMKDSOMD | 315 | 315 |
| | 12 | M 16×1.5 | 10 | 7.5 | 21.9 | 27.0 | 25.0 | 18.0 | 16.5 | 12 | 36.0 | 33 | 3.0 | 27* | 24 | 22 | 180 | WH12LMKDSOMD | 315 | 315 |
| | 15 | M 18×1.5 | 11 | 9.0 | 23.9 | 29.0 | 27.5 | 21.5 | 18.5 | 12 | 39.5 | 37 | 3.0 | 30 | 27 | 27 | 244 | WH15LMKDSOMD | 315 | 315 |
| | 18 | M 22×1.5 | 15 | 12.0 | 26.9 | 32.0 | 28.5 | 21.0 | 21.5 | 14 | 45.0 | 37 | 4.5 | 32 | 30 | 32 | 327 | WH18LMKDSOMD | 315 | 315 |
| | 22 | M 26×1.5 | 19 | 17.0 | 31.9 | 41.0 | 35.0 | 27.5 | 24.0 | 16 | 53.0 | 44 | 3.5 | 41 | 36 | 36 | 573 | WH22LMKDSOMD | 160 | 160 |
| | 28 | M 33×2.0 | 24 | 21.0 | 39.9 | 46.0 | 39.5 | 32.0 | 30.5 | 18 | 66.0 | 49 | 3.5 | 50 | 46 | 41 | 1017 | WH28LMKDSOMD | 160 | 160 |
| | 35 | M 42×2.0 | 30 | 27.0 | 49.9 | 57.0 | 46.5 | 36.0 | 35.5 | 20 | 76.0 | 58 | 3.5 | 60 | 55 | 50 | 1512 | WH35LMKDSOMD | 160 | 160 |
| | 42 | M 48×2.0 | 36 | 34.0 | 55.9 | 64.0 | 51.5 | 40.5 | 40.5 | 22 | 87.0 | 63 | 3.5 | 70 | 60 | 60 | 2217 | WH42LMKDSOMD | 160 | 160 |
| S ⁴⁾ | 06 | M 12×1.5 | 4 | 6.0 | 17.0 | 22.0 | 23.5 | 16.5 | 14.0 | 12 | 30.0 | 31 | 3.0 | 22 | 19 | 17 | 104 | WH06SMKDSOMD | 400 | 400 |
| | 08 | M 14×1.5 | 5 | 6.0 | 18.9 | 22.5 | 23.5 | 16.5 | 14.0 | 12 | 30.0 | 31 | 3.0 | 22 | 19 | 19 | 110 | WH08SMKDSOMD | 400 | 400 |
| | 10 | M 16×1.5 | 7 | 7.5 | 21.9 | 27.0 | 26.0 | 18.5 | 16.5 | 12 | 36.0 | 35 | 3.0 | 27 | 24 | 22 | 186 | WH10SMKDSOMD | 400 | 400 |
| | 12 | M 18×1.5 | 8 | 9.0 | 23.9 | 29.0 | 27.5 | 20.0 | 18.5 | 12 | 39.5 | 36 | 3.0 | 27* | 27 | 24 | 246 | WH12SMKDSOMD | 400 | 400 |
| | 16 | M 22×1.5 | 12 | 12.0 | 26.9 | 32.0 | 30.5 | 22.0 | 21.5 | 14 | 45.0 | 40 | 4.5 | 32 | 30 | 30 | 327 | WH16SMKDSOMD | 315 | 315 |
| | 20 | M 27×2.0 | 16 | 16.0 | 32.9 | 41.0 | 37.0 | 26.5 | 24.0 | 16 | 53.0 | 48 | 3.5 | 41 | 36 | 36 | 598 | WH20SMKDSOMD | 315 | 315 |
| | 25 | M 33×2.0 | 20 | 21.0 | 39.9 | 46.0 | 43.5 | 31.5 | 30.5 | 18 | 66.0 | 56 | 3.5 | 50 | 46 | 46 | 1055 | WH25SMKDSOMD | 250 | 250 |
| | 30 | M 42×2.0 | 25 | 27.0 | 49.9 | 57.0 | 50.5 | 37.0 | 35.5 | 20 | 76.0 | 64 | 3.5 | 60 | 55 | 50 | 1572 | WH30SMKDSOMD | 160 | 160 |
| 38 | M 48×2.0 | 32 | 34.0 | 55.9 | 64.0 | 57.5 | 41.5 | 40.5 | 22 | 87.0 | 72 | 3.5 | 70 | 60 | 60 | 2317 | WH38SMKDSOMD | 160 | 160 | |

¹⁾ Pressure shown = item deliverable

³⁾ L = light series; ⁴⁾ S = heavy series

PN (bar) = PN (MPa) / 10

Delivery without nut and ring. Information on ordering complete fittings or alternative sealing materials see page 17.

*S1=SW30 in 1.4571

| Order code suffixes | | | |
|---------------------------------|-----------------------------|----------------|---|
| Material | Suffix surface and material | Example | Standard sealing material (no additional suffix needed) |
| Steel, zinc plated, Cr(VI)-free | CF | WH16SMKDSOMDCF | NBR |
| Stainless Steel | 71 | WH16SMKDOMD71 | VIT/PTFE |

*Please add the suffixes below according to the material/surface required.

Stainless Steel only with sealing ring KD available!
Replace KDS by KD in the order code.

DIN fittings

WH-M High pressure banjo elbow

EO 24° cone end / Male metric thread with metal sealing ring

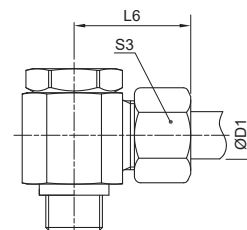
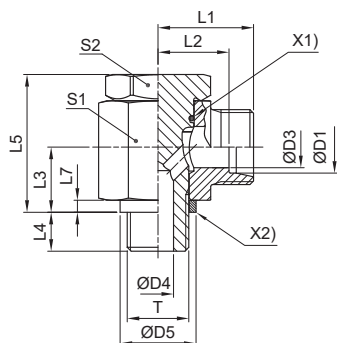
 X1) O-ring OR
 X2) Sealing ring DKA

| Series | D1 | T | D3 | D4 | D5 | L1 | L2 | L3 | L4 | L5 | L6 | L7 | S1 | S2 | S3 | Weight g/1 piece | Order code* | PN (bar) ¹⁾ | |
|-----------------|----------|----------|------|------|------|------|------|------|------|------|-----|-----|-----|----|------|---------------------|-------------|------------------------|-----|
| | | | | | | | | | | | | | | | | | | CF | 71 |
| L ³⁾ | 06 | M 10×1.0 | 4 | 4.5 | 14 | 19.0 | 12.0 | 10.5 | 8 | 24.0 | 27 | 2.5 | 17 | 17 | 14 | 54 | WH06LMOMD | 250 | 250 |
| | 08 | M 12×1.5 | 6 | 6.0 | 17 | 21.5 | 14.5 | 14.0 | 12 | 30.0 | 29 | 3.0 | 22 | 19 | 17 | 97 | WH08LMOMD | 250 | 250 |
| | 10 | M 14×1.5 | 8 | 6.0 | 19 | 22.5 | 15.5 | 14.0 | 12 | 30.0 | 30 | 3.0 | 22 | 19 | 19 | 104 | WH10LMOMD | 250 | 250 |
| | 12 | M 16×1.5 | 10 | 7.5 | 21 | 25.0 | 18.0 | 16.5 | 12 | 36.0 | 33 | 3.0 | 27 | 24 | 22 | 180 | WH12LMOMD | 250 | 250 |
| | 15 | M 18×1.5 | 11 | 9.0 | 23 | 27.5 | 21.5 | 18.5 | 12 | 39.5 | 37 | 3.0 | 30 | 27 | 27 | 243 | WH15LMOMD | 250 | 250 |
| | 18 | M 22×1.5 | 15 | 12.0 | 27 | 28.5 | 21.0 | 21.5 | 14 | 45.0 | 37 | 4.5 | 32 | 30 | 32 | 326 | WH18LMOMD | 250 | 250 |
| | 22 | M 26×1.5 | 19 | 17.0 | 31 | 35.0 | 27.5 | 24.0 | 16 | 53.0 | 44 | 3.5 | 41 | 36 | 36 | 574 | WH22LMOMD | 160 | 160 |
| | 28 | M 33×2.0 | 24 | 21.0 | 39 | 39.5 | 32.0 | 30.5 | 18 | 66.0 | 49 | 3.5 | 50 | 46 | 41 | 1016 | WH28LMOMD | 160 | 160 |
| S ⁴⁾ | 35 | M 42×2.0 | 30 | 27.0 | 49 | 46.5 | 36.0 | 35.5 | 20 | 76.0 | 58 | 3.5 | 60 | 55 | 50 | 1512 | WH35LMOMD | 160 | 160 |
| | 42 | M 48×2.0 | 36 | 34.0 | 55 | 51.5 | 40.5 | 40.5 | 22 | 87.0 | 63 | 3.5 | 70 | 60 | 60 | 2216 | WH42LMOMD | 160 | 160 |
| | 06 | M 12×1.5 | 4 | 6.0 | 17 | 23.5 | 16.5 | 14.0 | 12 | 30.0 | 31 | 3.0 | 22 | 19 | 17 | 104 | WH06SMOMD | 315 | 315 |
| | 08 | M 14×1.5 | 5 | 6.0 | 19 | 23.5 | 16.5 | 14.0 | 12 | 30.0 | 31 | 3.0 | 22 | 19 | 19 | 111 | WH08SMOMD | 315 | 315 |
| | 10 | M 16×1.5 | 7 | 7.5 | 21 | 26.0 | 18.5 | 16.5 | 12 | 36.0 | 35 | 3.0 | 27 | 24 | 22 | 186 | WH10SMOMD | 315 | 315 |
| | 12 | M 18×1.5 | 8 | 9.0 | 23 | 27.5 | 20.0 | 18.5 | 12 | 39.5 | 36 | 3.0 | 27* | 27 | 24 | 246 | WH12SMOMD | 315 | 315 |
| | 16 | M 22×1.5 | 12 | 12.0 | 27 | 30.5 | 22.0 | 21.5 | 14 | 45.0 | 40 | 4.5 | 32 | 30 | 30 | 326 | WH16SMOMD | 315 | 315 |
| | 20 | M 27×2.0 | 16 | 16.0 | 32 | 37.0 | 26.5 | 24.0 | 16 | 53.0 | 48 | 3.5 | 41 | 36 | 36 | 596 | WH20SMOMD | 160 | 160 |
| 25 | M 33×2.0 | 20 | 21.0 | 39 | 43.5 | 31.5 | 30.5 | 18 | 66.0 | 56 | 3.5 | 50 | 46 | 46 | 1055 | WH25SMOMD | 160 | 160 | |
| 30 | M 42×2.0 | 25 | 27.0 | 49 | 50.5 | 37.0 | 35.5 | 20 | 76.0 | 64 | 3.5 | 60 | 55 | 50 | 1572 | WH30SMOMD | 160 | 160 | |
| 38 | M 48×2.0 | 32 | 34.0 | 55 | 57.5 | 41.5 | 40.5 | 22 | 87.0 | 72 | 3.5 | 70 | 60 | 60 | 2316 | WH38SMOMD | 160 | 160 | |

1) Pressure shown = item deliverable

3) L = light series; 4) S = heavy series

$$\frac{\text{PN (bar)}}{10} = \text{PN (MPa)}$$

Delivery without nut and ring. Information on ordering complete fittings or alternative sealing materials see page 17.

*S1=SW30 in 1.4571

| Order code suffixes | | | |
|---------------------------------|-----------------------------|-------------|---|
| Material | Suffix surface and material | Example | Standard sealing material (no additional suffix needed) |
| Steel, zinc plated, Cr(VI)-free | CF | WH16SMOMDCF | NBR |
| Stainless Steel | 71 | WH16SMOMD71 | VIT |

*Please add the suffixes below according to the material/surface required.



WH-R-KDS High pressure banjo elbow

EO 24° cone end / Male BSPP thread with soft seal ring

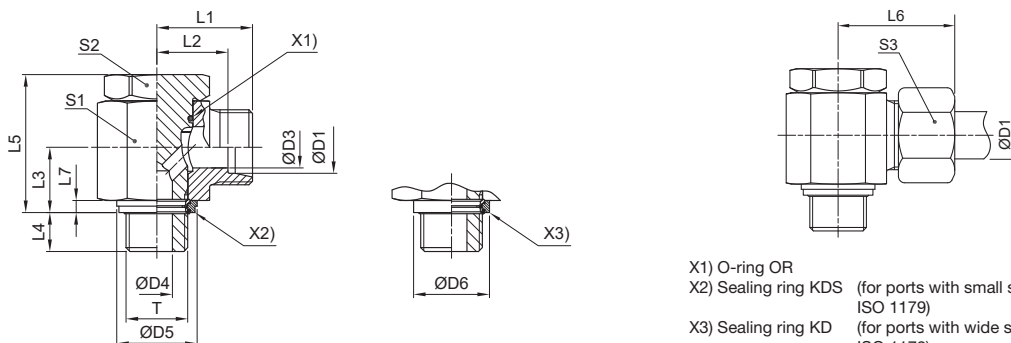

- X1) O-ring OR
- X2) Sealing ring KDS (for ports with small spot face, ISO 1179)
- X3) Sealing ring KD (for ports with wide spot face, ISO 1179)

| Series | D1 | T | D3 | D4 | D5 KDS | D6 KD | L1 | L2 | L3 | L4 | L5 | L6 | L7 | S1 | S2 | S3 | Weight g/1 piece | Order code* | PN (bar) ¹⁾ | CF | 71 |
|-----------------|----|-----------|----|------|-----------|----------|------|------|------|----|----|----|-----|-----|----|----|---------------------|--------------|------------------------|-----|----|
| L ³⁾ | 06 | G 1/8 A | 4 | 4.5 | 14.9 | 17 | 19.0 | 12.0 | 10.5 | 8 | 24 | 27 | 2.5 | 17 | 17 | 14 | 53 | WH06LRKDSOMD | 315 | 315 | |
| | 08 | G 1/4 A | 6 | 6.0 | 18.9 | 22 | 21.5 | 14.5 | 14.0 | 12 | 30 | 29 | 3.0 | 22 | 19 | 17 | 101 | WH08LRKDSOMD | 315 | 315 | |
| | 10 | G 1/4 A | 8 | 6.0 | 18.9 | 22 | 22.5 | 15.5 | 14.0 | 12 | 30 | 30 | 3.0 | 22 | 19 | 19 | 102 | WH10LRKDSOMD | 315 | 315 | |
| | 12 | G 3/8 A | 10 | 7.5 | 21.9 | 27 | 25.0 | 18.0 | 16.5 | 12 | 36 | 33 | 3.0 | 27 | 24 | 22 | 181 | WH12LRKDSOMD | 315 | 315 | |
| | 15 | G 1/2 A | 12 | 11.0 | 26.9 | 32 | 28.5 | 21.5 | 21.5 | 14 | 45 | 37 | 4.5 | 32 | 30 | 27 | 312 | WH15LRKDSOMD | 315 | 315 | |
| | 18 | G 1/2 A | 15 | 11.0 | 26.9 | 32 | 28.5 | 21.0 | 21.5 | 14 | 45 | 37 | 4.5 | 32 | 30 | 32 | 319 | WH18LRKDSOMD | 315 | 315 | |
| | 22 | G 3/4 A | 19 | 17.0 | 32.9 | 41 | 35.0 | 27.5 | 24.0 | 16 | 53 | 44 | 3.5 | 41 | 36 | 36 | 578 | WH22LRKDSOMD | 160 | 160 | |
| | 28 | G 1 A | 24 | 21.0 | 39.9 | 46 | 39.5 | 32.0 | 30.5 | 18 | 66 | 49 | 3.5 | 50 | 46 | 41 | 1035 | WH28LRKDSOMD | 160 | 160 | |
| | 35 | G 1 1/4 A | 30 | 27.0 | 49.9 | 57 | 46.5 | 36.0 | 35.5 | 20 | 76 | 58 | 3.5 | 60 | 55 | 50 | 1499 | WH35LRKDSOMD | 160 | 160 | |
| | 42 | G 1 1/2 A | 36 | 34.0 | 55.9 | 64 | 51.5 | 40.5 | 40.5 | 22 | 87 | 63 | 3.5 | 70 | 60 | 60 | 2196 | WH42LRKDSOMD | 160 | 160 | |
| S ⁴⁾ | 06 | G 1/4 A | 4 | 6.0 | 18.9 | 22 | 23.5 | 16.5 | 14.0 | 12 | 30 | 31 | 3.0 | 22 | 19 | 17 | 107 | WH06SRKDSOMD | 400 | 400 | |
| | 08 | G 1/4 A | 5 | 6.0 | 18.9 | 22 | 23.5 | 16.5 | 14.0 | 12 | 30 | 31 | 3.0 | 22 | 19 | 19 | 107 | WH08SRKDSOMD | 400 | 400 | |
| | 10 | G 3/8 A | 7 | 7.5 | 21.9 | 27 | 26.0 | 18.5 | 16.5 | 12 | 36 | 35 | 3.0 | 27 | 24 | 22 | 188 | WH10SRKDSOMD | 400 | 400 | |
| | 12 | G 3/8 A | 8 | 7.5 | 21.9 | 27 | 26.0 | 18.5 | 16.5 | 12 | 36 | 35 | 3.0 | 27* | 24 | 24 | 190 | WH12SRKDSOMD | 400 | 400 | |
| | 16 | G 1/2 A | 12 | 11.0 | 26.9 | 32 | 30.5 | 22.0 | 21.5 | 14 | 45 | 40 | 4.5 | 32 | 30 | 30 | 324 | WH16SRKDSOMD | 315 | 315 | |
| | 20 | G 3/4 A | 16 | 17.0 | 32.9 | 41 | 37.0 | 26.5 | 24.0 | 16 | 53 | 48 | 3.5 | 41 | 36 | 36 | 588 | WH20SRKDSOMD | 315 | 315 | |
| | 25 | G 1 A | 20 | 21.0 | 39.9 | 46 | 43.5 | 31.5 | 30.5 | 18 | 66 | 56 | 3.5 | 50 | 46 | 46 | 1073 | WH25SRKDSOMD | 250 | 250 | |
| | 30 | G 1 1/4 A | 25 | 27.0 | 49.9 | 57 | 50.5 | 37.0 | 35.5 | 20 | 76 | 64 | 3.5 | 60 | 55 | 50 | 1559 | WH30SRKDSOMD | 160 | 160 | |
| | 38 | G 1 1/2 A | 32 | 34.0 | 55.9 | 64 | 57.5 | 41.5 | 40.5 | 22 | 87 | 72 | 3.5 | 70 | 60 | 60 | 2296 | WH38SRKDSOMD | 160 | 160 | |

¹⁾ Pressure shown = item deliverable

³⁾ L = light series; ⁴⁾ S = heavy series

PN (bar)
10 = PN (MPa)

Delivery without nut and ring. Information on ordering complete fittings or alternative sealing materials see page 17.

*Please add the **suffixes** below according to the material/surface required.

| Order code suffixes | | | |
|---------------------------------|-----------------------------|----------------|---|
| Material | Suffix surface and material | Example | Standard sealing material (no additional suffix needed) |
| Steel, zinc plated, Cr(VI)-free | CF | WH16SRKDSOMDCF | NBR |
| Stainless Steel | 71 | WH16SRKDOMD71 | VIT/PTFE |

Stainless Steel only with sealing ring **KD** available!
Replace KDS by **KD** in the order code.

DIN fittings

WH-R High pressure banjo elbow

EO 24° cone end / Male BSPP thread with metal sealing ring

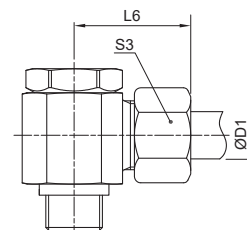
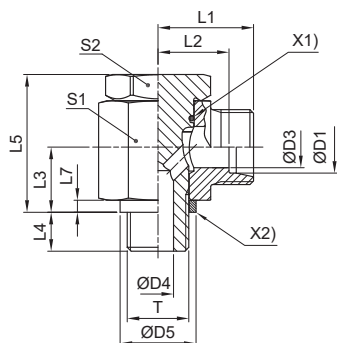
 X1) O-ring OR
 X2) Sealing ring DKA

| Series | D1 | T | D3 | D4 | D5 | L1 | L2 | L3 | L4 | L5 | L6 | L7 | S1 | S2 | S3 | Weight g/1 piece | Order code* | PN (bar) ¹⁾ | | |
|-----------------|-----------|-----------|------|------|------|------|------|------|----|----|-----|-----|-----|----|------|---------------------|-------------|------------------------|-----|-----|
| | | | | | | | | | | | | | | | | | | CF | 71 | MS |
| L ³⁾ | 06 | G 1/8 A | 4 | 4.5 | 14 | 19.0 | 12.0 | 10.5 | 8 | 24 | 27 | 2.5 | 17 | 17 | 14 | 53 | WH06LROMD | 250 | 250 | 160 |
| | 08 | G 1/4 A | 6 | 6.0 | 18 | 21.5 | 14.5 | 14.0 | 12 | 30 | 29 | 3.0 | 22 | 19 | 17 | 101 | WH08LROMD | 250 | 250 | 160 |
| | 10 | G 1/4 A | 8 | 6.0 | 18 | 22.5 | 15.5 | 14.0 | 12 | 30 | 30 | 3.0 | 22 | 19 | 19 | 102 | WH10LROMD | 250 | 250 | 160 |
| | 12 | G 3/8 A | 10 | 7.5 | 22 | 25.0 | 18.0 | 16.5 | 12 | 36 | 33 | 3.0 | 27 | 24 | 22 | 181 | WH12LROMD | 250 | 250 | 160 |
| | 15 | G 1/2 A | 12 | 11.0 | 26 | 28.5 | 21.5 | 21.5 | 14 | 45 | 37 | 4.5 | 32 | 30 | 27 | 311 | WH15LROMD | 250 | 250 | 160 |
| | 18 | G 1/2 A | 15 | 11.0 | 26 | 28.5 | 21.0 | 21.5 | 14 | 45 | 37 | 4.5 | 32 | 30 | 32 | 319 | WH18LROMD | 250 | 250 | 160 |
| | 22 | G 3/4 A | 19 | 17.0 | 32 | 35.0 | 27.5 | 24.0 | 16 | 53 | 44 | 3.5 | 41 | 36 | 36 | 577 | WH22LROMD | 160 | 160 | |
| | 28 | G 1 A | 24 | 21.0 | 39 | 39.5 | 32.0 | 30.5 | 18 | 66 | 49 | 3.5 | 50 | 46 | 41 | 1034 | WH28LROMD | 160 | 160 | |
| | 35 | G 1 1/4 A | 30 | 27.0 | 57 | 46.5 | 36.0 | 35.5 | 20 | 76 | 58 | 3.5 | 60 | 55 | 50 | 1500 | WH35LROMD | 160 | 160 | |
| | 42 | G 1 1/2 A | 36 | 34.0 | 55 | 51.5 | 40.5 | 40.5 | 22 | 87 | 63 | 3.5 | 70 | 60 | 60 | 2195 | WH42LROMD | 160 | 160 | |
| S ⁴⁾ | 06 | G 1/4 A | 4 | 6.0 | 18 | 23.5 | 16.5 | 14.0 | 12 | 30 | 31 | 3.0 | 22 | 19 | 17 | 107 | WH06SROMD | 315 | 315 | 200 |
| | 08 | G 1/4 A | 5 | 6.0 | 18 | 23.5 | 16.5 | 14.0 | 12 | 30 | 31 | 3.0 | 22 | 19 | 19 | 107 | WH08SROMD | 315 | 315 | 200 |
| | 10 | G 3/8 A | 7 | 7.5 | 22 | 26.0 | 18.5 | 16.5 | 12 | 36 | 35 | 3.0 | 27 | 24 | 22 | 188 | WH10SROMD | 315 | 315 | 200 |
| | 12 | G 3/8 A | 8 | 7.5 | 22 | 26.0 | 18.5 | 16.5 | 12 | 36 | 35 | 3.0 | 27* | 24 | 24 | 190 | WH12SROMD | 315 | 315 | 200 |
| | 16 | G 1/2 A | 12 | 11.0 | 26 | 30.5 | 22.0 | 21.5 | 14 | 45 | 40 | 4.5 | 32 | 30 | 30 | 317 | WH16SROMD | 315 | 315 | |
| | 20 | G 3/4 A | 16 | 17.0 | 32 | 37.0 | 26.5 | 24.0 | 16 | 53 | 48 | 3.5 | 41 | 36 | 36 | 587 | WH20SROMD | 160 | 160 | |
| | 25 | G 1 A | 20 | 21.0 | 39 | 43.5 | 31.5 | 30.5 | 18 | 66 | 56 | 3.5 | 50 | 46 | 46 | 1072 | WH25SROMD | 160 | 160 | |
| | 30 | G 1 1/4 A | 25 | 27.0 | 49 | 50.5 | 37.0 | 35.5 | 20 | 76 | 64 | 3.5 | 60 | 55 | 50 | 1560 | WH30SROMD | 160 | 160 | |
| 38 | G 1 1/2 A | 32 | 34.0 | 55 | 57.5 | 41.5 | 40.5 | 22 | 87 | 72 | 3.5 | 70 | 60 | 60 | 2295 | WH38SROMD | 160 | 160 | | |

1) Pressure shown = item deliverable

3) L = light series; 4) S = heavy series

 $PN(\text{bar}) = \frac{PN(\text{MPa})}{10}$

Delivery without nut and ring. Information on ordering complete fittings or alternative sealing materials see page 17.

| Order code suffixes | | | |
|---------------------------------|-----------------------------|-------------|---|
| Material | Suffix surface and material | Example | Standard sealing material (no additional suffix needed) |
| Steel, zinc plated, Cr(VI)-free | CF | WH16SROMDCF | NBR |
| Stainless Steel | 71 | WH16SROMD71 | VIT |
| Brass | MS | WH18LROMDMS | NBR |

*Please add the suffixes below according to the material/surface required

TH-M-KDS High pressure banjo tee

EO 24° cone end / Male metric thread with soft seal ring

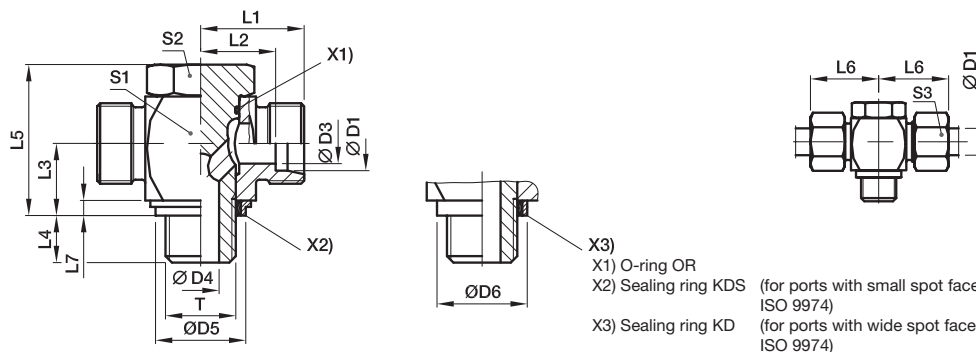

X1) O-ring OR
 X2) Sealing ring KDS (for ports with small spot face, ISO 9974)
 X3) Sealing ring KD (for ports with wide spot face, ISO 9974)

| Series | D1 | T | D3 | D4 | D5 KDS | D6 KD | L1 | L2 | L3 | L4 | L5 | L6 | L7 | S1 | S2 | S3 | Weight g/1 piece | Order code* | PN (bar) ¹⁾ | |
|-----------------|----|----------|----|------|--------|-------|------|------|------|----|------|----|-----|----|----|----|------------------|--------------|------------------------|-----|
| | | | | | | | | | | | | | | | | | | | CF | 71 |
| L ³⁾ | 06 | M 10×1.0 | 4 | 4.5 | 14.9 | 17.0 | 19.0 | 12.0 | 10.5 | 8 | 24.0 | 27 | 2.5 | 17 | 17 | 14 | 59 | TH06LMKDSOMD | 315 | 315 |
| | 08 | M 12×1.5 | 6 | 6.0 | 17.0 | 22.0 | 21.5 | 14.5 | 14.0 | 12 | 30.0 | 29 | 3.0 | 22 | 19 | 17 | 104 | TH08LMKDSOMD | 315 | 315 |
| | 10 | M 14×1.5 | 8 | 6.0 | 18.9 | 22.5 | 22.5 | 15.5 | 14.0 | 12 | 30.0 | 30 | 3.0 | 22 | 19 | 19 | 112 | TH10LMKDSOMD | 315 | 315 |
| | 12 | M 16×1.5 | 10 | 7.5 | 21.9 | 27.0 | 25.0 | 18.0 | 16.5 | 12 | 36.0 | 33 | 3.0 | 27 | 24 | 22 | 192 | TH12LMKDSOMD | 315 | 315 |
| | 15 | M 18×1.5 | 11 | 9.0 | 23.9 | 29.0 | 27.5 | 21.5 | 18.5 | 12 | 39.5 | 37 | 3.0 | 30 | 27 | 27 | 258 | TH15LMKDSOMD | 315 | 315 |
| | 18 | M 22×1.5 | 15 | 12.0 | 26.9 | 32.0 | 28.5 | 21.0 | 21.5 | 14 | 45.0 | 37 | 4.5 | 32 | 30 | 32 | 337 | TH18LMKDSOMD | 315 | 315 |
| | 22 | M 26×1.5 | 19 | 17.0 | 31.9 | 41.0 | 35.0 | 27.5 | 24.0 | 16 | 53.0 | 44 | 3.5 | 41 | 36 | 36 | 589 | TH22LMKDSOMD | 160 | 160 |
| | 28 | M 33×2.0 | 24 | 21.0 | 39.9 | 46.0 | 39.5 | 32.0 | 30.5 | 18 | 66.0 | 49 | 3.5 | 50 | 46 | 41 | 1072 | TH28LMKDSOMD | 160 | 160 |
| | 35 | M 42×2.0 | 30 | 27.0 | 49.9 | 57.0 | 46.5 | 36.0 | 35.5 | 20 | 76.0 | 58 | 3.5 | 60 | 55 | 50 | 1778 | TH35LMKDSOMD | 160 | 160 |
| | 42 | M 48×2.0 | 36 | 34.0 | 55.9 | 64.0 | 51.5 | 40.5 | 40.5 | 22 | 87.0 | 63 | 3.5 | 70 | 60 | 60 | 2566 | TH42LMKDSOMD | 160 | 160 |
| S ⁴⁾ | 06 | M 12×1.5 | 4 | 6.0 | 17.0 | 22.0 | 23.5 | 16.5 | 14.0 | 12 | 30.0 | 31 | 3.0 | 22 | 19 | 17 | 112 | TH06SMKDSOMD | 400 | 400 |
| | 08 | M 14×1.5 | 5 | 6.0 | 18.9 | 22.5 | 23.5 | 16.5 | 14.0 | 12 | 30.0 | 31 | 3.0 | 22 | 19 | 19 | 123 | TH08SMKDSOMD | 400 | 400 |
| | 10 | M 16×1.5 | 7 | 7.5 | 21.9 | 27.0 | 26.0 | 18.5 | 16.5 | 12 | 36.0 | 35 | 3.0 | 27 | 24 | 22 | 200 | TH10SMKDSOMD | 400 | 400 |
| | 12 | M 18×1.5 | 8 | 9.0 | 23.9 | 29.0 | 27.5 | 20.0 | 18.5 | 12 | 39.5 | 36 | 3.0 | 27 | 27 | 24 | 261 | TH12SMKDSOMD | 400 | 400 |
| | 16 | M 22×1.5 | 12 | 12.0 | 26.9 | 32.0 | 30.5 | 22.0 | 21.5 | 14 | 45.0 | 40 | 4.5 | 32 | 30 | 30 | 351 | TH16SMKDSOMD | 315 | 315 |
| | 20 | M 27×2.0 | 16 | 16.0 | 32.9 | 41.0 | 37.0 | 26.5 | 24.0 | 16 | 53.0 | 48 | 3.5 | 41 | 36 | 36 | 629 | TH20SMKDSOMD | 315 | 315 |
| | 25 | M 33×2.0 | 20 | 21.0 | 39.9 | 46.0 | 43.5 | 31.5 | 30.5 | 18 | 66.0 | 56 | 3.5 | 50 | 46 | 46 | 1106 | TH25SMKDSOMD | 250 | 250 |
| | 30 | M 42×2.0 | 25 | 27.0 | 49.9 | 57.0 | 50.5 | 37.0 | 35.5 | 20 | 76.0 | 64 | 3.5 | 60 | 55 | 50 | 1843 | TH30SMKDSOMD | 160 | 160 |
| | 38 | M 48×2.0 | 32 | 34.0 | 55.9 | 64.0 | 57.5 | 41.5 | 40.5 | 22 | 87.0 | 72 | 3.5 | 70 | 60 | 60 | 2744 | TH38SMKDSOMD | 160 | 160 |

¹⁾ Pressure shown = item deliverable

³⁾ L = light series; ⁴⁾ S = heavy series

PN (bar) = PN (MPa)
 10

Delivery without nut and ring. Information on ordering complete fittings or alternative sealing materials see page 17.

*S1=SW30 in 1.4571

| Order code suffixes | | | |
|---------------------------------|-----------------------------|----------------|---|
| Material | Suffix surface and material | Example | Standard sealing material (no additional suffix needed) |
| Steel, zinc plated, Cr(VI)-free | CF | TH16SMKDSOMDCF | NBR |
| Stainless Steel | 71 | TH16SMKDOMD71 | VIT/PTFE |

*Please add the suffixes below according to the material/surface required.

Stainless Steel only with sealing ring KD available!
 Replace KDS by KD in the order code.

DIN fittings

TH-M High pressure banjo tee

EO 24° cone end / Male metric thread with metal sealing ring

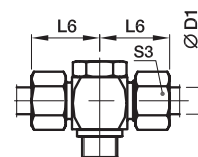
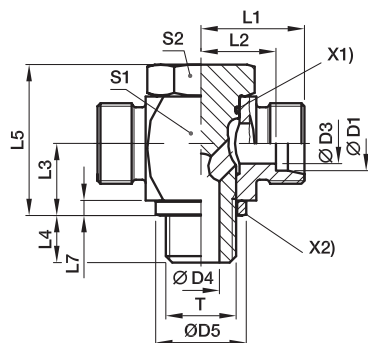
 X1) O-ring OR
 X2) Sealing ring DKA

| Series | D1 | T | D3 | D4 | D5 | L1 | L2 | L3 | L4 | L5 | L6 | L7 | S1 | S2 | S3 | Weight g/1 piece | Order code* | PN (bar) ¹⁾ | |
|-----------------|----|----------|----|------|----|------|------|------|----|------|----|-----|----|----|----|---------------------|-------------|------------------------|-----|
| | | | | | | | | | | | | | | | | | | CF | 71 |
| L ³⁾ | 06 | M 10×1.0 | 4 | 4.5 | 14 | 19.0 | 12.0 | 10.5 | 8 | 24.0 | 27 | 2.5 | 17 | 17 | 14 | 58 | TH06LMOMD | 250 | 250 |
| | 08 | M 12×1.5 | 6 | 6.0 | 17 | 21.5 | 14.5 | 14.0 | 12 | 30.0 | 29 | 3.0 | 22 | 19 | 17 | 104 | TH08LMOMD | 250 | 250 |
| | 10 | M 14×1.5 | 8 | 6.0 | 19 | 22.5 | 15.5 | 14.0 | 12 | 30.0 | 30 | 3.0 | 22 | 19 | 19 | 112 | TH10LMOMD | 250 | 250 |
| | 12 | M 16×1.5 | 10 | 7.5 | 21 | 25.0 | 18.0 | 16.5 | 12 | 36.0 | 33 | 3.0 | 27 | 24 | 22 | 191 | TH12LMOMD | 250 | 250 |
| | 15 | M 18×1.5 | 11 | 9.0 | 23 | 27.5 | 21.5 | 18.5 | 12 | 39.5 | 37 | 3.0 | 30 | 27 | 27 | 258 | TH15LMOMD | 250 | 250 |
| | 18 | M 22×1.5 | 15 | 12.0 | 27 | 28.5 | 21.0 | 21.5 | 14 | 45.0 | 37 | 4.5 | 32 | 30 | 32 | 337 | TH18LMOMD | 250 | 250 |
| | 22 | M 26×1.5 | 19 | 17.0 | 31 | 35.0 | 27.5 | 24.0 | 16 | 53.0 | 44 | 3.5 | 41 | 36 | 36 | 590 | TH22LMOMD | 160 | 160 |
| | 28 | M 33×2.0 | 24 | 21.0 | 39 | 39.5 | 32.0 | 30.5 | 18 | 66.0 | 49 | 3.5 | 50 | 46 | 41 | 1072 | TH28LMOMD | 160 | 160 |
| | 35 | M 42×2.0 | 30 | 27.0 | 49 | 46.5 | 36.0 | 35.5 | 20 | 76.0 | 58 | 3.5 | 60 | 55 | 50 | 1778 | TH35LMOMD | 160 | 160 |
| | 42 | M 48×2.0 | 36 | 34.0 | 55 | 51.5 | 40.5 | 40.5 | 22 | 87.0 | 63 | 3.5 | 70 | 60 | 60 | 2565 | TH42LMOMD | 160 | 160 |
| S ⁴⁾ | 06 | M 12×1.5 | 4 | 6.0 | 17 | 23.5 | 16.5 | 14.0 | 12 | 30.0 | 31 | 3.0 | 22 | 19 | 17 | 112 | TH06SMOMD | 315 | 315 |
| | 08 | M 14×1.5 | 5 | 6.0 | 19 | 23.5 | 16.5 | 14.0 | 12 | 30.0 | 31 | 3.0 | 22 | 19 | 19 | 124 | TH08SMOMD | 315 | 315 |
| | 10 | M 16×1.5 | 7 | 7.5 | 21 | 26.0 | 18.5 | 16.5 | 12 | 36.0 | 35 | 3.0 | 27 | 24 | 22 | 200 | TH10SMOMD | 315 | 315 |
| | 12 | M 18×1.5 | 8 | 9.0 | 23 | 27.5 | 20.0 | 18.5 | 12 | 39.5 | 36 | 3.0 | 27 | 27 | 24 | 261 | TH12SMOMD | 315 | 315 |
| | 16 | M 22×1.5 | 12 | 12.0 | 27 | 30.5 | 22.0 | 21.5 | 14 | 45.0 | 40 | 4.5 | 32 | 30 | 30 | 350 | TH16SMOMD | 315 | 315 |
| | 20 | M 27×2.0 | 16 | 16.0 | 32 | 37.0 | 26.5 | 24.0 | 16 | 53.0 | 48 | 3.5 | 41 | 36 | 36 | 628 | TH20SMOMD | 160 | 160 |
| | 25 | M 33×2.0 | 20 | 21.0 | 39 | 43.5 | 31.5 | 30.5 | 18 | 66.0 | 56 | 3.5 | 50 | 46 | 46 | 1106 | TH25SMOMD | 160 | 160 |
| | 30 | M 42×2.0 | 25 | 27.0 | 49 | 50.5 | 37.0 | 35.5 | 20 | 76.0 | 64 | 3.5 | 60 | 55 | 50 | 1843 | TH30SMOMD | 160 | 160 |
| | 38 | M 48×2.0 | 32 | 34.0 | 55 | 57.5 | 41.5 | 40.5 | 22 | 87.0 | 72 | 3.5 | 70 | 60 | 60 | 2741 | TH38SMOMD | 160 | 160 |

1) Pressure shown = item deliverable

3) L = light series; 4) S = heavy series

$$\frac{\text{PN (bar)}}{10} = \text{PN (MPa)}$$

Delivery without nut and ring. Information on ordering complete fittings or alternative sealing materials see page 17.

*S1=SW30 in 1.4571

| Order code suffixes | | | |
|---------------------------------|-----------------------------|-------------|---|
| Material | Suffix surface and material | Example | Standard sealing material (no additional suffix needed) |
| Steel, zinc plated, Cr(VI)-free | CF | TH16SMOMDCF | NBR |
| Stainless Steel | 71 | TH16SMOMD71 | VIT |

*Please add the suffixes below according to the material/surface required.



TH-R-KDS High pressure banjo tee

EO 24° cone end / Male BSPP thread with soft seal ring

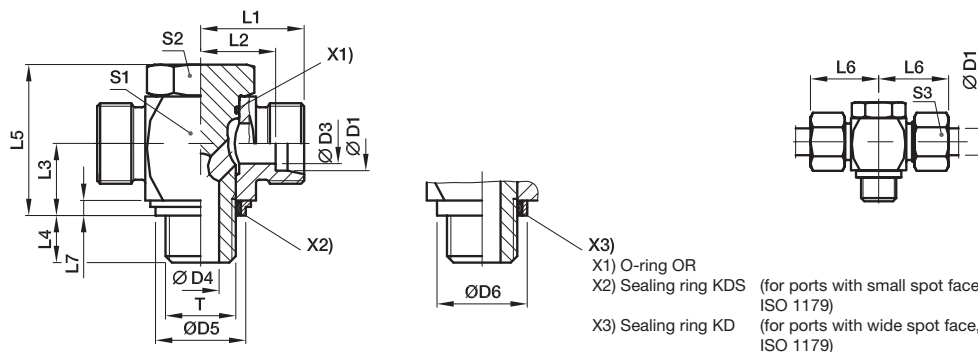

| Series | D1 | T | D3 | D4 | D5 KDS | D6 KD | L1 | L2 | L3 | L4 | L5 | L6 | L7 | S1 | S2 | S3 | Weight g/1 piece | Order code* | PN (bar) ¹⁾ | |
|-----------------|----|-----------|----|------|-----------|----------|------|------|------|----|----|----|-----|----|----|----|---------------------|--------------|------------------------|-----|
| | | | | | | | | | | | | | | | | | | | CF | 71 |
| L ³⁾ | 06 | G 1/8 A | 4 | 4.5 | 14.9 | 17 | 19.0 | 12.0 | 10.5 | 8 | 24 | 27 | 2.5 | 17 | 17 | 14 | 58 | TH06LRKDSOMD | 315 | 315 |
| | 08 | G 1/4 A | 6 | 6.0 | 18.9 | 22 | 21.5 | 14.5 | 14.0 | 12 | 30 | 29 | 3.0 | 22 | 19 | 17 | 108 | TH08LRKDSOMD | 315 | 315 |
| | 10 | G 1/4 A | 8 | 6.0 | 18.9 | 22 | 22.5 | 15.5 | 14.0 | 12 | 30 | 30 | 3.0 | 22 | 19 | 19 | 110 | TH10LRKDSOMD | 315 | 315 |
| | 12 | G 3/8 A | 10 | 7.5 | 21.9 | 27 | 25.0 | 18.0 | 16.5 | 12 | 36 | 33 | 3.0 | 27 | 24 | 22 | 193 | TH12LRKDSOMD | 315 | 315 |
| | 15 | G 1/2 A | 12 | 11.0 | 26.9 | 32 | 28.5 | 21.5 | 21.5 | 14 | 45 | 37 | 4.5 | 32 | 30 | 27 | 321 | TH15LRKDSOMD | 315 | 315 |
| | 18 | G 1/2 A | 15 | 11.0 | 26.9 | 32 | 28.5 | 21.0 | 21.5 | 14 | 45 | 37 | 4.5 | 32 | 30 | 32 | 329 | TH18LRKDSOMD | 315 | 315 |
| | 22 | G 3/4 A | 19 | 17.0 | 32.9 | 41 | 35.0 | 27.5 | 24.0 | 16 | 53 | 44 | 3.5 | 41 | 36 | 36 | 585 | TH22LRKDSOMD | 160 | 160 |
| | 28 | G 1 A | 24 | 21.0 | 39.9 | 46 | 39.5 | 32.0 | 30.5 | 18 | 66 | 49 | 3.5 | 50 | 46 | 41 | 1090 | TH28LRKDSOMD | 160 | 160 |
| | 35 | G 1 1/4 A | 30 | 27.0 | 49.9 | 57 | 46.5 | 36.0 | 35.5 | 20 | 76 | 58 | 3.5 | 60 | 55 | 50 | 1765 | TH35LRKDSOMD | 160 | 160 |
| | 42 | G 1 1/2 A | 36 | 34.0 | 55.9 | 64 | 51.5 | 40.5 | 40.5 | 22 | 87 | 63 | 3.5 | 70 | 60 | 60 | 2545 | TH42LRKDSOMD | 160 | 160 |
| S ⁴⁾ | 06 | G 1/4 A | 4 | 6.0 | 18.9 | 22 | 23.5 | 16.5 | 14.0 | 12 | 30 | 31 | 3.0 | 22 | 19 | 17 | 116 | TH06SRKDSOMD | 400 | 400 |
| | 08 | G 1/4 A | 5 | 6.0 | 18.9 | 22 | 23.5 | 16.5 | 14.0 | 12 | 30 | 31 | 3.0 | 22 | 19 | 19 | 121 | TH08SRKDSOMD | 400 | 400 |
| | 10 | G 3/8 A | 7 | 7.5 | 21.9 | 27 | 26.0 | 18.5 | 16.5 | 12 | 36 | 35 | 3.0 | 27 | 24 | 22 | 201 | TH10SRKDSOMD | 400 | 400 |
| | 12 | G 3/8 A | 8 | 7.5 | 21.9 | 27 | 26.0 | 18.5 | 16.5 | 12 | 36 | 35 | 3.0 | 27 | 24 | 24 | 207 | TH12SRKDSOMD | 400 | 400 |
| | 16 | G 1/2 A | 12 | 11.0 | 26.9 | 32 | 30.5 | 22.0 | 21.5 | 14 | 45 | 40 | 4.5 | 32 | 30 | 30 | 350 | TH16SRKDSOMD | 315 | 315 |
| | 20 | G 3/4 A | 16 | 17.0 | 32.9 | 41 | 37.0 | 26.5 | 24.0 | 16 | 53 | 48 | 3.5 | 41 | 36 | 36 | 620 | TH20SRKDSOMD | 315 | 315 |
| | 25 | G 1 A | 20 | 21.0 | 39.9 | 46 | 43.5 | 31.5 | 30.5 | 18 | 66 | 56 | 3.5 | 50 | 46 | 46 | 1124 | TH25SRKDSOMD | 250 | 250 |
| | 30 | G 1 1/4 A | 25 | 27.0 | 49.9 | 57 | 50.5 | 37.0 | 35.5 | 20 | 76 | 64 | 3.5 | 60 | 55 | 50 | 1830 | TH30SRKDSOMD | 160 | 160 |
| | 38 | G 1 1/2 A | 32 | 34.0 | 55.9 | 64 | 57.5 | 41.5 | 40.5 | 22 | 87 | 72 | 3.5 | 70 | 60 | 60 | 2721 | TH38SRKDSOMD | 160 | 160 |

¹⁾ Pressure shown = item deliverable

³⁾ L = light series; ⁴⁾ S = heavy series

PN (bar)
 10 = PN (MPa)

Delivery without nut and ring. Information on ordering complete fittings or alternative sealing materials see page 17.

*Please add the suffixes below according to the material/surface required.

| Order code suffixes | | | |
|---------------------------------|-----------------------------|----------------|---|
| Material | Suffix surface and material | Example | Standard sealing material (no additional suffix needed) |
| Steel, zinc plated, Cr(VI)-free | CF | TH16SRKDSOMDCF | NBR |
| Stainless Steel | 71 | TH16SRKDOMD71 | VIT/PTFE |

Stainless Steel only with sealing ring KD available!
 Replace KDS by KD in the order code.

DIN fittings

TH-R High pressure banjo tee

EO 24° cone end / Male BSPP thread with metal sealing ring

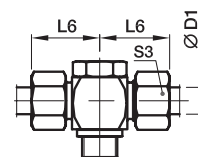
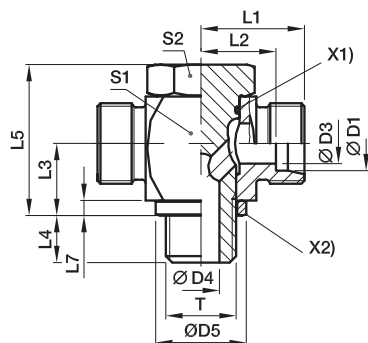
 X1) O-ring OR
 X2) Sealing ring DKA

| Series | D1 | T | D3 | D4 | D5 | L1 | L2 | L3 | L4 | L5 | L6 | L7 | S1 | S2 | S3 | Weight g/1 piece | Order code* | PN (bar) ¹⁾ | |
|-----------------|-----------|-----------|------|------|------|------|------|------|----|----|-----|-----|----|----|------|---------------------|-------------|------------------------|-----|
| | | | | | | | | | | | | | | | | | | CF | 71 |
| L ³⁾ | 06 | G 1/8 A | 4 | 4.5 | 14 | 19.0 | 12.0 | 10.5 | 8 | 24 | 27 | 2.5 | 17 | 17 | 14 | 58 | TH06LR0MD | 250 | 250 |
| | 08 | G 1/4 A | 6 | 6.0 | 18 | 21.5 | 14.5 | 14.0 | 12 | 30 | 29 | 3.0 | 22 | 19 | 17 | 108 | TH08LR0MD | 250 | 250 |
| | 10 | G 1/4 A | 8 | 6.0 | 18 | 22.5 | 15.5 | 14.0 | 12 | 30 | 30 | 3.0 | 22 | 19 | 19 | 110 | TH10LR0MD | 250 | 250 |
| | 12 | G 3/8 A | 10 | 7.5 | 22 | 25.0 | 18.0 | 16.5 | 12 | 36 | 33 | 3.0 | 27 | 24 | 22 | 193 | TH12LR0MD | 250 | 250 |
| | 15 | G 1/2 A | 12 | 11.0 | 26 | 28.5 | 21.5 | 21.5 | 14 | 45 | 37 | 4.5 | 32 | 30 | 27 | 321 | TH15LR0MD | 250 | 250 |
| | 18 | G 1/2 A | 15 | 11.0 | 26 | 28.5 | 21.0 | 21.5 | 14 | 45 | 37 | 4.5 | 32 | 30 | 32 | 329 | TH18LR0MD | 250 | 250 |
| | 22 | G 3/4 A | 19 | 17.0 | 32 | 35.0 | 27.5 | 24.0 | 16 | 53 | 44 | 3.5 | 41 | 36 | 36 | 584 | TH22LR0MD | 160 | 160 |
| | 28 | G 1 A | 24 | 21.0 | 39 | 39.5 | 32.0 | 30.5 | 18 | 66 | 49 | 3.5 | 50 | 46 | 41 | 1090 | TH28LR0MD | 160 | 160 |
| | 35 | G 1 1/4 A | 30 | 27.0 | 57 | 46.5 | 36.0 | 35.5 | 20 | 76 | 58 | 3.5 | 60 | 55 | 50 | 1766 | TH35LR0MD | 160 | 160 |
| | 42 | G 1 1/2 A | 36 | 34.0 | 55 | 51.5 | 40.5 | 40.5 | 22 | 87 | 63 | 3.5 | 70 | 60 | 60 | 2544 | TH42LR0MD | 160 | 160 |
| S ⁴⁾ | 06 | G 1/4 A | 4 | 6.0 | 18 | 23.5 | 16.5 | 14.0 | 12 | 30 | 31 | 3.0 | 22 | 19 | 17 | 116 | TH06SR0MD | 315 | 315 |
| | 08 | G 1/4 A | 5 | 6.0 | 18 | 23.5 | 16.5 | 14.0 | 12 | 30 | 31 | 3.0 | 22 | 19 | 19 | 121 | TH08SR0MD | 315 | 315 |
| | 10 | G 3/8 A | 7 | 7.5 | 22 | 26.0 | 18.5 | 16.5 | 12 | 36 | 35 | 3.0 | 27 | 24 | 22 | 201 | TH10SR0MD | 315 | 315 |
| | 12 | G 3/8 A | 8 | 7.5 | 22 | 26.0 | 18.5 | 16.5 | 12 | 36 | 35 | 3.0 | 27 | 24 | 24 | 207 | TH12SR0MD | 315 | 315 |
| | 16 | G 1/2 A | 12 | 11.0 | 26 | 30.5 | 22.0 | 21.5 | 14 | 45 | 40 | 4.5 | 32 | 30 | 30 | 350 | TH16SR0MD | 315 | 315 |
| | 20 | G 3/4 A | 16 | 17.0 | 32 | 37.0 | 26.5 | 24.0 | 16 | 53 | 48 | 3.5 | 41 | 36 | 36 | 618 | TH20SR0MD | 160 | 160 |
| | 25 | G 1 A | 20 | 21.0 | 39 | 43.5 | 31.5 | 30.5 | 18 | 66 | 56 | 3.5 | 50 | 46 | 46 | 1124 | TH25SR0MD | 160 | 160 |
| | 30 | G 1 1/4 A | 25 | 27.0 | 49 | 50.5 | 37.0 | 35.5 | 20 | 76 | 64 | 3.5 | 60 | 55 | 50 | 1831 | TH30SR0MD | 160 | 160 |
| 38 | G 1 1/2 A | 32 | 34.0 | 55 | 57.5 | 41.5 | 40.5 | 22 | 87 | 72 | 3.5 | 70 | 60 | 60 | 2720 | TH38SR0MD | 160 | 160 | |

1) Pressure shown = item deliverable

3) L = light series; 4) S = heavy series

$$\frac{\text{PN (bar)}}{10} = \text{PN (MPa)}$$

Delivery without nut and ring. Information on ordering complete fittings or alternative sealing materials see page 17.

*Please add the suffixes below according to the material/surface required.

| Order code suffixes | | | |
|---------------------------------|-----------------------------|-------------|---|
| Material | Suffix surface and material | Example | Standard sealing material (no additional suffix needed) |
| Steel, zinc plated, Cr(VI)-free | CF | TH16SR0MDCF | NBR |
| Stainless Steel | 71 | TH16SR0MD71 | VIT |



SWVE Metric male stud banjo elbow

SWVE-M EO 24° cone end / Metric male stud with metal seal ring

SWVE-M-KDS EO 24° cone end / Metric male stud with soft seal ring

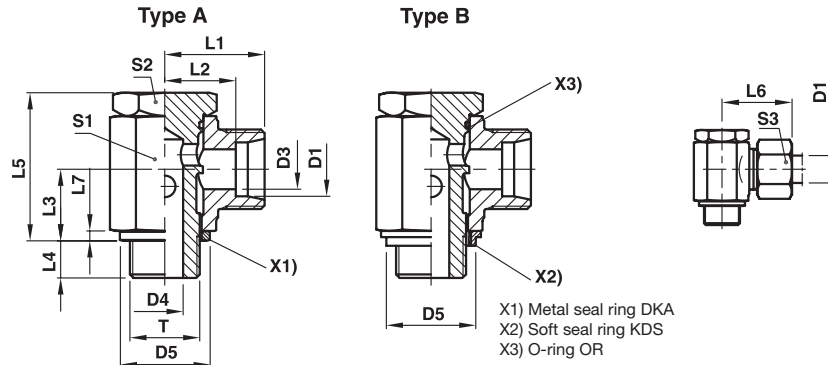

| Series | D1 | T | D3 | D4 | DKA D5 | KDS D5 | L1 | L2 | L3 | L4 | L5 | L6 | L7 | S1 | S2 | S3 | Weight g/1 piece | Type A Order code* metal sealed | Type B Order code* soft sealed | PN (bar) ¹⁾ CF |
|------------------|----------|----------|------|------|--------|--------|------|------|------|------|------|-----|-----|----|----|----|------------------|---------------------------------|--------------------------------|---------------------------|
| LL ²⁾ | 04 | M 08×1.0 | 3.0 | 3.0 | 12.5 | 15 | 14.5 | 10.5 | 8.0 | 6 | 17.0 | 20 | 2.5 | 12 | 12 | 10 | 18 | SWVE04LLMOMD | — | 63 |
| | 06 | M 10×1.0 | 4.5 | 5.0 | 14.0 | 15 | 15.5 | 10.0 | 10.0 | 6 | 21.0 | 22 | 2.5 | 14 | 14 | 12 | 29 | SWVE06LLMOMD | SWVE06LLMKDSOMD | 63 |
| | 08 | M 10×1.0 | 6.0 | 5.0 | 14.0 | 15 | 16.5 | 11.0 | 10.0 | 6 | 21.0 | 23 | 2.5 | 14 | 14 | 14 | 31 | SWVE08LLMOMD | SWVE08LLMKDSOMD | 63 |
| L ³⁾ | 06 | M 10×1.0 | 4.5 | 5.0 | 14.0 | 15 | 15.5 | 10.5 | 10.0 | 6 | 21.5 | 25 | 2.5 | 14 | 14 | 14 | 31 | SWVE06LMOMD | SWVE06LMKDSOMD | 160 |
| | 08 | M 12×1.5 | 6.0 | 6.0 | 17.0 | 17 | 19.0 | 12.0 | 12.0 | 9 | 25.0 | 27 | 3.0 | 17 | 17 | 17 | 51 | SWVE08LMOMD | SWVE08LMKDSOMD | 160 |
| | 10 | M 14×1.5 | 8.0 | 6.5 | 19.0 | 19 | 21.0 | 14.0 | 13.0 | 9 | 27.0 | 29 | 3.0 | 19 | 19 | 19 | 68 | SWVE10LMOMD | SWVE10LMKDSOMD | 160 |
| | 12 | M 16×1.5 | 10.0 | 8.5 | 21.0 | 22 | 22.5 | 15.5 | 15.0 | 9 | 32.0 | 30 | 3.0 | 22 | 21 | 22 | 100 | SWVE12LMOMD | SWVE12LMKDSOMD | 100 |
| | 15 | M 18×1.5 | 12.0 | 11.0 | 23.0 | 24 | 24.5 | 17.5 | 18.0 | 9 | 37.5 | 33 | 3.0 | 24 | 24 | 27 | 138 | SWVE15LMOMD | SWVE15LMKDSOMD | 100 |
| | 18 | M 22×1.5 | 15.0 | 13.0 | 27.0 | 27 | 28.0 | 20.5 | 21.5 | 11 | 44.5 | 37 | 4.5 | 30 | 27 | 32 | 241 | SWVE18LMOMD | SWVE18LMKDSOMD | 100 |
| | 22 | M 26×1.5 | 19.0 | 18.0 | 31.0 | 32 | 33.0 | 25.5 | 24.0 | 13 | 49.0 | 42 | 3.5 | 36 | 32 | 36 | 351 | SWVE22LMOMD | SWVE22LMKDSOMD | 100 |
| | 28 | M 33×2.0 | 24.0 | 22.0 | 39.0 | 40 | 39.5 | 32.0 | 30.5 | 14 | 66.5 | 49 | 3.5 | 50 | 46 | 41 | | SWVE28LMOMD | SWVE28LMKDSOMD | 100 |
| | 35 | M 42×2.0 | 30.0 | 29.0 | 49.0 | 50 | 46.5 | 36.0 | 35.5 | 16 | 76.0 | 58 | 3.5 | 60 | 55 | 50 | | SWVE35LMOMD | SWVE35LMKDSOMD | 100 |
| | 42 | M 48×2.0 | 36.0 | 35.0 | 55.0 | 56 | 51.5 | 40.5 | 40.5 | 18 | 86.0 | 63 | 3.5 | 70 | 60 | 60 | | SWVE42LMOMD | SWVE42LMKDSOMD | 100 |
| S ⁴⁾ | 06 | M 12×1.5 | 4.0 | 6.0 | 17.0 | 17 | 21.0 | 14.0 | 12.0 | 9 | 25.0 | 29 | 3.0 | 17 | 17 | 17 | 55 | SWVE06SMOMD | SWVE06SMKDSOMD | 160 |
| | 08 | M 14×1.5 | 5.0 | 6.5 | 19.0 | 19 | 22.0 | 15.0 | 13.0 | 9 | 27.0 | 30 | 3.0 | 19 | 19 | 19 | 75 | SWVE08SMOMD | SWVE08SMKDSOMD | 160 |
| | 10 | M 16×1.5 | 7.0 | 8.5 | 21.0 | 22 | 23.5 | 16.0 | 15.0 | 9 | 32.0 | 32 | 3.0 | 22 | 22 | 22 | 106 | SWVE10SMOMD | SWVE10SMKDSOMD | 100 |
| | 12 | M 18×1.5 | 8.0 | 11.0 | 23.0 | 24 | 24.5 | 17.0 | 18.0 | 9 | 37.0 | 33 | 3.0 | 24 | 24 | 24 | 134 | SWVE12SMOMD | SWVE12SMKDSOMD | 100 |
| | 16 | M 22×1.5 | 12.0 | 13.0 | 27.0 | 27 | 30.0 | 21.5 | 21.5 | 11 | 44.5 | 40 | 4.5 | 30 | 27 | 30 | 252 | SWVE16SMOMD | SWVE16SMKDSOMD | 100 |
| | 20 | M 27×2.0 | 16.0 | 18.0 | 32.0 | 33 | 35.0 | 24.5 | 24.0 | 13 | 49.0 | 46 | 3.5 | 36 | 32 | 36 | 363 | SWVE20SMOMD | SWVE20SMKDSOMD | 100 |
| | 25 | M 33×2.0 | 20.0 | 22.0 | 39.0 | 40 | 43.5 | 31.5 | 30.5 | 14 | 66.5 | 56 | 3.5 | 50 | 46 | 46 | | SWVE25SMOMD | SWVE25SMKDSOMD | 100 |
| | 30 | M 42×2.0 | 25.0 | 29.0 | 49.0 | 50 | 50.5 | 37.0 | 35.5 | 16 | 76.0 | 64 | 3.5 | 60 | 55 | 50 | | SWVE30SMOMD | SWVE30SMKDSOMD | 100 |
| 38 | M 48×2.0 | 32.0 | 35.0 | 55.0 | 56 | 57.5 | 41.5 | 40.5 | 18 | 86.0 | 72 | 3.5 | 70 | 60 | 60 | | SWVE38SMOMD | SWVE38SMKDSOMD | 100 | |

1) Pressure shown = item deliverable

2) LL = very light series; 3) L = light series; 4) S = heavy series

PN (bar) = PN (MPa) / 10

Delivery without nut and ring. Information on ordering complete fittings or alternative sealing materials see page 17.

| Order code suffixes | | | |
|---------------------------------|-----------------------------|------------------|---|
| Material | Suffix surface and material | Example | Standard sealing material (no additional suffix needed) |
| Steel, zinc plated, Cr(VI)-free | CF | SWVE16SMOMDCF | NBR |
| Steel, zinc plated, Cr(VI)-free | CF | SWVE16SMKDSOMDCF | NBR |

*Please add the suffixes below according to the material/surface required.

SWVE BSPP male stud banjo elbow

SWVE-R EO 24° cone end / BSPP male stud with metal seal ring
 SWVE-R-KDS EO 24° cone end / BSPP male stud with soft seal ring

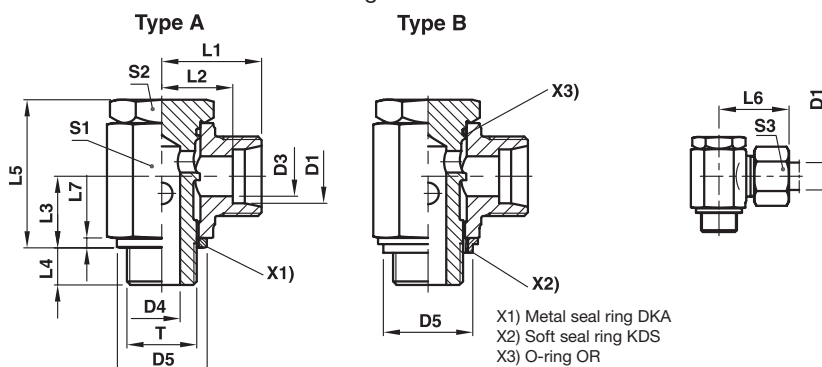

| Series | D1 | T | D3 | D4 | DKA D5 | KDS D5 | L1 | L2 | L3 | L4 | L5 | L6 | L7 | S1 | S2 | S3 | Weight g/1 piece | Type A Order code* metal sealed | Type B Order code* soft sealed | PN (bar) ¹⁾ CF |
|------------------|----|-----------|------|------|--------|--------|------|------|------|----|------|----|-----|----|----|----|------------------|---------------------------------|--------------------------------|---------------------------|
| LL ²⁾ | 04 | G 1/8 A | 3.0 | 5.0 | 14 | 15 | 15.5 | 11.5 | 10.0 | 6 | 21.0 | 21 | 2.5 | 14 | 14 | 10 | 28 | SWVE04LLROMD | SWVE04LLRKDSOMD | 63 |
| | 06 | G 1/8 A | 4.5 | 5.0 | 14 | 15 | 15.5 | 10.0 | 10.0 | 6 | 21.5 | 22 | 2.5 | 14 | 14 | 12 | 28 | SWVE06LLROMD | SWVE06LLRKDSOMD | 63 |
| | 08 | G 1/8 A | 6.0 | 5.0 | 14 | 15 | 16.5 | 11.0 | 10.0 | 6 | 21.0 | 23 | 2.5 | 14 | 14 | 14 | 30 | SWVE08LLROMD | SWVE08LLRKDSOMD | 63 |
| L ³⁾ | 06 | G 1/8 A | 4.0 | 5.0 | 14 | 15 | 17.5 | 10.5 | 10.0 | 6 | 21.0 | 25 | 2.5 | 14 | 14 | 14 | 31 | SWVE06LROMD | SWVE06LRKDSOMD | 160 |
| | 08 | G 1/4 A | 6.0 | 6.5 | 18 | 19 | 20.0 | 13.0 | 13.0 | 9 | 27.0 | 28 | 3.0 | 19 | 19 | 17 | 65 | SWVE08LROMD | SWVE08LRKDSOMD | 160 |
| | 10 | G 1/4 A | 8.0 | 6.5 | 18 | 19 | 21.0 | 14.0 | 13.0 | 9 | 27.0 | 29 | 3.0 | 19 | 19 | 19 | 66 | SWVE10LROMD | SWVE10LRKDSOMD | 160 |
| | 12 | G 3/8 A | 10.0 | 8.5 | 22 | 22 | 22.5 | 15.5 | 15.0 | 9 | 32.0 | 30 | 3.0 | 22 | 22 | 22 | 102 | SWVE12LROMD | SWVE12LRKDSOMD | 100 |
| | 15 | G 1/2 A | 12.0 | 11.0 | 26 | 27 | 26.0 | 19.0 | 18.0 | 11 | 37.5 | 34 | 4.5 | 27 | 27 | 27 | 171 | SWVE15LROMD | SWVE15LRKDSOMD | 100 |
| | 18 | G 1/2 A | 15.0 | 13.0 | 26 | 27 | 28.0 | 20.5 | 21.5 | 11 | 44.5 | 37 | 4.5 | 30 | 27 | 32 | 249 | SWVE18LROMD | SWVE18LRKDSOMD | 100 |
| | 22 | G 3/4 A | 19.0 | 18.0 | 32 | 33 | 33.0 | 25.5 | 24.0 | 13 | 49.0 | 42 | 3.5 | 36 | 32 | 36 | 349 | SWVE22LROMD | SWVE22LRKDSOMD | 100 |
| | 28 | G 1 A | 24.0 | 22.0 | 39 | 40 | 39.5 | 32.0 | 30.5 | 14 | 66.5 | 49 | 3.5 | 50 | 46 | 41 | | SWVE28LROMD | SWVE28LRKDSOMD | 100 |
| | 35 | G 1 1/4 A | 30.0 | 29.0 | 49 | 50 | 46.5 | 36.0 | 35.5 | 16 | 76.0 | 58 | 3.5 | 60 | 55 | 50 | | SWVE35LROMD | SWVE35LRKDSOMD | 100 |
| | 42 | G 1 1/2 A | 36.0 | 35.0 | 55 | 56 | 51.5 | 40.5 | 40.5 | 18 | 86.0 | 63 | 3.5 | 70 | 60 | 60 | | SWVE42LROMD | SWVE42LRKDSOMD | 100 |
| S ⁴⁾ | 06 | G 1/4 A | 4.0 | 6.5 | 18 | 19 | 22.0 | 15.0 | 13.0 | 9 | 27.0 | 30 | 3.0 | 19 | 19 | 17 | 69 | SWVE06SRROMD | SWVE06SRKDSOMD | 160 |
| | 08 | G 1/4 A | 5.0 | 6.5 | 18 | 19 | 22.0 | 15.0 | 13.0 | 9 | 27.0 | 30 | 3.0 | 19 | 19 | 19 | 73 | SWVE08SRROMD | SWVE08SRKDSOMD | 160 |
| | 10 | G 3/8 A | 7.0 | 8.5 | 22 | 22 | 23.5 | 16.0 | 15.0 | 9 | 32.0 | 32 | 3.0 | 22 | 22 | 22 | 108 | SWVE10SRROMD | SWVE10SRKDSOMD | 100 |
| | 12 | G 3/8 A | 8.0 | 8.0 | 22 | 22 | 24.5 | 17.0 | 18.0 | 9 | 37.0 | 33 | 3.0 | 24 | 24 | 24 | 147 | SWVE12SRROMD | SWVE12SRKDSOMD | 100 |
| | 16 | G 1/2 A | 12.0 | 13.0 | 26 | 27 | 30.0 | 21.5 | 21.5 | 11 | 44.5 | 40 | 4.5 | 30 | 27 | 30 | 249 | SWVE16SRROMD | SWVE16SRKDSOMD | 100 |
| | 20 | G 3/4 A | 16.0 | 18.0 | 32 | 33 | 35.0 | 24.5 | 24.0 | 13 | 49.0 | 46 | 3.5 | 36 | 32 | 36 | 359 | SWVE20SRROMD | SWVE20SRKDSOMD | 100 |
| | 25 | G 1 A | 20.0 | 22.0 | 39 | 40 | 43.5 | 31.5 | 30.5 | 14 | 66.5 | 56 | 3.5 | 50 | 46 | 46 | | SWVE25SRROMD | SWVE25SRKDSOMD | 100 |
| | 30 | G 1 1/4 A | 25.0 | 29.0 | 49 | 50 | 50.5 | 37.0 | 35.5 | 16 | 76.0 | 64 | 3.5 | 60 | 55 | 50 | | SWVE30SRROMD | SWVE30SRKDSOMD | 100 |
| | 38 | G 1 1/2 A | 32.0 | 35.0 | 55 | 56 | 57.5 | 41.5 | 40.5 | 18 | 86.0 | 72 | 3.5 | 70 | 60 | 60 | | SWVE38SRROMD | SWVE38SRKDSOMD | 100 |

1) Pressure shown = item deliverable

2) LL = very light series; 3) L = light series; 4) S = heavy series

PN (bar) = PN (MPa) / 10

Delivery without nut and ring. Information on ordering complete fittings see page I7.

*Please add the suffixes below according to the material/surface required.

| Order code suffixes | | | |
|---------------------------------|-----------------------------|------------------|---|
| Material | Suffix surface and material | Example | Standard sealing material (no additional suffix needed) |
| Steel, zinc plated, Cr(VI)-free | CF | SWVE16SRROMDCF | NBR |
| Steel, zinc plated, Cr(VI)-free | CF | SWVE16SRKDSOMDCF | NBR |



WE-NPT Male stud elbow

EO 24° cone end / Male NPT thread (SAE J476)

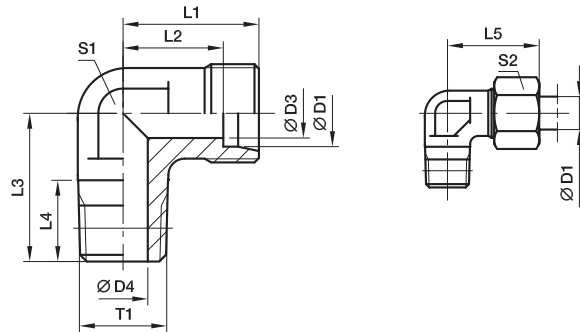

| Series | D1 | T1 | D3 | D4 | L1 | L2 | L3 | L4 | L5 | S1 | S2 | Weight g/1 piece | Order code* | PN (bar) ¹⁾ | | | |
|------------------|-----------------|----------------|------------|------|------|------|------|------|------|----|----|---------------------|--------------|------------------------|-----|-----|-----|
| | | | | | | | | | | | | | | CF | 71 | MS | |
| LL ²⁾ | 04 | 1/8-27 NPT | 3.0 | 4.0 | 15 | 11.0 | 17 | 10.0 | 21 | 9 | 10 | 18 | WE04LL1/8NPT | 100 | | | |
| | 06 | 1/8-27 NPT | 4.5 | 4.5 | 15 | 9.5 | 17 | 10.0 | 21 | 9 | 12 | 17 | WE06LL1/8NPT | 100 | | | |
| | 08 | 1/8-27 NPT | 6.0 | 5.0 | 17 | 11.5 | 20 | 10.0 | 23 | 12 | 14 | 25 | WE08LL1/8NPT | 100 | | | |
| L ³⁾ | 06 | 1/8-27 NPT | 4.0 | 4.0 | 19 | 12.0 | 20 | 10.0 | 27 | 12 | 14 | 29 | WE06L1/8NPT | 315 | 315 | 200 | |
| | 06 | 1/4-18 NPT | 4.0 | 7.0 | 21 | 14.0 | 26 | 14.5 | 29 | 12 | 14 | 44 | WE06L1/4NPT | 315 | 315 | 200 | |
| | 06 | 3/8-18 NPT | 4.0 | 8.0 | 25 | 18.0 | 28 | 14.5 | 33 | 17 | 14 | 55 | WE06L3/8NPT | 315 | 315 | 200 | |
| | 08 | 1/8-27 NPT | 6.0 | 4.0 | 21 | 14.0 | 26 | 10.0 | 29 | 12 | 17 | 48 | WE08L1/8NPT | 315 | 315 | 200 | |
| | 08 | 1/4-18 NPT | 6.0 | 6.0 | 21 | 14.0 | 26 | 14.5 | 29 | 12 | 17 | 47 | WE08L1/4NPT | 315 | 315 | 200 | |
| | 10 | 1/4-18 NPT | 8.0 | 7.0 | 22 | 15.0 | 27 | 14.5 | 30 | 14 | 19 | 61 | WE10L1/4NPT | 315 | 315 | 200 | |
| | 10 | 3/8-18 NPT | 8.0 | 8.0 | 24 | 17.0 | 28 | 14.5 | 32 | 17 | 19 | 92 | WE10L3/8NPT | 315 | 315 | 200 | |
| | 12 | 1/4-18 NPT | 10.0 | 7.0 | 24 | 17.0 | 28 | 14.5 | 32 | 17 | 22 | 82 | WE12L1/4NPT | 315 | 315 | 200 | |
| | 12 | 3/8-18 NPT | 10.0 | 8.0 | 24 | 17.0 | 28 | 14.5 | 32 | 17 | 22 | 92 | WE12L3/8NPT | 315 | 315 | 200 | |
| | 12 | 1/2-14 NPT | 10.0 | 11.0 | 28 | 21.0 | 34 | 19.5 | 36 | 19 | 22 | 90 | WE12L1/2NPT | 315 | 315 | 200 | |
| | 15 | 1/2-14 NPT | 12.0 | 11.0 | 28 | 21.0 | 34 | 19.5 | 36 | 19 | 27 | 89 | WE15L1/2NPT | 315 | 315 | 200 | |
| | 18 | 1/2-14 NPT | 15.0 | 12.0 | 31 | 23.5 | 36 | 19.5 | 40 | 24 | 32 | 150 | WE18L1/2NPT | 315 | 315 | 200 | |
| | 22 | 3/4-14 NPT | 19.0 | 16.0 | 35 | 27.5 | 42 | 19.5 | 44 | 27 | 36 | 176 | WE22L3/4NPT | 160 | 160 | 100 | |
| | 28 | 1-11.5 NPT | 24.0 | 21.0 | 38 | 30.5 | 48 | 24.5 | 47 | 36 | 41 | 314 | WE28L1NPT | 160 | 160 | 100 | |
| | 35 | 1 1/4-11.5 NPT | 30.0 | 28.0 | 45 | 34.5 | 54 | 25.0 | 56 | 41 | 50 | 465 | WE35L11/4NPT | 160 | 160 | 100 | |
| | 42 | 1 1/2-11.5 NPT | 36.0 | 34.0 | 51 | 40.0 | 61 | 26.0 | 63 | 50 | 60 | 849 | WE42L11/2NPT | 160 | 160 | 100 | |
| | S ⁴⁾ | 06 | 1/4-18 NPT | 4.0 | 4.0 | 23 | 16.0 | 26 | 14.5 | 31 | 12 | 17 | 56 | WE06S1/4NPT | 630 | 630 | 400 |
| | | 08 | 1/4-18 NPT | 5.0 | 5.0 | 24 | 17.0 | 27 | 14.5 | 32 | 14 | 19 | 73 | WE08S1/4NPT | 630 | 630 | 400 |
| | | 08 | 3/8-18 NPT | 5.0 | 8.0 | 25 | 18.0 | 28 | 14.5 | 33 | 17 | 19 | 77 | WE08S3/8NPT | 630 | 630 | 400 |
| | | 08 | 1/2-14 NPT | 5.0 | 10.0 | 30 | 23.0 | 34 | 19.5 | 38 | 19 | 19 | 75 | WE08S1/2NPT | 630 | 630 | 400 |
| 10 | | 1/4-18 NPT | 7.0 | 5.0 | 25 | 17.5 | 28 | 14.5 | 34 | 17 | 22 | 96 | WE10S1/4NPT | 630 | 630 | 400 | |
| 10 | | 3/8-18 NPT | 7.0 | 7.0 | 25 | 17.5 | 28 | 14.5 | 34 | 17 | 22 | 98 | WE10S3/8NPT | 630 | 630 | 400 | |
| 12 | | 1/4-18 NPT | 8.0 | 5.0 | 29 | 21.5 | 29 | 14.5 | 38 | 17 | 24 | 73 | WE12S1/4NPT | 630 | 630 | 400 | |
| 12 | | 3/8-18 NPT | 8.0 | 8.0 | 29 | 22.5 | 28 | 14.5 | 38 | 17 | 24 | 123 | WE12S3/8NPT | 630 | 630 | 400 | |
| 12 | | 1/2-14 NPT | 8.0 | 10.0 | 30 | 22.5 | 34 | 19.5 | 39 | 19 | 24 | 107 | WE12S1/2NPT | 630 | 630 | 400 | |
| 16 | | 1/2-14 NPT | 12.0 | 12.0 | 33 | 24.5 | 36 | 19.5 | 43 | 24 | 30 | 157 | WE16S1/2NPT | 400 | 400 | 250 | |
| 20 | | 3/4-14 NPT | 16.0 | 16.0 | 37 | 26.5 | 42 | 19.5 | 48 | 27 | 36 | 205 | WE20S3/4NPT | 400 | 400 | 250 | |
| 25 | | 1-11.5 NPT | 20.0 | 20.0 | 42 | 30.0 | 48 | 24.5 | 54 | 36 | 46 | 381 | WE25S1NPT | 400 | 400 | 250 | |
| 30 | | 1 1/4-11.5 NPT | 25.0 | 25.0 | 49 | 35.5 | 54 | 25.0 | 62 | 41 | 50 | 598 | WE30S11/4NPT | 400 | 400 | 250 | |
| 38 | | 1 1/2-11.5 NPT | 32.0 | 32.0 | 57 | 41.0 | 61 | 26.0 | 72 | 50 | 60 | 1029 | WE38S11/2NPT | 315 | 315 | 200 | |

¹⁾ Pressure shown = item deliverable

²⁾ LL = very light series; ³⁾ L = light series; ⁴⁾ S = heavy series

$\frac{PN \text{ (bar)}}{10} = PN \text{ (MPa)}$

Delivery without nut and ring. Information on ordering complete fittings see page 17.

*Please add the **suffixes** below according to the material/surface required.

| Order code suffixes | | |
|---------------------------------|-----------------------------|----------------|
| Material | Suffix surface and material | Example |
| Steel, zinc plated, Cr(VI)-free | CFX | WE16S1/2NPTCFX |
| Stainless Steel | 71X | WE16S1/2NPT71X |
| Brass | MSX | WE16S1/2NPTMSX |



DIN fittings

WE-M(KEG) Male stud elbow

EO 24° cone end / Male metric taper thread (DIN 3852-1, type C)

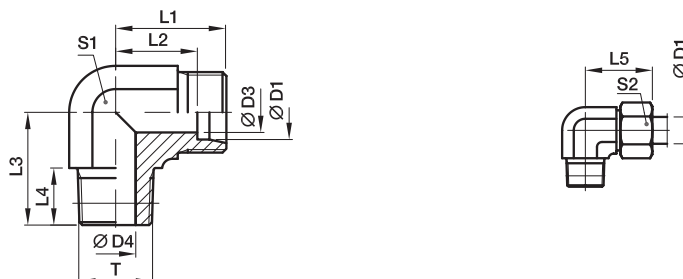

| Series | D1 | T | D3 | D4 | L1 | L2 | L3 | L4 | L5 | S1 | S2 | Weight g/1 piece | Order code* | PN (bar) ¹⁾ | | |
|------------------|---------------|---------------|------|------|------|------|----|----|----|----|-----|---------------------|----------------|------------------------|-----|-----|
| | | | | | | | | | | | | | | CF | 71 | MS |
| LL ²⁾ | 04 | M 08×1.0 tap. | 3.0 | 3.5 | 15 | 11.0 | 17 | 8 | 21 | 9 | 10 | 14 | WE04LLM | 100 | 100 | 63 |
| | 06 | M 10×1.0 tap. | 4.5 | 4.5 | 15 | 9.5 | 17 | 8 | 21 | 9 | 12 | 17 | WE06LLM | 100 | 100 | 63 |
| | 08 | M 10×1.0 tap. | 6.0 | 6.0 | 17 | 11.5 | 20 | 8 | 23 | 12 | 14 | 25 | WE08LLM | 100 | 100 | 63 |
| L ³⁾ | 06 | M 10×1.0 tap. | 4.0 | 4.0 | 19 | 12.0 | 20 | 8 | 27 | 12 | 14 | 29 | WE06LM | 315 | 315 | 200 |
| | 08 | M 12×1.5 tap. | 6.0 | 6.0 | 21 | 14.0 | 26 | 12 | 29 | 12 | 17 | 46 | WE08LM | 315 | 315 | 200 |
| | 10 | M 14×1.5 tap. | 8.0 | 7.0 | 22 | 15.0 | 27 | 12 | 30 | 14 | 19 | 62 | WE10LM | 315 | 315 | 200 |
| | 12 | M 16×1.5 tap. | 10.0 | 9.0 | 24 | 17.0 | 28 | 12 | 32 | 17 | 22 | 89 | WE12LM | 315 | 315 | 200 |
| | 15 | M 18×1.5 tap. | 12.0 | 11.0 | 28 | 21.0 | 32 | 12 | 36 | 19 | 27 | 78 | WE15LM | 315 | 315 | 200 |
| S ⁴⁾ | 18 | M 22×1.5 tap. | 15.0 | 14.0 | 31 | 23.0 | 36 | 14 | 40 | 24 | 32 | 148 | WE18LM | 315 | 315 | 200 |
| | 06 | M 12×1.5 tap. | 4.0 | 4.0 | 23 | 16.0 | 26 | 12 | 31 | 12 | 17 | 53 | WE06SM | 400 | 400 | 250 |
| | 08 | M 14×1.5 tap. | 5.0 | 5.0 | 24 | 17.0 | 27 | 12 | 32 | 14 | 19 | 78 | WE08SM | 400 | 400 | 250 |
| | 10 | M 16×1.5 tap. | 7.0 | 7.0 | 25 | 17.5 | 28 | 12 | 34 | 17 | 22 | 102 | WE10SM | 400 | 400 | 250 |
| | 12 | M 18×1.5 tap. | 8.0 | 8.0 | 29 | 21.5 | 28 | 12 | 38 | 17 | 24 | 134 | WE12SM | 400 | 400 | 250 |
| 16 | M 22×1.5 tap. | 12.0 | 12.0 | 33 | 24.5 | 32 | 14 | 43 | 24 | 30 | 161 | WE16SM | 400 | 400 | 250 | |

¹⁾ Pressure shown = item deliverable

²⁾ LL = very light series; ³⁾ L = light series; ⁴⁾ S = heavy series

$$\frac{\text{PN (bar)}}{10} = \text{PN (MPa)}$$

Delivery without nut and ring. Information on ordering complete fittings see page 17.

| Order code suffixes | | |
|---------------------------------|-----------------------------|-----------|
| Material | Suffix surface and material | Example |
| Steel, zinc plated, Cr(VI)-free | CFX | WE16SMCFX |
| Stainless Steel | 71X | WE16SM71X |
| Brass | MSX | WE16SMMSX |

 *Please add the **suffixes** below according to the material/surface required.



WE-M Male stud elbow

EO 24° cone end / Male metric thread – metal sealing edge (ISO 9974)

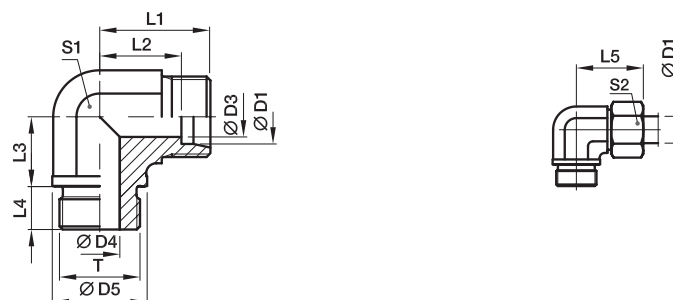

| Series | D1 | T | D3 | D4 | D5 | L1 | L2 | L3 | L4 | L5 | S1 | S2 | Weight g/1 piece | Order code* | PN (bar) ¹⁾ | |
|-----------------|----|----------|----|----|----|----|------|----|----|----|----|----|---------------------|---------------|------------------------|-----|
| | | | | | | | | | | | | | | | CF | 71 |
| L ³⁾ | 22 | M 26×1.5 | 19 | 18 | 31 | 35 | 27.5 | 26 | 16 | 44 | 27 | 36 | 173 | WE22LM | 160 | 160 |
| | 28 | M 33×2.0 | 24 | 23 | 39 | 38 | 30.5 | 30 | 18 | 47 | 36 | 41 | 303 | WE28LM | 160 | 160 |
| | 35 | M 42×2.0 | 30 | 30 | 49 | 45 | 34.5 | 34 | 20 | 56 | 41 | 50 | 469 | WE35LM | 160 | 160 |
| | 42 | M 48×2.0 | 36 | 36 | 55 | 51 | 40.0 | 39 | 22 | 63 | 50 | 60 | 661 | WE42LM | 160 | 160 |
| S ⁴⁾ | 20 | M 27×2.0 | 16 | 16 | 32 | 37 | 26.5 | 26 | 16 | 48 | 27 | 36 | 208 | WE20SM | 400 | 400 |
| | 25 | M 33×2.0 | 20 | 20 | 39 | 42 | 30.0 | 30 | 18 | 54 | 36 | 46 | 396 | WE25SM | 250 | 250 |
| | 30 | M 42×2.0 | 25 | 25 | 49 | 49 | 35.5 | 34 | 20 | 62 | 41 | 50 | 632 | WE30SM | 160 | 160 |
| | 38 | M 48×2.0 | 32 | 32 | 55 | 57 | 41.0 | 39 | 22 | 72 | 50 | 60 | 907 | WE38SM | 160 | 160 |

¹⁾ Pressure shown = item deliverable

³⁾ L = light series; ⁴⁾ S = heavy series

$\frac{\text{PN (bar)}}{10} = \text{PN (MPa)}$

Delivery without nut and ring. Information on ordering complete fittings see page 17.

| Order code suffixes | | |
|---------------------------------|-----------------------------|-----------|
| Material | Suffix surface and material | Example |
| Steel, zinc plated, Cr(VI)-free | CFX | WE20SMCFX |
| Stainless Steel | 71X | WE20SM71X |

*Please add the **suffixes** below according to the material/surface required.

WE-R Male stud elbow

EO 24° cone end / Male BSPP thread – metal sealing edge (ISO 1179)

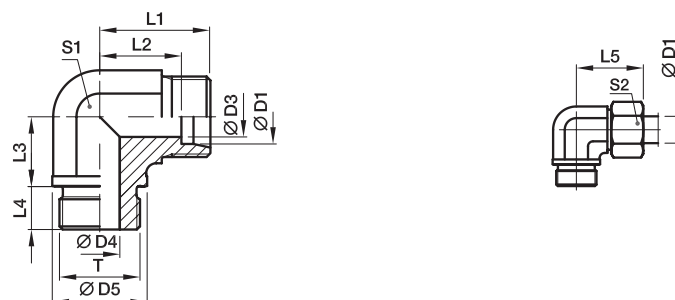

| Series | D1 | T | D3 | D4 | D5 | L1 | L2 | L3 | L4 | L5 | S1 | S2 | Weight g/1 piece | Order code* | PN (bar) ¹⁾ | | |
|-----------------|----|-----------|----|----|----|----|------|----|----|----|----|----|---------------------|---------------|------------------------|-----|-----|
| | | | | | | | | | | | | | | | CF | 71 | MS |
| L ³⁾ | 22 | G 3/4 A | 19 | 18 | 32 | 35 | 27.5 | 26 | 16 | 44 | 27 | 36 | 168 | WE22LR | 160 | 160 | 100 |
| | 28 | G 1 A | 24 | 23 | 39 | 38 | 30.5 | 30 | 18 | 47 | 36 | 41 | 305 | WE28LR | 160 | 160 | 100 |
| | 35 | G 1 1/4 A | 30 | 30 | 49 | 45 | 34.5 | 34 | 20 | 56 | 41 | 50 | 465 | WE35LR | 160 | 160 | 100 |
| | 42 | G 1 1/2 A | 36 | 36 | 55 | 51 | 40.0 | 39 | 22 | 63 | 50 | 60 | 706 | WE42LR | 160 | 160 | 100 |
| S ⁴⁾ | 20 | G 3/4 A | 16 | 16 | 32 | 37 | 26.5 | 26 | 16 | 48 | 27 | 36 | 210 | WE20SR | 400 | 400 | 250 |
| | 25 | G 1 A | 20 | 20 | 39 | 42 | 30.0 | 30 | 18 | 54 | 36 | 46 | 388 | WE25SR | 250 | 250 | 160 |
| | 30 | G 1 1/4 A | 25 | 25 | 49 | 49 | 35.5 | 34 | 20 | 62 | 41 | 50 | 630 | WE30SR | 160 | 160 | 100 |
| | 38 | G 1 1/2 A | 32 | 32 | 55 | 57 | 41.0 | 39 | 22 | 72 | 50 | 60 | 888 | WE38SR | 160 | 160 | 100 |

¹⁾ Pressure shown = item deliverable

³⁾ L = light series; ⁴⁾ S = heavy series

$\frac{\text{PN (bar)}}{10} = \text{PN (MPa)}$

Delivery without nut and ring. Information on ordering complete fittings see page 17.

| Order code suffixes | | |
|---------------------------------|-----------------------------|-----------|
| Material | Suffix surface and material | Example |
| Steel, zinc plated, Cr(VI)-free | CFX | WE20SRCFX |
| Stainless Steel | 71X | WE20SR71X |
| Brass | MSX | WE20SRMSX |

*Please add the **suffixes** below according to the material/surface required.

WE-R (KEG) Male stud elbow

EO 24° cone end / Male short BSP taper thread (DIN 3852-2, type C)

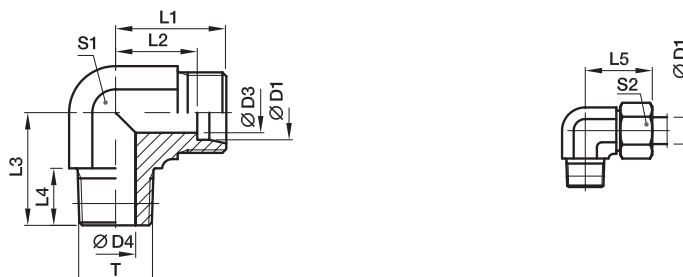

| Series | D1 | T | D3 | D4 | L1 | L2 | L3 | L4 | L5 | S1 | S2 | Weight g/1 piece | Order code* | PN (bar) ¹⁾ | | |
|------------------|----|------------|------|------|----|------|----|----|----|----|----|---------------------|------------------|------------------------|-----|-----|
| | | | | | | | | | | | | | | CF | 71 | MS |
| LL ²⁾ | 04 | R 1/8 tap. | 3.0 | 4.0 | 15 | 11.0 | 17 | 8 | 21 | 9 | 10 | 17 | WE04LLR | 100 | 100 | 63 |
| | 06 | R 1/8 tap. | 4.5 | 4.5 | 15 | 9.5 | 17 | 8 | 21 | 9 | 12 | 17 | WE06LLR | 100 | 100 | 63 |
| | 08 | R 1/8 tap. | 6.0 | 6.0 | 17 | 11.5 | 20 | 8 | 23 | 12 | 14 | 24 | WE08LLR | 100 | 100 | 63 |
| | 10 | R 1/4 tap. | 8.0 | 7.0 | 18 | 12.5 | 23 | 12 | 24 | 12 | 17 | 36 | WE10LLR | 100 | | |
| | 12 | R 1/4 tap. | 10.0 | 7.0 | 19 | 13.0 | 23 | 12 | 25 | 14 | 19 | 46 | WE12LLR | 100 | | |
| L ³⁾ | 06 | R 1/8 tap. | 4.0 | 4.0 | 19 | 12.0 | 20 | 8 | 27 | 12 | 14 | 30 | WE06LR | 315 | 315 | 200 |
| | 06 | R 1/4 tap. | 4.0 | 6.0 | 21 | 14.0 | 26 | 12 | 29 | 12 | 14 | 47 | WE06LR1/4 | 315 | 315 | |
| | 08 | R 1/4 tap. | 6.0 | 6.0 | 21 | 14.0 | 26 | 12 | 29 | 12 | 17 | 46 | WE08LR | 315 | 315 | 200 |
| | 08 | R 1/8 tap. | 6.0 | 4.0 | 21 | 14.0 | 26 | 8 | 29 | 12 | 17 | 49 | WE08LR1/8 | 315 | 315 | |
| | 08 | R 3/8 tap. | 6.0 | 9.0 | 24 | 17.0 | 28 | 12 | 32 | 17 | 17 | 94 | WE08LR3/8 | 315 | 315 | |
| | 10 | R 1/4 tap. | 8.0 | 7.0 | 22 | 15.0 | 27 | 12 | 30 | 14 | 19 | 61 | WE10LR | 315 | 315 | 200 |
| | 10 | R 3/8 tap. | 8.0 | 9.0 | 24 | 17.0 | 28 | 12 | 32 | 17 | 19 | 87 | WE10LR3/8 | 315 | 315 | |
| | 12 | R 3/8 tap. | 10.0 | 9.0 | 24 | 17.0 | 28 | 12 | 32 | 17 | 22 | 88 | WE12LR | 315 | 315 | 200 |
| | 12 | R 1/4 tap. | 10.0 | 7.0 | 24 | 17.0 | 27 | 12 | 32 | 17 | 22 | 80 | WE12LR1/4 | 315 | 315 | |
| | 12 | R 1/2 tap. | 10.0 | 11.0 | 28 | 21.0 | 34 | 14 | 36 | 19 | 22 | 89 | WE12LR1/2 | 315 | 315 | |
| | 15 | R 1/2 tap. | 12.0 | 11.0 | 28 | 21.0 | 34 | 14 | 36 | 19 | 27 | 94 | WE15LR | 315 | 315 | 200 |
| | 18 | R 1/2 tap. | 15.0 | 14.0 | 31 | 23.5 | 36 | 14 | 40 | 24 | 32 | 141 | WE18LR | 315 | 315 | 200 |
| S ⁴⁾ | 06 | R 1/4 tap. | 4.0 | 4.0 | 23 | 16.0 | 26 | 12 | 31 | 12 | 17 | 56 | WE06SR | 400 | 400 | 250 |
| | 06 | R 3/8 tap. | 4.0 | 7.0 | 25 | 18.0 | 28 | 12 | 33 | 17 | 17 | 61 | WE06SR3/8 | 400 | 400 | |
| | 08 | R 1/4 tap. | 5.0 | 5.0 | 24 | 17.0 | 27 | 12 | 32 | 14 | 19 | 73 | WE08SR | 400 | 400 | 250 |
| | 08 | R 3/8 tap. | 5.0 | 7.0 | 25 | 18.0 | 28 | 12 | 33 | 17 | 19 | 63 | WE08SR3/8 | 400 | 400 | |
| | 10 | R 3/8 tap. | 7.0 | 7.0 | 25 | 17.5 | 28 | 12 | 34 | 17 | 22 | 104 | WE10SR | 400 | 400 | 250 |
| | 10 | R 1/4 tap. | 7.0 | 5.0 | 25 | 17.5 | 28 | 12 | 34 | 17 | 22 | 59 | WE10SR1/4 | 400 | 400 | |
| | 10 | R 1/2 tap. | 7.0 | 10.0 | 30 | 22.5 | 32 | 14 | 39 | 19 | 22 | 98 | WE10SR1/2 | 400 | 400 | |
| | 12 | R 3/8 tap. | 8.0 | 8.0 | 29 | 21.5 | 28 | 12 | 38 | 17 | 24 | 126 | WE12SR | 400 | 400 | 250 |
| | 12 | R 1/2 tap. | 8.0 | 11.0 | 30 | 22.5 | 32 | 14 | 39 | 19 | 24 | 97 | WE12SR1/2 | 400 | 400 | |
| | 16 | R 1/2 tap. | 12.0 | 12.0 | 33 | 24.5 | 32 | 14 | 43 | 24 | 30 | 150 | WE16SR | 400 | 400 | 250 |

¹⁾ Pressure shown = item deliverable

²⁾ LL = very light series; ³⁾ L = light series; ⁴⁾ S = heavy series

$$\frac{PN(\text{bar})}{10} = PN(\text{MPa})$$

Delivery without nut and ring. Information on ordering complete fittings see page 17.

*Please add the **suffixes** below according to the material/surface required.

| Order code suffixes | | |
|---------------------------------|-----------------------------|-----------|
| Material | Suffix surface and material | Example |
| Steel, zinc plated, Cr(VI)-free | CFX | WE16SRCFX |
| Stainless Steel | 71X | WE16SR71X |
| Brass | MSX | WE16SRMSX |

TE-M Male stud branch tee

EO 24° cone end / Male metric thread – metal sealing edge (ISO 9974)

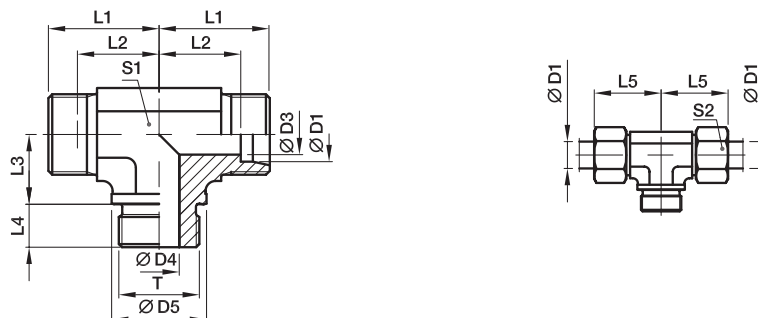

| Series | D1 | T | D3 | D4 | D5 | L1 | L2 | L3 | L4 | L5 | S1 | S2 | Weight g/1 piece | Order code* | PN (bar) ¹⁾ | |
|-----------------|----|----------|----|----|----|----|------|----|----|----|----|----|---------------------|-------------|------------------------|-----|
| | | | | | | | | | | | | | | | CF | 71 |
| L ³⁾ | 22 | M 26×1.5 | 19 | 18 | 31 | 35 | 27.5 | 26 | 16 | 44 | 27 | 36 | 208 | TE22LM | 160 | 160 |
| | 28 | M 33×2.0 | 24 | 23 | 39 | 38 | 30.5 | 30 | 18 | 47 | 36 | 41 | 352 | TE28LM | 160 | 160 |
| | 35 | M 42×2.0 | 30 | 30 | 49 | 45 | 34.5 | 34 | 20 | 56 | 41 | 50 | 554 | TE35LM | 160 | 160 |
| | 42 | M 48×2.0 | 36 | 36 | 55 | 51 | 40.0 | 39 | 22 | 63 | 50 | 60 | 847 | TE42LM | 160 | 160 |
| S ⁴⁾ | 20 | M 27×2.0 | 16 | 16 | 32 | 37 | 26.5 | 26 | 16 | 48 | 27 | 36 | 265 | TE20SM | 400 | 400 |
| | 25 | M 33×2.0 | 20 | 20 | 39 | 42 | 30.0 | 30 | 18 | 54 | 36 | 46 | 482 | TE25SM | 250 | 250 |
| | 30 | M 42×2.0 | 25 | 25 | 49 | 49 | 35.5 | 34 | 20 | 62 | 41 | 50 | 772 | TE30SM | 160 | 160 |
| | 38 | M 48×2.0 | 32 | 32 | 55 | 57 | 41.0 | 39 | 22 | 72 | 50 | 60 | 1121 | TE38SM | 160 | 160 |

¹⁾ Pressure shown = item deliverable

³⁾ L = light series; ⁴⁾ S = heavy series

$\frac{PN \text{ (bar)}}{10} = PN \text{ (MPa)}$

Delivery without nut and ring. Information on ordering complete fittings see page 17.

| Order code suffixes | | |
|---------------------------------|-----------------------------|-----------|
| Material | Suffix surface and material | Example |
| Steel, zinc plated, Cr(VI)-free | CFX | TE20SMCFX |
| Stainless Steel | 71X | TE20SM71X |

*Please add the **suffixes** below according to the material/surface required.

TE-R Male stud branch tee

EO 24° cone end / Male BSPP thread – metal sealing edge (ISO 1179)

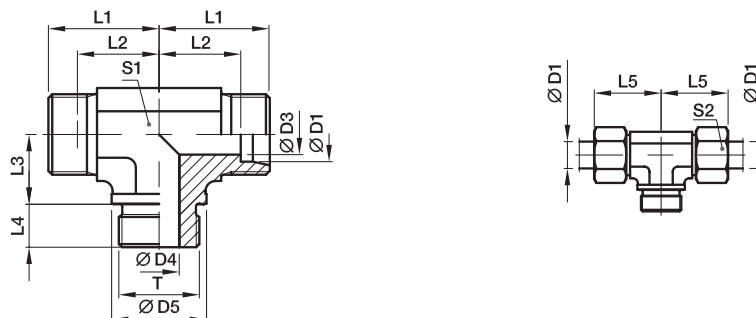

| Series | D1 | T | D3 | D4 | D5 | L1 | L2 | L3 | L4 | L5 | S1 | S2 | Weight g/1 piece | Order code* | PN (bar) ¹⁾ | | |
|-----------------|----|-----------|----|----|----|----|------|----|----|----|----|----|---------------------|-------------|------------------------|-----|-----|
| | | | | | | | | | | | | | | | CF | 71 | MS |
| L ³⁾ | 22 | G 3/4 A | 19 | 18 | 32 | 35 | 27.5 | 26 | 16 | 44 | 27 | 36 | 208 | TE22LR | 160 | 160 | 100 |
| | 28 | G 1 A | 24 | 23 | 39 | 38 | 30.5 | 30 | 18 | 47 | 36 | 41 | 378 | TE28LR | 160 | 160 | 100 |
| | 35 | G 1 1/4 A | 30 | 30 | 49 | 45 | 34.5 | 34 | 20 | 56 | 41 | 50 | 554 | TE35LR | 160 | 160 | 100 |
| | 42 | G 1 1/2 A | 36 | 36 | 55 | 51 | 40.0 | 39 | 22 | 63 | 50 | 60 | 847 | TE42LR | 160 | 160 | 100 |
| S ⁴⁾ | 20 | G 3/4 A | 16 | 16 | 32 | 37 | 26.5 | 26 | 16 | 48 | 27 | 36 | 267 | TE20SR | 400 | 400 | 250 |
| | 25 | G 1 A | 20 | 20 | 39 | 42 | 30.0 | 30 | 18 | 54 | 36 | 46 | 485 | TE25SR | 250 | 250 | |
| | 30 | G 1 1/4 A | 25 | 25 | 49 | 49 | 35.5 | 34 | 20 | 62 | 41 | 50 | 762 | TE30SR | 160 | 160 | |
| | 38 | G 1 1/2 A | 32 | 32 | 55 | 57 | 41.0 | 39 | 22 | 72 | 50 | 60 | 1121 | TE38SR | 160 | 160 | |

¹⁾ Pressure shown = item deliverable

³⁾ L = light series; ⁴⁾ S = heavy series

$\frac{\text{PN (bar)}}{10} = \text{PN (MPa)}$

Delivery without nut and ring. Information on ordering complete fittings see page 17.

| Order code suffixes | | |
|---------------------------------|-----------------------------|-----------|
| Material | Suffix surface and material | Example |
| Steel, zinc plated, Cr(VI)-free | CFX | TE20SRCFX |
| Stainless Steel | 71X | TE20SR71X |
| Brass | MSX | TE20SRMSX |

*Please add the **suffixes** below according to the material/surface required.

TE-R (KEG) Male stud branch tee

EO 24° cone end / Male short BSP taper thread (DIN 3852-2, type C)

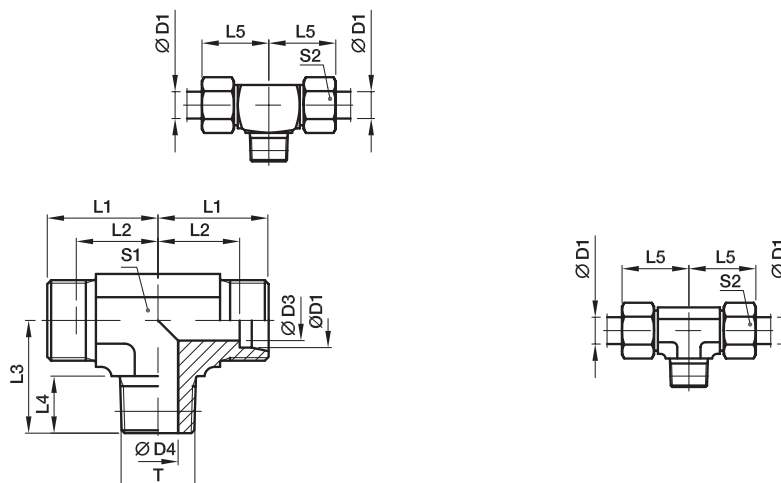

| Series | D1 | T | D3 | D4 | L1 | L2 | L3 | L4 | L5 | S1 | S2 | Weight g/1 piece | Order code* | PN (bar) ¹⁾ | | |
|------------------|----|------------|------|------|----|------|----|----|----|-----|----|---------------------|----------------|------------------------|-----|-----|
| | | | | | | | | | | | | | | CF | 71 | MS |
| LL ²⁾ | 04 | R 1/8 tap. | 3.0 | 4.0 | 15 | 11.0 | 17 | 8 | 21 | 9 | 10 | 21 | TE04LLR | 100 | 100 | 63 |
| | 06 | R 1/8 tap. | 4.5 | 4.5 | 15 | 9.5 | 17 | 8 | 21 | 9 | 12 | 21 | TE06LLR | 100 | 100 | 63 |
| | 08 | R 1/8 tap. | 6.0 | 6.0 | 17 | 11.5 | 20 | 8 | 23 | 12 | 14 | 29 | TE08LLR | 100 | 100 | 63 |
| L ³⁾ | 06 | R 1/8 tap. | 4.0 | 4.0 | 19 | 12.0 | 20 | 8 | 27 | 14 | 14 | 38 | TE06LR | 315 | 315 | 200 |
| | 08 | R 1/4 tap. | 6.0 | 6.0 | 21 | 14.0 | 26 | 12 | 29 | 12 | 17 | 58 | TE08LR | 315 | 315 | 200 |
| | 10 | R 1/4 tap. | 8.0 | 7.0 | 22 | 15.0 | 27 | 12 | 30 | 14 | 19 | 43 | TE10LR | 315 | 315 | 200 |
| | 12 | R 3/8 tap. | 10.0 | 9.0 | 24 | 17.0 | 28 | 12 | 32 | 17 | 22 | 61 | TE12LR | 315 | 315 | 200 |
| | 15 | R 1/2 tap. | 12.0 | 11.0 | 28 | 21.0 | 34 | 14 | 36 | 19 | 27 | 113 | TE15LR | 315 | 315 | 200 |
| | 18 | R 1/2 tap. | 15.0 | 14.0 | 31 | 23.5 | 36 | 14 | 40 | 24 | 32 | 149 | TE18LR | 315 | 315 | 200 |
| S ⁴⁾ | 06 | R 1/4 tap. | 4.0 | 4.0 | 23 | 16.0 | 26 | 12 | 31 | 12 | 17 | 73 | TE06SR | 400 | 400 | 250 |
| | 08 | R 1/4 tap. | 5.0 | 5.0 | 24 | 17.0 | 27 | 12 | 32 | 14 | 19 | 61 | TE08SR | 400 | 400 | 250 |
| | 10 | R 3/8 tap. | 7.0 | 7.0 | 25 | 17.5 | 28 | 12 | 34 | 17 | 22 | 82 | TE10SR | 400 | 400 | 250 |
| | 12 | R 3/8 tap. | 8.0 | 8.0 | 29 | 21.5 | 28 | 12 | 38 | 19* | 24 | 105 | TE12SR | 400 | 400 | 250 |
| | 16 | R 1/2 tap. | 12.0 | 12.0 | 33 | 24.5 | 32 | 14 | 43 | 24 | 30 | 175 | TE16SR | 400 | 400 | 250 |

¹⁾ Pressure shown = item deliverable

²⁾ LL = very light series; ³⁾ L = light series; ⁴⁾ S = heavy series

*S1 = 17 in 1.4571

$\frac{PN \text{ (bar)}}{10} = PN \text{ (MPa)}$

Delivery without nut and ring. Information on ordering complete fittings see page 17.

*Please add the **suffixes** below according to the material/surface required.

| Order code suffixes | | |
|---------------------------------|-----------------------------|-----------|
| Material | Suffix surface and material | Example |
| Steel, zinc plated, Cr(VI)-free | CFX | TE16SRCFX |
| Stainless Steel | 71X | TE16SR71X |
| Brass | MSX | TE16SRMSX |



TE-M(KEG) Male stud branch tee

EO 24° cone end / Male short metric taper thread (DIN 3852-1, type C)

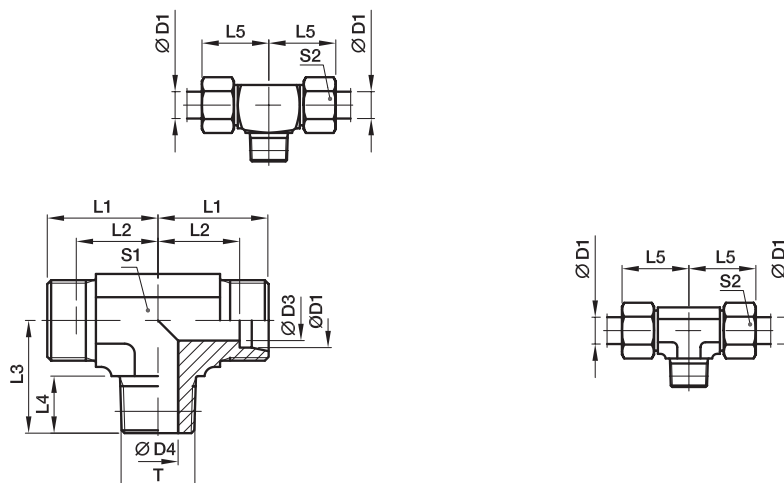

| Series | D1 | T | D3 | D4 | L1 | L2 | L3 | L4 | L5 | S1 | S2 | Weight g/1 piece | Order code* | PN (bar) ¹⁾ | |
|------------------|----|---------------|------|------|----|------|----|----|----|-----|----|---------------------|-------------|------------------------|-----|
| | | | | | | | | | | | | | | CF | 71 |
| LL ²⁾ | 04 | M 08×1.0 tap. | 3.0 | 3.5 | 15 | 11.0 | 17 | 8 | 21 | 9 | 10 | 17 | TE04LLM | 100 | 100 |
| | 06 | M 10×1.0 tap. | 4.5 | 4.5 | 15 | 9.5 | 17 | 8 | 21 | 9 | 12 | 20 | TE06LLM | 100 | 100 |
| | 08 | M 10×1.0 tap. | 6.0 | 6.0 | 17 | 11.5 | 20 | 8 | 23 | 12 | 14 | 29 | TE08LLM | 100 | 100 |
| L ³⁾ | 06 | M 10×1.0 tap. | 4.0 | 4.0 | 19 | 12.0 | 20 | 8 | 27 | 12 | 14 | 38 | TE06LM | 315 | 315 |
| | 08 | M 12×1.5 tap. | 6.0 | 6.0 | 21 | 14.0 | 26 | 12 | 29 | 12 | 17 | 54 | TE08LM | 315 | 315 |
| | 10 | M 14×1.5 tap. | 8.0 | 7.0 | 22 | 15.0 | 27 | 12 | 30 | 14 | 19 | 45 | TE10LM | 315 | 315 |
| | 12 | M 16×1.5 tap. | 10.0 | 9.0 | 24 | 17.0 | 28 | 12 | 32 | 17 | 22 | 60 | TE12LM | 315 | 315 |
| | 15 | M 18×1.5 tap. | 12.0 | 11.0 | 28 | 21.0 | 32 | 12 | 36 | 19 | 27 | 100 | TE15LM | 315 | 315 |
| | 18 | M 22×1.5 tap. | 15.0 | 14.0 | 31 | 23.5 | 36 | 14 | 40 | 24 | 32 | 149 | TE18LM | 315 | 315 |
| S ⁴⁾ | 06 | M 12×1.5 tap. | 4.0 | 4.0 | 23 | 16.0 | 26 | 12 | 31 | 12 | 17 | 69 | TE06SM | 400 | 400 |
| | 08 | M 14×1.5 tap. | 5.0 | 5.0 | 24 | 17.0 | 27 | 12 | 32 | 14 | 19 | 98 | TE08SM | 400 | 400 |
| | 10 | M 16×1.5 tap. | 7.0 | 7.0 | 25 | 17.5 | 28 | 12 | 34 | 17 | 22 | 82 | TE10SM | 400 | 400 |
| | 12 | M 18×1.5 tap. | 8.0 | 8.0 | 29 | 21.5 | 28 | 12 | 38 | 19* | 24 | 106 | TE12SM | 400 | 400 |
| | 16 | M 22×1.5 tap. | 12.0 | 12.0 | 33 | 24.5 | 32 | 14 | 43 | 24 | 30 | 177 | TE16SM | 400 | 400 |

¹⁾ Pressure shown = item deliverable

²⁾ LL = very light series; ³⁾ L = light series; ⁴⁾ S = heavy series

*S1 = 17 in 1.4571

$\frac{PN \text{ (bar)}}{10} = PN \text{ (MPa)}$

Delivery without nut and ring. Information on ordering complete fittings see page 17.

*Please add the **suffixes** below according to the material/surface required.

| Order code suffixes | | |
|---------------------------------|-----------------------------|-----------|
| Material | Suffix surface and material | Example |
| Steel, zinc plated, Cr(VI)-free | CFX | TE16SMCFX |
| Stainless Steel | 71X | TE16SM71X |

LE-M Male stud run tee

EO 24° cone end / Male metric thread – metal sealing edge (ISO 9974)

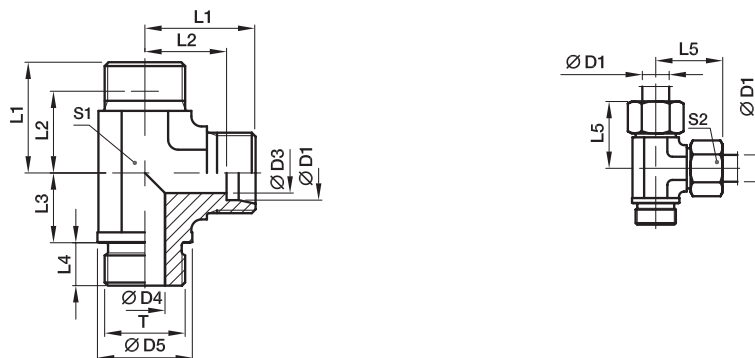

| Series | D1 | T | D3 | D4 | D5 | L1 | L2 | L3 | L4 | L5 | S1 | S2 | Weight g/1 piece | Order code* | PN (bar) ¹⁾ | |
|-----------------|----|----------|----|----|----|----|------|----|----|----|----|----|---------------------|-------------|------------------------|-----|
| | | | | | | | | | | | | | | | CF | 71 |
| L ³⁾ | 22 | M 26×1.5 | 19 | 18 | 31 | 35 | 27.5 | 26 | 16 | 44 | 27 | 36 | 225 | LE22LM | 160 | 160 |
| | 28 | M 33×2.0 | 24 | 23 | 39 | 38 | 30.5 | 30 | 18 | 47 | 36 | 41 | 382 | LE28LM | 160 | 160 |
| | 35 | M 42×2.0 | 30 | 30 | 49 | 45 | 34.5 | 34 | 20 | 56 | 41 | 50 | 583 | LE35LM | 160 | 160 |
| | 42 | M 48×2.0 | 36 | 36 | 55 | 51 | 40.0 | 39 | 22 | 63 | 50 | 60 | 821 | LE42LM | 160 | 160 |
| S ⁴⁾ | 20 | M 27×2.0 | 16 | 16 | 32 | 37 | 26.5 | 26 | 16 | 48 | 27 | 36 | 264 | LE20SM | 400 | 400 |
| | 25 | M 33×2.0 | 20 | 20 | 39 | 42 | 30.0 | 30 | 18 | 54 | 36 | 46 | 497 | LE25SM | 250 | 250 |
| | 30 | M 42×2.0 | 25 | 25 | 49 | 49 | 35.5 | 34 | 20 | 62 | 41 | 50 | 744 | LE30SM | 160 | 160 |
| | 38 | M 48×2.0 | 32 | 32 | 55 | 57 | 41.0 | 39 | 22 | 72 | 50 | 60 | 1111 | LE38SM | 160 | 160 |

¹⁾ Pressure shown = item deliverable

³⁾ L = light series; ⁴⁾ S = heavy series

$\frac{PN \text{ (bar)}}{10} = PN \text{ (MPa)}$

Delivery without nut and ring. Information on ordering complete fittings see page I7.

*Please add the **suffixes** below according to the material/surface required.

| Order code suffixes | | |
|---------------------------------|-----------------------------|-----------|
| Material | Suffix surface and material | Example |
| Steel, zinc plated, Cr(VI)-free | CFX | LE20SMCFX |
| Stainless Steel | 71X | LE20SM71X |



LE-R Male stud run tee

EO 24° cone end / Male BSPP thread – metal sealing edge (ISO 1179)

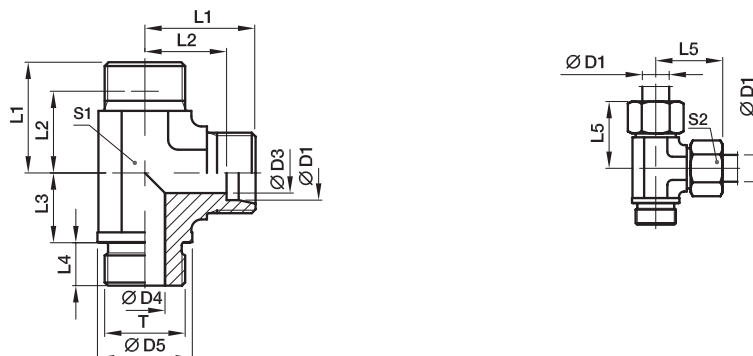

| Series | D1 ⊕ | T | D3 | D4 | D5 | L1 | L2 | L3 | L4 | L5 | S1 | S2 | Weight g/1 piece | Order code* | PN (bar) ¹⁾ | |
|-----------------|---------|-----------|----|----|----|----|------|----|----|----|----|----|---------------------|-------------|------------------------|-----|
| | | | | | | | | | | | | | | | CF | 71 |
| L ³⁾ | 22 | G 3/4 A | 19 | 18 | 32 | 35 | 27.5 | 26 | 16 | 44 | 27 | 36 | 225 | LE22LR | 160 | 160 |
| | 28 | G 1 A | 24 | 23 | 39 | 38 | 30.5 | 30 | 18 | 47 | 36 | 41 | 358 | LE28LR | 160 | 160 |
| | 35 | G 1 1/4 A | 30 | 30 | 49 | 45 | 34.5 | 34 | 20 | 56 | 41 | 50 | 583 | LE35LR | 160 | 160 |
| | 42 | G 1 1/2 A | 36 | 36 | 55 | 51 | 40.0 | 39 | 22 | 63 | 50 | 60 | 821 | LE42LR | 160 | 160 |
| S ⁴⁾ | 20 | G 3/4 A | 16 | 16 | 32 | 37 | 26.5 | 26 | 16 | 48 | 27 | 36 | 259 | LE20SR | 400 | 400 |
| | 25 | G 1 A | 20 | 20 | 39 | 42 | 30.0 | 30 | 18 | 54 | 36 | 46 | 495 | LE25SR | 250 | 250 |
| | 30 | G 1 1/4 A | 25 | 25 | 49 | 49 | 35.5 | 34 | 20 | 62 | 41 | 50 | 744 | LE30SR | 160 | 160 |
| | 38 | G 1 1/2 A | 32 | 32 | 55 | 57 | 41.0 | 39 | 22 | 72 | 50 | 60 | 1111 | LE38SR | 160 | 160 |

¹⁾ Pressure shown = item deliverable

³⁾ L = light series; ⁴⁾ S = heavy series

PN (bar) = PN (MPa)
10

Delivery without nut and ring. Information on ordering complete fittings see page 17.

*Please add the **suffixes** below according to the material/surface required.

| Order code suffixes | | |
|---------------------------------|-----------------------------|-----------|
| Material | Suffix surface and material | Example |
| Steel, zinc plated, Cr(VI)-free | CFX | LE20SRCFX |
| Stainless Steel | 71X | LE20SR71X |



LE-R (KEG) Male stud run tee

EO 24° cone end / Male short BSP taper thread (DIN 3852-2, type C)

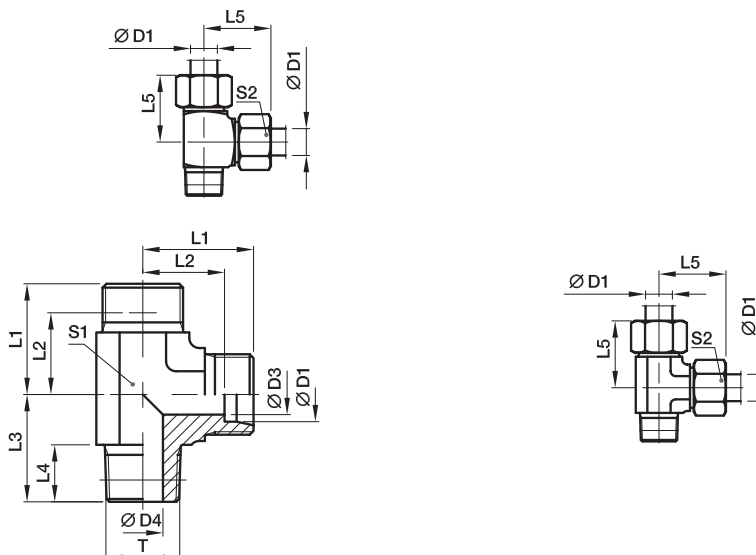

| Series | D1 | T | D3 | D4 | L1 | L2 | L3 | L4 | L5 | S1 | S2 | Weight g/1 piece | Order code* | PN (bar) ¹⁾ | |
|------------------|----|------------|------|------|----|------|----|----|----|-----|----|---------------------|-------------|------------------------|-----|
| | | | | | | | | | | | | | | CF | 71 |
| LL ²⁾ | 04 | R 1/8 tap. | 3.0 | 4.0 | 15 | 11.0 | 17 | 8 | 21 | 9 | 10 | 20 | LE04LLR | 100 | 100 |
| | 06 | R 1/8 tap. | 4.5 | 4.5 | 15 | 9.5 | 17 | 8 | 21 | 9 | 12 | 21 | LE06LLR | 100 | 100 |
| | 08 | R 1/8 tap. | 6.0 | 6.0 | 17 | 11.5 | 20 | 8 | 23 | 12 | 14 | 28 | LE08LLR | 100 | 100 |
| L ³⁾ | 06 | R 1/8 tap. | 4.0 | 4.0 | 19 | 12.0 | 20 | 8 | 27 | 12 | 14 | 40 | LE06LR | 315 | 315 |
| | 08 | R 1/4 tap. | 6.0 | 6.0 | 21 | 14.0 | 26 | 12 | 29 | 12 | 17 | 57 | LE08LR | 315 | 315 |
| | 10 | R 1/4 tap. | 8.0 | 7.0 | 22 | 15.0 | 27 | 12 | 30 | 14 | 19 | 50 | LE10LR | 315 | 315 |
| | 12 | R 3/8 tap. | 10.0 | 9.0 | 24 | 17.0 | 28 | 12 | 32 | 17 | 22 | 60 | LE12LR | 315 | 315 |
| | 15 | R 1/2 tap. | 12.0 | 11.0 | 28 | 21.0 | 34 | 14 | 36 | 19 | 27 | 115 | LE15LR | 315 | 315 |
| | 18 | R 1/2 tap. | 15.0 | 14.0 | 31 | 23.5 | 36 | 14 | 40 | 24 | 32 | 145 | LE18LR | 315 | 315 |
| S ⁴⁾ | 06 | R 1/4 tap. | 4.0 | 4.0 | 23 | 16.0 | 26 | 12 | 31 | 12 | 17 | 71 | LE06SR | 400 | 400 |
| | 08 | R 1/4 tap. | 5.0 | 5.0 | 24 | 17.0 | 27 | 12 | 32 | 14 | 19 | 62 | LE08SR | 400 | 400 |
| | 10 | R 3/8 tap. | 7.0 | 7.0 | 25 | 17.5 | 28 | 12 | 34 | 17 | 22 | 82 | LE10SR | 400 | 400 |
| | 12 | R 3/8 tap. | 8.0 | 8.0 | 29 | 21.5 | 28 | 12 | 38 | 19* | 24 | 102 | LE12SR | 400 | 400 |
| | 16 | R 1/2 tap. | 12.0 | 12.0 | 33 | 24.5 | 32 | 14 | 43 | 24 | 30 | 193 | LE16SR | 400 | 400 |

¹⁾ Pressure shown = item deliverable

²⁾ LL = very light series; ³⁾ L = light series; ⁴⁾ S = heavy series

*S1 = 17 in 1.4571

$\frac{PN \text{ (bar)}}{10} = PN \text{ (MPa)}$

Delivery without nut and ring. Information on ordering complete fittings see page 17.

*Please add the **suffixes** below according to the material/surface required.

| Order code suffixes | | |
|---------------------------------|-----------------------------|-----------|
| Material | Suffix surface and material | Example |
| Steel, zinc plated, Cr(VI)-free | CFX | LE16SRCFX |
| Stainless Steel | 71X | LE16SR71X |



LE-M(KEG) Male stud run tee

EO 24° cone end / Male short metric taper thread (DIN 3852-1, Form C)

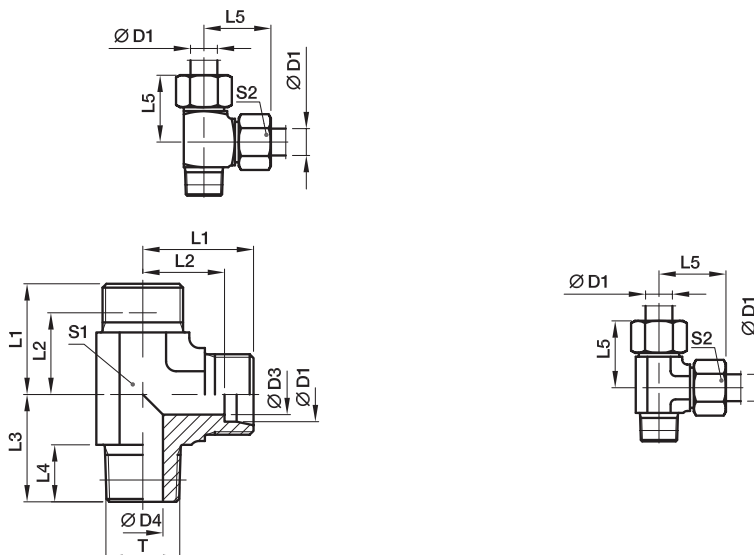

| Series | D1 | T | D3 | D4 | L1 | L2 | L3 | L4 | L5 | S1 | S2 | Weight g/1 piece | Order code* | PN (bar) ¹⁾ | |
|------------------|----|---------------|------|------|----|------|----|----|----|-----|----|---------------------|-------------|------------------------|-----|
| | | | | | | | | | | | | | | CF | 71 |
| LL ²⁾ | 04 | M 08×1.0 tap. | 3.0 | 3.5 | 15 | 11.0 | 17 | 8 | 21 | 9 | 10 | 17 | LE04LLM | 100 | 100 |
| | 06 | M 10×1.0 tap. | 4.5 | 4.5 | 15 | 9.5 | 17 | 8 | 21 | 9 | 12 | 21 | LE06LLM | 100 | 100 |
| | 08 | M 10×1.0 tap. | 6.0 | 6.0 | 17 | 11.5 | 20 | 8 | 23 | 12 | 14 | 29 | LE08LLM | 100 | 100 |
| L ³⁾ | 06 | M 10×1.0 tap. | 4.0 | 4.0 | 19 | 12.0 | 20 | 8 | 27 | 12 | 14 | 38 | LE06LM | 315 | 315 |
| | 08 | M 12×1.5 tap. | 6.0 | 6.0 | 21 | 14.0 | 26 | 12 | 29 | 12 | 17 | 56 | LE08LM | 315 | 315 |
| | 10 | M 14×1.5 tap. | 8.0 | 7.0 | 22 | 15.0 | 27 | 12 | 30 | 14 | 19 | 47 | LE10LM | 315 | 315 |
| | 12 | M 16×1.5 tap. | 10.0 | 9.0 | 24 | 17.0 | 28 | 12 | 32 | 17 | 22 | 58 | LE12LM | 315 | 315 |
| | 15 | M 18×1.5 tap. | 12.0 | 11.0 | 28 | 21.0 | 32 | 12 | 36 | 19 | 27 | 98 | LE15LM | 315 | 315 |
| | 18 | M 22×1.5 tap. | 15.0 | 14.0 | 31 | 23.5 | 36 | 14 | 40 | 24 | 32 | 156 | LE18LM | 315 | 315 |
| S ⁴⁾ | 06 | M 12×1.5 tap. | 4.0 | 4.0 | 23 | 16.0 | 26 | 12 | 31 | 12 | 17 | 70 | LE06SM | 400 | 400 |
| | 08 | M 14×1.5 tap. | 5.0 | 5.0 | 24 | 17.0 | 27 | 12 | 32 | 14 | 19 | 66 | LE08SM | 400 | 400 |
| | 10 | M 16×1.5 tap. | 7.0 | 7.0 | 25 | 17.5 | 28 | 12 | 34 | 17 | 22 | 123 | LE10SM | 400 | 400 |
| | 12 | M 18×1.5 tap. | 8.0 | 8.0 | 29 | 21.5 | 28 | 12 | 38 | 19* | 24 | 169 | LE12SM | 400 | 400 |
| | 16 | M 22×1.5 tap. | 12.0 | 12.0 | 33 | 24.5 | 32 | 14 | 43 | 24 | 30 | 178 | LE16SM | 400 | 400 |

¹⁾ Pressure shown = item deliverable

²⁾ LL = very light series; ³⁾ L = light series; ⁴⁾ S = heavy series

*S1 = 17 in 1.4571

$\frac{PN \text{ (bar)}}{10} = PN \text{ (MPa)}$

Delivery without nut and ring. Information on ordering complete fittings see page I7.

*Please add the **suffixes** below according to the material/surface required.

| Order code suffixes | | |
|---------------------------------|-----------------------------|-----------|
| Material | Suffix surface and material | Example |
| Steel, zinc plated, Cr(VI)-free | CFX | LE16SMCFX |
| Stainless Steel | 71X | LE16SM71X |



DIN fittings

GAI-M Female connector

Female metric thread (ISO 9974-1) / EO 24° cone end

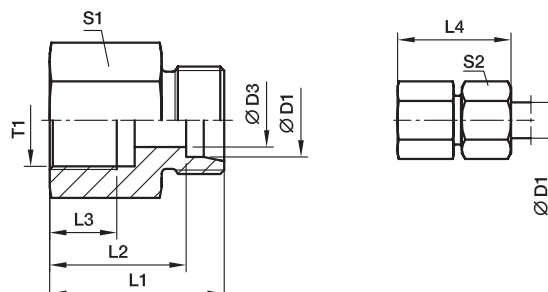

| Series | D1 | T1 | D3 | L1 | L2 | L3 | L4 | S1 | S2 | Weight g/1 piece | Order code* | PN (bar) ¹⁾ | |
|-----------------|----------|----------|------|------|------|------|----|----|-----|---------------------|----------------|------------------------|-----|
| | | | | | | | | | | | | CF | 71 |
| L ³⁾ | 06 | M 10×1.0 | 4 | 26.5 | 19.5 | 8.0 | 34 | 14 | 14 | 18 | GAI06LM | 315 | 315 |
| | 08 | M 12×1.5 | 6 | 31.0 | 24.0 | 12.0 | 39 | 17 | 17 | 32 | GAI08LM | 315 | 315 |
| | 10 | M 14×1.5 | 8 | 32.0 | 25.0 | 12.0 | 40 | 19 | 19 | 39 | GAI10LM | 315 | 315 |
| | 12 | M 16×1.5 | 10 | 33.0 | 26.0 | 12.0 | 41 | 22 | 22 | 52 | GAI12LM | 315 | 315 |
| | 15 | M 18×1.5 | 12 | 35.0 | 28.0 | 12.0 | 43 | 24 | 27 | 68 | GAI15LM | 315 | 315 |
| | 18 | M 22×1.5 | 15 | 37.0 | 29.5 | 14.0 | 46 | 30 | 32 | 111 | GAI18LM | 315 | 315 |
| | 22 | M 26×1.5 | 19 | 42.0 | 34.5 | 16.0 | 51 | 32 | 36 | 123 | GAI22LM | 160 | 160 |
| | 28 | M 33×2.0 | 24 | 45.0 | 37.5 | 18.0 | 54 | 41 | 41 | 211 | GAI28LM | 160 | 160 |
| | 35 | M 42×2.0 | 30 | 51.0 | 40.5 | 20.0 | 62 | 55 | 50 | 459 | GAI35LM | 160 | 160 |
| 42 | M 48×2.0 | 36 | 53.0 | 42.0 | 22.0 | 65 | 60 | 60 | 522 | GAI42LM | 160 | 160 | |
| S ⁴⁾ | 06 | M 12×1.5 | 4 | 33.0 | 26.0 | 12.0 | 41 | 17 | 17 | 35 | GAI06SM | 400 | 400 |
| | 08 | M 14×1.5 | 5 | 33.0 | 26.0 | 12.0 | 41 | 17 | 19 | 42 | GAI08SM | 400 | 400 |
| | 10 | M 16×1.5 | 7 | 34.0 | 26.5 | 12.0 | 43 | 22 | 22 | 58 | GAI10SM | 400 | 400 |
| | 12 | M 18×1.5 | 8 | 35.0 | 27.5 | 12.0 | 44 | 24 | 24 | 70 | GAI12SM | 400 | 400 |
| | 16 | M 22×1.5 | 12 | 39.0 | 30.5 | 14.0 | 49 | 30 | 30 | 114 | GAI16SM | 400 | 400 |
| | 20 | M 27×2.0 | 16 | 45.0 | 34.5 | 16.0 | 56 | 36 | 36 | 189 | GAI20SM | 315 | 315 |
| | 25 | M 33×2.0 | 20 | 49.0 | 37.0 | 18.0 | 61 | 41 | 46 | 235 | GAI25SM | 315 | 315 |
| | 30 | M 42×2.0 | 25 | 55.0 | 41.5 | 20.0 | 68 | 55 | 50 | 490 | GAI30SM | 315 | 315 |
| | 38 | M 48×2.0 | 32 | 59.0 | 43.0 | 22.0 | 74 | 60 | 60 | 597 | GAI38SM | 250 | 250 |

¹⁾ Pressure shown = item deliverable

³⁾ L = light series; ⁴⁾ S = heavy series

 $\frac{PN(\text{bar})}{10} = PN(\text{MPa})$

Delivery without nut and ring. Information on ordering complete fittings see page 17.

 *Please add the **suffixes** below according to the material/surface required.

| Order code suffixes | | |
|---------------------------------|-----------------------------|------------|
| Material | Suffix surface and material | Example |
| Steel, zinc plated, Cr(VI)-free | CFX | GAI16SMCFX |
| Stainless Steel | 71X | GAI16SM71X |



GAI-R Female connector

Female BSPP thread (ISO 1179-1) / EO 24° cone end

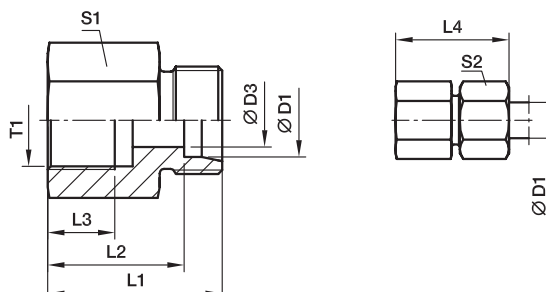

| Series | D1 ⊕ -0.05 | T1 | D3 | L1 | L2 | L3 | L4 | S1 | S2 | Weight g/1 piece | Order code* | PN (bar) ¹⁾ | | |
|-----------------|------------------|---------|------|------|------|------|----|----|-----|---------------------|-------------------|------------------------|-----|-----|
| | | | | | | | | | | | | CF | 71 | MS |
| L ³⁾ | 06 | G 1/8 | 4 | 26.0 | 19.0 | 8.0 | 34 | 14 | 14 | 18 | GAI06LR | 315 | 315 | 200 |
| | 06 | G 1/4 | 4 | 31.0 | 24.0 | 12.0 | 39 | 19 | 14 | 39 | GAI06LR1/4 | 315 | 315 | 200 |
| | 08 | G 1/4 | 6 | 31.0 | 24.0 | 12.0 | 39 | 19 | 17 | 39 | GAI08LR | 315 | 315 | 200 |
| | 08 | G 3/8 | 6 | 32.0 | 25.0 | 12.0 | 40 | 24 | 17 | 61 | GAI08LR3/8 | 315 | 315 | 200 |
| | 08 | G 1/2 | 6 | 36.0 | 29.0 | 14.0 | 44 | 27 | 17 | 80 | GAI08LR1/2 | 315 | 315 | 200 |
| | 10 | G 1/4 | 8 | 32.0 | 25.0 | 12.0 | 40 | 19 | 19 | 40 | GAI10LR | 315 | 315 | 200 |
| | 10 | G 3/8 | 8 | 33.0 | 26.0 | 12.0 | 41 | 24 | 19 | 63 | GAI10LR3/8 | 315 | 315 | 200 |
| | 10 | G 1/2 | 8 | 37.0 | 30.0 | 14.0 | 45 | 27 | 19 | 81 | GAI10LR1/2 | 315 | 315 | 200 |
| | 12 | G 3/8 | 10 | 33.0 | 26.0 | 12.0 | 41 | 24 | 22 | 64 | GAI12LR | 315 | 315 | 200 |
| | 12 | G 1/2 | 10 | 37.0 | 30.0 | 14.0 | 45 | 27 | 22 | 83 | GAI12LR1/2 | 315 | 315 | 200 |
| | 15 | G 1/2 | 12 | 38.0 | 31.0 | 14.0 | 46 | 27 | 27 | 87 | GAI15LR | 315 | 315 | 200 |
| | 18 | G 1/2 | 15 | 38.0 | 30.5 | 14.0 | 47 | 27 | 32 | 89 | GAI18LR | 315 | 315 | 200 |
| | 18 | G 3/8 | 15 | 34.0 | 26.5 | 12.0 | 43 | 27 | 32 | 95 | GAI18LR3/8 | 315 | 315 | 200 |
| | 22 | G 3/4 | 19 | 43.0 | 35.5 | 16.0 | 52 | 36 | 36 | 173 | GAI22LR | 160 | 160 | 100 |
| | 28 | G 1 | 24 | 45.5 | 38.0 | 18.0 | 55 | 41 | 41 | 211 | GAI28LR | 160 | 160 | 100 |
| | 35 | G 1 1/4 | 30 | 51.5 | 41.0 | 20.0 | 63 | 55 | 50 | 469 | GAI35LR | 160 | 160 | 100 |
| 42 | G 1 1/2 | 36 | 53.5 | 42.5 | 22.0 | 65 | 60 | 60 | 540 | GAI42LR | 160 | 160 | 100 | |
| S ⁴⁾ | 06 | G 1/4 | 4 | 33.0 | 26.0 | 12.0 | 41 | 19 | 17 | 43 | GAI06SR | 400 | 400 | |
| | 08 | G 1/4 | 5 | 33.0 | 26.0 | 12.0 | 41 | 19 | 19 | 47 | GAI08SR | 400 | 400 | |
| | 10 | G 3/8 | 7 | 34.0 | 26.5 | 12.0 | 43 | 24 | 22 | 68 | GAI10SR | 400 | 400 | |
| | 12 | G 3/8 | 8 | 34.0 | 26.5 | 12.0 | 43 | 24 | 24 | 71 | GAI12SR | 400 | 400 | |
| | 12 | G 1/2 | 8 | 38.0 | 30.5 | 14.0 | 47 | 30 | 24 | 121 | GAI12SR1/2 | 400 | 400 | |
| | 16 | G 1/2 | 12 | 40.0 | 31.5 | 14.0 | 50 | 30 | 30 | 126 | GAI16SR | 400 | 400 | |
| | 20 | G 3/4 | 16 | 45.0 | 34.5 | 16.0 | 56 | 36 | 36 | 196 | GAI20SR | 315 | 315 | |
| | 25 | G 1 | 20 | 49.5 | 37.5 | 18.0 | 62 | 41 | 46 | 246 | GAI25SR | 315 | 315 | |
| | 30 | G 1 1/4 | 25 | 55.5 | 42.0 | 22.0 | 69 | 55 | 50 | 537 | GAI30SR | 315 | 315 | |
| | 38 | G 1 1/2 | 32 | 59.5 | 43.5 | 22.0 | 74 | 60 | 60 | 649 | GAI38SR | 250 | 250 | |

¹⁾ Pressure shown = item deliverable

³⁾ L = light series; ⁴⁾ S = heavy series

$$\frac{\text{PN (bar)}}{10} = \text{PN (MPa)}$$

Delivery without nut and ring. Information on ordering complete fittings see page I7.

*Please add the **suffixes** below according to the material/surface required.

| Order code suffixes | | |
|---------------------------------|-----------------------------|------------|
| Material | Suffix surface and material | Example |
| Steel, zinc plated, Cr(VI)-free | CFX | GAI16SRCFX |
| Stainless Steel | 71X | GAI16SR71X |
| Brass | MSX | GAI16SRMSX |



DIN fittings

GAI-NPT Female connector

Female NPT thread (SAE 476) / EO 24° cone end

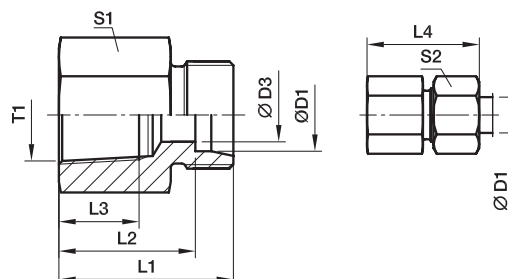

| Series | D1 ⊕ | T1 | D3 | L1 | L2 | L3 | L4 | S1 | S2 | Weight g/1 piece | Order code* | PN (bar) ¹⁾ | |
|-----------------|---------|----------------|----|------|------|------|----|----|----|---------------------|----------------------|------------------------|-----|
| | | | | | | | | | | | | CF | 71 |
| L ³⁾ | 06 | 1/8-27 NPT | 4 | 26.0 | 19.0 | 11.6 | 34 | 14 | 14 | 19 | GAI06L1/8NPT | 315 | 315 |
| | 06 | 1/4-18 NPT | 4 | 30.5 | 23.5 | 16.4 | 38 | 19 | 14 | 38 | GAI06L1/4NPT | 315 | 315 |
| | 08 | 1/4-18 NPT | 6 | 30.5 | 23.5 | 16.4 | 38 | 19 | 17 | 39 | GAI08L1/4NPT | 315 | 315 |
| | 10 | 1/4-18 NPT | 8 | 31.0 | 24.0 | 16.4 | 39 | 19 | 19 | 40 | GAI10L1/4NPT | 315 | 315 |
| | 12 | 3/8-18 NPT | 10 | 34.0 | 27.0 | 17.4 | 42 | 24 | 22 | 69 | GAI12L3/8NPT | 315 | 315 |
| | 12 | 1/2-14 NPT | 10 | 39.0 | 32.0 | 22.6 | 47 | 27 | 22 | 91 | GAI12L1/2NPT | 315 | 315 |
| | 15 | 1/2-14 NPT | 12 | 40.0 | 33.0 | 22.6 | 48 | 27 | 27 | 96 | GAI15L1/2NPT | 315 | 315 |
| | 18 | 1/2-14 NPT | 15 | 40.0 | 32.5 | 22.6 | 49 | 27 | 32 | 99 | GAI18L1/2NPT | 315 | 315 |
| | 22 | 3/4-14 NPT | 19 | 43.0 | 35.5 | 23.1 | 52 | 36 | 36 | 184 | GAI22L3/4NPT | 160 | 160 |
| | 28 | 1-11.5 NPT | 24 | 48.0 | 40.5 | 27.8 | 57 | 41 | 41 | 238 | GAI28L1NPT | 160 | 160 |
| | 35 | 1 1/4-11.5 NPT | 30 | 51.0 | 40.5 | 28.3 | 62 | 55 | 50 | 424 | GAI35L11/4NPT | 160 | 160 |
| | 42 | 1 1/2-11.5 NPT | 36 | 53.0 | 42.0 | 28.3 | 65 | 60 | 60 | 547 | GAI42L11/2NPT | 160 | 160 |
| S ⁴⁾ | 06 | 1/8-27 NPT | 4 | 29.0 | 22.0 | 11.6 | 36 | 14 | 17 | 25 | GAI06S1/8NPT | 400 | 400 |
| | 06 | 1/4-18 NPT | 4 | 33.0 | 26.0 | 16.4 | 41 | 19 | 17 | 41 | GAI06S1/4NPT | 400 | 400 |
| | 08 | 1/4-18 NPT | 5 | 33.0 | 26.0 | 16.4 | 41 | 19 | 19 | 42 | GAI08S1/4NPT | 400 | 400 |
| | 10 | 3/8-18 NPT | 7 | 35.0 | 27.0 | 17.4 | 44 | 24 | 22 | 74 | GAI10S3/8NPT | 400 | 400 |
| | 12 | 1/4-18 NPT | 8 | 32.5 | 25.0 | 16.4 | 41 | 22 | 24 | 81 | GAI12S1/4NPT | 400 | 400 |
| | 12 | 3/8-18 NPT | 8 | 35.0 | 27.5 | 17.4 | 44 | 24 | 24 | 76 | GAI12S3/8NPT | 400 | 400 |
| | 12 | 1/2-14 NPT | 8 | 41.0 | 33.5 | 22.6 | 50 | 27 | 24 | 101 | GAI12S1/2NPT | 400 | 400 |
| | 16 | 1/2-14 NPT | 12 | 43.0 | 34.5 | 22.6 | 50 | 27 | 30 | 111 | GAI16S1/2NPT | 400 | 400 |
| | 20 | 1/2-14 NPT | 16 | 44.0 | 33.5 | 22.6 | 55 | 32 | 36 | 129 | GAI20S1/2NPT | 315 | 315 |
| | 20 | 3/4-14 NPT | 16 | 46.0 | 35.5 | 23.1 | 57 | 36 | 36 | 214 | GAI20S3/4NPT | 315 | 315 |
| | 25 | 1-11.5 NPT | 20 | 53.0 | 41.0 | 27.8 | 65 | 41 | 46 | 288 | GAI25S1NPT | 315 | 315 |
| | 30 | 1 1/4-11.5 NPT | 25 | 57.0 | 43.5 | 28.3 | 70 | 55 | 50 | 559 | GAI30S11/4NPT | 315 | 315 |
| | 38 | 1 1/2-11.5 NPT | 32 | 59.0 | 43.0 | 28.3 | 74 | 60 | 60 | 632 | GAI38S11/2NPT | 250 | 250 |

1) Pressure shown = item deliverable

3) L = light series; 4) S = heavy series

$$\frac{\text{PN (bar)}}{10} = \text{PN (MPa)}$$

Delivery without nut and ring. Information on ordering complete fittings see page 17.

| Order code suffixes | | |
|---------------------------------|-----------------------------|-----------------|
| Material | Suffix surface and material | Example |
| Steel, zinc plated, Cr(VI)-free | CFX | GAI16S1/2NPTCFX |
| Stainless Steel | 71X | GAI16S1/2NPT71X |

*Please add the suffixes below according to the material/surface required.

RI-ED Thread reducer/expander

Male BSPP thread – ED-seal (ISO 1179) / Female BSPP thread (ISO 1179-1)

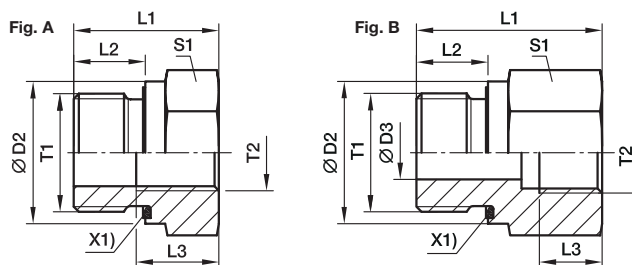

X1) Elastic-sealing ED

| Male Stud T1 | Female Stud T2 | D2 | D3 | L1 | L2 | L3 | S1 | Fig. | Weight g/1 piece | Order code* | PN (bar) ¹⁾ | |
|-----------------|-------------------|----|----|------|----|------|----|------|---------------------|---------------|------------------------|-----|
| | | | | | | | | | | | CF | 71 |
| G 1/8 A | G 1/4 | 14 | 4 | 31.0 | 8 | 12.0 | 19 | B | 41 | RI1/8EDX1/4 | 400 | 400 |
| G 1/8 A | G 3/8 | 14 | 4 | 32.0 | 8 | 12.0 | 24 | B | 63 | RI1/8EDX3/8 | 400 | 400 |
| G 1/4 A | G 1/8 | 19 | 5 | 29.0 | 12 | 8.0 | 19 | B | 41 | RI1/4EDX1/8 | 400 | 400 |
| G 1/4 A | G 3/8 | 19 | 5 | 36.0 | 12 | 12.0 | 24 | B | 69 | RI1/4EDX3/8 | 400 | 400 |
| G 1/4 A | G 1/2 | 19 | 5 | 40.0 | 12 | 14.0 | 30 | B | 120 | RI1/4EDX1/2 | 400 | 400 |
| G 1/4 A | G 3/4 | 19 | 5 | 43.0 | 12 | 16.0 | 36 | B | 171 | RI1/4EDX3/4 | 400 | 400 |
| G 3/8 A | G 1/8 | 22 | | 22.5 | 12 | 8.0 | 22 | A | 38 | RI3/8EDX1/8 | 400 | 400 |
| G 3/8 A | G 1/4 | 22 | 8 | 36.0 | 12 | 12.0 | 22 | B | 68 | RI3/8EDX1/4 | 400 | 400 |
| G 3/8 A | G 1/2 | 22 | 8 | 41.0 | 12 | 14.0 | 30 | B | 124 | RI3/8EDX1/2 | 400 | 400 |
| G 3/8 A | G 3/4 | 22 | 8 | 44.0 | 12 | 16.0 | 36 | B | 182 | RI3/8EDX3/4 | 315 | 315 |
| G 1/2 A | G 1/8 | 27 | | 24.0 | 14 | 8.0 | 27 | A | 65 | RI1/2EDX1/8 | 400 | 400 |
| G 1/2 A | G 1/4 | 27 | | 24.0 | 14 | 12.0 | 27 | A | 56 | RI1/2EDX1/4 | 400 | 400 |
| G 1/2 A | G 3/8 | 27 | 12 | 37.0 | 14 | 12.0 | 27 | B | 95 | RI1/2EDX3/8 | 400 | 400 |
| G 1/2 A | G 3/4 | 27 | 12 | 46.0 | 14 | 16.0 | 36 | B | 183 | RI1/2EDX3/4 | 315 | 315 |
| G 1/2 A | G 1 | 27 | 12 | 49.0 | 14 | 18.0 | 41 | B | 232 | RI1/2EDX1 | 315 | 315 |
| G 1/2 A | G 1 1/4 | 27 | 10 | 53.0 | 14 | 20.0 | 55 | B | 481 | RI1/2EDX11/4 | 315 | 315 |
| G 3/4 A | G 1/4 | 32 | | 26.0 | 16 | 12.0 | 32 | A | 103 | RI3/4EDX1/4 | 315 | 315 |
| G 3/4 A | G 3/8 | 32 | | 26.0 | 16 | 12.0 | 32 | A | 86 | RI3/4EDX3/8 | 315 | 315 |
| G 3/4 A | G 1/2 | 32 | 16 | 43.0 | 16 | 14.0 | 32 | B | 156 | RI3/4EDX1/2 | 315 | 315 |
| G 3/4 A | G 1 | 32 | 16 | 51.0 | 16 | 18.0 | 41 | B | 237 | RI3/4EDX1 | 315 | 315 |
| G 3/4 A | G 1 1/4 | 32 | 16 | 55.0 | 16 | 20.0 | 55 | B | 486 | RI3/4EDX11/4 | 315 | 315 |
| G 3/4 A | G 1 1/2 | 32 | 16 | 57.0 | 16 | 22.0 | 60 | B | 561 | RI3/4EDX11/2 | 250 | 250 |
| G 1 A | G 1/4 | 40 | | 29.0 | 18 | 12.0 | 41 | A | 197 | RI1EDX1/4 | 315 | 315 |
| G 1 A | G 3/8 | 40 | | 29.0 | 18 | 12.0 | 41 | A | 179 | RI1EDX3/8 | 315 | 315 |
| G 1 A | G 1/2 | 40 | | 29.0 | 18 | 14.0 | 41 | A | 153 | RI1EDX1/2 | 315 | 315 |
| G 1 A | G 3/4 | 40 | 20 | 49.0 | 18 | 16.0 | 41 | B | 290 | RI1EDX3/4 | 315 | 315 |
| G 1 A | G 1 1/4 | 40 | 20 | 57.0 | 18 | 20.0 | 55 | B | 503 | RI1EDX11/4 | 315 | 315 |
| G 1 A | G 1 1/2 | 40 | 20 | 59.0 | 18 | 22.0 | 60 | B | 585 | RI1EDX11/2 | 250 | 250 |
| G 1 1/4 A | G 1/2 | 50 | | 32.0 | 20 | 14.0 | 50 | A | 313 | RI11/4EDX1/2 | 315 | 315 |
| G 1 1/4 A | G 3/4 | 50 | | 32.0 | 20 | 16.0 | 50 | A | 393 | RI11/4EDX3/4 | 315 | 315 |
| G 1 1/4 A | G 1 | 50 | 25 | 52.0 | 20 | 18.0 | 50 | B | 469 | RI11/4EDX1 | 315 | 315 |
| G 1 1/4 A | G 1 1/2 | 50 | 25 | 60.0 | 20 | 22.0 | 60 | B | 624 | RI11/4EDX11/2 | 250 | 250 |
| G 1 1/2 A | G 1/2 | 55 | | 36.0 | 22 | 14.0 | 55 | A | 470 | RI11/2EDX1/2 | 250 | 250 |
| G 1 1/2 A | G 3/4 | 55 | | 36.0 | 22 | 16.0 | 55 | A | 415 | RI11/2EDX3/4 | 250 | 250 |
| G 1 1/2 A | G 1 | 55 | | 36.0 | 22 | 18.0 | 55 | A | 338 | RI11/2EDX1 | 250 | 250 |
| G 1 1/2 A | G 1 1/4 | 55 | 32 | 58.0 | 22 | 20.0 | 55 | B | 542 | RI11/2EDX11/4 | 250 | 250 |
| G 2 A | G 1 1/2 | 75 | 40 | 65.0 | 24 | 22.0 | 75 | B | 1309 | RI2EDX11/2 | 160 | |

¹⁾ Pressure shown = item deliverable

PN (bar) = PN (MPa)
10

Information on ordering alternative sealing materials see page I7.

*Please add the suffixes below according to the material/surface required.

| Order code suffixes | | | |
|---------------------------------|-----------------------------|-------------|---|
| Material | Suffix surface and material | Example | Standard sealing material (no additional suffix needed) |
| Steel, zinc plated, Cr(VI)-free | CF | RI1EDX1/2CF | NBR |
| Stainless Steel | 71 | RI1EDX1/271 | VIT |

DIN fittings

RI Thread reducer/expander

Male BSPP thread – metal sealing edge (ISO 1179) / Female BSPP thread (ISO 1179-1)

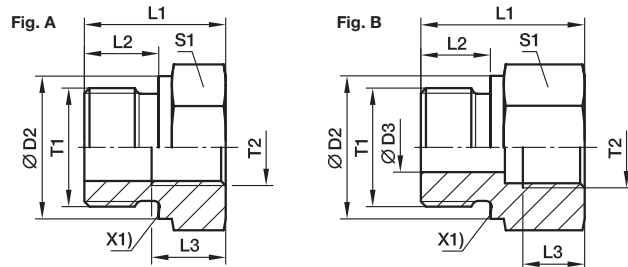

X1) metal sealing edge

| Male Stud T1 | Female Stud T2 | D2 | D3 | L1 | L2 | L3 | S1 | Fig. | Weight g/1 piece | Order code* | PN (bar) ¹⁾ | | |
|-----------------|-------------------|----|----|------|----|------|----|------|---------------------|-------------|------------------------|-----|-----|
| | | | | | | | | | | | CF | 71 | MS |
| G 1/8 A | G 1/4 | 14 | 4 | 31.0 | 8 | 12.0 | 19 | B | 42 | RI1/8X1/4 | 400 | 400 | 250 |
| G 1/8 A | G 3/8 | 14 | 4 | 32.0 | 8 | 12.0 | 24 | B | 63 | RI1/8X3/8 | 400 | 400 | 250 |
| G 1/4 A | G 1/8 | 18 | 5 | 28.0 | 12 | 8.0 | 19 | B | 38 | RI1/4X1/8 | 400 | 400 | 250 |
| G 1/4 A | G 3/8 | 18 | 5 | 36.0 | 12 | 12.0 | 24 | B | 69 | RI1/4X3/8 | 400 | 400 | 250 |
| G 1/4 A | G 1/2 | 18 | 5 | 40.0 | 12 | 14.0 | 30 | B | 116 | RI1/4X1/2 | 400 | 400 | 250 |
| G 1/4 A | G 3/4 | 18 | 5 | 43.0 | 12 | 16.0 | 36 | B | 170 | RI1/4X3/4 | 315 | 315 | 200 |
| G 3/8 A | G 1/8 | 22 | | 22.5 | 12 | 8.0 | 22 | A | 39 | RI3/8X1/8 | 400 | 400 | 250 |
| G 3/8 A | G 1/4 | 22 | 8 | 36.0 | 12 | 12.0 | 22 | B | 68 | RI3/8X1/4 | 400 | 400 | 250 |
| G 3/8 A | G 1/2 | 22 | 8 | 41.0 | 12 | 14.0 | 30 | B | 125 | RI3/8X1/2 | 400 | 400 | 250 |
| G 3/8 A | G 3/4 | 22 | 8 | 44.0 | 12 | 16.0 | 36 | B | 183 | RI3/8X3/4 | 315 | 315 | 200 |
| G 1/2 A | G 1/8 | 26 | | 24.0 | 14 | 8.0 | 27 | A | 66 | RI1/2X1/8 | 400 | 400 | 250 |
| G 1/2 A | G 1/4 | 26 | | 24.0 | 14 | 12.0 | 27 | A | 56 | RI1/2X1/4 | 315 | 315 | 200 |
| G 1/2 A | G 3/8 | 26 | 12 | 37.0 | 14 | 12.0 | 27 | B | 94 | RI1/2X3/8 | 315 | 315 | 200 |
| G 1/2 A | G 3/4 | 26 | 12 | 46.0 | 14 | 16.0 | 36 | B | 182 | RI1/2X3/4 | 315 | 315 | 200 |
| G 1/2 A | G 1 | 26 | 12 | 49.0 | 14 | 18.0 | 41 | B | 221 | RI1/2X1 | 315 | 315 | 200 |
| G 1/2 A | G 1 1/4 | 26 | 10 | 53.0 | 14 | 20.0 | 55 | B | 482 | RI1/2X11/4 | 160 | 160 | |
| G 3/4 A | G 1/4 | 32 | | 26.0 | 16 | 12.0 | 32 | A | 103 | RI3/4X1/4 | 315 | 315 | 200 |
| G 3/4 A | G 3/8 | 32 | | 26.0 | 16 | 12.0 | 32 | A | 87 | RI3/4X3/8 | 315 | 315 | 200 |
| G 3/4 A | G 1/2 | 32 | 16 | 40.0 | 16 | 14.0 | 32 | B | 143 | RI3/4X1/2 | 315 | 315 | 200 |
| G 3/4 A | G 1 | 32 | 16 | 51.0 | 16 | 18.0 | 41 | B | 235 | RI3/4X1 | 315 | 315 | 200 |
| G 3/4 A | G 1 1/4 | 32 | 16 | 55.0 | 16 | 20.0 | 55 | B | 481 | RI3/4X11/4 | 160 | 160 | |
| G 3/4 A | G 1 1/2 | 32 | 16 | 57.0 | 16 | 22.0 | 60 | B | 560 | RI3/4X11/2 | 160 | 160 | |
| G 1 A | G 1/4 | 39 | | 29.0 | 18 | 12.0 | 41 | A | 195 | RI1X1/4 | 315 | 315 | |
| G 1 A | G 3/8 | 39 | | 29.0 | 18 | 12.0 | 41 | A | 179 | RI1X3/8 | 315 | 315 | 200 |
| G 1 A | G 1/2 | 39 | | 29.0 | 18 | 14.0 | 41 | A | 157 | RI1X1/2 | 315 | 315 | 200 |
| G 1 A | G 3/4 | 39 | 20 | 47.0 | 18 | 16.0 | 41 | B | 278 | RI1X3/4 | 315 | 315 | 200 |
| G 1 A | G 1 1/4 | 39 | 20 | 57.0 | 18 | 20.0 | 55 | B | 530 | RI1X11/4 | 160 | 160 | 100 |
| G 1 A | G 1 1/2 | 39 | 20 | 59.0 | 18 | 22.0 | 60 | B | 585 | RI1X11/2 | 160 | 160 | 100 |
| G 1 1/4 A | G 1/2 | 49 | | 32.0 | 20 | 14.0 | 50 | A | 308 | RI11/4X1/2 | 160 | 160 | 100 |
| G 1 1/4 A | G 3/4 | 49 | | 32.0 | 20 | 16.0 | 50 | A | 267 | RI11/4X3/4 | 160 | 160 | 100 |
| G 1 1/4 A | G 1 | 49 | 25 | 52.0 | 20 | 18.0 | 50 | B | 458 | RI11/4X1 | 160 | 160 | 100 |
| G 1 1/4 A | G 1 1/2 | 49 | 25 | 60.0 | 20 | 22.0 | 60 | B | 616 | RI11/4X11/2 | 160 | 160 | 100 |
| G 1 1/2 A | G 1/2 | 55 | | 36.0 | 22 | 14.0 | 55 | A | 477 | RI11/2X1/2 | 160 | 160 | 100 |
| G 1 1/2 A | G 3/4 | 55 | | 36.0 | 22 | 16.0 | 55 | A | 402 | RI11/2X3/4 | 160 | 160 | 100 |
| G 1 1/2 A | G 1 | 55 | | 36.0 | 22 | 18.0 | 55 | A | 337 | RI11/2X1 | 160 | 160 | 100 |
| G 1 1/2 A | G 1 1/4 | 55 | 32 | 58.0 | 22 | 20.0 | 55 | B | 542 | RI11/2X11/4 | 160 | 160 | 100 |
| G 2 A | G 1 1/2 | 68 | 40 | 62.0 | 24 | 22.0 | 70 | B | 990 | RI2X11/2 | 160 | 160 | |

¹⁾ Pressure shown = item deliverable

$$\frac{\text{PN (bar)}}{10} = \text{PN (MPa)}$$

 *Please add the **suffixes** below according to the material/surface required.

| Order code suffixes | | |
|---------------------------------|-----------------------------|------------|
| Material | Suffix surface and material | Example |
| Steel, zinc plated, Cr(VI)-free | CFX | RI1X1/2CFX |
| Stainless Steel | 71X | RI1X1/271X |
| Brass | MSX | RI1X1/2MSX |



MAV Pressure gauge connector

Female BSPP thread / EO 24° cone end
Port acc. to ISO 1179-1

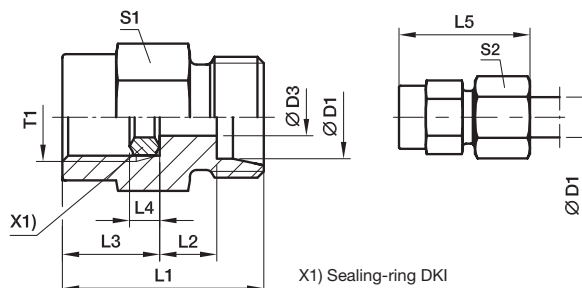

| Series | D1 ⊕ | T1 | D3 | L1 | L2 | L3 | L4 | L5 | S1 | S2 | Weight g/1 piece | Order code* | PN (bar) ¹⁾ | | |
|------------------|---------|-------|-----|----|------|------|-----|----|----|----|---------------------|--------------------|------------------------|-----|-----|
| | | | | | | | | | | | | | CF | 71 | MS |
| LL ²⁾ | 04 | G 1/4 | 2.5 | 27 | 7.5 | 15.5 | 4.5 | 33 | 19 | 10 | 33 | MAV04LLROMD | 100 | | |
| L ³⁾ | 06 | G 1/4 | 2.5 | 29 | 6.5 | 15.5 | 4.5 | 37 | 19 | 14 | 37 | MAV06LROMD | 500 | 315 | 200 |
| | 08 | G 1/4 | 5.5 | 29 | 6.5 | 15.5 | 4.5 | 37 | 19 | 17 | 38 | MAV08LROMD | 500 | 315 | 200 |
| | 10 | G 1/4 | 5.5 | 30 | 6.5 | 15.5 | 4.5 | 38 | 19 | 19 | 41 | MAV10LROMD | 500 | 315 | 200 |
| | 12 | G 1/4 | 5.5 | 30 | 6.5 | 15.5 | 4.5 | 38 | 19 | 22 | 43 | MAV12LROMD | 400 | 315 | 200 |
| S ⁴⁾ | 06 | G 1/2 | 3.5 | 38 | 11.0 | 20.0 | 5.0 | 46 | 27 | 17 | 86 | MAV06SROMD | 630 | 630 | 400 |
| | 08 | G 1/2 | 3.5 | 38 | 11.0 | 20.0 | 5.0 | 46 | 27 | 19 | 86 | MAV08SROMD | 630 | 630 | 400 |
| | 10 | G 1/2 | 7.5 | 38 | 10.5 | 20.0 | 5.0 | 47 | 27 | 22 | 88 | MAV10SROMD | 630 | 630 | 400 |
| | 12 | G 1/2 | 7.5 | 38 | 10.5 | 20.0 | 5.0 | 47 | 27 | 24 | 93 | MAV12SROMD | 630 | 630 | 400 |

¹⁾ Pressure shown = item deliverable

²⁾ LL = very light series; ³⁾ L = light series; ⁴⁾ S = heavy series

PN (bar) = PN (MPa)
10

Delivery without nut and ring. Information on ordering complete fittings see page I7.

| Order code suffixes | | |
|---------------------------------|-----------------------------|--------------|
| Material | Suffix surface and material | Example |
| Steel, zinc plated, Cr(VI)-free | CF | MAV10SROMDCF |
| Stainless Steel | 71 | MAV10SROMD71 |
| Brass | MS | MAV10SROMDMS |

*Please add the **suffixes** below according to the material/surface required.

DIN fittings

MAVE Pressure gauge swivel connector

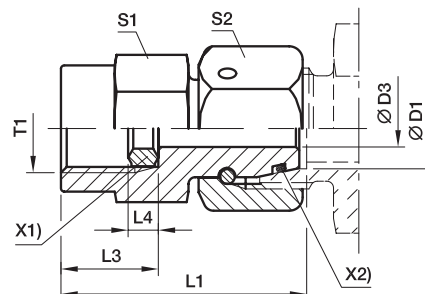
 Female BSPP thread / EO 24° DKO swivel
 Port acc. to ISO 1179-1

 X1) Sealing-ring DKO
 X2) O-ring OR

| Series | D1 ⊕ ± | T1 | D3 | L1 | L3 | L4 | S1 | S2 | Weight g/1 piece | Order code* | PN (bar) ¹⁾ | |
|-----------------|--------------|-------|-----|------|------|-----|----|----|---------------------|--------------------|------------------------|-----|
| | | | | | | | | | | | CF | 71 |
| L ³⁾ | 06 | G 1/4 | 2.5 | 35.5 | 15.5 | 4.5 | 19 | 14 | 46 | MAVE06LR | 500 | 315 |
| | 08 | G 1/4 | 4.0 | 35.5 | 15.5 | 4.5 | 19 | 17 | 52 | MAVE08LR | 500 | 315 |
| | 10 | G 1/4 | 5.5 | 36.0 | 15.5 | 4.5 | 19 | 19 | 59 | MAVE10LR | 500 | 315 |
| | 12 | G 1/4 | 5.5 | 36.0 | 15.5 | 4.5 | 19 | 22 | 70 | MAVE12LR | 400 | 315 |
| S ⁴⁾ | 06 | G 1/2 | 2.5 | 42.5 | 20.0 | 5.0 | 27 | 17 | 95 | MAVE06SR | 630 | 630 |
| | 06 | G 1/4 | 2.5 | 35.5 | 15.5 | 4.5 | 19 | 17 | 52 | MAVE06SR1/4 | 630 | 630 |
| | 08 | G 1/2 | 4.0 | 43.0 | 20.0 | 5.0 | 27 | 19 | 100 | MAVE08SR | 630 | 630 |
| | 08 | G 1/4 | 4.0 | 35.5 | 15.5 | 4.5 | 19 | 19 | 58 | MAVE08SR1/4 | 630 | 630 |
| | 10 | G 1/2 | 6.0 | 43.5 | 20.0 | 5.0 | 27 | 22 | 109 | MAVE10SR | 630 | 630 |
| | 10 | G 1/4 | 7.0 | 39.0 | 15.5 | 4.5 | 19 | 22 | 67 | MAVE10SR1/4 | 630 | 630 |
| | 12 | G 1/2 | 7.0 | 45.0 | 20.0 | 5.0 | 27 | 24 | 125 | MAVE12SR | 630 | 630 |
| | 12 | G 1/4 | 7.0 | 39.0 | 15.5 | 4.5 | 19 | 24 | 83 | MAVE12SR1/4 | 630 | 630 |

¹⁾ Pressure shown = item deliverable

³⁾ L = light series; ⁴⁾ S = heavy series

 $\frac{\text{PN (bar)}}{10} = \text{PN (MPa)}$

Information on ordering alternative sealing materials see page 17.

| Order code suffixes | | | |
|---------------------------------|-----------------------------|------------|---|
| Material | Suffix surface and material | Example | Standard sealing material (no additional suffix needed) |
| Steel, zinc plated, Cr(VI)-free | CF | MAVE10SRCF | NBR |
| Stainless Steel | 71 | MAVE10SR71 | VIT |

 *Please add the **suffixes** below according to the material/surface required.



ROV Blanking plug for tube ends

EO 24° cone end

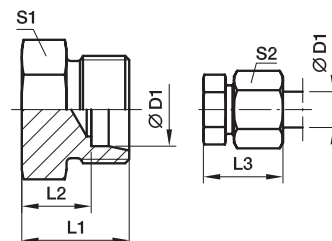

| Series | D1 | L1 | L2 | L3 | S1 | S2 | Weight g/1 piece | Order code* | PN (bar) ¹⁾ | |
|-----------------|--------|----|------|----|----|----|---------------------|---------------|------------------------|-----|
| | | | | | | | | | CF | 71 |
| L ³⁾ | 06 | 14 | 7.0 | 22 | 12 | 14 | 8 | ROV06L | 315 | 315 |
| | 08 | 15 | 8.0 | 23 | 14 | 17 | 13 | ROV08L | 315 | 315 |
| | 10 | 16 | 9.0 | 24 | 17 | 19 | 17 | ROV10L | 315 | 315 |
| | 12 | 17 | 10.0 | 25 | 19 | 22 | 24 | ROV12L | 315 | 315 |
| | 15 | 18 | 11.0 | 26 | 24 | 27 | 41 | ROV15L | 315 | 315 |
| | 18 | 19 | 11.5 | 28 | 27 | 32 | 56 | ROV18L | 315 | 315 |
| | 22 | 21 | 13.5 | 30 | 32 | 36 | 84 | ROV22L | 160 | 160 |
| | 28 | 22 | 14.5 | 31 | 41 | 41 | 138 | ROV28L | 160 | 160 |
| | 35 | 25 | 14.5 | 36 | 46 | 50 | 203 | ROV35L | 160 | 160 |
| | 42 | 27 | 16.0 | 39 | 55 | 60 | 318 | ROV42L | 160 | 160 |
| S ⁴⁾ | 06 | 18 | 11.0 | 26 | 14 | 17 | 17 | ROV06S | 630 | 630 |
| | 08 | 20 | 13.0 | 28 | 17 | 19 | 28 | ROV08S | 630 | 630 |
| | 10 | 20 | 12.5 | 29 | 19 | 22 | 33 | ROV10S | 630 | 630 |
| | 12 | 22 | 14.5 | 31 | 22 | 24 | 50 | ROV12S | 630 | 630 |
| | 16 | 24 | 15.5 | 34 | 27 | 30 | 75 | ROV16S | 400 | 400 |
| | 20 | 28 | 17.5 | 39 | 32 | 36 | 125 | ROV20S | 400 | 400 |
| | 25 | 32 | 20.0 | 44 | 41 | 46 | 229 | ROV25S | 400 | 400 |
| | 30 | 34 | 20.5 | 47 | 46 | 50 | 310 | ROV30S | 400 | 400 |
| | 38 | 39 | 23.0 | 54 | 55 | 60 | 508 | ROV38S | 315 | 315 |

¹⁾ Pressure shown = item deliverable

³⁾ L = light series; ⁴⁾ S = heavy series

PN (bar) = PN (MPa)
10

Delivery without nut and ring. Information on ordering complete fittings see page I7.

*Please add the **suffixes** below according to the material/surface required.

| Order code suffixes | | |
|---------------------------------|-----------------------------|-----------|
| Material | Suffix surface and material | Example |
| Steel, zinc plated, Cr(VI)-free | CFX | ROV16SCFX |
| Stainless Steel | 71X | ROV16S71X |

VSTI M-OR Blanking plug for ports

Male metric thread – O-ring (ISO 6149)

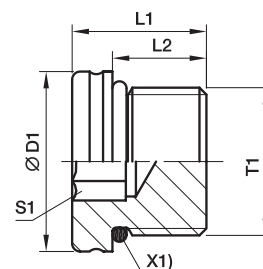

X1) O-ring OR

| T1 | D1 | L1 | L2 | S1 | Weight g/1 piece | Order code* | PN (bar) ¹⁾ CF |
|----------|----|------|------|----|---------------------|---------------------|------------------------------|
| M 08×1.0 | 12 | 13.0 | 9.5 | 4 | 6 | VSTI8X1OR | 630 |
| M 10×1.0 | 13 | 13.5 | 9.5 | 5 | 8 | VSTI10X1OR | 630 |
| M 12×1.5 | 17 | 15.0 | 11.0 | 6 | 14 | VSTI12X1.5OR | 630 |
| M 14×1.5 | 19 | 16.0 | 11.0 | 6 | 20 | VSTI14X1.5OR | 630 |
| M 16×1.5 | 21 | 17.5 | 12.5 | 8 | 26 | VSTI16X1.5OR | 630 |
| M 18×1.5 | 23 | 19.0 | 14.0 | 8 | 37 | VSTI18X1.5OR | 630 |
| M 22×1.5 | 27 | 20.0 | 15.0 | 10 | 58 | VSTI22X1.5OR | 630 |
| M 26×1.5 | 31 | 21.0 | 16.0 | 12 | 77 | VSTI26X1.5OR | 400 |
| M 27×2.0 | 32 | 23.5 | 18.5 | 12 | 95 | VSTI27X2OR | 400 |
| M 33×2.0 | 38 | 25.0 | 18.5 | 14 | 148 | VSTI33X2OR | 400 |
| M 42×2.0 | 48 | 25.5 | 19.0 | 22 | 233 | VSTI42X2OR | 400 |
| M 48×2.0 | 55 | 28.0 | 21.5 | 24 | 336 | VSTI48X2OR | 400 |

¹⁾ Pressure shown = item deliverable

$\frac{PN \text{ (bar)}}{10} = PN \text{ (MPa)}$

Information on ordering alternative sealing materials see page 17.

| Order code suffixes | | | |
|---------------------------------|-----------------------------|----------------|---|
| Material | Suffix surface and material | Example | Standard sealing material (no additional suffix needed) |
| Steel, zinc plated, Cr(VI)-free | CF | VSTI18X1.5ORCF | NBR |

*Please add the **suffixes** below according to the material/surface required.



VSTI M/R-ED Blanking plug for ports

Male metric thread – ED-seal (ISO 9974)

Male BSPP thread – ED-seal (ISO 1179)

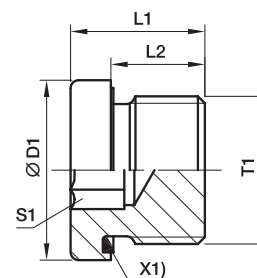

X1) Eolastic-sealing ED

| Male metric parallel thread T1 | Male stud BSP thread T1 | D1 | L1 | L2 | S1 | Weight g/1 piece | Order code* | Order code* | PN (bar) ¹⁾ | |
|-----------------------------------|----------------------------|------|------|----|----|---------------------|--------------|-------------|------------------------|-----|
| | | | | | | | | | CF | 71 |
| M 10×1.0 | G 1/8 A | 14.0 | 12.3 | 8 | 5 | 8 | VSTI10X1ED | VSTI1/8ED | 400 | 400 |
| M 12×1.5 | | 17.0 | 17.3 | 12 | 6 | 14 | VSTI12X1.5ED | | 400 | 400 |
| M 14×1.5 | G 1/4 A | 19.0 | 17.3 | 12 | 6 | 20 | VSTI14X1.5ED | VSTI1/4ED | 400 | 400 |
| M 16×1.5 | G 3/8 A | 22.0 | 17.3 | 12 | 8 | 25 | VSTI16X1.5ED | VSTI3/8ED | 400 | 400 |
| M 18×1.5 | | 24.0 | 17.3 | 12 | 8 | 32 | VSTI18X1.5ED | | 400 | 400 |
| M 20×1.5 | | 26.0 | 19.3 | 14 | 10 | 42 | VSTI20X1.5ED | | 400 | 400 |
| M 22×1.5 | G 1/2 A | 27.0 | 19.3 | 14 | 10 | 51 | VSTI22X1.5ED | VSTI1/2ED | 400 | 400 |
| M 26×1.5 | | 32.0 | 21.3 | 16 | 12 | 78 | VSTI26X1.5ED | | 400 | 400 |
| M 27×2.0 | G 3/4 A | 32.0 | 21.3 | 16 | 12 | 79 | VSTI27X2ED | VSTI3/4ED | 400 | 400 |
| M 33×2.0 | G 1 A | 40.0 | 22.8 | 16 | 17 | 130 | VSTI33X2ED | VSTI1ED | 400 | 400 |
| M 42×2.0 | G 1 1/4 A | 50.0 | 22.8 | 16 | 22 | 198 | VSTI42X2ED | VSTI11/4ED | 315 | 315 |
| M 48×2.0 | G 1 1/2 A | 55.0 | 22.8 | 16 | 24 | 263 | VSTI48X2ED | VSTI11/2ED | 315 | 315 |

¹⁾ Pressure shown = item deliverable

$\frac{\text{PN (bar)}}{10} = \text{PN (MPa)}$

Information on ordering alternative sealing materials see page 17.

| Order code suffixes | | | |
|---------------------------------|-----------------------------|-------------|---|
| Material | Suffix surface and material | Example | Standard sealing material (no additional suffix needed) |
| Steel, zinc plated, Cr(VI)-free | CF | VSTI1/2EDCF | NBR |
| Stainless Steel | 71 | VSTI1/2ED71 | VIT |

*Please add the **suffixes** below according to the material/surface required.

VKA Blanking plug for cones

EO 24° DKO swivel

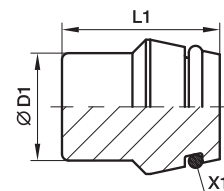

X1) O-ring OR

| Series | D1 | L1 | Weight g/1 piece | Order code* | PN (bar) ¹⁾ | | |
|-----------------|--------|------|---------------------|--------------|------------------------|-----|-----|
| | | | | | CF | 71 | MS |
| L ³⁾ | 06 | 18.5 | 6 | VKA06 | 500 | 315 | 200 |
| | 08 | 18.5 | 9 | VKA08 | 500 | 315 | 200 |
| | 10 | 20.0 | 15 | VKA10 | 500 | 315 | 200 |
| | 12 | 20.5 | 21 | VKA12 | 400 | 315 | 200 |
| | 15 | 20.5 | 32 | VKA15 | 400 | 315 | 200 |
| | 18 | 22.5 | 49 | VKA18 | 400 | 315 | 200 |
| | 22 | 25.0 | 80 | VKA22 | 250 | 160 | 100 |
| | 28 | 25.5 | 131 | VKA28 | 250 | 160 | 100 |
| | 35 | 30.0 | 240 | VKA35 | 250 | 160 | 100 |
| | 42 | 30.0 | 343 | VKA42 | 250 | 160 | 100 |
| S ⁴⁾ | 06 | 18.5 | 6 | VKA06 | 800 | 630 | 400 |
| | 08 | 18.5 | 9 | VKA08 | 800 | 630 | 400 |
| | 10 | 20.0 | 15 | VKA10 | 800 | 630 | 400 |
| | 12 | 20.5 | 21 | VKA12 | 630 | 630 | 400 |
| | 16 | 23.5 | 40 | VKA16 | 630 | 400 | 250 |
| | 20 | 28.5 | 78 | VKA20 | 420 | 400 | 250 |
| | 25 | 29.0 | 120 | VKA25 | 420 | 400 | 250 |
| | 30 | 30.5 | 180 | VKA30 | 420 | 400 | 250 |
| | 38 | 33.0 | 309 | VKA38 | 420 | 315 | 200 |

¹⁾ Pressure shown = item deliverable

³⁾ L = light series; ⁴⁾ S = heavy series

 $\frac{PN \text{ (bar)}}{10} = PN \text{ (MPa)}$

Information on ordering alternative sealing materials see page 17.

| Order code suffixes | | | |
|---------------------------------|-----------------------------|---------|---|
| Material | Suffix surface and material | Example | Standard sealing material (no additional suffix needed) |
| Steel, zinc plated, Cr(VI)-free | CF | VKA16CF | NBR |
| Stainless Steel | 71 | VKA1671 | VIT |
| Brass | MS | VKA16MS | NBR |

^{*}Please add the **suffixes** below according to the material/surface required.



VKAM Blanking plug with nut for cone

EO 24° DKO swivel

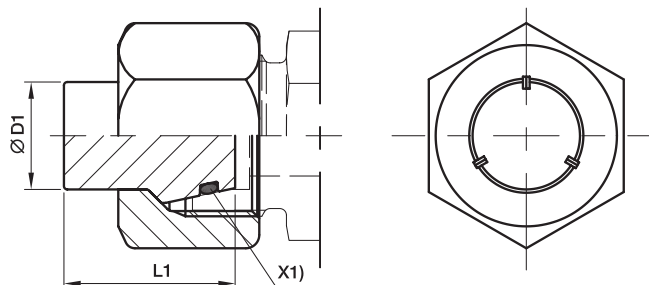

X1) O-ring OR

| Series | D1 ⌀ | L1 | Weight g/1 piece | Order code* | PN (bar) ¹⁾ | |
|-----------------|---------|------|---------------------|-------------|------------------------|-----|
| | | | | | CF | 71 |
| L ³⁾ | 06 | 18.5 | 15 | VKAM06L | 500 | 315 |
| | 08 | 18.5 | 24 | VKAM08L | 500 | 315 |
| | 10 | 20.0 | 33 | VKAM10L | 500 | 315 |
| | 12 | 20.5 | 46 | VKAM12L | 400 | 315 |
| | 15 | 20.5 | 73 | VKAM15L | 400 | 315 |
| | 18 | 22.5 | 111 | VKAM18L | 400 | 315 |
| | 22 | 25.0 | 162 | VKAM22L | 250 | 160 |
| | 28 | 25.5 | 220 | VKAM28L | 250 | 160 |
| | 35 | 30.0 | 376 | VKAM35L | 250 | 160 |
| | 42 | 30.0 | 558 | VKAM42L | 250 | 160 |
| S ⁴⁾ | 06 | 18.5 | 23 | VKAM06S | 800 | 630 |
| | 08 | 18.5 | 29 | VKAM08S | 800 | 630 |
| | 10 | 20.0 | 46 | VKAM10S | 800 | 630 |
| | 12 | 20.5 | 55 | VKAM12S | 630 | 630 |
| | 16 | 23.5 | 106 | VKAM16S | 630 | 400 |
| | 20 | 28.5 | 180 | VKAM20S | 420 | 400 |
| | 25 | 29.0 | 322 | VKAM25S | 420 | 400 |
| | 30 | 30.5 | 398 | VKAM30S | 420 | 400 |
| | 38 | 33.0 | 647 | VKAM38S | 420 | 315 |

¹⁾ Pressure shown = item deliverable

³⁾ L = light series; ⁴⁾ S = heavy series

 $\frac{PN \text{ (bar)}}{10} = PN \text{ (MPa)}$

Information on ordering alternative sealing materials see page I7.

 *Please add the **suffixes** below according to the material/surface required.

| Order code suffixes | | | |
|---------------------------------|-----------------------------|-----------|---|
| Material | Suffix surface and material | Example | Standard sealing material (no additional suffix needed) |
| Steel, zinc plated, Cr(VI)-free | CF | VKAM16SCF | NBR |
| Stainless Steel | 71 | VKAM16S71 | VIT |



BUZ Blanking plug for cones

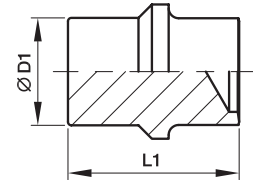

| Series | D1 | L1 | Weight g/1 piece | Order code* | PN (bar) ¹⁾ | | |
|-----------------|--------|------|---------------------|---------------|------------------------|-----|-----|
| | | | | | CF | 71 | MS |
| L ³⁾ | 06 | 19.5 | 5 | BUZ06L | 315 | 315 | 200 |
| | 08 | 19.5 | 8 | BUZ08L | 315 | 315 | 200 |
| | 10 | 21.0 | 13 | BUZ10L | 315 | 315 | 200 |
| | 12 | 21.8 | 20 | BUZ12L | 315 | 315 | 200 |
| | 15 | 22.0 | 30 | BUZ15L | 315 | 315 | 200 |
| | 18 | 24.0 | 45 | BUZ18L | 315 | 315 | 200 |
| | 22 | 26.0 | 74 | BUZ22L | 160 | 160 | 100 |
| | 28 | 26.5 | 117 | BUZ28L | 160 | 160 | 100 |
| | 35 | 32.0 | 217 | BUZ35L | 160 | 160 | 100 |
| | 42 | 32.5 | 308 | BUZ42L | 160 | 160 | 100 |
| S ⁴⁾ | 06 | 19.5 | 5 | BUZ06L | 630 | 630 | 400 |
| | 08 | 19.5 | 8 | BUZ08L | 630 | 630 | 400 |
| | 10 | 21.0 | 13 | BUZ10L | 630 | 630 | 400 |
| | 12 | 21.8 | 20 | BUZ12L | 630 | 630 | 400 |
| | 16 | 25.5 | 39 | BUZ16S | 400 | 400 | 250 |
| | 20 | 30.5 | 73 | BUZ20S | 400 | 400 | 250 |
| | 25 | 32.5 | 119 | BUZ25S | 400 | 400 | 250 |
| | 30 | 35.5 | 181 | BUZ30S | 400 | 400 | 250 |
| | 38 | 40.0 | 325 | BUZ38S | 315 | 315 | 200 |

¹⁾ Pressure shown = item deliverable

³⁾ L = light series; ⁴⁾ S = heavy series

$\frac{PN \text{ (bar)}}{10} = PN \text{ (MPa)}$

*Please add the **suffixes** below according to the material/surface required.

| Order code suffixes | | |
|---------------------------------|-----------------------------|-----------|
| Material | Suffix surface and material | Example |
| Steel, zinc plated, Cr(VI)-free | CFX | BUZ16SCFX |
| Stainless Steel | 71X | BUZ16S71X |
| Brass | MSX | BUZ16SMSX |

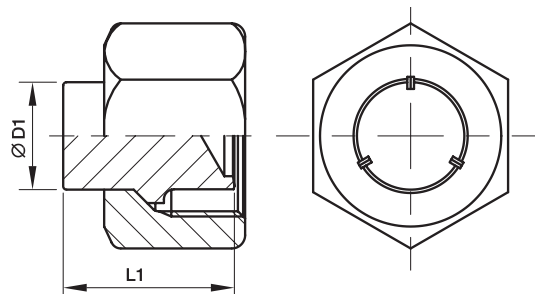
BUZM Blanking plug with nut for cones

| Series | D1 $\begin{matrix} \oplus \\ \ominus \end{matrix}$ | L1 | Weight g/1 piece | Order code* | PN (bar) ¹⁾ | |
|-----------------|---|------|---------------------|----------------|------------------------|-----|
| | | | | | CF | 71 |
| L ³⁾ | 06 | 19.5 | 15 | BUZM06L | 315 | 315 |
| | 08 | 19.5 | 23 | BUZM08L | 315 | 315 |
| | 10 | 21.0 | 31 | BUZM10L | 315 | 315 |
| | 12 | 21.8 | 45 | BUZM12L | 315 | 315 |
| | 15 | 22.0 | 71 | BUZM15L | 315 | 315 |
| | 18 | 24.0 | 107 | BUZM18L | 315 | 315 |
| | 22 | 26.0 | 156 | BUZM22L | 160 | 160 |
| | 28 | 26.5 | 206 | BUZM28L | 160 | 160 |
| | 35 | 32.0 | 354 | BUZM35L | 160 | 160 |
| | 42 | 32.5 | 524 | BUZM42L | 160 | 160 |
| S ⁴⁾ | 06 | 19.5 | 23 | BUZM06S | 630 | 630 |
| | 08 | 19.5 | 28 | BUZM08S | 630 | 630 |
| | 10 | 21.0 | 44 | BUZM10S | 630 | 630 |
| | 12 | 21.8 | 54 | BUZM12S | 630 | 630 |
| | 16 | 25.5 | 105 | BUZM16S | 400 | 400 |
| | 20 | 30.5 | 176 | BUZM20S | 400 | 400 |
| | 25 | 32.5 | 321 | BUZM25S | 400 | 400 |
| | 30 | 35.5 | 399 | BUZM30S | 400 | 400 |
| | 38 | 40.0 | 664 | BUZM38S | 315 | 315 |

¹⁾ Pressure shown = item deliverable

³⁾ L = light series; ⁴⁾ S = heavy series

$\frac{\text{PN (bar)}}{10} = \text{PN (MPa)}$

*Please add the **suffixes** below according to the material/surface required.

| Order code suffixes | | |
|---------------------------------|-----------------------------|-----------|
| Material | Suffix surface and material | Example |
| Steel, zinc plated, Cr(VI)-free | CF | BUZM16SCF |
| Stainless Steel | 71 | BUZM16S71 |

DIN fittings

GM Locknut for bulk heads

For bulkhead SV and WSV

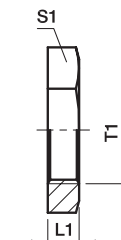

| Series | Tube O.D. | T1 | L1 | S1 | Weight g/1 piece | Order code | | |
|-----------------|-----------|----------|----|----|------------------|------------|--------------------|----------|
| | | | | | | Steel CF | Stainless Steel 71 | Brass MS |
| L ³⁾ | 06 | M 12×1.5 | 6 | 17 | 7 | GM06LCFX | GM06L71X | GM06LMSX |
| | 08 | M 14×1.5 | 6 | 19 | 8 | GM08LCFX | GM08L71X | GM08LMSX |
| | 10 | M 16×1.5 | 6 | 22 | 11 | GM10LCFX | GM10L71X | GM10LMSX |
| | 12 | M 18×1.5 | 6 | 24 | 12 | GM12LCFX | GM12L71X | GM12LMSX |
| | 15 | M 22×1.5 | 7 | 30 | 23 | GM15LCFX | GM15L71X | GM15LMSX |
| | 18 | M 26×1.5 | 8 | 36 | 37 | GM18LCFX | GM18L71X | GM18LMSX |
| | 22 | M 30×2.0 | 8 | 41 | 46 | GM22LCFX | GM22L71X | GM22LMSX |
| | 28 | M 36×2.0 | 9 | 46 | 58 | GM28LCFX | GM28L71X | GM28LMSX |
| | 35 | M 45×2.0 | 9 | 55 | 71 | GM35LCFX | GM35L71X | GM35LMSX |
| | 42 | M 52×2.0 | 10 | 65 | 123 | GM42LCFX | GM42L71X | GM42LMSX |
| S ⁴⁾ | 06 | M 14×1.5 | 6 | 19 | 8 | GM08LCFX | GM08L71X | GM06LMSX |
| | 08 | M 16×1.5 | 6 | 22 | 11 | GM10LCFX | GM10L71X | GM10LMSX |
| | 10 | M 18×1.5 | 6 | 24 | 12 | GM12LCFX | GM12L71X | GM12LMSX |
| | 12 | M 20×1.5 | 6 | 27 | 15 | GM12SCFX | GM12S71X | GM12SMSX |
| | 16 | M 24×1.5 | 7 | 32 | 24 | GM16SCFX | GM16S71X | GM16SMSX |
| | 20 | M 30×2.0 | 8 | 41 | 46 | GM22LCFX | GM22L71X | GM22LMSX |
| | 25 | M 36×2.0 | 9 | 46 | 58 | GM28LCFX | GM28L71X | GM28LMSX |
| | 30 | M 42×2.0 | 9 | 50 | 58 | GM30SCFX | GM30S71X | GM30SMSX |
| | 38 | M 52×2.0 | 10 | 65 | 123 | GM42LCFX | GM42L71X | GM42LMSX |

³⁾ L = light series; ⁴⁾ S = heavy series



VH Support sleeve

for thin-walled metal tubing

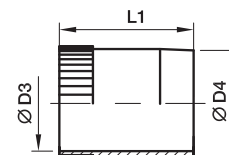

| Tube I.D. | D3 | D4 | L1 | Weight g/1 piece | Steel CF | Order code Stainless Steel 71 | Brass MS |
|-----------|------|------|------|------------------|------------|-------------------------------|------------|
| 4.00 | 2.6 | 3.8 | 14.0 | 0.7 | VH04CFX | VH0471X | VH04MSX |
| 4.50 | 3.1 | 4.3 | 14.0 | 0.8 | VH04.5CFX | VH04.571X | VH04.5MSX |
| 5.00 | 3.6 | 4.8 | 14.0 | 0.8 | VH05CFX | VH0571X | VH05MSX |
| 6.00 | 4.6 | 5.8 | 14.0 | 1.0 | VH06CFX | VH0671X | VH06MSX |
| 6.50 | 5.1 | 6.3 | 14.0 | 1.0 | VH06.5CFX | VH06.571X | VH06.5MSX |
| 7.00 | 5.6 | 6.8 | 15.5 | 1.3 | VH07CFX | VH0771X | VH07MSX |
| 8.00 | 6.6 | 7.8 | 15.5 | 1.6 | VH08CFX | VH0871X | VH08MSX |
| 9.00 | 7.6 | 8.8 | 15.5 | 1.8 | VH09CFX | VH0971X | VH09MSX |
| 10.00 | 8.6 | 9.8 | 15.5 | 2.1 | VH10CFX | VH1071X | VH10MSX |
| 10.05 | 8.6 | 9.8 | 15.5 | 2.1 | VH10.05CFX | VH10.0571X | VH10.05MSX |
| 10.50 | 9.1 | 10.3 | 15.5 | 2.3 | VH10.5CFX | VH10.571X | VH10.5MSX |
| 11.00 | 9.6 | 10.8 | 15.5 | 2.6 | VH11CFX | VH1171X | VH11MSX |
| 12.00 | 10.2 | 11.8 | 17.0 | 3.7 | VH12CFX | VH1271X | VH12MSX |
| 12.95 | 11.2 | 12.8 | 17.0 | 3.9 | VH12.95CFX | VH12.9571X | VH12.95MSX |
| 13.00 | 11.2 | 12.8 | 17.0 | 3.9 | VH13CFX | VH1371X | VH13MSX |
| 14.00 | 12.2 | 13.8 | 17.0 | 4.3 | VH14CFX | VH1471X | VH14MSX |
| 15.00 | 13.2 | 14.8 | 20.0 | 5.7 | VH15CFX | VH1571X | VH15MSX |
| 16.00 | 14.2 | 15.8 | 20.0 | 5.8 | VH16.00CFX | VH16.0071X | VH16.00MSX |
| 16.20 | 14.2 | 15.8 | 20.0 | 5.8 | VH16CFX | VH1671X | VH16MSX |
| 17.00 | 15.2 | 16.8 | 20.0 | 6.3 | VH17CFX | VH1771X | VH17MSX |
| 18.00 | 16.2 | 17.8 | 20.0 | 6.3 | VH18CFX | VH1871X | VH18MSX |
| 19.00 | 17.2 | 18.8 | 16.0 | 5.8 | VH19CFX | VH1971X | VH19MSX |
| 19.90 | 18.2 | 19.8 | 21.5 | 7.9 | VH19.90CFX | VH19.9071X | VH19.90MSX |
| 20.00 | 18.2 | 19.8 | 21.5 | 7.9 | VH20CFX | VH2071X | VH20MSX |
| 21.00 | 19.2 | 20.8 | 21.5 | 8.0 | VH21CFX | VH2171X | VH21MSX |
| 22.00 | 20.2 | 21.8 | 23.5 | 9.7 | VH22CFX | VH2271X | VH22MSX |
| 23.00 | 21.2 | 22.8 | 23.5 | 10.6 | VH23CFX | VH2371X | VH23MSX |
| 24.00 | 22.2 | 23.8 | 23.5 | 11.1 | VH24CFX | VH2471X | VH24MSX |
| 24.90 | 23.3 | 24.8 | 23.5 | 10.8 | VH24.90CFX | VH24.9071X | VH2490MSX |
| 25.00 | 23.2 | 24.8 | 23.5 | 10.8 | VH25CFX | VH2571X | VH25MSX |
| 26.00 | 24.2 | 25.8 | 23.5 | 12.7 | VH26CFX | VH2671X | VH26MSX |
| 27.00 | 25.2 | 26.8 | 23.5 | 12.2 | VH27CFX | VH2771X | VH27MSX |
| 30.00 | 27.8 | 29.8 | 26.5 | 18.7 | VH30CFX | VH3071X | VH30MSX |
| 31.00 | 28.8 | 30.8 | 26.5 | 20.7 | VH31CFX | VH3171X | VH31MSX |
| 32.00 | 29.8 | 31.8 | 26.5 | 19.2 | VH32CFX | VH3271X | VH32MSX |
| 32.10 | 29.8 | 31.8 | 26.5 | 19.2 | VH32.10CFX | VH32.1071X | VH32.10MSX |
| 33.00 | 30.8 | 32.8 | 26.5 | 19.9 | VH33CFX | VH3371X | VH33MSX |
| 34.00 | 31.8 | 33.8 | 26.5 | 26.5 | VH34CFX | VH3471X | VH34MSX |
| 37.80 | 35.8 | 37.7 | 31.0 | 19.5 | VH37.8CFX | VH37.871X | VH37.8MSX |
| 38.00 | 35.8 | 37.8 | 21.0 | 19.7 | VH38CFX | VH3871X | VH38MSX |
| 39.00 | 36.8 | 38.8 | 21.0 | 19.5 | VH39CFX | VH3971X | VH39MSX |

DIN fittings



Index

E Tube/hose insert

for plastic tubing

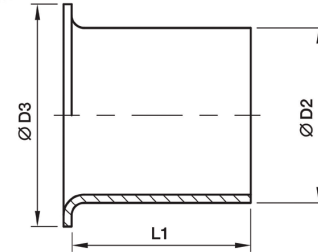

| Tube O.D. | Tube I.D. | D2 | D3 | L1 | Weight g/1 piece | Order code Brass |
|-----------|-----------|------|------|----|------------------|------------------|
| 04 | 2.0 | 2.0 | 3.5 | 8 | 1 | E04/02X |
| 04 | 2.5 | 2.5 | 4.0 | 8 | 1 | E04/2.5X |
| 05 | 3.0 | 3.0 | 5.0 | 14 | 1 | E0506/03X |
| 06 | 3.0 | 3.0 | 5.0 | 14 | 1 | E0506/03X |
| 05 | 4.0 | 4.0 | 5.0 | 14 | 1 | E0506/04X |
| 06 | 4.0 | 4.0 | 5.0 | 14 | 1 | E0506/04X |
| 08 | 4.0 | 4.0 | 6.6 | 14 | 1 | E08/04X |
| 06 | 5.0 | 5.0 | 6.0 | 14 | 1 | E06/05X |
| 08 | 5.0 | 5.0 | 6.0 | 14 | 1 | E08/05X |
| 10 | 6.0 | 6.0 | 8.0 | 15 | 1 | E0810/06X |
| 08 | 6.0 | 6.0 | 8.0 | 15 | 1 | E0810/06X |
| 10 | 8.0 | 8.0 | 10.0 | 15 | 1 | E10/08X |
| 12 | 8.0 | 8.0 | 12.0 | 15 | 2 | E12/08X |
| 12 | 9.0 | 9.0 | 12.0 | 15 | 2 | E12/09X |
| 12 | 10.0 | 10.0 | 12.0 | 15 | 2 | E1215/10X |
| 15 | 12.0 | 12.0 | 14.8 | 15 | 3 | E15/12X |
| 15 | 12.5 | 12.5 | 14.8 | 15 | 3 | E1516/12.5X |
| 16 | 12.5 | 12.5 | 14.8 | 15 | 3 | E1516/12.5X |
| 18 | 14.0 | 14.0 | 17.8 | 15 | 4 | E18/14X |
| 18 | 16.0 | 16.0 | 17.8 | 20 | 4 | E1820/16X |
| 20 | 16.0 | 16.0 | 17.8 | 20 | 4 | E1820/16X |
| 22 | 18.0 | 18.0 | 21.8 | 16 | 5 | E22/18X |

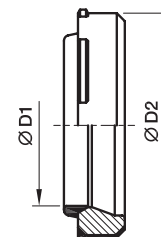
DOZ EO-2 Soft sealing ring

Assembly direction:
Sealing lip shows to the tube end

| Series | D1 | D2 | Weight g/1 piece | Order code | | | |
|------------------|--------|------|---------------------|----------------|------------------|------------------------|------------------------|
| | | | | Steel NBR | Steel FKM | Stainless Steel FKM | Stainless Steel NBR |
| LL ²⁾ | 04 | 6.8 | 1 | DOZ04LL | — | — | — |
| | 06 | 8.8 | 1 | DOZ06LL | — | — | — |
| L ³⁾ | 06 | 10.3 | 1 | DOZ06L | DOZ06LVIT | DOZ06L71 | DOZ06LNBR71 |
| | 08 | 12.3 | 1 | DOZ08L | DOZ08LVIT | DOZ08L71 | DOZ08LNBR71 |
| | 10 | 14.3 | 2 | DOZ10L | DOZ10LVIT | DOZ10L71 | DOZ10LNBR71 |
| | 12 | 16.3 | 2 | DOZ12L | DOZ12LVIT | DOZ12L71 | DOZ12LNBR71 |
| | 15 | 20.3 | 3 | DOZ15L | DOZ15LVIT | DOZ15L71 | DOZ15LNBR71 |
| | 18 | 24.3 | 5 | DOZ18L | DOZ18LVIT | DOZ18L71 | DOZ18LNBR71 |
| | 22 | 27.7 | 6 | DOZ22L | DOZ22LVIT | DOZ22L71 | DOZ22LNBR71 |
| | 28 | 33.7 | 7 | DOZ28L | DOZ28LVIT | DOZ28L71 | DOZ28LNBR71 |
| | 35 | 42.7 | 14 | DOZ35L | DOZ35LVIT | DOZ35L71 | DOZ35LNBR71 |
| | 42 | 49.7 | 17 | DOZ42L | DOZ42LVIT | DOZ42L71 | DOZ42LNBR71 |
| S ⁴⁾ | 06 | 12.3 | 2 | DOZ06S | DOZ06SVIT | DOZ06S71 | DOZ06SNBR71 |
| | 08 | 14.3 | 2 | DOZ08S | DOZ08SVIT | DOZ08S71 | DOZ08SNBR71 |
| | 10 | 16.3 | 3 | DOZ10S | DOZ10SVIT | DOZ10S71 | DOZ10SNBR71 |
| | 12 | 18.3 | 4 | DOZ12S | DOZ12SVIT | DOZ12S71 | DOZ12SNBR71 |
| | 16 | 22.3 | 5 | DOZ16S | DOZ16SVIT | DOZ16S71 | DOZ16SNBR71 |
| | 20 | 27.7 | 9 | DOZ20S | DOZ20SVIT | DOZ20S71 | DOZ20SNBR71 |
| | 25 | 33.7 | 13 | DOZ25S | DOZ25SVIT | DOZ25S71 | DOZ25SNBR71 |
| | 30 | 39.7 | 18 | DOZ30S | DOZ30SVIT | DOZ30S71 | DOZ30SNBR71 |
| | 38 | 49.7 | 27 | DOZ38S | DOZ38SVIT | DOZ38S71 | DOZ38SNBR71 |

²⁾ LL = very light series; ³⁾ L = light series; ⁴⁾ S = heavy series

DIN fittings



Index

ED Eolastic soft seal (for BSPP and metric parallel threads)

For Type: GE...ED, EGE...ED, EVGE...ED, EW...ED, EV...ED, ET...ED, EL...ED, VSTI...ED, RI...ED

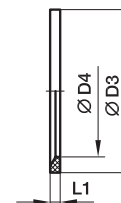

| Male stud metric thread T1 | Male stud BSP thread T1 | D3 | D4 | L1 | Weight g/1 piece | Order code NBR | Order code FKM |
|-------------------------------|----------------------------|---------|------|------|---------------------|-------------------|-------------------|
| M 08×1.0 | G 1/8 A | 9.9 | 6.5 | 1.0 | 0.1 | ED8X1X | ED8X1VITX |
| M 10×1.0 | | 11.9 | 8.4 | 1.0 | 0.1 | ED10X1X | ED10X1VITX |
| M 12×1.5 | G 1/4 A | 14.4 | 9.8 | 1.5 | 0.2 | ED12X1.5X | ED12X1.5VITX |
| M 14×1.5 | | 16.5 | 11.6 | 1.5 | 0.2 | ED14X1.5X | ED14X1.5VITX |
| M 16×1.5 | | 18.9 | 13.8 | 1.5 | 0.1 | ED16X1.5X | ED16X1.5VITX |
| M 18×1.5 | | G 3/8 A | 18.9 | 14.7 | 1.5 | 0.2 | ED3/8X |
| M 20×1.5 | G 1/2 A | 20.9 | 15.7 | 1.5 | 0.1 | ED18X1.5X | ED18X1.5VITX |
| M 22×1.5 | | 22.9 | 17.8 | 1.5 | 0.2 | ED20X1.5X | ED20X1.5VITX |
| M 26×1.5 | | 23.9 | 18.5 | 1.5 | 0.3 | ED1/2X | ED1/2VITX |
| M 27×2.0 | G 3/4 A | 24.3 | 19.6 | 1.5 | 0.2 | ED22X1.5X | ED22X1.5VITX |
| M 33×2.0 | G 3/4 A | 29.2 | 23.9 | 1.5 | 0.4 | ED26X1.5X | ED26X1.5VITX |
| M 42×2.0 | G 1 A | 29.2 | 23.9 | 1.5 | 0.4 | ED26X1.5X | ED26X1.5VITX |
| M 48×2.0 | G 1 1/4 A | 35.7 | 29.7 | 2.0 | 0.7 | ED33X2X | ED33X2VITX |
| | G 1 1/2 A | 45.8 | 38.8 | 2.0 | 0.9 | ED42X2X | ED42X2VITX |
| | | 50.7 | 44.7 | 2.0 | 1.0 | ED48X2X | ED48X2VITX |



OR O-Ring for fittings with EO 24° DKO swivel

For Type:

DA, EGE, EGEO, MAVE, EW, EV, ET, EL, RED, GZ, GZR, VKA, VKAM

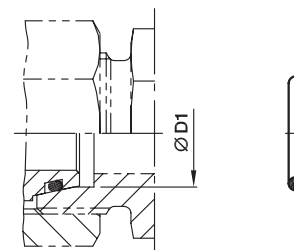

| Series | D1 | O-ring NBR Shore-hardness approx. 90 | O-ring FKM Shore-hardness approx. 90 |
|-----------------|-----------|---|---|
| L ³⁾ | 6 | OR4.5X1.5X | OR4.5X1.5VITX |
| | 8 | OR6.5X1.5X | OR6.5X1.5VITX |
| | 10 | OR8.5X1.5X | OR8X1.5VITX |
| | 12 | OR10.5X1.5X | OR10X1.5VITX |
| | 15 | OR12.5X2X | OR12X2VITX |
| | 18 | OR16X2X | OR15X2VITX |
| | 22 | OR20X2X | OR20X2VITX |
| | 28 | OR26X2X | OR26X2VITX |
| | 35 | OR32X2.5X | OR32X2.5VITX |
| | 42 | OR39X2.5X | OR38X2.5VITX |
| S ⁴⁾ | 6 | OR4.5X1.5X | OR4.5X1.5VITX |
| | 8 | OR6.5X1.5X | OR6.5X1.5VITX |
| | 10 | OR8.5X1.5X | OR8X1.5VITX |
| | 12 | OR10.5X1.5X | OR10X1.5VITX |
| | 16 | OR14X2X | OR13X2VITX |
| | 20 | OR17X2.5X | OR16.3X2.4VITX |
| | 25 | OR22X2.5X | OR20.3X2.4VITX |
| | 30 | OR27X2.5X | OR25.3X2.4VITX |
| 38 | OR35X2.5X | OR33.3X2.4VITX | |

³⁾ L = light series; ⁴⁾ S = heavy series

DIN fittings
OR O-rings for male stud ends

Male metric thread – O-ring (ISO 6149)
 Male UN/UNF thread – O-ring (ISO 11926)

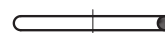
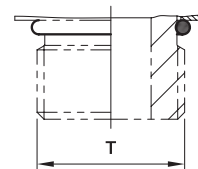

Types with metric thread:
 VSTI-OR, GEO, EGE0

| Thread T | O-ring NBR | O-ring FKM |
|-------------|-------------------|-----------------------|
| M 08×1.0 | OR6.1X1.6 | OR6.1X1.6VITX |
| M 10×1.0 | OR8.1X1.6 | OR8.1X1.6VITX |
| M 12×1.5 | OR9.3X2.2 | OR9.3X2.2VITX |
| M 14×1.5 | OR11.3X2.2 | OR11.3X2.2VITX |
| M 16×1.5 | OR13.3X2.2 | OR13.3X2.2VITX |
| M 18×1.5 | OR15.3X2.2 | OR15.3X2.2VITX |
| M 22×1.5 | OR19.3X2.2 | OR19.3X2.2VITX |
| M 27×2.0 | OR23.6X2.9 | OR23.6X2.9VITX |
| M 33×2.0 | OR29.6X2.9 | OR29.6X2.9VITX |
| M 42×2.0 | OR38.6X2.9 | OR38.6X2.9VITX |
| M 48×2.0 | OR44.6X2.9 | OR44.6X2.9VITX |

Types with UN/UNF thread:
 GE-UNF

| Thread T | O-ring NBR | O-ring FKM |
|--------------|---------------------|-------------------------|
| 7/16-20 UNF | OR8.92X1.83 | OR8.92X1.83VITX |
| 9/16-18 UNF | OR11.89X1.98 | OR11.89X1.98VITX |
| 3/4-16 UNF | OR16.36X2.21 | OR16.36X2.21VITX |
| 7/8-14 UNF | OR19.18X2.46 | OR19X2.5VITX |
| 1 1/16-12 UN | OR23.47X2.95 | OR23.47X2.95VITX |
| 1 5/16-12 UN | OR29.74X2.95 | OR29.74X2.95VITX |
| 1 5/8-12 UN | OR37.46X3 | OR37.46X3VITX |
| 1 7/8-12 UN | OR43.69X3 | OR43.69X3VITX |

OR O-rings and retaining rings for male stud ends

Adjustable BSPP thread – O-ring + retaining ring (ISO 1179)

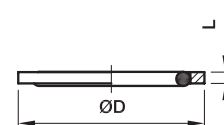
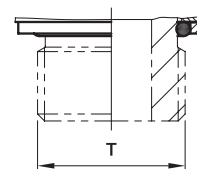

Types with BSPP thread: WEE-R

| Thread T | O-ring NBR | Steel | | Order code Retaining ring CF | O-ring FKM | Stainless Steel | | Order code Retaining ring Stainless Steel |
|-------------|----------------------|-------|-----|------------------------------------|-------------------------|-----------------|-----|---|
| | | D | L | | | D | L | |
| G 1/8 A | OR8X1.88X | 14.8 | 1.4 | RRS1/8CF | same like steel | 15.0 | 1.4 | 8207SS1/8 |
| G 1/4 A | OR10.77X2.62X | 19.8 | 1.9 | RRS1/4CF | OR10.77X2.62VITX | 19.5 | 1.9 | 8207SS1/4A |
| G 3/8 A | OR13.94X2.62X | 22.8 | 2.0 | RRS3/8CF | same like steel | 23.5 | 1.9 | 8207SS3/8A |
| G 1/2 A | OR18X3.15X | 27.8 | 2.6 | RRS1/2CF | OR17.96X2.62VITX | 28.5 | 1.9 | 8207SS1/2 |
| G 3/4 A | OR23X3X | 32.8 | 2.5 | RRS3/4CF | OR23.47X2.62VITX | 34.5 | 1.9 | 8207SS3/4 |
| G 1 A | OR29.74X3.53X | 40.8 | 2.5 | RRS1CF | same like steel | 43.5 | 2.6 | 8207SS1A |
| G 1 1/4 A | OR37.69X3.53X | 50.8 | 2.6 | RRS11/4CF | same like steel | 52.5 | 2.6 | 8207SS11/4 |
| G 1 1/2 A | OR44.04X3.53X | 55.8 | 2.6 | RRS11/2CF | same like steel | 60.0 | 2.6 | 8207SS11/2 |

| Order code suffixes | |
|---------------------|------------------|
| Material | Example |
| NBR | OR10.77X2.62X |
| FKM | OR10.77X2.62VITX |



OR O-Rings for banjo fittings WH/TH

| For WH / TH | For WH / TH | O-ring NBR | O-ring FKM |
|-------------|-------------|--------------------|-----------------------|
| 06LM/LR | | OR9.3X1.5X | OR9.3X1.5VITX |
| 08LM/LR | 06SM/SR | OR12.5X1.5X | OR12.5X1.5VITX |
| 10LM/LR | 08SM/SR | OR12.5X1.5X | OR12.5X1.5VITX |
| 12LM/LR | 10SM/SR | OR16X1.5X | OR16X1.5VITX |
| | 12SR | OR16X1.5X | OR16X1.5VITX |
| 15LM | 12SM | OR18X1.5X | OR18X1.5VITX |
| 15LR | | OR20X1.5X | OR20X1.5VITX |
| 18LM/LR | 16SM/SR | OR20X1.5X | OR20X1.5VITX |
| 22LM/LR | 20SM/SR | OR25X2X | OR25X2VITX |
| 28LM/LR | 25SM/SR | OR33X2.5X | OR33X2.5VITX |
| 35LM/LR | 30SM/SR | OR41X2.5X | OR41X2.5VITX |
| 42LM/LR | 38SM/SR | OR46X3X | OR46X3VITX |

OR O-Rings for banjo elbows SWVE..M/R KDSOMD

| For SWVE..M/R KDSOMD | O-ring NBR |
|---|----------------------|
| 04LLR/- 06LLR/LLM 08LLR/LLM 06LR/LM | OR9X1.2X |
| 08LM 06SM | OR10X1.5X |
| 08LR 06SR 10LR/LM 08SR/LM | OR12.5X1.5X |
| 12LR/LM 10SR/LM 12SR | OR15X1.5X |
| 15LM 12SM | OR16X1.5X |
| 15LR | OR19X1.5X |
| 18LR/LM 16SR/SM | OR20X1.5X |
| 22LR/LM 20SR/SM | OR25.12X1.78X |
| 28LR/LM 25SR/SM | OR33X2.5X |
| 35LR/LM 30SR/SM | OR41X2.5X |
| 42LR/LM 38SR/SM | OR46X3.0X |

DKI Sealing ring for pressure gauge connectors

| Female thread | D1 | D2 | L1 | Weight g/1 piece | Order code | |
|---------------|----|------|-----|------------------|------------------|--------------------|
| | | | | | Steel CF | Stainless Steel 71 |
| G 1/4 | 6 | 11.3 | 4.5 | 2.5 | DKI1/4CFX | DKI1/471X |
| G 1/2 | 12 | 18.5 | 5.0 | 5.0 | DKI1/2CFX | DKI1/271X |

KDS Soft sealing ring for banjo fittings SWVE, WH and TH from steel

for small and wide spot faces of ports

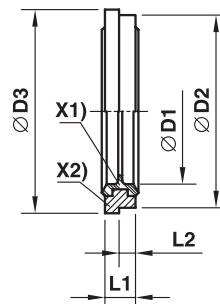

X1) NBR sealing
X2) Supporting-ring (Steel)

| Male stud metric thread | Male stud BSPP thread | D1 | D2 | D3 | L1 | L2 | Weight g/1 piece | Order code |
|----------------------------|--------------------------|------|------|------|-----|-----|---------------------|---------------|
| | | | | | | | | Steel/NBR |
| M 10×1.0 | G 1/8 A | 10.3 | 14.9 | 16.0 | 2.5 | 1.1 | 2 | KDS10X |
| M 12×1.5 | | 12.3 | 17.0 | 18.0 | 3.0 | 1.6 | 2 | KDS12X |
| M 14×1.5 | G 1/4 A | 14.3 | 18.9 | 20.0 | 3.0 | 1.6 | 2 | KDS14X |
| M 16×1.5 | G 3/8 A | 17.0 | 21.9 | 24.0 | 3.0 | 2.1 | 3 | KDS16X |
| M 18×1.5 | | 18.3 | 23.9 | 23.9 | 3.0 | | 4 | KDS18X |
| M 22×1.5 | G 1/2 A | 22.3 | 26.9 | 30.0 | 4.5 | 2.6 | 7 | KDS22X |
| M 26×1.5 | | 26.3 | 31.9 | 35.0 | 3.5 | 2.6 | 7 | KDS26X |
| M 27×2.0 | G 3/4 A | 27.3 | 32.9 | 38.0 | 3.5 | 2.6 | 8 | KDS27X |
| M 33×2.0 | G 1 A | 33.6 | 39.9 | 42.0 | 3.5 | 2.6 | 10 | KDS33X |
| M 42×2.0 | G 1 1/4 A | 42.4 | 49.9 | 49.9 | 3.5 | | 12 | KDS42X |
| M 48×2.0 | G 1 1/2 A | 48.4 | 55.9 | 60.0 | 3.5 | 2.6 | 16 | KDS48X |



KD Soft sealing ring for banjo fittings WH/TH from stainless steel

for wide spot faces of ports

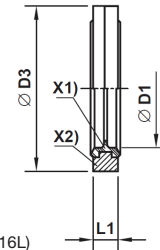

X1) Vulcanized FKM Seal
X2) Supporting-ring (Stainless Steel 316L)

| Metric thread parallel | BSPP thread parallel | D1 | D3 | L1 | Weight g/1 piece | Order code Stainless steel FKM |
|------------------------|----------------------|------|------|-----|------------------|--------------------------------------|
| M 10×1.0 | G 1/8 A | 10.3 | 17.0 | 2.5 | 3 | KD10-1/8SS |
| M 12×1.5 | | 12.3 | 22.0 | 3.0 | 5 | KD12SS |
| M 14×1.5 | G 1/4 A | 14.3 | 22.0 | 3.0 | 5 | KD14-1/4SS |
| M 16×1.5 | G 3/8 A | 17.0 | 27.0 | 3.0 | 6 | KD16-3/8SS |
| M 18×1.5 | | 18.3 | 29.0 | 3.0 | 8 | KD18SS |
| M 22×1.5 | G 1/2 A | 22.3 | 32.0 | 4.5 | 12 | KD22-1/2SS |
| M 26×1.5 | | 26.3 | 41.0 | 3.5 | 18 | KD26SS |
| M 27×2.0 | G 3/4 A | 27.3 | 41.0 | 3.5 | 19 | KD27-3/4SS |
| M 33×2.0 | G 1 A | 33.6 | 46.0 | 3.5 | 18 | KD33-1SS |
| M 42×2.0 | G 1 1/4 A | 42.4 | 57.0 | 3.5 | 26 | KD42-11/4SS |
| M 48×2.0 | G 1 1/2 A | 48.4 | 64.0 | 3.5 | 35 | KD48-11/2SS |



DKA Sealing ring

for banjo fittings WH/TH and SWVE

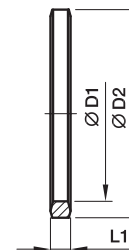

| BSPP thread | D1 | D2 | L1 | Weight g/1 piece | Order code | |
|-------------|------|----|-----|------------------|---------------|--------------------|
| | | | | | Steel CF | Stainless Steel 71 |
| G 1/8 A | 9.8 | 14 | 2.5 | 1 | DKA1/8CFX | DKA1/871X |
| G 1/4 A | 13.3 | 18 | 3.0 | 3 | DKA1/4CFX | DKA1/471X |
| G 3/8 A | 16.8 | 22 | 3.0 | 3 | DKA3/8CFX | DKA3/871X |
| G 1/2 A | 21.1 | 26 | 4.5 | 6 | DKA1/2X4.5CFX | DKA1/2X4.571X |
| G 3/4 A | 26.6 | 32 | 3.5 | 6 | DKA3/4CFX | DKA3/471X |
| G 1 A | 33.4 | 39 | 3.5 | 8 | DKA1CFX | DKA171X |
| G 1 1/4 A | 42.1 | 49 | 3.5 | 12 | DKA11/4CFX | DKA11/471X |
| G 1 1/2 A | 48.1 | 55 | 3.5 | 15 | DKA11/2CFX | DKA11/271X |

| Male stud metric thread | D1 | D2 | L1 | Weight g/1 piece | Order code | |
|-------------------------|------|----|-----|------------------|--------------|--------------------|
| | | | | | Steel CF | Stainless Steel 71 |
| M 08×1.0 | 8.1 | 12 | 2.5 | 1 | DKA08CFX | |
| M 10×1.0 | 10.1 | 14 | 3.0 | 1 | DKA10CFX | DKA1071X |
| M 12×1.5 | 12.1 | 17 | 3.0 | 2 | DKA12CFX | DKA1271X |
| M 14×1.5 | 14.1 | 19 | 3.0 | 3 | DKA14CFX | DKA1471X |
| M 16×1.5 | 16.1 | 21 | 3.0 | 3 | DKA16CFX | DKA1671X |
| M 18×1.5 | 18.1 | 23 | 3.0 | 3 | DKA18CFX | DKA1871X |
| M 20×1.5 | 20.1 | 25 | 3.0 | 4 | DKA20CFX | DKA2071X |
| M 22×1.5 | 22.1 | 27 | 4.5 | 6 | DKA22X4.5CFX | DKA22X4.571X |
| M 26×1.5 | 26.1 | 31 | 3.5 | 6 | DKA26X3.5CFX | DKA26X3.571X |
| M 27×2.0 | 27.1 | 32 | 3.5 | 6 | DKA27CFX | DKA2771X |
| M 33×2.0 | 33.1 | 39 | 3.5 | 8 | DKA33CFX | DKA3371X |
| M 42×2.0 | 42.1 | 49 | 3.5 | 12 | DKA11/4CFX | DKA11/471X |
| M 48×2.0 | 48.1 | 55 | 3.5 | 15 | DKA11/2CFX | DKA11/271X |





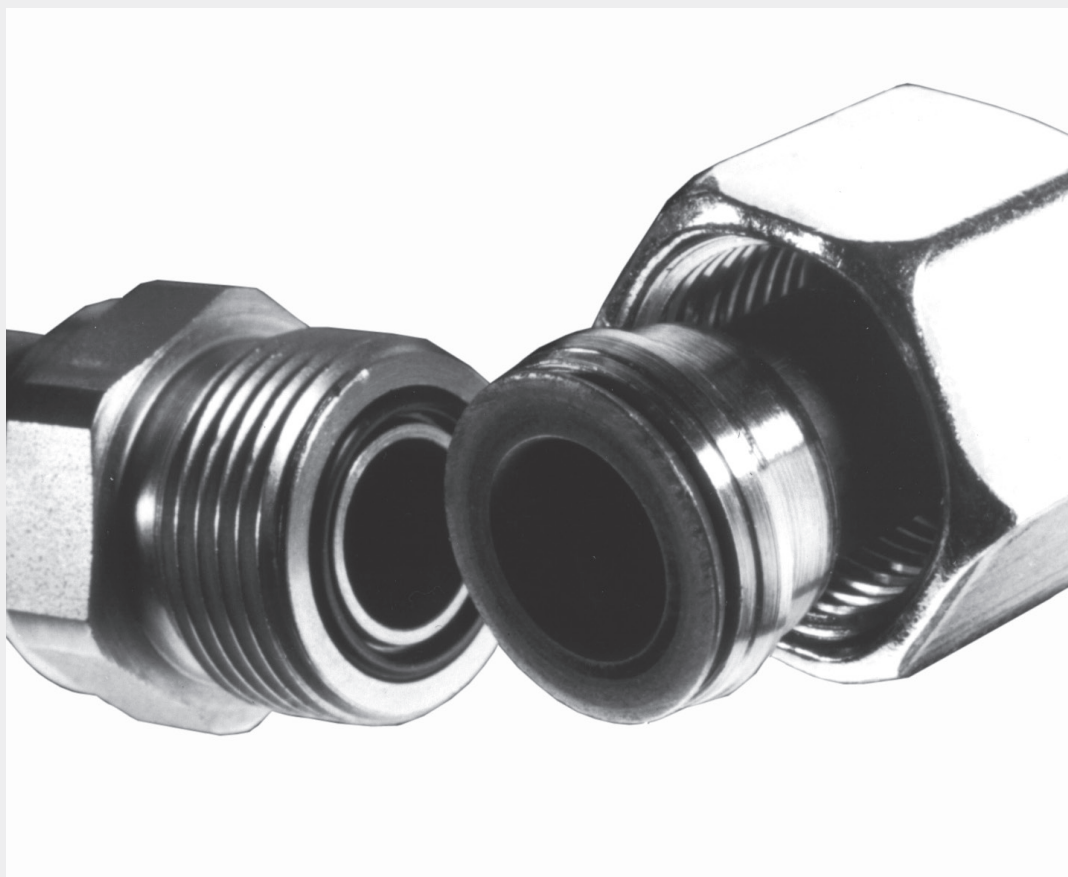







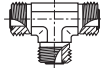
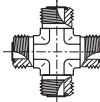
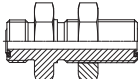

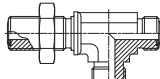

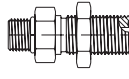





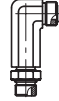

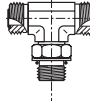
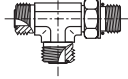
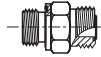
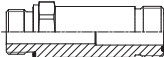
O-Lok[®]
O-Ring face seal tube fittings



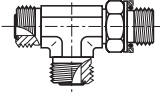
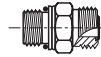

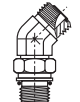
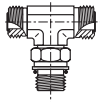
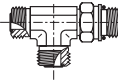
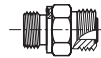

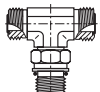
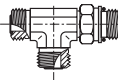
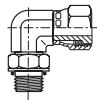
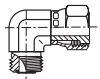
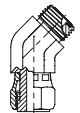
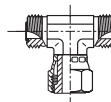
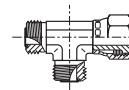



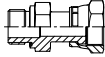
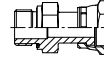
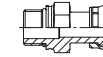
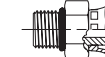

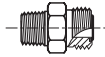















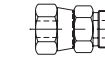

O-Lok®

Visual index

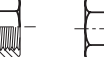
| | | | | | | | |
|----------------------------------|---|---|---|--|---|---|---|
| Tube-Tube unions |  |  |  |  | | | |
| | HMLO p. J9 | EMLO p. J10 | JMLO p. J11 | KLO p. J12 | | | |
| Bulkhead unions |  |  |  |  |  |  |  |
| | WMLO p. J13 | WEMLO p. J14 | WJJLO p. J17 | WJLO p. J16 | WF5OLO p. J29 | WNLO p. J15 | WLNML p. J72 |
| Tube to UNF thread |  |  |  |  |  |  |  |
| | F5OMLO p. J27 | FF5OMLO p. J28 | C5OMLO p. J39 | CC5OLO p. J40 | V5OMLO p. J45 | S5OMLO p. J49 | R5OMLO p. J53 |
| Tube to BSPP thread |  |  |  |  |  |  | |
| | F42EDMLO p. J30 | FF42EDMLO p. J31 | C4OMLO p. J41 | V4OMLO p. J46 | S4OMLO p. J50 | R4OMLO p. J54 | |
| Tube to metric ISO 6149-2 thread |  |  |  |  |  | | |
| | F87OMLO p. J26 | C87OMLO p. J38 | V87OMLO p. J44 | S87OMLO p. J48 | R87OMLO p. J52 | | |
| Tube to metric thread |  |  |  |  |  | | |
| | F82EDMLO p. J32 | C8OMLO p. J42 | V8OMLO p. J47 | S8OMLO p. J51 | R8OMLO p. J55 | | |
| Swivel fittings |  |  |  |  |  | | |
| | AOEL6 p. J18 | C6MLO p. J19 | V6LO p. J20 | S6MLO p. J21 | R6MLO p. J22 | | |

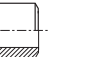
Visual index

| | | | | | | | | |
|----------------------------------|---|---|---|---|--|--|------------------------|------------------------|
| Swivel nut to straight thread |  BSPF F642EDML p. J36 |  Metric F682EDML p. J37 |  ISO Metric F687OML p. J34 |  UNF F65OL p. J35 |  HL6 p. J25 | | | |
| Tube to NPTF thread |  FLO p. J33 |  CLO p. J43 | Taper threads should not be used for new projects or designs. Parker Hannifin recommends elastomerically sealed components. | | | | | |
| Bleed adapters |  FNLBA p. J69 |  PNLOBA p. J70 |  NPTF HPBA p. J71 |  UNF P5ONBA p. J71 | | | | |
| Test point and gauge adapters |  TTP4ML p. J60 |  R6P4MLO p. J61 |  G4MLOSOMO p. J57 |  TT4ML p. J58 |  TT8ML p. J59 |  G87MLO p. J56 | | |
| Sleeves for metric and inch tube |  TPL p. J6 |  TL p. J7 |  TL Reducing Braze Sleeve p. J8 | Nuts, Reducers & Expanders    | | BML/BL p. J5 | TRMLO p. J23 | LOHL6 p. J24 |
| Conversion adapters |  XHML0 p. J65 |  XHML6 p. J66 |  LOHMX6 p. J67 |  LOHU86 p. J68 | | | | |
| Accessories |  LOHB3 p. J62 |  FNML p. J63 |  PNMLO p. J64 |  O-ring p. J73-74 |  SBR Braze ring p. J75 |  TW3L p. J72 | | |

J

O-Lok®

How to order O-Lok® fittings

Example Order code **6-8 C 5 O M L O S**

1 2 3 4 5 6 7 8

1 Order codes for tube and port thread ends

| Dash Size | Tube Size (Inch) | Tube Size (mm) | O-Lok Tube Thread Size | Port Thread Size (Inch) BSPP/BSPT/NPT | Port Thread Size UN / UNF |
|-----------|------------------|----------------|------------------------|---------------------------------------|---------------------------|
| 4 | 1/4 | 6 | 9/16-18 | 1/4 | 7/16-20 |
| 5 | | | 5/8-18 | | 1/2-20 |
| 6 | 3/8 | 8,10 | 11/16-16 | 3/8 | 9/16-18 |
| 8 | 1/2 | 12 | 13/16-16 | 1/2 | 3/4-16 |
| 10 | 5/8 | 14,15,16 | 1-14 | 5/8 | 7/8-14 |
| 12 | 3/4 | 18,20 | 1 3/16-12 | 3/4 | 1 1/8-12 |
| 14 | | | 1 5/16-12 | | 1 3/8-12 |
| 16 | 1 | 25 | 1 7/16-12 | 1 | 1 5/16-12 |
| 20 | 1 1/4 | 28,30,32 | 1 11/16-12 | 1 1/4 | 1 5/8-12 |
| 24 | 1 1/2 | 35,38 | 2-12 | 1 1/2 | 1 7/8-12 |
| 32 | 2 | 50 | 2 1/2-12 | 2 | 2 1/2-12 |

Metric port threads are shown as per example 4M12C87OMLOS

3 Threads and sealing methods

| Code | Description |
|------|--|
| None | NPT/NPTF Thread |
| 3 | BSPT Thread |
| 4 | BSPP Thread O-Ring & Retainer Ring |
| 42 | BSPP Thread EOLASTIC seal 'ED' |
| 5 | UN/UNF Thread (O-Ring Seal) |
| 8 | Metric Thread O-Ring & Retainer Ring |
| 82 | Metric Thread EOLASTIC seal 'ED' |
| 87 | Metric ISO 6149 Thread (O-Ring Seal) |
| 63 | Swivel Connector BSPT end |
| 64 | Swivel Connector BSPP end (O-Ring & Retainer Ring) |
| 642 | Swivel Connector BSPP end (EOLASTIC Seal 'ED') |
| 65 | Swivel Connector UN/UNF end (O-Ring seal) |
| 68 | Swivel Connector Metric end (O-Ring & Retainer Ring) |
| 682 | Swivel Connector Metric end (EOLASTIC Seal 'ED') |
| 687 | Swivel Connector Metric ISO 6149 end |

2 Codes for fitting styles/shapes

| Code | Description |
|--------|-----------------------------------|
| AE6 | Straight Thread Swivel |
| B | Nut |
| C | Male Stud elbow |
| C6 | Swivel Nut Elbow |
| E | Union elbow |
| F | Male Stud connector |
| FF | Extended Male Stud connector |
| F6 | Male Stud Swivel |
| FN | Cap |
| FNLBAS | Bleed Adapter Cap |
| G | Female Connector |
| H | Straight union |
| H6 | Swivel/Swivel Adapter |
| J | Union Tee |
| K | Union Cross |
| LOHB3 | Braze Adapter |
| LOHX6 | Triple-Lok® Swivel/O-Lok® adaptor |
| M | Female Run Tee |
| O | Female Branch Tee |
| PN | Plug |
| PNLOBA | Bleed Adapter Plug |
| R | Male Stud Run Tee |
| R6 | Swivel Run Tee |
| S | Male Stud Branch Tee |
| S6 | Swivel Branch Tee |
| SBR | Braze Ring |
| TPL | Parflange® sleeve |
| TL | Brazed sleeve |
| TR | Tube End Reducer |
| TT | Test Point Adapter |
| TW3 | Weld Nipple |
| V | 45° male stud elbow |
| V6 | Swivel Nut 45° Elbow |
| W | Bulkhead Union |
| WE | Bulkhead Union Elbow |
| WJJ | Bulkhead Run Tee |
| WJT | Bulkhead Branch Tee |
| WLNML | Bulkhead Locknut |
| WN | Bulkhead 45° union elbow |
| XHL6 | Triple Lok®/Swivel O-Lok® adaptor |
| XHLO | Triple Lok®/O-Lok® male adaptor |

4 Stud connector seal

| Code | Description |
|---------|--|
| O | O-Ring Seal (Assembled on fitting) |
| ED | Captive EOLASTIC Seal (Assembled on fitting) |
| No Code | No Seal (O-Ring not assembled on fitting) |

5 Hexagon/ Across flats style

| Code | Description |
|---------|--------------------------|
| M | Metric Hexagon Dimension |
| No Code | Inch Hexagon Dimension |

6 Fitting type

| Code | Description |
|------|---------------|
| L | Parker O-Lok® |

7 Tube connection seal ORFS

| Code | Description |
|---------|------------------------------------|
| O | O-Ring Seal (Assembled on Fitting) |
| No Code | No Seal/O-Ring |

8 Fitting material

| Code | Description |
|------|-----------------|
| S | Steel |
| SS | Stainless Steel |
| B | Brass |

BML Nut

O-Lok® ORFS tube nut
SAE 52M0110 ISO 8434-3 NA

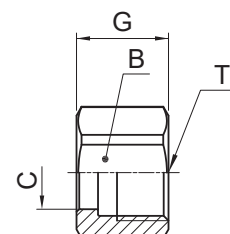

| Tube O.D. | | Thread UN/UNF-2B T | B mm | C mm | G mm | Weight (steel) g/1 piece | O-Lok® Steel | O-Lok® Stainless Steel |
|------------|-------|--------------------|------|------|------|--------------------------|---------------|------------------------|
| mm | in. | | | | | | | |
| 6 | 1/4 | 9/16-18 | 17 | 10.5 | 15 | 14 | 4BMLS | 4BMLSS |
| 8, 10 | 3/8 | 11/16-16 | 22 | 13.5 | 18 | 17 | 6BMLS | 6BMLSS |
| 12 | 1/2 | 13/16-16 | 24 | 16.6 | 20 | 29 | 8BMLS | 8BMLSS |
| 14, 15, 16 | 5/8 | 1-14 | 30 | 21.1 | 24 | 46 | 10BMLS | 10BMLSS |
| 18, 20 | 3/4 | 1 3/16-12 | 36 | 24.2 | 27 | 69 | 12BMLS | 12BMLSS |
| 22, 25 | 1 | 1 7/16-12 | 41 | 29.1 | 28 | 109 | 16BMLS | 16BMLSS |
| 28, 30, 32 | 1 1/4 | 1 11/16-12 | 50 | 36.0 | 28 | 126 | 20BMLS | 20BMLSS |
| 35, 38 | 1 1/2 | 2-12 | 60 | 44.0 | 28 | 195 | 24BMLS | 24BMLSS |
| 50 | 2 | 2 1/2-12 | 75 | 56.0 | 33 | 800 | 32BMLS | 32BMLSS |

Part numbers shown are part of our current manufacturing programme.
Do not create drawings from these dimensions, they are subject to change and ISO manufacturing allowances.

J

BL Nut

O-Lok® ORFS tube nut
SAE 520110

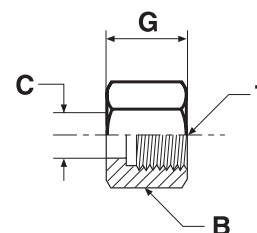

| Tube O.D. | | Thread UN/UNF-2B T | B in. | C mm | G mm | Weight (steel) g/1 piece | O-Lok® Steel | O-Lok® Stainless Steel |
|------------|-------|--------------------|-------|------|------|--------------------------|----------------|------------------------|
| mm | in. | | | | | | | |
| 6 | 1/4 | 9/16-18 | 11/16 | 10.5 | 15 | 16 | 4 BL-S | 4 BL-SS |
| 8, 10 | 3/8 | 11/16-16 | 13/16 | 13.5 | 17 | 24 | 6 BL-S | 6 BL-SS |
| 12 | 1/2 | 13/16-16 | 15/16 | 16.6 | 21 | 37 | 8 BL-S | 8 BL-SS |
| 14, 15, 16 | 5/8 | 1-14 | 1 1/8 | 22.1 | 24 | 52 | 10 BL-S | 10 BL-SS |
| 18, 20 | 3/4 | 1 3/16-12 | 1 3/8 | 24.1 | 26 | 89 | 12 BL-S | 12 BL-SS |
| 22, 25 | 1 | 1 7/16-12 | 1 5/8 | 29.1 | 28 | 119 | 16 BL-S | 16 BL-SS |
| 28, 30, 32 | 1 1/4 | 1 11/16-12 | 1 7/8 | 36.0 | 28 | 132 | 20 BL-S | 20 BL-SS |
| 35, 38 | 1 1/2 | 2-12 | 2 1/4 | 44.0 | 28 | 220 | 24 BL-S | 24 BL-SS |
| 50 | 2 | 2 1/2-12 | 2 7/8 | 56.0 | 33 | 700 | 32 BL-S | 32 BL-SS |

Part numbers shown are part of our current manufacturing programme.
Do not create drawings from these dimensions, they are subject to change and ISO manufacturing allowances.

O-Lok®
TPL Sleeve metric tubing

O-Lok® ORFS Parflange® tube sleeve

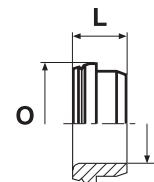

| Tube O.D. 1 mm | L mm | O mm | Weight (steel) g/1 piece | O-Lok® Steel | O-Lok® Stainless Steel |
|----------------------|---------|---------|--------------------------------|------------------|---------------------------|
| 6 | 8 | 13 | 4 | TPLS6 | TPLSS6 |
| 8 | 8 | 13 | 4 | TPLS8-6 | TPLSS8-6 |
| 8 | 9 | 16 | 4 | TPLS8 | TPLSS8 |
| 10 | 9 | 16 | 5 | TPLS10 | TPLSS10 |
| 10 | 11 | 19 | 6 | TPLS12-10 | TPLSS12-10 |
| 12 | 11 | 19 | 6 | TPLS12 | TPLSS12 |
| 14 | 11 | 23 | 10 | TPLS14 | TPLSS14 |
| 15 | 11 | 23 | 9 | TPLS15 | TPLSS15 |
| 16 | 11 | 23 | 8 | TPLS16 | TPLSS16 |
| 18 | 12 | 28 | 14 | TPLS18 | TPLSS18 |
| 20 | 12 | 28 | 15 | TPLS20 | TPLSS20 |
| 22 | 14 | 34 | 20 | TPLS22 | TPLSS22 |
| 25 | 13 | 34 | 23 | TPLS25 | TPLSS25 |
| 28 | 13 | 40 | 24 | TPLS28 | TPLSS28 |
| 30 | 13 | 40 | 25 | TPLS30 | TPLSS30 |
| 32 | 13 | 40 | 26 | TPLS32 | TPLSS32 |
| 35 | 13 | 48 | 36 | TPLS35 | TPLSS35 |
| 38 | 13 | 48 | 44 | TPLS38 | TPLSS38 |
| 50 | 14 | 61 | 180 | TPLS50 | TPLSS50 |

Part numbers shown are part of our current manufacturing programme.
Do not create drawings from these dimensions, they are subject to change and ISO manufacturing allowances.

TPL Sleeve inch tubing

O-Lok® ORFS Parflange® tube sleeve

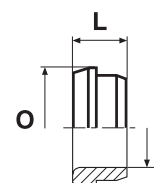

| Tube O.D. 1 in. | L mm | O mm | Weight (steel) g/1 piece | O-Lok® Steel | O-Lok® Stainless Steel |
|-----------------------|---------|---------|--------------------------------|-----------------|---------------------------|
| 1/4 | 8 | 13 | 4 | 4 TPL-S | 4 TPL-SS |
| 3/8 | 9 | 16 | 5 | 6 TPL-S | 6 TPL-SS |
| 1/2 | 11 | 19 | 6 | 8 TPL-S | 8 TPL-SS |
| 5/8 | 11 | 23 | 11 | 10 TPL-S | 10 TPL-SS |
| 3/4 | 12 | 28 | 19 | 12 TPL-S | 12 TPL-SS |
| 7/8 | 14 | 31 | 19 | 14 TPL-S | 14 TPL-SS |
| 1 | 14 | 34 | 22 | 16 TPL-S | 16 TPL-SS |
| 1 1/4 | 13 | 41 | 28 | 20 TPL-S | 20 TPL-SS |
| 1 1/2 | 13 | 48 | 44 | 24 TPL-S | 24 TPL-SS |
| 2 | 14 | 61 | 180 | 32 TPL-S | 32 TPL-SS |

Part numbers shown are part of our current manufacturing programme.
Do not create drawings from these dimensions, they are subject to change and ISO manufacturing allowances.

TL* Braze sleeve metric tubing

O-Lok® ORFS silver braze tube sleeve
 SAE 52M0115 ISO 8434-3 BRSL
 (*Parts delivered oil dipped finish only – steel)

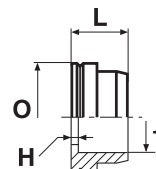

| ORFS dash size | Tube O.D. 1 mm | H mm | L mm | O mm | Weight (steel) g/1 piece | O-Lok® Steel | O-Lok® Stainless Steel |
|----------------|----------------|------|------|------|--------------------------|-----------------|------------------------|
| 4 | 6 | 1 | 10 | 13 | 5 | TLS6 | TLSS6 |
| 4 | 8 | 1 | 10 | 13 | 5 | TLS6-8 | TLSS6-8 |
| 5 | 8 | 1 | 10 | 16 | 7 | TLS8 | TLSS8 |
| 6 | 8 | 2 | 10 | 16 | 7 | TLS10-8 | TLSS10-8 |
| 6 | 10 | 1 | 10 | 16 | 7 | TLS10 | TLSS10 |
| 8 | 10 | 4 | 12 | 19 | 10 | TLS12-10 | TLSS12-10 |
| 8 | 12 | 1 | 10 | 19 | 10 | TLS12 | TLSS12 |
| 10 | 15 | 2 | 11 | 23 | 16 | TLS16-15 | TLSS16-15 |
| 10 | 16 | 2 | 11 | 23 | 16 | TLS16 | TLSS16 |
| 12 | 18 | 2 | 14 | 28 | 26 | TLS20-18 | TLSS20-18 |
| 12 | 20 | 2 | 14 | 28 | 21 | TLS20 | TLSS20 |
| 16 | 22 | 2 | 16 | 34 | 33 | TLS25-22 | TLSS25-22 |
| 16 | 25 | 2 | 16 | 34 | 30 | TLS25 | TLSS25 |
| 20 | 28 | 2 | 16 | 41 | 41 | TLS32-28 | TLSS32-28 |
| 20 | 30 | 2 | 16 | 41 | 42 | TLS32-30 | TLSS32-30 |
| 20 | 32 | 2 | 16 | 41 | 40 | TLS32 | TLSS32 |
| 24 | 35 | 2 | 16 | 49 | 48 | TLS38-35 | TLSS38-35 |
| 24 | 38 | 2 | 16 | 49 | 63 | TLS38 | TLSS38 |

Part numbers shown are part of our current manufacturing programme.
 Do not create drawings from these dimensions, they are subject to change and ISO manufacturing allowances.

TL* Braze sleeve inch tubing

O-Lok® ORFS silver braze tube sleeve
 SAE 520115
 (*Parts delivered oil dipped finish only – steel)

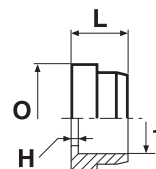

| Tube O.D. 1 in. | H mm | L mm | O mm | Weight (steel) g/1 piece | O-Lok® Steel | O-Lok® Stainless Steel |
|-----------------|------|------|------|--------------------------|----------------|------------------------|
| 1/4 | 1 | 10 | 13 | 5 | 4 TL-S | 4 TL-SS |
| 3/8 | 1 | 10 | 16 | 6 | 6 TL-S | 6 TL-SS |
| 1/2 | 1 | 10 | 19 | 10 | 8 TL-S | 8 TL-SS |
| 5/8 | 2 | 11 | 23 | 18 | 10 TL-S | 10 TL-SS |
| 3/4 | 2 | 14 | 28 | 26 | 12 TL-S | 12 TL-SS |
| 1 | 2 | 16 | 34 | 33 | 16 TL-S | 16 TL-SS |
| 1 1/4 | 2 | 16 | 41 | 42 | 20 TL-S | 20 TL-SS |
| 1 1/2 | 2 | 16 | 49 | 63 | 24 TL-S | 24 TL-SS |
| 2 | 2 | 17 | 61 | 210 | 32 TL-S | 32 TL-SS |

Part numbers shown are part of our current manufacturing programme.
 Do not create drawings from these dimensions, they are subject to change and ISO manufacturing allowances.

O-Lok®

TL* Reducing braze sleeve inch tubing

O-Lok® ORFS silver braze tube sleeve
 SAE 520115
 (*Parts delivered oil dipped finish only – steel)

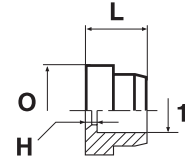

| ORFS dash size | Tube O.D. 1 in. | H mm | L mm | O mm | Weight (Steel) g/1 piece | O-Lok® Steel | O-Lok® Stainless Steel |
|----------------|-----------------|------|------|------|--------------------------|-------------------|------------------------|
| 6 | 1/4 | 2 | 10 | 16 | 10 | 6-4 TL-S | 6-4 TL-SS |
| 8 | 1/4 | 4 | 12 | 19 | 17 | 8-4 TL-S | 8-4 TL-SS |
| 8 | 3/8 | 4 | 12 | 19 | 17 | 8-6 TL-S | 8-6 TL-SS |
| 10 | 1/4 | 5 | 14 | 23 | 37 | 10-4 TL-S | 10-4 TL-SS |
| 10 | 3/8 | 5 | 14 | 23 | 32 | 10-6 TL-S | 10-6 TL-SS |
| 10 | 1/2 | 5 | 14 | 23 | 28 | 10-8 TL-S | 10-8 TL-SS |
| 12 | 1/4 | 6 | 15 | 28 | 54 | 12-4 TL-S | 12-4 TL-SS |
| 12 | 3/8 | 6 | 15 | 28 | 49 | 12-6 TL-S | 12-6 TL-SS |
| 12 | 1/2 | 6 | 15 | 28 | 44 | 12-8 TL-S | 12-8 TL-SS |
| 12 | 5/8 | 6 | 15 | 28 | 39 | 12-10 TL-S | 12-10 TL-SS |
| 16 | 1/2 | 7 | 16 | 34 | 76 | 16-8 TL-S | 16-8 TL-SS |
| 16 | 5/8 | 7 | 16 | 34 | 71 | 16-10 TL-S | 16-10 TL-SS |
| 16 | 3/4 | 5 | 17 | 34 | 66 | 16-12 TL-S | 16-12 TL-SS |
| 16 | 7/8 | 5 | 17 | 34 | 50 | 16-14 TL-S | 16-14 TL-SS |
| 20 | 3/4 | 7 | 20 | 41 | 102 | 20-12 TL-S | 20-12 TL-SS |
| 20 | 1 | 7 | 21 | 41 | 79 | 20-16 TL-S | 20-16 TL-SS |
| 24 | 1 | 7 | 21 | 49 | 141 | 24-16 TL-S | 24-16 TL-SS |
| 24 | 1 1/4 | 7 | 21 | 49 | 107 | 24-20 TL-S | 24-20 TL-SS |

Part numbers shown are part of our current manufacturing programme.
 Do not create drawings from these dimensions, they are subject to change and ISO manufacturing allowances.

HMLO Union

O-Lok® ORFS tube ends
SAE 520101

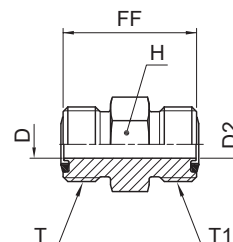

| Tube 1 O.D. | | Tube 2 O.D. | | Thread UN/UNF-2A T | Thread UN/UNF-2A T1 | D | D2 | FF | H | Weight (steel) g/1 piece | O-Lok® Steel | O-Lok® Stainless Steel | PN (bar) | |
|----------------|-----------|----------------|-----------|--------------------------|---------------------------|------|------|----|----|--------------------------------|-------------------|---------------------------|----------|-----|
| mm | in. | mm | in. | | | mm | mm | mm | mm | | | | S | SS |
| 6 | 1/4 | 6 | 1/4 | 9/16-18 | 9/16-18 | 4.5 | 4.5 | 28 | 17 | 31 | 4HMLOS | 4HMLOSS | 630 | 630 |
| 8, 10 | 5/16, 3/8 | 8, 10 | 5/16, 3/8 | 11/16-16 | 11/16-16 | 6.5 | 6.5 | 31 | 19 | 49 | 6HMLOS | 6HMLOSS | 630 | 630 |
| 10 | 3/8 | 6 | 1/4 | 11/16-16 | 9/16-18 | 6.5 | 4.5 | 30 | 19 | 45 | 6-4HMLOS | 6-4HMLOSS | 630 | 630 |
| 12 | 1/2 | 12 | 1/2 | 13/16-16 | 13/16-16 | 9.5 | 9.5 | 36 | 22 | 77 | 8HMLOS | 8HMLOSS | 630 | 630 |
| 12 | 1/2 | 10 | 3/8 | 13/16-16 | 11/16-16 | 9.5 | 6.5 | 34 | 22 | 67 | 8-6 HLO-S | 8-6HMLOSS | 630 | 630 |
| 14, 15, 16 | 5/8 | 10 | 3/8 | 1-14 | 11/16-16 | 12.5 | 6.5 | 38 | 27 | 113 | 10-6HMLOS | 10-6HMLOSS | 420 | 420 |
| 14, 15, 16 | 5/8 | 14, 15, 16 | 5/8 | 1-14 | 1-14 | 12.5 | 12.5 | 43 | 27 | 129 | 10HMLOS | 10HMLOSS | 420 | 420 |
| 16 | 5/8 | 12 | 1/2 | 1-14 | 13/16-16 | 12.5 | 9.5 | 40 | 27 | 112 | 10-8 HLO-S | 10-8HMLOSS | 420 | 420 |
| 18, 20 | 3/4 | 12 | 1/2 | 1 3/16-12 | 13/16-16 | 15.5 | 9.5 | 43 | 32 | 160 | 12-8HMLOS | 12-8HMLOSS | 420 | 420 |
| 18, 20 | 3/4 | 18, 20 | 3/4 | 1 3/16-12 | 1 3/16-12 | 15.5 | 15.5 | 47 | 32 | 204 | 12HMLOS | 12HMLOSS | 420 | 420 |
| 20 | 3/4 | 16 | 5/8 | 1 3/16-12 | 1-14 | 15.5 | 12.5 | 46 | 32 | 186 | 12-10HMLOS | 12-10HMLOSS | 420 | 420 |
| 22, 25 | 1 | 22, 25 | 1 | 1 7/16-12 | 1 7/16-12 | 20.5 | 20.5 | 49 | 41 | 291 | 16HMLOS | 16HMLOSS | 420 | 420 |
| 25 | 1 | 18, 20 | 3/4 | 1 7/16-12 | 1 3/16-12 | 20.5 | 15.5 | 49 | 41 | 285 | 16-12HMLOS | 16-12HMLOSS | 420 | 420 |
| 28, 30, 32 | 1 1/4 | 28, 30, 32 | 1 1/4 | 1 11/16-12 | 1 11/16-12 | 26.0 | 26.0 | 51 | 45 | 299 | 20 HLO-S | 20HMLOSS | 420 | 280 |
| 28, 30, 32 | 1 1/4 | 22, 25 | 1 | 1 11/16-12 | 1 7/16-12 | 26.0 | 20.5 | 52 | 46 | 280 | 20-16HMLOS | 20-16HMLOSS | 420 | 280 |
| 35, 38 | 1 1/2 | 35, 38 | 1 1/2 | 2-12 | 2-12 | 32.0 | 32.0 | 53 | 54 | 552 | 24 HLO-S | 24HMLOSS | 350 | 280 |
| 35, 38 | 1 1/2 | 28, 30, 32 | 1 1/4 | 2-12 | 1 11/16-12 | 32.0 | 26.0 | 53 | 55 | 530 | 24-20HMLOS | 24-20HMLOSS | 350 | 280 |

J

Product delivered with NBR TRAP seal. Replacement of TRAP seal is with a standard NBR O-ring – see page J73-J74.

Part numbers shown are part of our current manufacturing programme.

Imperial and metric parts may vary in hexagon dimensions.

$$\frac{\text{PN (bar)}}{10} = \text{PN (MPa)}$$

Do not create drawings from these dimensions, they are subject to change and ISO manufacturing allowances.

O-Lok®
EMLO Union elbow

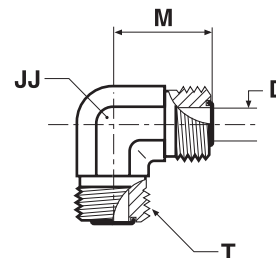
 O-Lok® ORFS tube ends
 SAE 520201

| Tube O.D. | | Thread UN/UNF-2A T | D mm | JJ* mm | M mm | Weight (steel) g/1 piece | O-Lok® Steel | O-Lok® Stainless Steel | PN (bar) | |
|------------|-----------|--------------------|------|--------|------|--------------------------|-----------------|------------------------|----------|-----|
| mm | in. | | | | | | | | S | SS |
| 6 | 1/4 | 9/16-18 | 4.5 | 14 | 22 | 47 | 4 ELO-S | 4EMLOSS | 630 | 630 |
| 8, 10 | 5/16, 3/8 | 11/16-16 | 6.5 | 19 | 25 | 109 | 6 ELO-S | 6EMLOSS | 630 | 630 |
| 12 | 1/2 | 13/16-16 | 9.5 | 19 | 28 | 123 | 8 ELO-S | 8EMLOSS | 630 | 630 |
| 14, 15, 16 | 5/8 | 1-14 | 12.5 | 27 | 34 | 183 | 10 ELO-S | 10EMLOSS | 420 | 420 |
| 18, 20 | 3/4 | 1 3/16-12 | 15.5 | 30 | 38 | 255 | 12 ELO-S | 12EMLOSS | 420 | 420 |
| 22, 25 | 1 | 1 7/16-12 | 20.5 | 36 | 42 | 457 | 16 ELO-S | 16EMLOSS | 420 | 420 |
| 28, 30, 32 | 1 1/4 | 1 11/16-12 | 26.0 | 41 | 45 | 530 | 20 ELO-S | 20EMLOSS | 350 | 280 |
| 35, 38 | 1 1/2 | 2-12 | 32.0 | 48 | 49 | 687 | 24 ELO-S | 24EMLOSS | 280 | 280 |

Product delivered with NBR TRAP seal. Replacement of TRAP seal is with a standard NBR O-ring – see page J73-J74.

Part numbers shown are part of our current manufacturing programme.

Imperial and metric parts may vary in hexagon dimensions.

$$\frac{\text{PN (bar)}}{10} = \text{PN (MPa)}$$

Do not create drawings from these dimensions, they are subject to change and ISO manufacturing allowances.

*JJ may vary in stainless steel

JMLO Union tee

O-Lok® ORFS tube ends
SAE 520401

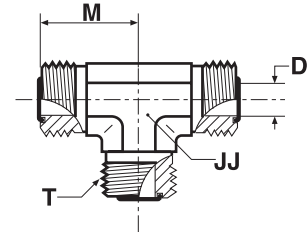

| Tube O.D. | | Thread UN/UNF-2A T | D mm | JJ* mm | M mm | Weight (steel) g/1 piece | O-Lok® | | PN (bar) | |
|------------|-----------|--------------------|------|--------|------|--------------------------|-----------------|-----------------|----------|-----|
| mm | in. | | | | | | Steel | Stainless Steel | S | SS |
| 6 | 1/4 | 9/16-18 | 4.5 | 14 | 22 | 66 | 4JMLOS | 4JMLOSS | 630 | 630 |
| 8, 10 | 5/16, 3/8 | 11/16-16 | 6.5 | 19 | 25 | 114 | 6JMLOS | 6JMLOSS | 630 | 630 |
| 12 | 1/2 | 13/16-16 | 9.5 | 19 | 28 | 199 | 8JMLOS | 8JMLOSS | 630 | 630 |
| 14, 15, 16 | 5/8 | 1-14 | 12.5 | 27 | 34 | 239 | 10 JLO-S | 10JMLOSS | 420 | 420 |
| 18, 20 | 3/4 | 1 3/16-12 | 15.5 | 30 | 38 | 321 | 12 JLO-S | 12JMLOSS | 420 | 420 |
| 22, 25 | 1 | 1 7/16-12 | 20.5 | 36 | 42 | 488 | 16 JLO-S | 16JMLOSS | 420 | 420 |
| 28, 30, 32 | 1 1/4 | 1 11/16-12 | 26.0 | 41 | 45 | 768 | 20 JLO-S | 20JMLOSS | 350 | 280 |
| 35, 38 | 1 1/2 | 2-12 | 32.0 | 48 | 49 | 866 | 24 JLO-S | 24JMLOSS | 280 | 280 |

Product delivered with NBR TRAP seal. Replacement of TRAP seal is with a standard NBR O-ring – see page J73-J74.

Part numbers shown are part of our current manufacturing programme.

Imperial and metric parts may vary in hexagon dimensions.

$$\frac{\text{PN (bar)}}{10} = \text{PN (MPa)}$$

Do not create drawings from these dimensions, they are subject to change and ISO manufacturing allowances.

*JJ may vary in stainless steel

J

O-Lok®

KLO Union cross

O-Lok® ORFS tube ends
SAE 520501

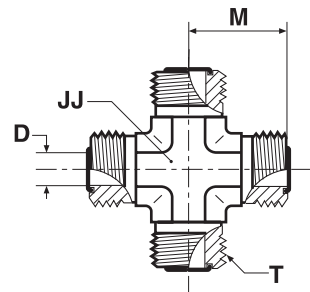

| Tube O.D. | | Thread UN/UNF-2A T | D mm | JJ* mm | M mm | Weight (steel) g/1 piece | O-Lok® Steel | O-Lok® Stainless Steel | PN (bar) | |
|------------|-----------|--------------------|------|--------|------|--------------------------|-----------------|------------------------|----------|-----|
| mm | in. | | | | | | | | S | SS |
| 6 | 1/4 | 9/16-18 | 4.5 | 14 | 22 | 72 | 4 KLO-S | 4 KLO-SS | 630 | 630 |
| 8, 10 | 5/16, 3/8 | 11/16-16 | 6.5 | 19 | 25 | 140 | 6 KLO-S | 6 KLO-SS | 630 | 630 |
| 12 | 1/2 | 13/16-16 | 9.5 | 19 | 28 | 225 | 8 KLO-S | 8 KLO-SS | 630 | 630 |
| 14, 15, 16 | 5/8 | 1-14 | 12.5 | 27 | 33 | 288 | 10 KLO-S | 10 KLO-SS | 420 | 420 |
| 18, 20 | 3/4 | 1 3/16-12 | 15.5 | 30 | 37 | 415 | 12 KLO-S | 12 KLO-SS | 420 | 420 |
| 22, 25 | 1 | 1 7/16-12 | 20.5 | 41 | 42 | 967 | 16 KLO-S | 16 KLO-SS | 420 | 420 |
| 28, 30, 32 | 1 1/4 | 1 11/16-12 | 26.0 | 41 | 45 | 1247 | 20 KLO-S | 20 KLO-SS | 350 | 280 |
| 35, 38 | 1 1/2 | 2-12 | 32.0 | 48 | 49 | 1592 | 24 KLO-S | 24 KLO-SS | 280 | 280 |

Product delivered with NBR TRAP seal. Replacement of TRAP seal is with a standard NBR O-ring – see page J73-J74.

Part numbers shown are part of our current manufacturing programme.

Imperial and metric parts may vary in hexagon dimensions.

$$\frac{PN \text{ (bar)}}{10} = PN \text{ (MPa)}$$

Do not create drawings from these dimensions, they are subject to change and ISO manufacturing allowances.

*JJ may vary in stainless steel

WMLO Bulkhead union

O-Lok® ORFS tube ends
SAE 520601 ISO 8434-3 BHS

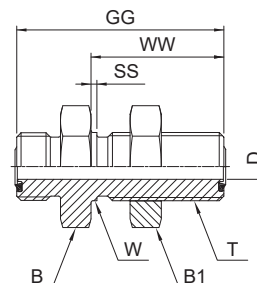

| Tube O.D. | | Thread UN/UNF-2A T | B1 mm | B mm | D mm | GG mm | SS mm | W mm | WW mm | Weight (steel) g/1 piece | O-Lok® | | PN (bar) | |
|------------|-----------|--------------------------|----------|---------|---------|----------|----------|---------|----------|--------------------------------|----------------------|---------------------|----------|-----|
| mm | in. | | | | | | | | | | Steel | Stainless Steel | S | SS |
| 6 | 1/4 | 9/16-18 | 20.6 | 21 | 4.5 | 48 | 2 | 14 | 32 | 65 | 4 WLO-WLNL-S | 4WMLOWNMLSS | 630 | 630 |
| 8, 10 | 5/16, 3/8 | 11/16-16 | 27.0 | 27 | 6.5 | 53 | 2 | 17 | 34 | 104 | 6WMLOWNMLS | 6WMLOWNMLSS | 630 | 630 |
| 12 | 1/2 | 13/16-16 | 30.0 | 30 | 9.5 | 59 | 3 | 21 | 37 | 141 | 8WMLOWNMLS | 8WMLOWNMLSS | 630 | 630 |
| 14, 15, 16 | 5/8 | 1-14 | 36.0 | 32 | 12.5 | 67 | 3 | 25 | 41 | 285 | 10WMLOWNMLS | 10WMLOWNMLSS | 420 | 420 |
| 18, 20 | 3/4 | 1 3/16-12 | 41.0 | 41 | 15.5 | 69 | 3 | 30 | 42 | 322 | 12WMLOWNMLS | 12WMLOWNMLSS | 420 | 420 |
| 22, 25 | 1 | 1 7/16-12 | 44.5 | 45 | 20.5 | 70 | 2 | 36 | 42 | 480 | 16 WLO-WLNL-S | 16WMLOWNMLSS | 420 | 420 |
| 28, 30, 32 | 1 1/4 | 1 11/16-12 | 50.4 | 51 | 26.0 | 70 | 2 | 43 | 42 | 510 | 20 WLO-WLNL-S | 20WMLOWNMLSS | 420 | 280 |
| 35, 38 | 1 1/2 | 2-12 | 60.3 | 60 | 32.0 | 70 | 2 | 51 | 42 | 674 | 24 WLO-WLNL-S | 24WMLOWNMLSS | 350 | 280 |

Product delivered with NBR TRAP seal. Replacement of TRAP seal is with a standard NBR O-ring – see page J73-J74.

Part numbers shown are part of our current manufacturing programme.

Imperial and metric parts may vary in hexagon dimensions.

For the version without the locknut remove "WLNL" (e.g. 16WMLO)

$$\frac{PN \text{ (bar)}}{10} = PN \text{ (MPa)}$$

Do not create drawings from these dimensions, they are subject to change and ISO manufacturing allowances.

Maximum bulkhead wallthickness

| Size | Tube O.D. | | Straight bulkhead union Max. thickness mm | Shape bulkhead union Max. thickness mm |
|------|-----------|--------|---|--|
| | inch | metric | | |
| 4 | 1/4 | 6 | 13.5 | 13.5 |
| 6 | 3/8 | 10 | 13.5 | 13.5 |
| 8 | 1/2 | 12 | 13.5 | 13.5 |
| 10 | 5/8 | 14-16 | 13.2 | 13.2 |
| 12 | 3/4 | 18-20 | 12.7 | 12.7 |
| 16 | 1 | 22-25 | 13.0 | 13.0 |
| 20 | 1 1/4 | 28-32 | 13.0 | 13.0 |
| 24 | 1 1/2 | 35-38 | 13.0 | 13.0 |

O-Lok®
WEMLO Bulkhead union elbow

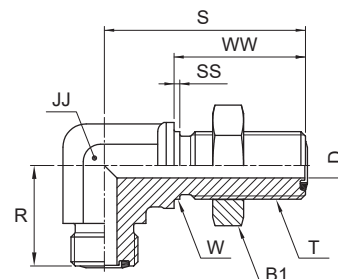
 O-Lok® ORFS tube end/O-Lok® ORFS tube end
 SAE520701/SAE 520701 ISO 8434-3 BHE

| Tube O.D. | | Thread UN/UNF-2A T | B1 mm | D mm | JJ* mm | R mm | S mm | SS mm | W mm | WW mm | Weight (steel) g/1 piece | O-Lok® | | PN (bar) | |
|------------|-----------|--------------------|-------|------|--------|------|------|-------|------|-------|--------------------------|-----------------------|------------------------|----------|-----|
| mm | in. | | | | | | | | | | | Steel | Stainless Steel | S | SS |
| 6 | 1/4 | 9/16-18 | 20.6 | 4.5 | 14 | 23 | 47 | 2 | 14 | 32 | 78 | 4 WELO-WLNL-S | 4 WELO-WLNL-SS | 630 | 630 |
| 8, 10 | 5/16, 3/8 | 11/16-16 | 27.0 | 6.5 | 19 | 26 | 52 | 2 | 17 | 34 | 146 | 6WEMLOWLNMLS | 6 WELO-WLNL-SS | 630 | 630 |
| 12 | 1/2 | 13/16-16 | 30.0 | 9.5 | 19 | 29 | 56 | 3 | 21 | 37 | 252 | 8WEMLOWLNMLS | 8 WELO-WLNL-SS | 630 | 630 |
| 14, 15, 16 | 5/8 | 1-14 | 36.0 | 12.5 | 27 | 35 | 63 | 3 | 25 | 41 | 287 | 10WEMLOWLNMLS | 10 WELO-WLNL-SS | 420 | 420 |
| 18, 20 | 3/4 | 1 3/16-12 | 38.0 | 15.5 | 30 | 39 | 67 | 2 | 30 | 42 | 445 | 12 WELO-WLNL-S | 12 WELO-WLNL-SS | 420 | 420 |
| 22, 25 | 1 | 1 7/16-12 | 44.5 | 20.5 | 36 | 42 | 71 | 2 | 37 | 42 | 639 | 16 WELO-WLNL-S | 16 WELO-WLNL-SS | 420 | 420 |
| 28, 30, 32 | 1 1/4 | 1 11/16-12 | 50.4 | 26.0 | 41 | 46 | 75 | 2 | 43 | 42 | 718 | 20 WELO-WLNL-S | 20 WELO-WLNL-SS | 350 | 280 |
| 35, 38 | 1 1/2 | 2-12 | 60.3 | 32.0 | 48 | 50 | 80 | 2 | 51 | 42 | 945 | 24 WELO-WLNL-S | 24 WELO-WLNL-SS | 280 | 280 |

Product delivered with NBR TRAP seal. Replacement of TRAP seal is with a standard NBR O-ring – see page J73-J74.

Part numbers shown are part of our current manufacturing programme.

Imperial and metric parts may vary in hexagon dimensions.

For the version without the locknut remove "WLNML" (e.g. 16WEMLO)

$$\frac{\text{PN (bar)}}{10} = \text{PN (MPa)}$$

Do not create drawings from these dimensions, they are subject to change and ISO manufacturing allowances.

*JJ may vary in stainless steel

Maximum bulkhead wallthickness

| Size | Tube O.D. | | Straight bulkhead union Max. thickness mm | Shape bulkhead union Max. thickness mm |
|------|-----------|--------|---|--|
| | inch | metric | | |
| 4 | 1/4 | 6 | 13.5 | 13.5 |
| 6 | 3/8 | 10 | 13.5 | 13.5 |
| 8 | 1/2 | 12 | 13.5 | 13.5 |
| 10 | 5/8 | 14-16 | 13.2 | 13.2 |
| 12 | 3/4 | 18-20 | 12.7 | 12.7 |
| 16 | 1 | 22-25 | 13.0 | 13.0 |
| 20 | 1 1/4 | 28-32 | 13.0 | 13.0 |
| 24 | 1 1/2 | 35-38 | 13.0 | 13.0 |

WNLO Bulkhead union 45° elbow

O-Lok® ORFS tube ends
SAE 520801 ISO 8434-3 BHE 45

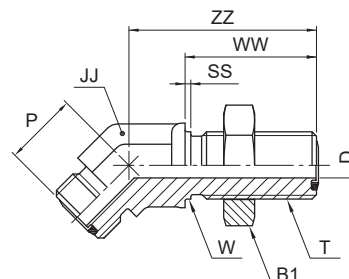

| Tube O.D. | | Thread | B1 | D | JJ* | P | SS | W | WW | ZZ | Weight (steel) | O-Lok® Steel | PN (bar) |
|------------|-----------|-------------|------|------|-----|----|----|----|----|----|----------------|-----------------------|----------|
| mm | in. | UN/UNF-2A T | mm | mm | mm | mm | mm | mm | mm | mm | g/1 piece | | |
| 6 | 1/4 | 9/16-18 | 20.6 | 4.5 | 14 | 16 | 2 | 14 | 32 | 44 | 65 | 4 WNLO-WLNL-S | 630 |
| 8, 10 | 5/16, 3/8 | 11/16-16 | 25.4 | 6.5 | 19 | 19 | 2 | 17 | 34 | 49 | 123 | 6 WNLO-WLNL-S | 630 |
| 12 | 1/2 | 13/16-16 | 28.6 | 9.5 | 19 | 21 | 2 | 21 | 37 | 51 | 163 | 8 WNLO-WLNL-S | 630 |
| 14, 15, 16 | 5/8 | 1-14 | 33.3 | 12.5 | 27 | 24 | 2 | 25 | 41 | 57 | 252 | 10 WNLO-WLNL-S | 420 |
| 18, 20 | 3/4 | 1 3/16-12 | 38.0 | 15.5 | 30 | 26 | 2 | 30 | 42 | 61 | 386 | 12 WNLO-WLNL-S | 420 |
| 22, 25 | 1 | 1 7/16-12 | 44.5 | 20.5 | 36 | 30 | 2 | 37 | 42 | 65 | 465 | 16 WNLO-WLNL-S | 420 |
| 28, 30, 32 | 1 1/4 | 1 11/16-12 | 50.4 | 26.0 | 41 | 32 | 2 | 43 | 42 | 67 | 578 | 20 WNLO-WLNL-S | 350 |
| 35, 38 | 1 1/2 | 2-12 | 60.3 | 32.0 | 48 | 37 | 2 | 51 | 42 | 67 | 770 | 24 WNLO-WLNL-S | 280 |

Product delivered with NBR TRAP seal. Replacement of TRAP seal is with a standard NBR O-ring – see page J73-J74.

Part numbers shown are part of our current manufacturing programme.

Imperial and metric parts may vary in hexagon dimensions.

For the version without the locknut remove "WLNL" (e.g. 16 WNLO)

$$\frac{\text{PN (bar)}}{10} = \text{PN (MPa)}$$

Do not create drawings from these dimensions, they are subject to change and ISO manufacturing allowances.

*JJ may vary in stainless steel

J

Maximum bulkhead wallthickness

| Size | Tube O.D. | | Straight bulkhead union Max. thickness mm | Shape bulkhead union Max. thickness mm |
|------|-----------|--------|---|--|
| | inch | metric | | |
| 4 | 1/4 | 6 | 13.5 | 13.5 |
| 6 | 3/8 | 10 | 13.5 | 13.5 |
| 8 | 1/2 | 12 | 13.5 | 13.5 |
| 10 | 5/8 | 14-16 | 13.2 | 13.2 |
| 12 | 3/4 | 18-20 | 12.7 | 12.7 |
| 16 | 1 | 22-25 | 13.0 | 13.0 |
| 20 | 1 1/4 | 28-32 | 13.0 | 13.0 |
| 24 | 1 1/2 | 35-38 | 13.0 | 13.0 |

O-Lok®

WJLO Bulkhead branch tee

O-Lok® ORFS tube ends

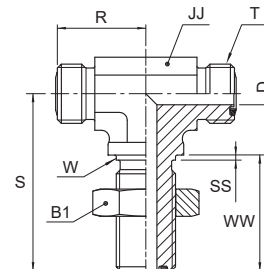

| Tube O.D. | | Thread | B1 | D | JJ* | R | S | SS | W | WW | Weight (steel) | O-Lok® | PN |
|------------|-----------|-------------|------|------|-----|----|----|----|----|----|----------------|-----------------------|-------|
| mm | in. | UN/UNF-2A T | mm | mm | mm | mm | mm | mm | mm | mm | g/1 piece | Steel | (bar) |
| 6 | 1/4 | 9/16-18 | 20.6 | 4.5 | 14 | 23 | 47 | 2 | 14 | 32 | 100 | 4 WJLO-WLNL-S | 630 |
| 8, 10 | 5/16, 3/8 | 11/16-16 | 25.4 | 6.5 | 19 | 26 | 52 | 2 | 18 | 34 | 178 | 6 WJLO-WLNL-S | 630 |
| 12 | 1/2 | 13/16-16 | 28.6 | 9.5 | 19 | 29 | 55 | 2 | 21 | 37 | 270 | 8 WJLO-WLNL-S | 630 |
| 14, 15, 16 | 5/8 | 1-14 | 33.3 | 12.5 | 27 | 35 | 63 | 2 | 25 | 41 | 370 | 10 WJLO-WLNL-S | 420 |
| 18, 20 | 3/4 | 1 3/16-12 | 38.0 | 15.5 | 30 | 39 | 67 | 2 | 30 | 42 | 520 | 12 WJLO-WLNL-S | 420 |
| 22, 25 | 1 | 1 7/16-12 | 44.5 | 20.5 | 36 | 42 | 71 | 2 | 37 | 42 | 680 | 16 WJLO-WLNL-S | 420 |

Product delivered with NBR TRAP seal. Replacement of TRAP seal is with a standard NBR O-ring – see page J73-J74.

Part numbers shown are part of our current manufacturing programme.

Imperial and metric parts may vary in hexagon dimensions.

For the version without the locknut remove "WLNL" (e.g. 16 WJLO)

$$\frac{\text{PN (bar)}}{10} = \text{PN (MPa)}$$

Do not create drawings from these dimensions, they are subject to change and ISO manufacturing allowances.

*JJ may vary in stainless steel

Maximum bulkhead wallthickness

| Size | Tube O.D. | | Straight bulkhead union Max. thickness mm | Shape bulkhead union Max. thickness mm |
|------|-----------|--------|---|--|
| | inch | metric | | |
| 4 | 1/4 | 6 | 13.5 | 13.5 |
| 6 | 3/8 | 10 | 13.5 | 13.5 |
| 8 | 1/2 | 12 | 13.5 | 13.5 |
| 10 | 5/8 | 14-16 | 13.2 | 13.2 |
| 12 | 3/4 | 18-20 | 12.7 | 12.7 |
| 16 | 1 | 22-25 | 13.0 | 13.0 |
| 20 | 1 1/4 | 28-32 | 13.0 | 13.0 |
| 24 | 1 1/2 | 35-38 | 13.0 | 13.0 |

WJJLO Bulkhead run tee

O-Lok® ORFS tube ends
SAE 520958 ISO 8434-3 BHRT

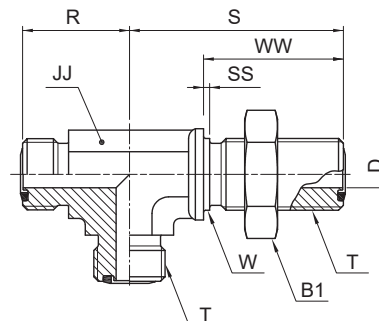

| Tube O.D. | | Thread | B1 | D | JJ* | R | S | SS | W | WW | Weight (steel) | O-Lok® Steel | PN (bar) |
|------------|-----------|-------------|------|------|-----|----|----|----|----|----|----------------|------------------------|----------|
| mm | in. | UN/UNF-2A T | mm | mm | mm | mm | mm | mm | mm | mm | g/1 piece | | |
| 6 | 1/4 | 9/16-18 | 20.6 | 4.5 | 14 | 23 | 46 | 2 | 14 | 32 | 99 | 4 WJJLO-WLNL-S | 630 |
| 8, 10 | 5/16, 3/8 | 11/16-16 | 25.4 | 6.5 | 19 | 26 | 52 | 2 | 17 | 34 | 178 | 6 WJJLO-WLNL-S | 630 |
| 12 | 1/2 | 13/16-16 | 28.6 | 9.5 | 19 | 29 | 55 | 2 | 21 | 37 | 270 | 8 WJJLO-WLNL-S | 630 |
| 14, 15, 16 | 5/8 | 1-14 | 33.3 | 12.5 | 27 | 35 | 63 | 2 | 25 | 41 | 368 | 10 WJJLO-WLNL-S | 420 |
| 18, 20 | 3/4 | 1 3/16-12 | 38.0 | 15.5 | 30 | 39 | 67 | 2 | 30 | 42 | 516 | 12 WJJLO-WLNL-S | 420 |
| 22, 25 | 1 | 1 7/16-12 | 44.5 | 20.5 | 36 | 42 | 71 | 2 | 37 | 42 | 678 | 16 WJJLO-WLNL-S | 420 |
| 28, 30, 32 | 1 1/4 | 1 11/16-12 | 50.4 | 26.0 | 41 | 46 | 71 | 2 | 43 | 42 | 980 | 20 WJJLO-WLNL-S | 350 |
| 35, 38 | 1 1/2 | 2-12 | 60.3 | 32.0 | 48 | 50 | 80 | 2 | 51 | 42 | 1900 | 24 WJJLO-WLNL-S | 280 |

Product delivered with NBR TRAP seal. Replacement of TRAP seal is with a standard NBR O-ring – see page J73-J74.

Part numbers shown are part of our current manufacturing programme.

Imperial and metric parts may vary in hexagon dimensions.

For the version without the locknut remove "WLNL" (e.g. 16 WJJLO)

$$\frac{\text{PN (bar)}}{10} = \text{PN (MPa)}$$

Do not create drawings from these dimensions, they are subject to change and ISO manufacturing allowances.

*JJ may vary in stainless steel

J

Maximum bulkhead wallthickness

| Size | Tube O.D. | | Straight bulkhead union Max. thickness mm | Shape bulkhead union Max. thickness mm |
|------|-----------|--------|---|--|
| | inch | metric | | |
| 4 | 1/4 | 6 | 13.5 | 13.5 |
| 6 | 3/8 | 10 | 13.5 | 13.5 |
| 8 | 1/2 | 12 | 13.5 | 13.5 |
| 10 | 5/8 | 14-16 | 13.2 | 13.2 |
| 12 | 3/4 | 18-20 | 12.7 | 12.7 |
| 16 | 1 | 22-25 | 13.0 | 13.0 |
| 20 | 1 1/4 | 28-32 | 13.0 | 13.0 |
| 24 | 1 1/2 | 35-38 | 13.0 | 13.0 |

O-Lok®
AOEL6 Swivel nut stud elbow

O-Lok® ORFS Female swivel end / Male UN/UNF thread – O-ring (ISO 11926)
SAE 520281

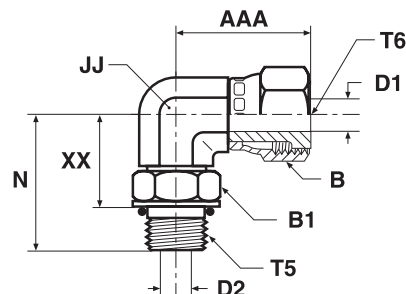

| Tube O.D. | | Thread UN/UNF-2A T5 | Thread UN/UNF-2B T6 | AAA | B | B1 | D1 | D2 | JJ* | N | XX | Weight (steel) | O-Lok® Steel | O-Lok® Stainless Steel | PN (bar) | |
|------------|-----------|---------------------|---------------------|-----|----|----|------|------|-----|----|----|----------------|-------------------|------------------------|----------|-----|
| mm | in. | | | mm | mm | mm | mm | mm | mm | mm | mm | g/1 piece | | | S | SS |
| 6 | 1/4 | 7/16-20 | 9/16-18 | 26 | 18 | 14 | 4.0 | 4.5 | 14 | 33 | 22 | 47 | 4 AOEL6-S | 4 AOEL6-SS | 420 | 420 |
| 8, 10 | 5/16, 3/8 | 9/16-18 | 11/16-16 | 30 | 21 | 19 | 6.5 | 7.5 | 19 | 37 | 25 | 97 | 6 AOEL6-S | 6 AOEL6-SS | 420 | 420 |
| 12 | 1/2 | 3/4-16 | 13/16-16 | 38 | 24 | 24 | 9.0 | 10.0 | 19 | 41 | 27 | 104 | 8 AOEL6-S | 8 AOEL6-SS | 420 | 420 |
| 14, 15, 16 | 5/8 | 7/8-14 | 1-14 | 42 | 29 | 27 | 11.5 | 12.5 | 27 | 50 | 34 | 199 | 10 AOEL6-S | 10 AOEL6-SS | 420 | 420 |
| 18, 20 | 3/4 | 1 1/16-12 | 1 3/16-12 | 46 | 35 | 35 | 14.0 | 15.5 | 27 | 55 | 37 | 162 | 12 AOEL6-S | 12 AOEL6-SS | 420 | 420 |
| 22, 25 | 1 | 1 5/16-12 | 1 7/16-12 | 53 | 41 | 41 | 20.0 | 21.5 | 33 | 60 | 42 | 365 | 16 AOEL6-S | 16 AOEL6-SS | 380 | 380 |
| 28, 30, 32 | 1 1/4 | 1 5/8-12 | 1 11/16-12 | 58 | 48 | 48 | 26.0 | 27.5 | 41 | 62 | 44 | 480 | 20 AOEL6-S | 20 AOEL6-SS | 280 | 280 |
| 35, 38 | 1 1/2 | 1 7/8-12 | 2-12 | 61 | 57 | 54 | 32.0 | 33.5 | 50 | 66 | 47 | 933 | 24 AOEL6-S | 24 AOEL6-SS | 280 | 280 |

O-Lok® is delivered with NBR elastomeric seals as standard. For more details on other seal materials see page J73-J74.

Part numbers shown are part of our current manufacturing programme.

Imperial and metric parts may vary in hexagon dimensions.

$$\frac{\text{PN (bar)}}{10} = \text{PN (MPa)}$$

Do not create drawings from these dimensions, they are subject to change and ISO manufacturing allowances.

*JJ may vary in stainless steel

C6MLO Swivel nut elbow

O-Lok® ORFS Female swivel end / O-Lok® ORFS tube end
SAE 52M0221 ISO 8434-3 SWE

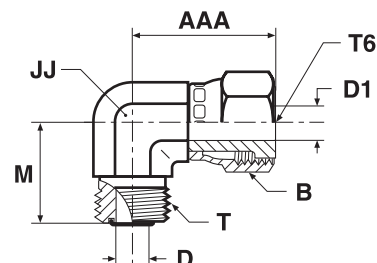

| Tube O.D. | | Thread UN/UNF-2A T | Thread UN/UNF-2B T6 | AAA mm | B mm | D mm | D1 mm | JJ* mm | M mm | Weight (steel) g/1 piece | O-Lok® Steel | O-Lok® Stainless Steel | PN (bar) | |
|------------|-----------|--------------------|---------------------|--------|------|------|-------|--------|------|--------------------------|------------------|------------------------|----------|-----|
| mm | in. | | | | | | | | | | | | S | SS |
| 6 | 1/4 | 9/16-18 | 9/16-18 | 26 | 17 | 4.5 | 4.0 | 14 | 22 | 45 | 4C6MLOS | 4C6MLOSS | 500 | 420 |
| 8, 10 | 5/16, 3/8 | 11/16-16 | 11/16-16 | 29 | 22 | 6.5 | 6.5 | 19 | 25 | 84 | 6C6MLOS | 6C6MLOSS | 630 | 420 |
| 12 | 1/2 | 13/16-16 | 13/16-16 | 38 | 24 | 9.5 | 9.0 | 19 | 28 | 126 | 8C6MLOS | 8C6MLOSS | 630 | 420 |
| 14, 15, 16 | 5/8 | 1-14 | 1-14 | 41 | 30 | 12.5 | 11.5 | 27 | 33 | 221 | 10C6MLOS | 10C6MLOSS | 420 | 420 |
| 18, 20 | 3/4 | 1 3/16-12 | 1 3/16-12 | 46 | 36 | 15.5 | 14.0 | 30 | 37 | 284 | 12C6MLOS | 12C6MLOSS | 420 | 420 |
| 22, 25 | 1 | 1 7/16-12 | 1 7/16-12 | 53 | 41 | 20.5 | 20.0 | 36 | 42 | 541 | 16C6MLOS | 16C6MLOSS | 420 | 420 |
| 28, 30, 32 | 1 1/4 | 1 11/16-12 | 1 11/16-12 | 58 | 48 | 26.0 | 26.0 | 41 | 45 | 557 | 20 C6LO-S | 20C6MLOSS | 350 | 280 |
| 35, 38 | 1 1/2 | 2-12 | 2-12 | 61 | 57 | 32.0 | 32.0 | 48 | 49 | 706 | 24 C6LO-S | 24C6MLOSS | 280 | 280 |

Product delivered with NBR TRAP seal. Replacement of TRAP seal is with a standard NBR O-ring – see page J73-J74.

Part numbers shown are part of our current manufacturing programme.

Imperial and metric parts may vary in hexagon dimensions.

$$\frac{\text{PN (bar)}}{10} = \text{PN (MPa)}$$

Do not create drawings from these dimensions, they are subject to change and ISO manufacturing allowances.

*JJ may vary in stainless steel

J

O-Lok®
V6LO 45° Swivel nut elbow

O-Lok® ORFS female swivel end / O-Lok® ORFS tube end

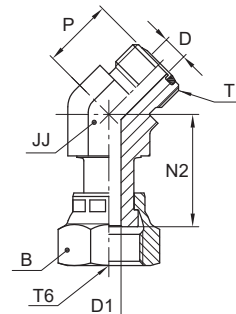

*JJ – Across wrench flats

| Tube O.D. | | Thread UN/UNF-2A T | Thread UN/UNF-2B T6 | B mm | D mm | D1 mm | JJ* mm | N2 mm | P mm | Weight (steel) g/1 piece | O-Lok® Steel | PN (bar) |
|------------|-----------|--------------------|---------------------|------|------|-------|--------|-------|------|--------------------------|------------------|----------|
| mm | in. | | | | | | | | | | | |
| 6 | 1/4 | 9/16-18 | 9/16-18 | 18 | 4.5 | 4.0 | 14 | 25 | 16 | 44 | 4 V6LO-S | 500 |
| 8, 10 | 5/16, 3/8 | 11/16-16 | 11/16-16 | 22 | 6.5 | 6.5 | 19 | 30 | 19 | 96 | 6V6MLOS | 630 |
| 12 | 1/2 | 13/16-16 | 13/16-16 | 24 | 9.5 | 9.0 | 19 | 38 | 20 | 110 | 8 V6LO-S | 630 |
| 14, 15, 16 | 5/8 | 1-14 | 1-14 | 30 | 12.5 | 11.5 | 27 | 42 | 23 | 235 | 10V6MLOS | 420 |
| 18, 20 | 3/4 | 1 3/16-12 | 1 3/16-12 | 36 | 15.5 | 14.0 | 30 | 46 | 26 | 349 | 12V6MLOS | 420 |
| 22, 25 | 1 | 1 7/16-12 | 1 7/16-12 | 41 | 20.5 | 20.0 | 36 | 48 | 30 | 300 | 16 V6LO-S | 420 |
| 28, 30, 32 | 1 1/4 | 1 11/16-12 | 1 11/16-12 | 48 | 26.0 | 26.0 | 41 | 50 | 32 | 444 | 20 V6LO-S | 350 |
| 35, 38 | 1 1/2 | 2-12 | 2-12 | 57 | 32.0 | 32.0 | 48 | 52 | 37 | 568 | 24 V6LO-S | 280 |

Product delivered with NBR TRAP seal. Replacement of TRAP seal is with a standard NBR O-ring – see page J73-J74.

Part numbers shown are part of our current manufacturing programme.

Imperial and metric parts may vary in hexagon dimensions.

$$\frac{\text{PN (bar)}}{10} = \text{PN (MPa)}$$

Do not create drawings from these dimensions, they are subject to change and ISO manufacturing allowances.

*JJ may vary in stainless steel

S6MLO Swivel nut branch tee

O-Lok® ORFS female swivel end / O-Lok® ORFS tube ends
SAE 52M0433 ISO 8434-3 SWBT

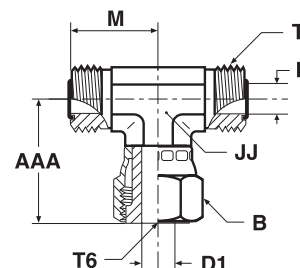

| Tube O.D. | | Thread UN/UNF-2A T | Thread UN/UNF-2B T6 | AAA mm | B mm | D mm | D1 mm | JJ* mm | M mm | Weight (steel) g/1 piece | O-Lok® Steel | O-Lok® Stainless Steel | PN (bar) | |
|------------|-----------|--------------------|---------------------|--------|------|------|-------|--------|------|--------------------------|------------------|------------------------|----------|-----|
| mm | in. | | | | | | | | | | | | S | SS |
| 6 | 1/4 | 9/16-18 | 9/16-18 | 26 | 17 | 4.5 | 4.0 | 14 | 22 | 66 | 4S6MLOS | 4S6MLOSS | 500 | 420 |
| 8, 10 | 5/16, 3/8 | 11/16-16 | 11/16-16 | 29 | 22 | 6.5 | 6.5 | 19 | 25 | 125 | 6S6MLOS | 6S6MLOSS | 630 | 420 |
| 12 | 1/2 | 13/16-16 | 13/16-16 | 38 | 24 | 9.5 | 9.0 | 19 | 28 | 150 | 8S6MLOS | 8S6MLOSS | 630 | 420 |
| 14, 15, 16 | 5/8 | 1-14 | 1-14 | 41 | 30 | 12.5 | 11.5 | 27 | 33 | 233 | 10S6MLOS | 10S6MLOSS | 420 | 420 |
| 18, 20 | 3/4 | 1 3/16-12 | 1 3/16-12 | 47 | 35 | 15.5 | 14.0 | 30 | 38 | 383 | 12 S6LO-S | 12S6MLOSS | 420 | 420 |
| 22, 25 | 1 | 1 7/16-12 | 1 7/16-12 | 54 | 41 | 20.5 | 20.0 | 36 | 42 | 518 | 16 S6LO-S | 16S6MLOSS | 420 | 420 |
| 28, 30, 32 | 1 1/4 | 1 11/16-12 | 1 11/16-12 | 58 | 48 | 26.0 | 26.0 | 41 | 45 | 775 | 20 S6LO-S | 20S6MLOSS | 350 | 280 |
| 35, 38 | 1 1/2 | 2-12 | 2-12 | 61 | 57 | 32.0 | 32.0 | 48 | 49 | 933 | 24 S6LO-S | 24S6MLOSS | 280 | 280 |

Product delivered with NBR TRAP seal. Replacement of TRAP seal is with a standard NBR O-ring – see page J73-J74.

Part numbers shown are part of our current manufacturing programme.

Imperial and metric parts may vary in hexagon dimensions.

$$\frac{\text{PN (bar)}}{10} = \text{PN (MPa)}$$

Do not create drawings from these dimensions, they are subject to change and ISO manufacturing allowances.

*JJ may vary in stainless steel

J

O-Lok®
R6MLO Swivel nut run tee

O-Lok® ORFS female swivel end / O-Lok® ORFS tube ends
 SAE 52M0432 ISO 8434-3 SWRT

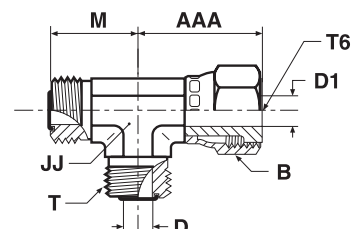

| Tube O.D. | | Thread UN/UNF-2A T | Thread UN/UNF-2B T6 | AAA mm | B mm | D mm | D1 mm | JJ* mm | M mm | Weight (steel) g/1 piece | O-Lok® Steel | O-Lok® Stainless Steel | PN (bar) | |
|------------|-----------|--------------------|---------------------|--------|------|------|-------|--------|------|--------------------------|------------------|------------------------|----------|-----|
| mm | in. | | | | | | | | | | | | S | SS |
| 6 | 1/4 | 9/16-18 | 9/16-18 | 26 | 17 | 4.5 | 4.0 | 14 | 22 | 66 | 4R6MLOS | 4R6MLOSS | 500 | 420 |
| 8, 10 | 5/16, 3/8 | 11/16-16 | 11/16-16 | 29 | 22 | 6.5 | 6.5 | 19 | 25 | 125 | 6R6MLOS | 6R6MLOSS | 630 | 420 |
| 12 | 1/2 | 13/16-16 | 13/16-16 | 38 | 24 | 9.5 | 9.0 | 19 | 28 | 150 | 8R6MLOS | 8R6MLOSS | 630 | 420 |
| 14, 15, 16 | 5/8 | 1-14 | 1-14 | 41 | 30 | 12.5 | 11.5 | 27 | 33 | 233 | 10R6MLOS | 10R6MLOSS | 420 | 420 |
| 18, 20 | 3/4 | 1 3/16-12 | 1 3/16-12 | 47 | 35 | 15.5 | 14.0 | 30 | 38 | 383 | 12 R6LO-S | 12R6MLOSS | 420 | 420 |
| 22, 25 | 1 | 1 7/16-12 | 1 7/16-12 | 54 | 41 | 20.5 | 20.0 | 36 | 42 | 518 | 16 R6LO-S | 16R6MLOSS | 420 | 420 |
| 28, 30, 32 | 1 1/4 | 1 11/16-12 | 1 11/16-12 | 58 | 48 | 26.0 | 26.0 | 41 | 45 | 775 | 20 R6LO-S | 20R6MLOSS | 350 | 280 |
| 35, 38 | 1 1/2 | 2-12 | 2-12 | 61 | 57 | 32.0 | 32.0 | 48 | 49 | 933 | 24 R6LO-S | 24R6MLOSS | 280 | 280 |

Product delivered with NBR TRAP seal. Replacement of TRAP seal is with a standard NBR O-ring – see page J73-J74.

Part numbers shown are part of our current manufacturing programme.

Imperial and metric parts may vary in hexagon dimensions.

$$\frac{\text{PN (bar)}}{10} = \text{PN (MPa)}$$

Do not create drawings from these dimensions, they are subject to change and ISO manufacturing allowances.

*JJ may vary in stainless steel

TRMLO Tube end reducer

O-Lok® ORFS tube end / O-Lok® ORFS swivel female end
SAE 520123 /A

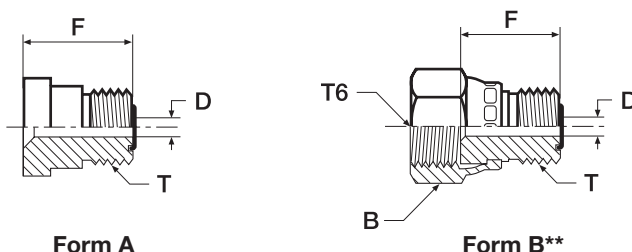

* For Form A, a BL- or BML-nut is required
(to be ordered separately)

| Tube O.D. | | Thread UN/UNF-2A T | Thread UN/UNF-2B T6 | B | D | F | Weight (steel) | Form | O-Lok® Steel | O-Lok® Stainless Steel | PN (bar) | |
|-----------|-------|--------------------|---------------------|----|------|----|----------------|------|---------------------|------------------------|----------|-----|
| mm | in. | | | mm | mm | mm | g/1 piece | | | | S | SS |
| 10 | 3/8 | 9/16-18 | 11/16-16 | 22 | 4.5 | 20 | 21 | B | 6-4TRMLONS | 6-4TRMLONSS | 630 | 420 |
| 12 | 1/2 | 9/16-18 | — | — | 4.5 | 22 | 30 | A | 8-4 TRLO-S | 8-4TRMLOSS | 630 | 420 |
| 12 | 1/2 | 11/16-16 | 13/16-16 | 24 | 6.5 | 22 | 33 | B | 8-6TRMLONS | 8-6TRMLONSS | 630 | 420 |
| 16 | 5/8 | 9/16-18 | — | — | 4.5 | 23 | 37 | A | 10-4 TRLO-S | 10-4TRMLOSS | 420 | 420 |
| 16 | 5/8 | 11/16-16 | — | — | 6.5 | 24 | 48 | A | 10-6 TRLO-S | 10-6TRMLOSS | 420 | 420 |
| 16 | 5/8 | 13/16-16 | — | — | 9.5 | 26 | 50 | A | 10-8 TRLO-S | 10-8TRMLOSS | 420 | 420 |
| 20 | 3/4 | 9/16-18 | — | — | 4.5 | 25 | 63 | A | 12-4 TRLO-S | 12-4TRMLOSS | 420 | 420 |
| 20 | 3/4 | 11/16-16 | — | — | 6.5 | 26 | 66 | A | 12-6 TRLO-S | 12-6TRMLOSS | 420 | 420 |
| 20 | 3/4 | 13/16-16 | — | — | 9.5 | 28 | 71 | A | 12-8 TRLO-S | 12-8TRMLOSS | 420 | 420 |
| 20 | 3/4 | 1-14 | 1 3/16-12 | 36 | 12.5 | 30 | 85 | B | 12-10TRMLONS | 12-10TRMLONSS | 420 | 420 |
| 25 | 1 | 13/16-16 | — | — | 9.5 | 29 | 103 | A | 16-8 TRLO-S | 16-8TRMLOSS | 420 | 420 |
| 25 | 1 | 1-14 | — | — | 12.5 | 32 | 118 | A | 16-10 TRLO-S | 16-10TRMLOSS | 420 | 420 |
| 25 | 1 | 1 3/16-12 | 1 7/16-12 | 41 | 15.5 | 33 | 133 | B | 16-12 TRLO-S | 16-12TRMLONSS | 420 | 420 |
| 32 | 1 1/4 | 1-14 | — | — | 12.5 | 32 | 163 | A | 20-10TRLOS | 20-10TRMOLSS | 420 | 420 |
| 32 | 1 1/4 | 1 3/16-12 | — | — | 15.5 | 34 | 169 | A | 20-12 TRLO-S | 20-12TRMLOSS | 420 | 280 |
| 32 | 1 1/4 | 1 7/16-12 | 1 11/16-12 | 48 | 20.5 | 38 | 183 | B | 20-16 TRLO-S | 20-16TRMLONSS | 350 | 280 |
| 38 | 1 1/2 | 1 7/16-12 | — | — | 20.5 | 34 | 205 | A | 24-16 TRLO-S | 24-16TRMLOSS | 350 | 280 |
| 38 | 1 1/2 | 1 11/16-12 | — | — | 26.0 | 34 | 209 | A | 24-20 TRLO-S | 24-20TRMLOSS | 350 | 280 |

Product delivered with NBR TRAP seal. Replacement of TRAP seal is with a standard NBR O-ring – see page J73-J74.

Part numbers shown are part of our current manufacturing programme.

Imperial and metric parts may vary in hexagon dimensions.

$$\frac{\text{PN (bar)}}{10} = \text{PN (MPa)}$$

Do not create drawings from these dimensions, they are subject to change and ISO manufacturing allowances.

**These size come assembled with a crimp style nut (Form B).

J

O-Lok®

LOHL6 Tube end expander

O-Lok® ORFS tube end / O-Lok® ORFS female swivel end

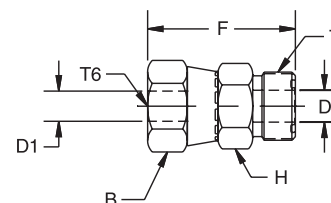

| Tube O.D. | | Thread UN/UNF-2A T | Thread UN/UNF-2B T6 | B | D | D1 | H | F | Weight (steel) g/1 piece | O-Lok® Steel | PN (bar) |
|------------|-----------|--------------------|---------------------|----|------|------|----|----|--------------------------|----------------------|----------|
| mm | in. | | | mm | mm | mm | mm | mm | | | |
| 8, 10 | 5/16, 3/8 | 11/16-16 | 9/16-18 | 18 | 4.0 | 4.0 | 19 | 35 | 33 | 6-4 LOHL6-S | 630 |
| 12 | 1/2 | 13/16-16 | 11/16-16 | 21 | 9.5 | 6.5 | 22 | 41 | 52 | 8-6 LOHL6-S | 630 |
| 14, 15, 16 | 5/8 | 1-14 | 13/16-16 | 24 | 12.5 | 9.0 | 27 | 46 | 92 | 10-8 LOHL6-S | 420 |
| 18, 20 | 3/4 | 1 3/16-12 | 1-14 | 29 | 15.5 | 11.5 | 32 | 51 | 146 | 12-10 LOHL6-S | 420 |
| 22, 25 | 1 | 1 7/16-12 | 1 3/16-12 | 35 | 20.5 | 14.0 | 38 | 55 | 205 | 16-12 LOHL6-S | 420 |
| 28, 30, 32 | 1 1/4 | 1 11/16-12 | 1 7/16-12 | 42 | 26.0 | 20.0 | 45 | 58 | 260 | 20-16 LOHL6-S | 350 |
| 35, 38 | 1 1/2 | 2-12 | 1 11/16-12 | 48 | 32.0 | 26.0 | 54 | 60 | 315 | 24-20 LOHL6-S | 280 |

Product delivered with NBR TRAP seal. Replacement of TRAP seal is with a standard NBR O-ring – see page J73-J74.

Part numbers shown are part of our current manufacturing programme.

Imperial and metric parts may vary in hexagon dimensions.

$$\frac{\text{PN (bar)}}{10} = \text{PN (MPa)}$$

Do not create drawings from these dimensions, they are subject to change and ISO manufacturing allowances.

HL6 Swivel nut union

O-Lok® ORFS female swivel ends

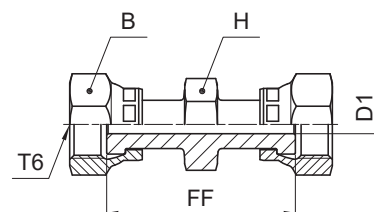

| Tube O.D. | | Thread UN/UNF-2B T6 | B mm | D1 mm | FF mm | H mm | Weight (steel) g/1 piece | O-Lok® Steel | PN (bar) |
|------------|-----------|---------------------|------|-------|-------|------|--------------------------|-----------------|----------|
| mm | in. | | | | | | | | |
| 6 | 1/4 | 9/16-18 | 18 | 4.0 | 40 | 16 | 53 | 4 HL6-S | 500 |
| 8, 10 | 5/16, 3/8 | 11/16-16 | 21 | 6.5 | 45 | 19 | 66 | 6 HL6-S | 630 |
| 12 | 1/2 | 13/16-16 | 24 | 9.0 | 54 | 22 | 110 | 8 HL6-S | 630 |
| 14, 15, 16 | 5/8 | 1-14 | 29 | 11.5 | 62 | 27 | 173 | 10 HL6-S | 420 |
| 18, 20 | 3/4 | 1 3/16-12 | 35 | 14.0 | 70 | 32 | 275 | 12 HL6-S | 420 |
| 22, 25 | 1 | 1 7/16-12 | 41 | 20.0 | 75 | 37 | 499 | 16 HL6-S | 420 |

Part numbers shown are part of our current manufacturing programme.

Imperial and metric parts may vary in hexagon dimensions.

$\frac{\text{PN (bar)}}{10} = \text{PN (MPa)}$

Do not create drawings from these dimensions, they are subject to change and ISO manufacturing allowances.

J

O-Lok®

F87OMLO Male stud connector

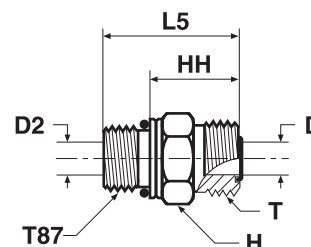
 O-Lok® ORFS tube end / Male metric thread – O-ring (ISO 6149-2)
 SAE 52M0187 ISO 8434-3 SDS

| Tube O.D. | | Thread metric T87 | Thread UN/UNF-2A T | D mm | D2 mm | H mm | HH mm | L5 mm | Weight (steel) g/1 piece | O-Lok® Steel | O-Lok® Stainless Steel | PN (bar) | |
|------------|-----------|-------------------|--------------------|------|-------|------|-------|-------|--------------------------|---------------|------------------------|----------|-----|
| mm | in. | | | | | | | | | | | S | SS |
| 6 | 1/4 | M 10×1.0 | 9/16-18 | 4.5 | 3.0 | 17 | 18 | 27 | 20 | 4M10F87OMLOS | 4M10F87OMLOSS | 630 | 630 |
| 6 | 1/4 | M 12×1.5 | 9/16-18 | 4.5 | 4.0 | 17 | 18 | 29 | 24 | 4M12F87OMLOS | 4M12F87OMLOSS | 630 | 630 |
| 6 | 1/4 | M 14×1.5 | 9/16-18 | 4.5 | 4.5 | 19 | 19 | 30 | 30 | 4M14F87OMLOS | 4M14F87OMLOSS | 630 | 630 |
| 6 | 1/4 | M 16×1.5 | 9/16-18 | 4.5 | 7.0 | 22 | 20 | 33 | 35 | 4M16F87OMLOS | 4M16F87OMLOSS | 630 | 630 |
| 8, 10 | 5/16, 3/8 | M 12×1.5 | 11/16-16 | 6.5 | 4.0 | 19 | 21 | 32 | 40 | 6M12F87OMLOS | 6M12F87OMLOSS | 630 | 630 |
| 8, 10 | 5/16, 3/8 | M 14×1.5 | 11/16-16 | 6.5 | 6.0 | 19 | 21 | 32 | 43 | 6M14F87OMLOS | 6M14F87OMLOSS | 630 | 630 |
| 8, 10 | 5/16, 3/8 | M 16×1.5 | 11/16-16 | 6.5 | 6.5 | 22 | 21 | 34 | 43 | 6M16F87OMLOS | 6M16F87OMLOSS | 630 | 630 |
| 8, 10 | 5/16, 3/8 | M 18×1.5 | 11/16-16 | 6.5 | 9.0 | 24 | 22 | 36 | 45 | 6M18F87OMLOS | 6M18F87OMLOSS | 630 | 630 |
| 8, 10 | 5/16, 3/8 | M 22×1.5 | 11/16-16 | 6.5 | 6.5 | 27 | 23 | 38 | 52 | 6M22F87OMLOS | 6M22F87OMLOSS | 420 | 420 |
| 12 | 1/2 | M 14×1.5 | 13/16-16 | 9.5 | 6.0 | 22 | 24 | 35 | 40 | 8M14F87OMLOS | 8M14F87OMLOSS | 630 | 630 |
| 12 | 1/2 | M 16×1.5 | 13/16-16 | 9.5 | 7.0 | 22 | 24 | 37 | 58 | 8M16F87OMLOS | 8M16F87OMLOSS | 630 | 630 |
| 12 | 1/2 | M 18×1.5 | 13/16-16 | 9.5 | 9.0 | 24 | 24 | 38 | 55 | 8M18F87OMLOS | 8M18F87OMLOSS | 630 | 630 |
| 12 | 1/2 | M 22×1.5 | 13/16-16 | 9.5 | 9.5 | 27 | 24 | 39 | 60 | 8M22F87OMLOS | 8M22F87OMLOSS | 420 | 420 |
| 12 | 1/2 | M 27×2.0 | 13/16-16 | 9.5 | 9.5 | 32 | 26 | 44 | 70 | 8M27F87OMLOS | 8M27F87OMLOSS | 420 | 420 |
| 14, 15, 16 | 5/8 | M 18×1.5 | 1-14 | 12.5 | 9.0 | 27 | 27 | 41 | 120 | 10M18F87OMLOS | 10M18F87OMLOSS | 420 | 420 |
| 14, 15, 16 | 5/8 | M 22×1.5 | 1-14 | 12.5 | 12.0 | 27 | 27 | 42 | 127 | 10M22F87OMLOS | 10M22F87OMLOSS | 420 | 420 |
| 14, 15, 16 | 5/8 | M 27×2.0 | 1-14 | 12.5 | 13.0 | 32 | 29 | 47 | 177 | 10M27F87OMLOS | 10M27F87OMLOSS | 420 | 420 |
| 18, 20 | 3/4 | M 22×1.5 | 1 3/16-12 | 15.5 | 12.0 | 32 | 30 | 45 | 170 | 12M22F87OMLOS | 12M22F87OMLOSS | 420 | 420 |
| 18, 20 | 3/4 | M 27×2.0 | 1 3/16-12 | 15.5 | 15.0 | 32 | 30 | 49 | 187 | 12M27F87OMLOS | 12M27F87OMLOSS | 420 | 420 |
| 18, 20 | 3/4 | M 33×2.0 | 1 3/16-12 | 15.5 | 20.0 | 41 | 33 | 52 | 200 | 12M33F87OMLOS | 12M33F87OMLOSS | 420 | 420 |
| 22, 25 | 1 | M 27×2.0 | 1 7/16-12 | 20.5 | 15.0 | 41 | 34 | 52 | 230 | 16M27F87OMLOS | 16M27F87OMLOSS | 420 | 420 |
| 22, 25 | 1 | M 33×2.0 | 1 7/16-12 | 20.5 | 20.0 | 41 | 34 | 52 | 270 | 16M33F87OMLOS | 16M33F87OMLOSS | 420 | 280 |
| 28, 30, 32 | 1 1/4 | M 33×2.0 | 1 11/16-12 | 26.0 | 20.0 | 46 | 36 | 54 | 370 | 20M33F87OMLOS | 20M33F87OMLOSS | 420 | 280 |
| 28, 30, 32 | 1 1/4 | M 42×2.0 | 1 11/16-12 | 26.0 | 26.0 | 50 | 36 | 55 | 390 | 20M42F87OMLOS | 20M42F87OMLOSS | 420 | 280 |
| 35, 38 | 1 1/2 | M 42×2.0 | 2-12 | 32.0 | 26.0 | 55 | 36 | 55 | 400 | 24M42F87OMLOS | 24M42F87OMLOSS | 350 | 280 |
| 35, 38 | 1 1/2 | M 48×2.0 | 2-12 | 32.0 | 32.0 | 55 | 36 | 57 | 412 | 24M48F87OMLOS | 24M48F87OMLOSS | 350 | 280 |

Product delivered with NBR TRAP seal. Replacement of TRAP seal is with a standard NBR O-ring – see page J73-J74.

Part numbers shown are part of our current manufacturing programme.

Imperial and metric parts may vary in hexagon dimensions.

$$\frac{\text{PN (bar)}}{10} = \text{PN (MPa)}$$

Do not create drawings from these dimensions, they are subject to change and ISO manufacturing allowances.

F5OMLO Male stud connector

O-Lok® ORFS tube end / Male UN/UNF thread – O-ring (ISO 11926)
SAE 520120

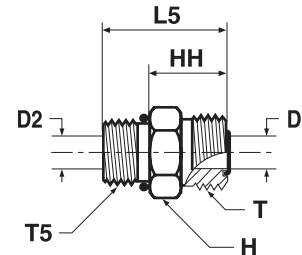

| Tube O.D. | | Thread UN/UNF-2A T5 | Thread UN/UNF-2A T | D | D2 | H | HH | L5 | Weight (steel) | O-Lok® Steel | O-Lok® Stainless Steel | PN (bar) | |
|------------|-----------|---------------------|--------------------|------|------|----|----|----|----------------|----------------------|------------------------|----------|-----|
| mm | in. | | | mm | mm | mm | mm | mm | g/1 piece | | | S | SS |
| 6 | 1/4 | 7/16-20 | 9/16-18 | 4.5 | 4.5 | 17 | 18 | 29 | 21 | 4F5OMLOS | 4F5OMLOSS | 630 | 630 |
| 6 | 1/4 | 1/2-20 | 9/16-18 | 4.5 | 4.5 | 16 | 19 | 30 | 30 | 4-5 F5OLO-S | 4-5F5OMLOSS | 630 | 630 |
| 6 | 1/4 | 9/16-18 | 9/16-18 | 4.5 | 7.5 | 19 | 19 | 31 | 36 | 4-6F5OMLOS | 4-6F5OMLOSS | 630 | 630 |
| 6 | 1/4 | 3/4-16 | 9/16-18 | 4.5 | 10.0 | 22 | 20 | 34 | 67 | 4-8 F5OLO-S | 4-8F5OMLOSS | 630 | 630 |
| 8, 10 | 5/16, 3/8 | 9/16-18 | 11/16-16 | 6.5 | 6.5 | 19 | 20 | 32 | 45 | 6F5OMLOS | 6F5OMLOSS | 630 | 630 |
| 8, 10 | 5/16, 3/8 | 7/16-20 | 11/16-16 | 6.5 | 4.5 | 19 | 23 | 34 | 47 | 6-4F5OMLOS | 6-4F5OMLOSS | 630 | 630 |
| 8, 10 | 5/16, 3/8 | 1/2-20 | 11/16-16 | 6.5 | 6.0 | 19 | 20 | 31 | 50 | 6-5 F5OLO-S | 6-5F5OMLOSS | 630 | 630 |
| 8, 10 | 5/16, 3/8 | 3/4-16 | 11/16-16 | 6.5 | 10.0 | 22 | 21 | 35 | 51 | 6-8F5OMLOS | 6-8F5OMLOSS | 630 | 630 |
| 8, 10 | 5/16, 3/8 | 7/8-14 | 11/16-16 | 6.5 | 6.5 | 27 | 23 | 39 | 89 | 6-10F5OMLOS | 6-10F5OMLOSS | 420 | 420 |
| 12 | 1/2 | 3/4-16 | 13/16-16 | 9.5 | 9.5 | 22 | 23 | 37 | 56 | 8F5OMLOS | 8F5OMLOSS | 630 | 630 |
| 12 | 1/2 | 7/16-20 | 13/16-16 | 9.5 | 4.5 | 22 | 25 | 36 | 63 | 8-4 F5OLO-S | 8-4F5OMLOSS | 630 | 630 |
| 12 | 1/2 | 9/16-18 | 13/16-16 | 9.5 | 7.5 | 22 | 26 | 38 | 69 | 8-6F5OMLOS | 8-6F5OMLOSS | 630 | 630 |
| 12 | 1/2 | 7/8-14 | 13/16-16 | 9.5 | 9.5 | 27 | 24 | 40 | 105 | 8-10F5OMLOS | 8-10F5OMLOSS | 420 | 420 |
| 12 | 1/2 | 1 1/16-12 | 13/16-16 | 9.5 | 9.5 | 32 | 26 | 44 | 169 | 8-12F5OMLOS | 8-12F5OMLOSS | 420 | 420 |
| 12 | 1/2 | 1 5/16-12 | 13/16-16 | 9.5 | 21.5 | 41 | 27 | 46 | 227 | 8-16F5OMLOS | 8-16F5OMLOSS | 420 | 420 |
| 14, 15, 16 | 5/8 | 7/8-14 | 1-14 | 12.5 | 12.5 | 27 | 27 | 43 | 137 | 10F5OMLOS | 10F5OMLOSS | 420 | 420 |
| 14, 15, 16 | 5/8 | 9/16-18 | 1-14 | 12.5 | 7.5 | 27 | 30 | 42 | 110 | 10-6 F5OLO-S | 10-6F5OMLOSS | 420 | 420 |
| 14, 15, 16 | 5/8 | 3/4-16 | 1-14 | 12.5 | 10.0 | 27 | 31 | 45 | 120 | 10-8F5OMLOS | 10-8F5OMLOSS | 420 | 420 |
| 14, 15, 16 | 5/8 | 1 1/16-12 | 1-14 | 12.5 | 12.5 | 32 | 29 | 47 | 170 | 10-12F5OMLOS | 10-12F5OMLOSS | 420 | 420 |
| 18, 20 | 3/4 | 1 1/16-12 | 1 3/16-12 | 15.5 | 15.5 | 32 | 30 | 49 | 189 | 12F5OMLOS | 12F5OMLOSS | 420 | 420 |
| 18, 20 | 3/4 | 3/4-16 | 1 3/16-12 | 15.5 | 10.0 | 32 | 35 | 49 | 167 | 12-8 F5OLO-S | 12-8F5OMLOSS | 420 | 420 |
| 18, 20 | 3/4 | 7/8-14 | 1 3/16-12 | 15.5 | 12.5 | 32 | 35 | 51 | 177 | 12-10F5OMLOS | 12-10F5OMLOSS | 420 | 420 |
| 18, 20 | 3/4 | 1 5/16-12 | 1 3/16-12 | 15.5 | 15.5 | 41 | 31 | 50 | 280 | 12-16F5OMLOS | 12-16F5OMLOSS | 420 | 420 |
| 18, 20 | 3/4 | 1 5/8-12 | 1 3/16-12 | 15.5 | 27.5 | 46 | 32 | 51 | 350 | 12-20F5OMLOS | 12-20F5OMLOSS | 420 | 420 |
| 22, 25 | 1 | 1 5/16-12 | 1 7/16-12 | 20.5 | 20.5 | 38 | 32 | 50 | 271 | 16 F5OLO-S | 16F5OMLOSS | 420 | 420 |
| 22, 25 | 1 | 1 1/16-12 | 1 7/16-12 | 20.5 | 15.5 | 38 | 36 | 54 | 275 | 16-12 F5OLO-S | 16-12F5OMLOSS | 420 | 420 |
| 22, 25 | 1 | 1 3/16-12 | 1 7/16-12 | 20.5 | 17.0 | 38 | 32 | 51 | 279 | 16-14F5OMLOS | 16-14F5OMLOSS | 420 | 420 |
| 22, 25 | 1 | 1 5/8-12 | 1 7/16-12 | 20.5 | 27.5 | 48 | 34 | 52 | 428 | 16-20 F5OLO-S | 16-20F5OMLOSS | 420 | 280 |
| 28, 30, 32 | 1 1/4 | 1 5/8-12 | 1 11/16-12 | 26.0 | 26.0 | 50 | 34 | 52 | 391 | 20F5OMLOS | 20F5OMLOSS | 420 | 280 |
| 28, 30, 32 | 1 1/4 | 1 5/16-12 | 1 11/16-12 | 26.0 | 21.5 | 48 | 39 | 58 | 401 | | 20-16F5OMLOSS | | 280 |
| 28, 30, 32 | 1 1/4 | 1 5/16-12 | 1 11/16-12 | 26.0 | 21.5 | 46 | 39 | 58 | 430 | 20-16 F5OLO-S | | 420 | |
| 28, 30, 32 | 1 1/4 | 1 7/8-12 | 1 11/16-12 | 26.0 | 32.0 | 54 | 36 | 54 | 557 | 20-24 F5OLO-S | 20-24F5OMLOSS | 350 | 280 |
| 35, 38 | 1 1/2 | 1 7/8-12 | 2-12 | 32.0 | 32.0 | 54 | 36 | 54 | 412 | 24 F5OLO-S | 24F5OMLOSS | 350 | 280 |
| 35, 38 | 1 1/2 | 1 5/8-12 | 2-12 | 32.0 | 27.5 | 54 | 41 | 60 | 581 | 24-20 F5OLO-S | 24-20F5OMLOSS | 350 | 280 |

J

Product delivered with NBR TRAP seal. Replacement of TRAP seal is with a standard NBR O-ring – see page J73-J74.

Part numbers shown are part of our current manufacturing programme.

Imperial and metric parts may vary in hexagon dimensions.

PN (bar)
10 = PN (MPa)

Do not create drawings from these dimensions, they are subject to change and ISO manufacturing allowances.

O-Lok®
FF50MLO Extended male stud connector

O-Lok® ORFS tube end / Male UN/UNF thread – O-ring (ISO 11926)
SAE 521720 (Previously 520122)

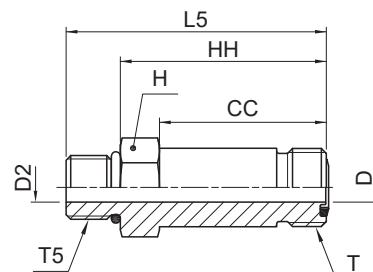

| Tube O.D. | | Thread UN/UNF-2A T5 | Thread UN/UNF-2A T | CC mm | D mm | D2 mm | H mm | HH mm | L5 mm | Weight (steel) g/1 piece | O-Lok® | | PN (bar) | |
|------------|-----------|---------------------|--------------------|-------|------|-------|------|-------|-------|--------------------------|-------------|-----------------|----------|-----|
| mm | in. | | | | | | | | | | Steel | Stainless Steel | S | SS |
| 6 | 1/4 | 7/16-20 | 9/16-18 | 34 | 4.5 | 4.5 | 16 | 42 | 53 | 51 | 4 FF5OLO-S | 4FF50MLOSS | 630 | 630 |
| 8, 10 | 5/16, 3/8 | 9/16-18 | 11/16-16 | 37 | 6.5 | 6.5 | 19 | 46 | 58 | 79 | 6 FF5OLO-S | 6FF50MLOSS | 630 | 630 |
| 12 | 1/2 | 3/4-16 | 13/16-16 | 45 | 9.5 | 9.5 | 22 | 54 | 68 | 125 | 8 FF5OLO-S | 8FF50MLOSS | 630 | 630 |
| 14, 15, 16 | 5/8 | 7/8-14 | 1-14 | 53 | 12.5 | 12.5 | 27 | 64 | 80 | 212 | 10 FF5OLO-S | 10FF50MLOSS | 420 | 420 |
| 18, 20 | 3/4 | 1 1/16-12 | 1 3/16-12 | 64 | 15.5 | 15.5 | 32 | 77 | 96 | 309 | 12 FF5OLO-S | 12FF50MLOSS | 420 | 420 |
| 22, 25 | 1 | 1 5/16-12 | 1 7/16-12 | 73 | 20.5 | 20.5 | 38 | 87 | 105 | 435 | 16 FF5OLO-S | 16FF50MLOSS | 420 | 420 |
| 28, 30, 32 | 1 1/4 | 1 5/8-12 | 1 11/16-12 | 86 | 26.0 | 26.0 | 48 | 102 | 121 | 818 | 20 FF5OLO-S | 20FF50MLOSS | 420 | 280 |
| 35, 38 | 1 1/2 | 1 7/8-12 | 2-12 | 97 | 32.0 | 32.0 | 54 | 115 | 134 | 1430 | 24 FF5OLO-S | 24FF50MLOSS | 350 | 280 |

Product delivered with NBR TRAP seal. Replacement of TRAP seal is with a standard NBR O-ring – see page J73-J74.

Part numbers shown are part of our current manufacturing programme.

Imperial and metric parts may vary in hexagon dimensions.

$$\frac{\text{PN (bar)}}{10} = \text{PN (MPa)}$$

Do not create drawings from these dimensions, they are subject to change and ISO manufacturing allowances.

WF5OLO Bulkhead male connector

O-Lok® ORFS tube end / Male UN/UNF – O-ring (ISO 11926)

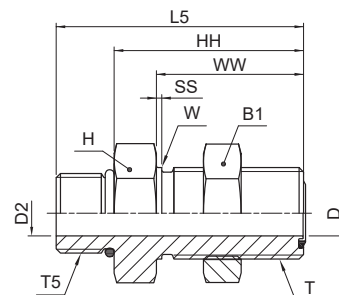

| Tube O.D. | | Thread UN/UNF-2A T | Thread UN/UNF-2A T5 | B1 mm | D mm | D2 mm | H mm | HH mm | L5 mm | SS mm | W mm | WW mm | Weight (steel) g/1 piece | O-Lok® Steel | PN (bar) |
|------------|-----------|--------------------|---------------------|-------|------|-------|------|-------|-------|-------|------|-------|--------------------------|-------------------------|----------|
| 6 | 1/4 | 9/16-18 | 7/16-20 | 21 | 4.5 | 4.5 | 21 | 43 | 54 | 2 | 14 | 32 | 75 | 4 WF5OLO-WLNL-S | 630 |
| 8, 10 | 5/16, 3/8 | 11/16-16 | 9/16-18 | 25 | 6.5 | 6.5 | 25 | 47 | 59 | 2 | 18 | 34 | 112 | 6 WF5OLO-WLNL-S | 630 |
| 12 | 1/2 | 13/16-16 | 3/4-16 | 29 | 9.5 | 9.5 | 29 | 52 | 66 | 2 | 21 | 37 | 147 | 8 WF5OLO-WLNL-S | 630 |
| 14, 15, 16 | 5/8 | 1-14 | 7/8-14 | 33 | 12.5 | 12.5 | 33 | 52 | 68 | 2 | 25 | 41 | 295 | 10 WF5OLO-WLNL-S | 420 |
| 18, 20 | 3/4 | 1 3/16-12 | 1 1/16-12 | 38 | 15.5 | 15.5 | 38 | 55 | 73 | 2 | 30 | 42 | 330 | 12 WF5OLO-WLNL-S | 420 |

Product delivered with NBR TRAP seal. Replacement of TRAP seal is with a standard NBR O-ring – see page J73-J74.

Part numbers shown are part of our current manufacturing programme.

Imperial and metric parts may vary in hexagon dimensions.

For the version without the locknut remove "WLNL" (e.g. 12 WF5OLO)

$$\frac{\text{PN (bar)}}{10} = \text{PN (MPa)}$$

Do not create drawings from these dimensions, they are subject to change and ISO manufacturing allowances.

J

O-Lok®

F42EDMLO Male stud connector

O-Lok® ORFS tube end / Male BSPP thread – ED seal (ISO 1179)

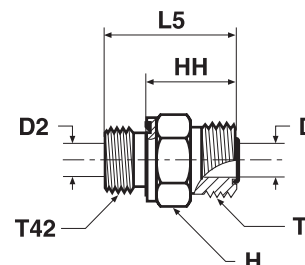

| Tube O.D. | | BSPP male thread T42 | Thread UN/UNF-2A T | D mm | D2 mm | H mm | HH mm | L5 mm | Weight (steel) g/1 piece | O-Lok® | | PN (bar) | |
|------------|-----------|----------------------|--------------------|------|-------|------|-------|-------|--------------------------|-----------------------|------------------------|----------|-----|
| mm | in. | | | | | | | | | Steel | Stainless Steel | S | SS |
| 6 | 1/4 | 1/8-28 | 9/16-18 | 4.5 | 4.0 | 17 | 18 | 26 | 29 | 4F42EDMLOS | 4F42EDMLOSS | 630 | 630 |
| 6 | 1/4 | 1/4-19 | 9/16-18 | 4.5 | 4.5 | 19 | 19 | 31 | 42 | 4-4F42EDMLOS | 4-4F42EDMLOSS | 630 | 630 |
| 6 | 1/4 | 3/8-19 | 9/16-18 | 4.5 | 4.5 | 22 | 20 | 32 | 61 | 4-6F42EDMLOS | 4-6F42EDMLOSS | 630 | 630 |
| 6 | 1/4 | 1/2-14 | 9/16-18 | 4.5 | 4.5 | 27 | 22 | 36 | 119 | 4-8F42EDMLOS | 4-8F42EDMLOSS | 420 | 420 |
| 8, 10 | 5/16, 3/8 | 1/4-19 | 11/16-16 | 6.5 | 5.0 | 19 | 20 | 32 | 45 | 6F42EDMLOS | 6F42EDMLOSS | 630 | 630 |
| 8, 10 | 5/16, 3/8 | 1/8-28 | 11/16-16 | 6.5 | 4.0 | 19 | 23 | 31 | 44 | 6-2F42EDMLOS | 6-2F42EDMLOSS | 630 | 630 |
| 8, 10 | 5/16, 3/8 | 3/8-19 | 11/16-16 | 6.5 | 6.5 | 22 | 21 | 33 | 63 | 6-6F42EDMLOS | 6-6F42EDMLOSS | 630 | 630 |
| 8, 10 | 5/16, 3/8 | 1/2-14 | 11/16-16 | 6.5 | 6.5 | 27 | 23 | 37 | 122 | 6-8F42EDMLOS | 6-8F42EDMLOSS | 420 | 420 |
| 8, 10 | 5/16, 3/8 | 3/4-14 | 11/16-16 | 6.5 | 16.0 | 32 | 24 | 40 | 192 | 6-12F42EDMLOS | 6-12F42EDMLOSS | 420 | 420 |
| 12 | 1/2 | 3/8-19 | 13/16-16 | 9.5 | 8.0 | 22 | 23 | 35 | 196 | 8F42EDMLOS | 8F42EDMLOSS | 630 | 630 |
| 12 | 1/2 | 1/4-19 | 13/16-16 | 9.5 | 5.0 | 22 | 26 | 38 | 193 | 8-4F42EDMLOS | 8-4F42EDMLOSS | 630 | 630 |
| 12 | 1/2 | 1/2-14 | 13/16-16 | 9.5 | 9.5 | 27 | 25 | 39 | 198 | 8-8F42EDMLOS | 8-8F42EDMLOSS | 420 | 420 |
| 12 | 1/2 | 3/4-14 | 13/16-16 | 9.5 | 9.5 | 32 | 26 | 42 | 205 | 8-12F42EDMLOS | 8-12F42EDMLOSS | 420 | 420 |
| 14, 15, 16 | 5/8 | 1/2-14 | 1-14 | 12.5 | 12.5 | 27 | 27 | 41 | 332 | 10F42EDMLOS | 10F42EDMLOSS | 420 | 420 |
| 14, 15, 16 | 5/8 | 3/8-19 | 1-14 | 12.5 | 8.0 | 27 | 31 | 43 | 315 | 10-6F42EDMLOS | 10-6F42EDMLOSS | 420 | 420 |
| 14, 15, 16 | 5/8 | 3/4-14 | 1-14 | 12.5 | 12.5 | 32 | 29 | 45 | 348 | 10-12F42EDMLOS | 10-12F42EDMLOSS | 420 | 420 |
| 14, 15, 16 | 5/8 | 1-11 | 1-14 | 12.5 | 12.5 | 41 | 30 | 48 | 360 | 10-16F42EDMLOS | 10-16F42EDMLOSS | 420 | 420 |
| 18, 20 | 3/4 | 3/4-14 | 1 3/16-12 | 15.5 | 15.5 | 32 | 30 | 46 | 200 | 12F42EDMLOS | 12F42EDMLOSS | 420 | 420 |
| 18, 20 | 3/4 | 1/2-14 | 1 3/16-12 | 15.5 | 12.0 | 32 | 35 | 49 | 183 | 12-8F42EDMLOS | 12-8F42EDMLOSS | 420 | 420 |
| 18, 20 | 3/4 | 1-11 | 1 3/16-12 | 15.5 | 15.5 | 41 | 32 | 50 | 362 | 12-16F42EDMLOS | 12-16F42EDMLOSS | 420 | 420 |
| 18, 20 | 3/4 | 1 1/4-11 | 1 3/16-12 | 15.5 | 16.0 | 50 | 34 | 54 | 505 | 12-20F42EDMLOS | 12-20F42EDMLOSS | 420 | 420 |
| 22, 25 | 1 | 1-11 | 1 7/16-12 | 20.5 | 20.0 | 41 | 32 | 50 | 343 | 16F42EDMLOS | 16F42EDMLOSS | 420 | 420 |
| 22, 25 | 1 | 1/2-14 | 1 7/16-12 | 20.5 | 12.0 | 41 | 36 | 50 | 380 | 16-8F42EDMLOS | 16-8F42EDMLOSS | 420 | 420 |
| 22, 25 | 1 | 3/4-14 | 1 7/16-12 | 20.5 | 16.0 | 41 | 36 | 52 | 411 | 16-12F42EDMLOS | 16-12F42EDMLOSS | 420 | 420 |
| 22, 25 | 1 | 1 1/4-11 | 1 7/16-12 | 20.5 | 20.5 | 50 | 34 | 54 | 487 | 16-20F42EDMLOS | 16-20F42EDMLOSS | 420 | 420 |
| 22, 25 | 1 | 1 1/2-11 | 1 7/16-12 | 20.5 | 20.5 | 55 | 36 | 58 | 715 | 16-24F42EDMLOS | 16-24F42EDMLOSS | 350 | 280 |
| 28, 30, 32 | 1 1/4 | 1 1/4-11 | 1 11/16-12 | 25.0 | 25.0 | 50 | 34 | 54 | 454 | 20F42EDMLOS | 20F42EDMLOSS | 420 | 280 |
| 28, 30, 32 | 1 1/4 | 3/4-14 | 1 11/16-12 | 26.0 | 16.0 | 46 | 37 | 53 | 362 | 20-12F42EDMLOS | 20-12F42EDMLOSS | 420 | 280 |
| 28, 30, 32 | 1 1/4 | 1-11 | 1 11/16-12 | 26.0 | 20.0 | 46 | 39 | 57 | 412 | 20-16F42EDMLOS | 20-16F42EDMLOSS | 420 | 280 |
| 28, 30, 32 | 1 1/4 | 1 1/2-11 | 1 11/16-12 | 26.0 | 26.0 | 55 | 36 | 58 | 532 | 20-24F42EDMLOS | 20-24F42EDMLOSS | 350 | 280 |
| 35, 38 | 1 1/2 | 1 1/2-11 | 2-12 | 32.0 | 32.0 | 55 | 36 | 58 | 585 | 24F42EDMLOS | 24F42EDMLOSS | 350 | 280 |
| 35, 38 | 1 1/2 | 1-11 | 2-12 | 32.0 | 20.0 | 55 | 41 | 59 | 471 | 24-16F42EDMLOS | 24-16F42EDMLOSS | 350 | 280 |
| 35, 38 | 1 1/2 | 1 1/4-11 | 2-12 | 32.0 | 25.0 | 55 | 41 | 61 | 540 | 24-20F42EDMLOS | 24-20F42EDMLOSS | 350 | 280 |

Product delivered with NBR TRAP seal. Replacement of TRAP seal is with a standard NBR O-ring – see page J73-J74.

Part numbers shown are part of our current manufacturing programme.

Imperial and metric parts may vary in hexagon dimensions.

$$\frac{\text{PN (bar)}}{10} = \text{PN (MPa)}$$

Do not create drawings from these dimensions, they are subject to change and ISO manufacturing allowances.

FF42EDMLO Extended male stud connector

O-Lok® ORFS tube end / Male BSPP thread - ED seal (ISO 1179-2)

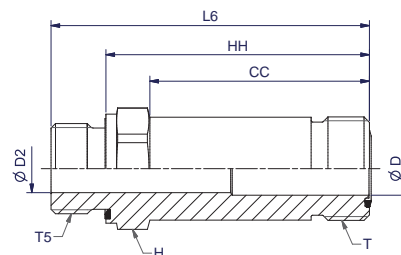

| Tube O.D. | | Thread UN/UNF-2A | Thread BSPP | CC mm | D mm | D2 mm | H mm | HH mm | L6 mm | Weight (steel) g/1 piece | O-Lok® Steel | O-Lok® Stainless Steel | PN (bar) | |
|------------|-----------|------------------|-------------|-------|------|-------|------|-------|-------|--------------------------|---------------------|------------------------|----------|-----|
| mm | inch | | | | | | | | | | | | S | SS |
| 8, 10 | 5/16, 3/8 | 11/16-16 | 1/4-19 | 37 | 7 | 5 | 19 | 46 | 58 | 80 | 6FF42EDMLOS | 6FF42EDMLOSS | 630 | 630 |
| 12 | 1/2 | 13/16-16 | 3/8-14 | 44 | 10 | 8 | 22 | 54 | 66 | 130 | 8FF42EDMLOS | 8FF42EDMLOSS | 630 | 630 |
| 14, 15, 16 | 5/8 | 1-14 | 1/2-14 | 52 | 13 | 13 | 27 | 63 | 77 | 200 | 10FF42EDMLOS | 10FF42EDMLOSS | 420 | 420 |
| 18, 20 | 3/4 | 1 3/16-12 | 3/4-14 | 64 | 16 | 16 | 32 | 74 | 93 | 360 | 12FF42EDMLOS | 12FF42EDMLOSS | 420 | 420 |

Product delivered with NBR TRAP seal. Replacement of TRAP seal is with a standard NBR O-ring – see page J73-J74.

Order codes shown are part of our current manufacturing programme.

Imperial and metric parts may vary in hexagon dimensions.

$$\frac{\text{PN (bar)}}{10} = \text{PN (MPa)}$$

Do not create drawings from these dimensions, they are subject to change and ISO manufacturing allowances.

J

O-Lok®

F82EDMLO Male stud connector

O-Lok® ORFS tube end / Male metric thread – ED seal (ISO 9974)

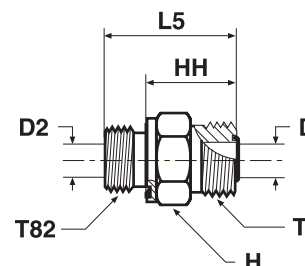

| Tube O.D. | | Thread metric T82 | Thread UN/UNF-2A T | D mm | D2 mm | H mm | HH mm | L5 mm | Weight (steel) g/1 piece | O-Lok® | | PN (bar) | |
|------------|-----------|-------------------|--------------------|------|-------|------|-------|-------|--------------------------|----------------|-----------------|----------|-----|
| mm | in. | | | | | | | | | Steel | Stainless Steel | S | SS |
| 6 | 1/4 | M 10×1.0 | 9/16-18 | 4.5 | 4.0 | 17 | 18 | 26 | 20 | 4M10F82EDMLOS | 4M10F82EDMLOSS | 630 | 630 |
| 6 | 1/4 | M 12×1.5 | 9/16-18 | 4.5 | 4.0 | 17 | 18 | 30 | 24 | 4M12F82EDMLOS | 4M12F82EDMLOSS | 630 | 630 |
| 6 | 1/4 | M 14×1.5 | 9/16-18 | 4.5 | 4.5 | 19 | 19 | 31 | 29 | 4M14F82EDMLOS | 4M14F82EDMLOSS | 630 | 630 |
| 6 | 1/4 | M 16×1.5 | 9/16-18 | 4.5 | 7.0 | 22 | 19 | 31 | 33 | 4M16F82EDMLOS | 4M16F82EDMLOSS | 630 | 630 |
| 8, 10 | 5/16, 3/8 | M 12×1.5 | 11/16-16 | 6.5 | 4.0 | 19 | 23 | 35 | 35 | 6M12F82EDMLOS | 6M12F82EDMLOSS | 630 | 630 |
| 8, 10 | 5/16, 3/8 | M 14×1.5 | 11/16-16 | 6.5 | 5.0 | 19 | 20 | 32 | 40 | 6M14F82EDMLOS | 6M14F82EDMLOSS | 630 | 630 |
| 8, 10 | 5/16, 3/8 | M 16×1.5 | 11/16-16 | 6.5 | 6.5 | 22 | 20 | 32 | 43 | 6M16F82EDMLOS | 6M16F82EDMLOSS | 630 | 630 |
| 8, 10 | 5/16, 3/8 | M 18×1.5 | 11/16-16 | 6.5 | 6.5 | 24 | 21 | 33 | 70 | 6M18F82EDMLOS | 6M18F82EDMLOSS | 630 | 630 |
| 8, 10 | 5/16, 3/8 | M 22×1.5 | 11/16-16 | 6.5 | 12.0 | 27 | 23 | 37 | 83 | 6M22F82EDMLOS | 6M22F82EDMLOSS | 630 | 630 |
| 12 | 1/2 | M 12×1.5 | 13/16-16 | 9.5 | 4.0 | 22 | 24 | 36 | 58 | 8M12F82EDMLOS | 8M12F82EDMLOSS | 630 | 630 |
| 12 | 1/2 | M 14×1.5 | 13/16-16 | 9.5 | 5.0 | 22 | 23 | 35 | 57 | 8M14F82EDMLOS | 8M14F82EDMLOSS | 630 | 630 |
| 12 | 1/2 | M 16×1.5 | 13/16-16 | 9.5 | 7.0 | 22 | 26 | 38 | 49 | 8M16F82EDMLOS | 8M16F82EDMLOSS | 630 | 630 |
| 12 | 1/2 | M 18×1.5 | 13/16-16 | 9.5 | 8.0 | 24 | 23 | 35 | 55 | 8M18F82EDMLOS | 8M18F82EDMLOSS | 630 | 630 |
| 12 | 1/2 | M 26×1.5 | 13/16-16 | 9.5 | 9.5 | 32 | 26 | 42 | 148 | 8M26F82EDMLOS | 8M26F82EDMLOSS | 420 | 420 |
| 14, 15, 16 | 5/8 | M 16×1.5 | 1-14 | 12.5 | 7.0 | 27 | 30 | 42 | 70 | 10M16F82EDMLOS | 10M16F82EDMLOSS | 420 | 420 |
| 14, 15, 16 | 5/8 | M 18×1.5 | 1-14 | 12.5 | 8.0 | 27 | 31 | 43 | 85 | 10M18F82EDMLOS | 10M18F82EDMLOSS | 420 | 420 |
| 14, 15, 16 | 5/8 | M 22×1.5 | 1-14 | 12.5 | 12.0 | 27 | 27 | 41 | 127 | 10M22F82EDMLOS | 10M22F82EDMLOSS | 420 | 420 |
| 14, 15, 16 | 5/8 | M 26×1.5 | 1-14 | 12.5 | 18.0 | 32 | 31 | 47 | 170 | 10M26F82EDMLOS | 10M26F82EDMLOSS | 420 | 420 |
| 18, 20 | 3/4 | M 18×1.5 | 1 3/16-12 | 15.5 | 8.0 | 32 | 35 | 47 | 184 | 12M18F82EDMLOS | 12M18F82EDMLOSS | 420 | 420 |
| 18, 20 | 3/4 | M 22×1.5 | 1 3/16-12 | 15.5 | 12.0 | 32 | 35 | 47 | 173 | 12M22F82EDMLOS | 12M22F82EDMLOSS | 420 | 420 |
| 18, 20 | 3/4 | M 27×2.0 | 1 3/16-12 | 15.5 | 15.5 | 32 | 30 | 46 | 187 | 12M27F82EDMLOS | 12M27F82EDMLOSS | 420 | 420 |
| 22, 25 | 1 | M 33×2.0 | 1 7/16-12 | 20.5 | 20.0 | 41 | 32 | 50 | 270 | 16M33F82EDMLOS | 16M33F82EDMLOSS | 420 | 420 |
| 28, 30, 32 | 1 1/4 | M 42×2.0 | 1 11/16-12 | 26.0 | 25.0 | 50 | 34 | 54 | 390 | 20M42F82EDMLOS | 20M42F82EDMLOSS | 420 | 280 |
| 35, 38 | 1 1/2 | M 48×2.0 | 2-12 | 32.0 | 32.0 | 55 | 36 | 58 | 412 | 24M48F82EDMLOS | 24M48F82EDMLOSS | 350 | 280 |

Product delivered with NBR TRAP seal. Replacement of TRAP seal is with a standard NBR O-ring – see page J73-J74.

Part numbers shown are part of our current manufacturing programme.

Imperial and metric parts may vary in hexagon dimensions.

$$\frac{\text{PN (bar)}}{10} = \text{PN (MPa)}$$

Do not create drawings from these dimensions, they are subject to change and ISO manufacturing allowances.

FLO Male stud connector

O-Lok® ORFS tube end / Male NPTF* thread (SAE J476)

*Stainless Steel = NPT to prevent galling

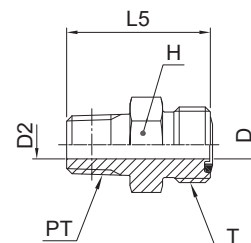

| Tube O.D. | | Thread NPTF PT | Thread UN/UNF-2A T | D mm | D2 mm | L5 mm | H mm | Weight (steel) g/1 piece | O-Lok® Steel | O-Lok® Stainless Steel | PN (bar) | |
|------------|-----------|----------------|--------------------|------|-------|-------|------|--------------------------|--------------------|------------------------|----------|-----|
| mm | in. | | | | | | | | | | S | SS |
| 6 | 1/4 | 1/8-27 | 9/16-18 | 4.5 | 4.5 | 27 | 16 | 26 | 4 FLO-S | 4 FLO-SS | 420 | 420 |
| 6 | 1/4 | 1/4-18 | 9/16-18 | 4.5 | 4.5 | 32 | 16 | 34 | 4-4 FLO-S | 4-4 FLO-SS | 420 | 420 |
| 6 | 1/4 | 3/8-18 | 9/16-18 | 4.5 | 4.5 | 34 | 19 | 47 | 4-6 FLO-S | 4-6 FLO-SS | 420 | 420 |
| 8, 10 | 5/16, 3/8 | 1/4-18 | 11/16-16 | 6.5 | 6.5 | 32 | 19 | 39 | 6 FLO-S | 6 FLO-SS | 420 | 420 |
| 8, 10 | 5/16, 3/8 | 3/8-18 | 11/16-16 | 6.5 | 6.5 | 34 | 19 | 52 | 6-6 FLO-S | 6-6 FLO-SS | 420 | 420 |
| 8, 10 | 5/16, 3/8 | 1/2-14 | 11/16-16 | 6.5 | 6.5 | 39 | 22 | 82 | 6-8 FLO-S | 6-8 FLO-SS | 420 | 420 |
| 12 | 1/2 | 3/8-18 | 13/16-16 | 9.5 | 9.5 | 38 | 22 | 83 | 8 FLO-S | 8 FLO-SS | 420 | 420 |
| 12 | 1/2 | 1/2-14 | 13/16-16 | 9.5 | 6.5 | 42 | 22 | 84 | 8-8 FLO-S | 8-8 FLO-SS | 420 | 420 |
| 12 | 1/2 | 3/4-14 | 13/16-16 | 9.5 | 9.5 | 43 | 29 | 166 | 8-12 FLO-S | 8-12 FLO-SS | 380 | 350 |
| 14, 15, 16 | 5/8 | 1/2-14 | 1-14 | 12.5 | 12.5 | 46 | 27 | 115 | 10 FLO-S | 10 FLO-SS | 420 | 420 |
| 14, 15, 16 | 5/8 | 3/4-14 | 1-14 | 12.5 | 12.5 | 46 | 29 | 138 | 10-12 FLO-S | 10-12 FLO-SS | 380 | 350 |
| 18, 20 | 3/4 | 3/4-14 | 1 3/16-12 | 15.5 | 15.5 | 49 | 32 | 179 | 12 FLO-S | 12 FLO-SS | 380 | 350 |
| 18, 20 | 3/4 | 1/2-14 | 1 3/16-12 | 15.5 | 13.5 | 49 | 32 | 165 | 12-8 FLO-S | 12-8 FLO-SS | 420 | 420 |
| 18, 20 | 3/4 | 1-11.5 | 1 3/16-12 | 15.5 | 15.5 | 54 | 35 | 225 | 12-16 FLO-S | 12-16 FLO-SS | 310 | 210 |
| 22, 25 | 1 | 1-11.5 | 1 7/16-12 | 20.5 | 20.5 | 56 | 38 | 271 | 16 FLO-S | 16 FLO-SS | 310 | 210 |
| 22, 25 | 1 | 3/4-14 | 1 7/16-12 | 20.5 | 18.3 | 51 | 38 | 238 | 16-12 FLO-S | 16-12 FLO-SS | 380 | 350 |
| 28, 30, 32 | 1 1/4 | 1 1/4-11.5 | 1 11/16-12 | 26.0 | 26.0 | 58 | 48 | 424 | 20 FLO-S | 20 FLO-SS | 210 | 210 |
| 35, 38 | 1 1/2 | 1 1/2-11.5 | 2-12 | 32.0 | 32.0 | 61 | 54 | 534 | 24 FLO-S | 24 FLO-SS | 200 | 175 |

Product delivered with NBR TRAP seal. Replacement of TRAP seal is with a standard NBR O-ring – see page J73-J74.

Part numbers shown are part of our current manufacturing programme.

Imperial and metric parts may vary in hexagon dimensions.

$$\frac{\text{PN (bar)}}{10} = \text{PN (MPa)}$$

Do not create drawings from these dimensions, they are subject to change and ISO manufacturing allowances.

J

O-Lok®

F687OML Swivel male stud

O-Lok® ORFS Female swivel end / Male metric thread – O-ring (ISO 6149-2)

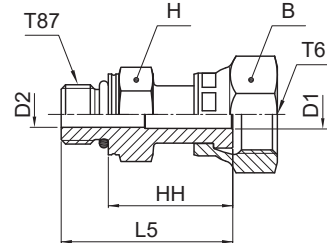

| Tube O.D. | | Thread metric T87 | Thread UN/UNF-2B T6 | B mm | H mm | D1 mm | D2 mm | L5 mm | HH mm | Weight (steel) g/1 piece | O-Lok® Steel | O-Lok® Stainless Steel | PN (bar) | |
|------------|-------|-------------------|---------------------|------|------|-------|-------|-------|-------|--------------------------|----------------------|------------------------|----------|-----|
| mm | in. | | | | | | | | | | | | S | SS |
| 6 | 1/4 | M 12×1.5 | 9/16-18 | 17 | 17 | 4.0 | 4.0 | 38 | 27 | 53 | 4M12F687OMLS | 4M12F687OMLSS | 500 | 420 |
| 8, 10 | 3/8 | M 14×1.5 | 11/16-16 | 22 | 19 | 6.5 | 6.0 | 40 | 29 | 72 | 6M14F687OMLS | 6M14F687OMLSS | 630 | 420 |
| 8, 10 | 3/8 | M 16×1.5 | 11/16-16 | 22 | 22 | 7.0 | 7.0 | 42 | 29 | 85 | 6M16F687OMLS | 6M16F687OMLSS | 630 | 420 |
| 12 | 1/2 | M 16×1.5 | 13/16-16 | 24 | 22 | 9.0 | 7.0 | 49 | 36 | 110 | 8M16F687OMLS | 8M16F687OMLSS | 630 | 420 |
| 14, 15, 16 | 5/8 | M 22×1.5 | 1-14 | 30 | 27 | 11.5 | 11.5 | 53 | 38 | 173 | 10M22F687OMLS | 10M22F687OMLSS | 420 | 400 |
| 18, 20 | 3/4 | M 22×1.5 | 1 3/16-12 | 36 | 30 | 14.0 | 12.0 | 57 | 42 | 230 | 12M22F687OMLS | 12M22F687OMLSS | 420 | 400 |
| 18, 20 | 3/4 | M 27×2.0 | 1 3/16-12 | 36 | 32 | 14.0 | 14.0 | 61 | 42 | 275 | 12M27F687OMLS | 12M27F687OMLSS | 420 | 400 |
| 22, 25 | 1 | M 33×2.0 | 1 7/16-12 | 41 | 41 | 20.0 | 20.0 | 68 | 49 | 462 | 16M33F687OMLS | 16M33F687OMLSS | 420 | 400 |
| 28, 30, 32 | 1 1/4 | M 42×2.0 | 1 11/16-12 | 50 | 50 | 26.0 | 26.0 | 71 | 52 | 622 | 20M42F687OMLS | 20M42F687OMLSS | 350 | 280 |
| 35, 38 | 1 1/2 | M 48×2.0 | 2-12 | 60 | 55 | 32.0 | 32.0 | 71 | 50 | 885 | 24M48F687OMLS | 24M48F687OMLSS | 280 | 280 |

O-Lok® is delivered with NBR elastomeric seals as standard. For more details on other seal materials see page J73-J74.

Part numbers shown are part of our current manufacturing programme.

Imperial and metric parts may vary in hexagon dimensions.

$$\frac{\text{PN (bar)}}{10} = \text{PN (MPa)}$$

Do not create drawings from these dimensions, they are subject to change and ISO manufacturing allowances.

F65OL Swivel male stud

O-Lok® ORFS female swivel end / Male UN/UNF thread – O-ring (ISO 11926)
SAE 520181

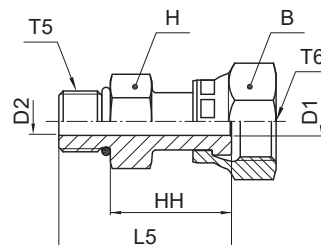

| Tube O.D. | | Thread UN/UNF-2A T5 | Thread UN/UNF-2B T6 | B | D1 | D2 | H | HH | L5 | Weight (steel) g/1 piece | O-Lok® Steel | PN (bar) |
|------------|-----------|---------------------|---------------------|----|------|------|----|----|----|--------------------------|-------------------|----------|
| mm | in. | | | mm | mm | mm | mm | mm | mm | | | |
| 6 | 1/4 | 7/16-20 | 9/16-18 | 18 | 4.0 | 4.0 | 16 | 26 | 37 | 53 | 4 F65OL-S | 500 |
| 8, 10 | 5/16, 3/8 | 9/16-18 | 11/16-16 | 21 | 6.5 | 6.5 | 19 | 28 | 40 | 66 | 6 F65OL-S | 630 |
| 12 | 1/2 | 3/4-16 | 13/16-16 | 24 | 9.0 | 9.0 | 22 | 36 | 50 | 110 | 8 F65OL-S | 630 |
| 14, 15, 16 | 5/8 | 7/8-14 | 1-14 | 29 | 11.5 | 12.5 | 27 | 38 | 54 | 173 | 10 F65OL-S | 420 |
| 18, 20 | 3/4 | 1 1/16-12 | 1 3/16-12 | 35 | 14.0 | 15.5 | 32 | 41 | 59 | 275 | 12 F65OL-S | 420 |
| 22, 25 | 1 | 1 5/16-12 | 1 7/16-12 | 41 | 20.0 | 20.0 | 38 | 49 | 68 | 462 | 16 F65OL-S | 420 |
| 28, 30, 32 | 1 1/4 | 1 5/8-12 | 1 11/16-12 | 48 | 26.0 | 26.0 | 48 | 49 | 68 | 622 | 20 F65OL-S | 350 |

O-Lok® is delivered with NBR elastomeric seals as standard. For more details on other seal materials see page J73-J74.

Part numbers shown are part of our current manufacturing programme.

Imperial and metric parts may vary in hexagon dimensions.

$$\frac{\text{PN (bar)}}{10} = \text{PN (MPa)}$$

Do not create drawings from these dimensions, they are subject to change and ISO manufacturing allowances.

J

O-Lok®

F642EDML Swivel male stud

O-Lok® ORFS Swivel female end / Male BSPP thread – ED seal (ISO 1179)

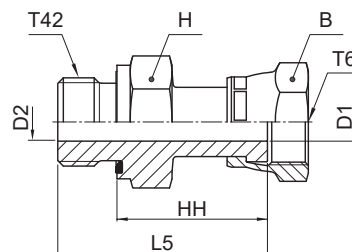

| Tube O.D. | | Thread BSPP T42 | Thread UN/UNF-2B T6 | B mm | H mm | D1 mm | D2 mm | L5 mm | HH mm | Weight (steel) g/1 piece | O-Lok® Steel | O-Lok® Stainless Steel | PN (bar) | |
|------------|-----------|-----------------|---------------------|------|------|-------|-------|-------|-------|--------------------------|-----------------------|------------------------|----------|-----|
| mm | in. | | | | | | | | | | | | S | SS |
| 6 | 1/4 | 1/8-28 | 9/16-18 | 17 | 14 | 4.0 | 4.0 | 35 | 27 | 43 | 4F642EDMLS | 4F642EDMLSS | 500 | 420 |
| 6 | 1/4 | 1/4-19 | 9/16-18 | 17 | 19 | 4.0 | 4.0 | 39 | 27 | 59 | 4-4F642EDMLS | 4-4F642EDMLSS | 500 | 420 |
| 8, 10 | 5/16, 3/8 | 1/4-19 | 11/16-16 | 22 | 19 | 6.5 | 5.0 | 41 | 29 | 72 | 6F642EDMLS | 6F642EDMLSS | 630 | 420 |
| 8, 10 | 5/16, 3/8 | 3/8-19 | 11/16-16 | 22 | 22 | 6.5 | 6.5 | 41 | 29 | 86 | 6-6F642EDMLS | 6-6F642EDMLSS | 630 | 420 |
| 8, 10 | 5/16, 3/8 | 1/2-14 | 11/16-16 | 22 | 27 | 6.5 | 6.5 | 43 | 29 | 92 | 6-8F642EDMLS | 6-8F642EDMLSS | 420 | 420 |
| 12 | 1/2 | 3/8-19 | 13/16-16 | 24 | 22 | 9.0 | 8.0 | 48 | 36 | 104 | 8F642EDMLS | 8F642EDMLSS | 630 | 420 |
| 12 | 1/2 | 1/4-19 | 13/16-16 | 24 | 22 | 9.0 | 5.0 | 48 | 36 | 98 | 8-4F642EDMLS | 8-4F642EDMLSS | 630 | 420 |
| 12 | 1/2 | 1/2-14 | 13/16-16 | 24 | 27 | 9.0 | 9.0 | 50 | 36 | 142 | 8-8F642EDMLS | 8-8F642EDMLSS | 420 | 420 |
| 14, 15, 16 | 5/8 | 1/2-14 | 1-14 | 30 | 27 | 11.5 | 11.5 | 52 | 38 | 165 | 10F642EDMLS | 10F642EDMLSS | 420 | 420 |
| 14, 15, 16 | 5/8 | 3/4-14 | 1-14 | 30 | 32 | 11.5 | 11.5 | 54 | 38 | 185 | 10-12F642EDMLS | 10-12F642EDMLSS | 420 | 420 |
| 18, 20 | 3/4 | 3/4-14 | 1 3/16-12 | 36 | 32 | 14.0 | 14.0 | 58 | 42 | 266 | 12F642EDMLS | 12F642EDMLSS | 420 | 420 |
| 18, 20 | 3/4 | 1/2-14 | 1 3/16-12 | 36 | 30 | 14.0 | 12.0 | 56 | 42 | 220 | 12-8F642EDMLS | 12-8F642EDMLSS | 420 | 420 |
| 22, 25 | 1 | 1-11 | 1 7/16-12 | 41 | 41 | 20.0 | 20.0 | 67 | 49 | 414 | 16F642EDMLS | 16F642EDMLSS | 420 | 420 |
| 28, 30, 32 | 1 1/4 | 1-11 | 1 11/16-12 | 50 | 46 | 26.0 | 20.0 | 67 | 49 | 655 | 20-16F642EDMLS | 20-16F642EDMLSS | 350 | 280 |
| 28, 30, 32 | 1 1/4 | 1 1/4-11 | 1 11/16-12 | 50 | 50 | 26.0 | 25.0 | 69 | 49 | 623 | 20F642EDMLS | 20F642EDMLSS | 350 | 280 |
| 35, 38 | 1 1/2 | 1 1/2-11 | 2-12 | 60 | 55 | 32.0 | 32.0 | 72 | 50 | 885 | 24F642EDMLS | 24F642EDMLSS | 280 | 280 |

O-Lok® is delivered with NBR elastomeric seals as standard. For more details on other seal materials see page J73-J74.

Part numbers shown are part of our current manufacturing programme.

Imperial and metric parts may vary in hexagon dimensions.

$$\frac{\text{PN (bar)}}{10} = \text{PN (MPa)}$$

Do not create drawings from these dimensions, they are subject to change and ISO manufacturing allowances.

F682EDML Swivel male stud

O-Lok® ORFS Swivel female end / Male metric thread – ED seal (ISO 9974)

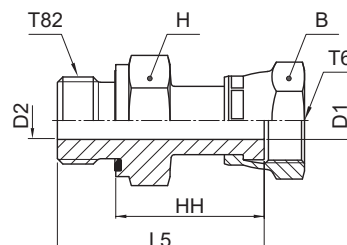

| Tube O.D. | | Thread metric T82 | Thread UN/UNF-2B T6 | B mm | H mm | D1 mm | D2 mm | L5 mm | HH mm | Weight (steel) g/1 piece | O-Lok® | | PN (bar) | |
|------------|-----------|-------------------|---------------------|------|------|-------|-------|-------|-------|--------------------------|-----------------------|------------------------|----------|-----|
| mm | in. | | | | | | | | | | Steel | Stainless Steel | S | SS |
| 6 | 1/4 | M 12×1.5 | 9/16-18 | 17 | 17 | 4.0 | 4.0 | 39 | 27 | 56 | 4M12F682EDMLS | 4M12F682EDMLSS | 500 | 420 |
| 8, 10 | 5/16, 3/8 | M 12×1.5 | 11/16-16 | 22 | 19 | 6.5 | 4.0 | 41 | 29 | 70 | 6M12F682EDMLS | 6M12F682EDMLSS | 500 | 420 |
| 8, 10 | 5/16, 3/8 | M 14×1.5 | 11/16-16 | 22 | 19 | 6.5 | 5.0 | 41 | 29 | 73 | 6M14F682EDMLS | 6M14F682EDMLSS | 630 | 420 |
| 8, 10 | 5/16, 3/8 | M 16×1.5 | 11/16-16 | 22 | 22 | 6.5 | 6.5 | 41 | 29 | 85 | 6M16F682EDMLS | 6M16F682EDMLSS | 630 | 420 |
| 12 | 1/2 | M 16×1.5 | 13/16-16 | 24 | 22 | 9.0 | 7.0 | 48 | 36 | 109 | 8M16F682EDMLS | 8M16F682EDMLSS | 630 | 420 |
| 14, 15, 16 | 5/8 | M 22×1.5 | 1-14 | 30 | 27 | 11.5 | 11.5 | 53 | 39 | 165 | 10M22F682EDMLS | 10M22F682EDMLSS | 420 | 420 |
| 18, 20 | 3/4 | M 27×2.0 | 1 3/16-12 | 36 | 32 | 14.0 | 14.0 | 58 | 42 | 282 | 12M27F682EDMLS | 12M27F682EDMLSS | 420 | 420 |
| 22, 25 | 1 | M 33×2.0 | 1 7/16-12 | 41 | 41 | 20.0 | 20.0 | 68 | 50 | 467 | 16M33F682EDMLS | 16M33F682EDMLSS | 420 | 420 |
| 28, 30, 32 | 1 1/4 | M 42×2.0 | 1 11/16-12 | 50 | 50 | 26.0 | 26.0 | 70 | 50 | 635 | 20M42F682EDMLS | 20M42F682EDMLSS | 350 | 280 |
| 35, 38 | 1 1/2 | M 48×2.0 | 2-12 | 60 | 55 | 32.0 | 32.0 | 72 | 50 | 885 | 24M48F682EDMLS | 24M48F682EDMLSS | 280 | 280 |

J

O-Lok® is delivered with NBR elastomeric seals as standard. For more details on other seal materials see page J73-J74.

Part numbers shown are part of our current manufacturing programme.

Imperial and metric parts may vary in hexagon dimensions.

$$\frac{\text{PN (bar)}}{10} = \text{PN (MPa)}$$

Do not create drawings from these dimensions, they are subject to change and ISO manufacturing allowances.

O-Lok®
C87OMLO Male stud elbow

O-Lok® ORFS tube end / Male metric thread – O-ring (ISO 6149-2)
SAE 52M0287 ISO 8434-3 SDE

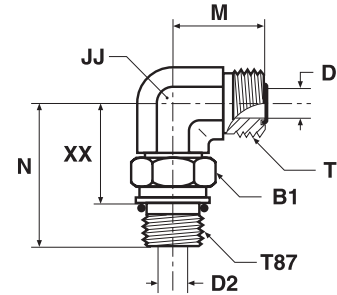

| Tube O.D. | | Thread metric T87 | Thread UN/UNF-2B T | B1 mm | D mm | D2 mm | JJ* mm | M mm | N mm | XX mm | Weight (steel) g/1 piece | O-Lok® Steel | O-Lok® Stainless Steel | PN (bar) | |
|------------|-----------|-------------------|--------------------|-------|------|-------|--------|------|------|-------|--------------------------|---------------|------------------------|----------|-----|
| mm | in. | | | | | | | | | | | | | S | SS |
| 6 | 1/4 | M 10×1.0 | 9/16-18 | 14 | 4.5 | 3 | 14 | 22 | 31 | 21 | 50 | 4M10C87OMLOS | 4M10C87OMLOSS | 420 | 420 |
| 6 | 1/4 | M 12×1.5 | 9/16-18 | 17 | 4.5 | 4 | 14 | 22 | 33 | 21 | 52 | 4M12C87OMLOS | 4M12C87OMLOSS | 420 | 420 |
| 6 | 1/4 | M 14×1.5 | 9/16-18 | 19 | 4.5 | 6 | 14 | 24 | 36 | 24 | 55 | 4M14C87OMLOS | 4M14C87OMLOSS | 420 | 420 |
| 8, 10 | 5/16, 3/8 | M 12×1.5 | 11/16-16 | 17 | 6.5 | 4 | 19 | 25 | 36 | 24 | 60 | 6M12C87OMLOS | 6M12C87OMLOSS | 420 | 420 |
| 8, 10 | 5/16, 3/8 | M 14×1.5 | 11/16-16 | 19 | 6.5 | 6 | 19 | 25 | 36 | 24 | 60 | 6M14C87OMLOS | 6M14C87OMLOSS | 420 | 420 |
| 8, 10 | 5/16, 3/8 | M 16×1.5 | 11/16-16 | 22 | 6.5 | 7 | 19 | 25 | 38 | 24 | 65 | 6M16C87OMLOS | 6M16C87OMLOSS | 420 | 420 |
| 8, 10 | 5/16, 3/8 | M 18×1.5 | 11/16-16 | 24 | 6.5 | 9 | 19 | 27 | 41 | 26 | 130 | 6M18C87OMLOS | 6M18C87OMLOSS | 420 | 420 |
| 12 | 1/2 | M 14×1.5 | 13/16-16 | 19 | 9.5 | 6 | 19 | 28 | 36 | 24 | 150 | 8M14C87OMLOS | 8M14C87OMLOSS | 420 | 420 |
| 12 | 1/2 | M 16×1.5 | 13/16-16 | 22 | 9.5 | 7 | 19 | 28 | 38 | 25 | 92 | 8M16C87OMLOS | 8M16C87OMLOSS | 420 | 420 |
| 12 | 1/2 | M 18×1.5 | 13/16-16 | 24 | 9.5 | 9 | 19 | 28 | 41 | 26 | 161 | 8M18C87OMLOS | 8M18C87OMLOSS | 420 | 420 |
| 12 | 1/2 | M 22×1.5 | 13/16-16 | 27 | 9.5 | 12 | 27 | 31 | 49 | 33 | 200 | 8M22C87OMLOS | 8M22C87OMLOSS | 420 | 420 |
| 14, 15, 16 | 5/8 | M 18×1.5 | 1-14 | 24 | 12.5 | 9 | 27 | 33 | 48 | 33 | 190 | 10M18C87OMLOS | 10M18C87OMLOSS | 420 | 420 |
| 14, 15, 16 | 5/8 | M 22×1.5 | 1-14 | 27 | 12.5 | 12 | 27 | 33 | 49 | 33 | 214 | 10M22C87OMLOS | 10M22C87OMLOSS | 420 | 420 |
| 18, 20 | 3/4 | M 22×1.5 | 1 3/16-12 | 27 | 15.5 | 12 | 30 | 37 | 50 | 34 | 390 | 12M22C87OMLOS | 12M22C87OMLOSS | 420 | 420 |
| 18, 20 | 3/4 | M 27×2.0 | 1 3/16-12 | 32 | 15.5 | 15 | 30 | 37 | 56 | 37 | 440 | 12M27C87OMLOS | 12M27C87OMLOSS | 420 | 420 |
| 22, 25 | 1 | M 33×2.0 | 1 7/16-12 | 41 | 20.5 | 20 | 36 | 42 | 59 | 41 | 501 | 16M33C87OMLOS | 16M33C87OMLOSS | 420 | 420 |
| 28, 30, 32 | 1 1/4 | M 33×2.0 | 1 11/16-12 | 41 | 26.0 | 20 | 41 | 45 | 62 | 43 | 530 | 20M33C87OMLOS | 20M33C87OMLOSS | 350 | 280 |
| 28, 30, 32 | 1 1/4 | M 42×2.0 | 1 11/16-12 | 50 | 26.0 | 26 | 41 | 45 | 63 | 44 | 561 | 20M42C87OMLOS | 20M42C87OMLOSS | 280 | 280 |
| 35, 38 | 1 1/2 | M 48×2.0 | 2-12 | 55 | 32.0 | 32 | 50 | 49 | 72 | 50 | 684 | 24M48C87OMLOS | 24M48C87OMLOSS | 280 | 280 |

Product delivered with NBR TRAP seal. Replacement of TRAP seal is with a standard NBR O-ring – see page J73-J74.

Part numbers shown are part of our current manufacturing programme.

Imperial and metric parts may vary in hexagon dimensions.

PN (bar) = PN (MPa)
10

Do not create drawings from these dimensions, they are subject to change and ISO manufacturing allowances.

*JJ may vary in stainless steel

C5OMLO Male stud elbow

O-Lok® ORFS tube end / Male UN/UNF thread – O-ring (ISO 11926)
SAE 520220

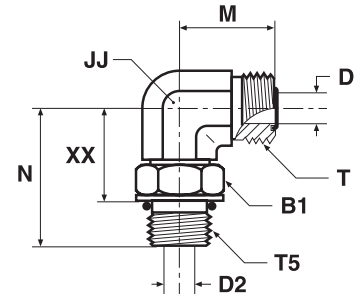

| Tube O.D. | | Thread UN/UNF-2A T5 | Thread UN/UNF-2A T | B1 | D | D2 | JJ* | M | N | XX | Weight (steel) g/1 piece | O-Lok® Steel | O-Lok® Stainless Steel | PN (bar) | |
|------------|-------|---------------------|--------------------|----|------|------|-----|----|----|----|--------------------------|---------------|------------------------|----------|-----|
| mm | in. | | T | mm | mm | mm | mm | mm | mm | mm | | | | S | SS |
| 6 | 1/4 | 7/16-20 | 9/16-18 | 17 | 4.5 | 4.5 | 14 | 22 | 33 | 21 | 53 | 4C5OMLOS | 4C5OMLOSS | 420 | 420 |
| 6 | 1/4 | 9/16-18 | 9/16-18 | 19 | 4.5 | 7.5 | 19 | 24 | 37 | 24 | 66 | 4-6C5OMLOS | 4-6C5OMLOSS | 420 | 420 |
| 8, 10 | 3/8 | 9/16-18 | 11/16-16 | 19 | 6.5 | 7.5 | 19 | 25 | 37 | 24 | 68 | 6C5OMLOS | 6C5OMLOSS | 420 | 420 |
| 8, 10 | 3/8 | 7/16-20 | 11/16-16 | 16 | 6.5 | 4.5 | 19 | 25 | 35 | 24 | 57 | 6-4 C5OLO-S | 6-4C5OMLOSS | 420 | 420 |
| 8, 10 | 3/8 | 1/2-20 | 11/16-16 | 18 | 6.5 | 6.0 | 19 | 25 | 35 | 23 | 94 | 6-5 C5OLO-S | 6-5C5OMLOSS | 420 | 420 |
| 8, 10 | 3/8 | 3/4-16 | 11/16-16 | 24 | 6.5 | 10.0 | 19 | 26 | 41 | 26 | 105 | 6-8C5OMLOS | 6-8C5OMLOSS | 420 | 420 |
| 8, 10 | 3/8 | 7/8-14 | 11/16-16 | 27 | 6.5 | 12.5 | 22 | 29 | 50 | 33 | 196 | 6-10 C5OLO-S | 6-10C5OMLOSS | 420 | 420 |
| 8, 10 | 3/8 | 1 1/16-12 | 11/16-16 | 35 | 6.5 | 15.5 | 27 | 33 | 55 | 36 | 250 | 6-12 C5OLO-S | 6-12C5OMLOSS | 420 | 420 |
| 12 | 1/2 | 3/4-16 | 13/16-16 | 24 | 9.5 | 10.0 | 19 | 28 | 41 | 26 | 164 | 8C5OMLOS | 8C5OMLOSS | 420 | 420 |
| 12 | 1/2 | 1/2-20 | 13/16-16 | 18 | 9.5 | 6.0 | 19 | 28 | 35 | 23 | 101 | 8-5 C5OLO-S | 8-5C5OMLOSS | 420 | 420 |
| 12 | 1/2 | 9/16-18 | 13/16-16 | 19 | 9.5 | 7.5 | 19 | 28 | 37 | 24 | 81 | 8-6 C5OLO-S | 8-6C5OMLOSS | 420 | 420 |
| 12 | 1/2 | 7/8-14 | 13/16-16 | 27 | 9.5 | 12.5 | 27 | 31 | 50 | 33 | 187 | 8-10C5OMLOS | 8-10C5OMLOSS | 420 | 420 |
| 12 | 1/2 | 1 1/16-12 | 13/16-16 | 36 | 9.5 | 15.5 | 30 | 34 | 55 | 36 | 201 | 8-12C5OMLOS | 8-12C5OMLOSS | 420 | 420 |
| 14, 15, 16 | 5/8 | 7/8-14 | 1-14 | 27 | 12.5 | 12.5 | 27 | 33 | 50 | 33 | 214 | 10C5OMLOS | 10C5OMLOSS | 420 | 420 |
| 14, 15, 16 | 5/8 | 3/4-16 | 1-14 | 24 | 12.5 | 10.0 | 27 | 33 | 46 | 32 | 175 | 10-8 C5OLO-S | 10-8C5OMLOSS | 420 | 420 |
| 14, 15, 16 | 5/8 | 1 1/16-12 | 1-14 | 35 | 12.5 | 15.5 | 30 | 36 | 55 | 36 | 248 | 10-12 C5OLO-S | 10-12C5OMLOSS | 420 | 420 |
| 18, 20 | 3/4 | 1 1/16-12 | 1 3/16-12 | 36 | 15.5 | 15.5 | 30 | 37 | 55 | 36 | 442 | 12C5OMLOS | 12C5OMLOSS | 420 | 420 |
| 18, 20 | 3/4 | 3/4-16 | 1 3/16-12 | 24 | 15.5 | 10.0 | 30 | 37 | 47 | 32 | 325 | 12-8 C5OLO-S | 12-8C5OMLOSS | 420 | 420 |
| 18, 20 | 3/4 | 7/8-14 | 1 3/16-12 | 27 | 15.5 | 12.5 | 30 | 37 | 51 | 34 | 296 | 12-10C5OMLOS | 12-10C5OMLOSS | 420 | 420 |
| 18, 20 | 3/4 | 1 5/16-12 | 1 3/16-12 | 41 | 15.5 | 21.5 | 36 | 41 | 60 | 41 | 346 | 12-16 C5OLO-S | 12-16C5OMLOSS | 380 | 380 |
| 25 | 1 | 1 5/16-12 | 1 7/16-12 | 41 | 20.5 | 21.5 | 36 | 42 | 60 | 41 | 502 | 16 C5OLO-S | 16C5OMLOSS | 380 | 380 |
| 25 | 1 | 1 1/16-12 | 1 7/16-12 | 35 | 20.5 | 15.5 | 36 | 42 | 59 | 40 | 473 | 16-12 C5OLO-S | 16-12C5OMLOSS | 420 | 420 |
| 25 | 1 | 1 5/8-12 | 1 7/16-12 | 48 | 20.5 | 27.5 | 41 | 45 | 62 | 43 | 580 | 16-20 C5OLO-S | 16-20C5OMLOSS | 280 | 280 |
| 28, 30, 32 | 1 1/4 | 1 5/8-12 | 1 11/16-12 | 48 | 26.0 | 27.5 | 41 | 45 | 62 | 43 | 563 | 20 C5OLO-S | 20C5OMLOSS | 280 | 280 |
| 28, 30, 32 | 1 1/4 | 1 5/16-12 | 1 11/16-12 | 41 | 26.0 | 21.5 | 41 | 45 | 62 | 43 | 563 | 20-16 C5OLO-S | 20-16C5OMLOSS | 380 | 280 |
| 28, 30, 32 | 1 1/4 | 1 7/8-12 | 1 11/16-12 | 54 | 26.0 | 33.5 | 48 | 49 | 66 | 47 | 764 | 20-24 C5OLO-S | 20-24C5OMLOSS | 280 | 280 |
| 35, 38 | 1 1/2 | 1 7/8-12 | 2-12 | 54 | 32.0 | 33.5 | 48 | 49 | 66 | 47 | 689 | 24 C5OLO-S | 24C5OMLOSS | 280 | 280 |
| 35, 38 | 1 1/2 | 1 5/8-12 | 2-12 | 48 | 32.0 | 26.0 | 48 | 49 | 66 | 47 | 644 | 24-20 C5OLO-S | 24-20C5OMLOSS | 280 | 280 |

Product delivered with NBR TRAP seal. Replacement of TRAP seal is with a standard NBR O-ring – see page J73-J74.

Part numbers shown are part of our current manufacturing programme.

Imperial and metric parts may vary in hexagon dimensions.

$$\frac{\text{PN (bar)}}{10} = \text{PN (MPa)}$$

Do not create drawings from these dimensions, they are subject to change and ISO manufacturing allowances.

*JJ may vary in stainless steel

O-Lok®

CC5OLO Extended male stud elbow

O-Lok® ORFS tube end / Male UN/UNF thread – O-ring (ISO 11926)
SAE 521520

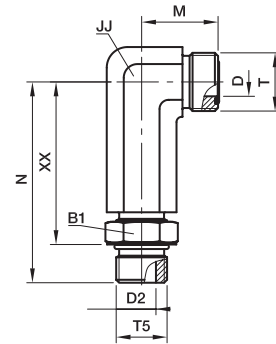

| Tube O.D. | | Thread UN/UNF-2A T5 | Thread UN/UNF-2A T | B1 | D | D2 | JJ* | M | N | XX | Weight (steel) g/1 piece | O-Lok® Steel | PN (bar) |
|------------|-----|---------------------|--------------------|----|------|------|-----|----|-----|----|--------------------------|--------------------|----------|
| mm | in. | | | mm | mm | mm | mm | mm | mm | mm | | | |
| 6 | 1/4 | 7/16-20 | 9/16-18 | 16 | 4.5 | 4.5 | 14 | 22 | 57 | 45 | 44 | 4 CC5OLO-S | 420 |
| 8, 10 | 3/8 | 9/16-18 | 11/16-16 | 19 | 6.5 | 7.5 | 22 | 25 | 66 | 54 | 51 | 6 CC5OLO-S | 420 |
| 12 | 1/2 | 3/4-16 | 13/16-16 | 24 | 9.5 | 10.0 | 22 | 28 | 75 | 61 | 146 | 8 CC5OLO-S | 420 |
| 14, 15, 16 | 5/8 | 7/8-14 | 1-14 | 27 | 12.5 | 12.5 | 27 | 33 | 89 | 73 | 159 | 10 CC5OLO-S | 420 |
| 18, 20 | 3/4 | 1 1/16-12 | 1 3/16-12 | 35 | 15.5 | 15.5 | 33 | 37 | 101 | 82 | 291 | 12 CC5OLO-S | 420 |
| 25 | 1 | 1 5/16-12 | 1 7/16-12 | 41 | 20.5 | 21.5 | 41 | 42 | 115 | 96 | 481 | 16 CC5OLO-S | 380 |

Product delivered with NBR TRAP seal. Replacement of TRAP seal is with a standard NBR O-ring – see page J73-J74.

Part numbers shown are part of our current manufacturing programme.

Imperial and metric parts may vary in hexagon dimensions.

$$\frac{\text{PN (bar)}}{10} = \text{PN (MPa)}$$

Do not create drawings from these dimensions, they are subject to change and ISO manufacturing allowances.

*JJ may vary in stainless steel

C4OMLO Male stud elbow

O-Lok® ORFS tube end / Male BSPP thread O-ring + retaining ring (ISO 1179)

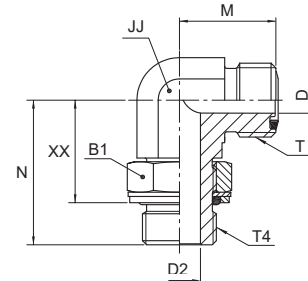

| Tube O.D. | | Thread BSPP T4 | Thread UN/UNF-2A T | B1 mm | D mm | D2 mm | JJ* mm | M mm | N mm | XX mm | Weight (steel) g/1 piece | O-Lok® Steel | O-Lok® Stainless Steel | PN (bar) | |
|------------|-------|----------------|--------------------|-------|------|-------|--------|------|------|-------|--------------------------|---------------------|------------------------|----------|-----|
| mm | in. | | | | | | | | | | | Steel | Stainless Steel | S | SS |
| 6 | 1/4 | 1/8-28 | 9/16-18 | 14 | 4.5 | 4.4 | 14 | 22 | 30 | 21 | 49 | 4C4OMLOS | 4C4OMLOSS | 250 | 250 |
| 6 | 1/4 | 1/4-19 | 9/16-18 | 19 | 4.5 | 7.5 | 19 | 24 | 36 | 25 | 93 | 4-4C4OMLOS | 4-4C4OMLOSS | 250 | 200 |
| 6 | 1/4 | 3/8-19 | 9/16-18 | 22 | 4.5 | 9.9 | 19 | 25 | 38 | 27 | 99 | 4-6C4OMLOS | 4-6C4OMLOSS | 250 | 200 |
| 8, 10 | 3/8 | 1/4-19 | 11/16-16 | 19 | 6.5 | 7.5 | 19 | 25 | 36 | 25 | 97 | 6C4OMLOS | 6C4OMLOSS | 250 | 200 |
| 8, 10 | 3/8 | 1/8-28 | 11/16-16 | 14 | 6.5 | 4.4 | 19 | 25 | 32 | 23 | 62 | 6-2C4OMLOS | 6-2C4OMLOSS | 250 | 200 |
| 8, 10 | 3/8 | 3/8-19 | 11/16-16 | 22 | 6.5 | 9.9 | 19 | 27 | 38 | 27 | 106 | 6-6C4OMLOS | 6-6C4OMLOSS | 250 | 200 |
| 8, 10 | 3/8 | 1/2-14 | 11/16-16 | 27 | 6.5 | 12.3 | 27 | 29 | 49 | 35 | 120 | 6-8C4OMLOS | 6-8C4OMLOSS | 250 | 200 |
| 12 | 1/2 | 3/8-19 | 13/16-16 | 22 | 9.5 | 9.9 | 19 | 28 | 38 | 27 | 108 | 8C4OMLOS | 8C4OMLOSS | 250 | 200 |
| 12 | 1/2 | 1/4-19 | 13/16-16 | 19 | 9.5 | 7.5 | 19 | 28 | 36 | 25 | 99 | 8-4C4OMLOS | 8-4C4OMLOSS | 250 | 200 |
| 12 | 1/2 | 1/2-14 | 13/16-16 | 27 | 9.5 | 12.3 | 27 | 31 | 49 | 35 | 239 | 8-8C4OMLOS | 8-8C4OMLOSS | 250 | 200 |
| 12 | 1/2 | 3/4-14 | 13/16-16 | 36 | 9.5 | 15.5 | 30 | 34 | 52 | 38 | 258 | 8-12C4OMLOS | 8-12C4OMLOSS | 250 | 200 |
| 14, 15, 16 | 5/8 | 1/2-14 | 1-14 | 27 | 12.5 | 12.3 | 27 | 33 | 49 | 35 | 274 | 10C4OMLOS | 10C4OMLOSS | 250 | 200 |
| 14, 15, 16 | 5/8 | 3/8-19 | 1-14 | 22 | 12.5 | 9.9 | 27 | 33 | 43 | 32 | 235 | 10-6C4OMLOS | 10-6C4OMLOSS | 250 | 200 |
| 14, 15, 16 | 5/8 | 3/4-14 | 1-14 | 36 | 12.5 | 15.5 | 30 | 36 | 52 | 38 | 352 | 10-12C4OMLOS | 10-12C4OMLOSS | 250 | 200 |
| 14, 15, 16 | 5/8 | 1-11 | 1-14 | 41 | 12.5 | 21.5 | 36 | 40 | 58 | 42 | 382 | 10-16C4OMLOS | 10-16C4OMLOSS | 250 | 200 |
| 18, 20 | 3/4 | 3/4-14 | 1 3/16-12 | 36 | 15.5 | 15.5 | 30 | 37 | 52 | 38 | 355 | 12C4OMLOS | 12C4OMLOSS | 250 | 200 |
| 18, 20 | 3/4 | 1/2-14 | 1 3/16-12 | 27 | 15.5 | 12.3 | 30 | 37 | 50 | 36 | 297 | 12-8C4OMLOS | 12-8C4OMLOSS | 250 | 200 |
| 18, 20 | 3/4 | 1-11 | 1 3/16-12 | 41 | 15.5 | 21.5 | 36 | 41 | 58 | 42 | 362 | 12-16C4OMLOS | 12-16C4OMLOSS | 250 | 200 |
| 25 | 1 | 1-11 | 1 7/16-12 | 41 | 20.5 | 21.5 | 36 | 42 | 58 | 42 | 551 | 16C4OMLOS | 16C4OMLOSS | 250 | 200 |
| 25 | 1 | 3/4-14 | 1 7/16-12 | 36 | 20.5 | 15.5 | 36 | 42 | 55 | 42 | 533 | 16-12C4OMLOS | 16-12C4OMLOSS | 250 | 200 |
| 25 | 1 | 1 1/4-11 | 1 7/16-12 | 50 | 20.5 | 27.5 | 41 | 45 | 61 | 45 | 758 | 16-20C4OMLOS | 16-20C4OMLOSS | 210 | 160 |
| 28, 30, 32 | 1 1/4 | 1 1/4-11 | 1 11/16-12 | 50 | 26.0 | 27.5 | 41 | 45 | 61 | 45 | 752 | 20C4OMLOS | 20C4OMLOSS | 210 | 160 |
| 28, 30, 32 | 1 1/4 | 1-11 | 1 11/16-12 | 41 | 26.0 | 21.5 | 41 | 45 | 61 | 45 | 712 | 20-16C4OMLOS | 20-16C4OMLOSS | 250 | 200 |
| 28, 30, 32 | 1 1/4 | 1 1/2-11 | 1 11/16-12 | 55 | 26.0 | 33.0 | 50 | 49 | 65 | 48 | 821 | 20-24C4OMLOS | 20-24C4OMLOSS | 140 | 140 |
| 35, 28 | 1 1/2 | 1 1/2-11 | 2-12 | 55 | 32.0 | 33.0 | 50 | 49 | 65 | 48 | 953 | 24C4OMLOS | 24C4OMLOSS | 140 | 140 |
| 35, 38 | 1 1/2 | 1 1/4-11 | 2-12 | 50 | 32.0 | 27.5 | 50 | 49 | 65 | 46 | 1098 | 24-20C4OMLOS | 24-20C4OMLOSS | 140 | 140 |

J

Product delivered with NBR TRAP seal. Replacement of TRAP seal is with a standard NBR O-ring – see page J73-J74.

Part numbers shown are part of our current manufacturing programme.

Imperial and metric parts may vary in hexagon dimensions.

$$\frac{\text{PN (bar)}}{10} = \text{PN (MPa)}$$

Do not create drawings from these dimensions, they are subject to change and ISO manufacturing allowances.

*JJ may vary in stainless steel

O-Lok®

C8OMLO Male stud elbow

O-Lok® ORFS tube end / Male metric thread – O-ring + retaining ring

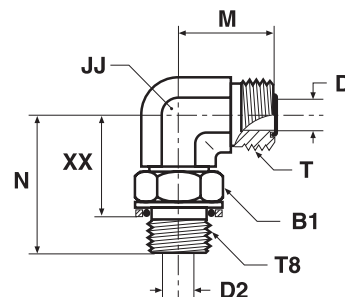

| Tube O.D. | | Thread metric T8 | Thread UN/UNF-2A T | B1 mm | D mm | D2 mm | JJ* mm | M mm | N mm | XX mm | Weight (steel) g/1 piece | O-Lok® Steel | PN (bar) |
|------------|-------|------------------|--------------------|-------|------|-------|--------|------|------|-------|--------------------------|---------------------|----------|
| mm | in. | | | | | | | | | | | | |
| 6 | 1/4 | M 12×1.5 | 9/16-18 | 17 | 4.5 | 4 | 14 | 22 | 33 | 22 | 52 | 4M12C8OMLOS | 250 |
| 6 | 1/4 | M 14×1.5 | 9/16-18 | 17 | 4.5 | 6 | 14 | 24 | 36 | 24 | 58 | 4M14C8OMLOS | 250 |
| 8, 10 | 3/8 | M 14×1.5 | 11/16-16 | 17 | 6.5 | 6 | 19 | 25 | 36 | 25 | 62 | 6M14C8OMLOS | 250 |
| 8, 10 | 3/8 | M 16×1.5 | 11/16-16 | 19 | 6.5 | 7 | 19 | 25 | 38 | 24 | 65 | 6M16C8OMLOS | 250 |
| 12 | 1/2 | M 16×1.5 | 13/16-16 | 19 | 9.5 | 7 | 19 | 28 | 38 | 25 | 82 | 8M16C8OMLOS | 250 |
| 12 | 1/2 | M 18×1.5 | 13/16-16 | 22 | 9.5 | 9 | 19 | 28 | 41 | 25 | 161 | 8M18C8OMLOS | 250 |
| 14, 15, 16 | 5/8 | M 18×1.5 | 1-14 | 22 | 12.5 | 9 | 27 | 33 | 48 | 32 | 185 | 10M18C8OMLOS | 250 |
| 14, 15, 16 | 5/8 | M 22×1.5 | 1-14 | 27 | 12.5 | 12 | 27 | 33 | 49 | 31 | 214 | 10M22C8OMLOS | 250 |
| 18, 20 | 3/4 | M 22×1.5 | 1 3/16-12 | 27 | 15.5 | 12 | 30 | 37 | 50 | 31 | 322 | 12M22C8OMLOS | 250 |
| 18, 20 | 3/4 | M 27×2.0 | 1 3/16-12 | 32 | 15.5 | 15 | 30 | 37 | 56 | 35 | 440 | 12M27C8OMLOS | 250 |
| 25 | 1 | M 33×2.0 | 1 7/16-12 | 38 | 20.5 | 20 | 36 | 42 | 59 | 39 | 501 | 16M33C8OMLOS | 140 |
| 28, 30, 32 | 1 1/4 | M 42×2.0 | 1 11/16-12 | 50 | 26.0 | 26 | 41 | 45 | 63 | 42 | 561 | 20M42C8OMLOS | 140 |
| 35, 38 | 1 1/2 | M 48×2.0 | 2-12 | 55 | 32.0 | 32 | 50 | 49 | 72 | 47 | 684 | 24M48C8OMLOS | 140 |

Product delivered with NBR TRAP seal. Replacement of TRAP seal is with a standard NBR O-ring – see page J73-J74.

Part numbers shown are part of our current manufacturing programme.

Imperial and metric parts may vary in hexagon dimensions.

$$\frac{\text{PN (bar)}}{10} = \text{PN (MPa)}$$

Do not create drawings from these dimensions, they are subject to change and ISO manufacturing allowances.

*JJ may vary in stainless steel

CLO Male stud elbow

O-Lok® ORFS tube end / Male NPTF* thread (SAE J476)

*Stainless Steel = NPT to prevent galling

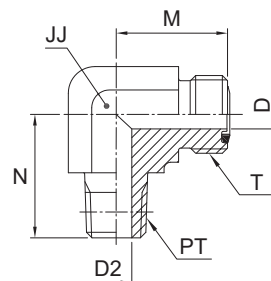

| Tube O.D. | | Thread NPTF PT | Thread UN/UNF-2A T | D mm | D2 mm | JJ* mm | M mm | N mm | Weight (steel) g/1 piece | O-Lok® Steel | O-Lok® Stainless Steel | PN (bar) | |
|------------|-------|----------------|--------------------|------|-------|--------|------|------|--------------------------|--------------------|------------------------|----------|-----|
| mm | in. | | | | | | | | | | | S | SS |
| 6 | 1/4 | 1/8-27 | 9/16-18 | 4.5 | 4.8 | 14 | 22 | 20 | 39 | 4 CLO-S | 4 CLO-SS | 420 | 420 |
| 6 | 1/4 | 1/4-18 | 9/16-18 | 4.5 | 7.1 | 14 | 22 | 28 | 50 | 4-4 CLO-S | 4-4 CLO-SS | 420 | 420 |
| 8, 10 | 3/8 | 1/4-18 | 11/16-16 | 6.5 | 7.1 | 19 | 25 | 28 | 75 | 6 CLO-S | 6 CLO-SS | 420 | 420 |
| 8, 10 | 3/8 | 3/8-18 | 11/16-16 | 6.5 | 10.3 | 19 | 25 | 31 | 81 | 6-6 CLO-S | 6-6 CLO-SS | 420 | 420 |
| 8, 10 | 3/8 | 1/2-14 | 11/16-16 | 6.5 | 13.5 | 22 | 29 | 37 | 84 | 6-8 CLO-S | 6-8 CLO-SS | 420 | 420 |
| 12 | 1/2 | 3/8-18 | 13/16-16 | 9.5 | 10.3 | 19 | 28 | 31 | 89 | 8 CLO-S | 8 CLO-SS | 420 | 420 |
| 12 | 1/2 | 1/2-14 | 13/16-16 | 9.5 | 13.5 | 22 | 28 | 37 | 125 | 8-8 CLO-S | 8-8 CLO-SS | 420 | 420 |
| 12 | 1/2 | 3/4-14 | 13/16-16 | 9.5 | 18.3 | 27 | 34 | 40 | 168 | 8-12 CLO-S | 8-12 CLO-SS | 280 | 280 |
| 14, 15, 16 | 5/8 | 1/2-14 | 1-14 | 12.5 | 13.5 | 27 | 33 | 37 | 154 | 10 CLO-S | 10 CLO-SS | 420 | 420 |
| 14, 15, 16 | 5/8 | 3/4-14 | 1-14 | 12.5 | 18.3 | 27 | 36 | 40 | 237 | 10-12 CLO-S | 10-12 CLO-SS | 280 | 280 |
| 18, 20 | 3/4 | 3/4-14 | 1 3/16-12 | 15.5 | 18.3 | 30 | 37 | 40 | 246 | 12 CLO-S | 12 CLO-SS | 280 | 280 |
| 18, 20 | 3/4 | 1/2-14 | 1 3/16-12 | 15.5 | 13.5 | 30 | 37 | 40 | 257 | 12-8 CLO-S | 12-8 CLO-SS | 420 | 420 |
| 18, 20 | 3/4 | 1-11.5 | 1 3/16-12 | 15.5 | 23.8 | 33 | 41 | 50 | 363 | 12-16 CLO-S | 12-16 CLO-SS | 210 | 210 |
| 25 | 1 | 1-11.5 | 1 7/16-12 | 20.5 | 23.8 | 36 | 42 | 50 | 387 | 16 CLO-S | 16 CLO-SS | 210 | 210 |
| 25 | 1 | 3/4-14 | 1 7/16-12 | 20.5 | 18.3 | 36 | 42 | 45 | 401 | 16-12 CLO-S | 16-12 CLO-SS | 280 | 280 |
| 28, 30, 32 | 1 1/4 | 1 1/4-11.5 | 1 11/16-12 | 26.0 | 31.8 | 41 | 45 | 61 | 469 | 20 CLO-S | 20 CLO-SS | 175 | 175 |
| 35, 38 | 1 1/2 | 1 1/2-11.5 | 2-12 | 32.0 | 38.1 | 48 | 49 | 67 | 603 | 24 CLO-S | 24 CLO-SS | 175 | 175 |

Product delivered with NBR TRAP seal. Replacement of TRAP seal is with a standard NBR O-ring – see page J73-J74.

Part numbers shown are part of our current manufacturing programme.

Imperial and metric parts may vary in hexagon dimensions.

$\frac{\text{PN (bar)}}{10} = \text{PN (MPa)}$

Do not create drawings from these dimensions, they are subject to change and ISO manufacturing allowances.

*JJ may vary in stainless steel

J

O-Lok®

V87OMLO 45° male stud elbow

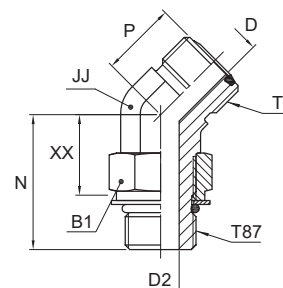
 O-Lok® ORFS tube end / Male metric thread – O-ring (ISO 6149-2)
 SAE 52M0387 ISO 8434-3 SDE45

| Tube O.D. | | Thread metric T87 | Thread UN/UNF-2A T | B1 | D | D2 | JJ* | P | N | XX | Weight (steel) g/1 piece | O-Lok® Steel | O-Lok® Stainless Steel | PN (bar) | |
|------------|-------|-------------------|--------------------|----|------|----|-----|----|----|----|--------------------------|----------------------|------------------------|----------|-----|
| mm | in. | | | mm | mm | mm | mm | mm | mm | mm | | | | S | SS |
| 6 | 1/4 | M 12×1.5 | 9/16-18 | 17 | 4.5 | 4 | 14 | 16 | 30 | 19 | 44 | 4M12V87OMLOS | 4M12V87OMLOSS | 420 | 420 |
| 8, 10 | 3/8 | M 16×1.5 | 11/16-16 | 22 | 6.5 | 7 | 19 | 19 | 33 | 20 | 82 | 6M16V87OMLOS | 6M16V87OMLOSS | 420 | 420 |
| 12 | 1/2 | M 18×1.5 | 13/16-16 | 24 | 9.5 | 9 | 19 | 20 | 37 | 22 | 110 | 8M18V87OMLOS | 8M18V87OMLOSS | 420 | 420 |
| 14, 15, 16 | 5/8 | M 22×1.5 | 1-14 | 27 | 12.5 | 12 | 27 | 23 | 44 | 29 | 190 | 10M22V87OMLOS | 10M22V87OMLOSS | 420 | 420 |
| 18, 20 | 3/4 | M 27×2.0 | 1 3/16-12 | 32 | 15.5 | 15 | 30 | 26 | 50 | 31 | 288 | 12M27V87OMLOS | 12M27V87OMLOSS | 420 | 420 |
| 25 | 1 | M 33×2.0 | 1 7/16-12 | 41 | 20.5 | 20 | 36 | 30 | 52 | 33 | 300 | 16M33V87OMLOS | 16M33V87OMLOSS | 420 | 420 |
| 28, 30, 32 | 1 1/4 | M 42×2.0 | 1 11/16-12 | 50 | 26.0 | 26 | 41 | 32 | 54 | 35 | 444 | 20M42V87OMLOS | 20M42V87OMLOSS | 280 | 280 |
| 35, 38 | 1 1/2 | M 48×2.0 | 2-12 | 55 | 32.0 | 32 | 50 | 37 | 56 | 35 | 569 | 24M48V87OMLOS | 24M48V87OMLOSS | 280 | — |

Product delivered with NBR TRAP seal. Replacement of TRAP seal is with a standard NBR O-ring – see page J73-J74.

Part numbers shown are part of our current manufacturing programme.

Imperial and metric parts may vary in hexagon dimensions.

$$\frac{\text{PN (bar)}}{10} = \text{PN (MPa)}$$

Do not create drawings from these dimensions, they are subject to change and ISO manufacturing allowances.

*JJ may vary in stainless steel

V50MLO 45° male stud elbow

O-Lok® ORFS tube end / Adjustable UN/UNF thread O-ring (ISO 11926)
SAE 520320

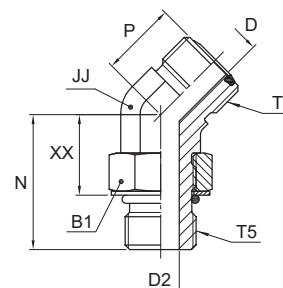

| Tube O.D. | | Thread UN/UNF-2A T5 | Thread UN/UNF-2A T | B1 | D | D2 | JJ* | P | N | XX | Weight (steel) g/1 piece | O-Lok® Steel | O-Lok® Stainless Steel | PN (bar) | |
|------------|-------|---------------------|--------------------|----|------|------|-----|----|----|----|--------------------------|----------------------|------------------------|----------|-----|
| mm | in. | | | mm | mm | mm | mm | mm | mm | mm | | | | S | SS |
| 6 | 1/4 | 7/16-20 | 9/16-18 | 17 | 4.5 | 4.5 | 14 | 16 | 30 | 19 | 45 | 4 V50LO-S | 4V50MLOSS | | 420 |
| 6 | 1/4 | 7/16-20 | 9/16-18 | 16 | 4.5 | 4.5 | 14 | 16 | 30 | 19 | 45 | 4-6 V50LO-S | 4-6V50MLOSS | 630 | 420 |
| 6 | 1/4 | 9/16-18 | 9/16-18 | 19 | 4.5 | 7.5 | 19 | 17 | 33 | 20 | 76 | 6 V50LO-S | 6V50MLOSS | 630 | 420 |
| 8, 10 | 3/8 | 9/16-18 | 11/16-16 | 19 | 6.5 | 7.5 | 19 | 19 | 33 | 20 | 83 | 6-4 V50LO-S | 6-4V50MLOSS | 630 | 420 |
| 8, 10 | 3/8 | 7/16-20 | 11/16-16 | 16 | 6.5 | 4.5 | 19 | 19 | 31 | 20 | 64 | 6-8 V50LO-S | 6-8V50MLOSS | 630 | 420 |
| 8, 10 | 3/8 | 3/4-16 | 11/16-16 | 24 | 6.5 | 10.0 | 19 | 19 | 36 | 22 | 96 | 8 V50LO-S | 8V50MLOSS | 630 | 420 |
| 12 | 1/2 | 3/4-16 | 13/16-16 | 24 | 9.5 | 10.0 | 19 | 20 | 36 | 23 | 117 | 8-6 V50LO-S | 8-6V50MLOSS | 630 | 420 |
| 12 | 1/2 | 9/16-18 | 13/16-16 | 19 | 9.5 | 7.5 | 19 | 20 | 32 | 20 | 71 | 8-10 V50LO-S | 8-10V50MLOSS | 420 | 420 |
| 12 | 1/2 | 7/8-14 | 13/16-16 | 27 | 9.5 | 12.5 | 19 | 21 | 45 | 22 | 147 | 10 V50LO-S | 10V50MLOSS | 420 | 420 |
| 14, 15, 16 | 5/8 | 7/8-14 | 1-14 | 27 | 12.5 | 12.5 | 27 | 23 | 45 | 28 | 194 | 10-8 V50LO-S | 10-8V50MLOSS | 420 | 420 |
| 14, 15, 16 | 5/8 | 3/4-16 | 1-14 | 24 | 12.5 | 10.0 | 27 | 23 | 40 | 26 | 192 | 10-12 V50LO-S | 10-12V50MLOSS | 420 | 420 |
| 14, 15, 16 | 5/8 | 1 1/16-12 | 1-14 | 35 | 12.5 | 15.5 | 30 | 24 | 50 | 31 | 207 | 12V50MLO-S | 12V50MLOSS | 420 | 420 |
| 18, 20 | 3/4 | 1 1/16-12 | 1 3/16-12 | 35 | 15.5 | 15.5 | 30 | 26 | 50 | 31 | 294 | 12-10 V50LO-S | 12-10V50MLOSS | 420 | 420 |
| 18, 20 | 3/4 | 7/8-14 | 1 3/16-12 | 27 | 15.5 | 12.5 | 30 | 26 | 46 | 29 | 219 | 12-16 V50LO-S | 12-16V50MLOSS | 420 | 380 |
| 18, 20 | 3/4 | 1 5/16-12 | 1 3/16-12 | 41 | 15.5 | 21.5 | 36 | 30 | 52 | 33 | 322 | 16V50MLOS | 16V50MLOSS | 420 | 380 |
| 22, 25 | 1 | 1 5/16-12 | 1 7/16-12 | 41 | 20.5 | 21.5 | 36 | 30 | 52 | 33 | 394 | 16-12 V50LO-S | 16-12V50MLOSS | 420 | 420 |
| 22, 25 | 1 | 1 1/16-12 | 1 7/16-12 | 36 | 20.5 | 15.5 | 36 | 30 | 52 | 33 | 337 | 20 V50LO-S | 20V50MLOSS | 350 | 280 |
| 22, 25 | 1 | 1 1/16-12 | 1 7/16-12 | 35 | 20.5 | 15.5 | 36 | 30 | 52 | 33 | 337 | 24 V50LO-S | 24V50MLOSS | 280 | 280 |
| 22, 25 | 1 | 1 5/8-12 | 1 7/16-12 | 48 | 20.5 | 27.5 | 41 | 32 | 54 | 35 | 511 | | | | |
| 28, 30, 32 | 1 1/4 | 1 5/8-12 | 1 11/16-12 | 48 | 26.0 | 27.5 | 41 | 32 | 54 | 35 | 447 | | | | |
| 35, 38 | 1 1/2 | 1 7/8-12 | 2-12 | 54 | 32.0 | 33.5 | 48 | 37 | 54 | 35 | 571 | | | | |

J

Product delivered with NBR TRAP seal. Replacement of TRAP seal is with a standard NBR O-ring – see page J73-J74.

Part numbers shown are part of our current manufacturing programme.

Imperial and metric parts may vary in hexagon dimensions.

$$\frac{\text{PN (bar)}}{10} = \text{PN (MPa)}$$

Do not create drawings from these dimensions, they are subject to change and ISO manufacturing allowances.

*JJ may vary in stainless steel

O-Lok®

V40MLO 45° male stud elbow

O-Lok® ORFS tube end / Adjustable BSPP thread O-ring + retaining ring (ISO 1179)

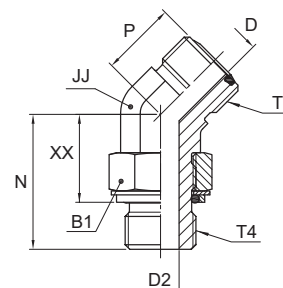

| Tube O.D. | | Thread BSPP T4 | Thread UN/UNF-2A T | B1 mm | D mm | D2 mm | JJ* mm | P mm | N mm | XX mm | Weight (steel) g/1 piece | O-Lok® | | PN (bar) | |
|------------|-------|----------------|--------------------|-------|------|-------|--------|------|------|-------|--------------------------|---------------------|----------------------|----------|-----|
| mm | in. | | | | | | | | | | | Steel | Stainless Steel | S | SS |
| 6 | 1/4 | 1/8-28 | 9/16-18 | 14 | 4.5 | 4.4 | 14 | 16 | 28 | 18 | 38 | 4V40MLOS | 4V40MLOSS | 250 | 250 |
| 6 | 1/4 | 1/4-19 | 9/16-18 | 19 | 4.5 | 7.5 | 19 | 17 | 33 | 22 | 43 | 4-4V40MLOS | 4-4V40MLOSS | 250 | 200 |
| 8, 10 | 3/8 | 1/4-19 | 11/16-16 | 19 | 6.5 | 7.5 | 19 | 19 | 32 | 20 | 83 | 6V40MLOS | 6V40MLOSS | 250 | 200 |
| 8, 10 | 3/8 | 3/8-19 | 11/16-16 | 22 | 6.5 | 9.9 | 19 | 19 | 34 | 22 | 95 | 6-6V40MLOS | 6-6V40MLOSS | 250 | 200 |
| 8, 10 | 3/8 | 1/2-14 | 11/16-16 | 27 | 6.5 | 12.3 | 27 | 19 | 43 | 29 | 107 | 6-8V40MLOS | 6-8V40MLOSS | 250 | 200 |
| 12 | 1/2 | 3/8-19 | 13/16-16 | 22 | 9.5 | 9.9 | 19 | 20 | 34 | 22 | 117 | 8V40MLOS | 8V40MLOSS | 250 | 200 |
| 12 | 1/2 | 1/2-14 | 13/16-16 | 27 | 9.5 | 12.3 | 27 | 21 | 43 | 30 | 196 | 8-8V40MLOS | 8-8V40MLOSS | 250 | 200 |
| 14, 15, 16 | 5/8 | 1/2-14 | 1-14 | 27 | 12.5 | 12.3 | 27 | 23 | 43 | 29 | 191 | 10V40MLOS | 10V40MLOSS | 250 | 200 |
| 14, 15, 16 | 5/8 | 3/4-14 | 1-14 | 36 | 12.5 | 15.5 | 30 | 24 | 46 | 32 | 227 | 10-12V40MLOS | 10-12V40MLOSS | 250 | 200 |
| 18, 20 | 3/4 | 3/4-14 | 1 3/16-12 | 36 | 15.5 | 15.5 | 30 | 26 | 46 | 32 | 294 | 12V40MLOS | 12V40MLOSS | 250 | 200 |
| 18, 20 | 3/4 | 1-11 | 1 3/16-12 | 41 | 15.5 | 21.5 | 36 | 30 | 51 | 34 | 325 | 12-16V40MLOS | 12-16V40MLOSS | 250 | 200 |
| 25 | 1 | 1-11 | 1 7/16-12 | 41 | 20.5 | 21.5 | 36 | 30 | 51 | 34 | 394 | 16V40MLOS | 16V40MLOSS | 250 | 200 |
| 28, 30, 32 | 1 1/4 | 1 1/4-11 | 1 11/16-12 | 50 | 26.0 | 27.5 | 41 | 32 | 52 | 37 | 430 | 20V40MLOS | 20V40MLOSS | 210 | 160 |
| 35, 38 | 1 1/2 | 1 1/2-11 | 2-12 | 55 | 32.0 | 33.0 | 50 | 37 | 52 | 37 | 551 | 24V40MLOS | 24V40MLOSS | 140 | 140 |

Product delivered with NBR TRAP seal. Replacement of TRAP seal is with a standard NBR O-ring – see page J73-J74.

Part numbers shown are part of our current manufacturing programme.

Imperial and metric parts may vary in hexagon dimensions.

$$\frac{PN \text{ (bar)}}{10} = PN \text{ (MPa)}$$

Do not create drawings from these dimensions, they are subject to change and ISO manufacturing allowances.

*JJ may vary in stainless steel

V8OMLO 45° male stud elbow

O-Lok® ORFS tube end / Male metric thread – O-ring + retaining ring

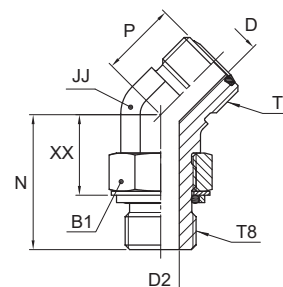

| Tube O.D. | | Thread metric T8 | Thread UN/UNF-2A T | B1 mm | D mm | D2 mm | JJ* mm | P mm | N mm | XX mm | Weight (steel) g/1 piece | O-Lok® Steel | PN (bar) |
|------------|-------|------------------|--------------------|-------|------|-------|--------|------|------|-------|--------------------------|---------------------|----------|
| mm | in. | | | | | | | | | | | | |
| 6 | 1/4 | M 12×1.5 | 9/16-18 | 17 | 4.5 | 4 | 14 | 16 | 30 | 19 | 44 | 4M12V8OMLOS | 250 |
| 10 | 3/8 | M 16×1.5 | 11/16-16 | 19 | 6.5 | 7 | 19 | 19 | 33 | 19 | 82 | 6M16V8OMLOS | 250 |
| 12 | 1/2 | M 14×1.5 | 13/16-16 | 17 | 9.5 | 6 | 19 | 20 | 32 | 21 | 92 | 8M14V8OMLOS | 250 |
| 12 | 1/2 | M 18×1.5 | 13/16-16 | 22 | 9.5 | 9 | 19 | 20 | 37 | 21 | 110 | 8M18V8OMLOS | 250 |
| 14, 15, 16 | 5/8 | M 18×1.5 | 1-14 | 22 | 12.5 | 9 | 27 | 24 | 43 | 27 | 160 | 10M18V8OMLOS | 250 |
| 14, 15, 16 | 5/8 | M 22×1.5 | 1-14 | 27 | 12.5 | 12 | 27 | 23 | 44 | 27 | 190 | 10M22V8OMLOS | 250 |
| 18, 20 | 3/4 | M 27×2.0 | 1 3/16-12 | 32 | 15.5 | 15 | 30 | 26 | 50 | 30 | 288 | 12M27V8OMLOS | 250 |
| 25 | 1 | M 33×2.0 | 1 7/16-12 | 38 | 20.5 | 20 | 36 | 30 | 52 | 32 | 300 | 16M33V8OMLOS | 140 |
| 28, 30, 32 | 1 1/4 | M 42×2.0 | 1 11/16-12 | 50 | 26.0 | 26 | 41 | 32 | 54 | 33 | 444 | 20M42V8OMLOS | 140 |
| 35, 38 | 1 1/2 | M 48×2.0 | 2-12 | 55 | 32.0 | 32 | 50 | 37 | 56 | 32 | 568 | 24M48V8OMLOS | 140 |

Product delivered with NBR TRAP seal. Replacement of TRAP seal is with a standard NBR O-ring – see page J73-J74.

Part numbers shown are part of our current manufacturing programme.

Imperial and metric parts may vary in hexagon dimensions.

$$\frac{\text{PN (bar)}}{10} = \text{PN (MPa)}$$

Do not create drawings from these dimensions, they are subject to change and ISO manufacturing allowances.

*JJ may vary in stainless steel

J

O-Lok®

S87OMLO Male stud branch tee

O-Lok® ORFS tube ends / Adjustable metric thread – O-ring (ISO 6149)
 SAE 52M0489 ISO 8434-3 SDBT

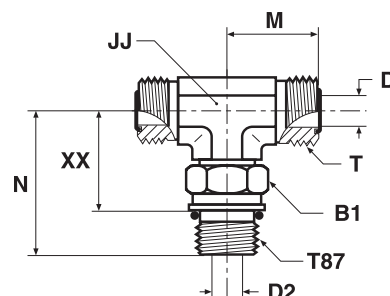

| Tube O.D. | | Thread metric T87 | Thread UN/UNF-2A T | B1 mm | D mm | D2 mm | JJ* mm | M mm | N mm | XX mm | Weight (steel) g/1 piece | O-Lok® | | PN (bar) | |
|------------|-------|-------------------|--------------------|-------|------|-------|--------|------|------|-------|--------------------------|---------------|------------------------|----------|-----|
| mm | in. | | | | | | | | | | | O-Lok® Steel | O-Lok® Stainless Steel | S | SS |
| 6 | 1/4 | M 12×1.5 | 9/16-18 | 17 | 4.5 | 4 | 14 | 22 | 33 | 21 | 66 | 4M12S87OMLOS | 4M12S87OMLOSS | 420 | 420 |
| 8, 10 | 3/8 | M 16×1.5 | 11/16-16 | 22 | 6.5 | 7 | 19 | 25 | 37 | 24 | 131 | 6M16S87OMLOS | 6M16S87OMLOSS | 420 | 420 |
| 12 | 1/2 | M 18×1.5 | 13/16-16 | 24 | 9.5 | 9 | 19 | 28 | 41 | 26 | 187 | 8M18S87OMLOS | 8M18S87OMLOSS | 420 | 420 |
| 14, 15, 16 | 5/8 | M 22×1.5 | 1-14 | 27 | 12.5 | 12 | 27 | 33 | 49 | 33 | 283 | 10M22S87OMLOS | 10M22S87OMLOSS | 420 | 420 |
| 18, 20 | 3/4 | M 27×2.0 | 1 3/16-12 | 32 | 15.5 | 15 | 30 | 37 | 55 | 36 | 549 | 12M27S87OMLOS | 12M27S87OMLOSS | 420 | 420 |
| 25 | 1 | M 33×2.0 | 1 7/16-12 | 41 | 20.5 | 20 | 36 | 42 | 59 | 41 | 565 | 16M33S87OMLOS | 16M33S87OMLOSS | 420 | 420 |
| 28, 30, 32 | 1 1/4 | M 42×2.0 | 1 11/16-12 | 50 | 26.0 | 26 | 41 | 45 | 62 | 43 | 824 | 20M42S87OMLOS | 20M42S87OMLOSS | 280 | 280 |
| 35, 38 | 1 1/2 | M 48×2.0 | 2-12 | 55 | 32.0 | 32 | 48 | 49 | 69 | 50 | 940 | 24M48S87OMLOS | 24M48S87OMLOSS | 280 | — |

Product delivered with NBR TRAP seal. Replacement of TRAP seal is with a standard NBR O-ring – see page J73-J74.

Part numbers shown are part of our current manufacturing programme.

Imperial and metric parts may vary in hexagon dimensions.

$$\frac{\text{PN (bar)}}{10} = \text{PN (MPa)}$$

Do not create drawings from these dimensions, they are subject to change and ISO manufacturing allowances.

*JJ may vary in stainless steel

S50MLO Male stud branch tee

O-Lok® ORFS tube end / Adjustable UN/UNF thread O-ring (ISO 11926)
SAE 520429

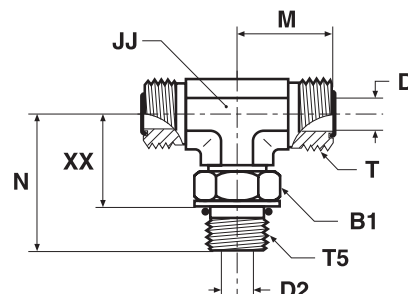

| Tube O.D. | | Thread UN/UNF-2A T5 | Thread UN/UNF-2A T | B1 | D | D2 | JJ* | M | N | XX | Weight (steel) | O-Lok® Steel | O-Lok® Stainless Steel | PN (bar) | |
|------------|-------|---------------------|--------------------|----|------|------|-----|----|----|----|----------------|-------------------|------------------------|----------|-----|
| mm | in. | | | mm | mm | mm | mm | mm | mm | mm | g/1 piece | | | S | SS |
| 6 | 1/4 | 7/16-20 | 9/16-18 | 16 | 4.5 | 4.5 | 14 | 22 | 33 | 21 | 67 | 4 S50LO-S | 4 S50LO-SS | 420 | 420 |
| 8, 10 | 3/8 | 9/16-18 | 11/16-16 | 19 | 6.5 | 7.5 | 19 | 25 | 37 | 24 | 131 | 6S50MLOS | 6 S50LO-SS | 420 | 420 |
| 12 | 1/2 | 3/4-16 | 13/16-16 | 24 | 9.5 | 10.0 | 19 | 28 | 41 | 26 | 187 | 8 S50LO-S | 8 S50LO-SS | 420 | 420 |
| 14, 15, 16 | 5/8 | 7/8-14 | 1-14 | 27 | 12.5 | 12.5 | 27 | 33 | 50 | 33 | 279 | 10 S50LO-S | 10 S50LO-SS | 420 | 420 |
| 18, 20 | 3/4 | 1 1/16-12 | 1 3/16-12 | 35 | 15.5 | 15.5 | 30 | 37 | 55 | 36 | 441 | 12 S50LO-S | 12 S50LO-SS | 420 | 420 |
| 25 | 1 | 1 5/16-12 | 1 7/16-12 | 41 | 20.5 | 21.5 | 37 | 42 | 60 | 41 | 539 | 16 S50LO-S | 16 S50LO-SS | 380 | 380 |
| 28, 30, 32 | 1 1/4 | 1 5/8-12 | 1 11/16-12 | 48 | 26.0 | 27.5 | 41 | 45 | 62 | 43 | 851 | 20 S50LO-S | | 280 | — |
| 35, 38 | 1 1/2 | 1 7/8-12 | 2-12 | 54 | 32.0 | 33.5 | 48 | 49 | 66 | 47 | 942 | 24 S50LO-S | | 280 | — |

Product delivered with NBR TRAP seal. Replacement of TRAP seal is with a standard NBR O-ring – see page J73-J74.

Part numbers shown are part of our current manufacturing programme.

Imperial and metric parts may vary in hexagon dimensions.

$$\frac{\text{PN (bar)}}{10} = \text{PN (MPa)}$$

Do not create drawings from these dimensions, they are subject to change and ISO manufacturing allowances.

*JJ may vary in stainless steel.

J

O-Lok®

S40MLO Male stud branch tee

O-Lok® ORFS tube end / Adjustable BSPP thread O-ring + retaining ring (ISO 1179)

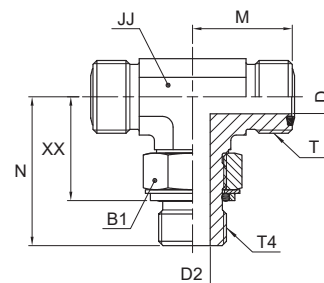

| Tube O.D. | | Thread BSPP T4 | Thread UN/UNF-2A T | B1 mm | D mm | D2 mm | JJ* mm | M mm | N mm | XX mm | Weight (steel) g/1 piece | O-Lok® | O-Lok® | PN (bar) | |
|------------|-------|----------------|--------------------|-------|------|-------|--------|------|------|-------|--------------------------|------------------------|-------------------------|----------|-----|
| mm | in. | | | | | | | | | | | Steel | Stainless Steel | S | SS |
| 6 | 1/4 | 1/8-28 | 9/16-18 | 14 | 4.5 | 4.4 | 14 | 22 | 30 | 21 | 69 | 4S40MLOS | 4S40MLOSS | 250 | 250 |
| 6 | 1/4 | 1/4-19 | 9/16-18 | 19 | 4.5 | 7.5 | 19 | 24 | 36 | 25 | 97 | 4-4-4S40MLOS | 4-4-4S40MLOSS | 250 | 200 |
| 8, 10 | 3/8 | 1/4-19 | 11/16-16 | 19 | 6.5 | 7.5 | 19 | 25 | 36 | 25 | 127 | 6S40MLOS | 6S40MLOSS | 250 | 200 |
| 8, 10 | 3/8 | 3/8-19 | 11/16-16 | 22 | 6.5 | 9.9 | 19 | 27 | 38 | 27 | 126 | 6-6-6S40MLOS | 6-6-6S40MLOSS | 250 | 200 |
| 12 | 1/2 | 3/8-19 | 13/16-16 | 22 | 9.5 | 9.9 | 19 | 28 | 38 | 27 | 146 | 8S40MLOS | 8S40MLOSS | 250 | 200 |
| 12 | 1/2 | 1/2-14 | 13/16-16 | 27 | 9.5 | 12.3 | 27 | 31 | 49 | 35 | 174 | 8-8-8S40MLOS | 8-8-8S40MLOSS | 250 | 200 |
| 14, 15, 16 | 5/8 | 1/2-14 | 1-14 | 27 | 12.5 | 12.3 | 27 | 33 | 49 | 35 | 288 | 10S40MLOS | 10S40MLOSS | 250 | 200 |
| 14, 15, 16 | 5/8 | 3/4-14 | 1-14 | 36 | 12.5 | 15.5 | 30 | 36 | 52 | 38 | 314 | 10-10-12S40MLOS | 10-10-12S40MLOSS | 250 | 200 |
| 18, 20 | 3/4 | 3/4-14 | 1 3/16-12 | 36 | 15.5 | 15.5 | 30 | 37 | 52 | 38 | 531 | 12S40MLOS | 12S40MLOSS | 250 | 200 |
| 22, 25 | 1 | 1-11 | 1 7/16-12 | 41 | 20.5 | 21.5 | 36 | 42 | 58 | 42 | 600 | 16S40MLOS | 16S40MLOSS | 250 | 200 |
| 28, 30, 32 | 1 1/4 | 1 1/4-11 | 1 11/16-12 | 50 | 26.0 | 27.5 | 41 | 45 | 61 | 45 | 850 | 20S40MLOS | 20S40MLOSS | 210 | 160 |
| 35, 38 | 1 1/2 | 1 1/2-11 | 2-12 | 55 | 32.0 | 33.0 | 50 | 49 | 65 | 50 | 940 | 24S40MLOS | 24S40MLOSS | 140 | — |

Product delivered with NBR TRAP seal. Replacement of TRAP seal is with a standard NBR O-ring – see page J73-J74.

Part numbers shown are part of our current manufacturing programme.

Imperial and metric parts may vary in hexagon dimensions.

$$\frac{\text{PN (bar)}}{10} = \text{PN (MPa)}$$

Do not create drawings from these dimensions, they are subject to change and ISO manufacturing allowances.

*JJ may vary in stainless steel.

S8OMLO Male stud branch tee

O-Lok® ORFS tube end / Adjustable metric thread – O-ring + retaining ring

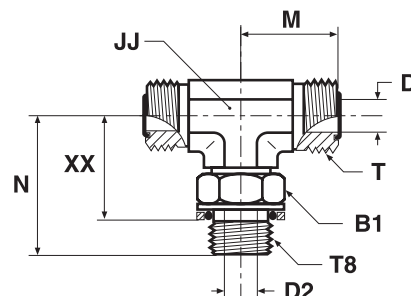

| Tube O.D. | | Thread metric T8 | Thread UN/UNF-2A T | B1 mm | D mm | D2 mm | JJ* mm | M mm | N mm | XX mm | Weight (steel) g/1 piece | O-Lok® Steel | PN (bar) |
|------------|-------|------------------|--------------------|-------|------|-------|--------|------|------|-------|--------------------------|---------------------|----------|
| mm | in. | | | | | | | | | | | | |
| 6 | 1/4 | M 12×1.5 | 9/16-18 | 17 | 4.5 | 4 | 14 | 22 | 33 | 22 | 66 | 4M12S8OMLOS | 250 |
| 8, 10 | 3/8 | M 16×1.5 | 11/16-16 | 19 | 6.5 | 7 | 19 | 25 | 38 | 24 | 131 | 6M16S8OMLOS | 250 |
| 12 | 1/2 | M 18×1.5 | 13/16-16 | 22 | 9.5 | 9 | 19 | 28 | 41 | 25 | 187 | 8M18S8OMLOS | 250 |
| 14, 15, 16 | 5/8 | M 22×1.5 | 1-14 | 27 | 12.5 | 12 | 27 | 33 | 49 | 31 | 283 | 10M22S8OMLOS | 250 |
| 18, 20 | 3/4 | M 27×2.0 | 1 3/16-12 | 32 | 15.5 | 15 | 30 | 37 | 55 | 35 | 550 | 12M27S8OMLOS | 250 |
| 25 | 1 | M 33×2.0 | 1 7/16-12 | 38 | 20.5 | 20 | 36 | 42 | 59 | 39 | 566 | 16M33S8OMLOS | 140 |
| 28, 30, 32 | 1 1/4 | M 42×2.0 | 1 11/16-12 | 50 | 26.0 | 26 | 41 | 45 | 62 | 41 | 824 | 20M42S8OMLOS | 140 |
| 35, 38 | 1 1/2 | M 48×2.0 | 2-12 | 55 | 32.0 | 32 | 48 | 49 | 72 | 47 | 940 | 24M48S8OMLOS | 140 |

Product delivered with NBR TRAP seal. Replacement of TRAP seal is with a standard NBR O-ring – see page J73-J74.

Part numbers shown are part of our current manufacturing programme.

Imperial and metric parts may vary in hexagon dimensions.

$$\frac{\text{PN (bar)}}{10} = \text{PN (MPa)}$$

Do not create drawings from these dimensions, they are subject to change and ISO manufacturing allowances.

*JJ may vary in stainless steel.

J

O-Lok®

R87OMLO Male stud run tee

O-Lok® ORFS tube ends / Adjustable metric thread – O-ring (ISO 6149)
 SAE 52M0488 ISO 8434-3 SDRT

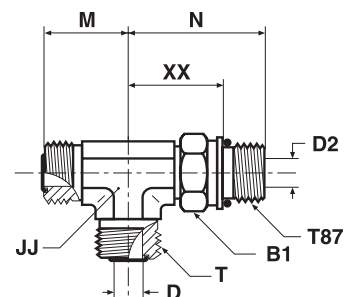

| Tube O.D. | | Thread metric T87 | Thread UN/UNF-2A T | B1 mm | D mm | D2 mm | JJ* mm | M mm | N mm | XX mm | Weight (steel) g/1 piece | O-Lok® | | PN (bar) | |
|------------|-------|-------------------|--------------------|-------|------|-------|--------|-----------------|------|-------|--------------------------|---------------|------------------------|----------|-----|
| mm | in. | | | | | | | | | | | O-Lok® Steel | O-Lok® Stainless Steel | S | SS |
| 6 | 1/4 | M 12×1.5 | 9/16-18 | 17 | 4.5 | 4 | 14 | 22 | 33 | 21 | 66 | 4M12R87OMLOS | 4M12R87OMLOSS | 420 | 420 |
| 6 | 1/4 | M 14×1.5 | 11/16-16 | 19 | 6.5 | 6 | 19 | 25 | 36 | 21 | 129 | 6M14R87OMLOS | 6M14R87OMLOSS | 420 | 420 |
| 8, 10 | 3/8 | M 16×1.5 | 11/16-16 | 22 | 6.5 | 7 | 19 | 25 | 38 | 24 | 131 | 6M16R87OMLOS | 6M16R87OMLOSS | 420 | 420 |
| 12 | 1/2 | M 18×1.5 | 13/16-16 | 24 | 9.5 | 9 | 19 | 28 | 41 | 26 | 187 | 8M18R87OMLOS | 8M18R87OMLOSS | 420 | 420 |
| 14, 15, 16 | 5/8 | M 22×1.5 | 1-14 | 27 | 12.5 | 12 | 27 | 33 | 49 | 33 | 283 | 10M22R87OMLOS | 10M22R87OMLOSS | 420 | 420 |
| 18, 20 | 3/4 | M 27×2.0 | 1 3/16-12 | 32 | 15.5 | 15 | 30 | 37 | 55 | 36 | 549 | 12M27R87OMLOS | 12M27R87OMLOSS | 420 | 420 |
| 25 | 1 | M 33×2.0 | 1 7/16-12 | 41 | 20.5 | 20 | 36 | 42 | 59 | 41 | 565 | 16M33R87OMLOS | 16M33R87OMLOSS | 420 | 420 |
| 28, 30, 32 | 1 1/4 | M 42×2.0 | 1 11/16-12 | 50 | 26.0 | 26 | 41 | 45 | 63 | 43 | 824 | 20M42R87OMLOS | 20M42R87OMLOSS | 280 | 280 |
| 35, 38 | 1 1/2 | M 48×2.0 | 2-12 | 55 | 32.0 | 32 | 48 | 49 [†] | 69 | 50 | 940 | 24M48R87OMLOS | 24M48R87OMLOSS | 280 | — |

Product delivered with NBR TRAP seal. Replacement of TRAP seal is with a standard NBR O-ring – see page J73-J74.

Part numbers shown are part of our current manufacturing programme.

Imperial and metric parts may vary in hexagon dimensions.

$\frac{\text{PN (bar)}}{10} = \text{PN (MPa)}$

Do not create drawings from these dimensions, they are subject to change and ISO manufacturing allowances.

*JJ may vary in stainless steel.

†M=52 in stainless steel.

R50MLO Male stud run tee

O-Lok® ORFS tube end / Adjustable UN/UNF thread O-ring (ISO 11926)
SAE 520428

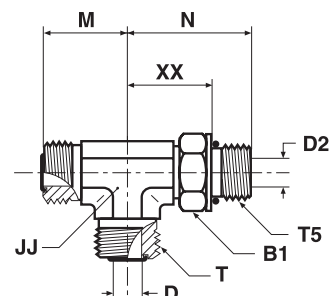

| Tube O.D. | | Thread UN/UNF-2A T5 | Thread UN/UNF-2A T | B1 | D | D2 | JJ* | M | N | XX | Weight (steel) | O-Lok® Steel | O-Lok® Stainless Steel | PN (bar) | |
|------------|-------|---------------------|--------------------|----|------|------|-----|------------------|----|----|----------------|-------------------------|--------------------------|----------|-----|
| mm | in. | | | mm | mm | mm | mm | mm | mm | mm | g/1 piece | | | S | SS |
| 6 | 1/4 | 7/16-20 | 9/16-18 | 16 | 4.5 | 4.5 | 14 | 22 | 33 | 21 | 67 | 4 R50LO-S | 4 R50LO-SS | 420 | 420 |
| 6 | 1/4 | 9/16-18 | 9/16-18 | 19 | 4.5 | 4.0 | 19 | 24 | 37 | 24 | 133 | 4-6-4R50MLOS | 4-6-4 R0LO-SS | 420 | 420 |
| 8, 10 | 3/8 | 9/16-18 | 11/16-16 | 19 | 6.5 | 6.5 | 19 | 25 | 37 | 24 | 131 | 6 R50LO-S | 6 R50LO-SS | 420 | 420 |
| 12 | 1/2 | 3/4-16 | 13/16-16 | 24 | 9.5 | 9.5 | 19 | 28 | 41 | 26 | 187 | 8 R50LO-S | 8 R50LO-SS | 420 | 420 |
| 12 | 1/2 | 7/8-14 | 13/16-16 | 27 | 9.5 | 12.5 | 27 | 32 | 50 | 26 | 286 | 8-10-8 R50LO-S | 8-10-8 R50LO-SS | 420 | 420 |
| 14, 15, 16 | 5/8 | 7/8-14 | 1-14 | 27 | 12.5 | 12.5 | 27 | 33 | 50 | 33 | 288 | 10 R50LO-S | 10 R50LO-SS | 420 | 420 |
| 18, 20 | 3/4 | 1 1/16-12 | 1 3/16-12 | 36 | 15.5 | 15.5 | 30 | 37 | 55 | 36 | 558 | 12R50MLOS | 12 R50LO-SS | 420 | 420 |
| 18, 20 | 3/4 | 1 5/16-12 | 1 3/16-12 | 41 | 15.5 | 21.5 | 36 | 41 | 60 | 41 | 560 | 12-16-12 R50LO-S | 12-16-12 R50LO-SS | 380 | 380 |
| 25 | 1 | 1 5/16-12 | 1 7/16-12 | 41 | 20.5 | 20.5 | 36 | 42 | 60 | 41 | 566 | 16 R50LO-S | 16 R50LO-SS | 380 | 380 |
| 28, 30, 32 | 1 1/4 | 1 5/8-12 | 1 11/16-12 | 48 | 26.0 | 27.5 | 41 | 45 | 62 | 43 | 825 | 20 R50LO-S | 20 R50LO-SS | 280 | 280 |
| 35, 38 | 1 1/2 | 1 7/8-12 | 2-12 | 54 | 32.0 | 32.0 | 48 | 49 ¹¹ | 66 | 47 | 942 | 24 R50LO-S | 24 R50LO-SS | 280 | 280 |

Product delivered with NBR TRAP seal. Replacement of TRAP seal is with a standard NBR O-ring – see page J73-J74.

Part numbers shown are part of our current manufacturing programme.

Imperial and metric parts may vary in hexagon dimensions.

$$\frac{\text{PN (bar)}}{10} = \text{PN (MPa)}$$

Do not create drawings from these dimensions, they are subject to change and ISO manufacturing allowances.

*JJ may vary in stainless steel.

**M=52 in stainless steel.

J

O-Lok®
R40MLO Male stud run tee

O-Lok® ORFS tube ends / Adjustable BSPP thread O-ring + retaining ring (ISO 1179)

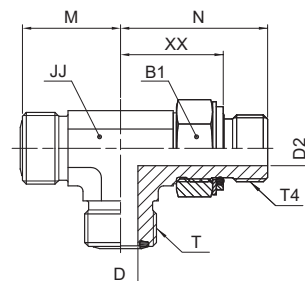

| Tube O.D. | | Thread BSPP T4 | Thread UN/UNF-2A T | B1 mm | D mm | D2 mm | JJ* mm | M mm | N mm | XX mm | Weight (steel) g/1 piece | O-Lok® | | PN (bar) | |
|------------|-------|----------------|--------------------|-------|------|-------|--------|------------------|------|-------|--------------------------|------------------------|-------------------------|----------|-----|
| mm | in. | | | | | | | | | | | Steel | Stainless Steel | S | SS |
| 6 | 1/4 | 1/8-28 | 9/16-18 | 14 | 4.5 | 4.5 | 14 | 22 | 30 | 20 | 69 | 4R40MLOS | 4R40MLOSS | 250 | 250 |
| 6 | 1/4 | 1/4-19 | 9/16-18 | 19 | 4.5 | 7.5 | 19 | 24 | 36 | 25 | 97 | 4-4-4R40MLOS | 4-4-4R40MLOSS | 250 | 200 |
| 8, 10 | 3/8 | 1/4-19 | 11/16-16 | 19 | 6.5 | 7.5 | 19 | 25 | 36 | 25 | 127 | 6R40MLOS | 6R40MLOSS | 250 | 200 |
| 8, 10 | 3/8 | 3/8-19 | 11/16-16 | 22 | 6.5 | 9.9 | 19 | 27 | 38 | 27 | 126 | 6-6-6R40MLOS | 6-6-6R40MLOSS | 250 | 200 |
| 12 | 1/2 | 3/8-19 | 13/16-16 | 22 | 9.5 | 9.9 | 19 | 28 | 38 | 27 | 146 | 8R40MLOS | 8R40MLOSS | 250 | 200 |
| 12 | 1/2 | 1/2-14 | 13/16-16 | 27 | 9.5 | 12.3 | 27 | 31 | 49 | 33 | 174 | 8-8-8R40MLOS | 8-8-8R40MLOSS | 250 | 200 |
| 14, 15, 16 | 5/8 | 1/2-14 | 1-14 | 27 | 12.5 | 12.3 | 27 | 33 | 49 | 33 | 288 | 10R40MLOS | 10R40MLOSS | 250 | 200 |
| 18, 20 | 3/4 | 3/4-14 | 1 3/16-12 | 36 | 15.5 | 15.5 | 30 | 37 | 52 | 36 | 531 | 12R40MLOS | 12R40MLOSS | 250 | 200 |
| 18, 20 | 3/4 | 1-11 | 1 3/16-12 | 41 | 15.5 | 21.5 | 36 | 41 | 58 | 40 | 559 | 12-16-12R40MLOS | 12-16-12R40MLOSS | 250 | 200 |
| 25 | 1 | 1-11 | 1 7/16-12 | 41 | 20.5 | 21.5 | 36 | 42 | 58 | 40 | 553 | 16R40MLOS | 16R40MLOSS | 250 | 200 |
| 28, 30, 32 | 1 1/4 | 1 1/4-11 | 1 11/16-12 | 50 | 26.0 | 27.5 | 41 | 45 | 61 | 42 | 824 | 20R40MLOS | 20R40MLOSS | 210 | 160 |
| 35, 38 | 1 1/2 | 1 1/2-11 | 2-12 | 55 | 32.0 | 32.0 | 50 | 49 ^{*1} | 65 | 48 | 940 | 24R40MLOS | 24R40MLOSS | 140 | — |

Product delivered with NBR TRAP seal. Replacement of TRAP seal is with a standard NBR O-ring – see page J73-J74.

Part numbers shown are part of our current manufacturing programme.

Imperial and metric parts may vary in hexagon dimensions.

$$\frac{\text{PN (bar)}}{10} = \text{PN (MPa)}$$

Do not create drawings from these dimensions, they are subject to change and ISO manufacturing allowances.

*JJ may vary in stainless steel.

 *¹M=52 in stainless steel.

R80MLO Male stud run tee

O-Lok® ORFS tube end / Adjustable metric thread – O-ring + retaining ring

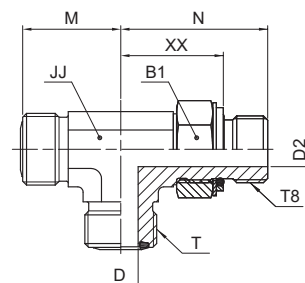

| Tube O.D. | | Thread metric T8 | Thread UN/UNF-2A T | B1 mm | D mm | D2 mm | JJ* mm | M mm | N mm | XX mm | Weight (steel) g/1 piece | O-Lok® Steel | PN (bar) |
|------------|-------|------------------|--------------------|-------|------|-------|--------|-----------------|------|-------|--------------------------|---------------------|----------|
| mm | in. | | | | | | | | | | | | |
| 6 | 1/4 | M 12×1.5 | 9/16-18 | 17 | 4.5 | 4 | 14 | 22 | 33 | 22 | 66 | 4M12R80MLOS | 250 |
| 8, 10 | 3/8 | M 16×1.5 | 11/16-16 | 19 | 6.5 | 7 | 19 | 25 | 38 | 24 | 131 | 6M16R80MLOS | 250 |
| 12 | 1/2 | M 18×1.5 | 13/16-16 | 22 | 9.5 | 9 | 19 | 28 | 41 | 25 | 187 | 8M18R80MLOS | 250 |
| 14, 15, 16 | 5/8 | M 22×1.5 | 1-14 | 27 | 12.5 | 12 | 27 | 33 | 49 | 31 | 283 | 10M22R80MLOS | 250 |
| 18, 20 | 3/4 | M 27×2.0 | 1 3/16-12 | 32 | 15.5 | 15 | 30 | 37 | 55 | 35 | 550 | 12M27R80MLOS | 250 |
| 25 | 1 | M 33×2.0 | 1 7/16-12 | 38 | 20.5 | 20 | 36 | 42 | 59 | 39 | 566 | 16M33R80MLOS | 140 |
| 28, 30, 32 | 1 1/4 | M 42×2.0 | 1 11/16-12 | 50 | 26.0 | 26 | 41 | 45 | 62 | 41 | 824 | 20M42R80MLOS | 140 |
| 35, 38 | 1 1/2 | M 48×2.0 | 2-12 | 55 | 32.0 | 32 | 48 | 49 ¹ | 72 | 47 | 940 | 24M48R80MLOS | 140 |

Product delivered with NBR TRAP seal. Replacement of TRAP seal is with a standard NBR O-ring – see page J73-J74.

Part numbers shown are part of our current manufacturing programme.

Imperial and metric parts may vary in hexagon dimensions.

$$\frac{\text{PN (bar)}}{10} = \text{PN (MPa)}$$

Do not create drawings from these dimensions, they are subject to change and ISO manufacturing allowances.

*JJ may vary in stainless steel.

¹M=52 in stainless steel.

J

O-Lok®

G87MLO Pressure gauge connector

O-Lok® ORFS tube end / Female metric thread – O-ring (ISO 6149-1) suitably for EMA link

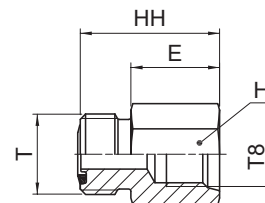

| Tube O.D. | | Thread metric T8 | Thread UN/UNF-2A T | E mm | H mm | HH mm | Weight (steel) g/1 piece | O-Lok® Steel | O-Lok® Stainless Steel | PN (bar) | |
|------------|-----|------------------|--------------------|------|------|-------|--------------------------|---------------------|------------------------|----------|-----|
| mm | in. | | | | | | | | | S | SS |
| 6 | 1/4 | M 14x1.5 | 9/16-18 | 19 | 19 | 29 | 20 | 4M14G87MLOS | 4M14G87MLOSS | 630 | 630 |
| 8, 10 | 3/8 | M 14x1.5 | 11/16-18 | 19 | 19 | 30 | 44 | 6M14G87MLOS | 6M14G87MLOSS | 630 | 630 |
| 12 | 1/2 | M 14x1.5 | 13/16-16 | 19 | 22 | 32 | 66 | 8M14G87MLOS | 8M14G87MLOSS | 630 | 630 |
| 14, 15, 16 | 5/8 | M 14x1.5 | 1-14 | 19 | 27 | 35 | 82 | 10M14G87MLOS | 10M14G87MLOSS | 420 | 420 |
| 18, 20 | 3/4 | M 14x1.5 | 1 3/16-12 | 19 | 32 | 36 | 104 | 12M14G87MLOS | 12M14G87MLOSS | 420 | 420 |

Product delivered with NBR TRAP seal. Replacement of TRAP seal is with a standard NBR O-ring – see page J73-J74.

Part numbers shown are part of our current manufacturing programme.

Imperial and metric parts may vary in hexagon dimensions.

$\frac{\text{PN (bar)}}{10} = \text{PN (MPa)}$

Do not create drawings from these dimensions, they are subject to change and ISO manufacturing allowances.

G4MLOSMO Pressure gauge connector

O-Lok® ORFS tube end / Female BSPP gauge thread (ISO 1179-1)

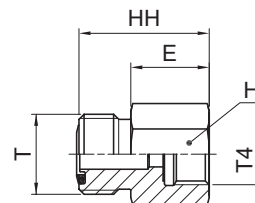

| Tube O.D. | | Thread BSPP T4 | Thread UN/UNF-2A T | E mm | H mm | HH mm | Weight (steel) g/1 piece | O-Lok® Steel | O-Lok® Stainless Steel | PN (bar) | |
|-----------|-----|----------------|--------------------|------|------|-------|--------------------------|--------------------|------------------------|----------|-----|
| mm | in. | | | | | | | | | S | SS |
| 6 | 1/4 | 1/4-19 | 9/16-18 | 18 | 17 | 27 | 32 | 4-4G4MLOSMO | 4-4G4MLOSSMO | 400 | 400 |
| 6 | 1/4 | 1/2-14 | 9/16-18 | 27 | 30 | 37 | 80 | 4-8G4MLOSMO | 4-8G4MLOSSMO | 400 | 400 |
| 8, 10 | 3/8 | 1/4-19 | 11/16-16 | 17 | 19 | 28 | 49 | 6G4MLOSMO | 6G4MLOSSMO | 400 | 400 |
| 8, 10 | 3/8 | 1/2-14 | 11/16-16 | 27 | 30 | 38 | 107 | 6-8G4MLOSMO | 6-8G4MLOSSMO | 400 | 400 |
| 12 | 1/2 | 1/4-19 | 13/16-16 | 17 | 22 | 30 | 60 | 8-4G4MLOSMO | 8-4G4MLOSSMO | 280 | 280 |
| 12 | 1/2 | 1/2-14 | 13/16-16 | 27 | 30 | 40 | 80 | 8-8G4MLOSMO | 8-8G4MLOSSMO | 280 | 280 |

Product delivered with NBR TRAP seal. Replacement of TRAP seal is with a standard NBR O-ring – see page J73-J74.

Part numbers shown are part of our current manufacturing programme.

Imperial and metric parts may vary in hexagon dimensions.

$$\frac{\text{PN (bar)}}{10} = \text{PN (MPa)}$$

Do not create drawings from these dimensions, they are subject to change and ISO manufacturing allowances.

J

O-Lok®

TT4ML Test point connector

O-Lok® ORFS swivel female end / Female BSPP thread (ISO 1179-1) for EMA3 test point

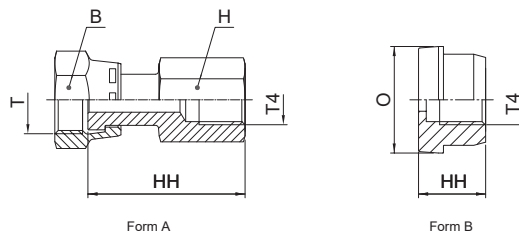

Form B has to be assembled with a nut BMLS/BLS.

| Thread UN/UNF-2B T | Thread BSPP T4 | O mm | B mm | H mm | HH mm | Weight (steel) g/1 piece | Form | O-Lok® | | PN (bar) | |
|--------------------------|----------------------|---------|---------|---------|----------|--------------------------------|------|----------------|------------------|----------|-----|
| | | | | | | | | Steel | Stainless Steel | S | SS |
| 9/16-18 | 1/4-19 | — | 17 | 19 | 38 | 60 | A | 4TT4MLS | 4TT4MLSS | 420 | 420 |
| 11/16-16 | 1/4-19 | — | 22 | 19 | 41 | 74 | A | 6TT4MLS | 6TT4MLSS | 420 | 420 |
| 13/16-16 | 1/4-19 | — | 24 | 19 | 43 | 91 | A | 8TT4MLS | 8TT4MLSS | 420 | 420 |
| — | 1/4-19 | 23 | — | — | 18 | 30 | B | 10TT4LS | 10TT4MLSS | 420 | 420 |
| — | 1/4-19 | 28 | — | — | 18 | 48 | B | 12TT4LS | 12TT4MLSS | 420 | 420 |
| — | 1/4-19 | 34 | — | — | 18 | 95 | B | 16TT4LS | 16TT4MLSS | 420 | 420 |
| — | 1/4-19 | 41 | — | — | 18 | 130 | B | 20TT4LS | 20TT4MLSS | 280 | 280 |
| — | 1/4-19 | 48 | — | — | 18 | 189 | B | 24TT4LS | 24TT4MLSS | 280 | 280 |

Part numbers shown are part of our current manufacturing programme.

Imperial and metric parts may vary in hexagon dimensions.

$$\frac{PN \text{ (bar)}}{10} = PN \text{ (MPa)}$$

Do not create drawings from these dimensions, they are subject to change and ISO manufacturing allowances.

TT8ML Test point connector

O-Lok® ORFS female swivel end / Metric female thread
(Metric female thread designed for use with EMA3 connections only)

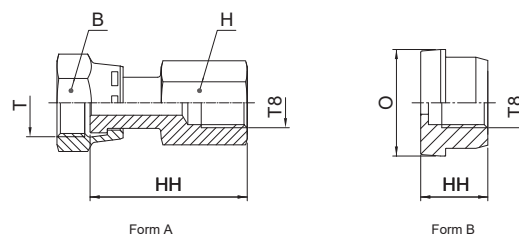

Form B has to be assembled with a nut BMLS/BLS.

| Thread UN/UNF-2B T | Thread metric T8 | O mm | B mm | H mm | HH mm | Weight (steel) g/1 piece | Form | O-Lok® Steel | O-Lok® Stainless Steel | PN (bar) | |
|--------------------------|------------------------|---------|---------|---------|----------|--------------------------------|------|-----------------|---------------------------|----------|-----|
| | | | | | | | | | | S | SS |
| 9/16-18 | M 10x1.0 | — | 17 | 19 | 38 | 86 | A | 4TT8MLS | 4TT8MLSS | 420 | 420 |
| 11/16-16 | M 10x1.0 | — | 22 | 19 | 39 | 86 | A | 6TT8MLS | 6TT8MLSS | 420 | 420 |
| 13/16-16 | M 10x1.0 | — | 24 | 19 | 43 | 123 | A | 8TT8MLS | 8TT8MLSS | 420 | 420 |
| — | M 10x1.0 | 23 | — | — | 16 | 40 | B | 10TT8LS | 10TT8LSS | 420 | 420 |
| — | M 10x1.0 | 28 | — | — | 16 | 60 | B | 12TT8LS | 12TT8LSS | 420 | 420 |
| — | M 10x1.0 | 34 | — | — | 16 | 85 | B | 16TT8LS | 16TT8LSS | 420 | 420 |
| — | M 10x1.0 | 41 | — | — | 16 | 133 | B | 20TT8LS | 20TT8LSS | 280 | 280 |
| — | M 10x1.0 | 48 | — | — | 16 | 193 | B | 24TT8LS | 24TT8LSS | 280 | 280 |

Part numbers shown are part of our current manufacturing programme.

Imperial and metric parts may vary in hexagon dimensions.

$$\frac{\text{PN (bar)}}{10} = \text{PN (MPa)}$$

Do not create drawings from these dimensions, they are subject to change and ISO manufacturing allowances.

J

O-Lok®

TTP4ML Test point connector

O-Lok® ORFS female swivel end / EMA3 test point

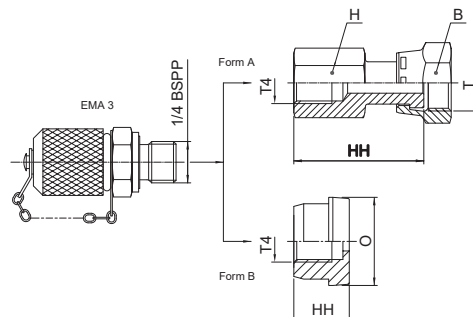

Form B versions delivered complete with BMLS nut.

| Thread UN/UNF-2B T | Thread BSPP T4 | O mm | B mm | H mm | HH mm | Weight (steel) g/1 piece | Form | O-Lok® Steel | PN (bar) |
|--------------------------|----------------------|---------|---------|---------|----------|--------------------------------|------|-----------------|-------------|
| 9/16-18 | 1/4-19 | — | 17 | 19 | 38 | 150 | A | 4TTP4MLS | 420 |
| 11/16-16 | 1/4-19 | — | 22 | 19 | 41 | 164 | A | 6TTP4MLS | 420 |
| 13/16-16 | 1/4-19 | — | 24 | 19 | 43 | 181 | A | 8TTP4MLS | 420 |
| — | 1/4-19 | 23 | 30 | — | 18 | 120 | B | 10TTP4LS | 420 |
| — | 1/4-19 | 28 | 36 | — | 18 | 138 | B | 12TTP4LS | 420 |
| — | 1/4-19 | 34 | 41 | — | 18 | 185 | B | 16TTP4LS | 420 |
| — | 1/4-19 | 41 | 50 | — | 18 | 200 | B | 20TTP4LS | 280 |
| — | 1/4-19 | 49 | 60 | — | 18 | 279 | B | 24TTP4LS | 280 |

O-Lok® is delivered with NBR elastomeric seals as standard. For more details on other seal materials see page J73-J74.

Part numbers shown are part of our current manufacturing programme.

Imperial and metric parts may vary in hexagon dimensions.

$$\frac{\text{PN (bar)}}{10} = \text{PN (MPa)}$$

Do not create drawings from these dimensions, they are subject to change and ISO manufacturing allowances.

R6P4MLO Test point connector

O-Lok® ORFS end / O-Lok® ORFS female swivel end / EMA3 test point

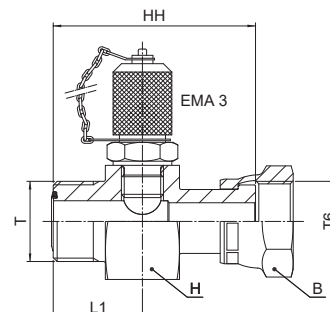

| Tube O.D. | | Thread UN/UNF-2A T | Thread UN/UNF-2B T6 | HH | L1 | H | B | Weight (steel) g/1 piece | O-Lok® Steel | PN (bar) |
|------------|-------|--------------------|---------------------|----|----|----|----|--------------------------|---------------------|----------|
| mm | in. | | | mm | mm | mm | mm | | | |
| 6 | 1/4 | 9/16-18 | 9/16-18 | 50 | 22 | 36 | 17 | 270 | 4-4R6P4MLOS | 420 |
| 8, 10 | 3/8 | 11/16-16 | 11/16-16 | 53 | 23 | 36 | 22 | 300 | 6-4R6P4MLOS | 420 |
| 12 | 1/2 | 13/16-16 | 13/16-16 | 58 | 25 | 36 | 24 | 308 | 8-4R6P4MLOS | 420 |
| 14, 15, 16 | 5/8 | 1-14 | 1-14 | 64 | 27 | 36 | 30 | 337 | 10-4R6P4MLOS | 420 |
| 18, 20 | 3/4 | 1 3/16-12 | 1 3/16-12 | 68 | 29 | 41 | 36 | 416 | 12-4R6P4MLOS | 420 |
| 22, 25 | 1 | 1 7/16-12 | 1 7/16-12 | 71 | 29 | 46 | 41 | 506 | 16-4R6P4MLOS | 420 |
| 28, 30, 32 | 1 1/4 | 1 11/16-12 | 1 11/16-12 | 73 | 29 | 50 | 50 | 691 | 20-4R6P4MLOS | 280 |
| 35, 38 | 1 1/2 | 2-12 | 2-12 | 74 | 29 | 60 | 60 | 995 | 24-4R6P4MLOS | 280 |

Product delivered with NBR TRAP seal. Replacement of TRAP seal is with a standard NBR O-ring – see page J73-J74.

Part numbers shown are part of our current manufacturing programme.

Imperial and metric parts may vary in hexagon dimensions.

$$\frac{\text{PN (bar)}}{10} = \text{PN (MPa)}$$

Do not create drawings from these dimensions, they are subject to change and ISO manufacturing allowances.

J

O-Lok®
LOHB3* Braze connector

O-Lok® ORFS tube end / Braze socket
 SAE 520104 / SAE 52M0104 ISO 8434-3 BRS
 (*Parts delivered oil dipped finish only – steel)

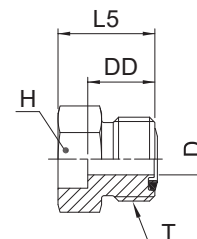

| Tube O.D. | | Thread UN/UNF-2A T | D mm | DD mm | H in. | H mm | L5 mm | Weight (steel) g/1 piece | O-Lok® Steel | O-Lok® Stainless Steel | | PN (bar) | |
|-----------|-----|--------------------|-----------|-------|--------|--------|-------|--------------------------|----------------------|------------------------|-----------------------|----------|-----|
| mm | in. | | | | | | | | | S | SS | S | SS |
| 6 | | 9/16-18 | 4.5 | 14 | — | 17 | 22 | 23 | 4-6MMLOHB3S | | 420 | — | |
| | | 1/4 | 4.5 | 13 | 5/8 | — | 22 | 24 | 4 LOHB3-S | 4 LOHB3-SS | 420 | 420 | |
| | | 3/8 | 4.5 | 13 | 5/8 | — | 22 | 23 | 4-6 LOHB3-S | 4-6 LOHB3-SS | 420 | 420 | |
| | | 3/8 | 11/16-16 | 6.5 | 14 | 3/4 | — | 23 | 36 | 6 LOHB3-S | 6 LOHB3-SS | 420 | 420 |
| | | 1/4 | 11/16-16 | 6.5 | 14 | 3/4 | — | 23 | 42 | 6-4 LOHB3-S | 6-4 LOHB3-SS | 420 | 420 |
| | | 1/2 | 11/16-16 | 6.5 | 14 | 3/4 | — | 23 | 36 | 6-8 LOHB3-S | 6-8 LOHB3-SS | 420 | 420 |
| | | 5/8 | 11/16-16 | 6.5 | 15 | 3/4 | — | 23 | 30 | 6-10 LOHB3-S | 6-10 LOHB3-SS | 420 | 420 |
| | | | 11/16-16 | 6.5 | 15 | — | 19 | 23 | 30 | 6-10MMLOHB3S | | 420 | — |
| 12 | | 13/16-16 | 9.5 | 16 | — | 22 | 25 | 42 | 8-12MMLOHB3S | | 420 | — | |
| | | 1/2 | 9.5 | 16 | 7/8 | — | 25 | 44 | 8 LOHB3-S | 8 LOHB3-SS | 420 | 420 | |
| | | 1/4 | 9.5 | 16 | 7/8 | — | 25 | 58 | 8-4 LOHB3-S | 8-4 LOHB3-SS | 420 | 420 | |
| | | 3/8 | 13/16-16 | 9.5 | 16 | 7/8 | — | 25 | 43 | 8-6 LOHB3-S | 8-6 LOHB3-SS | 420 | 420 |
| | | 5/8 | 13/16-16 | 9.5 | 16 | 7/8 | — | 25 | 42 | 8-10 LOHB3-S | 8-10 LOHB3-SS | 420 | 420 |
| | | 3/4 | 13/16-16 | 9.5 | 17 | 1 1/16 | — | 30 | 74 | 8-12 LOHB3-S | 8-12 LOHB3-SS | 420 | 420 |
| 16 | | 1-14 | 12.5 | 19 | — | — | 28 | 101 | 10-16MMLOHB3S | | 420 | — | |
| | | 5/8 | 12.5 | 19 | 1 1/16 | — | 27 | 104 | 10 LOHB3-S | 10 LOHB3-SS | 420 | 420 | |
| | | 3/8 | 1-14 | 12.5 | 19 | 1 1/16 | — | 27 | 99 | 10-6 LOHB3-S | 10-6 LOHB3-SS | 420 | 420 |
| | | 1/2 | 1-14 | 12.5 | 19 | 1 1/16 | — | 27 | 96 | 10-8 LOHB3-S | 10-8 LOHB3-SS | 420 | 420 |
| | | 3/4 | 1-14 | 12.5 | 19 | 1 1/16 | — | 31 | 97 | 10-12 LOHB3-S | 10-12 LOHB3-SS | 420 | 420 |
| 20 | | 1 3/16-12 | 15.5 | 21 | — | 32 | 34 | 144 | 12-20MMLOHB3S | | 420 | — | |
| | | 3/4 | 15.5 | 21 | 1 1/4 | — | 34 | 149 | 12 LOHB3-S | 12 LOHB3-SS | 420 | 420 | |
| | | 1/2 | 1 3/16-12 | 15.5 | 21 | 1 1/4 | — | 30 | 174 | 12-8 LOHB3-S | 12-8 LOHB3-SS | 420 | 420 |
| | | 5/8 | 1 3/16-12 | 15.5 | 21 | 1 1/4 | — | 30 | 171 | 12-10 LOHB3-S | 12-10 LOHB3-SS | 420 | 420 |
| | | 1 | 1 3/16-12 | 15.5 | 21 | 1 1/2 | — | 35 | 220 | 12-16 LOHB3-S | 12-16 LOHB3-SS | 420 | 420 |
| 25 | | 1 7/16-12 | 20.5 | 25 | — | 41 | 39 | 218 | 16-25MMLOHB3S | | 420 | — | |
| | | 1 | 20.5 | 25 | 1 1/2 | — | 39 | 225 | 16 LOHB3-S | 16 LOHB3-SS | 420 | 420 | |
| | | 1/2 | 1 7/16-12 | 20.5 | 25 | 1 1/2 | — | 33 | 237 | 16-8 LOHB3-S | 16-8 LOHB3-SS | 420 | 420 |
| | | 3/4 | 1 7/16-12 | 20.5 | 25 | 1 1/2 | — | 37 | 228 | 16-12 LOHB3-S | 16-12 LOHB3-SS | 420 | 420 |
| | | 1 1/4 | 1 7/16-12 | 20.5 | 25 | 1 3/4 | — | 39 | 276 | 16-20 LOHB3-S | 16-20 LOHB3-SS | 420 | 420 |
| 30 | | 1 11/16-12 | 26.0 | 25 | — | 46 | 39 | 269 | 20-30MMLOHB3S | | 280 | — | |
| | | 1 1/4 | 26.0 | 25 | 1 3/4 | — | 39 | 278 | 20 LOHB3-S | 20 LOHB3-SS | 280 | 280 | |
| | | 1 | 26.0 | 25 | 1 3/4 | — | 39 | 278 | 20-16 LOHB3-S | 20-16 LOHB3-SS | 280 | 280 | |
| | | 1 1/2 | 26.0 | 25 | 2 1/8 | — | 39 | 371 | 20-24 LOHB3-S | 20-24 LOHB3-SS | 280 | 280 | |
| 38 | | 2-12 | 32.0 | 25 | — | 55 | 39 | 374 | 24-38MMLOHB3S | | 280 | — | |
| | | 1 1/2 | 32.0 | 25 | 2 1/8 | — | 39 | 384 | 24 LOHB3-S | 24 LOHB3-SS | 280 | 280 | |
| | | 1 1/4 | 32.0 | 25 | 2 1/8 | — | 39 | 442 | 24-20 LOHB3-S | 24-20 LOHB3-SS | 280 | 280 | |

Product delivered with NBR TRAP seal. Replacement of TRAP seal is with a standard NBR O-ring – see page J73-J74.

Part numbers shown are part of our current manufacturing programme.

Imperial and metric parts may vary in hexagon dimensions.

$$\frac{\text{PN (bar)}}{10} = \text{PN (MPa)}$$

Do not create drawings from these dimensions, they are subject to change and ISO manufacturing allowances.

FNML Cap

O-Lok® ORFS Female swivel cap end
SAE 520112

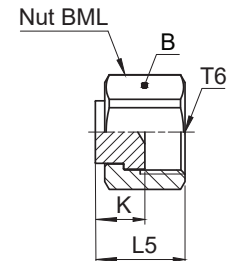

| Thread UN/UNF-2B T6 | B mm | K mm | L5 mm | Weight (steel) g/1 piece | O-Lok® Steel | O-Lok® Stainless Steel | PN (bar) | |
|---------------------------|---------|---------|----------|--------------------------------|-----------------|---------------------------|----------|-----|
| | | | | | | | S | SS |
| 9/16-18 | 17 | 9 | 16 | 6 | 4FNMLS | 4FNMLSS | 630 | 630 |
| 11/16-16 | 22 | 11 | 20 | 10 | 6FNMLS | 6FNMLSS | 630 | 630 |
| 13/16-16 | 24 | 12 | 22 | 11 | 8FNMLS | 8FNMLSS | 630 | 630 |
| 1-14 | 30 | 14 | 26 | 31 | 10FNMLS | 10FNMLSS | 420 | 420 |
| 1 3/16-12 | 36 | 15 | 29 | 52 | 12FNMLS | 12FNMLSS | 420 | 420 |
| 1 7/16-12 | 41 | 16 | 30 | 81 | 16FNMLS | 16FNMLSS | 420 | 420 |
| 1 11/16-12 | 48 | 16 | 30 | 129 | 20 FNL-S | 20FNMLSS | 280 | 280 |
| 2-12 | 57 | 16 | 30 | 189 | 24 FNL-S | 24FNMLSS | 280 | 280 |

Part numbers shown are part of our current manufacturing programme.
Imperial and metric parts may vary in hexagon dimensions.

$$\frac{\text{PN (bar)}}{10} = \text{PN (MPa)}$$

Do not create drawings from these dimensions, they are subject to change and ISO manufacturing allowances.

J

O-Lok®

PNMLO Plug

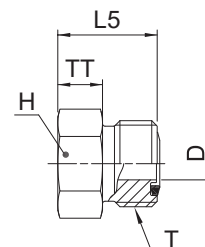
 O-Lok® ORFS tube end plug
 SAE 520109

| Tube O.D. | | Thread UN/UNF-2A T | D mm | H mm | L5 mm | TT mm | Weight (steel) g/1 piece | O-Lok® Steel | O-Lok® Stainless Steel | PN (bar) | |
|------------|-------|-----------------------|------|------|-------|-------|--------------------------|------------------|------------------------|----------|-----|
| mm | in. | | | | | | | | | S | SS |
| 6 | 1/4 | 9/16-18 | 4.5 | 16 | 17 | 7 | 18 | 4 PNLO-S | 4PNMLOSS | 630 | 630 |
| 8, 10 | 3/8 | 11/16-16 | 6.5 | 19 | 19 | 8 | 34 | 6PNMLOS | 6PNMLOSS | 630 | 630 |
| 12 | 1/2 | 13/16-16 | 9.5 | 22 | 22 | 9 | 45 | 8PNMLOS | 8PNMLOSS | 630 | 630 |
| 14, 15, 16 | 5/8 | 1-14 | 12.5 | 27 | 26 | 10 | 91 | 10 PNLO-S | 10PNMLOSS | 420 | 420 |
| 18, 20 | 3/4 | 1 3/16-12 | 15.5 | 32 | 27 | 10 | 138 | 12 PNLO-S | 12PNMLOSS | 420 | 420 |
| 22, 25 | 1 | 1 7/16-12 | 20.5 | 38 | 28 | 10 | 203 | 16 PNLO-S | 16PNMLOSS | 420 | 420 |
| 28, 30, 32 | 1 1/4 | 1 11/16-12 | 26.0 | 45 | 28 | 10 | 266 | 20 PNLO-S | 20PNMLOSS | 420 | 280 |
| 35, 38 | 1 1/2 | 2-12 | 32.0 | 54 | 28 | 10 | 369 | 24 PNLO-S | 24PNMLOSS | 350 | 280 |

Product delivered with NBR TRAP seal. Replacement of TRAP seal is with a standard NBR O-ring – see page J73-J74.

Part numbers shown are part of our current manufacturing programme.

Imperial and metric parts may vary in hexagon dimensions.

$$\frac{\text{PN (bar)}}{10} = \text{PN (MPa)}$$

Do not create drawings from these dimensions, they are subject to change and ISO manufacturing allowances.

XHMLO Conversion union

Triple-Lok® 37° flare tube end / O-Lok® ORFS tube end

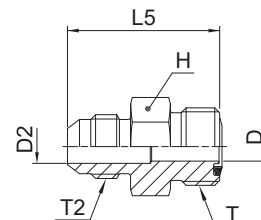

| Tube O.D. | | Thread UN/UNF-2A T | Thread UN/UNF-2A T2 | D | D2 | L5 | H | Weight (steel) | O-Lok® Steel | O-Lok® Stainless Steel | PN (bar) | |
|------------|-------|--------------------|---------------------|------|------|----|----|----------------|------------------|------------------------|----------|-----|
| mm | in. | | | mm | mm | mm | mm | g/1 piece | | | S | SS |
| 6 | 1/4 | 9/16-18 | 7/16-20 | 4.5 | 4.5 | 32 | 16 | 29 | 4 XHLO-S | 4XHMLOSS | 500 | 350 |
| 8, 10 | 3/8 | 11/16-16 | 9/16-18 | 6.5 | 7.5 | 34 | 19 | 45 | 6 XHLO-S | 6XHMLOSS | 420 | 350 |
| 12 | 1/2 | 13/16-16 | 3/4-16 | 9.5 | 9.9 | 39 | 22 | 70 | 8 XHLO-S | 8XHMLOSS | 420 | 350 |
| 14, 15, 16 | 5/8 | 1-14 | 7/8-14 | 12.5 | 12.5 | 47 | 27 | 119 | 10 XHLO-S | 10XHMLOSS | 350 | 350 |
| 18, 20 | 3/4 | 1 3/16-12 | 1 1/16-12 | 15.5 | 15.5 | 52 | 32 | 181 | 12 XHLO-S | 12XHMLOSS | 350 | 350 |
| 22, 25 | 1 | 1 7/16-12 | 1 5/16-12 | 20.5 | 20.5 | 55 | 38 | 265 | 16 XHLO-S | 16XHMLOSS | 280 | 280 |
| 28, 30, 32 | 1 1/4 | 1 11/16-12 | 1 5/8-12 | 26.0 | 26.0 | 58 | 45 | 383 | 20 XHLO-S | 20XHMLOSS | 280 | 210 |
| 35, 38 | 1 1/2 | 2-12 | 1 7/8-12 | 32.0 | 32.0 | 63 | 54 | 562 | 24 XHLO-S | 24XHMLOSS | 210 | 140 |

Product delivered with NBR TRAP seal. Replacement of TRAP seal is with a standard NBR O-ring – see page J73-J74.

Part numbers shown are part of our current manufacturing programme.

Imperial and metric parts may vary in hexagon dimensions.

$$\frac{\text{PN (bar)}}{10} = \text{PN (MPa)}$$

Do not create drawings from these dimensions, they are subject to change and ISO manufacturing allowances.

J

O-Lok®

XHML6 Conversion swivel nut connector

Triple-Lok® 37° flare tube end / O-Lok® ORFS female swivel end

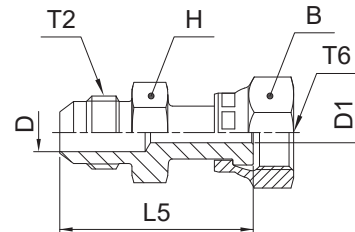

| Tube O.D. | | Thread UN/UNF-2A T2 | Thread UN/UNF-2B T6 | B | D1 | D | L5 | H | Weight (steel) | O-Lok® Steel | O-Lok® Stainless Steel | PN (bar) | |
|------------|-------|---------------------|---------------------|----|------|------|----|----|----------------|------------------|------------------------|----------|-----|
| mm | in. | | | mm | mm | mm | mm | mm | g/1 piece | | | S | SS |
| 6 | 1/4 | 7/16-20 | 9/16-18 | 18 | 4.2 | 4.2 | 38 | 16 | 29 | 4 XHL6-S | 4XHML6SS | 500 | 350 |
| 8, 10 | 3/8 | 9/16-18 | 11/16-16 | 21 | 6.7 | 6.7 | 41 | 19 | 46 | 6 XHL6-S | 6XHML6SS | 420 | 350 |
| 12 | 1/2 | 3/4-16 | 13/16-16 | 24 | 9.1 | 9.1 | 48 | 22 | 73 | 8 XHL6-S | 8XHML6SS | 420 | 350 |
| 14, 15, 16 | 5/8 | 7/8-14 | 1-14 | 29 | 11.5 | 11.5 | 56 | 27 | 126 | 10 XHL6-S | 10XHML6SS | 350 | 350 |
| 18, 20 | 3/4 | 1 1/16-12 | 1 3/16-12 | 35 | 14.0 | 14.0 | 64 | 32 | 205 | 12 XHL6-S | 12XHML6SS | 350 | 350 |
| 22, 25 | 1 | 1 5/16-12 | 1 7/16-12 | 41 | 19.9 | 19.9 | 68 | 38 | 285 | 16 XHL6-S | 16XHML6SS | 280 | 280 |
| 28, 30, 32 | 1 1/4 | 1 5/8-12 | 1 11/16-12 | 48 | 26.0 | 26.0 | 71 | 43 | 623 | 20 XHL6-S | 20XHML6SS | 280 | 210 |

Part numbers shown are part of our current manufacturing programme.

Imperial and metric parts may vary in hexagon dimensions.

$\frac{\text{PN (bar)}}{10} = \text{PN (MPa)}$

Do not create drawings from these dimensions, they are subject to change and ISO manufacturing allowances.

LOHMX6 Conversion swivel nut connector

Triple-Lok® 37 flare female swivel end / O-Lok® ORFS male end

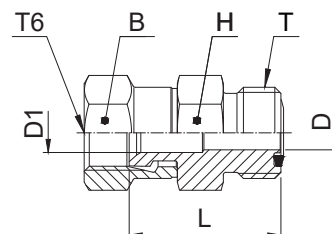

| Tube O.D. | | Thread UN/UNF-2A T | Thread UN/UNF-2B T6 | B | D | D1 | H | L | Weight (steel) | O-Lok® Steel | O-Lok® Stainless Steel | PN (bar) | |
|------------|-----|--------------------|---------------------|----|------|------|----|----|----------------|-------------------|------------------------|----------|-----|
| mm | in. | | | mm | mm | mm | mm | mm | g/1 piece | | | S | SS |
| 6 | 1/4 | 9/16-18 | 7/16-20 | 14 | 4.5 | 4.5 | 16 | 24 | 26 | 4 LOHX6-S | 4LOHMX6SS | 500 | 350 |
| 8, 10 | 3/8 | 11/16-16 | 9/16-18 | 18 | 6.5 | 6.5 | 19 | 29 | 40 | 6 LOHX6-S | 6LOHMX6SS | 350 | 350 |
| 12 | 1/2 | 13/16-16 | 3/4-16 | 22 | 9.5 | 9.5 | 22 | 34 | 63 | 8 LOHX6-S | 8LOHMX6SS | 350 | 350 |
| 14, 15, 16 | 5/8 | 1-14 | 7/8-14 | 25 | 12.5 | 12.5 | 27 | 39 | 103 | 10 LOHX6-S | 10LOHMX6SS | 350 | 350 |
| 18, 20 | 3/4 | 1 3/16-12 | 1 1/16-12 | 32 | 15.5 | 15.5 | 32 | 41 | 162 | 12 LOHX6-S | 12LOHMX6SS | 350 | 350 |
| 22, 25 | 1 | 1 7/16-12 | 1 5/16-12 | 38 | 20.5 | 20.5 | 38 | 46 | 229 | 16 LOHX6-S | 16LOHMX6SS | 250 | 250 |

Product delivered with NBR TRAP seal. Replacement of TRAP seal is with a standard NBR O-ring – see page J73-J74.

Part numbers shown are part of our current manufacturing programme.

Imperial and metric parts may vary in hexagon dimensions.

$$\frac{\text{PN (bar)}}{10} = \text{PN (MPa)}$$

Do not create drawings from these dimensions, they are subject to change and ISO manufacturing allowances.

J

O-Lok®

LOHU86 EO swivel adapter

O-Lok® ORFS tube end / EO 24° DKO swivel

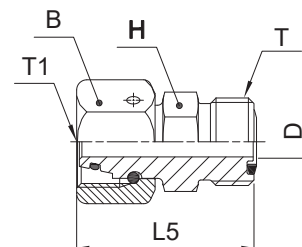

| Tube O.D. | | EO Swivel Size | Thread UN/UNF-2A T | Thread metric T1 | H mm | D mm | L5 mm | B mm | Weight (steel) g/1 piece | O-Lok® Steel | PN (bar) |
|------------|-----|----------------|--------------------|------------------|------|------|-------|------|--------------------------|------------------------|----------|
| mm | in. | | | | | | | | | | |
| 6 | 1/4 | 6L | 9/16-18 | M 12×1.5 | 17 | 2.6 | 34 | 14 | 30 | 4-6L LOHU86-S | 500 |
| 6 | 1/4 | 8L | 9/16-18 | M 14×1.5 | 17 | 4.1 | 34 | 17 | 50 | 4-8L LOHU86-S | 500 |
| 8, 10 | 3/8 | 10L | 11/16-16 | M 16×1.5 | 19 | 6.1 | 37 | 19 | 75 | 6-10L LOHU86-S | 500 |
| 12 | 1/2 | 12L | 13/16-16 | M 18×1.5 | 22 | 8.2 | 39 | 22 | 145 | 8-12L LOHU86-S | 400 |
| 14, 15, 16 | 5/8 | 15L | 1-14 | M 22×1.5 | 27 | 10.2 | 46 | 27 | 180 | 10-15L LOHU86-S | 400 |
| 18, 20 | 3/4 | 18L | 1 3/16-12 | M 26×1.5 | 32 | 13.2 | 48 | 32 | 250 | 12-18L LOHU86-S | 400 |
| 22, 25 | 1 | 22L | 1 7/16-12 | M 30×2.0 | 41 | 17.2 | 53 | 36 | 305 | 16-22L LOHU86-S | 250 |
| 6 | 1/4 | 6S | 9/16-18 | M 14×1.5 | 17 | 2.6 | 34 | 17 | 30 | 4-6S LOHU86-S | 630 |
| 6 | 1/4 | 8S | 9/16-18 | M 16×1.5 | 17 | 4.1 | 34 | 19 | 50 | 4-8S LOHU86-S | 630 |
| 8, 10 | 3/8 | 10S | 11/16-16 | M 18×1.5 | 19 | 6.0 | 37 | 22 | 75 | 6-10S LOHU86-S | 630 |
| 12 | 1/2 | 12S | 13/16-16 | M 20×1.5 | 22 | 8.0 | 40 | 24 | 145 | 8-12S LOHU86-S | 630 |
| 14, 15, 16 | 5/8 | 14S | 1-14 | M 22×1.5 | 27 | 9.2 | 47 | 27 | 180 | 10-14S LOHU86-S | 420 |
| 14, 15, 16 | 5/8 | 16S | 1-14 | M 24×1.5 | 27 | 11.2 | 47 | 30 | 185 | 10-16S LOHU86-S | 420 |
| 18, 20 | 3/4 | 20S | 1 3/16-12 | M 30×2.0 | 32 | 14.1 | 52 | 36 | 260 | 12-20S LOHU86-S | 420 |
| 22, 25 | 1 | 25S | 1 7/16-12 | M 36×2.0 | 41 | 18.2 | 55 | 46 | 308 | 16-25S LOHU86-S | 420 |

Product delivered with NBR TRAP seal. Replacement of TRAP seal is with a standard NBR O-ring – see page J73-J74.

Part numbers shown are part of our current manufacturing programme.

Imperial and metric parts may vary in hexagon dimensions.

$$\frac{\text{PN (bar)}}{10} = \text{PN (MPa)}$$

Do not create drawings from these dimensions, they are subject to change and ISO manufacturing allowances.

FNLBA Bleed adaptor

O-Lok® ORFS female end

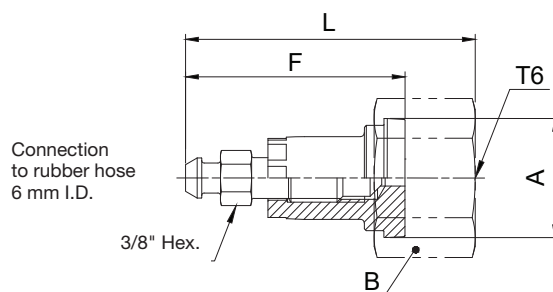

| Thread UN/UNF-2B T6 | A mm | F mm | B mm | L mm | Weight (steel) g/1 piece | O-Lok® | | PN (bar) | |
|---------------------------|---------|---------|---------|---------|--------------------------------|-------------------|--------------------|----------|-----|
| | | | | | | Steel | Stainless Steel | S | SS |
| 13/16-16 | 19 | 41 | 24 | 53 | 49 | 8 FNLBA-S | 8 FNLBA-SS | 630 | 630 |
| 1-14 | 23 | 41 | 29 | 55 | 77 | 10 FNLBA-S | 10 FNLBA-SS | 420 | 420 |
| 1 3/16-12 | 28 | 41 | 35 | 56 | 111 | 12 FNLBA-S | 12 FNLBA-SS | 420 | 420 |
| 1 7/16-12 | 34 | 41 | 41 | 56 | 113 | 16 FNLBA-S | 16 FNLBA-SS | 420 | 420 |
| 1 11/16-12 | 41 | 41 | 48 | 56 | 151 | 20 FNLBA-S | 20 FNLBA-SS | 420 | 420 |
| 2-12 | 49 | 41 | 57 | 56 | 161 | 24 FNLBA-S | 24 FNLBA-SS | 420 | 350 |

Part numbers shown are part of our current manufacturing programme.

Imperial and metric parts may vary in hexagon dimensions.

$\frac{\text{PN (bar)}}{10} = \text{PN (MPa)}$

Do not create drawings from these dimensions, they are subject to change and ISO manufacturing allowances.

J

O-Lok®

PNLOBA Bleed adaptor

O-Lok® ORFS female end

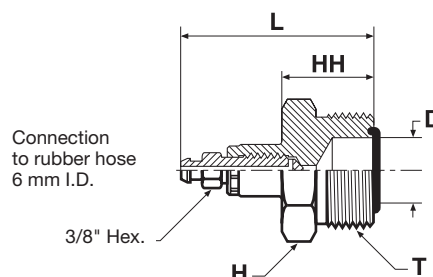

| Tube O.D. | | Thread UN/UNF-2A T | D mm | H mm | HH mm | L mm | Weight (steel) g/1 piece | O-Lok® Steel | PN (bar) |
|------------|-------|-----------------------|------|------|-------|------|--------------------------|--------------------|----------|
| mm | in. | | | | | | | | |
| 6 | 1/4 | 9/16-18 | 4.5 | 18 | 20 | 48 | 57 | 4 PNLOBA-S | 630 |
| 8, 10 | 3/8 | 11/16-16 | 6.5 | 19 | 22 | 50 | 64 | 6 PNLOBA-S | 630 |
| 12 | 1/2 | 13/16-16 | 9.5 | 22 | 23 | 53 | 93 | 8 PNLOBA-S | 630 |
| 14, 15, 16 | 5/8 | 1-14 | 12.5 | 27 | 26 | 56 | 127 | 10 PNLOBA-S | 420 |
| 18, 20 | 3/4 | 1 3/16-12 | 15.5 | 32 | 27 | 58 | 220 | 12 PNLOBA-S | 420 |
| 22, 25 | 1 | 1 7/16-12 | 20.5 | 38 | 28 | 60 | 266 | 16 PNLOBA-S | 420 |
| 28, 30, 32 | 1 1/4 | 1 11/16-12 | 26.0 | 45 | 28 | 61 | 304 | 20 PNLOBA-S | 420 |
| 35, 38 | 1 1/2 | 2-12 | 32.0 | 54 | 28 | 63 | 422 | 24 PNLOBA-S | 350 |

Product delivered with NBR TRAP seal. Replacement of TRAP seal is with a standard NBR O-ring – see page J73-J74.

Part numbers shown are part of our current manufacturing programme.

Imperial and metric parts may vary in hexagon dimensions.

$$\frac{\text{PN (bar)}}{10} = \text{PN (MPa)}$$

Do not create drawings from these dimensions, they are subject to change and ISO manufacturing allowances.

HPBA Bleed adaptor

Bleed hose connection / Male NPTF thread (SAE J476)

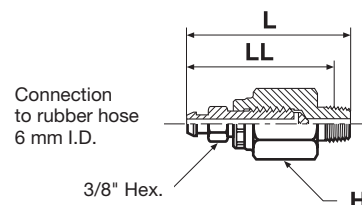

| Thread NPTF | H mm | L mm | LL mm | O-Lok® Steel | PN (bar) |
|----------------|---------|---------|----------|-----------------|-------------|
| 1/4-18 | 18 | 56 | 47 | 1/4 HPBA-S | 420 |

Imperial and metric parts may vary in hexagon dimensions.

$$\frac{\text{PN (bar)}}{10} = \text{PN (MPa)}$$

Do not create drawings from these dimensions, they are subject to change and ISO manufacturing allowances.

J

P5ONBA Bleed adaptor

Bleed hose connection/Male UN/UNF thread – O-ring (ISO 11926)

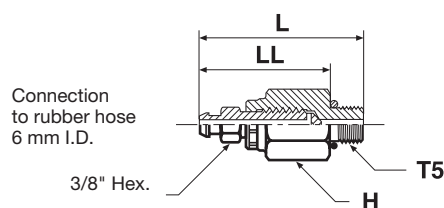

| Thread UN/UNF-2A T5 | H mm | L mm | LL mm | O-Lok® Steel | PN (bar) |
|---------------------------|---------|---------|----------|-----------------|-------------|
| 7/16-20 | 18 | 52 | 41 | 4 P5ONBA-S | 420 |

O-Lok® is delivered with NBR elastomeric seals as standard. For more details on other seal materials see page J73-J74.

Part numbers shown are part of our current manufacturing programme.

Imperial and metric parts may vary in hexagon dimensions.

$$\frac{\text{PN (bar)}}{10} = \text{PN (MPa)}$$

Do not create drawings from these dimensions, they are subject to change and ISO manufacturing allowances.

O-Lok®
TW3L Weld nipple

O-Lok® ORFS female end / Butt weld end

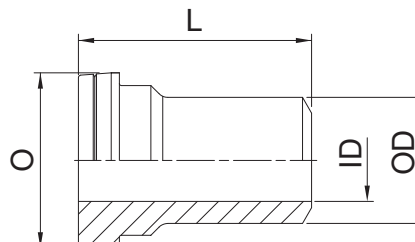

| Tube O.D. mm | ID mm | OD mm | O mm | L mm | Weight (steel) g/1 piece | O-Lok® Steel | O-Lok® Stainless Steel |
|--------------------|----------|----------|---------|---------|--------------------------------|-----------------|---------------------------|
| 6 | 2 | 6 | 13 | 25 | 10 | TW3LS6 | TW3LSS6 |
| 8 | 3 | 8 | 13 | 25 | 12 | TW3LS8 | TW3LSS8 |
| 10 | 4 | 10 | 16 | 26 | 15 | TW3LS10 | TW3LSS10 |
| 12 | 5 | 12 | 19 | 26 | 18 | TW3LS12 | TW3LSS12 |
| 16 | 10 | 16 | 23 | 32 | 25 | TW3LS16 | TW3LSS16 |
| 20 | 13 | 20 | 28 | 37 | 30 | TW3LS20 | TW3LSS20 |
| 25 | 16 | 25 | 34 | 42 | 37 | TW3LS25 | TW3LSS25 |
| 30 | 22 | 30 | 41 | 44 | 43 | TW3LS30 | TW3LSS30 |
| 38 | 28 | 38 | 48 | 49 | 70 | TW3LS38 | TW3LSS38 |

Part numbers shown are part of our current manufacturing programme.

Do not create drawings from these dimensions, they are subject to change and ISO manufacturing allowances.

WLNML Bulkhead locknut

SAE 520118/SAE 52M0118 ISO 8434-3 BHLN

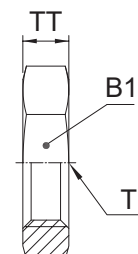

| Thread UN/UNF-2B T | B1 mm | TT mm | Weight (steel) g/1 piece | O-Lok® Steel | O-Lok® Stainless Steel |
|--------------------------|----------|----------|--------------------------------|-----------------|---------------------------|
| 9/16-18 | 22 | 7 | 11 | 4WLNMLS | 4WLNMLSS |
| 11/16-16 | 27 | 8 | 23 | 6WLNMLS | 6WLNMLSS |
| 13/16-16 | 30 | 9 | 26 | 8WLNMLS | 8WLNMLSS |
| 1-14 | 36 | 11 | 38 | 10WLNMLS | 10WLNMLSS |
| 1 3/16-12 | 41 | 11 | 44 | 12WLNMLS | 12WLNMLSS |
| 1 7/16-12 | 46 | 11 | 54 | 16WLNMLS | 16WLNMLSS |
| 1 11/16-12 | 51 | 10 | 73 | 20 WLNLS | 20WLNMLSS |
| 2-12 | 60 | 10 | 102 | 24 WLNLS | 24WLNMLSS |

Part numbers shown are part of our current manufacturing programme.

Imperial and metric parts may vary in hexagon dimensions.

Do not create drawings from these dimensions, they are subject to change and ISO manufacturing allowances.

Spare parts guide – O-Lok® retaining rings and seals



Face seal end O-rings SAE J1453/ISO 8434-3

| Dash size | Thread UN/UNF | O-ring order code | | O-ring ID × section mm |
|-----------|------------------|---------------------|---------------------|---------------------------|
| | | NBR | FKM | |
| 4 | 9/16-18 | 2-011-N552-9 | 2-011-V894-9 | 7.65 × 1.78 |
| 6 | 11/16-16 | 2-012-N552-9 | 2-012-V894-9 | 9.25 × 1.78 |
| 8 | 13/16-16 | 2-014-N552-9 | 2-014-V894-9 | 12.42 × 1.78 |
| 10 | 1-14 | 2-016-N552-9 | 2-016-V894-9 | 15.60 × 1.78 |
| 12 | 1 3/16-12 | 2-018-N552-9 | 2-018-V894-9 | 18.77 × 1.78 |
| 16 | 1 7/16-12 | 2-021-N552-9 | 2-021-V894-9 | 23.52 × 1.78 |
| 20 | 1 11/16-12 | 2-025-N552-9 | 2-025-V894-9 | 29.87 × 1.78 |
| 24 | 2-12 | 2-029-N552-9 | 2-029-V894-9 | 37.82 × 1.78 |

BSPP male threads – ISO 1179

| Thread BSPP | ED seal order code | | O-ring order code* | | O-ring ID × section mm | Retainer ring Order code Steel | Retainer ring Order code Stainless Steel |
|----------------|--------------------|---------------------|---------------------|---------------------|------------------------------|--------------------------------------|--|
| | NBR | FKM | NBR | FKM | | | |
| 1/8 | ED10X1X | ED10X1VITX | 6-002-N552-9 | 6-002-V894-9 | 8.00 × 2.00 | 8207-1/8 | 8207SS1/8 |
| 1/4 | ED14X1.5X | ED14X1.5VITX | 2-111-N552-9 | 2-111-V894-9 | 10.77 × 2.62 | 8207-1/4 | 8207SS1/4A |
| 3/8 | ED3/8X | ED3/8VITX | 2-113-N552-9 | 2-113-V894-9 | 13.94 × 2.62 | 8207-3/8 | 8207SS3/8A |
| 1/2 | ED1/2X | ED1/2VITX | 5-256-N552-9 | 5-256-V894-9 | 17.96 × 2.62 | 8207-1/2 | 8207SS1/2 |
| 3/4 | ED26X1.5X | ED26X1.5VITX | 2-119-N552-9 | 2-119-V894-9 | 23.47 × 2.62 | 8207-3/4 | 8207SS3/4 |
| 1 | ED33X2X | ED33X2VITX | 2-217-N552-9 | 2-217-V894-9 | 29.74 × 3.53 | 8207-1 | 8207SS1A |
| 1 1/4 | ED42X2X | ED42X2VITX | 2-222-N552-9 | 2-222-V894-9 | 37.69 × 3.53 | 8207-1-1/4 | 8207SS1 1/4 |
| 1 1/2 | ED48X2X | ED48X2VITX | 2-224-N552-9 | 2-224-V894-9 | 44.04 × 3.53 | 8207-1-1/2 | 8207SS1 1/2 |

Typical fittings using these parts: F42EDMLO/C4OMLO/V4OMLO etc.

*Must be used with correct retainer ring.

Metric male threads – ISO 9974

| Thread metric | ED seal order code | | O-ring order code* | | O-ring ID × section mm | Retainer ring Order code Steel | Retainer ring Order code Stainless Steel |
|------------------|-----------------------|--------------------------|---------------------|---------------------|------------------------------|--------------------------------------|--|
| | NBR | FKM | NBR | FKM | | | |
| M 10×1.0 | ED10X1/R1/8X | ED10X1R1/8VITX | 6-074-N552-9 | 6-074-V894-9 | 8.00 × 1.50 | M10RR | RRM10X1SS |
| M 12×1.5 | ED12X1.5X | ED14X1.5/VITX | 2-012-N552-9 | 2-012-V894-9 | 9.25 × 1.78 | M12RR | RRM12X1.5SS |
| M 14×1.5 | ED14X1.5/R1/4X | ED14X1.5/R1/4VITX | 2-013-N552-9 | 2-013-V894-9 | 10.82 × 1.78 | M14RR | RRM14X1.5SS |
| M 16×1.5 | ED16X1.5X | ED16X1.5/VITX | 3-907-N552-9 | 3-907-V894-9 | 13.46 × 2.08 | M16RR | RRM16X1.5SS |
| M 18×1.5 | ED18X1.5X | ED18X1.5/VITX | 2-114-N552-9 | 2-114-V894-9 | 15.54 × 2.62 | M18RR | RRM18X1.5SS |
| M 22×1.5 | ED22X1.5X | ED22X1.5VITX | 2-018-N552-9 | 2-018-V894-9 | 18.77 × 1.78 | M22RR | RRM22X1.5SS |
| M 27×2.0 | ED26X1.5X** | ED26X1.5VITX | 2-119-N552-9 | 2-119-V894-9 | 23.47 × 2.62 | M27RR | RRM27X2SS |
| M 33×2.0 | ED33X2R1X | ED33X2/R1VITX | 2-122-N552-9 | 2-122-V894-9 | 28.24 × 2.62 | M33RR | RRM33X2SS |
| M 42×2.0 | ED42X2/R1.1/4X | ED42X2R1.1/4VITX | 2-128-N552-9 | 2-128-V894-9 | 37.77 × 2.62 | M42RR | RRM42X2SS |
| M 48×2.0 | ED48X2/R1.1/2X | ED48X2R1.1/2VITX | 2-132-N552-9 | 2-132-V894-9 | 44.12 × 2.62 | M48RR | RRM48X2SS |

Typical fittings using these parts: F82EDMLO/C8OMLO/V8OMLO etc.

*Must be used with correct retainer ring.

**Same seal used for M 26×1.5 and M 27×2.0

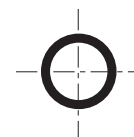
O-Lok®
Spare parts guide – O-Lok® retaining rings and seals

UN / UNF male threads – ISO 11926

| Dash size | Thread UN/UNF | O-ring order code | | O-ring ID × section mm |
|-----------|------------------|---------------------|---------------------|---------------------------|
| | | NBR | FKM | |
| 2 | 5/16-24 | 3-902-N552-9 | 3-902-V894-9 | 6.07 × 1.63 |
| 3 | 3/8-24 | 3-903-N552-9 | 3-903-V894-9 | 7.65 × 1.63 |
| 4 | 7/16-20 | 3-904-N552-9 | 3-904-V894-9 | 8.92 × 1.83 |
| 5 | 1/2-20 | 3-905-N552-9 | 3-905-V894-9 | 10.52 × 1.83 |
| 6 | 9/16-18 | 3-906-N552-9 | 3-906-V894-9 | 11.89 × 1.98 |
| 8 | 3/4-16 | 3-908-N552-9 | 3-908-V894-9 | 16.36 × 2.21 |
| 10 | 7/8-14 | 3-910-N552-9 | 3-910-V894-9 | 19.18 × 2.46 |
| 12 | 1 1/16-12 | 3-912-N552-9 | 3-912-V894-9 | 23.47 × 2.95 |
| 14 | 1 3/16-12 | 3-914-N552-9 | 3-914-V894-9 | 26.59 × 2.95 |
| 16 | 1 5/16-12 | 3-916-N552-9 | 3-916-V894-9 | 29.74 × 2.95 |
| 20 | 1 5/8-12 | 3-920-N552-9 | 3-920-V894-9 | 37.47 × 3.00 |
| 24 | 1 7/8-12 | 3-924-N552-9 | 3-924-V894-9 | 43.69 × 3.00 |
| 32 | 2 1/2-12 | 3-932-N552-9 | 3-932-V894-9 | 59.36 × 3.00 |

Typical fittings using these parts: F5OMLO/C5OMLO/R5OMLO etc.

Metric male threads – ISO 6149

| Thread metric | O-ring order code | | O-ring ID × section mm |
|------------------|---------------------|---------------------|---------------------------|
| | NBR | FKM | |
| M 10×1.0 | 6-345-N552-9 | 6-345-V894-9 | 8.20 × 1.50 |
| M 12×1.5 | 6-346-N552-9 | 6-346-V894-9 | 9.40 × 2.10 |
| M 14×1.5 | 6-347-N552-9 | 6-347-V894-9 | 11.40 × 2.10 |
| M 16×1.5 | 6-348-N552-9 | 6-348-V894-9 | 13.40 × 2.10 |
| M 18×1.5 | 6-349-N552-9 | 6-349-V894-9 | 15.40 × 2.10 |
| M 22×1.5 | 6-350-N552-9 | 6-350-V894-9 | 19.40 × 2.10 |
| M 27×2.0 | 6-351-N552-9 | 6-351-V894-9 | 23.70 × 2.80 |
| M 33×2.0 | 6-352-N552-9 | 6-352-V894-9 | 29.70 × 2.80 |
| M 42×2.0 | 6-353-N552-9 | 6-353-V894-9 | 38.70 × 2.80 |
| M 48×2.0 | 6-354-N552-9 | 6-354-V894-9 | 46.70 × 2.80 |

Typical fittings using these parts: F87OMLO/S87OMLO etc.

Other seal compounds are available on request for alternative applications.

SBR Braze ring

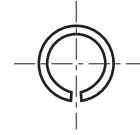

For metric tubing

| Tube O.D. mm | Order code |
|-----------------|---------------|
| 6 | SBR 6 |
| 8 | SBR 8 |
| 10 | SBR 10 |
| 12 | SBR 12 |
| 14 | SBR 14 |
| 15 | SBR 15 |
| 16 | SBR 16 |
| 18 | SBR 18 |
| 20 | SBR 20 |
| 22 | SBR 22 |
| 25 | SBR 25 |
| 28 | SBR 28 |
| 30 | SBR 30 |
| 32 | SBR 32 |
| 35 | SBR 35 |
| 38 | SBR 38 |
| 50 | SBR 50 |

For inch tubing

| Tube O.D. in. | Order code |
|------------------|--------------|
| 1/4 | 4SBR |
| 3/8 | 6SBR |
| 1/2 | 8SBR |
| 5/8 | 10SBR |
| 3/4 | 12SBR |
| 1 | 16SBR |
| 1 1/4 | 20SBR |
| 1 1/2 | 24SBR |
| 2 | 32SBR |

Part numbers shown are part of our current manufacturing programme.

J





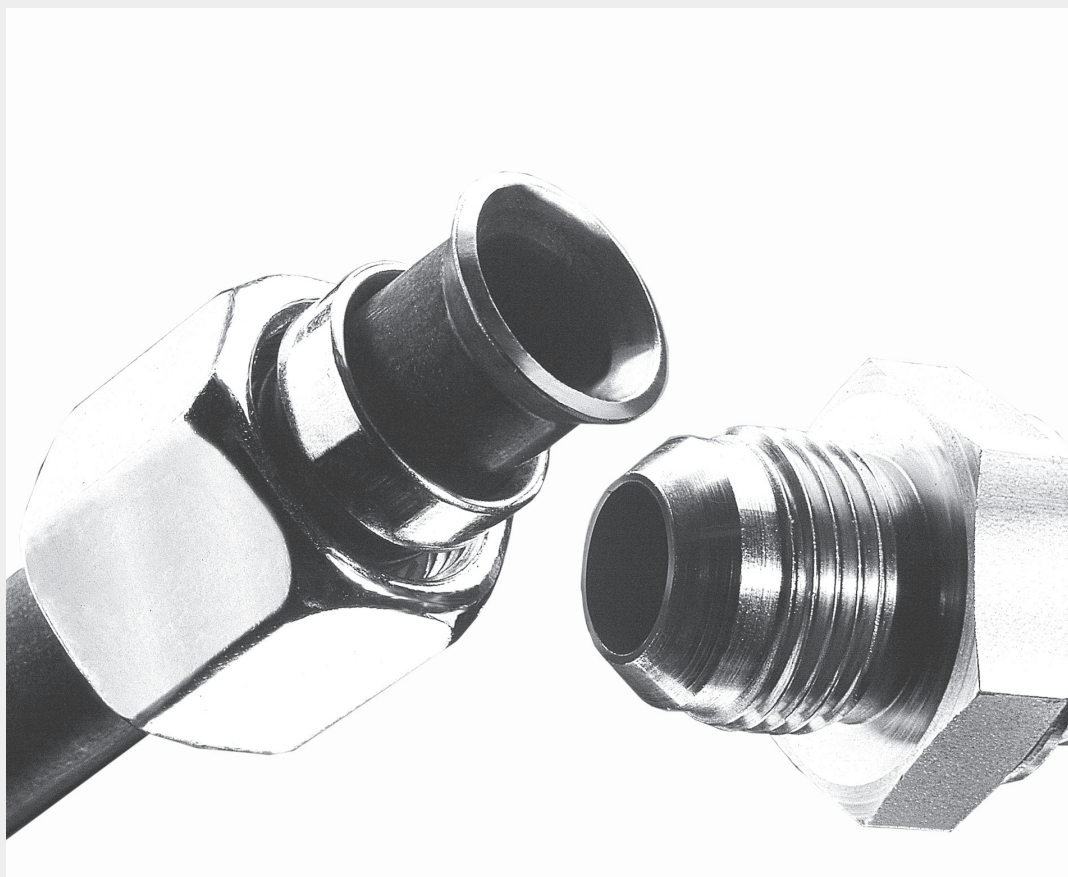





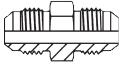

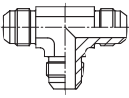

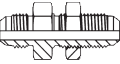
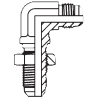
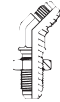
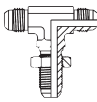
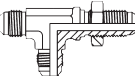

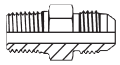



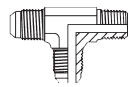
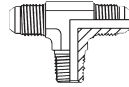



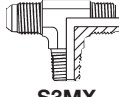
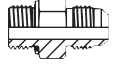
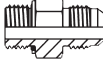
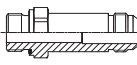

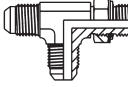
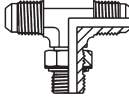

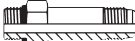



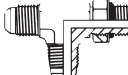
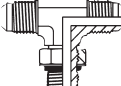



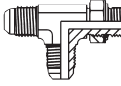
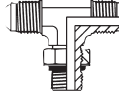

Triple-Lok[®]
*The universal
37° flared fitting*

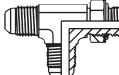
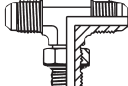

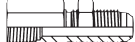
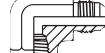

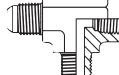





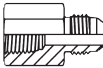
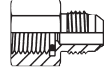
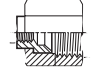
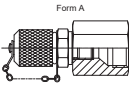
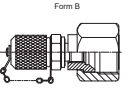
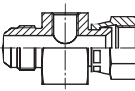

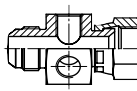
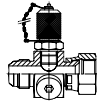
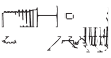

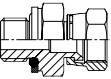
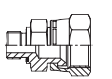

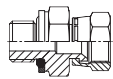
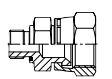

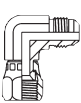
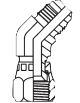
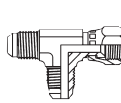
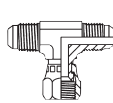
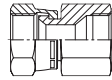
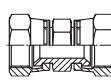
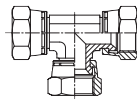
Triple-Lok®

Visual index

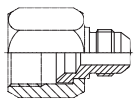
| | | | | | | | |
|--------------------------------|--|---|--|--|---|---|---|
| Tube to tube |  HMTX p. K9 |  EMTX p. K10 |  JMTX p. K11 |  KTX p. K12 | | | |
| Bulkhead union |  WMTX p. K13 |  WEMTX p. K14 |  WNTX p. K15 |  WJTX p. K16 |  WJJTX p. K17 |  WLNMX p. K91 | |
| Tube to male NPTF |  FMTX p. K35 |  CMTX p. K50 |  CCTX p. K51 |  CCCTX p. K52 |  VMTX p. K58 |  RMTX p. K70 |  SMTX p. K64 |
| Tube to male BSPT |  F3MX p. K36 |  C3MX p. K53 |  V3MX p. K59 |  R3MX p. K71 |  S3MX p. K65 | | |
| Tube to male BSPP |  F4OMX p. K32 |  F42EDMX p. K30 |  FF42EDMX p. K31 |  C4OMX p. K48 |  V4OMX p. K56 |  R4OMX p. K68 |  S4OMX p. K62 |
| Tube to straight thread UNF |  F5OMX p. K27 |  FF5OMX p. K29 |  C5OMX p. K46 |  CC5OX p. K47 |  V5OMX p. K55 |  R5OMX p. K67 |  S5OMX p. K61 |
| Tube to male metric ISO 6149-3 |  F87OMX p. K26 |  C87OMX p. K45 |  V87OMX p. K54 |  R87OMX p. K66 |  S87OMX p. K60 | | |
| Tube to male metric DIN 3852-1 |  F8OMX p. K34 |  F82EDMX p. K33 |  C8OMX p. K49 |  V8OMX p. K57 |  R8OMX p. K69 |  S8OMX p. K63 | |
| Tube to female NPTF |  GMTX p. K73 |  WGMTX p. K74 |  DMTX p. K75 |  OTX p. K76 |  MTX p. K77 |  G6X p. K78 | |

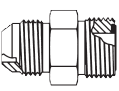
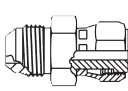
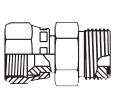
Visual index

| | | | | | | | |
|---|--|--|--|---|---|---|---|
| Pressure gauge connectors |  G4MX p. K72 |  G4MXMO p. K79 |  TT4MX p. K80 |  TTP4MX p. K81 |  TTP4MX p. K81 | | |
| |  R6O4MX p. K82 |  R6P4MX p. K83 |  K6O4MX p. K84 |  K6PP4MX p. K85 | | | |
| Triple-Lok® swivel nut male pipe |  F6MX p. K41 |  F63MX p. K44 | | | | | |
| Triple-Lok® swivel nut straight thread |  F64OMX p. K40 |  F642EDMX p. K39 |  F65OMX p. K38 |  F68OMX p. K42 |  F682EDMX p. K41 |  F687OMX p. K37 | |
| Tube to Triple-Lok® swivel nut |  C6MX p. K18 |  V6MX p. K19 |  R6MX p. K21 |  S6MX p. K20 |  BBMTX p. K22 |  HMX6 p. K24 |  JX6 p. K25 |
| Nuts & Sleeves |  BMTX p. K6 |  BTX p. K5 |  TX p. K7 | | | | |
| Tube end reducers Plug Caps |  TRMTX p. K23 |  FNMTX p. K86 |  PNMTX p. K87 | | | | |
| Conversion Adapters Triple-Lok®/ O-Lok® |  XHML0 p. K88 |  XHML6 p. K89 |  LOHMX6 p. K90 | | | | |
| Seals Retaining ring and Tooling |  Triple-Lok® Components p. K92 | | | | | | |

K

Triple-Lok®

How to order Triple-Lok® fittings

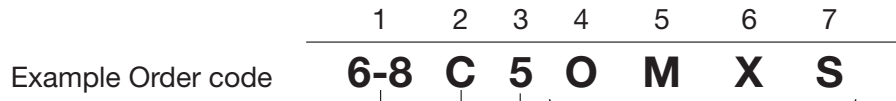

1 Order codes for tube and port thread ends

| Dash Size | Tube Size (Inch) | Tube Size (mm) | Port Thread Size (Inch) BSPP/BSPT/NPT | Port Thread Size UN / UNF |
|-----------|------------------|----------------|---------------------------------------|---------------------------|
| 2 | 1/8 | | 1/8 | 5/16-24 |
| 3 | 3/16 | | | 3/8-24 |
| 4 | 1/4 | 6 | 1/4 | 7/16-20 |
| 5 | | | | 1/2-20 |
| 6 | 3/8 | 8,10 | 3/8 | 9/16-18 |
| 8 | 1/2 | 12 | 1/2 | 3/4-16 |
| 10 | 5/8 | 14,15,16 | 5/8 | 7/8-14 |
| 12 | 3/4 | 18,20 | 3/4 | 1 1/6-12 |
| 14 | | | | 1 3/6-12 |
| 16 | 1 | 25 | 1 | 1 5/16-12 |
| 20 | 1 1/4 | 28,30,32 | 1 1/4 | 1 5/8-12 |
| 24 | 1 1/2 | 35,38 | 1 1/2 | 1 7/8-12 |
| 28 | | 42 | | 2 1/4-12 |
| 32 | 2 | 50 | 2 | 2 1/2-12 |

Metric port threads are shown as per example 4M12C87OMXS

3 Threads and sealing methods

| Code | Description |
|------|--|
| None | NPT/NPTF Thread |
| 3 | BSPT Thread |
| 4 | BSPP Thread O-Ring & Retainer Ring |
| 42 | BSPP Thread EOLASTIC seal 'ED' |
| 5 | UN/UNF Thread (O-Ring Seal) |
| 8 | Metric Thread O-Ring & Retainer Ring |
| 82 | Metric Thread EOLASTIC seal 'ED' |
| 87 | Metric ISO 6149 Thread (O-Ring Seal) |
| 63 | Swivel Connector BSPT end |
| 64 | Swivel Connector BSPP end (O-Ring & Retainer Ring) |
| 642 | Swivel Connector BSPP end (EOLASTIC Seal 'ED') |
| 65 | Swivel Connector UN/UNF end (O-Ring seal) |
| 68 | Swivel Connector Metric end (O-Ring & Retainer Ring) |
| 682 | Swivel Connector Metric end (EOLASTIC Seal 'ED') |
| 687 | Swivel Connector Metric ISO 6149 end |

2 Codes for fitting styles/shapes

| Code | Description |
|-------|-------------------------------------|
| AE6 | Straight Thread Swivel |
| B | Nut |
| C | Male Stud elbow |
| CC | Long Male Stud elbow |
| CCC | Extra Long Male Stud elbow |
| C6 | Swivel Nut Elbow |
| D | Female Elbow |
| E | Union elbow |
| F | Male Stud connector |
| FF | Long Male Stud connector |
| F6 | Male Stud Swivel |
| FN | Cap |
| G | Female Connector |
| G-MO | Gauge Adapter Fitting |
| G6 | Female Connector Swivel |
| H | Straight union |
| H6 | Swivel/Swivel Adapter |
| J | Union Tee |
| J6 | Swivel Tee |
| K | Union Cross |
| LOHX6 | Triple-Lok® Swivel/O-Lok® Adapter |
| M | Female Run Tee |
| O | Female Branch Tee |
| PN | Plug |
| R | Male Stud Run Tee |
| R6 | Swivel Run Tee |
| S | Male Stud Branch Tee |
| S6 | Swivel Branch Tee |
| T | Sleeve |
| TR | Tube End Reducer |
| TT | Test Point Adapter |
| V | 45° male stud elbow |
| V6 | Swivel Nut 45° Elbow |
| W | Bulkhead Union |
| WE | Bulkhead Union Elbow |
| WG | Female Bulkhead connector |
| WJJ | Bulkhead Run Tee |
| WJT | Bulkhead Branch Tee |
| WLN | Bulkhead Locknut |
| WN | Bulkhead 45° union elbow |
| XHL | Triple Lok® / O-Lok® Adaptor |
| XHL6 | Triple Lok® / O-Lok® Swivel Adaptor |

4 Stud connector seal

| Code | Description |
|---------|--|
| O | O-Ring Seal (Assembled on fitting) |
| ED | Captive EOLASTIC Seal (Assembled on fitting) |
| No Code | No Seal (O-Ring not assembled on fitting) |

5 Hexagon/ Across flats style

| Code | Description |
|---------|--------------------------|
| M | Metric Hexagon Dimension |
| No Code | Inch Hexagon Dimension |

6 Fitting type

| Code | Description |
|------|--------------------|
| X | Parker Triple-Lok® |

7 Fitting material

| Code | Description |
|------|-----------------|
| S | Steel |
| SS | Stainless Steel |
| B | Brass |



BTX Nut

Triple-Lok® 37° Flare end nut
SAE 070110 MS51531

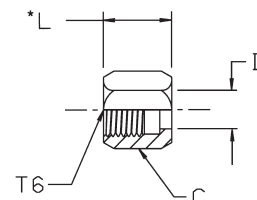

| Tube O.D. | | Thread UN/UNF-2B T6 | C in. | D mm | L mm | Weight (steel) g/1 piece | Triple-Lok® Steel | Triple-Lok® Stainless Steel | Triple-Lok® Brass |
|------------|--------|---------------------|-------|------|------|--------------------------|-------------------|-----------------------------|-------------------|
| mm | in. | | | | | | | | |
| 6 | 1/8 | 5/16-24 | 3/8 | 4.5 | 14.0 | 6 | 2 BTX-S | 2 BTX-SS | 2 BTX-B |
| | 3/16 | 3/8-24 | 7/16 | 6.0 | 15.5 | 8 | 3 BTX-S | 3 BTX-SS | 3 BTX-B |
| | 1/4 | 7/16-20 | 9/16 | 8.0 | 16.0 | 11 | 4 BTX-S | 4 BTX-SS | 4 BTX-B |
| | 5/16 | 1/2-20 | 5/8 | 9.5 | 17.0 | 14 | 5 BTX-S | 5 BTX-SS | 5 BTX-B |
| 8 | 3/8 | 9/16-18 | 11/16 | 11.0 | 18.5 | 18 | 6 BTX-S | 6 BTX-SS | 6 BTX-B |
| | 1/2 | 3/4-16 | 7/8 | 14.5 | 21.5 | 29 | 8 BTX-S | 8 BTX-SS | 8 BTX-B |
| 14, 15, 16 | 5/8 | 7/8-14 | 1 | 18.0 | 25.0 | 54 | 10 BTX-S | 10 BTX-SS | 10 BTX-B |
| | 3/4 | 1 1/16-12 | 1 1/4 | 21.0 | 26.0 | 73 | 12 BTX-S* | 12 BTX-SS* | 12 BTX-B* |
| 22 | 7/8 | 1 3/16-12 | 1 3/8 | 24.0 | 27.5 | 100 | 14 BTX-S | 14 BTX-SS | 14 BTX-B |
| | 1 | 1 5/16-12 | 1 1/2 | 27.5 | 28.5 | 104 | 16 BTX-S | 16 BTX-SS | 16 BTX-B |
| 28, 30, 32 | 1 1/4 | 1 5/8-12 | 2 | 34.0 | 31.0 | 240 | 20 BTX-S | 20 BTX-SS | 20 BTX-B |
| | 35, 38 | 1 7/8-12 | 2 1/4 | 41.0 | 36.0 | 325 | 24 BTX-S | 24 BTX-SS | 24 BTX-B |
| | 2 | 2 1/2-12 | 2 7/8 | 55.0 | 44.5 | 549 | 32 BTX-S | 32 BTX-SS | 32 BTX-B |

Order codes shown are part of our current manufacturing programme.
Do not create drawings from these dimensions, they are subject to change and ISO manufacturing allowances.

***Size 12 BTX-S cannot be used with the metric tube sleeve TXS20 or 20 mm tubes.
This applies to steel, stainless steel and brass.**

K

Triple-Lok®

BMTX Nut

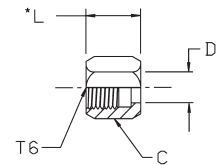
 Triple-Lok® 37° Flare end nut
 SAE 070110

| Tube O.D. | | Thread UN/UNF-2B T6 | C mm | D mm | L mm | Weight (steel) g/1 piece | Triple-Lok® Steel | Triple-Lok® Stainless Steel |
|------------|-------|---------------------|------|------|------|--------------------------|-------------------|-----------------------------|
| mm | in. | | | | | | | |
| 6 | 1/4 | 7/16-20 | 14 | 8.0 | 15.5 | 11 | 4BMTXS | 4BMTXSS |
| 8 | 5/16 | 1/2-20 | 17 | 10.0 | 17.0 | 14 | 5BMTXS | 5BMTXSS |
| 10 | 3/8 | 9/16-18 | 19 | 11.0 | 18.0 | 18 | 6BMTXS | 6BMTXSS |
| 12 | 1/2 | 3/4-16 | 22 | 14.5 | 21.0 | 29 | 8BMTXS | 8BMTXSS |
| 14, 15, 16 | 5/8 | 7/8-14 | 27 | 18.0 | 24.5 | 42 | 10BMTXS | 10BMTXSS |
| 18, 20 | 3/4 | 1 1/16-12 | 32 | 22.0 | 26.0 | 73 | 12BMTXS | 12BMTXSS |
| 25 | 1 | 1 5/16-12 | 41 | 28.0 | 28.0 | 104 | 16BMTXS | 16BMTXSS |
| 28, 30, 32 | 1 1/4 | 1 5/8-12 | 50 | 34.0 | 33.0 | 240 | 20BMTXS | 20BMTXSS |
| 35, 38 | 1 1/2 | 1 7/8-12 | 60 | 41.0 | 38.0 | 325 | 24BMTXS | 24BMTXSS |
| 42 | | 2 1/4-12 | 65 | 48.0 | 40.0 | 437 | 28BMTXS | 28BMTXSS |

Order codes shown are part of our current manufacturing programme.
 Do not create drawings from these dimensions, they are subject to change and ISO manufacturing allowances.

TX Sleeve

Triple-Lok® 37° Flare tube end sleeve for metric tubes
SAE 070105

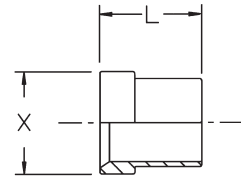

| Tube O.D. mm | L mm | X mm | Weight (steel) g/1 piece | Triple-Lok® Steel | Triple-Lok® Stainless Steel | Triple-Lok® Brass |
|--------------|------|------|--------------------------|-------------------|-----------------------------|-------------------|
| 6 | 10.0 | 9.5 | 2 | TXS6 | TXSS6 | TXB6 |
| 8 | 11.0 | 11.0 | 2 | TXS8 | TXSS8 | TXB8 |
| 10 | 12.5 | 12.5 | 2 | TXS10 | TXSS10 | TXB10 |
| 12 | 14.0 | 17.0 | 7 | TXS12 | TXSS12 | TXB12 |
| 14 | 17.0 | 20.0 | 13 | TXS14 | TXSS14 | TXB14 |
| 15 | 17.0 | 20.0 | 10 | TXS15 | TXSS15 | TXB15 |
| 16 | 17.0 | 20.0 | 7 | TXS16 | TXSS16 | TXB16 |
| 18 | 17.5 | 24.5 | 16 | TXS18 | TXSS18 | TXB18 |
| 20 | 17.5 | 24.5 | 12 | TXS20 | TXSS20 | TXB20 |
| 22 | 19.0 | 28.0 | 25 | TXS22 | TXSS22 | TXB22 |
| 25 | 20.0 | 31.0 | 21 | TXS25 | TXSS25 | TXB25 |
| 28 | 23.0 | 39.0 | 40 | TXS28 | TXSS28 | TXB28 |
| 30 | 23.0 | 39.0 | 45 | TXS30 | TXSS30 | TXB30 |
| 32 | 23.0 | 39.0 | 30 | TXS32 | TXSS32 | TXB32 |
| 35 | 28.5 | 45.0 | 60 | TXS35 | TXSS35 | TXB35 |
| 38 | 28.5 | 45.0 | 51 | TXS38 | TXSS38 | TXB38 |
| 42 | 29.0 | 55.0 | 149 | TXS42 | TXSS42 | TXB42 |

K

Order codes shown are part of our current manufacturing programme.
Do not create drawings from these dimensions, they are subject to change and ISO manufacturing allowances.

Triple-Lok®

TX Sleeve

Triple-Lok® 37° Flare tube sleeve
SAE 070105 MS51533

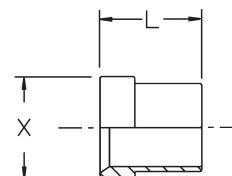

| Tube O.D. in. | L mm | X mm | Weight (steel) g/1 piece | Triple-Lok® Steel | Triple-Lok® Stainless Steel | Triple-Lok® Brass |
|---------------------|---------|---------|--------------------------------|----------------------|--------------------------------|----------------------|
| 1/8 | 8.5 | 7.0 | 2 | 2 TX-S | 2 TX-SS | 2 TX-B |
| 3/16 | 8.5 | 8.0 | 2 | 3 TX-S | 3 TX-SS | 3 TX-B |
| 1/4 | 10.5 | 10.0 | 2 | 4 TX-S | 4 TX-SS | 4 TX-B |
| 5/16 | 11.0 | 11.5 | 2 | 5 TX-S | 5 TX-SS | 5 TX-B |
| 3/8 | 12.5 | 13.0 | 3 | 6 TX-S | 6 TX-SS | 6 TX-B |
| 1/2 | 14.0 | 17.0 | 6 | 8 TX-S | 8 TX-SS | 8 TX-B |
| 5/8 | 17.0 | 20.0 | 8 | 10 TX-S | 10 TX-SS | 10 TX-B |
| 3/4 | 17.0 | 24.5 | 13 | 12 TX-S | 12 TX-SS | 12 TX-B |
| 7/8 | 19.0 | 28.0 | 18 | 14 TX-S | 14 TX-SS | 14 TX-B |
| 1 | 20.0 | 31.0 | 23 | 16 TX-S | 16 TX-SS | 16 TX-B |
| 1 1/4 | 23.0 | 39.0 | 30 | 20 TX-S | 20 TX-SS | 20 TX-B |
| 1 1/2 | 28.0 | 45.0 | 51 | 24 TX-S | 24 TX-SS | 24 TX-B |
| 2 | 30.0 | 61.0 | 156 | 32 TX-S | 32 TX-SS | 32 TX-B |

Order codes shown are part of our current manufacturing programme.
Do not create drawings from these dimensions, they are subject to change and ISO manufacturing allowances.

HMTX Union

Triple-Lok® 37° Flare ends
SAE 070101 MS51501

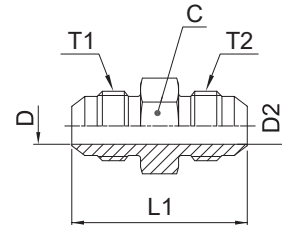

| Tube 1 O.D. | | Tube 2 O.D. | | Thread UN/UNF-2A T1 | Thread UN/UNF-2A T2 | C | D | D2 | L1 | Weight (steel) g/1 piece | Triple-Lok® Steel | Triple-Lok® Stainless Steel | Triple-Lok® Brass | PN (bar) | | |
|----------------|-------|----------------|------------|---------------------------|---------------------------|-----------|------|------|------|--------------------------------|----------------------|--------------------------------|----------------------|------------|-----|-----|
| mm | in. | mm | in. | | | mm | mm | mm | mm | | | | | S | SS | |
| 6 | 1/8 | 6 | 1/8 | 5/16-24 | 5/16-24 | 11.0 | 1.5 | 1.5 | 30.0 | 9 | 2 HTX-S | | | 500 | — | |
| | 3/16 | | 3/16 | 3/8-24 | 3/8-24 | 11.0 | 3.0 | 3.0 | 31.0 | 10 | 3 HTX-S | | | 500 | — | |
| | 1/4 | | 1/4 | 7/16-20 | 7/16-20 | 14.0 | 4.5 | 4.5 | 35.0 | 16 | 4HMTXS | 4HMTXSS | 4HMTXB | 500 | 350 | |
| | 1/4 | | 1/8 | 7/16-20 | 5/16-24 | 12.5 | 4.4 | 1.6 | 32.0 | 12 | 4-2 HTX-S | 4-2HMTXSS | 4-2HMTXB | 500 | 350 | |
| 6 | 1/4 | 6 | 3/16 | 7/16-20 | 3/8-24 | 12.5 | 4.4 | 3.0 | 33.0 | 14 | 4-3 HTX-S | 4-3HMTXSS | 4-3HMTXB | 500 | 350 | |
| 8 | 5/16 | | 8 | 5/16 | 1/2-20 | 1/2-20 | 14.0 | 6.0 | 6.0 | 35.0 | 18 | 5HMTXS | 5HMTXSS | 5HMTXB | 420 | 350 |
| 8 | 5/16 | | 6 | 1/4 | 1/2-20 | 7/16-20 | 14.0 | 6.0 | 4.5 | 35.0 | 18 | 5-4HMTXS | 5-4HMTXSS | 5-4HMTXB | 420 | 350 |
| 10 | 3/8 | | 10 | 3/8 | 9/16-18 | 9/16-18 | 17.0 | 7.5 | 7.5 | 36.0 | 25 | 6HMTXS | 6HMTXSS | 6HMTXB | 420 | 350 |
| 10 | 3/8 | 6 | 1/4 | 9/16-18 | 7/16-20 | 17.0 | 7.5 | 4.5 | 35.5 | 22 | 6-4HMTXS | 6-4HMTXSS | 6-4HMTXB | 420 | 350 | |
| 10 | 3/8 | | 8 | 5/16 | 9/16-18 | 1/2-20 | 17.0 | 7.5 | 6.0 | 36.0 | 25 | 6-5HMTXS | 6-5HMTXSS | 6-5HMTXB | 420 | 350 |
| 12 | 1/2 | | 12 | 1/2 | 3/4-16 | 3/4-16 | 19.0 | 9.9 | 9.9 | 41.0 | 52 | 8HMTXS | 8HMTXSS | 8HMTXB | 420 | 350 |
| 12 | 1/2 | | 6 | 1/4 | 3/4-16 | 7/16-20 | 20.6 | 9.9 | 4.5 | 38.5 | 45 | 8-4 HTX-S | 8-4HMTXSS | 8-4HMTXB | 420 | 350 |
| 12 | 1/2 | 14, 15, 16 | 3/8 | 3/4-16 | 9/16-18 | 20.6 | 9.9 | 7.5 | 38.5 | 45 | 8-6 HTX-S | 8-6HMTXSS | 8-6HMTXB | 420 | 350 | |
| 14, 15, 16 | 5/8 | | 5/8 | 7/8-14 | 7/8-14 | 24.0 | 12.0 | 12.0 | 48.0 | 80 | 10HMTXS | 10HMTXSS | 10HMTXB | 350 | 350 | |
| 14, 15, 16 | 5/8 | | 10 | 3/8 | 7/8-14 | 9/16-18 | 24.0 | 12.3 | 7.5 | 43.0 | 60 | 10-6HMTXS | 10-6HMTXSS | 10-6HMTXB | 350 | 350 |
| 14, 15, 16 | 5/8 | | 12 | 1/2 | 7/8-14 | 3/4-16 | 23.8 | 12.3 | 9.9 | 45.0 | 68 | 10-8 HTX-S | 10-8HMTXSS | 10-8HMTXB | 350 | 350 |
| 18, 20 | 3/4 | 18, 20 | 3/4 | 1 1/16-12 | 1 1/16-12 | 27.0 | 15.5 | 15.5 | 55.0 | 125 | 12HMTXS | 12HMTXSS | 12HMTXB | 350 | 350 | |
| 18, 20 | 3/4 | | 12 | 1/2 | 1 1/16-12 | 3/4-16 | 28.5 | 15.5 | 9.9 | 49.5 | 101 | 12-8 HTX-S | 12-8HMTXSS | 12-8HMTXB | 350 | 350 |
| 20 | 3/4 | | 14, 15, 16 | 5/8 | 1 1/16-12 | 7/8-14 | 27.0 | 15.5 | 12.3 | 52.0 | 113 | 12-10HMTXS | 12-10HMTXSS | 12-10HMTXB | 350 | 350 |
| 22 | 7/8 | | 22 | 7/8 | 1 3/16-12 | 1 3/16-12 | 32.0 | 18.0 | 18.0 | 56.0 | 156 | 14 HTX-S | 14HMTXSS | 14HMTXB | 280 | 280 |
| 25 | 1 | 25 | 1 | 1 5/16-12 | 1 5/16-12 | 36.0 | 21.5 | 21.5 | 57.0 | 131 | 16HMTXS | 16HMTXSS | 16HMTXB | 280 | 280 | |
| 25 | 1 | | 20 | 3/4 | 1 5/16-12 | 1 1/16-12 | 36.0 | 21.5 | 15.5 | 56.0 | 169 | 16-12HMTXS | 16-12HMTXSS | 16-12HMTXB | 280 | 280 |
| 28, 30, 32 | 1 1/4 | | 28, 30, 32 | 1 1/4 | 1 5/8-12 | 1 5/8-12 | 46.0 | 27.5 | 27.5 | 62.0 | 271 | 20HMTXS | 20HMTXSS | 20HMTXB | 280 | 210 |
| 28, 30, 32 | 1 1/4 | | 18, 20 | 3/4 | 1 5/8-12 | 1 1/16-12 | 46.0 | 27.5 | 15.5 | 59.5 | 302 | 20-12HMTXS | 20-12HMTXSS | 20-12HMTXB | 280 | 210 |
| 28, 30, 32 | 1 1/4 | 35, 38 | 25 | 1 5/8-12 | 1 5/16-12 | 46.0 | 27.5 | 21.5 | 60.5 | 313 | 20-16HMTXS | 20-16HMTXSS | 20-16HMTXB | 280 | 210 | |
| 35, 38 | 1 1/2 | | 1 1/2 | 1 7/8-12 | 1 7/8-12 | 50.0 | 33.0 | 33.0 | 70.0 | 382 | 24HMTXS | 24HMTXSS | 24HMTXB | 210 | 210 | |
| 42 | | | 42 | | 2 1/4-12 | 2 1/4-12 | 60.0 | 39.0 | 39.0 | 71.5 | 469 | 28HMTXS | 28HMTXSS | 28HMTXB | 140 | 150 |
| | 2 | | 2 | | 2 1/2-12 | 2 1/2-12 | 67.0 | 45.0 | 45.0 | 86.5 | 785 | 32 HTX-S | 32HMTXSS | 32HMTXB | 140 | 150 |

K

Order codes shown are part of our current manufacturing programme.

Imperial and metric parts may vary in hexagon dimensions.

$$\frac{PN \text{ (bar)}}{10} = PN \text{ (MPa)}$$

Pressure ratings – PN shown, apply to Steel and Stainless Steel versions of the product.

For Brass parts reduce pressures by 35%.

Do not create drawings from these dimensions, they are subject to change and ISO manufacturing allowances.

Triple-Lok®

EMTX Union elbow

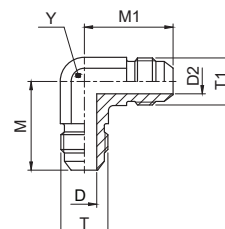
 Triple-Lok® 37° Flare ends
 SAE 070201 MS51505

| Tube O.D. | | Thread UN/UNF-2A T | Thread UN/UNF-2A T1 | D mm | D2 mm | M mm | M1 mm | Y mm | Weight (steel) g/1 piece | Triple-Lok® Steel | Triple-Lok® Stainless Steel | Triple-Lok® Brass | PN (bar) | |
|------------|-------|--------------------|---------------------|--------|-------|------|-------|------|--------------------------|--------------------|-----------------------------|--------------------|----------|-----|
| mm | in. | | | | | | | | | | | | S | SS |
| 6 | 1/8 | 5/16-24 | 5/16-24 | 1.6 | 1.6 | 20.0 | 20.0 | 11 | 18 | 2 ETX-S | | | 500 | — |
| | 3/16 | 3/8-24 | 3/8-24 | 3.0 | 3.0 | 21.0 | 21.0 | 11 | 20 | 3 ETX-S | | | 500 | — |
| | 1/4 | 7/16-20 | 7/16-20 | 4.4 | 4.4 | 22.5 | 22.5 | 11 | 25 | 4EMTXS | 4EMTXSS | 4 ETX-B | 500 | 350 |
| | 8 | 5/16 | 1/2-20 | 1/2-20 | 6.0 | 6.0 | 24.0 | 24.0 | 13 | 5EMTXS | 5EMTXSS | 5 ETX-B | 420 | 350 |
| 10 | 3/8 | 9/16-18 | 9/16-18 | 7.5 | 7.5 | 27.0 | 27.0 | 14 | 44 | 6EMTXS | 6EMTXSS | 6 ETX-B | 420 | 350 |
| | | | | | | | | | | | | | | |
| 10 | 3/8 | 9/16-18 | 7/16-20 | 7.5 | 4.4 | 27.0 | 27.0 | 14 | 40 | 6-4 ETX-S | 6-4EMTXSS | 6-4 ETX-B | 420 | 350 |
| 12 | 1/2 | 3/4-16 | 3/4-16 | 9.9 | 9.9 | 32.0 | 32.0 | 19 | 88 | 8EMTXS | 8EMTXSS | 8 ETX-B | 420 | 350 |
| 12 | 1/2 | 3/4-16 | 9/16-18 | 9.9 | 7.5 | 32.0 | 29.0 | 19 | 75 | 8-6 ETX-S | 8-6EMTXSS | | 420 | — |
| 14, 15, 16 | 5/8 | 7/8-14 | 7/8-14 | 12.3 | 12.3 | 37.0 | 37.0 | 22 | 139 | 10EMTXS | 10EMTXSS | 10 ETX-B | 350 | 350 |
| | | | | | | | | | | | | | | |
| 14, 15, 16 | 5/8 | 7/8-14 | 3/4-16 | 12.3 | 9.9 | 37.0 | 34.0 | 22 | 120 | 10-8 ETX-S | 10-8EMTXSS | 10-8 ETX-B | 350 | 350 |
| 18, 20 | 3/4 | 1 1/16-12 | 1 1/16-12 | 15.5 | 15.5 | 42.0 | 42.0 | 27 | 258 | 12EMTXS | 12EMTXSS | 12 ETX-B | 350 | 350 |
| 18, 20 | 3/4 | 1 1/16-12 | 3/4-16 | 15.5 | 9.9 | 42.0 | 36.0 | 27 | 220 | 12-8 ETX-S | 12-8EMTXSS | | 350 | — |
| 18, 20 | 3/4 | 1 1/16-12 | 7/8-14 | 15.5 | 12.3 | 42.0 | 39.0 | 27 | 240 | 12-10 ETX-S | 12-10EMTXSS | | 350 | — |
| 22 | 7/8 | 1 3/16-12 | 1 3/16-12 | 18.3 | 18.3 | 45.5 | 45.5 | 30 | 273 | 14 ETX-S | 14EMTXSS | | 280 | — |
| 22, 25 | 1 | 1 5/16-12 | 1 5/16-12 | 21.5 | 21.5 | 46.0 | 46.0 | 33 | 333 | 16EMTXS | 16EMTXSS | 16 ETX-B | 280 | 280 |
| 22, 25 | 1 | 1 5/16-12 | 1 1/16-12 | 21.5 | 15.5 | 46.0 | 45.0 | 33 | 310 | 16-12 ETX-S | 16-12EMTXSS | 16-12 ETX-B | 280 | 280 |
| 28, 30, 32 | 1 1/4 | 1 5/8-12 | 1 5/8-12 | 27.5 | 27.5 | 52.0 | 52.0 | 41 | 586 | 20EMTXS | 20EMTXSS | 20 ETX-B | 280 | 210 |
| 35, 38 | 1 1/2 | 1 7/8-12 | 1 7/8-12 | 33.0 | 33.0 | 59.0 | 59.0 | 48 | 778 | 24EMTXS | 24EMTXSS | 24 ETX-B | 210 | 140 |
| 42 | 1 3/4 | 2 1/4-12 | 2 1/4-12 | 39.0 | 39.0 | 74.0 | 74.0 | 63 | 1100 | 28 ETX-S | | | 140 | — |
| | | | | | | | | | | 32 ETX-S | | | 140 | — |

Order codes shown are part of our current manufacturing programme.

Imperial and metric parts may vary in hexagon dimensions.

$$\frac{\text{PN (bar)}}{10} = \text{PN (MPa)}$$

Pressure ratings – PN shown, apply to Steel and Stainless Steel versions of the product.

For Brass parts reduce pressures by 35%.

Do not create drawings from these dimensions, they are subject to change and ISO manufacturing allowances.

JMTX Union tee

Triple-Lok® 37° Flare end (three ends)
SAE 070401 MS51510

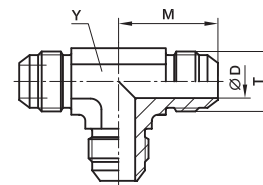

| Tube O.D. | | Thread UN/UNF-2A T | D mm | M mm | Y mm | Weight (steel) g/1 piece | Triple-Lok® Steel | Triple-Lok® Stainless Steel | Triple-Lok® Brass | PN (bar) | |
|------------|-------|--------------------|------|------|------|--------------------------|-------------------|-----------------------------|-------------------|----------|-----|
| mm | in. | | | | | | | | | S | SS |
| 6 | 1/8 | 5/16-24 | 1.6 | 19.5 | 8.0 | 25 | 2 JTX-S | | | 500 | — |
| | 3/16 | 3/8-24 | 3.0 | 21.0 | 11.0 | 30 | 3 JTX-S | | | 500 | — |
| | 1/4 | 7/16-20 | 4.4 | 22.5 | 11.0 | 33 | 4JMTXS | 4JMTXSS | 4 JTX-B | 500 | 350 |
| | 5/16 | 1/2-20 | 6.0 | 24.0 | 13.0 | 42 | 5JMTXS | 5JMTXSS | 5 JTX-B | 420 | 350 |
| 10 | 3/8 | 9/16-18 | 7.5 | 27.0 | 14.0 | 53 | 6JMTXS | 6JMTXSS | 6 JTX-B | 420 | 350 |
| | 1/2 | 3/4-16 | 9.9 | 32.0 | 19.0 | 118 | 8JMTXS | 8JMTXSS | 8 JTX-B | 420 | 350 |
| 14, 15, 16 | 5/8 | 7/8-14 | 12.3 | 37.0 | 22.0 | 182 | 10JMTXS | 10JMTXSS | 10 JTX-B | 350 | 350 |
| | 3/4 | 1 1/16-12 | 15.5 | 42.0 | 27.0 | 291 | 12JMTXS | 12JMTXSS | 12 JTX-B | 350 | 350 |
| 18, 20 | 7/8 | 1 3/16-12 | 18.0 | 45.8 | 33.0 | 403 | 14 JTX-S | 14JMTXSS | 14 JTX-B | 280 | 245 |
| | 1 | 1 5/16-12 | 21.5 | 46.0 | 33.0 | 415 | 16JMTXS | 16JMTXSS | 16 JTX-B | 280 | 280 |
| 28, 30, 32 | 1 1/4 | 1 5/8-12 | 27.5 | 52.0 | 41.0 | 706 | 20JMTXS | 20JMTXSS | 20 JTX-B | 280 | 210 |
| | 1 1/2 | 1 7/8-12 | 33.0 | 59.0 | 48.0 | 990 | 24 JTX-S | 24JMTXSS | 24 JTX-B | 210 | 140 |
| 35, 38 | 1 3/4 | 2 1/4-12 | 39.0 | 74.5 | 63.0 | 2270 | 28 JTX-S | | | 140 | — |
| | 2 | 2 1/2-12 | 45.0 | 78.0 | 63.5 | 2450 | 32 JTX-S | | | 140 | — |

Order codes shown are part of our current manufacturing programme.

Imperial and metric parts may vary in hexagon dimensions.

PN (bar) = PN (MPa)
10

Pressure ratings – PN shown, apply to Steel and Stainless Steel versions of the product.

For Brass parts reduce pressures by 35%.

Union tee reducing up on request.

Do not create drawings from these dimensions, they are subject to change and ISO manufacturing allowances.

K

Triple-Lok®

KTX Union cross

Triple-Lok® 37° Flare end (four ends)
SAE 070501 MS51517

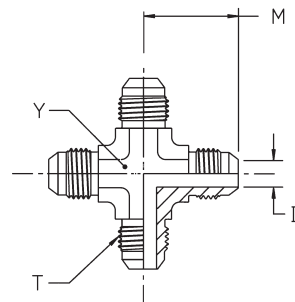

| Tube O.D. | | Thread UN/UNF-2A T | D mm | M mm | Y mm | Weight (steel) g/1 piece | Triple-Lok® Steel | Triple-Lok® Stainless Steel | Triple-Lok® Brass | PN (bar) | |
|------------|------|--------------------|------|------|------|--------------------------|-------------------|-----------------------------|-------------------|----------|-----|
| mm | in. | | | | | | | | | S | SS |
| 6 | 1/4 | 7/16-20 | 4.4 | 22.5 | 11 | 41 | 4 KTX-S | 4 KTX-SS | 4 KTX-B | 500 | 350 |
| 8 | 5/16 | 1/2-20 | 6.0 | 24.0 | 14 | 50 | 5 KTX-S | 5 KTX-SS | 5 KTX-B | 420 | 350 |
| 10 | 3/8 | 9/16-18 | 7.5 | 27.0 | 14 | 68 | 6 KTX-S | 6 KTX-SS | 6 KTX-B | 420 | 350 |
| 12 | 1/2 | 3/4-16 | 9.9 | 31.8 | 19 | 144 | 8 KTX-S | 8 KTX-SS | 8 KTX-B | 420 | 350 |
| 14, 15, 16 | 5/8 | 7/8-14 | 12.0 | 37.0 | 22 | 220 | 10 KTX-S | 10 KTX-SS | 10 KTX-B | 350 | 350 |
| 18, 20 | 3/4 | 1 1/16-12 | 15.5 | 42.0 | 27 | 345 | 12 KTX-S | 12 KTX-SS | 12 KTX-B | 350 | 350 |
| 25 | 1 | 1 5/16-12 | 21.5 | 46.0 | 33 | 588 | 16 KTX-S | 16 KTX-SS | 16 KTX-B | 280 | 280 |

Order codes shown are part of our current manufacturing programme.

Imperial and metric parts may vary in hexagon dimensions.

$$\frac{\text{PN (bar)}}{10} = \text{PN (MPa)}$$

Pressure ratings – PN shown, apply to Steel and Stainless Steel versions of the product.

For Brass parts reduce pressures by 35%.

Do not create drawings from these dimensions, they are subject to change and ISO manufacturing allowances.

WMTX Bulkhead union

Triple-Lok® 37° Flare ends
SAE 070601 MS51520

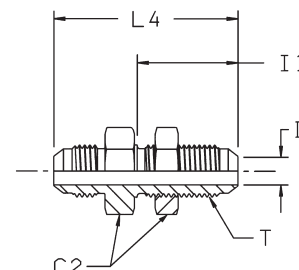

| Tube O.D. mm | in. | Thread UN/UNF-2A T | C2 mm | D mm | I1 mm | L4 mm | Weight (steel) g/1 piece | Triple-Lok® Steel | Triple-Lok® Stainless Steel | Triple-Lok® Brass | PN (bar) | |
|-----------------|-------|--------------------------|----------|---------|----------|----------|--------------------------------|----------------------|--------------------------------|----------------------|----------|-----|
| | | | | | | | | | | | S | SS |
| 6 | 1/4 | 7/16-20 | 17 | 4.4 | 30.5 | 52.5 | 41 | 4WMTXWLNMS | 4WMTXWLNMS | 4WMTXWLNMB | 500 | 350 |
| 8 | 5/16 | 1/2-20 | 19 | 6.0 | 30.5 | 52.5 | 49 | 5WMTXWLNMS | 5WMTXWLNMS | 5WMTXWLNMB | 420 | 350 |
| 10 | 3/8 | 9/16-18 | 22 | 7.5 | 32.5 | 55.5 | 64 | 6WMTXWLNMS | 6WMTXWLNMS | 6WMTXWLNMB | 420 | 350 |
| 12 | 1/2 | 3/4-16 | 24 | 9.9 | 36.5 | 62.0 | 111 | 8WMTXWLNMS | 8WMTXWLNMS | 8WMTXWLNMB | 420 | 350 |
| 14, 15, 16 | 5/8 | 7/8-14 | 30 | 12.3 | 40.0 | 70.0 | 157 | 10WMTXWLNMS | 10WMTXWLNMS | 10WMTXWLNMB | 350 | 350 |
| 18, 20 | 3/4 | 1 1/16-12 | 36 | 15.5 | 44.5 | 78.5 | 254 | 12WMTXWLNMS | 12WMTXWLNMS | 12WMTXWLNMB | 350 | 350 |
| 22 | 7/8 | 1 3/16-12 | 38 | 18.3 | 44.5 | 79.3 | 296 | 14 WTX-WLN-S | 14WMTXWLNMS | 14WMTXWLNMB | 280 | 280 |
| 25 | 1 | 1 5/16-12 | 41 | 21.5 | 44.5 | 80.0 | 337 | 16WMTXWLNMS | 16WMTXWLNMS | 16WMTXWLNMB | 280 | 280 |
| 28, 30, 32 | 1 1/4 | 1 5/8-12 | 50 | 27.5 | 46.0 | 84.0 | 462 | 20WMTXWLNMS | 20WMTXWLNMS | 20WMTXWLNMB | 280 | 210 |
| 35, 38 | 1 1/2 | 1 7/8-12 | 55 | 33.0 | 46.0 | 89.5 | 695 | 24WMTXWLNMS | 24WMTXWLNMS | 24WMTXWLNMB | 210 | 140 |

Order codes shown are part of our current manufacturing programme.

Imperial and metric parts may vary in hexagon dimensions.

For the version without the locknut remove "WLN" (e. g. 16WMTX)

$\frac{\text{PN (bar)}}{10} = \text{PN (MPa)}$

Pressure ratings – PN shown, apply to Steel and Stainless Steel versions of the product.

For Brass parts reduce pressures by 35%.

Do not create drawings from these dimensions, they are subject to change and ISO manufacturing allowances.

Maximum bulkhead wallthickness

| Size | Tube O.D. | | Straight bulkhead union Max. thickness mm | Shape bulkhead union Max. thickness mm |
|------|-----------|--------|---|--|
| | inch | metric | | |
| 4 | 1/4 | 6 | 8.4 | 5.3 |
| 5 | 5/16 | 8 | 8.4 | 5.3 |
| 6 | 3/8 | 10 | 10.7 | 7.1 |
| 8 | 1/2 | 12 | 11.2 | 8.4 |
| 10 | 5/8 | 14-16 | 10.9 | 8.1 |
| 12 | 3/4 | 18-20 | 11.2 | 8.6 |
| 14 | 7/8 | 22 | 10.4 | 7.9 |
| 16 | 1 | 25 | 9.9 | 7.4 |
| 20 | 1 1/4 | 28-32 | 10.2 | 7.4 |
| 24 | 1 1/2 | 35-38 | 7.1 | — |
| 32 | 2 | | 7.1 | — |

Triple-Lok®

WEMTX Bulkhead union elbow

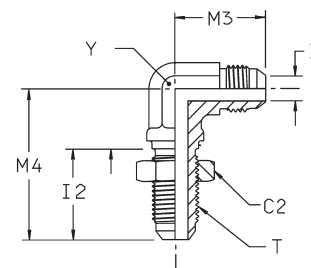
 Triple-Lok® 37° Flare ends
 SAE 070701 MS51507

| Tube O.D. | | Thread UN/UNF-2A T | C2 mm | D mm | I2 mm | M3 mm | M4 mm | Y mm | Weight (steel) g/1 piece | Triple-Lok® Steel | Triple-Lok® Stainless Steel | Triple-Lok® Brass | PN (bar) | |
|------------|-------|--------------------|-------|------|-------|-------|-------|------|--------------------------|----------------------|-----------------------------|----------------------|----------|-----|
| mm | in. | | | | | | | | | | | | S | SS |
| 6 | 1/4 | 7/16-20 | 17.5 | 4.4 | 23 | 25.0 | 40 | 11 | 44 | 4 WETX-WLN-S | 4 WETX-WLN-SS | 4 WETX-WLN-B | 500 | 350 |
| 8 | 5/16 | 1/2-20 | 19.0 | 6.0 | 26 | 27.0 | 44 | 14 | 59 | 5 WEMTXWLNMS | 5 WETX-WLN-SS | 5 WETX-WLN-B | 420 | 350 |
| 10 | 3/8 | 9/16-18 | 22.0 | 7.5 | 28 | 28.0 | 46 | 14 | 72 | 6WEMTXWLNMS | 6 WETX-WLN-SS | 6 WETX-WLN-B | 420 | 350 |
| 12 | 1/2 | 3/4-16 | 24.0 | 9.9 | 32 | 34.5 | 54 | 19 | 145 | 8WEMTXWLNMS | 8 WETX-WLN-SS | 8 WETX-WLN-B | 420 | 350 |
| 14, 15, 16 | 5/8 | 7/8-14 | 30.0 | 12.0 | 35 | 40.0 | 61 | 22 | 212 | 10WEMTXWLNMS | 10 WETX-WLN-SS | 10 WETX-WLN-B | 350 | 350 |
| 18, 20 | 3/4 | 1 1/16-12 | 36.0 | 15.5 | 40 | 45.0 | 68 | 27 | 345 | 12WEMTXWLNMS | 12 WETX-WLN-SS | 12 WETX-WLN-B | 350 | 350 |
| 22 | 7/8 | 1 3/16-12 | 38.0 | 18.0 | 40 | 49.0 | 71 | 33 | 370 | 14 WETX-WLN-S | 14 WETX-WLN-SS | | 280 | 280 |
| 25 | 1 | 1 5/16-12 | 41.0 | 21.5 | 40 | 49.0 | 71 | 33 | 474 | 16 WETX-WLN-S | 16 WETX-WLN-SS | | 280 | 280 |
| 28, 30, 32 | 1 1/4 | 1 5/8-12 | 47.6 | 27.4 | 41 | 55.0 | 79 | 41 | 753 | 20 WETX-WLN-S | 20 WETX-WLN-SS | | 280 | 280 |

Order codes shown are part of our current manufacturing programme.

Imperial and metric parts may vary in hexagon dimensions.

For the version without the locknut remove "WLNMS" (e. g. 16WETX)

$$\frac{\text{PN (bar)}}{10} = \text{PN (MPa)}$$

Pressure ratings – PN shown, apply to Steel and Stainless Steel versions of the product.

For Brass parts reduce pressures by 35%.

Do not create drawings from these dimensions, they are subject to change and ISO manufacturing allowances.

Maximum bulkhead wallthickness

| Size | Tube O.D. | | Straight bulkhead union Max. thickness mm | Shape bulkhead union Max. thickness mm |
|------|-----------|--------|---|--|
| | inch | metric | | |
| 4 | 1/4 | 6 | 8.4 | 5.3 |
| 5 | 5/16 | 8 | 8.4 | 5.3 |
| 6 | 3/8 | 10 | 10.7 | 7.1 |
| 8 | 1/2 | 12 | 11.2 | 8.4 |
| 10 | 5/8 | 14–16 | 10.9 | 8.1 |
| 12 | 3/4 | 18–20 | 11.2 | 8.6 |
| 14 | 7/8 | | 10.4 | 7.9 |
| 16 | 1 | 22–25 | 9.9 | 7.4 |
| 20 | 1 1/4 | 28–32 | 10.2 | 7.4 |
| 24 | 1 1/2 | 35–38 | 7.1 | — |
| 32 | 2 | | 7.1 | — |

WNTX 45° Bulkhead union elbow

Triple-Lok® 37° Flare ends
SAE 070801 MS51509

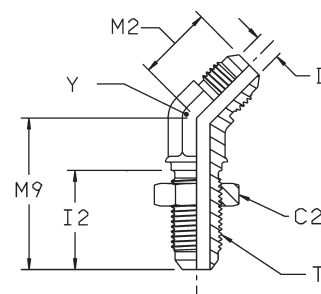

| Tube O.D. | | Thread UN/UNF-2A T | C2 mm | D mm | I2 mm | M2 mm | M9 mm | Y mm | Weight (steel) g/1 piece | Triple-Lok® Steel | Triple-Lok® Stainless Steel | PN (bar) | |
|------------|-------|--------------------|-------|------|-------|-------|-------|------|--------------------------|----------------------|-----------------------------|----------|-----|
| mm | in. | | | | | | | | | | | S | SS |
| 6 | 1/4 | 7/16-20 | 17.5 | 4.4 | 26 | 18 | 39 | 11 | 32 | 4 WNTX-WLN-S | 4 WNTX-WLN-SS | 500 | 350 |
| 8 | 5/16 | 1/2-20 | 19.0 | 6.0 | 26 | 20 | 42 | 14 | 41 | 5 WNTX-WLN-S | 5 WNTX-WLN-SS | 420 | — |
| 10 | 3/8 | 9/16-18 | 20.5 | 7.5 | 28 | 21 | 42 | 14 | 48 | 6 WNTX-WLN-S | 6 WNTX-WLN-SS | 420 | 350 |
| 12 | 1/2 | 3/4-16 | 25.5 | 9.9 | 32 | 33 | 62 | 19 | 105 | 8 WNTX-WLN-S | 8 WNTX-WLN-SS | 420 | 350 |
| 14, 15, 16 | 5/8 | 7/8-14 | 28.5 | 12.3 | 35 | 28 | 55 | 22 | 152 | 10 WNTX-WLN-S | 10 WNTX-WLN-SS | 350 | 350 |
| 18, 20 | 3/4 | 1 1/16-12 | 35.0 | 15.5 | 40 | 33 | 62 | 27 | 245 | 12 WNTX-WLN-S | 12 WNTX-WLN-SS | 350 | 350 |
| 22, 25 | 1 | 1 5/16-12 | 41.0 | 21.5 | 40 | 37 | 65 | 33 | 355 | 16 WNTX-WLN-S | 16 WNTX-WLN-SS | 280 | 280 |
| 28, 30, 32 | 1 1/4 | 1 5/8-12 | 47.6 | 27.4 | 41 | 40 | 67 | 41 | 465 | 20 WNTX-WLN-S | 20 WNTX-WLN-SS | 280 | — |

Order codes shown are part of our current manufacturing programme.

Imperial and metric parts may vary in hexagon dimensions.

For the version without the locknut remove "WLN" (e.g. 16 WNTX)

$$\frac{\text{PN (bar)}}{10} = \text{PN (MPa)}$$

Do not create drawings from these dimensions, they are subject to change and ISO manufacturing allowances.

K

Maximum bulkhead wallthickness

| Size | Tube O.D. | | Straight bulkhead union Max. thickness mm | Shape bulkhead union Max. thickness mm |
|------|-----------|--------|---|--|
| | inch | metric | | |
| 4 | 1/4 | 6 | 8.4 | 5.3 |
| 5 | 5/16 | 8 | 8.4 | 5.3 |
| 6 | 3/8 | 10 | 10.7 | 7.1 |
| 8 | 1/2 | 12 | 11.2 | 8.4 |
| 10 | 5/8 | 14-16 | 10.9 | 8.1 |
| 12 | 3/4 | 18-20 | 11.2 | 8.6 |
| 14 | 7/8 | | 10.4 | 7.9 |
| 16 | 1 | 22-25 | 9.9 | 7.4 |
| 20 | 1 1/4 | 28-32 | 10.2 | 7.4 |
| 24 | 1 1/2 | 35-38 | 7.1 | — |
| 32 | 2 | | 7.1 | — |

Triple-Lok®

WJTX Bulkhead branch tee

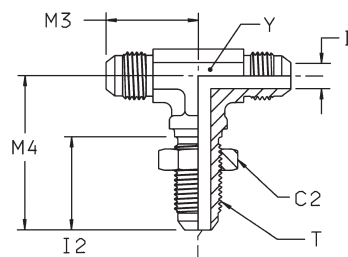
 Triple-Lok® 37° Flare ends
 SAE 070959 MS51515

| Tube O.D. | | Thread UN/UNF-2A T | C2 mm | D mm | I2 mm | M3 mm | M4 mm | Y mm | Weight (steel) g/1 piece | Triple-Lok® Steel | Triple-Lok® Stainless Steel | PN (bar) | |
|------------|-------|--------------------|-------|------|-------|-------|-------|------|--------------------------|----------------------|-----------------------------|----------|-----|
| mm | in. | | | | | | | | | | | S | SS |
| 6 | 1/4 | 7/16-20 | 17.5 | 4.4 | 26 | 25 | 40 | 11.0 | 45 | 4 WJTX-WLN-S | 4 WJTX-WLN-SS | 500 | 350 |
| 10 | 3/8 | 9/16-18 | 20.6 | 7.5 | 28 | 28 | 46 | 14.0 | 71 | 6 WJTX-WLN-S | 6 WJTX-WLN-SS | 420 | 350 |
| 12 | 1/2 | 3/4-16 | 25.0 | 9.9 | 32 | 35 | 54 | 19.0 | 158 | 8 WJTX-WLN-S | 8 WJTX-WLN-SS | 420 | 350 |
| 14, 15, 16 | 5/8 | 7/8-14 | 28.5 | 12.0 | 35 | 40 | 61 | 27.0 | 297 | 10 WJTX-WLN-S | 10 WJTX-WLN-SS | 350 | 350 |
| 18, 20 | 3/4 | 1 1/16-12 | 35.0 | 15.5 | 40 | 45 | 68 | 27.0 | 379 | 12 WJTX-WLN-S | 12 WJTX-WLN-SS | 350 | 350 |
| 22, 25 | 1 | 1 5/16-12 | 41.3 | 21.4 | 40 | 49 | 71 | 33.0 | 420 | 16 WJTX-WLN-S | | 280 | — |
| 28, 30, 32 | 1 1/4 | 1 5/8-12 | 47.6 | 24.4 | 41 | 55 | 79 | 44.5 | 500 | 20 WJTX-WLN-S | | 280 | — |

Order codes shown are part of our current manufacturing programme.

Imperial and metric parts may vary in hexagon dimensions.

For the version without the locknut remove "WLN" (e.g. 16 WJTX)

$$\frac{\text{PN (bar)}}{10} = \text{PN (MPa)}$$

Do not create drawings from these dimensions, they are subject to change and ISO manufacturing allowances.

Maximum bulkhead wallthickness

| Size | Tube O.D. | | Straight bulkhead union Max. thickness mm | Shape bulkhead union Max. thickness mm |
|------|-----------|--------|---|--|
| | inch | metric | | |
| 4 | 1/4 | 6 | 8.4 | 5.3 |
| 5 | 5/16 | 8 | 8.4 | 5.3 |
| 6 | 3/8 | 10 | 10.7 | 7.1 |
| 8 | 1/2 | 12 | 11.2 | 8.4 |
| 10 | 5/8 | 14-16 | 10.9 | 8.1 |
| 12 | 3/4 | 18-20 | 11.2 | 8.6 |
| 14 | 7/8 | | 10.4 | 7.9 |
| 16 | 1 | 22-25 | 9.9 | 7.4 |
| 20 | 1 1/4 | 28-32 | 10.2 | 7.4 |
| 24 | 1 1/2 | 35-38 | 7.1 | — |
| 32 | 2 | | 7.1 | — |

WJJTX Bulkhead run tee

Triple-Lok® 37° Flare ends
SAE 070958 MS51516

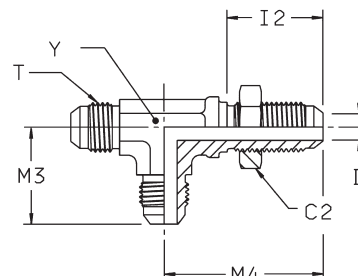

| Tube O.D. | | Thread UN/UNF-2A T | C2 mm | D mm | I2 mm | M3 mm | M4 mm | Y mm | Weight (steel) g/1 piece | Triple-Lok® Steel | PN (bar) |
|------------|-------|--------------------|-------|------|-------|-------|-------|------|--------------------------|-----------------------|----------|
| mm | in. | | | | | | | | | | |
| 6 | 1/4 | 7/16-20 | 17.5 | 4.4 | 26 | 25 | 40 | 11.0 | 58 | 4 WJJTX-WLN-S | 500 |
| 10 | 3/8 | 9/16-18 | 20.6 | 7.5 | 28 | 28 | 46 | 14.0 | 75 | 6 WJJTX-WLN-S | 420 |
| 12 | 1/2 | 3/4-16 | 25.0 | 9.9 | 32 | 35 | 54 | 19.0 | 158 | 8 WJJTX-WLN-S | 420 |
| 14, 15, 16 | 5/8 | 7/8-14 | 28.5 | 12.0 | 35 | 40 | 61 | 27.0 | 309 | 10 WJJTX-WLN-S | 350 |
| 18, 20 | 3/4 | 1 1/16-12 | 35.0 | 15.5 | 40 | 45 | 68 | 27.0 | 340 | 12 WJJTX-WLN-S | 350 |
| 22, 25 | 1 | 1 5/16-12 | 41.3 | 21.5 | 40 | 49 | 71 | 36.5 | 390 | 16 WJJTX-WLN-S | 280 |
| 28, 30, 32 | 1 1/4 | 1 5/8-12 | 47.6 | 27.5 | 41 | 55 | 79 | 44.5 | 450 | 20 WJJTX-WLN-S | 280 |

Order codes shown are part of our current manufacturing programme.

Imperial and metric parts may vary in hexagon dimensions.

For the version without the locknut remove "WLN" (e.g. 16 WJJTX)

$$\frac{\text{PN (bar)}}{10} = \text{PN (MPa)}$$

Do not create drawings from these dimensions, they are subject to change and ISO manufacturing allowances.

K

Maximum bulkhead wallthickness

| Size | Tube O.D. | | Straight bulkhead union Max. thickness mm | Shape bulkhead union Max. thickness mm |
|------|-----------|--------|---|--|
| | inch | metric | | |
| 4 | 1/4 | 6 | 8.4 | 5.3 |
| 5 | 5/16 | 8 | 8.4 | 5.3 |
| 6 | 3/8 | 10 | 10.7 | 7.1 |
| 8 | 1/2 | 12 | 11.2 | 8.4 |
| 10 | 5/8 | 14-16 | 10.9 | 8.1 |
| 12 | 3/4 | 18-20 | 11.2 | 8.6 |
| 14 | 7/8 | | 10.4 | 7.9 |
| 16 | 1 | 22-25 | 9.9 | 7.4 |
| 20 | 1 1/4 | 28-32 | 10.2 | 7.4 |
| 24 | 1 1/2 | 35-38 | 7.1 | — |
| 32 | 2 | | 7.1 | — |

Triple-Lok®

C6MX Swivel nut elbow

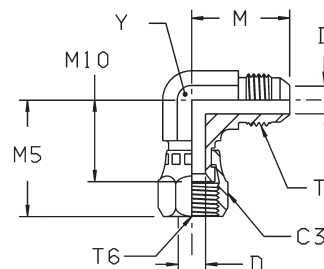
 Triple-Lok® 37° Flare end / Triple-Lok® 37° Flare female swivel end
 SAE 070221 MS51521

| Tube O.D. | | Thread UN/UNF-2A T | Thread UN/UNF-2B T6 | C3 mm | D mm | M mm | M5 mm | M10 mm | Y mm | Weight (steel) g/1 piece | Triple-Lok® Steel | Triple-Lok® Stainless Steel | PN (bar) | |
|------------|-------|--------------------|---------------------|-------|------|------|-------|--------|------|--------------------------|-------------------|-----------------------------|----------|-----|
| mm | in. | | | | | | | | | | | | S | SS |
| 6 | 3/16 | 3/8-24 | 3/8-24 | 14 | 3.0 | 21 | 25 | 18 | 11 | 27 | 3 C6X-S | | 500 | — |
| | 1/4 | 7/16-20 | 7/16-20 | 17 | 4.4 | 23 | 25 | 17 | 13 | 37 | 4C6MXS | 4C6MXSS | 500 | 350 |
| | 5/16 | 1/2-20 | 1/2-20 | 19 | 6.0 | 24 | 25 | 17 | 13 | 43 | 5C6MXS | 5C6MXSS | 420 | 350 |
| | 3/8 | 9/16-18 | 9/16-18 | 22 | 7.5 | 27 | 27 | 22 | 14 | 54 | 6C6MXS | 6C6MXSS | 350 | 350 |
| 8 | 1/2 | 3/4-16 | 3/4-16 | 27 | 9.9 | 32 | 34 | 24 | 19 | 105 | 8C6MXS | 8C6MXSS | 350 | 350 |
| 10 | 5/8 | 7/8-14 | 7/8-14 | 32 | 12.0 | 37 | 40 | 28 | 22 | 162 | 10C6MXS | 10C6MXSS | 350 | 350 |
| 12 | 3/4 | 1 1/16-12 | 1 1/16-12 | 35 | 15.5 | 42 | 42 | 30 | 27 | 260 | 12C6MXS | 12C6MXSS | 350 | 350 |
| 14, 15, 16 | 7/8 | 1 3/16-12 | 1 3/16-12 | 38 | 18.3 | 46 | 45 | 34 | 33 | 293 | 14 C6X-S | | 250 | — |
| 18, 20 | 1 | 1 5/16-12 | 1 5/16-12 | 50 | 21.5 | 46 | 52 | 37 | 33 | 420 | 16C6MXS | 16C6MXSS | 250 | 250 |
| 22 | 1 1/4 | 1 5/8-12 | 1 5/8-12 | 57 | 27.5 | 52 | 59 | 43 | 41 | 679 | 20C6MXS | 20C6MXSS | 250 | 210 |
| 25 | 1 1/2 | 1 7/8-12 | 1 7/8-12 | 73 | 33.0 | 59 | 67 | 47 | 48 | 747 | 24 C6X-S | 24C6MXSS | 170 | 140 |
| 28, 30, 32 | 2 | 2 1/2-12 | 2 1/2-12 | 78 | 45.0 | 78 | 87 | 62 | 64 | 920 | 32 C6X-S | | 110 | — |
| 35, 38 | | | | | | | | | | | | | | |

Order codes shown are part of our current manufacturing programme.

Imperial and metric parts may vary in hexagon dimensions.

$$\frac{\text{PN (bar)}}{10} = \text{PN (MPa)}$$

Do not create drawings from these dimensions, they are subject to change and ISO manufacturing allowances.

V6MX 45° Swivel nut elbow

Triple-Lok® 37° Flare end / Triple-Lok® 37° Flare female swivel end
SAE 070321 MS51522

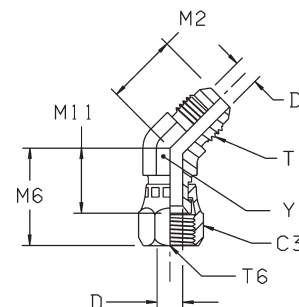

| Tube O.D. | | Thread UN/UNF-2A T | Thread UN/UNF-2B T6 | C3 mm | D mm | M2 mm | M6 mm | M11 mm | Y mm | Weight (steel) g/1 piece | Triple-Lok® Steel | Triple-Lok® Stainless Steel | PN (bar) | |
|------------|-------|--------------------|---------------------|-------|------|-------|-------|--------|------|--------------------------|-------------------|-----------------------------|----------|-----|
| mm | in. | | | | | | | | | | | | S | SS |
| 6 | 1/4 | 7/16-20 | 7/16-20 | 14.3 | 4.4 | 18 | 24 | 15 | 11.0 | 30 | 4 V6X-S | 4 V6X-SS | 500 | 350 |
| 8 | 5/16 | 1/2-20 | 1/2-20 | 16.0 | 6.0 | 20 | 26 | 16 | 14.0 | 45 | 5 V6X-S | 5 V6X-SS | 420 | 350 |
| 10 | 3/8 | 9/16-18 | 9/16-18 | 19.0 | 7.5 | 21 | 29 | 19 | 14.0 | 47 | 6V6MXS | 6 V6X-SS | 350 | 350 |
| 12 | 1/2 | 3/4-16 | 3/4-16 | 22.0 | 9.9 | 25 | 33 | 22 | 19.0 | 89 | 8V6MXS | 8 V6X-SS | 350 | 350 |
| 14, 15, 16 | 5/8 | 7/8-14 | 7/8-14 | 27.0 | 12.3 | 28 | 37 | 24 | 22.0 | 131 | 10V6MXS | 10 V6X-SS | 350 | 350 |
| 18, 20 | 3/4 | 1 1/16-12 | 1 1/16-12 | 32.0 | 15.5 | 33 | 38 | 24 | 27.0 | 203 | 12V6MXS | 12 V6X-SS | 350 | 350 |
| 22 | 7/8 | 1 3/16-12 | 1 3/16-12 | 35.0 | 18.2 | 37 | 43 | 28 | 30.0 | 291 | 14 V6X-S | | 250 | — |
| 25 | 1 | 1 5/16-12 | 1 5/16-12 | 38.0 | 21.4 | 37 | 46 | 30 | 33.3 | 335 | 16 V6X-S | 16 V6X-SS | 250 | 250 |
| 28, 30, 32 | 1 1/4 | 1 5/8-12 | 1 5/8-12 | 50.8 | 27.3 | 40 | 53 | 36 | 41.0 | 572 | 20 V6X-S | 20 V6X-SS | 250 | 210 |
| 35, 38 | 1 1/2 | 1 7/8-12 | 1 7/8-12 | 57.0 | 33.3 | 45 | 58 | 39 | 48.0 | 715 | 24 V6X-S | 24 V6X-SS | 170 | 140 |
| | 2 | 2 1/2-12 | 2 1/2-12 | 73.0 | 45.2 | 56 | 73 | 50 | 66.0 | 960 | 32 V6X-S | 32 V6X-SS | 110 | 110 |

Order codes shown are part of our current manufacturing programme.

Imperial and metric parts may vary in hexagon dimensions.

$$\frac{\text{PN (bar)}}{10} = \text{PN (MPa)}$$

Do not create drawings from these dimensions, they are subject to change and ISO manufacturing allowances.



Triple-Lok®

S6MX Swivel nut branch tee

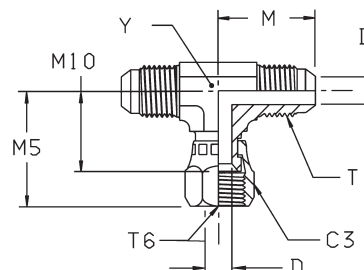
 Triple-Lok® 37° Flare ends / Triple-Lok® 37° Flare female swivel end
 SAE 070433 MS51524

| Tube O.D. | | Thread UN/UNF-2A T | Thread UN/UNF-2B T6 | C3 mm | D mm | M mm | M5 mm | M10 mm | Y mm | Weight (steel) g/1 piece | Triple-Lok® Steel | Triple-Lok® Stainless Steel | PN (bar) | |
|------------|-------|--------------------|---------------------|-------|------|------|-------|--------|------|--------------------------|-------------------|-----------------------------|----------|-----|
| mm | in. | | | | | | | | | | | | S | SS |
| 6 | 1/4 | 7/16-20 | 7/16-20 | 14.3 | 4.4 | 23 | 26 | 17 | 11.0 | 44 | 4 S6X-S | 4 S6X-SS | 500 | 350 |
| 8 | 5/16 | 1/2-20 | 1/2-20 | 17.0 | 6.0 | 24 | 27 | 17 | 13.0 | 58 | 5S6MXS | 5 S6X-SS | 420 | 350 |
| 10 | 3/8 | 9/16-18 | 9/16-18 | 19.0 | 7.5 | 27 | 32 | 22 | 14.0 | 71 | 6S6MXS | 6 S6X-SS | 350 | 350 |
| 12 | 1/2 | 3/4-16 | 3/4-16 | 22.0 | 9.9 | 32 | 35 | 24 | 19.0 | 133 | 8S6MXS | 8 S6X-SS | 350 | 350 |
| 14, 15, 16 | 5/8 | 7/8-14 | 7/8-14 | 27.0 | 12.3 | 37 | 41 | 28 | 22.0 | 203 | 10S6MXS | 10 S6X-SS | 350 | 350 |
| 18, 20 | 3/4 | 1 1/16-12 | 1 1/16-12 | 32.0 | 15.5 | 42 | 43 | 30 | 27.0 | 328 | 12S6MXS | 12 S6X-SS | 350 | 350 |
| 25 | 1 | 1 5/16-12 | 1 5/16-12 | 38.0 | 21.5 | 46 | 52 | 36 | 33.0 | 483 | 16S6MXS | 16 S6X-SS | 250 | 250 |
| 28, 30, 32 | 1 1/4 | 1 5/8-12 | 1 5/8-12 | 50.8 | 27.3 | 52 | 60 | 43 | 41.0 | 708 | 20 S6X-S | 20 S6X-SS | 250 | 210 |
| 35, 38 | 1 1/2 | 1 7/8-12 | 1 7/8-12 | 57.0 | 33.3 | 59 | 68 | 49 | 47.7 | 1100 | 24 S6X-S | 24 S6X-SS | 170 | 170 |

Order codes shown are part of our current manufacturing programme.

Imperial and metric parts may vary in hexagon dimensions.

$$\frac{\text{PN (bar)}}{10} = \text{PN (MPa)}$$

Do not create drawings from these dimensions, they are subject to change and ISO manufacturing allowances.

R6MX Swivel nut run tee

Triple-Lok® 37° Flare ends / Triple-Lok® 37° Flare female swivel end
SAE 070432

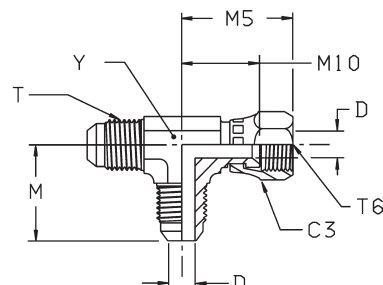

| Tube O.D. | | Thread UN/UNF-2A T | Thread UN/UNF-2B T6 | C3 | D | M | M5 | M10 | Y | Weight (steel) | Triple-Lok® Steel | Triple-Lok® Stainless Steel | PN (bar) | |
|------------|-------|--------------------|---------------------|------|------|----|----|-----|------|----------------|-------------------|-----------------------------|----------|-----|
| mm | in. | | | mm | mm | mm | mm | mm | mm | g/1 piece | | | S | SS |
| 6 | 1/4 | 7/16-20 | 7/16-20 | 14.0 | 4.4 | 23 | 26 | 17 | 11.0 | 44 | 4R6MXS | 4 R6X-SS | 500 | 350 |
| 8 | 5/16 | 1/2-20 | 1/2-20 | 17.0 | 6.0 | 24 | 26 | 17 | 13.0 | 56 | 5R6MXS | 5 R6X-SS | 420 | 350 |
| 10 | 3/8 | 9/16-18 | 9/16-18 | 19.0 | 7.5 | 27 | 32 | 22 | 14.0 | 69 | 6R6MXS | 6 R6X-SS | 350 | 350 |
| 12 | 1/2 | 3/4-16 | 3/4-16 | 22.0 | 9.9 | 32 | 35 | 24 | 19.0 | 136 | 8R6MXS | 8 R6X-SS | 350 | 350 |
| 14, 15, 16 | 5/8 | 7/8-14 | 7/8-14 | 27.0 | 12.3 | 37 | 41 | 28 | 22.0 | 207 | 10R6MXS | 10 R6X-SS | 350 | 350 |
| 18, 20 | 3/4 | 1 1/16-12 | 1 1/16-12 | 32.0 | 15.5 | 42 | 43 | 30 | 27.0 | 319 | 12R6MXS | 12 R6X-SS | 350 | 350 |
| 22 | 7/8 | 1 3/16-12 | 1 3/16-12 | 35.0 | 18.2 | 46 | 46 | 49 | 34.0 | 333 | 14 R6X-S | 14 R6MX-SS | 250 | 250 |
| 25 | 1 | 1 5/16-12 | 1 5/16-12 | 38.0 | 21.5 | 46 | 51 | 36 | 33.0 | 489 | 16R6MXS | 16 R6X-SS | 250 | 250 |
| 28, 30, 32 | 1 1/4 | 1 5/8-12 | 1 5/8-12 | 50.8 | 27.4 | 52 | 60 | 43 | 41.0 | 712 | 20 R6X-S | 20 R6X-SS | 250 | 210 |
| 35, 38 | 1 1/2 | 1 7/8-12 | 1 7/8-12 | 57.0 | 33.3 | 59 | 66 | 47 | 47.7 | 1100 | 24 R6X-S | 24 R6X-SS | 170 | 170 |

Order codes shown are part of our current manufacturing programme.

Imperial and metric parts may vary in hexagon dimensions.

$$\frac{\text{PN (bar)}}{10} = \text{PN (MPa)}$$

Do not create drawings from these dimensions, they are subject to change and ISO manufacturing allowances.



Triple-Lok®

BBMTX Swivel nut female connector

Triple-Lok® 37° Flare fixed female end / Triple-Lok® 37° Flare female swivel end

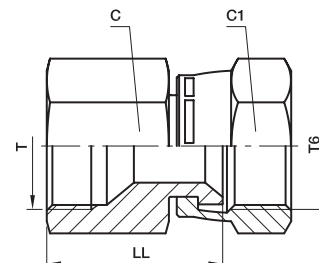

| Tube O.D. | | Thread UN/UNF-2A T | Thread UN/UNF-2B T6 | C mm | C1 mm | LL mm | Weight (steel) g/1 piece | Triple-Lok® Steel | Triple-Lok® Stainless Steel | PN (bar) | |
|------------|-------|--------------------|---------------------|------|-------|-------|--------------------------|-------------------|-----------------------------|----------|-----|
| mm | in. | | | | | | | | | S | SS |
| 6 | 1/4 | 7/16-20 | 7/16-20 | 14 | 14 | 23.0 | 25 | 4BBMTXS | 4BBMTXSS | 500 | 350 |
| 8 | 5/16 | 1/2-20 | 1/2-20 | 17 | 17 | 25.5 | 32 | 5BBMTXS | 5BBMTXSS | 420 | 350 |
| 10 | 3/8 | 9/16-18 | 9/16-18 | 19 | 19 | 25.5 | 60 | 6BBMTXS | 6BBMTXSS | 350 | 350 |
| 12 | 1/2 | 3/4-16 | 3/4-16 | 22 | 22 | 32.0 | 87 | 8BBMTXS | 8BBMTXSS | 350 | 350 |
| 14, 15, 16 | 5/8 | 7/8-14 | 7/8-14 | 27 | 27 | 36.0 | 150 | 10BBMTXS | 10BBMTXSS | 350 | 350 |
| 18, 20 | 3/4 | 1 1/16-12 | 1 1/16-12 | 32 | 32 | 37.0 | 221 | 12BBMTXS | 12BBMTXSS | 350 | 350 |
| 25 | 1 | 1 5/16-12 | 1 5/16-12 | 41 | 38 | 42.0 | 348 | 16BBMTXS | 16BBMTXSS | 250 | 250 |
| 28, 30, 32 | 1 1/4 | 1 5/8-12 | 1 5/8-12 | 50 | 50 | 47.0 | 955 | 20BBMTXS | 20BBMTXSS | 250 | 210 |
| 35, 38 | 1 1/2 | 1 7/8-12 | 1 7/8-12 | 60 | 60 | 54.0 | 1031 | 24BBMTXS | 24BBMTXSS | 170 | 140 |

Order codes shown are part of our current manufacturing programme.

Imperial and metric parts may vary in hexagon dimensions.

$$\frac{\text{PN (bar)}}{10} = \text{PN (MPa)}$$

Do not create drawings from these dimensions, they are subject to change and ISO manufacturing allowances.

TRMTX Tube end reducer

Triple-Lok® 37° Flare end / Triple-Lok® 37° Flare female swivel* end

SAE 070123 MS51534

*Form A Fixed Female Style

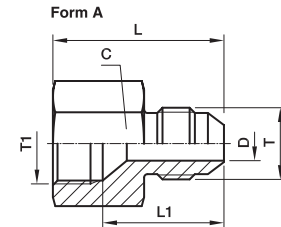
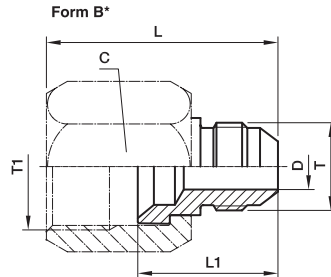

* For Form B, a BTX- or BMTX-nut is required (to be ordered separately)

| Tube Metric T1 O.D. | Tube Metric T O.D. | Tube in. T1 O.D. | Tube in. T O.D. | Thread UN/UNF-2B T1 | Thread UN/UNF-2A T | Typ | C mm | D mm | L mm | L1 mm | Weight (steel) g/1 piece | Triple-Lok® | | PN (bar) | | |
|------------------------------|-----------------------------|---------------------------|--------------------------|---------------------------|--------------------------|-----|---------|---------|---------|----------|--------------------------------|---------------|-----------------|--------------|-----|-----|
| | | | | | | | | | | | | Steel | Stainless Steel | Brass | S | SS |
| 8 | 6 | 5/16 | 1/8 | 7/16-20 | 5/16-24 | B | 14.3 | 1.6 | 29.0 | 19.0 | 16 | 4-2 TRTX-S | 4-2TRMTXSS | 6-4 TRTX-B | 500 | 350 |
| | | | 1/4 | 1/2-20 | 7/16-20 | A | 17.0 | 4.4 | 29.0 | 20.0 | 21 | 5-4TRMTXS | 5-4TRMTXSS | | 420 | 350 |
| | 8 | 3/8 | 1/4 | 9/16-18 | 7/16-20 | B | 19.0 | 4.4 | 36.0 | 24.5 | 35 | 6-4TRTXS | 6-4TRMTXSS | 8-4 TRTX-B | 420 | 350 |
| | | | | 5/16 | 1/2-20 | A | 19.0 | 6.0 | 30.0 | 21.0 | 29 | 6-5TRMTXS | 6-5TRMTXSS | | 420 | 350 |
| 12 | 6 | 1/2 | 1/4 | 3/4-16 | 7/16-20 | B | 22.0 | 4.4 | 38.0 | 25.5 | 38 | 8-4TRTXS | 8-4TRMTXSS | 8-4 TRTX-B | 420 | 350 |
| 12 | 8 | 1/2 | 5/16 | 3/4-16 | 1/2-20 | B | 22.0 | 6.0 | 38.0 | 25.5 | 35 | 8-5TRTXS | 8-5TRMTXSS | 8-6 TRTX-B | 420 | 350 |
| 12 | 10 | 1/2 | 3/8 | 3/4-16 | 9/16-18 | B | 22.0 | 7.5 | 38.0 | 25.5 | 32 | 8-6TRTXS | 8-6TRMTXSS | | 420 | 350 |
| 14, 15, 16 | 6 | 5/8 | 1/4 | 7/8-14 | 7/16-20 | B | 27.0 | 4.4 | 41.0 | 26.0 | 83 | 10-4 TRTX-S | 10-4TRMTXSS | 10-6 TRTX-B | 350 | 350 |
| 14, 15, 16 | 8 | 5/8 | 5/16 | 7/8-14 | 1/2-20 | B | 27.0 | 6.0 | 41.0 | 26.0 | 80 | 10-5TRTXS | 10-5TRMTXSS | | 350 | 350 |
| 14, 15, 16 | 10 | 5/8 | 3/8 | 7/8-14 | 9/16-18 | B | 27.0 | 7.5 | 41.0 | 26.0 | 78 | 10-6 TRTX-S | 10-6TRMTXSS | 10-6 TRTX-B | 350 | 350 |
| 14, 15, 16 | 12 | 5/8 | 1/2 | 7/8-14 | 3/4-16 | A | 27.0 | 9.9 | 36.5 | 24.5 | 73 | 10-8TRMTXS | 10-8TRMTXSS | 12-4 TRTX-B | 350 | 350 |
| 18, 20 | 6 | 3/4 | 1/4 | 1 1/16-12 | 7/16-20 | B | 31.8 | 4.4 | 42.5 | 27.5 | 120 | 12-4 TRTX-S | 12-4TRMTXSS | | 350 | 350 |
| 18, 20 | 8 | 3/4 | 5/16 | 1 1/16-12 | 1/2-20 | B | 32.0 | 6.0 | 42.5 | 27.5 | 118 | 12-5TRTXS | 12-5TRMTXSS | 12-6 TRTX-B | 350 | 350 |
| 18, 20 | 10 | 3/4 | 3/8 | 1 1/16-12 | 9/16-18 | B | 31.8 | 7.5 | 43.0 | 27.5 | 115 | 12-6 TRTX-S | 12-6TRMTXSS | | 350 | 350 |
| 18, 20 | 12 | 3/4 | 1/2 | 1 1/16-12 | 3/4-16 | B | 32.0 | 9.9 | 45.0 | 30.0 | 128 | 12-8TRTXS | 12-8TRMTXSS | 12-8 TRTX-B | 350 | 350 |
| 18, 20 | 14, 15, 16 | 3/4 | 5/8 | 1 1/16-12 | 7/8-14 | A | 32.0 | 12.3 | 42.0 | 29.5 | 119 | 12-10TRMTXS | 12-10TRMTXSS | 12-10 TRTX-B | 350 | 350 |
| 22 | 10 | 7/8 | 3/8 | 1 3/16-12 | 9/16-18 | B | 35.0 | 7.5 | 45.0 | 29.0 | 102 | 14-6 TRTX-S | 14-6TRMTXSS | | 350 | 350 |
| 22 | 14, 15, 16 | 7/8 | 5/8 | 1 3/16-12 | 7/8-14 | B | 35.0 | 12.3 | 50.0 | 34.0 | 120 | 14-10 TRTX-S | 14-10TRMTXSS | 14-12 TRTX-B | 350 | 350 |
| 22 | 18, 20 | 7/8 | 3/4 | 1 3/16-12 | 1 1/16-12 | A | 35.0 | 15.5 | 46.5 | 33.0 | 166 | 14-12 TRTX-S | 14-12TRMTXSS | | 350 | 350 |
| 25 | 6 | 1 | 1/4 | 1 5/16-12 | 7/16-20 | B | 38.0 | 4.4 | 46.5 | 31.0 | 205 | 16-4 TRTX-S | 16-4TRMTXSS | 16-4 TRTX-B | 310 | 350 |
| 25 | 10 | 1 | 3/8 | 1 5/16-12 | 9/16-18 | B | 41.0 | 7.5 | 46.5 | 29.5 | 215 | 16-6TRTXS | 16-6TRMTXSS | 16-8 TRTX-B | 310 | 350 |
| 25 | 12 | 1 | 1/2 | 1 5/16-12 | 3/4-16 | B | 38.0 | 9.9 | 49.0 | 32.0 | 228 | 16-8 TRTX-S | 16-8TRMTXSS | | 310 | 350 |
| 25 | 14, 15, 16 | 1 | 5/8 | 1 5/16-12 | 7/8-14 | B | 41.0 | 12.3 | 52.0 | 34.5 | 239 | 16-10TRTXS | 16-10TRMTXSS | 16-12 TRTX-B | 310 | 350 |
| 25 | 18, 20 | 1 | 3/4 | 1 5/16-12 | 1 1/16-12 | B | 41.0 | 15.5 | 54.5 | 37.0 | 252 | 16-12TRTXS | 16-12TRMTXSS | | 310 | 280 |
| 25 | 22 | 1 | 7/8 | 1 5/16-12 | 1 3/16-12 | A | 38.0 | 18.2 | 48.5 | 34.0 | 224 | 16-14 TRTXN-S | 16-14TRMTXSS | 16-14 TRTX-B | 310 | 280 |
| 28, 30, 32 | 12 | 1 1/4 | 1/2 | 1 5/8-12 | 3/4-16 | B | 50.0 | 9.9 | 54.0 | 36.0 | 380 | 20-8TRTXS | 20-8TRMTXSS | 20-10 TRTX-B | 280 | 280 |
| 28, 30, 32 | 14, 15, 16 | 1 1/4 | 5/8 | 1 5/8-12 | 7/8-14 | B | 50.0 | 12.3 | 56.0 | 38.0 | 380 | 20-10TRTXS | 20-10TRMTXSS | | 280 | 280 |
| 28, 30, 32 | 18, 20 | 1 1/4 | 3/4 | 1 5/8-12 | 1 1/16-12 | B | 50.0 | 15.5 | 57.0 | 39.0 | 370 | 20-12TRTXS | 20-12TRMTXSS | 20-16 TRTX-B | 280 | 280 |
| 28, 30, 32 | 25 | 1 1/4 | 1 | 1 5/8-12 | 1 5/16-12 | B | 50.0 | 21.5 | 59.0 | 40.5 | 355 | 20-16TRTXS | 20-16TRMTXSS | | 280 | 280 |
| 35, 38 | 20 | 1 1/2 | 3/4 | 1 7/8-12 | 1 1/16-12 | B | 60.0 | 15.5 | 63.0 | 41.5 | 520 | 24-12TRTXS | 24-12TRMTXSS | 24-16 TRTX-B | 210 | 280 |
| 35, 38 | 25 | 1 1/2 | 1 | 1 7/8-12 | 1 5/16-12 | B | 57.0 | 21.5 | 63.0 | 41.5 | 570 | 24-16 TRTX-S | 24-16TRMTXSS | | 210 | 140 |
| 35, 38 | 28, 30, 32 | 1 1/2 | 1 1/4 | 1 7/8-12 | 1 5/8-12 | B | 57.0 | 27.4 | 64.0 | 43.0 | 614 | 24-20 TRTX-S | 24-20TRMTXSS | 28-24 TRTX-B | 210 | 140 |
| 42 | 35, 38 | | | 2 1/4-12 | 1 7/8-12 | B | 65.0 | 33.3 | 72.0 | 48.5 | 839 | 28-24TRTXS | 28-24TRMTXSS | | 140 | 140 |
| 50 | 38 | 2 | 1 1/2 | 2 1/2-12 | 1 7/8-12 | B | 73.0 | 33.3 | 75.0 | 48.5 | 900 | 32-24 TRTX-S | | 140 | — | |

Order codes shown are part of our current manufacturing programme.

Imperial and metric parts may vary in hexagon dimensions.

$$\frac{\text{PN (bar)}}{10} = \text{PN (MPa)}$$

Pressure ratings – PN shown, apply to Steel and Stainless Steel versions of the product.

For Brass parts reduce pressures by 35 %

Do not create drawings from these dimensions, they are subject to change and ISO manufacturing allowances.

Triple-Lok®
HMX6 Swivel nut union

Triple-Lok® 37° Flare female swivel ends

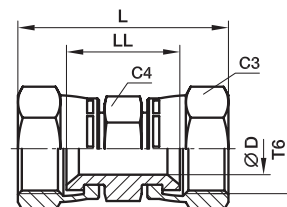

| Tube O.D. | | Thread UN/UNF-2B T6 | C3 mm | C4 mm | D mm | L mm | LL mm | Weight (steel) g/1 piece | Triple-Lok® Steel | Triple-Lok® Stainless Steel | PN (bar) | |
|------------|-----------|---------------------|-------|-------|------|------|-------|--------------------------|-------------------|-----------------------------|----------|-----|
| mm | in. | | | | | | | | | | S | SS |
| 6 | 1/4 | 7/16-20 | 14.3 | 14.3 | 4.4 | 38 | 20 | 27 | 4 HX6-S | 4HMX6SS | 500 | 500 |
| 8, 10 | 5/16, 3/8 | 9/16-18 | 17.5 | 17.5 | 7.5 | 45 | 26 | 35 | 6 HX6-S | 6HMX6SS | 350 | 350 |
| 12 | 1/2 | 3/4-16 | 22.2 | 22.2 | 9.9 | 51 | 29 | 64 | 8 HX6-S | 8HMX6SS | 350 | 350 |
| 14, 15, 16 | 5/8 | 7/8-14 | 25.4 | 25.4 | 12.3 | 58 | 32 | 115 | 10 HX6-S | 10HMX6SS | 350 | 350 |
| 18, 20 | 3/4 | 1 1/16-12 | 31.8 | 31.8 | 15.5 | 62 | 33 | 185 | 12 HX6-S | 12HMX6SS | 350 | 350 |
| 25 | 1 | 1 5/16-12 | 38.0 | 38.0 | 21.4 | 68 | 38 | 235 | 16 HX6-S | 16HMX6SS | 250 | 250 |

Order codes shown are part of our current manufacturing programme.

Imperial and metric parts may vary in hexagon dimensions.

$$\frac{\text{PN (bar)}}{10} = \text{PN (MPa)}$$

Do not create drawings from these dimensions, they are subject to change and ISO manufacturing allowances.

JX6 Swivel nut union tee

Triple-Lok® 37° Flare female swivel ends

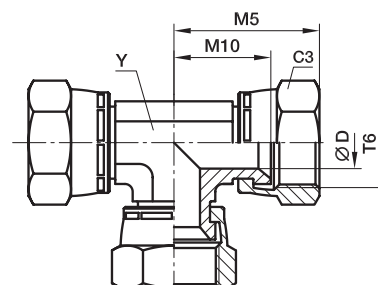

| Tube O.D. | | Thread UN/UNF-2B T6 | C3 mm | D mm | M5 mm | M10 mm | Y mm | Weight (steel) g/1 piece | Triple-Lok® Steel | PN (bar) |
|------------|-----------|---------------------|-------|------|-------|--------|------|--------------------------|-------------------|----------|
| mm | in. | | | | | | | | | |
| 6 | 1/4 | 7/16-20 | 14.3 | 4.4 | 26 | 17 | 11 | 55 | 4 JX6-S | 500 |
| 8, 10 | 5/16, 3/8 | 9/16-18 | 17.5 | 7.5 | 32 | 22 | 14 | 85 | 6 JX6-S | 350 |
| 12 | 1/2 | 3/4-16 | 22.2 | 9.9 | 35 | 24 | 19 | 150 | 8 JX6-S | 350 |
| 14, 15, 16 | 5/8 | 7/8-14 | 25.4 | 12.3 | 42 | 29 | 22 | 220 | 10 JX6-S | 350 |
| 18, 20 | 3/4 | 1 1/16-12 | 31.8 | 15.5 | 42 | 30 | 27 | 345 | 12 JX6-S | 350 |
| 25 | 1 | 1 5/16-12 | 38.0 | 21.4 | 52 | 36 | 30 | 510 | 16 JX6-S | 250 |

Order codes shown are part of our current manufacturing programme.

Imperial and metric parts may vary in hexagon dimensions.

$\frac{\text{PN (bar)}}{10} = \text{PN (MPa)}$

Do not create drawings from these dimensions, they are subject to change and ISO manufacturing allowances.

K

Triple-Lok®

F87OMX Male stud connector

Triple-Lok® 37° Flare end / Male metric thread – O-ring (ISO 6149)

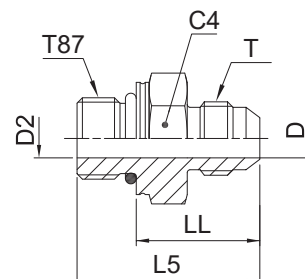

| Tube O.D. | | Thread Metric T87 | Thread UN/UNF-2A T | C4 mm | D mm | D2 mm | L5 mm | LL mm | Weight (steel) g/1 piece | Triple-Lok® Steel | Triple-Lok® Stainless Steel | PN (bar) | |
|------------|-------|-------------------|--------------------|-------|------|-------|-------|-------|--------------------------|-------------------|-----------------------------|----------|-----|
| mm | in. | | | | | | | | | | | S | SS |
| 6 | 1/4 | M 10×1.0 | 7/16-20 | 14 | 4.4 | 4.4 | 30.0 | 21.5 | 25 | 4M10F87OMXS | 4M10F87OMXS | 500 | 350 |
| 8 | 5/16 | M 10×1.0 | 1/2-20 | 14 | 4.4 | 6.0 | 30.0 | 21.5 | 30 | 5M10F87OMXS | 5M10F87OMXS | 420 | 350 |
| 8 | 5/16 | M 12×1.5 | 1/2-20 | 19 | 6.0 | 6.0 | 33.0 | 22.0 | 37 | 5M12F87OMXS | 5M12F87OMXS | 420 | 350 |
| 8 | 5/16 | M 14×1.5 | 1/2-20 | 19 | 6.0 | 6.0 | 34.0 | 23.0 | 40 | 5M14F87OMXS | 5M14F87OMXS | 420 | 350 |
| 10 | 3/8 | M 14×1.5 | 9/16-18 | 19 | 7.5 | 7.5 | 34.0 | 23.0 | 44 | 6M14F87OMXS | 6M14F87OMXS | 420 | 350 |
| 10 | 3/8 | M 16×1.5 | 9/16-18 | 22 | 7.5 | 7.5 | 35.5 | 24.5 | 53 | 6M16F87OMXS | 6M16F87OMXS | 420 | 350 |
| 10 | 3/8 | M 18×1.5 | 9/16-18 | 24 | 7.5 | 7.5 | 36.5 | 24.0 | 60 | 6M18F87OMXS | 6M18F87OMXS | 350 | 350 |
| 12 | 1/2 | M 14×1.5 | 3/4-16 | 19 | 9.9 | 7.5 | 36.0 | 25.0 | 41 | 8M14F87OMXS | 8M14F87OMXS | 420 | 350 |
| 12 | 1/2 | M 16×1.5 | 3/4-16 | 22 | 9.9 | 9.0 | 38.0 | 26.5 | 57 | 8M16F87OMXS | 8M16F87OMXS | 420 | 350 |
| 12 | 1/2 | M 18×1.5 | 3/4-16 | 24 | 9.9 | 9.9 | 39.0 | 26.5 | 71 | 8M18F87OMXS | 8M18F87OMXS | 350 | 350 |
| 14, 15, 16 | 5/8 | M 14×1.5 | 7/8-14 | 24 | 12.3 | 7.5 | 40.5 | 29.5 | 73 | 10M14F87OMXS | 10M14F87OMXS | 350 | 350 |
| 14, 15, 16 | 5/8 | M 18×1.5 | 7/8-14 | 24 | 12.3 | 11.0 | 43.0 | 30.5 | 75 | 10M18F87OMXS | 10M18F87OMXS | 350 | 350 |
| 14, 15, 16 | 5/8 | M 22×1.5 | 7/8-14 | 27 | 12.3 | 12.3 | 43.5 | 30.5 | 98 | 10M22F87OMXS | 10M22F87OMXS | 350 | 350 |
| 14, 15, 16 | 5/8 | M 27×2.0 | 7/8-14 | 32 | 12.3 | 12.3 | 46.0 | 30.0 | 75 | 10M27F87OMXS | 10M27F87OMXS | 350 | 350 |
| 18, 20 | 3/4 | M 22×1.5 | 1 1/16-12 | 27 | 15.5 | 14.0 | 48.0 | 35.0 | 104 | 12M22F87OMXS | 12M22F87OMXS | 350 | 350 |
| 18, 20 | 3/4 | M 27×2.0 | 1 1/16-12 | 32 | 15.5 | 15.5 | 51.0 | 35.0 | 158 | 12M27F87OMXS | 12M27F87OMXS | 350 | 350 |
| 25 | 1 | M 27×2.0 | 1 5/16-12 | 36 | 21.5 | 18.0 | 50.5 | 34.5 | 206 | 16M27F87OMXS | 16M27F87OMXS | 280 | 280 |
| 25 | 1 | M 33×2.0 | 1 5/16-12 | 41 | 21.5 | 21.5 | 53.0 | 37.0 | 273 | 16M33F87OMXS | 16M33F87OMXS | 280 | 280 |
| 28, 30, 32 | 1 1/4 | M 42×2.0 | 1 5/8-12 | 50 | 27.5 | 30.0 | 55.0 | 39.0 | 431 | 20M42F87OMXS | 20M42F87OMXS | 280 | 210 |
| 35, 38 | 1 1/2 | M 48×2.0 | 1 7/8-12 | 55 | 33.0 | 33.0 | 59.0 | 41.5 | 564 | 24M48F87OMXS | 24M48F87OMXS | 210 | 140 |

Steel, stainless steel and brass Triple-Lok® parts are delivered with NBR elastomeric seals as standard. For more details on other seal materials see page K92.

Order codes shown are part of our current manufacturing programme.

Imperial and metric parts may vary in hexagon dimensions.

$$\frac{\text{PN (bar)}}{10} = \text{PN (MPa)}$$

Do not create drawings from these dimensions, they are subject to change and ISO manufacturing allowances.

F5OMX Male stud connector

Triple-Lok® 37° Flare end / Male UN/UNF thread – O-ring (ISO 11926)
SAE 070120 MS51525

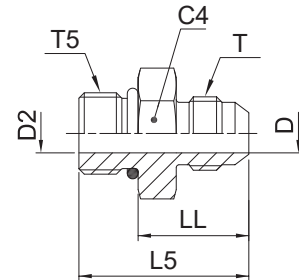

| Tube O.D. mm | in. | Thread UN/UNF-2A T5 | Thread UN/UNF-2A T | C4 mm | D mm | D2 mm | L5 mm | LL mm | Weight (steel) g/1 piece | Triple-Lok® Steel | Triple-Lok® Stainless Steel | PN (bar) | |
|--------------------|------|---------------------------|--------------------------|----------|---------|----------|----------|----------|--------------------------------|----------------------|--------------------------------|----------|-----|
| | | | | | | | | | | | | S | SS |
| 6 | 1/8 | 5/16-24 | 5/16-24 | 11.0 | 1.6 | 1.6 | 27.0 | 19.0 | 8 | 2 F5OX-S | | 500 | — |
| | 3/16 | 3/8-24 | 3/8-24 | 13.0 | 3.0 | 3.0 | 28.0 | 20.0 | 10 | 3 F5OX-S | | 500 | — |
| | 3/16 | 5/16-24 | 3/8-24 | 13.0 | 3.0 | 1.6 | 28.0 | 20.0 | 9 | 3-2 F5OX-S | | 500 | — |
| | 1/4 | 7/16-20 | 7/16-20 | 14.3 | 4.4 | 4.4 | 31.0 | 22.0 | 15 | 4F5OMXS | 4F5OMXS | 500 | 350 |
| 6 | 1/4 | 3/8-24 | 7/16-20 | 14.3 | 4.4 | 3.0 | 30.0 | 23.0 | 12 | | 4-3F5OMXS | 500 | 350 |
| 6 | 1/4 | 1/2-20 | 7/16-20 | 16.0 | 4.4 | 4.4 | 31.0 | 22.0 | 25 | 4-5 F5OX-S | 4-5F5OMXS | 420 | 350 |
| 6 | 1/4 | 9/16-18 | 7/16-20 | 17.0 | 4.4 | 4.4 | 33.0 | 23.0 | 27 | 4-6F5OMXS | 4-6F5OMXS | 420 | 350 |
| 6 | 1/4 | 3/4-16 | 7/16-20 | 22.3 | 4.4 | 4.4 | 35.0 | 24.0 | 35 | 4-8 F5OX-S | 4-8F5OMXS | 420 | 350 |
| 6 | 1/4 | 7/8-14 | 7/16-20 | 25.5 | 4.4 | 4.4 | 38.0 | 25.0 | 60 | 4-10 F5OX-S | 4-10F5OMXS | 350 | 350 |
| 8 | 5/16 | 1/2-20 | 1/2-20 | 17.0 | 6.0 | 6.0 | 31.0 | 22.0 | 18 | 5F5OMXS | 5F5OMXS | 420 | 350 |
| 8 | 5/16 | 7/16-20 | 1/2-20 | 14.0 | 6.0 | 4.5 | 31.0 | 22.0 | 18 | 5-4F5OMXS | 5-4F5OMXS | 420 | 350 |
| 8 | 5/16 | 9/16-18 | 1/2-20 | 17.5 | 6.0 | 6.0 | 33.0 | 23.0 | 25 | 5-6 F5OX-S | 5-6F5OMXS | 420 | 350 |
| 8 | 5/16 | 3/4-16 | 1/2-20 | 22.2 | 6.0 | 6.0 | 35.0 | 24.0 | 40 | 5-8 F5OX-S | 5-8F5OMXS | 420 | 350 |
| 10 | 3/8 | 9/16-18 | 9/16-18 | 17.0 | 7.5 | 7.5 | 33.0 | 23.0 | 25 | 6F5OMXS | 6F5OMXS | 420 | 350 |
| 10 | 3/8 | 7/16-20 | 9/16-18 | 16.0 | 7.5 | 4.4 | 32.0 | 23.0 | 40 | 6-4 F5OX-S | 6-4F5OMXS | 420 | 350 |
| 10 | 3/8 | 1/2-20 | 9/16-18 | 16.0 | 7.5 | 6.0 | 32.0 | 23.0 | 56 | 6-5 F5OX-S | 6-5F5OMXS | 420 | 350 |
| 10 | 3/8 | 3/4-16 | 9/16-18 | 22.0 | 7.5 | 7.5 | 35.0 | 24.0 | 44 | 6-8F5OMXS | 6-8F5OMXS | 420 | 350 |
| 10 | 3/8 | 7/8-14 | 9/16-18 | 27.0 | 7.5 | 7.5 | 38.0 | 25.0 | 85 | 6-10F5OMXS | 6-10F5OMXS | 350 | 350 |
| 10 | 3/8 | 1 1/16-12 | 9/16-18 | 31.8 | 7.5 | 15.5 | 42.0 | 27.0 | 100 | 6-12 F5OX-S | 6-12F5OMXS | 350 | 350 |
| 12 | 1/2 | 3/4-16 | 3/4-16 | 22.0 | 9.9 | 9.9 | 38.0 | 27.0 | 58 | 8F5OMXS | 8F5OMXS | 420 | 350 |
| 12 | 1/2 | 7/16-20 | 3/4-16 | 20.5 | 9.9 | 4.4 | 38.0 | 29.0 | 40 | 8-4 F5OX-S | 8-4F5OMXS | 420 | 350 |
| 12 | 1/2 | 9/16-18 | 3/4-16 | 19.0 | 9.9 | 7.5 | 36.5 | 26.5 | 44 | 8-6F5OMXS | 8-6F5OMXS | 420 | 350 |
| 12 | 1/2 | 7/8-14 | 3/4-16 | 27.0 | 9.9 | 9.9 | 41.0 | 28.0 | 73 | 8-10F5OMXS | 8-10F5OMXS | 350 | 350 |
| 12 | 1/2 | 1 1/16-12 | 3/4-16 | 32.0 | 9.9 | 9.9 | 45.0 | 30.0 | 126 | 8-12F5OMXS | 8-12F5OMXS | 350 | 350 |
| 12 | 1/2 | 1 5/16-12 | 3/4-16 | 38.0 | 9.9 | 9.9 | 45.0 | 30.0 | 160 | 8-16 F5OX-S | 8-16F5OMXS | 310 | 310 |
| 14, 15, 16 | 5/8 | 7/8-14 | 7/8-14 | 27.0 | 12.3 | 12.3 | 43.0 | 30.5 | 75 | 10F5OMXS | 10F5OMXS | 350 | 350 |
| 14, 15, 16 | 5/8 | 9/16-18 | 7/8-14 | 23.8 | 12.3 | 7.5 | 43.0 | 33.0 | 60 | 10-6 F5OX-S | 10-6F5OMXS | 350 | 350 |
| 14, 15, 16 | 5/8 | 3/4-16 | 7/8-14 | 24.0 | 12.3 | 9.9 | 42.0 | 30.5 | 65 | 10-8F5OMXS | 10-8F5OMXS | 350 | 350 |
| 14, 15, 16 | 5/8 | 1 1/16-12 | 7/8-14 | 32.0 | 12.3 | 12.3 | 47.0 | 32.0 | 132 | 10-12F5OMXS | 10-12F5OMXS | 350 | 350 |
| 14, 15, 16 | 5/8 | 1 5/16-12 | 7/8-14 | 38.0 | 12.3 | 12.3 | 48.0 | 33.0 | 170 | 10-16 F5OX-S | 10-16F5OMXS | 310 | 310 |
| 18, 20 | 3/4 | 1 1/16-12 | 1 1/16-12 | 32.0 | 15.5 | 15.5 | 50.0 | 35.0 | 134 | 12F5OMXS | 12F5OMXS | 350 | 350 |
| 18, 20 | 3/4 | 3/4-16 | 1 1/16-12 | 28.6 | 15.5 | 9.9 | 49.0 | 38.0 | 104 | 12-8 F5OX-S | 12-8F5OMXS | 350 | 350 |
| 18, 20 | 3/4 | 7/8-14 | 1 1/16-12 | 27.0 | 15.5 | 12.3 | 48.0 | 35.0 | 108 | 12-10F5OMXS | 12-10F5OMXS | 350 | 350 |
| 18, 20 | 3/4 | 1 3/16-12 | 1 1/16-12 | 35.0 | 15.5 | 15.5 | 50.0 | 35.0 | 170 | 12-14 F5OX-S | 12-14F5OMXS | 310 | 310 |
| 18, 20 | 3/4 | 1 5/16-12 | 1 1/16-12 | 38.0 | 15.5 | 21.5 | 50.5 | 35.5 | 197 | 12-16 F5OX-S | 12-16F5OMXS | 310 | 310 |
| 18, 20 | 3/4 | 1 5/8-12 | 1 1/16-12 | 47.6 | 15.5 | 15.5 | 53.0 | 38.0 | 230 | 12-20 F5OX-S | 12-20F5OMXS | 280 | 280 |
| 22 | 7/8 | 1 3/16-12 | 1 3/16-12 | 35.0 | 18.2 | 18.2 | 51.0 | 36.0 | 174 | 14 F5OX-S | 14F5OMXS | 280 | 280 |
| 22 | 7/8 | 1 5/16-12 | 1 3/16-12 | 38.0 | 18.2 | 18.2 | 51.0 | 36.0 | 223 | 14-16 F5OX-S | 14-16F5OMXS | 280 | 280 |
| 25 | 1 | 1 5/16-12 | 1 5/16-12 | 41.0 | 21.5 | 21.5 | 52.0 | 36.5 | 203 | 16F5OMXS | 16F5OMXS | 280 | 280 |
| 25 | 1 | 3/4-16 | 1 5/16-12 | 35.0 | 21.4 | 9.9 | 45.0 | 34.0 | 160 | 16-8 F5OX-S | 16-8F5OMXS | 280 | 280 |

Continued on page K28

Triple-Lok®

F5OMX Male stud connector

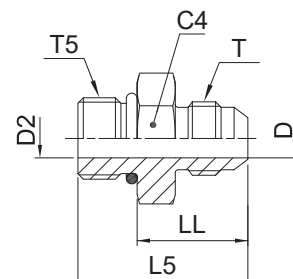
 Triple-Lok® 37° Flare end / Male UN/UNF thread – O-ring (ISO 11926)
 SAE 070120 MS51525

| Tube O.D. | | Thread UN/UNF-2A T5 | Thread UN/UNF-2A T | C4 | D | D2 | L5 | LL | Weight (steel) g/1 piece | Triple-Lok® Steel | Triple-Lok® Stainless Steel | PN (bar) | |
|------------|-------|---------------------|--------------------|------|------|------|----|------|--------------------------|---------------------|-----------------------------|----------|-----|
| mm | in. | | | mm | mm | mm | mm | mm | | | | S | SS |
| 25 | 1 | 7/8-14 | 1 5/16-12 | 35.0 | 21.4 | 12.3 | 53 | 40.0 | 183 | 16-10 F5OX-S | 16-10F5OMXSS | 280 | 280 |
| 25 | 1 | 1 1/16-12 | 1 5/16-12 | 36.0 | 21.4 | 15.5 | 52 | 36.5 | 204 | 16-12F5OMXS | 16-12F5OMXSS | 280 | 280 |
| 25 | 1 | 1 3/16-12 | 1 5/16-12 | 35.0 | 21.4 | 18.3 | 52 | 37.0 | 198 | 16-14 F5OX-S | 16-14F5OMXSS | 280 | 280 |
| 25 | 1 | 1 5/8-12 | 1 5/16-12 | 47.6 | 21.4 | 21.4 | 54 | 39.0 | 270 | 16-20 F5OX-S | 16-20F5OMXSS | 280 | 280 |
| 25 | 1 | 1 7/8-12 | 1 5/16-12 | 54.0 | 21.4 | 21.4 | 56 | 41.0 | 310 | 16-24 F5OX-S | 16-24F5OMXSS | 210 | 210 |
| 28, 30, 32 | 1 1/4 | 1 5/8-12 | 1 5/8-12 | 50.0 | 27.5 | 27.5 | 55 | 40.0 | 274 | 20F5OMXS | 20F5OMXSS | 280 | 210 |
| 28, 30, 32 | 1 1/4 | 1 1/16-12 | 1 5/8-12 | 43.0 | 27.4 | 15.5 | 58 | 43.0 | 250 | 20-12 F5OX-S | 20-12F5OMXSS | 280 | 210 |
| 28, 30, 32 | 1 1/4 | 1 5/16-12 | 1 5/8-12 | 43.0 | 27.4 | 21.4 | 59 | 44.0 | 280 | 20-16 F5OX-S | 20-16F5OMXSS | 280 | 210 |
| 28, 30, 32 | 1 1/4 | 1 7/8-12 | 1 5/16-12 | 54.0 | 27.4 | 27.4 | 57 | 42.0 | 454 | 20-24 F5OX-S | 20-24F5OMXSS | 280 | 210 |
| 35, 38 | 1 1/2 | 1 7/8-12 | 1 7/8-12 | 55.0 | 33.0 | 33.0 | 60 | 45.0 | 355 | 24F5OMXS | 24F5OMXSS | 210 | 140 |
| 35, 38 | 1 1/2 | 1 5/8-12 | 1 7/8-12 | 51.0 | 33.3 | 27.4 | 64 | 49.0 | 340 | 24-20 F5OX-S | 24-20F5OMXSS | 210 | 140 |
| 35, 38 | 1 1/2 | 2 1/2-12 | 1 7/8-12 | 70.0 | 33.3 | 33.3 | 64 | 49.0 | 400 | 24-32 F5OX-S | | 140 | — |
| | 2 | 2 1/2-12 | 2 1/2-12 | 70.0 | 45.2 | 45.2 | 71 | 56.0 | 650 | 32 F5OX-S | | 140 | — |
| | 2 | 1 7/8-12 | 2 1/2-12 | 66.7 | 45.2 | 33.3 | 75 | 60.0 | 600 | 32-24 F5OX-S | | 140 | — |

Steel, stainless steel and brass Triple-Lok® parts are delivered with NBR elastomeric seals as standard. For more details on other seal materials see page K92.

Order codes shown are part of our current manufacturing programme.

Imperial and metric parts may vary in hexagon dimensions.

$$\frac{\text{PN (bar)}}{10} = \text{PN (MPa)}$$

Do not create drawings from these dimensions, they are subject to change and ISO manufacturing allowances.

FF50MX Extended male stud connector

Triple-Lok® 37° Flare end / Male UN/UNF thread – O-ring (ISO 11926)
SAE 070122 MS51526

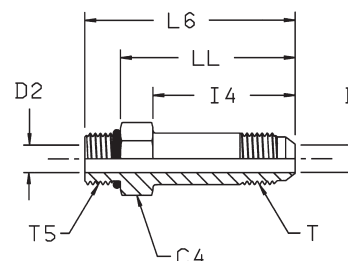

| Tube O.D. | | Thread UN/UNF-2A T5 | Thread UN/UNF-2A T | C4 | D | D2 | I4 | L6 | LL | Weight (steel) | Triple-Lok® Steel | Triple-Lok® Stainless Steel | PN (bar) | |
|------------|-------|---------------------|--------------------|------|------|------|----|-----|-----|----------------|-------------------|-----------------------------|----------|-----|
| mm | in. | | | mm | mm | mm | mm | mm | mm | g/1 piece | | | S | SS |
| 6 | 1/4 | 7/16-20 | 7/16-20 | 14.3 | 4.4 | 4.4 | 35 | 53 | 44 | 33 | 4 FF50X-S | 4 FF50X-SS | 500 | 500 |
| 10 | 3/8 | 9/16-18 | 9/16-18 | 17.5 | 7.5 | 7.5 | 40 | 59 | 49 | 53 | 6 FF50X-S | 6 FF50X-SS | 420 | 420 |
| 12 | 1/2 | 3/4-16 | 3/4-16 | 22.2 | 9.9 | 9.9 | 48 | 69 | 58 | 104 | 8 FF50X-S | 8 FF50X-SS | 420 | 420 |
| 14, 15, 16 | 5/8 | 7/8-14 | 7/8-14 | 25.4 | 12.3 | 12.3 | 53 | 77 | 64 | 151 | 10 FF50X-S | 10 FF50X-SS | 350 | 350 |
| 18, 20 | 3/4 | 1 1/16-12 | 1 1/16-12 | 31.8 | 15.5 | 15.5 | 64 | 92 | 77 | 277 | 12 FF50X-S | 12 FF50X-SS | 350 | 350 |
| 25 | 1 | 1 5/16-12 | 1 5/16-12 | 38.0 | 21.4 | 21.4 | 72 | 101 | 86 | 458 | 16 FF50X-S | 16 FF50X-SS | 280 | 280 |
| 28, 30, 32 | 1 1/4 | 1 5/8-12 | 1 5/8-12 | 47.6 | 27.4 | 27.4 | 88 | 119 | 104 | 862 | 20 FF50X-S | 20 FF50X-SS | 280 | 280 |

Steel, stainless steel and brass Triple-Lok® parts are delivered with NBR elastomeric seals as standard. For more details on other seal materials see page K92.

Order codes shown are part of our current manufacturing programme.

Imperial and metric parts may vary in hexagon dimensions.

$$\frac{\text{PN (bar)}}{10} = \text{PN (MPa)}$$

Do not create drawings from these dimensions, they are subject to change and ISO manufacturing allowances.

K

Triple-Lok®

F42EDMX Male stud connector

Triple-Lok® 37° Flare end / Male BSPP thread – ED seal (ISO 1179)

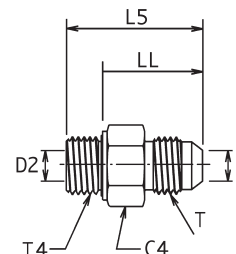

| Tube O.D. | | Thread BSPP T4 | Thread UN/UNF-2A T | C4 mm | D mm | D2 mm | L5 mm | LL mm | Weight (steel) g/1 piece | Triple-Lok® | | PN (bar) | |
|------------|-------|----------------|--------------------|-------|------|-------|-------|-------|--------------------------|---------------|-----------------|----------|-----|
| mm | in. | | | | | | | | | Steel | Stainless Steel | S | SS |
| 6 | 1/4 | 1/8-28 | 7/16-20 | 14 | 4.4 | 4.4 | 30.0 | 22.0 | 20 | 4F42EDMXS | 4F42EDMXSS | 500 | 350 |
| 6 | 1/4 | 1/4-19 | 7/16-20 | 19 | 4.4 | 4.4 | 35.0 | 23.0 | 34 | 4-4F42EDMXS | 4-4F42EDMXSS | 420 | 350 |
| 6 | 1/4 | 3/8-19 | 7/16-20 | 22 | 4.4 | 9.0 | 36.0 | 24.0 | 47 | 4-6F42EDMXS | 4-6F42EDMXSS | 420 | 350 |
| 6 | 1/4 | 1/2-14 | 7/16-20 | 27 | 4.4 | 14.0 | 39.5 | 25.5 | 99 | 4-8F42EDMXS | 4-8F42EDMXSS | 350 | 350 |
| 6 | 1/4 | 3/4-14 | 7/16-20 | 32 | 4.4 | 16.0 | 43.0 | 27.0 | 88 | 4-12F42EDMXS | 4-12F42EDMXSS | 350 | 350 |
| 8 | 5/16 | 1/8-28 | 1/2-20 | 14 | 6.0 | 4.0 | 30.0 | 22.0 | 20 | 5F42EDMXS | 5F42EDMXSS | 420 | 350 |
| 8 | 5/16 | 1/4-19 | 1/2-20 | 19 | 6.0 | 6.0 | 35.0 | 23.0 | 30 | 5-4F42EDMXS | 5-4F42EDMXSS | 420 | 350 |
| 8 | 5/16 | 3/8-19 | 1/2-20 | 22 | 6.0 | 9.0 | 36.0 | 24.0 | 47 | 5-6F42EDMXS | 5-6F42EDMXSS | 420 | 350 |
| 10 | 3/8 | 1/4-19 | 9/16-18 | 19 | 7.5 | 6.0 | 35.0 | 23.0 | 28 | 6F42EDMXS | 6F42EDMXSS | 420 | 350 |
| 10 | 3/8 | 1/8-28 | 9/16-18 | 17 | 7.5 | 4.0 | 31.0 | 23.0 | 27 | 6-2F42EDMXS | 6-2F42EDMXSS | 420 | 350 |
| 10 | 3/8 | 3/8-19 | 9/16-18 | 22 | 7.5 | 7.5 | 36.0 | 24.0 | 40 | 6-6F42EDMXS | 6-6F42EDMXSS | 420 | 350 |
| 10 | 3/8 | 1/2-14 | 9/16-18 | 27 | 7.5 | 14.0 | 39.5 | 25.5 | 95 | 6-8F42EDMXS | 6-8F42EDMXSS | 350 | 350 |
| 10 | 3/8 | 3/4-14 | 9/16-18 | 32 | 7.5 | 16.0 | 45.5 | 29.5 | 100 | 6-12F42EDMXS | 6-12F42EDMXSS | 350 | 350 |
| 12 | 1/2 | 3/8-19 | 3/4-16 | 22 | 9.9 | 9.0 | 38.5 | 26.5 | 50 | 8F42EDMXS | 8F42EDMXSS | 420 | 350 |
| 12 | 1/2 | 1/4-19 | 3/4-16 | 19 | 9.9 | 6.0 | 39.0 | 27.0 | 40 | 8-4F42EDMXS | 8-4F42EDMXSS | 420 | 350 |
| 12 | 1/2 | 1/2-14 | 3/4-16 | 27 | 9.9 | 9.9 | 42.0 | 28.0 | 100 | 8-8F42EDMXS | 8-8F42EDMXSS | 350 | 350 |
| 12 | 1/2 | 3/4-14 | 3/4-16 | 32 | 9.9 | 16.0 | 46.0 | 30.0 | 100 | 8-12F42EDMXS | 8-12F42EDMXSS | 350 | 350 |
| 12 | 1/2 | 1-11 | 3/4-16 | 41 | 9.9 | 23.0 | 53.0 | 35.0 | 150 | 8-16F42EDMXS | 8-16F42EDMXSS | 280 | 280 |
| 14, 15, 16 | 5/8 | 1/2-14 | 7/8-14 | 27 | 12.3 | 12.3 | 45.0 | 31.0 | 103 | 10F42EDMXS | 10F42EDMXSS | 350 | 350 |
| 14, 15, 16 | 5/8 | 1/4-19 | 7/8-14 | 24 | 12.3 | 6.0 | 41.0 | 29.0 | 110 | 10-4F42EDMXS | 10-4F42EDMXSS | 350 | 350 |
| 14, 15, 16 | 5/8 | 3/8-19 | 7/8-14 | 24 | 12.3 | 9.0 | 43.0 | 31.0 | 65 | 10-6F42EDMXS | 10-6F42EDMXSS | 350 | 350 |
| 14, 15, 16 | 5/8 | 3/4-14 | 7/8-14 | 32 | 12.3 | 16.0 | 48.0 | 32.0 | 160 | 10-12F42EDMXS | 10-12F42EDMXSS | 350 | 350 |
| 14, 15, 16 | 5/8 | 1-11 | 7/8-14 | 41 | 12.3 | 23.0 | 51.0 | 33.0 | 205 | 10-16F42EDMXS | 10-16F42EDMXSS | 280 | 280 |
| 18, 20 | 3/4 | 3/4-14 | 1 1/16-12 | 32 | 15.5 | 15.5 | 51.0 | 35.0 | 165 | 12F42EDMXS | 12F42EDMXSS | 350 | 350 |
| 18, 20 | 3/4 | 3/8-19 | 1 1/16-12 | 27 | 15.5 | 9.0 | 50.0 | 38.0 | 105 | 12-6F42EDMXS | 12-6F42EDMXSS | 350 | 350 |
| 18, 20 | 3/4 | 1/2-14 | 1 1/16-12 | 27 | 15.5 | 14.0 | 49.0 | 35.0 | 118 | 12-8F42EDMXS | 12-8F42EDMXSS | 350 | 350 |
| 18, 20 | 3/4 | 1-11 | 1 1/16-12 | 41 | 15.5 | 23.0 | 53.5 | 34.5 | 292 | 12-16F42EDMXS | 12-16F42EDMXSS | 280 | 280 |
| 18, 20 | 3/4 | 1 1/4-11 | 1 1/16-12 | 50 | 15.5 | 30.0 | 62.0 | 42.0 | 220 | 12-20F42EDMXS | 12-20F42EDMXSS | 280 | 210 |
| 22 | 7/8 | 3/4-14 | 1 3/16-12 | 32 | 18.0 | 18.0 | 51.0 | 35.0 | 173 | 14F42EDMXS | 14F42EDMXSS | 280 | 280 |
| 25 | 1 | 1-11 | 1 5/16-12 | 41 | 21.5 | 21.5 | 55.0 | 37.0 | 262 | 16F42EDMXS | 16F42EDMXSS | 280 | 280 |
| 25 | 1 | 1/2-14 | 1 5/16-12 | 36 | 21.5 | 14.0 | 54.0 | 40.0 | 145 | 16-8F42EDMXS | 16-8F42EDMXSS | 280 | 280 |
| 25 | 1 | 3/4-14 | 1 5/16-12 | 36 | 21.5 | 16.0 | 53.0 | 37.0 | 217 | 16-12F42EDMXS | 16-12F42EDMXSS | 280 | 280 |
| 25 | 1 | 1 1/4-11 | 1 5/16-12 | 50 | 21.5 | 25.0 | 59.0 | 39.0 | 386 | 16-20F42EDMXS | 16-20F42EDMXSS | 280 | 280 |
| 28, 30, 32 | 1 1/4 | 1 1/4-11 | 1 5/8-12 | 50 | 27.5 | 25.0 | 60.0 | 40.0 | 375 | 20F42EDMXS | 20F42EDMXSS | 280 | 210 |
| 28, 30, 32 | 1 1/4 | 3/4-14 | 1 5/8-12 | 46 | 27.5 | 16.0 | 59.5 | 43.5 | 220 | 20-12F42EDMXS | 20-12F42EDMXSS | 280 | 210 |
| 28, 30, 32 | 1 1/4 | 1-11 | 1 5/8-12 | 46 | 27.5 | 23.0 | 62.0 | 44.0 | 255 | 20-16F42EDMXS | 20-16F42EDMXSS | 280 | 210 |
| 28, 30, 32 | 1 1/4 | 1 1/2-11 | 1 5/8-12 | 55 | 27.5 | 32.0 | 64.0 | 42.0 | 420 | 20-24F42EDMXS | 20-24F42EDMXSS | 210 | 140 |
| 35, 38 | 1 1/2 | 1 1/2-11 | 1 7/8-12 | 55 | 33.0 | 32.0 | 67.0 | 45.0 | 480 | 24F42EDMXS | 24F42EDMXSS | 210 | 140 |
| 35, 38 | 1 1/2 | 1-11 | 1 7/8-12 | 50 | 33.0 | 23.0 | 63.0 | 45.0 | 390 | 24-16F42EDMXS | 24-16F42EDMXSS | 210 | 210 |
| 35, 38 | 1 1/2 | 1 1/4-11 | 1 7/8-12 | 50 | 33.0 | 30.0 | 62.0 | 42.0 | 420 | 24-20F42EDMXS | 24-20F42EDMXSS | 210 | 210 |
| 42 | | 1 1/2-11 | 2 1/4-12 | 60 | 39.0 | 36.0 | 71.0 | 49.0 | 746 | 28-24F42EDMXS | 28-24F42EDMXSS | 140 | 105 |

Steel, stainless steel and brass Triple-Lok® parts are delivered with NBR elastomeric seals as standard. For more details on other seal materials see page K92.

Order codes shown are part of our current manufacturing programme. Imperial and metric parts may vary in hexagon dimensions.

$$\frac{\text{PN (bar)}}{10} = \text{PN (MPa)}$$

Do not create drawings from these dimensions, they are subject to change and ISO manufacturing allowances.

FF42EDMX Extended male stud connector

Triple-Lok® 37° Flare end / Male BSPP thread - ED seal (ISO 1179-2)
SAE 070122

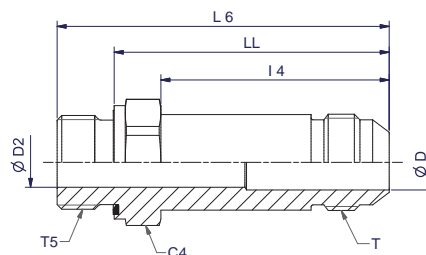

| Tube O.D. | | Thread UN/UNF-2A T | Thread BSPP T5 | C4 mm | D mm | D2 mm | I4 mm | L6 mm | LL mm | Weight (steel) g/1 piece | Triple-Lok® Steel | Triple-Lok® Stainless Steel | PN (bar) | |
|------------|------|--------------------|----------------|-------|------|-------|-------|-------|-------|--------------------------|--------------------|-----------------------------|----------|-----|
| mm | inch | | | | | | | | | | | | S | SS |
| 10 | 3/8 | 9/16-18 | 1/4-19 | 19 | 8 | 6 | 40 | 61 | 49 | 60 | 6FF42EDMXS | 6FF42EDMXSS | 420 | 350 |
| 12 | 1/2 | 3/4-16 | 3/8-19 | 22 | 10 | 9 | 48 | 70 | 58 | 100 | 8FF42EDMXS | 8FF42EDMXSS | 420 | 350 |
| 14, 15, 16 | 5/8 | 7/8-14 | 1/2-14 | 27 | 12 | 12 | 53 | 79 | 65 | 170 | 10FF42EDMXS | 10FF42EDMXSS | 350 | 350 |
| 18, 20 | 3/4 | 1 1/16-12 | 3/4-14 | 32 | 16 | 16 | 64 | 93 | 77 | 280 | 12FF42EDMXS | 12FF42EDMXSS | 350 | 350 |

Steel, stainless steel and brass Triple-Lok® parts are delivered with NBR elastomeric seals as standard. For more details on other materials see page K92.

Order codes shown are part of our current manufacturing programme.

Imperial and metric parts may vary in hexagon dimensions.

$$\frac{\text{PN (bar)}}{10} = \text{PN (MPa)}$$

Do not create drawings from these dimensions, they are subject to change and ISO manufacturing allowances.

K

Triple-Lok®

F4OMX Male stud connector

Triple-Lok® 37° Flare end / Male BSPP thread – O-ring + retaining ring (ISO 1179)

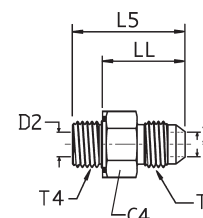

| Tube O.D. | | Thread BSPP T4 | Thread UN/UNF-2A T | C4 mm | D mm | D2 mm | L5 mm | LL mm | Weight (steel) g/1 piece | Triple-Lok® Steel | Triple-Lok® Stainless Steel | PN (bar) | |
|------------|-------|----------------|--------------------|-------|------|-------|-------|-------|--------------------------|-------------------|-----------------------------|----------|-----|
| mm | in. | | | | | | | | | | | S | SS |
| 6 | 1/4 | 1/8-28 | 7/16-20 | 17 | 4.4 | 4.4 | 28.0 | 21.0 | 20 | 4F4OMXS | 4F4OMXS | 350 | 350 |
| 6 | 1/4 | 1/4-19 | 7/16-20 | 19 | 4.4 | 4.4 | 32.0 | 21.0 | 34 | 4-4F4OMXS | 4-4F4OMXS | 350 | 350 |
| 6 | 1/4 | 3/8-19 | 7/16-20 | 22 | 4.4 | 4.4 | 33.0 | 22.0 | 47 | 4-6F4OMXS | 4-6F4OMXS | 350 | 350 |
| 6 | 1/4 | 1/2-14 | 7/16-20 | 30 | 4.4 | 4.4 | 39.0 | 24.0 | 99 | 4-8F4OMXS | 4-8F4OMXS | 350 | 350 |
| 8 | 5/16 | 1/8-28 | 1/2-20 | 17 | 6.0 | 4.4 | 28.0 | 21.0 | 25 | 5F4OMXS | 5F4OMXS | 350 | 350 |
| 8 | 5/16 | 1/4-19 | 1/2-20 | 19 | 6.0 | 6.0 | 32.0 | 21.0 | 30 | 5-4F4OMXS | 5-4F4OMXS | 350 | 350 |
| 8 | 5/16 | 3/8-19 | 1/2-20 | 22 | 6.0 | 6.0 | 33.0 | 22.0 | 47 | 5-6F4OMXS | 5-6F4OMXS | 350 | 350 |
| 10 | 3/8 | 1/4-19 | 9/16-18 | 19 | 7.5 | 6.0 | 32.5 | 21.0 | 28 | 6F4OMXS | 6F4OMXS | 350 | 350 |
| 10 | 3/8 | 1/8-28 | 9/16-18 | 17 | 7.5 | 4.4 | 29.0 | 22.0 | 27 | 6-2F4OMXS | 6-2F4OMXS | 350 | 350 |
| 10 | 3/8 | 3/8-19 | 9/16-18 | 22 | 7.5 | 7.5 | 33.0 | 22.0 | 40 | 6-6F4OMXS | 6-6F4OMXS | 350 | 350 |
| 10 | 3/8 | 1/2-14 | 9/16-18 | 30 | 7.5 | 7.5 | 38.0 | 23.5 | 25 | 6-8F4OMXS | 6-8F4OMXS | 350 | 350 |
| 10 | 3/8 | 3/4-14 | 9/16-18 | 36 | 7.5 | 7.5 | 39.5 | 25.0 | 100 | 6-12F4OMXS | 6-12F4OMXS | 280 | 280 |
| 12 | 1/2 | 3/8-19 | 3/4-16 | 22 | 9.9 | 9.9 | 36.0 | 25.0 | 50 | 8F4OMXS | 8F4OMXS | 350 | 350 |
| 12 | 1/2 | 1/4-19 | 3/4-16 | 19 | 9.9 | 6.0 | 41.0 | 24.0 | 40 | 8-4F4OMXS | 8-4F4OMXS | 350 | 350 |
| 12 | 1/2 | 1/2-14 | 3/4-16 | 30 | 9.9 | 9.9 | 41.0 | 27.0 | 100 | 8-8F4OMXS | 8-8F4OMXS | 350 | 350 |
| 12 | 1/2 | 3/4-14 | 3/4-16 | 36 | 9.9 | 9.9 | 42.0 | 28.5 | 100 | 8-12F4OMXS | 8-12F4OMXS | 280 | 250 |
| 12 | 1/2 | 1-11 | 3/4-16 | 46 | 9.9 | 9.9 | 47.0 | 29.0 | 150 | 8-16F4OMXS | 8-16F4OMXS | 280 | 250 |
| 14, 15, 16 | 5/8 | 1/2-14 | 7/8-14 | 30 | 12.3 | 12.3 | 43.0 | 28.5 | 103 | 10F4OMXS | 10F4OMXS | 350 | 350 |
| 14, 15, 16 | 5/8 | 1/4-19 | 7/8-14 | 24 | 12.3 | 6.0 | 39.0 | 28.0 | 110 | 10-4F4OMXS | 10-4F4OMXS | 350 | 350 |
| 14, 15, 16 | 5/8 | 3/8-19 | 7/8-14 | 24 | 12.3 | 9.0 | 39.0 | 28.0 | 65 | 10-6F4OMXS | 10-6F4OMXS | 350 | 350 |
| 14, 15, 16 | 5/8 | 3/4-14 | 7/8-14 | 36 | 12.3 | 12.3 | 45.0 | 30.5 | 160 | 10-12F4OMXS | 10-12F4OMXS | 280 | 250 |
| 18, 20 | 3/4 | 3/4-14 | 1 1/16-12 | 36 | 15.5 | 15.5 | 47.5 | 33.0 | 165 | 12F4OMXS | 12F4OMXS | 280 | 250 |
| 18, 20 | 3/4 | 3/8-19 | 1 1/16-12 | 27 | 15.5 | 9.0 | 44.0 | 34.0 | 97 | 12-6F4OMXS | 12-6F4OMXS | 350 | 250 |
| 18, 20 | 3/4 | 1/2-14 | 1 1/16-12 | 30 | 15.5 | 12.0 | 47.0 | 32.0 | 118 | 12-8F4OMXS | 12-8F4OMXS | 350 | 350 |
| 18, 20 | 3/4 | 1-11 | 1 1/16-12 | 46 | 15.5 | 15.5 | 52.5 | 34.0 | 292 | 12-16F4OMXS | 12-16F4OMXS | 280 | 250 |
| 18, 20 | 3/4 | 1 1/4-11 | 1 1/16-12 | 50 | 15.5 | 15.5 | 53.0 | 34.5 | 220 | 12-20F4OMXS | 12-20F4OMXS | 250 | 175 |
| 25 | 1 | 1-11 | 1 5/16-12 | 46 | 21.5 | 21.5 | 53.5 | 35.0 | 262 | 16F4OMXS | 16F4OMXS | 280 | 250 |
| 25 | 1 | 1/2-14 | 1 5/16-12 | 36 | 21.5 | 12.0 | 48.5 | 34.0 | 145 | 16-8F4OMXS | 16-8F4OMXS | 280 | 250 |
| 25 | 1 | 3/4-14 | 1 5/16-12 | 36 | 21.5 | 15.5 | 48.5 | 34.0 | 173 | 16-12F4OMXS | 16-12F4OMXS | 280 | 250 |
| 25 | 1 | 1 1/4-11 | 1 5/16-12 | 50 | 27.5 | 27.5 | 56.0 | 37.5 | 386 | 16-20F4OMXS | 16-20F4OMXS | 250 | 175 |
| 28, 30, 32 | 1 1/4 | 1 1/4-11 | 1 5/8-12 | 50 | 27.5 | 27.5 | 56.0 | 37.5 | 325 | 20F4OMXS | 20F4OMXS | 250 | 175 |
| 28, 30, 32 | 1 1/4 | 3/4-14 | 1 5/8-12 | 46 | 27.5 | 15.5 | 51.0 | 36.5 | 220 | 20-12F4OMXS | 20-12F4OMXS | 280 | 175 |
| 28, 30, 32 | 1 1/4 | 1-11 | 1 5/8-12 | 46 | 27.5 | 15.5 | 51.0 | 37.0 | 330 | 20-16F4OMXS | 20-16F4OMXS | 280 | 210 |
| 28, 30, 32 | 1 1/4 | 1 1/2-11 | 1 5/8-12 | 55 | 27.5 | 27.5 | 57.0 | 38.5 | 480 | 20-24F4OMXS | 20-24F4OMXS | 210 | 140 |
| 35, 38 | 1 1/2 | 1 1/2-11 | 1 7/8-12 | 55 | 33.0 | 33.0 | 61.0 | 42.5 | 480 | 24F4OMXS | 24F4OMXS | 210 | 140 |
| 35, 38 | 1 1/2 | 1 1/4-11 | 1 7/8-12 | 50 | 33.0 | 27.5 | 60.5 | 42.0 | 420 | 24-20F4OMXS | 24-20F4OMXS | 210 | 140 |
| 42 | 1 1/2 | 1 1/2-11 | 2 1/4 | 60 | 39.0 | 33.0 | 67.5 | 49.0 | 740 | 28-24F4OMXS | 28-24F4OMXS | 140 | 105 |

Steel, stainless steel and brass Triple-Lok® parts are delivered with NBR elastomeric seals as standard. For more details on other seal materials see page K92.

Order codes shown are part of our current manufacturing programme.

Imperial and metric parts may vary in hexagon dimensions.

$$\frac{\text{PN (bar)}}{10} = \text{PN (MPa)}$$

Do not create drawings from these dimensions, they are subject to change and ISO manufacturing allowances.

F82EDMX Male stud connector

Triple-Lok® 37° Flare end / Male metric thread – ED seal (ISO 9974)

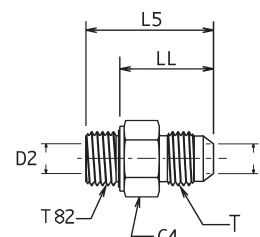

| Tube O.D. | | Thread Metric T82 | Thread UN/UNF-2A T | C4 mm | D mm | D2 mm | L5 mm | LL mm | Weight (steel) g/1 piece | Triple-Lok® Steel | Triple-Lok® Stainless Steel | PN (bar) | |
|------------|-------|-------------------|--------------------|-------|------|-------|-------|-------|--------------------------|-------------------|-----------------------------|----------|-----|
| mm | in. | | | | | | | | | | | S | SS |
| 6 | 1/4 | M 10×1.0 | 7/16-20 | 14 | 4.4 | 4 | 30.0 | 22.0 | 19 | 4M10F82EDMXS | 4M10F82EDMXSS | 500 | 350 |
| 6 | 1/4 | M 12×1.5 | 7/16-20 | 17 | 4.4 | 6 | 34.0 | 22.0 | 30 | 4M12F82EDMXS | 4M12F82EDMXSS | 420 | 350 |
| 8 | 5/16 | M 10×1.0 | 1/2-20 | 14 | 6.0 | 4 | 30.0 | 22.0 | 17 | 5M10F82EDMXS | 5M10F82EDMXSS | 420 | 350 |
| 8 | 5/16 | M 12×1.5 | 1/2-20 | 17 | 6.0 | 6 | 34.0 | 22.0 | 28 | 5M12F82EDMXS | 5M12F82EDMXSS | 420 | 350 |
| 8 | 5/16 | M 14×1.5 | 1/2-20 | 19 | 6.0 | 7 | 35.0 | 23.0 | 35 | 5M14F82EDMXS | 5M14F82EDMXSS | 420 | 350 |
| 10 | 3/8 | M 12×1.5 | 9/16-18 | 17 | 7.5 | 6 | 35.0 | 23.0 | 33 | 6M12F82EDMXS | 6M12F82EDMXSS | 420 | 350 |
| 10 | 3/8 | M 14×1.5 | 9/16-18 | 19 | 7.5 | 7 | 35.0 | 23.0 | 38 | 6M14F82EDMXS | 6M14F82EDMXSS | 420 | 350 |
| 10 | 3/8 | M 16×1.5 | 9/16-18 | 22 | 7.5 | 9 | 36.0 | 24.0 | 53 | 6M16F82EDMXS | 6M16F82EDMXSS | 420 | 350 |
| 10 | 3/8 | M 18×1.5 | 9/16-18 | 24 | 7.5 | 11 | 36.0 | 24.0 | 60 | 6M18F82EDMXS | 6M18F82EDMXSS | 350 | 350 |
| 10 | 3/8 | M 22×1.5 | 9/16-18 | 27 | 7.5 | 14 | 39.5 | 25.5 | 68 | 6M22F82EDMXS | 6M22F82EDMXSS | 350 | 350 |
| 12 | 1/2 | M 14×1.5 | 3/4-16 | 19 | 9.9 | 7 | 38.5 | 26.5 | 41 | 8M14F82EDMXS | 8M14F82EDMXSS | 420 | 350 |
| 12 | 1/2 | M 16×1.5 | 3/4-16 | 22 | 9.9 | 9 | 38.5 | 26.5 | 57 | 8M16F82EDMXS | 8M16F82EDMXSS | 420 | 350 |
| 12 | 1/2 | M 18×1.5 | 3/4-16 | 24 | 9.9 | 11 | 38.5 | 26.5 | 71 | 8M18F82EDMXS | 8M18F82EDMXSS | 350 | 350 |
| 12 | 1/2 | M 22×1.5 | 3/4-16 | 27 | 9.9 | 14 | 42.0 | 28.0 | 70 | 8M22F82EDMXS | 8M22F82EDMXSS | 350 | 350 |
| 14, 15, 16 | 5/8 | M 18×1.5 | 7/8-14 | 24 | 12.3 | 11 | 42.5 | 30.5 | 104 | 10M18F82EDMXS | 10M18F82EDMXSS | 350 | 350 |
| 14, 15, 16 | 5/8 | M 22×1.5 | 7/8-14 | 27 | 12.3 | 14 | 44.5 | 30.5 | 161 | 10M22F82EDMXS | 10M22F82EDMXSS | 350 | 350 |
| 18, 20 | 3/4 | M 18×1.5 | 1 1/16-12 | 27 | 15.5 | 11 | 44.5 | 32.5 | 85 | 12M18F82EDMXS | 12M18F82EDMXSS | 350 | 350 |
| 18, 20 | 3/4 | M 22×1.5 | 1 1/16-12 | 27 | 15.5 | 14 | 49.0 | 35.0 | 273 | 12M22F82EDMXS | 12M22F82EDMXSS | 350 | 350 |
| 18, 20 | 3/4 | M 26×1.5 | 1 1/16-12 | 32 | 15.5 | 18 | 51.0 | 35.0 | 135 | 12M26F82EDMXS | 12M26F82EDMXSS | 350 | 350 |
| 18, 20 | 3/4 | M 27×2.0 | 1 1/16-12 | 32 | 15.5 | 16 | 51.0 | 35.0 | 431 | 12M27F82EDMXS | 12M27F82EDMXSS | 350 | 350 |
| 25 | 1 | M 26×1.5 | 1 5/16-12 | 36 | 21.5 | 18 | 55.0 | 39.0 | 350 | 16M26F82EDMXS | 16M26F82EDMXSS | 280 | 280 |
| 25 | 1 | M 27×2.0 | 1 5/16-12 | 36 | 21.5 | 16 | 52.5 | 36.5 | 360 | 16M27F82EDMXS | 16M27F82EDMXSS | 280 | 280 |
| 25 | 1 | M 33×2.0 | 1 5/16-12 | 41 | 21.5 | 23 | 54.5 | 36.5 | 431 | 16M33F82EDMXS | 16M33F82EDMXSS | 280 | 280 |
| 28, 30, 32 | 1 1/4 | M 42×2.0 | 1 5/8-12 | 50 | 27.5 | 30 | 60.0 | 40.0 | 431 | 20M42F82EDMXS | 20M42F82EDMXSS | 280 | 210 |
| 35, 38 | 1 1/2 | M 48×2.0 | 1 7/8-12 | 55 | 33.0 | 36 | 67.0 | 45.0 | 580 | 24M48F82EDMXS | 24M48F82EDMXSS | 210 | 140 |

K

Steel, stainless steel and brass Triple-Lok® parts are delivered with NBR elastomeric seals as standard. For more details on other seal materials see page K92.

Order codes shown are part of our current manufacturing programme.

Imperial and metric parts may vary in hexagon dimensions.

$$\frac{\text{PN (bar)}}{10} = \text{PN (MPa)}$$

Do not create drawings from these dimensions, they are subject to change and ISO manufacturing allowances.

Triple-Lok®

F8OMX Male stud connector

Triple-Lok® 37° Flare end / Male metric thread – O-ring + retainer ring

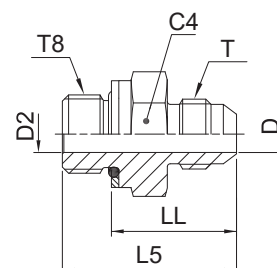

| Tube O.D. | | Thread Metric T8 | Thread UN/UNF-2A T | C4 mm | D mm | D2 mm | L5 mm | LL mm | Weight (steel) g/1 piece | Triple-Lok® | | PN (bar) | |
|------------|-------|------------------|--------------------|-------|------|-------|-------|-------|--------------------------|--------------------|--------------------|----------|-----|
| mm | in. | | | | | | | | | Steel | Stainless Steel | S | SS |
| 6 | 1/4 | M 10×1.0 | 7/16-20 | 14 | 4.4 | 4.4 | 30.0 | 21.5 | 25 | 4M10F8OMXS | 4M10F8OMXS | 350 | 350 |
| 6 | 1/4 | M 12×1.5 | 7/16-20 | 17 | 4.4 | 6.0 | 33.0 | 22.0 | 35 | 4M12F8OMXS | 4M12F8OMXS | 420 | 350 |
| 8 | 5/16 | M 10×1.0 | 1/2-20 | 14 | 6.0 | 4.5 | 30.0 | 21.5 | 25 | 5M10F8OMXS | 5M10F8OMXS | 350 | 350 |
| 8 | 5/16 | M 12×1.5 | 1/2-20 | 19 | 6.0 | 6.0 | 33.0 | 22.0 | 35 | 5M12F8OMXS | 5M12F8OMXS | 420 | 350 |
| 8 | 5/16 | M 14×1.5 | 1/2-20 | 19 | 6.0 | 6.0 | 34.0 | 24.0 | 35 | 5M14F8OMXS | 5M14F8OMXS | 350 | 350 |
| 10 | 3/8 | M 12×1.5 | 9/16-18 | 17 | 7.5 | 6.0 | 34.0 | 23.0 | 35 | 6M12F8OMXS | 6M12F8OMXS | 420 | 350 |
| 10 | 3/8 | M 14×1.5 | 9/16-18 | 19 | 7.5 | 7.5 | 34.0 | 23.0 | 35 | 6M14F8OMXS | 6M14F8OMXS | 350 | 350 |
| 10 | 3/8 | M 16×1.5 | 9/16-18 | 22 | 7.5 | 9.0 | 35.5 | 24.0 | 51 | 6M16F8OMXS | 6M16F8OMXS | 350 | 350 |
| 10 | 3/8 | M 18×1.5 | 9/16-18 | 24 | 7.5 | 11.0 | 36.5 | 24.0 | 60 | 6M18F8OMXS | 6M18F8OMXS | 250 | 350 |
| 12 | 1/2 | M 14×1.5 | 3/4-16 | 19 | 9.9 | 7.5 | 36.0 | 25.0 | 38 | 8M14F8OMXS | 8M14F8OMXS | 350 | 350 |
| 12 | 1/2 | M 16×1.5 | 3/4-16 | 22 | 9.9 | 9.0 | 38.0 | 26.5 | 55 | 8M16F8OMXS | 8M16F8OMXS | 350 | 350 |
| 12 | 1/2 | M 18×1.5 | 3/4-16 | 24 | 9.9 | 11.0 | 39.0 | 26.5 | 66 | 8M18F8OMXS | 8M18F8OMXS | 250 | 250 |
| 12 | 1/2 | M 22×1.5 | 3/4-16 | 27 | 9.9 | 14.0 | 41.0 | 28.0 | 70 | 8M22F8OMXS | 8M22F8OMXS | 250 | 250 |
| 14, 15, 16 | 5/8 | M 18×1.5 | 7/8-14 | 24 | 12.3 | 11.0 | 43.0 | 30.5 | 71 | 10M18F8OMXS | 10M18F8OMXS | 250 | 250 |
| 14, 15, 16 | 5/8 | M 20×1.5 | 7/8-14 | 27 | 12.3 | 11.0 | 44.5 | 33.0 | 90 | 10M20F8OMXS | 10M20F8OMXS | 250 | 250 |
| 14, 15, 16 | 5/8 | M 22×1.5 | 7/8-14 | 27 | 12.3 | 14.0 | 43.5 | 30.5 | 98 | 10M22F8OMXS | 10M22F8OMXS | 250 | 250 |
| 18, 20 | 3/4 | M 18×1.5 | 1 1/16-12 | 27 | 15.5 | 11.0 | 50.5 | 38.0 | 85 | 12M18F8OMXS | 12M18F8OMXS | 250 | 250 |
| 18, 20 | 3/4 | M 22×1.5 | 1 1/16-12 | 27 | 15.5 | 14.0 | 48.0 | 35.0 | 104 | 12M22F8OMXS | 12M22F8OMXS | 250 | 250 |
| 18, 20 | 3/4 | M 24×1.5 | 1 1/16-12 | 30 | 15.5 | 14.0 | 44.5 | 32.5 | 120 | 12M26F8OMXS | 12M26F8OMXS | 210 | 210 |
| 18, 20 | 3/4 | M 27×2.0 | 1 1/16-12 | 32 | 15.5 | 18.0 | 51.0 | 35.0 | 154 | 12M27F8OMXS | 12M27F8OMXS | 210 | 210 |
| 25 | 1 | M 22×1.5 | 1 5/16-12 | 36 | 21.5 | 14.0 | 47.5 | 34.5 | 180 | 16M22F8OMXS | 16M22F8OMXS | 250 | 250 |
| 25 | 1 | M 26×1.5 | 1 5/16-12 | 36 | 21.5 | 15.5 | 51.5 | 34.5 | 202 | 16M26F8OMXS | 16M26F8OMXS | 210 | 210 |
| 25 | 1 | M 27×2.0 | 1 5/16-12 | 36 | 21.5 | 18.0 | 50.5 | 34.5 | 202 | 16M27F8OMXS | 16M27F8OMXS | 210 | 210 |
| 25 | 1 | M 33×2.0 | 1 5/16-12 | 41 | 21.5 | 23.0 | 53.0 | 37.0 | 267 | 16M33F8OMXS | 16M33F8OMXS | 210 | 210 |
| 28, 30, 32 | 1 1/4 | M 42×2.0 | 1 5/8-12 | 50 | 27.5 | 30.0 | 55.0 | 39.0 | 427 | 20M42F8OMXS | 20M42F8OMXS | 210 | 210 |
| 35, 38 | 1 1/2 | M 48×2.0 | 1 7/8-12 | 55 | 33.0 | 36.0 | 59.5 | 42.0 | 545 | 24M48F8OMXS | 24M48F8OMXS | 140 | 140 |

Steel, stainless steel and brass Triple-Lok® parts are delivered with NBR elastomeric seals as standard. For more details on other seal materials see page K92.

Order codes shown are part of our current manufacturing programme.

Imperial and metric parts may vary in hexagon dimensions.

$$\frac{\text{PN (bar)}}{10} = \text{PN (MPa)}$$

Pressure ratings – PN shown, apply to Steel and Stainless Steel versions of the product.

Do not create drawings from these dimensions, they are subject to change and ISO manufacturing allowances.

FMTX Male stud connector

Triple-Lok® 37° Flare end / Male NPTF* thread (SAE 476)

SAE 070102 MS51500

*Stainless Steel = NPT to prevent galling

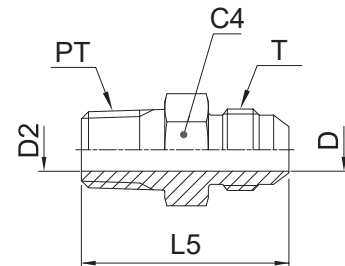

| Tube O.D. | | Thread NPT/NPTF PT | Thread UN/UNF-2A T | C4 mm | D mm | D2 mm | L5 mm | Weight (steel) g/1 piece | Triple-Lok® Steel | Triple-Lok® Stainless Steel | PN (bar) | |
|------------|-------|--------------------|--------------------|-------|------|-------|-------|--------------------------|--------------------|-----------------------------|----------|-----|
| mm | in. | | | | | | | | | | S | SS |
| 5 | 1/8 | 1/8-27 | 5/16-24 | 11.0 | 1.6 | 4.7 | 28.0 | 10 | 2 FTX-S | | 420 | — |
| | 3/16 | 1/8-27 | 3/8-24 | 11.0 | 3.0 | 3.0 | 29.0 | 12 | 3 FTX-S | | 420 | — |
| 6 | 1/4 | 1/8-27 | 7/16-20 | 13.0 | 4.4 | 4.4 | 31.0 | 14 | 4FMTXS | 4FMTXSS | 420 | 350 |
| | 1/4 | 1/4-18 | 7/16-20 | 14.0 | 4.4 | 4.4 | 36.0 | 26 | 4-4FMTXS | 4-4FMTXSS | 420 | 350 |
| 6 | 1/4 | 3/8-18 | 7/16-20 | 19.0 | 4.4 | 4.4 | 36.5 | 26 | 4-6 FTX-S | 4-6FMTXSS | 420 | 350 |
| 6 | 1/4 | 1/2-14 | 7/16-20 | 22.3 | 4.4 | 4.4 | 43.0 | 26 | 4-8 FTX-S | 4-8FMTXSS | 420 | 350 |
| | 5/16 | 1/8-27 | 1/2-20 | 14.0 | 6.0 | 5.0 | 31.0 | 17 | 5FMTXS | 5FMTXSS | 420 | 350 |
| 8 | 5/16 | 1/4-18 | 1/2-20 | 14.0 | 6.0 | 6.0 | 36.0 | 25 | 5-4FMTXS | 5-4FMTXSS | 420 | 350 |
| 8 | 5/16 | 3/8-18 | 1/2-20 | 19.0 | 6.0 | 6.0 | 36.0 | 30 | 5-6FMTXS | 5-6FMTXSS | 420 | 350 |
| 10 | 3/8 | 1/4-18 | 9/16-18 | 17.0 | 7.5 | 7.5 | 36.5 | 25 | 6FMTXS | 6FMTXSS | 420 | 350 |
| 10 | 3/8 | 1/8-27 | 9/16-18 | 16.0 | 7.5 | 4.7 | 31.5 | 21 | 6-2 FTX-S | 6-2FMTXSS | 420 | 350 |
| | 3/8 | 3/8-18 | 9/16-18 | 19.0 | 7.5 | 7.5 | 36.5 | 39 | 6-6FMTXS | 6-6FMTXSS | 420 | 350 |
| 10 | 3/8 | 1/2-14 | 9/16-18 | 22.0 | 7.5 | 7.5 | 43.0 | 47 | 6-8FMTXS | 6-8FMTXSS | 420 | 350 |
| 10 | 3/8 | 3/4-14 | 9/16-18 | 28.6 | 7.5 | 15.5 | 42.0 | 109 | 6-12 FTX-S | 6-12FMTXSS | 420 | 350 |
| 12 | 1/2 | 3/8-18 | 3/4-16 | 19.0 | 9.9 | 9.9 | 39.0 | 45 | 8FMTXS | 8FMTXSS | 420 | 350 |
| 12 | 1/2 | 1/4-18 | 3/4-16 | 19.0 | 9.9 | 7.0 | 39.0 | 42 | 8-4FMTXS | 8-4FMTXSS | 420 | 350 |
| | 1/2 | 1/2-14 | 3/4-16 | 22.0 | 9.9 | 9.9 | 45.5 | 74 | 8-8FMTXS | 8-8FMTXSS | 420 | 350 |
| 12 | 1/2 | 3/4-14 | 3/4-16 | 27.0 | 9.9 | 9.9 | 47.0 | 121 | 8-12FMTXS | 8-12FMTXSS | 380 | 350 |
| 14, 15, 16 | 5/8 | 1/2-14 | 7/8-14 | 24.0 | 12.3 | 12.3 | 48.0 | 77 | 10FMTXS | 10FMTXSS | 350 | 350 |
| 14, 15, 16 | 5/8 | 3/8-18 | 7/8-14 | 24.0 | 12.3 | 10.0 | 43.0 | 63 | 10-6FMTXS | 10-6FMTXSS | 350 | 350 |
| 14, 15, 16 | 5/8 | 3/4-14 | 7/8-14 | 27.0 | 12.3 | 12.3 | 49.5 | 122 | 10-12FMTXS | 10-12FMTXSS | 350 | 350 |
| 18, 20 | 3/4 | 3/4-14 | 1 1/16-12 | 27.0 | 15.5 | 15.5 | 53.0 | 123 | 12FMTX-S | 12FMTXSS | 350 | 350 |
| 18, 20 | 3/4 | 3/8-18 | 1 1/16-12 | 28.5 | 15.5 | 10.3 | 47.5 | 90 | 12-6 FTX-S | 12-6FMTXSS | 350 | 350 |
| 18, 20 | 3/4 | 1/2-14 | 1 1/16-12 | 28.5 | 15.5 | 13.5 | 52.0 | 103 | 12-8 FTX-S | 12-8FMTXSS | 350 | 350 |
| 18, 20 | 3/4 | 1-11.5 | 1 1/16-12 | 35.0 | 15.5 | 15.5 | 57.0 | 176 | 12-16 FTX-S | 12-16FMTXSS | 310 | 280 |
| 22 | 7/8 | 3/4-14 | 1 3/16-12 | 31.7 | 18.3 | 18.3 | 53.0 | 137 | 14 FTX-S | 14FMTXSS | 280 | 245 |
| | 1 | 1-11.5 | 1 5/16-12 | 36.0 | 21.5 | 21.5 | 58.5 | 189 | 16FMTXS | 16FMTXSS | 280 | 280 |
| 25 | 1 | 1/2-14 | 1 5/16-12 | 36.0 | 21.5 | 18.0 | 53.5 | 110 | 16-8 FTX-S | 16-8FMTXSS | 280 | 280 |
| 25 | 1 | 3/4-14 | 1 5/16-12 | 36.0 | 21.5 | 18.0 | 53.5 | 149 | 16-12FMTXS | 16-12FMTXSS | 280 | 280 |
| 25 | 1 | 1 1/4-11.5 | 1 5/16-12 | 47.6 | 21.4 | 21.4 | 54.0 | 331 | 16-20 FTX-S | 16-20FMTXSS | 280 | 280 |
| 28, 30, 32 | 1 1/4 | 1 1/4-11.5 | 1 5/8-12 | 46.0 | 27.5 | 32.0 | 62.0 | 315 | 20FMTXS | 20FMTXSS | 210 | 210 |
| 28, 30, 32 | 1 1/4 | 1-11.5 | 1 5/8-12 | 43.0 | 27.5 | 23.8 | 61.5 | 248 | 20-16 FTX-S | 20-16FMTXSS | 280 | 210 |
| 35, 38 | 1 1/2 | 1 1/2-11.5 | 1 7/8-12 | 50.0 | 33.0 | 38.0 | 68.0 | 430 | 24FMTXS | 24FMTXSS | 210 | 140 |
| 35, 38 | 1 1/2 | 1-11.5 | 1 7/8-12 | 51.0 | 33.3 | 24.0 | 66.5 | 310 | 24-16 FTX-S | 24-16FMTXSS | 210 | 140 |
| 35, 38 | 1 1/2 | 1 1/4-11.5 | 1 7/8-12 | 51.0 | 33.3 | 31.7 | 67.5 | 359 | 24-20 FTX-S | 24-20FMTXSS | 210 | 140 |
| 35, 38 | 1 1/2 | 2-11.5 | 1 7/8-12 | 66.7 | 33.3 | 33.3 | 72.5 | 720 | 24-32 FTX-S | 24-32FMTXSS | 140 | 140 |
| | 2 | 2-11.5 | 2 1/2-12 | 66.7 | 45.2 | 45.2 | 79.0 | 858 | 32 FTX-S | 32FMTXSS | 140 | 105 |
| | 2 | 1 1/2-11.5 | 2 1/2-12 | 66.7 | 45.2 | 38.0 | 78.0 | 720 | 32-24 FTX-S | 32-24FMTXSS | 140 | 105 |

Order codes shown are part of our current manufacturing programme. Imperial and metric parts may vary in hexagon dimensions.

PN (bar) = PN (MPa) / 10

Pressure ratings – PN shown, apply to Steel and Stainless Steel versions of the product.

For Brass parts reduce pressures by 35%.

Do not create drawings from these dimensions, they are subject to change and ISO manufacturing allowances.



Triple-Lok®

F3MX Male stud connector

Triple-Lok® 37° Flare end / Male BSPT thread (ISO 7)

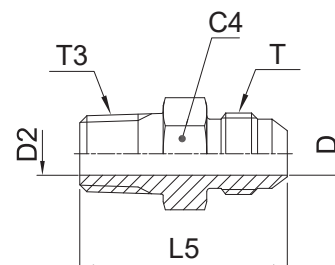

| Tube O.D. | | Thread BSPT T3 | Thread UN/UNF-2A T | C4 mm | D mm | D2 mm | L5 mm | Weight (steel) g/1 piece | Triple-Lok® Steel | Triple-Lok® Stainless Steel | PN (bar) | |
|------------|-------|----------------|--------------------|-------|------|-------|-------|--------------------------|-------------------|-----------------------------|----------|-----|
| mm | in. | | | | | | | | | | S | SS |
| 6 | 1/4 | 1/8-28 | 7/16-20 | 13 | 4.4 | 4.4 | 31.0 | 13 | 4F3MXS | 4F3MXSS | 315 | 315 |
| 6 | 1/4 | 1/4-19 | 7/16-20 | 14 | 4.4 | 4.4 | 35.5 | 25 | 4-4F3MXS | 4-4F3MXSS | 315 | 315 |
| 8 | 5/16 | 1/8-28 | 1/2-20 | 14 | 6.0 | 7.0 | 35.0 | 17 | 5F3MXS | 5F3MXSS | 315 | 315 |
| 8 | 5/16 | 1/4-19 | 1/2-20 | 14 | 6.0 | 7.0 | 35.0 | 24 | 5-4F3MXS | 5-4F3MXSS | 315 | 315 |
| 10 | 3/8 | 1/4-19 | 9/16-18 | 17 | 7.5 | 7.0 | 35.5 | 25 | 6F3MXS | 6F3MXSS | 315 | 315 |
| 10 | 3/8 | 3/8-19 | 9/16-18 | 19 | 7.5 | 10.0 | 35.5 | 37 | 6-6F3MXS | 6-6F3MXSS | 315 | 315 |
| 10 | 3/8 | 1/2-14 | 9/16-18 | 22 | 7.5 | 13.5 | 43.0 | 45 | 6-8F3MXS | 6-8F3MXSS | 315 | 315 |
| 12 | 1/2 | 3/8-19 | 3/4-16 | 19 | 9.9 | 10.0 | 39.0 | 43 | 8F3MXS | 8F3MXSS | 315 | 315 |
| 12 | 1/2 | 1/4-19 | 3/4-16 | 19 | 9.9 | 7.0 | 38.0 | 41 | 8-4F3MXS | 8-4F3MXSS | 315 | 315 |
| 12 | 1/2 | 1/2-14 | 3/4-16 | 22 | 9.9 | 13.5 | 45.5 | 71 | 8-8F3MXS | 8-8F3MXSS | 315 | 315 |
| 14, 15, 16 | 5/8 | 1/2-14 | 7/8-14 | 24 | 12.3 | 13.5 | 48.0 | 74 | 10F3MXS | 10F3MXSS | 315 | 315 |
| 14, 15, 16 | 5/8 | 3/8-19 | 7/8-14 | 24 | 12.3 | 10.0 | 43.0 | 61 | 10-6F3MXS | 10-6F3MXSS | 315 | 315 |
| 14, 15, 16 | 5/8 | 3/4-14 | 7/8-14 | 27 | 12.3 | 18.0 | 48.5 | 117 | 10-12F3MXS | 10-12F3MXSS | 160 | 160 |
| 18, 20 | 3/4 | 3/4-14 | 1 1/16-12 | 27 | 15.5 | 18.0 | 51.0 | 119 | 12F3MXS | 12F3MXSS | 160 | 160 |
| 18, 20 | 3/4 | 1/2-14 | 1 1/16-12 | 27 | 15.5 | 13.5 | 51.0 | 100 | 12-8F3MXS | 12-8F3MXSS | 315 | 315 |
| 18, 20 | 3/4 | 1-11 | 1 1/16-12 | 36 | 15.5 | 24.0 | 57.0 | 214 | 12-16F3MXS | 12-16F3MXSS | 160 | 160 |
| 25 | 1 | 1-11 | 1 5/16-12 | 36 | 21.5 | 24.0 | 58.5 | 185 | 16F3MXS | 16F3MXSS | 160 | 160 |
| 25 | 1 | 3/4-14 | 1 5/16-12 | 36 | 21.5 | 18.0 | 53.5 | 146 | 16-12F3MXS | 16-12F3MXSS | 160 | 160 |
| 28, 30, 32 | 1 1/4 | 1 1/4-11 | 1 5/8-12 | 46 | 27.5 | 32.0 | 62.0 | 309 | 20F3MXS | 20F3MXSS | 160 | 160 |
| 28, 30, 32 | 1 1/4 | 1-11 | 1 5/8-12 | 46 | 27.5 | 24.0 | 61.5 | 243 | 20-16F3MXS | 20-16F3MXSS | 160 | 160 |
| 35, 38 | 1 1/2 | 1 1/2-11 | 1 7/8-12 | 50 | 33.0 | 38.0 | 68.0 | 421 | 24F3MXS | 24F3MXSS | 160 | 140 |
| 35, 38 | 1 1/2 | 1 1/4-11 | 1 7/8-12 | 50 | 33.0 | 32.0 | 67.0 | 352 | 24-20F3MXS | 24-20F3MXSS | 160 | 140 |

Order codes shown are part of our current manufacturing programme.

Imperial and metric parts may vary in hexagon dimensions.

$$\frac{\text{PN (bar)}}{10} = \text{PN (MPa)}$$

Do not create drawings from these dimensions, they are subject to change and ISO manufacturing allowances.

F687OMX Swivel male stud

Triple-Lok® 37° Flare female swivel end / Male metric thread – O-ring (ISO 6149)

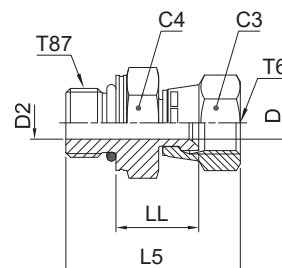

| Tube O.D. | | Thread Metric T87 | Thread UN/UNF-2B T6 | C4 mm | C3 mm | D mm | D2 mm | L5 mm | LL mm | Weight (steel) g/1 piece | Triple-Lok® Steel | Triple-Lok® Stainless Steel | PN (bar) | |
|------------|-------|-------------------|---------------------|-------|-------|------|-------|-------|-------|--------------------------|-------------------|-----------------------------|----------|-----|
| mm | in. | | | | | | | | | | | | S | SS |
| 6 | 1/4 | M 10×1.0 | 7/16-20 | 14 | 14 | 4.4 | 4.4 | 32 | 15.0 | 25 | 4M10F687OMXS | 4M10F687OMXSS | 500 | 350 |
| 6 | 1/4 | M 12×1.5 | 7/16-20 | 17 | 14 | 4.4 | 6.0 | 35 | 15.0 | 30 | 4M12F687OMXS | 4M12F687OMXSS | 420 | 350 |
| 8 | 5/16 | M 10×1.0 | 1/2-20 | 14 | 17 | 6.0 | 4.5 | 34 | 16.5 | 40 | 5M10F687OMXS | 5M10F687OMXSS | 420 | 350 |
| 8 | 5/16 | M 12×1.5 | 1/2-20 | 17 | 17 | 6.0 | 6.0 | 37 | 16.5 | 64 | 5M12F687OMXS | 5M12F687OMXSS | 420 | 350 |
| 10 | 3/8 | M 14×1.5 | 9/16-18 | 19 | 19 | 7.5 | 7.5 | 38 | 18.0 | 65 | 6M14F687OMXS | 6M14F687OMXSS | 350 | 350 |
| 10 | 3/8 | M 16×1.5 | 9/16-18 | 22 | 19 | 7.5 | 9.0 | 40 | 19.0 | 75 | 6M16F687OMXS | 6M16F687OMXSS | 350 | 350 |
| 12 | 1/2 | M 16×1.5 | 3/4-16 | 22 | 22 | 9.9 | 9.0 | 44 | 21.0 | 80 | 8M16F687OMXS | 8M16F687OMXSS | 350 | 350 |
| 12 | 1/2 | M 18×1.5 | 3/4-16 | 24 | 22 | 9.9 | 11.0 | 45 | 21.0 | 90 | 8M18F687OMXS | 8M18F687OMXSS | 350 | 350 |
| 14, 15, 16 | 5/8 | M 18×1.5 | 7/8-14 | 24 | 27 | 12.3 | 11.0 | 48 | 23.0 | 108 | 10M18F687OMXS | 10M18F687OMXSS | 350 | 350 |
| 14, 15, 16 | 5/8 | M 22×1.5 | 7/8-14 | 27 | 27 | 12.3 | 14.0 | 49 | 23.0 | 115 | 10M22F687OMXS | 10M22F687OMXSS | 350 | 350 |
| 18, 20 | 3/4 | M 22×1.5 | 1 1/16-12 | 27 | 32 | 15.5 | 14.0 | 52 | 24.5 | 183 | 12M22F687OMXS | 12M22F687OMXSS | 350 | 350 |
| 18, 20 | 3/4 | M 27×2.0 | 1 1/16-12 | 32 | 32 | 15.5 | 18.0 | 55 | 24.5 | 197 | 12M27F687OMXS | 12M27F687OMXSS | 350 | 350 |
| 25 | 1 | M 33×2.0 | 1 5/16-12 | 41 | 38 | 21.5 | 23.0 | 59 | 27.5 | 250 | 16M33F687OMXS | 16M33F687OMXSS | 250 | 280 |
| 28, 30, 32 | 1 1/4 | M 42×2.0 | 1 5/8-12 | 50 | 50 | 27.5 | 30.0 | 63 | 31.0 | 500 | 20M42F687OMXS | 20M42F687OMXSS | 250 | 210 |
| 35, 38 | 1 1/2 | M 48×2.0 | 1 7/8-12 | 55 | 60 | 33.0 | 36.0 | 72 | 33.0 | 688 | 24M48F687OMXS | 24M48F687OMXSS | 170 | 140 |

Steel, stainless steel and brass Triple-Lok® parts are delivered with NBR elastomeric seals as standard. For more details on other seal materials see page K92.

Order codes shown are part of our current manufacturing programme.

Imperial and metric parts may vary in hexagon dimensions.

$$\frac{\text{PN (bar)}}{10} = \text{PN (MPa)}$$

Do not create drawings from these dimensions, they are subject to change and ISO manufacturing allowances.



Triple-Lok®

F65OMX Swivel male stud

Triple-Lok® 37° Flare female swivel end / Male UN/UNF thread – O-ring (ISO 11926)

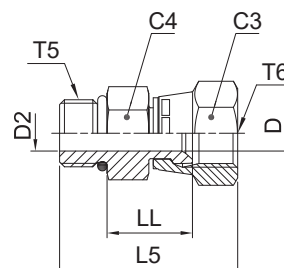

| Tube O.D. | | Thread UNF T5 | Thread UN/UNF-2B T6 | C4 mm | C3 mm | D mm | D2 mm | L5 mm | LL mm | Weight (steel) g/1 piece | Triple-Lok® Steel | PN (bar) |
|------------|-------|---------------|---------------------|-------|-------|------|-------|-------|-------|--------------------------|-------------------|----------|
| mm | in. | | | | | | | | | | | |
| 6 | 1/4 | 7/16-20 | 7/16-20 | 14.0 | 14.0 | 4.4 | 4.4 | 33.0 | 15.0 | 27 | 4F65OMXS | 500 |
| 8 | 5/16 | 1/2-20 | 1/2-20 | 17.0 | 17.0 | 6.0 | 6.0 | 35.0 | 17.0 | 30 | 5F65OMXS | 420 |
| 10 | 3/8 | 9/16-18 | 9/16-18 | 17.0 | 19.0 | 7.5 | 7.5 | 38.0 | 18.0 | 35 | 6F65OMXS | 350 |
| 12 | 1/2 | 3/4-16 | 3/4-16 | 22.2 | 22.0 | 9.9 | 9.9 | 41.5 | 19.0 | 64 | 8 F65OX-S | 350 |
| 14, 15, 16 | 5/8 | 7/8-14 | 7/8-14 | 25.4 | 25.4 | 12.3 | 12.3 | 46.0 | 20.5 | 112 | 10 F65OX-S | 350 |
| 18, 20 | 3/4 | 1 1/16-12 | 1 1/16-12 | 28.6 | 28.6 | 15.5 | 15.5 | 54.0 | 25.0 | 183 | 12 F65OX-S | 350 |
| 25 | 1 | 1 5/16-12 | 1 5/16-12 | 38.0 | 38.0 | 21.4 | 21.4 | 58.0 | 27.0 | 234 | 16 F65OX-S | 250 |
| 28, 30, 32 | 1 1/4 | 1 5/8-12 | 1 5/8-12 | 51.0 | 51.0 | 27.5 | 27.5 | 63.0 | 32.0 | 500 | 20 F65OX-S | 250 |

Steel, stainless steel and brass Triple-Lok® parts are delivered with NBR elastomeric seals as standard. For more details on other seal materials see page K92.

Order codes shown are part of our current manufacturing programme.

Imperial and metric parts may vary in hexagon dimensions.

$$\frac{\text{PN (bar)}}{10} = \text{PN (MPa)}$$

Do not create drawings from these dimensions, they are subject to change and ISO manufacturing allowances.

F642EDMX Swivel male stud

Triple-Lok® 37° Flare female swivel end / Male BSPP thread – ED seal (ISO 1179)

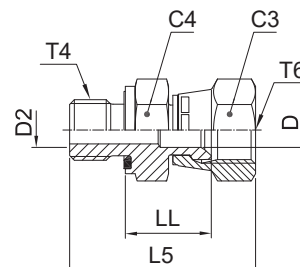

| Tube O.D. | | Thread BSPP T4 | Thread UN/UNF-2B T6 | C4 mm | C3 mm | D mm | D2 mm | L5 mm | LL mm | Weight (steel) g/1 piece | Triple-Lok® Steel | Triple-Lok® Stainless Steel | PN (bar) | |
|------------|-------|----------------|---------------------|-------|-------|------|-------|-------|-------|--------------------------|-----------------------|-----------------------------|----------|-----|
| mm | in. | | | | | | | | | | | | S | SS |
| 6 | 1/4 | 1/8-28 | 7/16-20 | 14 | 14 | 4.4 | 4.4 | 32 | 15.0 | 30 | 4F642EDMXS | 4F642EDMXSS | 500 | 350 |
| 6 | 1/4 | 1/4-19 | 7/16-20 | 19 | 14 | 4.4 | 4.4 | 37 | 16.5 | 30 | 4-4F642EDMXS | 4-4F642EDMXSS | 420 | 350 |
| 8 | 5/16 | 1/8-28 | 1/2-20 | 14 | 17 | 6.0 | 4.0 | 34 | 17.0 | 28 | 5F642EDMXS | 5F642EDMXSS | 420 | 350 |
| 8 | 5/16 | 1/4-19 | 1/2-20 | 19 | 17 | 6.0 | 6.0 | 39 | 17.5 | 37 | 5-4F642EDMXS | 5-4F642EDMXSS | 420 | 350 |
| 10 | 3/8 | 1/4-19 | 9/16-18 | 19 | 19 | 7.5 | 6.0 | 40 | 18.5 | 41 | 6F642EDMXS | 6F642EDMXSS | 350 | 350 |
| 10 | 3/8 | 3/8-19 | 9/16-18 | 22 | 19 | 7.5 | 9.0 | 41 | 19.0 | 57 | 6-6F642EDMXS | 6-6F642EDMXSS | 350 | 350 |
| 12 | 1/2 | 3/8-19 | 3/4-16 | 22 | 22 | 9.9 | 9.0 | 44 | 21.0 | 62 | 8F642EDMXS | 8F642EDMXSS | 350 | 350 |
| 12 | 1/2 | 1/4-19 | 3/4-16 | 19 | 22 | 9.9 | 6.0 | 44 | 21.0 | 60 | 8-4F642EDMXS | 8-4F642EDMXSS | 350 | 350 |
| 12 | 1/2 | 1/2-14 | 3/4-16 | 27 | 22 | 9.9 | 14.0 | 48 | 23.0 | 75 | 8-8F642EDMXS | 8-8F642EDMXSS | 350 | 350 |
| 14, 15, 16 | 5/8 | 1/2-14 | 7/8-14 | 27 | 27 | 12.3 | 14.0 | 50 | 23.0 | 127 | 10F642EDMXS | 10F642EDMXSS | 350 | 350 |
| 14, 15, 16 | 5/8 | 3/8-19 | 7/8-14 | 22 | 27 | 12.3 | 9.0 | 44 | 21.0 | 84 | 10-6F642EDMXS | 10-6F642EDMXSS | 350 | 350 |
| | | | | 36 | 32 | 12.3 | 12.3 | 49 | 23.0 | 169 | 10-12F642EDMXS | 10-12F642EDMXSS | 350 | 350 |
| 18, 20 | 3/4 | 3/4-14 | 1 1/16-12 | 32 | 32 | 15.5 | 18.0 | 55 | 24.5 | 183 | 12F642EDMXS | 12F642EDMXSS | 350 | 350 |
| 18, 20 | 3/4 | 1/2-14 | 1 1/16-12 | 27 | 32 | 15.5 | 14.0 | 53 | 24.5 | 170 | 12-8F642EDMXS | 12-8F642EDMXSS | 350 | 350 |
| 25 | 1 | 1-11 | 1 5/16-12 | 41 | 38 | 21.5 | 23.0 | 61 | 27.5 | 296 | 16F642EDMXS | 16F642EDMXSS | 250 | 250 |
| 25 | 1 | 3/4-14 | 1 5/16-12 | 32 | 38 | 21.5 | 18.0 | 59 | 27.5 | 254 | 16-12F642EDMXS | 16-12F642EDMXSS | 250 | 250 |
| 28, 30, 33 | 1 1/4 | 1 1/4-11 | 1 5/8-12 | 50 | 50 | 27.5 | 30.0 | 68 | 32.0 | 500 | 20F642EDMXS | 20F642EDMXSS | 250 | 210 |
| 28, 30, 32 | 1 1/4 | 1-11 | 1 5/8-12 | 41 | 50 | 27.5 | 23.0 | 70 | 36.5 | 440 | 20-16F642EDMXS | 20-16F642EDMXSS | 250 | 210 |
| 35, 38 | 1 1/2 | 1 1/2-11 | 1 7/8-12 | 55 | 60 | 33.0 | 36.0 | 80 | 36.0 | 739 | 24F642EDMXS | 24F642EDMXSS | 170 | 140 |

Steel, stainless steel and brass Triple-Lok® parts are delivered with NBR elastomeric seals as standard. For more details on other seal materials see page K92.

Order codes shown are part of our current manufacturing programme.

Imperial and metric parts may vary in hexagon dimensions.

PN (bar)
10 = PN (MPa)

Do not create drawings from these dimensions, they are subject to change and ISO manufacturing allowances.

Triple-Lok®

F64OMX Swivel male stud

Triple-Lok® 37° Flare female swivel end /
Male BSPP thread – O-ring + retainer ring (ISO 1179)

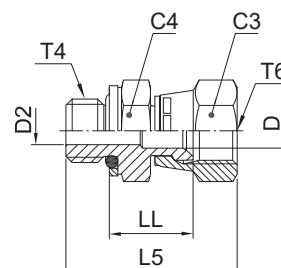

| Tube O.D. | | Thread BSPP T4 | Thread UN/UNF-2B T6 | C4 mm | C3 mm | D mm | D2 mm | L5 mm | LL mm | Weight (steel) g/1 piece | Triple-Lok® Steel | Triple-Lok® Stainless Steel | PN (bar) | |
|------------|-------|----------------|---------------------|-------|-------|------|-------|-------|-------|--------------------------|---------------------|-----------------------------|----------|-----|
| mm | in. | | | | | | | | | | | | S | SS |
| 6 | 1/4 | 1/8-28 | 7/16-20 | 17 | 14 | 4.4 | 4.4 | 32 | 17.0 | 30 | 4F64OMXS | 4F64OMXS | 350 | 350 |
| 6 | 1/4 | 1/4-19 | 7/16-20 | 19 | 14 | 4.4 | 6.0 | 34 | 17.0 | 30 | 4-4F64OMXS | 4-4F64OMXS | 350 | 350 |
| 8 | 5/16 | 1/8-28 | 1/2-20 | 17 | 17 | 6.0 | 4.0 | 32 | 17.0 | 28 | 5F64OMXS | 5F64OMXS | 350 | 350 |
| 8 | 5/16 | 1/4-19 | 1/2-20 | 19 | 17 | 7.5 | 6.0 | 36 | 18.0 | 37 | 5-4F64OMXS | 5-4F64OMXS | 350 | 350 |
| 10 | 3/8 | 1/4-19 | 9/16-18 | 19 | 19 | 7.5 | 6.0 | 37 | 18.0 | 41 | 6F64OMXS | 6F64OMXS | 350 | 350 |
| 10 | 3/8 | 3/8-19 | 9/16-18 | 22 | 19 | 7.5 | 9.0 | 38 | 19.0 | 57 | 6-6F64OMXS | 6-6F64OMXS | 350 | 350 |
| 12 | 1/2 | 3/8-19 | 3/4-16 | 22 | 22 | 9.9 | 9.0 | 41 | 21.0 | 62 | 8F64OMXS | 8F64OMXS | 350 | 350 |
| 12 | 1/2 | 1/4-19 | 3/4-16 | 19 | 22 | 9.9 | 6.0 | 43 | 20.0 | 57 | 8-4F64OMXS | 8-4F64OMXS | 350 | 350 |
| 12 | 1/2 | 1/2-14 | 3/4-16 | 30 | 22 | 9.9 | 14.0 | 46 | 23.0 | 75 | 8-8F64OMXS | 8-8F64OMXS | 350 | 350 |
| 14, 15, 16 | 5/8 | 1/2-14 | 7/8-14 | 30 | 27 | 12.3 | 14.0 | 50 | 24.5 | 127 | 10F64OMXS | 10F64OMXS | 350 | 350 |
| 14, 15, 16 | 5/8 | 3/8-19 | 7/8-14 | 22 | 27 | 12.3 | 9.0 | 44 | 22.5 | 84 | 10-6F64OMXS | 10-6F64OMXS | 350 | 350 |
| 18, 20 | 3/4 | 3/4-14 | 1 1/16-12 | 36 | 32 | 15.5 | 18.0 | 52 | 23.5 | 183 | 12F64OMXS | 12F64OMXS | 280 | 280 |
| 18, 20 | 3/4 | 1/2-14 | 1 1/16-12 | 30 | 32 | 15.5 | 14.0 | 50 | 21.5 | 169 | 12-8F64OMXS | 12-8F64OMXS | 350 | 350 |
| 25 | 1 | 1-11 | 1 5/16-12 | 46 | 38 | 21.5 | 23.0 | 59 | 27.0 | 296 | 16F64OMXS | 16F64OMXS | 250 | 250 |
| 25 | 1 | 3/4-14 | 1 5/16-12 | 36 | 38 | 21.5 | 18.0 | 54 | 26.0 | 253 | 16-12F64OMXS | 16-12F64OMXS | 250 | 250 |
| 28, 30, 32 | 1 1/4 | 1 1/4-11 | 1 5/8-12 | 50 | 50 | 27.5 | 30.0 | 64 | 32.0 | 500 | 20F64OMXS | 20F64OMXS | 250 | 175 |
| 28, 30, 32 | 1 1/4 | 1-11 | 1 5/8-12 | 46 | 50 | 27.5 | 23.0 | 63 | 31.0 | 420 | 20-16F64OMXS | 20-16F64OMXS | 250 | 175 |
| 35, 38 | 1 1/2 | 1 1/2-11 | 1 7/8-12 | 55 | 60 | 33.0 | 36.0 | 73 | 36.0 | 739 | 24F64OMXS | 24F64OMXS | 170 | 140 |

Steel, stainless steel and brass Triple-Lok® parts are delivered with NBR elastomeric seals as standard. For more details on other seal materials see page K92.

Order codes shown are part of our current manufacturing programme.

Imperial and metric parts may vary in hexagon dimensions.

$$\frac{\text{PN (bar)}}{10} = \text{PN (MPa)}$$

Do not create drawings from these dimensions, they are subject to change and ISO manufacturing allowances.

F682EDMX Swivel male stud

Triple-Lok® 37° Flare female swivel end / Male metric thread – ED seal (ISO 9974)

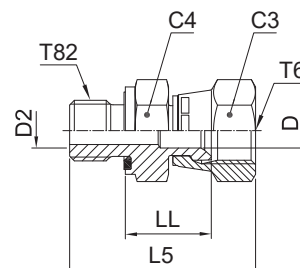

| Tube O.D. | | Thread Metric T82 | Thread UN/UNF-2B T6 | C4 mm | C3 mm | D mm | D2 mm | L5 mm | LL mm | Weight (steel) g/1 piece | Triple-Lok® Steel | Triple-Lok® Stainless Steel | PN (bar) | |
|------------|-------|-------------------|---------------------|-------|-------|------|-------|-------|-------|--------------------------|-------------------|-----------------------------|----------|-----|
| mm | in. | | | | | | | | | | | | S | SS |
| 6 | 1/4 | M 10×1.0 | 7/16-20 | 14 | 14 | 4.4 | 4.0 | 32 | 15.0 | 28 | 4M10F682EDMXS | 4M10F682EDMXSS | 500 | 350 |
| 8 | 5/16 | M 12×1.5 | 1/2-20 | 17 | 17 | 6.0 | 6.0 | 38 | 17.0 | 32 | 5M12F682EDMXS | 5M12F682EDMXSS | 420 | 350 |
| 10 | 3/8 | M 14×1.5 | 9/16-18 | 19 | 19 | 7.5 | 7.0 | 40 | 18.0 | 42 | 6M14F682EDMXS | 6M14F682EDMXSS | 350 | 350 |
| 12 | 1/2 | M 16×1.5 | 3/4-16 | 22 | 22 | 9.9 | 9.0 | 44 | 21.0 | 62 | 8M16F682EDMXS | 8M16F682EDMXSS | 350 | 350 |
| 12 | 1/2 | M 18×1.5 | 3/4-16 | 24 | 22 | 9.9 | 11.0 | 44 | 21.0 | 70 | 8M18F682EDMXS | 8M18F682EDMXSS | 350 | 350 |
| 14, 15, 16 | 5/8 | M 18×1.5 | 7/8-14 | 24 | 27 | 12.3 | 11.0 | 48 | 23.0 | 125 | 10M18F682EDMXS | 10M18F682EDMXSS | 350 | 350 |
| 14, 15, 16 | 5/8 | M 22×1.5 | 7/8-14 | 27 | 27 | 12.3 | 14.0 | 50 | 23.0 | 155 | 10M22F682EDMXS | 10M22F682EDMXSS | 350 | 350 |
| 18, 20 | 3/4 | M 22×1.5 | 1 1/16-12 | 27 | 32 | 15.5 | 14.0 | 52 | 24.5 | 160 | 12M22F682EDMXS | 12M22F682EDMXSS | 350 | 350 |
| 18, 20 | 3/4 | M 27×2.0 | 1 1/16-12 | 32 | 32 | 15.5 | 15.5 | 55 | 24.5 | 172 | 12M27F682EDMXS | 12M27F682EDMXSS | 350 | 350 |
| 25 | 1 | M 33×2.0 | 1 5/16-12 | 41 | 38 | 21.5 | 23.0 | 61 | 26.5 | 259 | 16M33F682EDMXS | 16M33F682EDMXSS | 250 | 250 |
| 28, 30, 32 | 1 1/4 | M 42×2.0 | 1 5/8-12 | 50 | 50 | 27.5 | 30.0 | 68 | 32.0 | 484 | 20M42F682EDMXS | 20M42F682EDMXSS | 250 | 210 |

Steel, stainless steel and brass Triple-Lok® parts are delivered with NBR elastomeric seals as standard. For more details on other seal materials see page K92.

Order codes shown are part of our current manufacturing programme.

Imperial and metric parts may vary in hexagon dimensions.

$$\frac{\text{PN (bar)}}{10} = \text{PN (MPa)}$$

Do not create drawings from these dimensions, they are subject to change and ISO manufacturing allowances.

K

Triple-Lok®

F68OMX Swivel male stud

Triple-Lok® 37° Flare female swivel end / Male metric thread O-ring + retaining ring

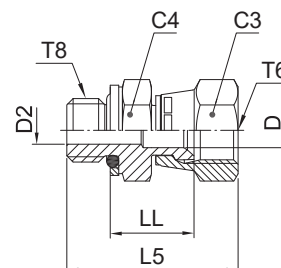

| Tube O.D. | | Thread Metric T8 | Thread UN/UNF-2B T6 | C4 mm | C3 mm | D mm | D2 mm | L5 mm | LL mm | Weight (steel) g/1 piece | Triple-Lok® Steel | PN (bar) |
|------------|-------|------------------|---------------------|-------|-------|------|-------|-------|-------|--------------------------|---------------------|----------|
| mm | in. | | | | | | | | | | | |
| 6 | 1/4 | M 10×1.0 | 7/16-20 | 14 | 14 | 4.4 | 4.0 | 32 | 15.0 | 28 | 4M10F68OMXS | 350 |
| 8 | 5/16 | M 12×1.5 | 1/2-20 | 17 | 17 | 6.0 | 6.0 | 37 | 18.0 | 32 | 5M12F68OMXS | 420 |
| 10 | 3/8 | M 14×1.5 | 9/16-18 | 19 | 19 | 7.5 | 7.0 | 38 | 19.5 | 42 | 6M14F68OMXS | 350 |
| 12 | 1/2 | M 16×1.5 | 3/4-16 | 22 | 22 | 9.9 | 7.5 | 44 | 23.0 | 62 | 8M16F68OMXS | 350 |
| 12 | 1/2 | M 18×1.5 | 3/4-16 | 24 | 22 | 9.9 | 11.0 | 45 | 23.0 | 62 | 8M18F68OMXS | 250 |
| 14, 15, 16 | 5/8 | M 18×1.5 | 7/8-14 | 24 | 27 | 12.3 | 11.0 | 48 | 25.0 | 127 | 10M18F68OMXS | 250 |
| 14, 15, 16 | 5/8 | M 22×1.5 | 7/8-14 | 27 | 27 | 12.3 | 14.0 | 49 | 25.0 | 155 | 10M22F68OMXS | 250 |
| 18, 20 | 3/4 | M 27×2.0 | 1 1/16-12 | 32 | 32 | 15.5 | 15.5 | 55 | 26.0 | 172 | 12M27F68OMXS | 210 |
| 25 | 1 | M 33×2.0 | 1 5/16-12 | 41 | 38 | 21.5 | 23.0 | 57 | 29.0 | 259 | 16M33F68OMXS | 210 |
| 28, 30, 32 | 1 1/4 | M 42×2.0 | 1 5/8-12 | 50 | 50 | 27.5 | 30.0 | 63 | 33.0 | 484 | 20M42F68OMXS | 210 |

Steel, stainless steel and brass Triple-Lok® parts are delivered with NBR elastomeric seals as standard. For more details on other seal materials see page K92.

Order codes shown are part of our current manufacturing programme.

Imperial and metric parts may vary in hexagon dimensions.

$$\frac{\text{PN (bar)}}{10} = \text{PN (MPa)}$$

Do not create drawings from these dimensions, they are subject to change and ISO manufacturing allowances.

F6MX Swivel male stud

Triple-Lok® 37° Flare female swivel end / Male NPT* thread (SAE 476)

*Stainless Steel = NPT to prevent galling

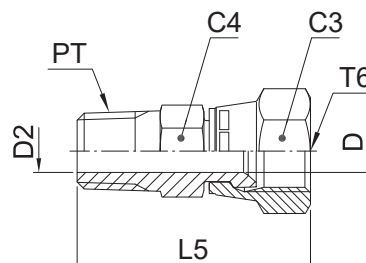

| Tube O.D. | | Thread NPT/NPTF PT | Thread UN/UNF-2B T6 | C4 mm | C3 mm | D mm | D2 mm | L5 mm | Weight (steel) g/1 piece | Triple-Lok® Steel | Triple-Lok® Stainless Steel | PN (bar) | |
|------------|-------|--------------------|---------------------|-------|-------|------|-------|-------|--------------------------|--------------------|-----------------------------|----------|-----|
| mm | in. | | | | | | | | | | | S | SS |
| 6 | 1/4 | 1/8-27 | 7/16-20 | 14.3 | 14.3 | 4.4 | 4.4 | 31 | 18 | 4 F6X-S | 4F6MXSS | 420 | 350 |
| 6 | 1/4 | 1/4-18 | 7/16-20 | 14.3 | 14.3 | 4.4 | 4.4 | 39 | 19 | 4-4 F6X-S | 4-4F6MXSS | 420 | 350 |
| 8 | 5/16 | 1/8-27 | 1/2-20 | 14.0 | 17.0 | 6.0 | 5.0 | 35 | 26 | 5F6MXS | 5F6MXSS | 420 | 350 |
| 8 | 5/16 | 1/4-18 | 1/2-20 | 16.0 | 16.0 | 6.0 | 6.0 | 40 | 37 | 5-4 F6X-S | 5-4F6MXSS | 420 | 350 |
| 10 | 3/8 | 1/4-18 | 9/16-18 | 17.5 | 17.5 | 7.1 | 7.1 | 40 | 30 | 6 F6X-S | 6F6MXSS | 350 | 350 |
| 10 | 3/8 | 3/8-18 | 9/16-18 | 19.0 | 17.5 | 7.5 | 7.5 | 43 | 48 | 6-6 F6X-S | 6-6F6MXSS | 350 | 350 |
| 12 | 1/2 | 3/8-18 | 3/4-16 | 22.2 | 22.2 | 9.9 | 9.9 | 44 | 50 | 8 F6X-S | 8F6MXSS | 350 | 350 |
| 12 | 1/2 | 1/4-18 | 3/4-16 | 19.0 | 22.0 | 9.9 | 7.0 | 44 | 46 | 8-4F6MXS | 8-4F6MXSS | 350 | 350 |
| 12 | 1/2 | 1/2-14 | 3/4-16 | 22.2 | 22.2 | 9.9 | 9.9 | 49 | 69 | 8-8 F6X-S | 8-8F6MXSS | 350 | 350 |
| 14, 15, 16 | 5/8 | 1/2-14 | 7/8-14 | 25.4 | 25.4 | 12.3 | 12.3 | 52 | 75 | 10 F6X-S | 10F6MXSS | 350 | 350 |
| 14, 15, 16 | 5/8 | 3/8-18 | 7/8-14 | 25.4 | 25.4 | 10.3 | 10.3 | 47 | 67 | 10-6 F6X-S | 10-6F6MXSS | 350 | 350 |
| 18, 20 | 3/4 | 3/4-14 | 1 1/16-12 | 31.8 | 31.8 | 15.5 | 15.5 | 55 | 125 | 12 F6X-S | 12F6MXSS | 350 | 350 |
| 18, 20 | 3/4 | 1/2-14 | 1 1/16-12 | 31.8 | 31.8 | 15.5 | 13.5 | 55 | 124 | 12-8 F6X-S | 12-8F6MXSS | 350 | 350 |
| 25 | 1 | 1-11.5 | 1 5/16-12 | 38.0 | 38.3 | 21.4 | 21.4 | 64 | 204 | 16 F6X-S | 16F6MXSS | 250 | 250 |
| 25 | 1 | 3/4-14 | 1 5/16-12 | 38.0 | 38.3 | 21.4 | 18.3 | 59 | 169 | 16-12 F6X-S | 16-12F6MXSS | 250 | 250 |
| 28, 30, 32 | 1 1/4 | 1 1/4-11.5 | 1 5/8-12 | 50.8 | 50.8 | 27.4 | 27.4 | 70 | 496 | 20 F6X-S | 20F6MXSS | 210 | 210 |
| 35, 38 | 1 1/2 | 1 1/2-11.5 | 1 7/8-12 | 57.2 | 57.2 | 33.3 | 33.3 | 77 | 750 | 24 F6X-S | 24F6MXSS | 170 | 170 |

Order codes shown are part of our current manufacturing programme.

Imperial and metric parts may vary in hexagon dimensions.

$$\frac{\text{PN (bar)}}{10} = \text{PN (MPa)}$$

Do not create drawings from these dimensions, they are subject to change and ISO manufacturing allowances.

K

Triple-Lok®

F63MX Swivel male stud

Triple-Lok® 37° Flare female swivel end / Male BSPT thread (ISO 7)

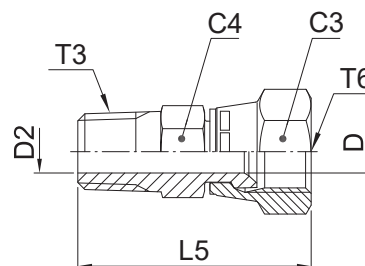

| Tube O.D. | | Thread BSPT T3 | Thread UN/UNF-2B T6 | C4 mm | C3 mm | D mm | D2 mm | L5 mm | Weight (steel) g/1 piece | Triple-Lok® Steel | Triple-Lok® Stainless Steel | PN (bar) | |
|------------|-------|----------------|---------------------|-------|-------|------|-------|-------|--------------------------|--------------------|-----------------------------|----------|-----|
| mm | in. | | | | | | | | | | | S | SS |
| 6 | 1/4 | 1/8-28 | 7/16-20 | 13 | 14 | 4.4 | 5.0 | 33 | 18 | 4F63MXS | 4F63MXSS | 315 | 315 |
| 6 | 1/4 | 1/4-19 | 7/16-20 | 14 | 14 | 4.4 | 7.0 | 38 | 19 | 4-4F63MXS | 4-4F63MXSS | 315 | 315 |
| 8 | 5/16 | 1/4-19 | 1/2-20 | 14 | 17 | 6.0 | 7.0 | 40 | 37 | 5-4F63MXS | 5-4F63MXSS | 315 | 315 |
| 10 | 3/8 | 1/4-19 | 9/16-18 | 14 | 19 | 7.5 | 7.0 | 41 | 30 | 6F63MXS | 6F63MXSS | 315 | 315 |
| 10 | 3/8 | 3/8-19 | 9/16-18 | 19 | 19 | 7.5 | 10.0 | 41 | 48 | 6-6F63MXS | 6-6F63MXSS | 315 | 315 |
| 12 | 1/2 | 3/8-19 | 3/4-16 | 19 | 22 | 9.9 | 9.9 | 44 | 50 | 8F63MXS | 8F63MXSS | 315 | 315 |
| 12 | 1/2 | 1/4-19 | 3/4-16 | 19 | 22 | 9.9 | 7.0 | 44 | 46 | 8-4F63MXS | 8-4F63MXSS | 315 | 315 |
| 14, 15, 16 | 5/8 | 1/2-14 | 7/8-14 | 22 | 27 | 12.3 | 13.5 | 53 | 75 | 10F63MXS | 10F63MXSS | 315 | 315 |
| 14, 15, 16 | 5/8 | 3/8-19 | 7/8-14 | 22 | 27 | 12.3 | 10.0 | 48 | 67 | 10-6F63MXS | 10-6F63MXSS | 315 | 315 |
| 18, 20 | 3/4 | 3/4-14 | 1 1/16-12 | 30 | 32 | 15.5 | 18.0 | 56 | 125 | 12F63MXS | 12F63MXSS | 160 | 160 |
| 18, 20 | 3/4 | 1/2-14 | 1 1/16-12 | 27 | 32 | 15.5 | 13.5 | 56 | 120 | 12-8F63MXS | 12-8F63MXSS | 315 | 315 |
| 25 | 1 | 1-11 | 1 5/16-12 | 36 | 38 | 21.5 | 24.0 | 64 | 204 | 16F63MXS | 16F63MXSS | 160 | 160 |
| 25 | 1 | 3/4-14 | 1 5/16-12 | 32 | 38 | 21.5 | 18.0 | 59 | 165 | 16-12F63MXS | 16-12F63MXSS | 160 | 160 |
| 28, 30, 32 | 1 1/4 | 1 1/4-11 | 1 5/8-12 | 46 | 50 | 27.5 | 32.0 | 70 | 496 | 20F63MXS | 20F63MXSS | 160 | 160 |

Order codes shown are part of our current manufacturing programme.

Imperial and metric parts may vary in hexagon dimensions.

$$\frac{\text{PN (bar)}}{10} = \text{PN (MPa)}$$

Do not create drawings from these dimensions, they are subject to change and ISO manufacturing allowances.

C87OMX Male stud elbow

Triple-Lok® 37° Flare end /
Adjustable metric thread – O-ring (ISO 6149)

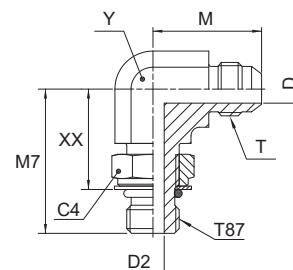

| Tube O.D. | | Thread Metric T87 | Thread UN/UNF-2A T | C4 mm | D mm | D2 mm | M mm | M7 mm | XX mm | Y mm | Weight (steel) g/1 piece | Triple-Lok® Steel | Triple-Lok® Stainless Steel | PN (bar) | |
|------------|-------|-------------------|--------------------|-------|------|-------|------|-------|-------|------|--------------------------|---------------------|-----------------------------|----------|-----|
| mm | in. | | | | | | | | | | | | | S | SS |
| 6 | 1/4 | M 10×1.0 | 7/16-20 | 14 | 4.4 | 4.5 | 23 | 27 | 19 | 11 | 17 | 4M10C87OMXS | 4M10C87OMXSS | 420 | 350 |
| 6 | 1/4 | M 12×1.5 | 7/16-20 | 17 | 4.4 | 6.0 | 24 | 31 | 19 | 13 | 20 | 4M12C87OMXS | 4M12C87OMXSS | 420 | 350 |
| 8 | 5/16 | M 10×1.0 | 1/2-20 | 14 | 6.0 | 4.5 | 24 | 26 | 17 | 13 | 22 | 5M10C87OMXS | 5M10C87OMXSS | 420 | 350 |
| 8 | 5/16 | M 12×1.5 | 1/2-20 | 17 | 6.0 | 6.0 | 24 | 31 | 19 | 13 | 25 | 5M12C87OMXS | 5M12C87OMXSS | 420 | 350 |
| 10 | 3/8 | M 14×1.5 | 9/16-18 | 19 | 7.5 | 7.5 | 27 | 34 | 22 | 14 | 31 | 6M14C87OMXS | 6M14C87OMXSS | 420 | 350 |
| 10 | 3/8 | M 16×1.5 | 9/16-18 | 22 | 7.5 | 9.0 | 29 | 38 | 26 | 19 | 55 | 6M16C87OMXS | 6M16C87OMXSS | 350 | 350 |
| 10 | 3/8 | M 16×1.5 | 3/4-16 | 22 | 9.9 | 9.0 | 32 | 38 | 26 | 19 | 65 | 8M16C87OMXS | 8M16C87OMXSS | 350 | 350 |
| 12 | 1/2 | M 18×1.5 | 3/4-16 | 24 | 9.9 | 11.0 | 32 | 38 | 25 | 19 | 66 | 8M18C87OMXS | 8M18C87OMXSS | 350 | 350 |
| 14, 15, 16 | 5/8 | M 18×1.5 | 7/8-14 | 24 | 12.3 | 11.0 | 37 | 42 | 29 | 22 | 99 | 10M18C87OMXS | 10M18C87OMXSS | 350 | 350 |
| 14, 15, 16 | 5/8 | M 22×1.5 | 7/8-14 | 27 | 12.3 | 14.0 | 37 | 43 | 29 | 22 | 99 | 10M22C87OMXS | 10M22C87OMXSS | 350 | 350 |
| 18, 20 | 3/4 | M 22×1.5 | 1 1/16-12 | 27 | 15.5 | 14.0 | 42 | 45 | 32 | 27 | 164 | 12M22C87OMXS | 12M22C87OMXSS | 350 | 350 |
| 18, 20 | 3/4 | M 27×2.0 | 1 1/16-12 | 32 | 15.5 | 18.0 | 42 | 51 | 35 | 27 | 173 | 12M27C87OMXS | 12M27C87OMXSS | 350 | 350 |
| 25 | 1 | M 27×2.0 | 1 5/16-12 | 32 | 21.5 | 18.0 | 46 | 53 | 37 | 33 | 287 | 16M27C87OMXS | 16M27C87OMXSS | 280 | 280 |
| 25 | 1 | M 33×2.0 | 1 5/16-12 | 41 | 21.5 | 23.0 | 46 | 53 | 37 | 33 | 287 | 16M33C87OMXS | 16M33C87OMXSS | 280 | 280 |
| 28, 30, 32 | 1 1/4 | M 42×2.0 | 1 5/8-12 | 50 | 27.5 | 30.0 | 52 | 58 | 42 | 41 | 575 | 20M42C87OMXS | 20M42C87OMXSS | 210 | 210 |
| 35, 38 | 1 1/2 | M 48×2.0 | 1 7/8-12 | 55 | 33.0 | 36.0 | 59 | 64 | 46 | 48 | 874 | 24M48C87OMXS | 24M48C87OMXSS | 140 | 140 |

Steel, stainless steel and brass Triple-Lok® parts are delivered with NBR elastomeric seals as standard. For more details on other seal materials see page K92.

Order codes shown are part of our current manufacturing programme.

Imperial and metric parts may vary in hexagon dimensions.

$$\frac{\text{PN (bar)}}{10} = \text{PN (MPa)}$$

Do not create drawings from these dimensions, they are subject to change and ISO manufacturing allowances.

K

Triple-Lok®

C50MX Male stud elbow

Triple-Lok® 37° Flare end /
Adjustable UN/UNF thread – O-ring (ISO 11926)
SAE 070220 MS51527

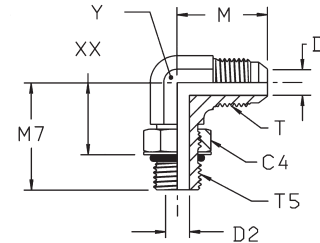

| Tube O.D. mm | in. | Thread UN/UNF-2A T5 | Thread UN/UNF-2A T | C4 mm | D mm | D2 mm | M mm | M7 mm | XX mm | Y mm | Weight (steel) g/1 piece | Triple-Lok® | | PN (bar) | |
|--------------------|-------|---------------------------|--------------------------|----------|---------|----------|---------|----------|----------|---------|--------------------------------|---------------------|---------------------|----------|-----|
| | | | | | | | | | | | | Steel | Stainless Steel | S | SS |
| 6 | 1/8 | 5/16-24 | 5/16-24 | 11.1 | 1.5 | 1.5 | 20 | 24 | 15 | 11 | 25 | 2 C50X-S | | 350 | — |
| | 3/16 | 3/8-24 | 3/8-24 | 12.7 | 3.2 | 3.2 | 21 | 24 | 15 | 11 | 30 | 3 C50X-S | | 350 | — |
| | 1/4 | 7/16-20 | 7/16-20 | 14.3 | 4.4 | 4.5 | 23 | 26 | 16 | 11 | 37 | 4C50MXS | 4C50MXSS | 420 | 350 |
| | 1/4 | 9/16-18 | 7/16-20 | 17.5 | 4.4 | 7.5 | 27 | 32 | 20 | 14 | 43 | 4-6 C50X-S | 4-6C50MXSS | 420 | 350 |
| 8 | 5/16 | 1/2-20 | 1/2-20 | 16.0 | 6.0 | 6.0 | 24 | 29 | 18 | 13 | 47 | 5C50MXS | 5C50MXSS | 420 | 350 |
| | 5/16 | 7/16-20 | 1/2-20 | 14.3 | 6.0 | 4.4 | 24 | 29 | 18 | 14 | 55 | 5-4 C50X-S | 5-4C50MXSS | 420 | 350 |
| 8 | 5/16 | 9/16-18 | 1/2-20 | 17.5 | 6.0 | 7.5 | 27 | 32 | 20 | 14 | 62 | 5-6 C50X-S | 5-6C50MXSS | 420 | 350 |
| | 3/8 | 9/16-18 | 9/16-18 | 17.5 | 7.5 | 7.5 | 27 | 32 | 20 | 14 | 63 | 6C50MXS | 6C50MXSS | 420 | 350 |
| 10 | 3/8 | 7/16-20 | 9/16-18 | 14.3 | 7.5 | 4.4 | 27 | 30 | 20 | 14 | 99 | 6-4 C50X-S | 6-4C50MXSS | 420 | 350 |
| | 3/8 | 1/2-20 | 9/16-18 | 16.0 | 7.5 | 6.0 | 27 | 30 | 19 | 14 | 99 | 6-5 C50X-S | 6-5C50MXSS | 420 | 350 |
| 10 | 3/8 | 3/4-16 | 9/16-18 | 22.2 | 7.5 | 10.0 | 29 | 37 | 24 | 19 | 125 | 6-8 C50X-S | 6-8C50MXSS | 420 | 350 |
| | 3/8 | 7/8-14 | 9/16-18 | 25.4 | 7.5 | 12.5 | 31 | 43 | 28 | 22 | 145 | 6-10 C50X-S | 6-10C50MXSS | 350 | 350 |
| 12 | 1/2 | 3/4-16 | 3/4-16 | 22.2 | 9.9 | 10.0 | 32 | 37 | 24 | 19 | 160 | 8C50MXS | 8C50MXSS | 420 | 350 |
| | 1/2 | 7/16-20 | 3/4-16 | 14.3 | 9.9 | 4.4 | 32 | 32 | 21 | 19 | 150 | 8-4 C50X-S | 8-4C50MXSS | 420 | 350 |
| 12 | 1/2 | 9/16-18 | 3/4-16 | 17.5 | 9.9 | 7.5 | 32 | 34 | 22 | 19 | 130 | 8-6 C50X-S | 8-6C50MXSS | 420 | 350 |
| | 1/2 | 7/8-14 | 3/4-16 | 27.0 | 9.9 | 12.5 | 34 | 43 | 28 | 22 | 180 | 8-10C50MXS | 8-10C50MXSS | 350 | 350 |
| 12 | 1/2 | 1 1/16-12 | 3/4-16 | 31.8 | 9.9 | 15.5 | 36 | 49 | 32 | 27 | 210 | 8-12 C50X-S | 8-12C50MXSS | 350 | 350 |
| | 5/8 | 7/8-14 | 7/8-14 | 27.0 | 12.3 | 12.5 | 37 | 43 | 28 | 22 | 186 | 10C50MXS | 10C50MXSS | 350 | 350 |
| 14, 15, 16 | 5/8 | 9/16-18 | 7/8-14 | 17.5 | 12.3 | 7.5 | 37 | 36 | 24 | 22 | 130 | 10-6 C50X-S | 10-6C50MXSS | 350 | 350 |
| | 5/8 | 3/4-16 | 7/8-14 | 22.2 | 12.3 | 10.0 | 37 | 39 | 26 | 22 | 157 | 10-8 C50X-S | 10-8C50MXSS | 350 | 350 |
| 14, 15, 16 | 5/8 | 1 1/16-12 | 7/8-14 | 31.8 | 12.3 | 15.5 | 39 | 49 | 32 | 27 | 331 | 10-12 C50X-S | 10-12C50MXSS | 350 | 350 |
| | 5/8 | 1 5/16-12 | 7/8-14 | 38.0 | 12.3 | 21.4 | 42 | 52 | 35 | 33 | 400 | 10-16 C50X-S | 10-16C50MXSS | 280 | 280 |
| 18, 20 | 3/4 | 1 1/16-12 | 1 1/16-12 | 32.0 | 15.5 | 15.5 | 42 | 49 | 32 | 27 | 301 | 12C50MXS | 12C50MXSS | 350 | 350 |
| | 3/4 | 3/4-16 | 1 1/16-12 | 22.2 | 15.5 | 10.0 | 42 | 41 | 28 | 27 | 297 | 12-8 C50X-S | 12-8C50MXSS | 350 | 350 |
| 18, 20 | 3/4 | 7/8-14 | 1 1/16-12 | 27.0 | 15.5 | 12.5 | 42 | 45 | 30 | 27 | 297 | 12-10C50MXS | 12-10C50MXSS | 350 | 350 |
| | 3/4 | 1 5/16-12 | 1 1/16-12 | 38.0 | 15.5 | 21.4 | 45 | 52 | 35 | 33 | 421 | 12-16 C50X-S | 12-16C50MXSS | 280 | 280 |
| 22 | 7/8 | 1 3/16-12 | 1 3/16-12 | 35.0 | 18.3 | 18.0 | 46 | 51 | 34 | 33 | 417 | 14 C50X-S | | 280 | — |
| | 1 | 1 5/16-12 | 1 5/16-12 | 41.0 | 21.5 | 21.5 | 46 | 52 | 35 | 33 | 426 | 16C50MXS | 16C50MXSS | 280 | 280 |
| 25 | 1 | 1 1/16-12 | 1 5/16-12 | 31.8 | 21.5 | 15.5 | 46 | 52 | 35 | 33 | 418 | 16-12 C50X-S | 16-12C50MXSS | 280 | 280 |
| | 1 | 1 5/8-12 | 1 5/16-12 | 47.6 | 21.5 | 27.4 | 51 | 57 | 40 | 41 | 546 | 16-20 C50X-S | 16-20C50MXSS | 280 | 210 |
| 28, 30, 32 | 1 1/4 | 1 5/8-12 | 1 5/8-12 | 47.6 | 27.4 | 27.4 | 52 | 57 | 40 | 41 | 674 | 20 C50X-S | 20C50MXSS | 280 | 210 |
| | 1 1/4 | 1 5/16-12 | 1 5/8-12 | 38.0 | 27.4 | 21.5 | 52 | 57 | 40 | 41 | 650 | 20-16 C50X-S | 20-16C50MXSS | 280 | 280 |
| 28, 30, 32 | 1 1/4 | 1 7/8-12 | 1 5/8-12 | 54.0 | 27.4 | 33.4 | 56 | 61 | 44 | 48 | 920 | 20-24 C50X-S | 20-24C50MXSS | 210 | 210 |
| | 1 1/2 | 1 7/8-12 | 1 7/8-12 | 54.0 | 33.4 | 33.4 | 59 | 61 | 44 | 48 | 917 | 24 C50X-S | 24C50MXSS | 210 | 140 |
| 35, 38 | 1 1/2 | 1 7/8-12 | 1 7/8-12 | 54.0 | 33.4 | 27.4 | 59 | 61 | 44 | 48 | 917 | 24-20 C50X-S | 24-20C50MXSS | 210 | 140 |

Steel, stainless steel and brass Triple-Lok® parts are delivered with NBR elastomeric seals as standard. For more details on other seal materials see page K92.

Order codes shown are part of our current manufacturing programme.

Imperial and metric parts may vary in hexagon dimensions.

$$\frac{\text{PN (bar)}}{10} = \text{PN (MPa)}$$

Do not create drawings from these dimensions, they are subject to change and ISO manufacturing allowances.

CC50X Extended male stud elbow

Triple-Lok® 37° Flare end / Male UNF thread – O-ring (ISO 11926)

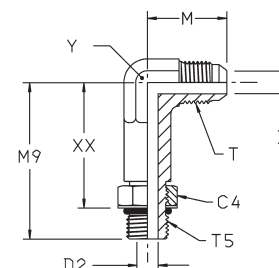

| Tube O.D. | | Thread UN/UNF-2A T5 | Thread UN/UNF-2A T | C4 mm | D mm | D2 mm | M mm | M9 mm | XX mm | Y mm | Weight (steel) g/1 piece | Triple-Lok® Steel | PN (bar) |
|------------|-----|---------------------|--------------------|-------|------|-------|------|-------|-------|------|--------------------------|-------------------|----------|
| 6 | 1/4 | 7/16-20 | 7/16-20 | 14.3 | 4.4 | 4.5 | 23 | 44 | 33 | 14 | 44 | 4 CC50X-S | 420 |
| 10 | 3/8 | 9/16-18 | 9/16-18 | 17.5 | 7.5 | 7.5 | 27 | 53 | 41 | 14 | 51 | 6 CC50X-S | 420 |
| 12 | 1/2 | 3/4-16 | 3/4-16 | 22.2 | 9.9 | 9.9 | 32 | 64 | 50 | 22 | 146 | 8 CC50X-S | 420 |
| 14, 15, 16 | 5/8 | 7/8-14 | 7/8-14 | 25.4 | 12.3 | 12.3 | 37 | 73 | 58 | 22 | 169 | 10 CC50X-S | 350 |
| 18, 20 | 3/4 | 1 1/16-12 | 1 1/16-12 | 32.0 | 15.5 | 15.5 | 42 | 85 | 67 | 37 | 291 | 12 CC50X-S | 350 |
| 25 | 1 | 1 5/16-12 | 1 5/16-12 | 38.0 | 21.5 | 21.5 | 46 | 95 | 78 | 33 | 481 | 16 CC50X-S | 280 |

Steel, stainless steel and brass Triple-Lok® parts are delivered with NBR elastomeric seals as standard. For more details on other seal materials see page K92.

Order codes shown are part of our current manufacturing programme.

Imperial and metric parts may vary in hexagon dimensions.

$$\frac{\text{PN (bar)}}{10} = \text{PN (MPa)}$$

Do not create drawings from these dimensions, they are subject to change and ISO manufacturing allowances.

K

Triple-Lok®

C4OMX Male stud elbow

Triple-Lok® 37° Flare end / Adjustable BSPP thread O-ring + retaining ring (ISO 1179)

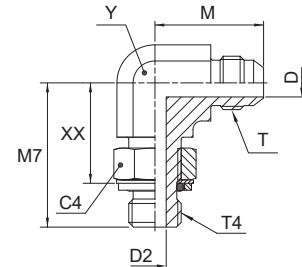

| Tube O.D. | | Thread BSPP T4 | Thread UN/UNF-2A T | C4 mm | D mm | D2 mm | M mm | M7 mm | XX mm | Y mm | Weight (steel) g/1 piece | Triple-Lok® Steel | Triple-Lok® Stainless Steel | PN (bar) | |
|------------|-------|----------------|--------------------|-------|------|-------|------|-------|-------|------|--------------------------|-------------------|-----------------------------|----------|-----|
| mm | in. | | | | | | | | | | | | | S | SS |
| 6 | 1/4 | 1/8-28 | 7/16-20 | 14 | 4.4 | 4.4 | 23 | 27 | 19 | 11 | 37 | 4C4OMXS | 4C4OMXS | 250 | 250 |
| 6 | 1/4 | 1/4-19 | 7/16-20 | 19 | 4.4 | 7.5 | 27 | 32 | 21 | 14 | 43 | 4-4C4OMXS | 4-4C4OMXS | 250 | 200 |
| 6 | 1/4 | 3/8-19 | 7/16-20 | 22 | 4.4 | 9.9 | 29 | 37 | 26 | 19 | 50 | 4-6C4OMXS | 4-6C4OMXS | 250 | 200 |
| 8 | 5/16 | 1/8-28 | 1/2-20 | 14 | 6.0 | 4.4 | 24 | 27 | 19 | 13 | 47 | 5C4OMXS | 5C4OMXS | 250 | 250 |
| 8 | 5/16 | 1/4-19 | 1/2-20 | 19 | 6.0 | 7.5 | 27 | 32 | 21 | 14 | 55 | 5-4C4OMXS | 5-4C4OMXS | 250 | 200 |
| 8 | 5/16 | 3/8-19 | 1/2-20 | 22 | 6.0 | 9.9 | 29 | 37 | 26 | 19 | 57 | 5-6C4OMXS | 5-6C4OMXS | 250 | 200 |
| 10 | 3/8 | 1/4-19 | 9/16-18 | 19 | 7.5 | 7.5 | 27 | 32 | 21 | 14 | 61 | 6C4OMXS | 6C4OMXS | 250 | 200 |
| 10 | 3/8 | 1/8-28 | 9/16-18 | 14 | 7.5 | 4.4 | 27 | 28 | 19 | 14 | 52 | 6-2C4OMXS | 6-2C4OMXS | 250 | 200 |
| 10 | 3/8 | 3/8-19 | 9/16-18 | 22 | 7.5 | 9.9 | 29 | 37 | 26 | 19 | 95 | 6-6C4OMXS | 6-6C4OMXS | 250 | 200 |
| 10 | 3/8 | 1/2-14 | 9/16-18 | 27 | 7.5 | 12.3 | 31 | 43 | 29 | 22 | 80 | 6-8C4OMXS | 6-8C4OMXS | 250 | 200 |
| 12 | 1/2 | 3/8-19 | 3/4-16 | 22 | 9.9 | 9.9 | 32 | 37 | 27 | 19 | 102 | 8C4OMXS | 8C4OMXS | 250 | 200 |
| 12 | 1/2 | 1/4-19 | 3/4-16 | 19 | 9.9 | 7.5 | 32 | 37 | 26 | 19 | 91 | 8-4C4OMXS | 8-4C4OMXS | 250 | 200 |
| 12 | 1/2 | 1/2-14 | 3/4-16 | 27 | 9.9 | 12.3 | 34 | 43 | 29 | 22 | 155 | 8-8C4OMXS | 8-8C4OMXS | 250 | 200 |
| 12 | 1/2 | 3/4-14 | 3/4-16 | 36 | 9.9 | 15.5 | 36 | 50 | 35 | 27 | 205 | 8-12C4OMXS | 8-12C4OMXS | 250 | 200 |
| 14, 15, 16 | 5/8 | 1/2-14 | 7/8-14 | 27 | 12.3 | 12.3 | 37 | 43 | 29 | 22 | 164 | 10C4OMXS | 10C4OMXS | 250 | 200 |
| 14, 15, 16 | 5/8 | 3/8-19 | 7/8-14 | 22 | 12.3 | 9.9 | 37 | 36 | 25 | 22 | 190 | 10-6C4OMXS | 10-6C4OMXS | 250 | 200 |
| 14, 15, 16 | 5/8 | 3/4-14 | 7/8-14 | 36 | 12.3 | 15.5 | 39 | 50 | 35 | 27 | 217 | 10-12C4OMXS | 10-12C4OMXS | 250 | 200 |
| 18, 20 | 3/4 | 3/4-14 | 1 1/16-12 | 36 | 15.5 | 15.5 | 42 | 50 | 35 | 27 | 295 | 12C4OMXS | 12C4OMXS | 250 | 200 |
| 18, 20 | 3/4 | 1/2-14 | 1 1/16-12 | 27 | 15.5 | 12.3 | 42 | 50 | 35 | 27 | 245 | 12-8C4OMXS | 12-8C4OMXS | 250 | 200 |
| 18, 20 | 3/4 | 1-11 | 1 1/16-12 | 41 | 15.5 | 21.5 | 45 | 52 | 35 | 33 | 317 | 12-16C4OMXS | 12-16C4OMXS | 250 | 200 |
| 25 | 1 | 1-11 | 1 5/16-12 | 41 | 21.5 | 21.5 | 46 | 52 | 36 | 33 | 425 | 16C4OMXS | 16C4OMXS | 250 | 200 |
| 25 | 1 | 3/4-14 | 1 5/16-12 | 36 | 21.5 | 15.5 | 46 | 47 | 33 | 33 | 405 | 16-12C4OMXS | 16-12C4OMXS | 250 | 200 |
| 28, 30, 32 | 1 1/4 | 1 1/4-11 | 1 5/8-12 | 50 | 27.5 | 27.5 | 52 | 57 | 41 | 41 | 697 | 20C4OMXS | 20C4OMXS | 210 | 160 |
| 28, 30, 32 | 1 1/4 | 1-11 | 1 5/8-12 | 41 | 21.5 | 27.5 | 52 | 57 | 41 | 41 | 650 | 20-16C4OMXS | 20-16C4OMXS | 250 | 160 |
| 35, 38 | 1 1/2 | 1 1/2-11 | 1 7/8-12 | 55 | 33.0 | 33.0 | 59 | 61 | 45 | 48 | 953 | 24C4OMXS | 24C4OMXS | 140 | 140 |
| 35, 38 | 1 1/2 | 1 1/4-11 | 1 7/8-12 | 50 | 33.0 | 27.5 | 59 | 61 | 45 | 48 | 964 | 24-20C4OMXS | 24-20C4OMXS | 210 | 140 |

Steel, stainless steel and brass Triple-Lok® parts are delivered with NBR elastomeric seals as standard. For more details on other seal materials see page K92.

Order codes shown are part of our current manufacturing programme.

Imperial and metric parts may vary in hexagon dimensions.

$$\frac{\text{PN (bar)}}{10} = \text{PN (MPa)}$$

Do not create drawings from these dimensions, they are subject to change and ISO manufacturing allowances.

C8OMX Male stud elbow

Triple-Lok® 37° Flare end / Male metric thread – O-ring + retainer ring

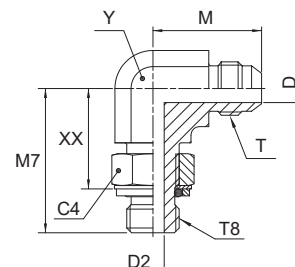

| Tube O.D. | | Thread Metric T8 | Thread UN/UNF-2A T | C4 mm | D mm | D2 mm | M mm | M7 mm | XX mm | Y mm | Weight (steel) g/1 piece | Triple-Lok® Steel | PN (bar) |
|------------|-------|------------------|--------------------|-------|------|-------|------|-------|-------|------|--------------------------|--------------------|----------|
| mm | in. | | | | | | | | | | | | |
| 6 | 1/4 | M 10×1.0 | 7/16-20 | 14 | 4.4 | 4.5 | 23 | 27.0 | 18 | 11 | 23 | 4M10C8OMXS | 250 |
| 6 | 1/4 | M 12×1.5 | 7/16-20 | 17 | 4.4 | 6.0 | 24 | 30.5 | 19 | 13 | 28 | 4M12C8OMXS | 250 |
| 8 | 5/16 | M 10×1.0 | 1/2-20 | 14 | 6.0 | 4.5 | 24 | 26.0 | 17 | 13 | 29 | 5M10C8OMXS | 250 |
| 8 | 5/16 | M 12×1.5 | 1/2-20 | 17 | 6.0 | 6.0 | 24 | 31.0 | 19 | 13 | 29 | 5M12C8OMXS | 250 |
| 8 | 5/16 | M 12×1.5 | 9/16-18 | 17 | 7.5 | 6.0 | 27 | 34.0 | 22 | 14 | 48 | 6M12C8OMXS | 250 |
| 10 | 3/8 | M 14×1.5 | 9/16-18 | 17 | 7.5 | 7.5 | 27 | 34.0 | 22 | 14 | 36 | 6M14C8OMXS | 250 |
| 10 | 3/8 | M 16×1.5 | 9/16-18 | 19 | 7.5 | 9.0 | 29 | 38.0 | 27 | 19 | 74 | 6M16C8OMXS | 250 |
| 10 | 3/8 | M 18×1.5 | 9/16-18 | 22 | 7.5 | 11.0 | 29 | 38.0 | 26 | 19 | 100 | 6M18C8OMXS | 250 |
| 12 | 1/2 | M 16×1.5 | 3/4-16 | 19 | 9.9 | 9.0 | 32 | 38.0 | 27 | 19 | 77 | 8M16C8OMXS | 250 |
| 12 | 1/2 | M 18×1.5 | 3/4-16 | 22 | 9.9 | 11.0 | 32 | 38.0 | 26 | 19 | 78 | 8M18C8OMXS | 250 |
| 12 | 1/2 | M 22×1.5 | 3/4-16 | 27 | 9.9 | 14.0 | 34 | 43.0 | 31 | 22 | 95 | 8M22C8OMXS | 250 |
| 14, 15, 16 | 5/8 | M 18×1.5 | 7/8-14 | 22 | 12.3 | 11.0 | 37 | 42.0 | 31 | 22 | 104 | 10M18C8OMXS | 250 |
| 14, 15, 16 | 5/8 | M 22×1.5 | 7/8-14 | 27 | 12.3 | 14.0 | 37 | 43.0 | 31 | 22 | 119 | 10M22C8OMXS | 250 |
| 18, 20 | 3/4 | M 22×1.5 | 1 1/16-12 | 27 | 15.5 | 14.0 | 42 | 45.0 | 34 | 27 | 198 | 12M22C8OMXS | 250 |
| 18, 20 | 3/4 | M 27×2.0 | 1 1/16-12 | 32 | 15.5 | 18.0 | 42 | 51.0 | 38 | 27 | 208 | 12M27C8OMXS | 175 |
| 25 | 1 | M 33×2.0 | 1 5/16-12 | 38 | 21.5 | 23.0 | 46 | 53.0 | 40 | 33 | 333 | 16M33C8OMXS | 140 |
| 28, 30, 32 | 1 1/4 | M 42×2.0 | 1 5/8-12 | 50 | 27.5 | 30.0 | 52 | 58.0 | 45 | 41 | 575 | 20M42C8OMXS | 140 |
| 35, 38 | 1 1/2 | M 48×2.0 | 1 7/8-12 | 55 | 33.0 | 36.0 | 59 | 64.0 | 49 | 48 | 872 | 24M48C8OMXS | 140 |

K

Steel, stainless steel and brass Triple-Lok® parts are delivered with NBR elastomeric seals as standard. For more details on other seal materials see page K92.

Order codes shown are part of our current manufacturing programme.

Imperial and metric parts may vary in hexagon dimensions.

$$\frac{\text{PN (bar)}}{10} = \text{PN (MPa)}$$

Do not create drawings from these dimensions, they are subject to change and ISO manufacturing allowances.

Triple-Lok®

CMTX Male stud elbow

Triple-Lok® 37° Flare end / Male NPTF* thread (SAE 476)

SAE 070202 MS51504

*Stainless Steel = NPT to prevent galling

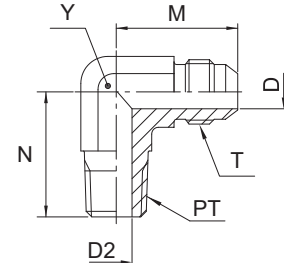

| Tube O.D. | | Thread NPT/NPTF PT | Thread UN/UNF-2A T | D mm | D2 mm | M mm | N mm | Y mm | Weight (steel) g/1 piece | Triple-Lok® Steel | Triple-Lok® Stainless Steel | PN (bar) | |
|------------|-------|--------------------|--------------------|---------|--------|------|------|------|--------------------------|--------------------|-----------------------------|------------------|-----|
| mm | in. | | | | | | | | | | | S | SS |
| 6 | 1/8 | 1/8-27 | 5/16-24 | 1.6 | 4.8 | 20 | 18 | 11.0 | 12 | 2 CTX-S | | 420 | — |
| | 3/16 | 1/8-27 | 3/8-24 | 3.2 | 4.8 | 21 | 18 | 11.0 | 15 | 3 CTX-S | | 420 | — |
| | 1/4 | 1/8-27 | 7/16-20 | 4.4 | 5.0 | 23 | 20 | 11.0 | 23 | 4CMTXS | 4CMTXSS | 420 | 350 |
| | 6 | 1/4 | 1/4-18 | 7/16-20 | 4.4 | 7.0 | 27 | 28 | 14.0 | 42 | 4-4 CTX-S | 4-4CMTXSS | 420 |
| 6 | 1/4 | 3/8-18 | 7/16-20 | 4.4 | 10.3 | 28 | 31 | 19.0 | 26 | 4-6 CTX-S | 4-6CMTXSS | 420 | 350 |
| 6 | 1/4 | 1/2-14 | 7/16-20 | 4.4 | 13.5 | 31 | 37 | 22.0 | 30 | 4-8 CTX-S | 4-8CMTXSS | 420 | 350 |
| 8 | 5/16 | 1/8-27 | 1/2-20 | 6.0 | 4.8 | 24 | 20 | 14.0 | 29 | 5 CTX-S | 5CMTXSS | 420 | 350 |
| 8 | 5/16 | 1/4-18 | 1/2-20 | 6.0 | 7.2 | 27 | 28 | 14.0 | 42 | 5-4 CTX-S | 5-4CMTXSS | 420 | 350 |
| 8 | 5/16 | 3/8-18 | 1/2-20 | 6.0 | 10.3 | 29 | 31 | 19.0 | 45 | 5-6 CTX-S | 5-6CMTXSS | 420 | 350 |
| 10 | 3/8 | 1/4-18 | 9/16-18 | 7.5 | 7.0 | 27 | 28 | 14.0 | 45 | 6CMTXS | 6CMTXSS | 420 | 350 |
| 10 | 3/8 | 1/8-27 | 9/16-18 | 7.5 | 4.8 | 27 | 23 | 14.0 | 55 | 6-2 CTX-S | 6-2CMTXSS | 420 | 350 |
| 10 | 3/8 | 3/8-18 | 9/16-18 | 7.5 | 10.0 | 29 | 31 | 19.0 | 76 | 6-6CMTXS | 6-6CMTXSS | 420 | 350 |
| 10 | 3/8 | 1/2-14 | 9/16-18 | 7.5 | 13.5 | 31 | 37 | 22.0 | 117 | 6-8CMTXS | 6-8CMTXSS | 420 | 350 |
| 12 | 1/2 | 3/8-18 | 3/4-16 | 9.9 | 10.0 | 32 | 31 | 19.0 | 86 | 8CMTXS | 8CMTXSS | 420 | 350 |
| 12 | 1/2 | 1/4-18 | 3/4-16 | 9.9 | 7.0 | 32 | 31 | 19.0 | 82 | 8-4CMTXS | 8-4CMTXSS | 420 | 350 |
| 12 | 1/2 | 1/2-14 | 3/4-16 | 9.9 | 13.5 | 34 | 37 | 22.0 | 125 | 8-8CMTXS | 8-8CMTXSS | 420 | 350 |
| 12 | 1/2 | 3/4-14 | 3/4-16 | 9.9 | 3/4-16 | 36 | 40 | 27.0 | 190 | 8-12 CTX-S | 8-12CMTXSS | 280 | 280 |
| 14, 15, 16 | 5/8 | 1/2-14 | 7/8-14 | 12.3 | 13.5 | 37 | 37 | 22.0 | 129 | 10CMTXS | 10CMTXSS | 350 | 350 |
| 14, 15, 16 | 5/8 | 3/8-18 | 7/8-14 | 12.3 | 10.3 | 37 | 33 | 22.0 | 127 | 10-6 CTX-S | 10-6CMTXSS | 350 | 350 |
| 14, 15, 16 | 5/8 | 3/4-14 | 7/8-14 | 12.3 | 18.0 | 39 | 40 | 27.0 | 192 | 10-12CMTXS | 10-12CMTXSS | 280 | 280 |
| 18, 20 | 3/4 | 3/4-14 | 1 1/16-12 | 15.5 | 18.3 | 42 | 40 | 27.0 | 198 | 12 CTX-S | 12CMTXSS | 280 | 280 |
| 18, 20 | 3/4 | 1/2-14 | 1 1/16-12 | 15.5 | 13.5 | 42 | 40 | 27.0 | 204 | 12-8 CTX-S | 12-8CMTXSS | 350 | 350 |
| 18, 20 | 3/4 | 1-11.5 | 1 1/16-12 | 15.5 | 23.8 | 45 | 50 | 33.0 | 318 | 12-16CMTXS | 12-16CMTXSS | 210 | 210 |
| 22 | 7/8 | 3/4-14 | 1 3/16-12 | 18.3 | 18.3 | 46 | 48 | 33.4 | 260 | 14 CTX-S | 14CMTXSS | 280 | 245 |
| 25 | 1 | 1-11.5 | 1 5/16-12 | 21.5 | 23.8 | 46 | 50 | 33.4 | 328 | 16 CTX-S | 16CMTXSS | 210 | 210 |
| 25 | 1 | 3/4-14 | 1 5/16-12 | 21.5 | 18.3 | 46 | 45 | 33.4 | 318 | 16-12 CTX-S | 16-12CMTXSS | 280 | 280 |
| 25 | 1 | 1 1/4-11.5 | 1 5/16-12 | 21.5 | 31.8 | 51 | 61 | 41.0 | 477 | 16-20 CTX-S | 16-20CMTXSS | 170 | 170 |
| 28, 30, 32 | 1 1/4 | 1 1/4-11.5 | 1 5/8-12 | 27.4 | 31.8 | 52 | 61 | 41.0 | 549 | 20 CTX-S | 20CMTXSS | 170 | 170 |
| 28, 30, 32 | 1 1/4 | 1-11.5 | 1 5/8-12 | 27.4 | 24.0 | 52 | 60 | 41.0 | 536 | 20-16CMTXS | 20-16CMTXSS | 210 | 210 |
| 28, 30, 32 | 1 1/4 | 1 1/2-11.5 | 1 5/8-12 | 27.4 | 38.0 | 56 | 67 | 48.0 | 630 | 20-24 CTX-S | 20-24CMTXSS | 170 | 140 |
| 35, 38 | 1 1/2 | 1 1/2-11.5 | 1 7/8-12 | 33.3 | 38.0 | 59 | 67 | 48.0 | 747 | 24 CTX-S | 24CMTXSS | 170 | 140 |
| 35, 38 | 1 1/2 | 1 1/4-11.5 | 1 7/8-12 | 33.3 | 31.8 | 59 | 57 | 48.0 | 715 | 24-20 CTX-S | 24-20CMTXSS | 170 | 140 |
| | 2 | 2-11.5 | 2 1/2-12 | 45.2 | 49.2 | 78 | 76 | 64.0 | 1644 | 32 CTX-S | | 140 | — |
| | 2 | 1 1/2-11.5 | 2 1/2-12 | 45.2 | 38.0 | 78 | 75 | 64.0 | 1450 | 32-24 CTX-S | | 140 | — |

Order codes shown are part of our current manufacturing programme.

Imperial and metric parts may vary in hexagon dimensions.

PN (bar) / 10 = PN (MPa)

Do not create drawings from these dimensions, they are subject to change and ISO manufacturing allowances.

CCTX Extended male stud elbow

Triple-Lok® 37° Flare end / Male NPTF* thread (SAE 476)

SAE 070202 MS51504

*Stainless Steel = NPT to prevent galling

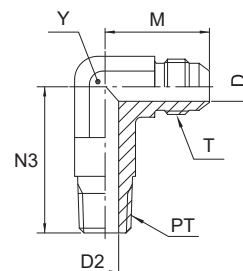

| Tube O.D. | | Thread NPT/NPTF PT | Thread UN/UNF-2A T | D mm | D2 mm | M mm | N3 mm | Y mm | Weight (steel) g/1 piece | Triple-Lok® Steel | Triple-Lok® Stainless Steel | PN (bar) | |
|------------|-------|--------------------|--------------------|------|-------|------|-------|------|--------------------------|-------------------|-----------------------------|----------|-----|
| mm | in. | | | | | | | | | | | S | SS |
| 6 | 1/4 | 1/8-27 | 7/16-20 | 4.4 | 4.8 | 23 | 30 | 11.0 | 28 | 4 CCTX-S | 4 CCTX-SS | 420 | 350 |
| 6 | 1/4 | 1/4-18 | 7/16-20 | 4.4 | 7.0 | 27 | 40 | 14.0 | 28 | 4-4 CCTX-S | 4-4 CCTX-SS | 420 | 350 |
| 8 | 5/16 | 1/8-27 | 1/2-20 | 6.0 | 4.8 | 24 | 30 | 14.0 | 35 | 5 CCTX-S | 5 CCTX-SS | 420 | 350 |
| 10 | 3/8 | 1/4-18 | 9/16-18 | 7.5 | 7.2 | 27 | 40 | 14.0 | 58 | 6 CCTX-S | 6 CCTX-SS | 420 | 350 |
| 10 | 3/8 | 3/8-18 | 9/16-18 | 7.5 | 10.3 | 29 | 46 | 19.0 | 58 | 6-6 CCTX-S | 6-6 CCTX-SS | 420 | 350 |
| 12 | 1/2 | 3/8-18 | 3/4-16 | 9.9 | 10.3 | 32 | 46 | 19.0 | 111 | 8 CCTX-S | 8 CCTX-SS | 420 | 350 |
| 12 | 1/2 | 1/2-14 | 3/4-16 | 9.9 | 13.5 | 34 | 55 | 22.0 | 136 | 8-8 CCTX-S | 8-8 CCTX-SS | 420 | 350 |
| 14, 15, 16 | 5/8 | 1/2-14 | 7/8-14 | 12.3 | 13.5 | 37 | 55 | 22.0 | 183 | 10 CCTX-S | 10 CCTX-SS | 350 | 350 |
| 18, 20 | 3/4 | 3/4-14 | 1 1/16-12 | 15.5 | 18.3 | 42 | 62 | 26.5 | 253 | 12 CCTX-S | 12 CCTX-SS | 280 | 280 |
| 25 | 1 | 1-11.5 | 1 5/16-12 | 21.4 | 23.8 | 46 | 76 | 33.0 | 435 | 16 CCTX-S | 16 CCTX-SS | 210 | 210 |
| 28, 30, 32 | 1 1/4 | 1 1/4-11.5 | 1 5/8-12 | 27.4 | 31.8 | 52 | 94 | 41.0 | 1021 | 20 CCTX-S | 20 CCTX-SS | 170 | 170 |

Order codes shown are part of our current manufacturing programme.

Imperial and metric parts may vary in hexagon dimensions.

$$\frac{\text{PN (bar)}}{10} = \text{PN (MPa)}$$

Do not create drawings from these dimensions, they are subject to change and ISO manufacturing allowances.



Triple-Lok®
CCCTX Extended male stud elbow

Triple-Lok® 37° Flare end / Male NPTF* thread (SAE 476)

SAE 071602

*Stainless Steel = NPT to prevent galling

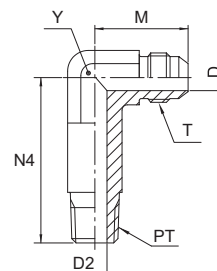

| Tube O.D. | | Thread NPT/NPTF PT | Thread UN/UNF-2A T | D mm | D2 mm | M mm | N4 mm | Y mm | Weight (steel) g/1 piece | Triple-Lok® Steel | PN (bar) |
|------------|-------|--------------------|--------------------|------|-------|------|-------|------|--------------------------|--------------------|----------|
| mm | in. | | | | | | | | | | |
| 6 | 1/4 | 1/8-27 | 7/16-20 | 4.4 | 4.8 | 23 | 40 | 11 | 32 | 4 CCCTX-S | 420 |
| 6 | 1/4 | 1/4-18 | 7/16-20 | 4.4 | 7.0 | 27 | 53 | 14 | 32 | 4-4 CCCTX-S | 420 |
| 8 | 5/16 | 1/8-27 | 1/2-20 | 6.0 | 4.8 | 25 | 41 | 14 | 39 | 5 CCCTX-S | 420 |
| 10 | 3/8 | 1/4-18 | 9/16-18 | 7.5 | 7.2 | 27 | 53 | 14 | 72 | 6 CCCTX-S | 420 |
| 10 | 3/8 | 3/8-18 | 9/16-18 | 7.5 | 10.3 | 29 | 59 | 19 | 72 | 6-6 CCCTX-S | 420 |
| 12 | 1/2 | 3/8-18 | 3/4-16 | 10.3 | 9.9 | 32 | 59 | 19 | 130 | 8 CCCTX-S | 420 |
| 12 | 1/2 | 1/2-14 | 3/4-16 | 9.9 | 13.5 | 34 | 73 | 22 | 163 | 8-8 CCCTX-S | 420 |
| 14, 15, 16 | 5/8 | 1/2-14 | 7/8-14 | 12.3 | 13.5 | 37 | 73 | 22 | 212 | 10 CCCTX-S | 350 |
| 18, 20 | 3/4 | 3/4-14 | 1 1/16-12 | 15.5 | 18.3 | 42 | 83 | 27 | 356 | 12 CCCTX-S | 280 |
| 25 | 1 | 1-11.5 | 1 5/16-12 | 21.4 | 23.8 | 46 | 102 | 33 | 520 | 16 CCCTX-S | 210 |
| 28, 30, 32 | 1 1/4 | 1 1/4-11.5 | 1 5/8-12 | 27.4 | 31.8 | 52 | 127 | 41 | 1196 | 20 CCCTX-S | 170 |

Order codes shown are part of our current manufacturing programme.

Imperial and metric parts may vary in hexagon dimensions.

$$\frac{\text{PN (bar)}}{10} = \text{PN (MPa)}$$

Do not create drawings from these dimensions, they are subject to change and ISO manufacturing allowances.

C3MX Male stud elbow

Triple-Lok® 37° Flare end / Male BSPT thread (ISO 7)

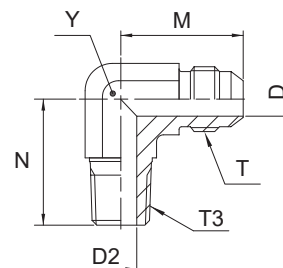

| Tube O.D. | | Thread BSPT T3 | Thread UN/UNF-2A T | D mm | D2 mm | M mm | N mm | Y mm | Weight (steel) g/1 piece | Triple-Lok® Steel | Triple-Lok® Stainless Steel | PN (bar) | |
|------------|-------|----------------|--------------------|------|-------|------|------|------|--------------------------|-------------------|-----------------------------|----------|-----|
| mm | in. | | | | | | | | | | | S | SS |
| 6 | 1/4 | 1/8-28 | 7/16-20 | 4.4 | 5.0 | 23 | 20 | 11 | 23 | 4C3MXS | 4C3MXSS | 315 | 315 |
| 6 | 1/4 | 1/4-19 | 7/16-20 | 4.4 | 7.0 | 27 | 28 | 14 | 42 | 4-4C3MXS | 4-4C3MXSS | 315 | 315 |
| 8 | 5/16 | 1/8-28 | 1/2-20 | 6.0 | 5.0 | 24 | 20 | 13 | 29 | 5C3MXS | 5C3MXSS | 315 | 315 |
| 8 | 5/16 | 1/4-19 | 1/2-20 | 6.0 | 7.0 | 27 | 28 | 14 | 42 | 5-4C3MXS | 5-4C3MXSS | 315 | 315 |
| 10 | 3/8 | 1/4-19 | 9/16-18 | 7.5 | 7.0 | 27 | 28 | 14 | 45 | 6C3MXS | 6C3MXSS | 315 | 315 |
| 10 | 3/8 | 3/8-19 | 9/16-18 | 7.5 | 10.0 | 29 | 31 | 19 | 76 | 6-6C3MXS | 6-6C3MXSS | 315 | 315 |
| 10 | 3/8 | 1/2-14 | 9/16-18 | 7.5 | 13.5 | 31 | 37 | 22 | 117 | 6-8C3MXS | 6-8C3MXSS | 315 | 315 |
| 12 | 1/2 | 3/8-19 | 3/4-16 | 9.9 | 10.0 | 32 | 31 | 19 | 86 | 8C3MXS | 8C3MXSS | 315 | 315 |
| 12 | 1/2 | 1/4-19 | 3/4-16 | 9.9 | 7.0 | 32 | 31 | 19 | 82 | 8-4C3MXS | 8-4C3MXSS | 315 | 315 |
| 12 | 1/2 | 1/2-14 | 3/4-16 | 9.9 | 13.5 | 34 | 37 | 22 | 125 | 8-8C3MXS | 8-8C3MXSS | 315 | 315 |
| 14, 15,16 | 5/8 | 1/2-14 | 7/8-14 | 12.3 | 13.5 | 37 | 37 | 22 | 129 | 10C3MXS | 10C3MXSS | 315 | 315 |
| 14, 15,16 | 5/8 | 3/8-19 | 7/8-14 | 12.3 | 10.3 | 37 | 33 | 22 | 127 | 10-6C3MXS | 10-6C3MXSS | 315 | 315 |
| 14, 15,16 | 5/8 | 3/4-14 | 7/8-14 | 12.3 | 18.0 | 39 | 40 | 27 | 192 | 10-12C3MXS | 10-12C3MXSS | 160 | 160 |
| 18, 20 | 3/4 | 3/4-14 | 1 1/16-12 | 15.5 | 18.0 | 42 | 40 | 27 | 198 | 12C3MXS | 12C3MXSS | 160 | 160 |
| 18, 20 | 3/4 | 1/2-14 | 1 1/16-12 | 15.5 | 13.5 | 42 | 40 | 27 | 204 | 12-8C3MXS | 12-8C3MXSS | 315 | 315 |
| 18, 20 | 3/4 | 1-11 | 1 1/16-12 | 15.5 | 24.0 | 45 | 50 | 33 | 251 | 12-16C3MXS | 12-16C3MXSS | 160 | 160 |
| 25 | 1 | 1-11 | 1 5/16-12 | 21.5 | 24.0 | 46 | 50 | 33 | 328 | 16C3MXS | 16C3MXSS | 160 | 160 |
| 25 | 1 | 3/4-14 | 1 5/16-12 | 21.5 | 18.0 | 46 | 45 | 33 | 318 | 16-12C3MXS | 16-12C3MXSS | 160 | 160 |
| 28, 30, 32 | 1 1/4 | 1 1/4-11 | 1 5/8-12 | 27.5 | 32.0 | 52 | 61 | 41 | 549 | 20C3MXS | 20C3MXSS | 160 | 160 |
| 28, 30, 32 | 1 1/4 | 1-11 | 1 5/8-12 | 27.5 | 24.0 | 52 | 60 | 41 | 536 | 20-16C3MXS | 20-16C3MXSS | 160 | 160 |
| 35, 38 | 1 1/2 | 1 1/2-11 | 1 7/8-12 | 33.0 | 38.0 | 59 | 67 | 48 | 747 | 24C3MXS | 24C3MXSS | 160 | 140 |

Order codes shown are part of our current manufacturing programme.

Imperial and metric parts may vary in hexagon dimensions.

$$\frac{\text{PN (bar)}}{10} = \text{PN (MPa)}$$

Do not create drawings from these dimensions, they are subject to change and ISO manufacturing allowances.

K

Triple-Lok®

V87OMX 45° Male stud elbow

Triple-Lok® 37° Flare end / Male metric thread O-ring (ISO 6149)

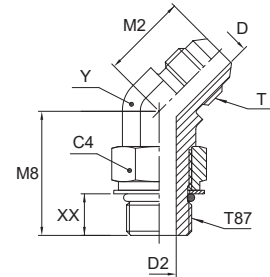

| Tube O.D. | | Thread Metric T87 | Thread UN/UNF-2A T | C4 mm | D mm | D2 mm | M2 mm | M8 mm | XX mm | Y mm | Weight (steel) g/1 piece | Triple-Lok® Steel | PN (bar) |
|-----------|------|-------------------|--------------------|-------|------|-------|-------|-------|-------|------|--------------------------|---------------------|----------|
| mm | in. | | | | | | | | | | | | |
| 6 | 1/4 | M 10×1.0 | 7/16-20 | 14 | 4.4 | 4.5 | 18 | 27 | 18 | 11 | 17 | 4M10V87OMXS | 420 |
| 6 | 1/4 | M 12×1.0 | 7/16-20 | 17 | 4.4 | 6.0 | 20 | 27 | 16 | 13 | 25 | 4M12V87OMXS | 420 |
| 8 | 5/16 | M 10×1.0 | 1/2-20 | 14 | 6.0 | 4.5 | 20 | 27 | 18 | 13 | 31 | 5M10V87OMXS | 420 |
| 8 | 5/16 | M 12×1.5 | 1/2-20 | 17 | 6.0 | 6.0 | 20 | 27 | 16 | 13 | 25 | 5M12V87OMXS | 420 |
| 10 | 3/8 | M 14×1.5 | 9/16-18 | 19 | 7.5 | 7.5 | 21 | 28 | 17 | 14 | 31 | 6M14V87OMXS | 420 |
| 10 | 3/8 | M 16×1.5 | 9/16-18 | 22 | 7.5 | 9.0 | 22 | 33 | 21 | 19 | 58 | 6M16V87OMXS | 350 |
| 10 | 3/8 | M 18×1.5 | 9/16-18 | 24 | 7.5 | 11.0 | 22 | 33 | 20 | 19 | 66 | 6M18V87OMXS | 350 |
| 12 | 1/2 | M 16×1.5 | 3/4-16 | 22 | 9.9 | 9.0 | 25 | 33 | 21 | 19 | 65 | 8M16V87OMXS | 350 |
| 12 | 1/2 | M 18×1.5 | 3/4-16 | 24 | 9.9 | 11.0 | 25 | 33 | 20 | 19 | 66 | 8M18V87OMXS | 350 |
| 14, 15,16 | 5/8 | M 18×1.5 | 7/8-14 | 24 | 12.3 | 11.0 | 28 | 37 | 24 | 22 | 99 | 10M18V87OMXS | 350 |
| 14, 15,16 | 5/8 | M 22×1.5 | 7/8-14 | 27 | 12.3 | 14.0 | 28 | 38 | 25 | 22 | 99 | 10M22V87OMXS | 350 |
| 18, 20 | 3/4 | M 22×1.5 | 1 1/16-12 | 27 | 15.5 | 14.0 | 33 | 40 | 27 | 27 | 164 | 12M22V87OMXS | 350 |
| 18, 20 | 3/4 | M 27×2.0 | 1 1/16-12 | 32 | 15.5 | 18.0 | 33 | 46 | 30 | 27 | 173 | 12M27V87OMXS | 350 |
| 25 | 1 | M 33×2.0 | 1 5/16-12 | 41 | 21.5 | 23.0 | 37 | 46 | 30 | 33 | 287 | 16M33V87OMXS | 280 |

Steel, stainless steel and brass Triple-Lok® parts are delivered with NBR elastomeric seals as standard. For more details on other seal materials see page K92.

Order codes shown are part of our current manufacturing programme.

Imperial and metric parts may vary in hexagon dimensions.

$$\frac{\text{PN (bar)}}{10} = \text{PN (MPa)}$$

Do not create drawings from these dimensions, they are subject to change and ISO manufacturing allowances.

V5OMX 45° Male stud elbow

Triple-Lok® 37° Flare end / Male UNF thread O-ring (ISO 11926)
SAE 070320 MS51528

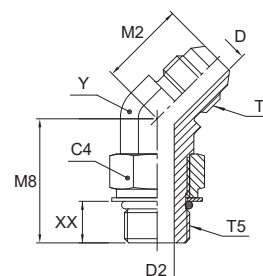

| Tube O.D. | | Thread UN/UNF-2A T5 | Thread UN/UNF-2A T | C4 mm | D mm | D2 mm | M2 mm | M8 mm | XX mm | Y mm | Weight (steel) g/1 piece | Triple-Lok® Steel | Triple-Lok® Stainless Steel | PN (bar) | |
|------------|-------|---------------------|--------------------|-------|------|-------|-------|-------|-------|------|--------------------------|---------------------|-----------------------------|----------|-----|
| mm | in. | | | | | | | | | | | | | S | SS |
| 6 | 1/4 | 7/16-20 | 7/16-20 | 14.3 | 4.4 | 4.4 | 18 | 27 | 16 | 11.0 | 34 | 4 V5OX-S | 4 V5OX-SS | 420 | 350 |
| 8 | 5/16 | 1/2-20 | 1/2-20 | 16.0 | 6.0 | 6.0 | 20 | 27 | 16 | 14.0 | 42 | 5 V5OX-S | 5 V5OX-SS | 420 | 350 |
| 10 | 3/8 | 9/16-18 | 9/16-18 | 17.0 | 7.5 | 7.5 | 21 | 29 | 17 | 14.0 | 52 | 6V5OMXS | 6 V5OX-SS | 420 | 350 |
| 10 | 3/8 | 3/4-16 | 9/16-18 | 22.2 | 7.5 | 9.9 | 22 | 23 | 19 | 19.0 | 104 | 6-8 V5OX-S | 6-8 V5OX-SS | 420 | 350 |
| 12 | 1/2 | 3/4-16 | 3/4-16 | 22.2 | 9.9 | 9.9 | 25 | 33 | 19 | 19.0 | 104 | 8 V5OX-S | 8 V5OX-SS | 420 | 350 |
| 12 | 1/2 | 9/16-18 | 3/4-16 | 17.5 | 9.9 | 7.5 | 25 | 28 | 16 | 19.0 | 98 | 8-6 V5OX-S | 8-6 V5OX-SS | 420 | 350 |
| 12 | 1/2 | 7/8-14 | 3/4-16 | 25.4 | 9.9 | 12.3 | 25 | 39 | 23 | 22.0 | 148 | 8-10 V5OX-S | 8-10 V5OX-SS | 350 | 350 |
| 14, 15, 16 | 5/8 | 7/8-14 | 7/8-14 | 25.4 | 12.3 | 12.3 | 28 | 39 | 23 | 22.0 | 157 | 10 V5OX-S | 10 V5OX-SS | 350 | 350 |
| 14, 15, 16 | 5/8 | 3/4-16 | 7/8-14 | 22.2 | 12.3 | 9.9 | 28 | 35 | 21 | 22.0 | 157 | 10-8 V5OX-S | 10-8 V5OX-SS | 350 | 350 |
| 18, 20 | 3/4 | 1 1/16-12 | 1 1/16-12 | 31.8 | 15.5 | 15.5 | 33 | 44 | 26 | 27.0 | 258 | 12 V5OX-S | 12 V5OX-SS | 350 | 350 |
| 18, 20 | 3/4 | 7/8-14 | 1 1/16-12 | 25.4 | 15.5 | 12.5 | 33 | 40 | 25 | 27.0 | 227 | 12-10 V5OX-S | 12-10 V5OX-SS | 350 | 350 |
| 22 | 7/8 | 1 3/16-12 | 1 3/16-12 | 35.0 | 18.3 | 18.3 | 37 | 47 | 30 | 33.3 | 275 | 14 V5OX-S | | 280 | — |
| 25 | 1 | 1 5/16-12 | 1 5/16-12 | 38.0 | 21.4 | 21.4 | 37 | 47 | 30 | 33.3 | 375 | 16 V5OX-S | 16 V5OX-SS | 280 | 280 |
| 25 | 1 | 1 1/16-12 | 1 5/16-12 | 31.8 | 21.4 | 15.5 | 37 | 47 | 31 | 33.3 | 277 | 16-12 V5OX-S | | 280 | 280 |
| 28, 30, 32 | 1 1/4 | 1 5/8-12 | 1 5/8-12 | 47.6 | 27.4 | 27.4 | 40 | 49 | 31 | 41.0 | 570 | 20 V5OX-S | 20 V5OX-SS | 280 | 210 |
| 35, 38 | 1 1/2 | 1 7/8-12 | 1 7/8-12 | 54.0 | 33.3 | 33.3 | 45 | 49 | 31 | 47.6 | 706 | 24 V5OX-S | 24 V5OX-SS | 210 | 140 |

K

Steel, stainless steel and brass Triple-Lok® parts are delivered with NBR elastomeric seals as standard. For more details on other seal materials see page K92.

Order codes shown are part of our current manufacturing programme.

Imperial and metric parts may vary in hexagon dimensions.

$$\frac{\text{PN (bar)}}{10} = \text{PN (MPa)}$$

Do not create drawings from these dimensions, they are subject to change and ISO manufacturing allowances.

Triple-Lok®

V4OMX 45° Male stud elbow

Triple-Lok® 37° Flare end / Male BSPP thread O-ring + retaining ring (ISO 1179)

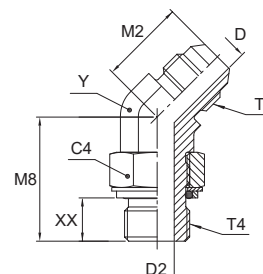

| Tube O.D. | | Thread BSPP T4 | Thread UN/UNF-2A T | C4 mm | D mm | D2 mm | M2 mm | M8 mm | XX mm | Y mm | Weight (steel) g/1 piece | Triple-Lok® Steel | PN (bar) |
|------------|-------|----------------|--------------------|-------|------|-------|-------|-------|-------|------|--------------------------|--------------------|----------|
| mm | in. | | | | | | | | | | | | |
| 6 | 1/4 | 1/8-28 | 7/16-20 | 14 | 4.4 | 4.4 | 18 | 27 | 18 | 11 | 35 | 4V4OMXS | 250 |
| 6 | 1/4 | 1/4-19 | 7/16-20 | 19 | 4.4 | 7.5 | 21 | 29 | 18 | 14 | 48 | 4-4V4OMXS | 250 |
| 8 | 5/16 | 1/8-28 | 1/2-20 | 14 | 6.0 | 4.4 | 20 | 27 | 18 | 13 | 44 | 5V4OMXS | 250 |
| 8 | 5/16 | 1/4-19 | 1/2-20 | 19 | 6.0 | 7.5 | 21 | 27 | 15 | 14 | 51 | 5-4V4OMXS | 250 |
| 10 | 3/8 | 1/4-19 | 9/16-18 | 19 | 7.5 | 7.5 | 21 | 29 | 18 | 14 | 55 | 6V4OMXS | 250 |
| 10 | 3/8 | 3/8-19 | 9/16-18 | 22 | 7.5 | 9.9 | 22 | 33 | 22 | 19 | 70 | 6-6V4OMXS | 250 |
| 10 | 3/8 | 1/2-14 | 9/16-18 | 27 | 7.5 | 12.3 | 22 | 39 | 24 | 22 | 92 | 6-8V4OMXS | 250 |
| 12 | 1/2 | 3/8-19 | 3/4-16 | 22 | 9.9 | 9.9 | 25 | 33 | 22 | 19 | 104 | 8V4OMXS | 250 |
| 12 | 1/2 | 1/2-14 | 3/4-16 | 27 | 9.9 | 12.3 | 25 | 39 | 24 | 22 | 148 | 8-8V4OMXS | 250 |
| 14, 15, 16 | 5/8 | 1/2-14 | 7/8-14 | 27 | 12.3 | 12.3 | 28 | 39 | 24 | 22 | 165 | 10V4OMXS | 250 |
| 14, 15, 16 | 5/8 | 3/4-14 | 7/8-14 | 36 | 12.3 | 15.5 | 30 | 44 | 29 | 27 | 235 | 10-12V4OMXS | 250 |
| 18, 20 | 3/4 | 3/4-14 | 1 1/16-12 | 36 | 15.5 | 15.5 | 33 | 44 | 30 | 27 | 270 | 12V4OMXS | 250 |
| 25 | 1 | 1-11 | 1 5/16-12 | 41 | 21.5 | 21.5 | 37 | 47 | 31 | 33 | 394 | 16V4OMXS | 250 |
| 28, 30, 32 | 1 1/4 | 1 1/4-11 | 1 5/8-12 | 50 | 27.5 | 27.5 | 40 | 48 | 32 | 41 | 599 | 20V4OMXS | 210 |
| 35, 38 | 1 1/2 | 1 1/2-11 | 1 7/8-12 | 55 | 33.0 | 33.0 | 45 | 48 | 33 | 48 | 750 | 24V4OMXS | 140 |

Steel, stainless steel and brass Triple-Lok® parts are delivered with NBR elastomeric seals as standard. For more details on other seal materials see page K92.

Order codes shown are part of our current manufacturing programme.

Imperial and metric parts may vary in hexagon dimensions.

$$\frac{\text{PN (bar)}}{10} = \text{PN (MPa)}$$

Do not create drawings from these dimensions, they are subject to change and ISO manufacturing allowances.

V8OMX 45° Male stud elbow

Triple-Lok® 37° Flare end / Male metric thread – O-ring + retaining ring

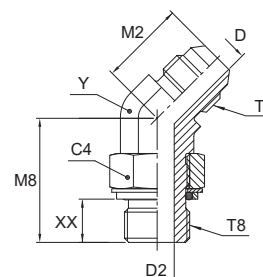

| Tube O.D. | | Thread Metric T8 | Thread UN/UNF-2A T | C4 mm | D mm | D2 mm | M2 mm | M8 mm | XX mm | Y mm | Weight (steel) g/1 piece | Triple-Lok® Steel | PN (bar) |
|------------|------|------------------|--------------------|-------|------|-------|-------|-------|-------|------|--------------------------|--------------------|----------|
| mm | in. | | | | | | | | | | | | |
| 6 | 1/4 | M 10×1.0 | 7/16-20 | 14 | 4.4 | 4.5 | 18 | 27 | 20 | 11 | 23 | 4M10V8OMXS | 250 |
| 6 | 1/4 | M 12×1.5 | 7/16-20 | 17 | 4.4 | 6.0 | 20 | 27 | 18 | 13 | 25 | 4M12V8OMXS | 250 |
| 8 | 5/16 | M 12×1.5 | 1/2-20 | 17 | 6.0 | 6.0 | 20 | 28 | 18 | 13 | 28 | 5M12V8OMXS | 250 |
| 10 | 3/8 | M 14×1.5 | 9/16-18 | 17 | 7.5 | 7.5 | 21 | 28 | 19 | 14 | 36 | 6M14V8OMXS | 250 |
| 12 | 1/2 | M 16×1.5 | 3/4-16 | 19 | 9.9 | 9.0 | 25 | 33 | 23 | 19 | 68 | 8M16V8OMXS | 250 |
| 12 | 1/2 | M 18×1.5 | 3/4-16 | 22 | 9.9 | 11.0 | 25 | 33 | 22 | 19 | 78 | 8M18V8OMXS | 250 |
| 14, 15, 16 | 5/8 | M 22×1.5 | 7/8-14 | 27 | 12.3 | 14.0 | 28 | 38 | 27 | 22 | 119 | 10M22V8OMXS | 250 |
| 18, 20 | 3/4 | M 27×2.0 | 1 1/16-12 | 32 | 15.5 | 18.0 | 33 | 46 | 32 | 27 | 208 | 12M27V8OMXS | 175 |
| 25 | 1 | M 33×2.0 | 1 5/16-12 | 38 | 21.5 | 23.0 | 37 | 46 | 32 | 33 | 333 | 16M33V8OMXS | 140 |

Steel, stainless steel and brass Triple-Lok® parts are delivered with NBR elastomeric seals as standard. For more details on other seal materials see page K92.

Order codes shown are part of our current manufacturing programme.

Imperial and metric parts may vary in hexagon dimensions.

$$\frac{\text{PN (bar)}}{10} = \text{PN (MPa)}$$

Do not create drawings from these dimensions, they are subject to change and ISO manufacturing allowances.



Triple-Lok®

VMTX 45° Male stud elbow

Triple-Lok® 37° Flare end / Male NPTF* thread (SAE 476)

SAE 070302 MS51508

*Stainless Steel = NPT to prevent galling

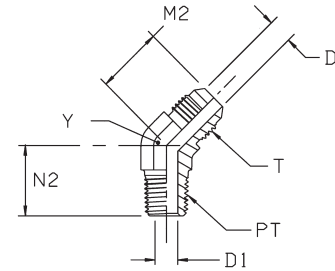

| Tube O.D. | | Thread NPT/NPTF PT | Thread UN/UNF-2A T | D mm | D1 mm | M2 mm | N2 mm | Y mm | Weight (steel) g/1 piece | Triple-Lok® Steel | Triple-Lok® Stainless Steel | Triple-Lok® Brass | PN (bar) | |
|------------|-------|--------------------|--------------------|------|-------|-------|-------|------|--------------------------|-------------------|-----------------------------|-------------------|----------|-----|
| mm | in. | | | | | | | | | | | | S | SS |
| 6 | 1/4 | 1/8-27 | 7/16-20 | 4.4 | 4.8 | 18 | 16 | 11.0 | 18 | 4 VTX-S | 4 VTX-SS | 4 VTX-B | 420 | 350 |
| 6 | 1/4 | 1/4-18 | 7/16-20 | 4.4 | 7.0 | 21 | 22 | 14.0 | 30 | 4-4 VTX-S | 4-4 VTX-SS | 4-4 VTX-B | 420 | 350 |
| 6 | 1/4 | 3/8-18 | 9/16-18 | 4.4 | 10.3 | 22 | 24 | 19.0 | 54 | 4-6 VTX-S | | | 420 | 350 |
| 8 | 5/16 | 1/8-27 | 1/2-20 | 6.0 | 4.8 | 20 | 16 | 14.0 | 22 | 5 VTX-S | 5 VTX-SS | 5 VTX-B | 420 | 350 |
| 8 | 5/16 | 1/4-18 | 1/2-20 | 6.0 | 7.0 | 21 | 22 | 14.0 | 31 | 5-4 VTX-S | 5-4 VTX-SS | 5-4 VTX-B | 420 | 350 |
| 10 | 3/8 | 1/4-18 | 9/16-18 | 7.5 | 7.0 | 21 | 22 | 14.0 | 27 | 6 VTX-S | 6 VTX-SS | 6 VTX-B | 420 | 350 |
| 10 | 3/8 | 1/8-27 | 9/16-18 | 7.5 | 4.7 | 21 | 17 | 14.0 | 23 | 6-2 VTX-S | 6-2 VTX-SS | 6-2 VTX-B | 420 | 350 |
| 10 | 3/8 | 3/8-18 | 9/16-18 | 7.5 | 10.3 | 22 | 24 | 19.0 | 52 | 6-6 VTX-S | 6-6 VTX-SS | 6-6 VTX-B | 420 | 350 |
| 10 | 3/8 | 1/2-14 | 9/16-18 | 7.5 | 13.5 | 22 | 30 | 22.0 | 74 | 6-8 VTX-S | 6-8 VTX-SS | 6-8 VTX-B | 420 | 350 |
| 12 | 1/2 | 1/4-18 | 3/4-16 | 9.9 | 7.0 | 25 | 24 | 19.0 | 62 | 8-4 VTX-S | 8-4 VTX-SS | 8-4 VTX-B | 420 | 350 |
| 12 | 1/2 | 3/8-18 | 3/4-16 | 9.9 | 10.3 | 25 | 24 | 19.0 | 61 | 8 VTX-S | 8 VTX-SS | 8 VTX-B | 420 | 350 |
| 12 | 1/2 | 1/2-14 | 3/4-16 | 9.9 | 13.5 | 25 | 30 | 22.0 | 92 | 8-8 VTX-S | 8-8 VTX-SS | 8-8 VTX-B | 420 | 350 |
| 12 | 1/2 | 3/4-14 | 3/4-16 | 9.9 | 18.2 | 26 | 31 | 27.0 | 144 | 8-12 VTX-S | 8-12 VTX-SS | 8-12 VTX-B | 280 | 280 |
| 14, 15, 16 | 5/8 | 1/2-14 | 7/8-14 | 12.3 | 13.5 | 28 | 30 | 22.0 | 92 | 10 VTX-S | 10 VTX-SS | 10 VTX-B | 350 | 350 |
| 14, 15, 16 | 5/8 | 3/8-18 | 7/8-14 | 12.3 | 10.3 | 28 | 25 | 22.0 | 94 | 10-6 VTX-S | 10-6 VTX-SS | 10-6 VTX-B | 350 | 350 |
| 14, 15, 16 | 5/8 | 3/4-14 | 7/8-14 | 12.3 | 18.2 | 33 | 31 | 27.0 | 156 | 10-12 VTX-S | 10-12 VTX-SS | | 280 | 280 |
| 18, 20 | 3/4 | 3/4-14 | 1 1/16-12 | 15.5 | 18.2 | 33 | 31 | 27.0 | 148 | 12 VTX-S | 12 VTX-SS | 12 VTX-B | 280 | 280 |
| 18, 20 | 3/4 | 1/2-14 | 1 1/16-12 | 15.5 | 13.5 | 33 | 31 | 27.0 | 144 | 12-8 VTX-S | 12-8 VTX-SS | 12-8 VTX-B | 350 | 350 |
| 18, 20 | 3/4 | 1-11.5 | 1 1/16-12 | 15.5 | 23.8 | 36 | 38 | 33.3 | 169 | 12-16 VTX-S | 12-16 VTX-SS | 12-16 VTX-B | 210 | 210 |
| 25 | 1 | 1-11.5 | 1 5/16-12 | 21.4 | 23.8 | 37 | 38 | 33.3 | 239 | 16 VTX-S | 16 VTX-SS | 16 VTX-B | 210 | 210 |
| 25 | 1 | 3/4-14 | 1 5/16-12 | 21.4 | 18.2 | 37 | 33 | 33.3 | 213 | 16-12 VTX-S | 16-12 VTX-SS | 16-12 VTX-B | 280 | 280 |
| 28, 30, 32 | 1 1/4 | 1 1/4-11.5 | 1 5/8-12 | 27.4 | 31.8 | 40 | 42 | 41.0 | 385 | 20 VTX-S | 20 VTX-SS | 20 VTX-B | 170 | 170 |
| 35, 38 | 1 1/2 | 1 1/2-11.5 | 1 7/8-12 | 33.3 | 38.0 | 45 | 45 | 47.6 | 495 | 24 VTX-S | 24 VTX-SS | 24 VTX-B | 170 | 140 |
| | 2 | 2-11.5 | 2 1/2-12 | 45.0 | 49.0 | 56 | 54 | 63.5 | 1149 | 32 VTX-S | | | 170 | 140 |

Order codes shown are part of our current manufacturing programme.

Imperial and metric parts may vary in hexagon dimensions.

$$\frac{\text{PN (bar)}}{10} = \text{PN (MPa)}$$

Pressure ratings – PN shown, apply to Steel and Stainless Steel versions of the product.

For Brass parts reduce pressures by 35%.

Do not create drawings from these dimensions, they are subject to change and ISO manufacturing allowances.

V3MX 45° Male stud elbow

Triple-Lok® 37° Flare end / Male BSPT thread (ISO 7)

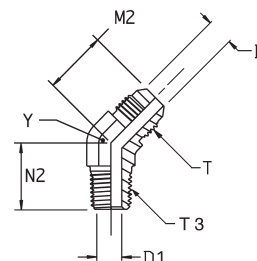

| Tube O.D. | | Thread BSPT T3 | Thread UN/UNF-2A T | D mm | D1 mm | M2 mm | N2 mm | Y mm | Weight (steel) g/1 piece | Triple-Lok® Steel | PN (bar) |
|------------|-------|----------------|--------------------|------|-------|-------|-------|------|--------------------------|-------------------|----------|
| mm | in. | | | | | | | | | | |
| 6 | 1/4 | 1/8-28 | 7/16-20 | 4.4 | 5.0 | 18 | 16 | 11 | 18 | 4V3MXS | 315 |
| 6 | 1/4 | 1/4-19 | 7/16-20 | 4.4 | 7.0 | 21 | 22 | 14 | 30 | 4-4V3MXS | 315 |
| 8 | 5/16 | 1/8-28 | 1/2-20 | 6.0 | 5.0 | 20 | 16 | 13 | 22 | 5V3MXS | 315 |
| 8 | 5/16 | 1/4-19 | 1/2-20 | 6.0 | 7.0 | 21 | 22 | 14 | 31 | 5-4V3MXS | 315 |
| 10 | 3/8 | 1/4-19 | 9/16-18 | 7.5 | 7.0 | 21 | 22 | 14 | 27 | 6V3MXS | 315 |
| 10 | 3/8 | 3/8-19 | 9/16-18 | 7.5 | 10.0 | 22 | 24 | 19 | 52 | 6-6V3MXS | 315 |
| 10 | 3/8 | 1/2-14 | 9/16-18 | 7.5 | 13.5 | 22 | 30 | 22 | 74 | 6-8V3MXS | 315 |
| 12 | 1/2 | 3/8-19 | 3/4-16 | 9.9 | 10.0 | 25 | 24 | 19 | 61 | 8V3MXS | 315 |
| 12 | 1/2 | 1/2-14 | 3/4-16 | 9.9 | 13.5 | 25 | 30 | 22 | 92 | 8-8V3MXS | 315 |
| 14, 15, 16 | 5/8 | 1/2-14 | 7/8-14 | 12.3 | 13.5 | 28 | 30 | 22 | 92 | 10V3MXS | 315 |
| 18, 20 | 3/4 | 3/4-14 | 7/8-14 | 15.5 | 18.0 | 33 | 31 | 27 | 148 | 12V3MXS | 160 |
| 25 | 1 | 1-11 | 1 5/16-12 | 21.5 | 24.0 | 37 | 38 | 33 | 239 | 16V3MXS | 160 |
| 28, 30, 32 | 1 1/4 | 1 1/4-11 | 1 5/8-12 | 27.5 | 32.0 | 40 | 42 | 41 | 385 | 20V3MXS | 160 |
| 35, 38 | 1 1/2 | 1 1/2-11 | 1 7/8-12 | 33.0 | 38.0 | 45 | 45 | 48 | 495 | 24V3MXS | 160 |

Order codes shown are part of our current manufacturing programme.

Imperial and metric parts may vary in hexagon dimensions.

PN (bar) = PN (MPa)
10

Do not create drawings from these dimensions, they are subject to change and ISO manufacturing allowances.



Triple-Lok®

S870MX Male stud branch tee

Triple-Lok® 37° Flare ends / Male metric thread O-ring (ISO 6149)

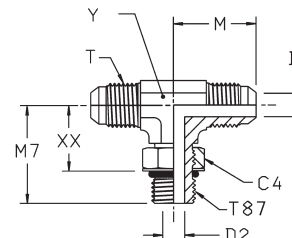

| Tube O.D. | | Thread Metric T87 | Thread UN/UNF-2A T | C4 mm | D mm | D2 mm | M mm | M7 mm | XX mm | Y mm | Weight (steel) g/1 piece | Triple-Lok® Steel | PN (bar) |
|------------|------|-------------------|--------------------|-------|------|-------|------|-------|-------|------|--------------------------|---------------------|----------|
| mm | in. | | | | | | | | | | | | |
| 6 | 1/4 | M 10×1.0 | 7/16-20 | 14 | 4.4 | 4.5 | 23 | 27 | 18 | 11 | 27 | 4M10S870MXS | 420 |
| 8 | 5/16 | M 12×1.5 | 1/2-20 | 17 | 6.0 | 6.0 | 24 | 31 | 19 | 13 | 42 | 5M12S870MXS | 420 |
| 10 | 3/8 | M 14×1.5 | 9/16-18 | 19 | 7.5 | 7.5 | 27 | 34 | 22 | 14 | 53 | 6M14S870MXS | 420 |
| 12 | 1/2 | M 16×1.5 | 3/4-16 | 22 | 9.9 | 9.0 | 32 | 38 | 26 | 19 | 113 | 8M16S870MXS | 350 |
| 12 | 1/2 | M 18×1.5 | 3/4-16 | 24 | 9.9 | 11.0 | 32 | 38 | 26 | 19 | 114 | 8M18S870MXS | 350 |
| 14, 15, 16 | 5/8 | M 18×1.5 | 7/8-14 | 24 | 12.3 | 11.0 | 37 | 42 | 29 | 22 | 174 | 10M18S870MXS | 350 |
| 14, 15, 16 | 5/8 | M 22×1.5 | 7/8-14 | 27 | 12.3 | 14.0 | 37 | 43 | 29 | 22 | 175 | 10M22S870MXS | 350 |
| 18, 20 | 3/4 | M 22×1.5 | 1 1/16-12 | 27 | 15.5 | 14.0 | 42 | 45 | 32 | 27 | 295 | 12M22S870MXS | 350 |
| 18, 20 | 3/4 | M 27×2.0 | 1 1/16-12 | 32 | 15.5 | 18.0 | 42 | 51 | 35 | 27 | 304 | 12M27S870MXS | 350 |
| 25 | 1 | M 33×2.0 | 1 5/16-12 | 41 | 21.5 | 23.0 | 46 | 53 | 38 | 33 | 530 | 16M33S870MXS | 280 |

Steel, stainless steel and brass Triple-Lok® parts are delivered with NBR elastomeric seals as standard. For more details on other seal materials see page K92.

Order codes shown are part of our current manufacturing programme.

Imperial and metric parts may vary in hexagon dimensions.

$\frac{\text{PN (bar)}}{10} = \text{PN (MPa)}$

Do not create drawings from these dimensions, they are subject to change and ISO manufacturing allowances.

S50MX Male stud branch tee

Triple-Lok® 37° Flare ends / Male UNF thread O-ring (ISO 11926)
SAE 070429 MS51529

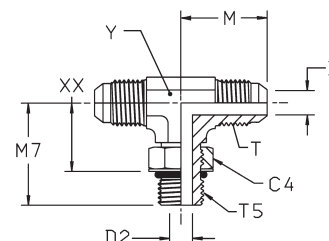

| Tube O.D. | | Thread UN/UNF-2A T5 | Thread UN/UNF-2A T | C4 mm | D mm | D2 mm | M mm | M7 mm | XX mm | Y mm | Weight (steel) g/1 piece | Triple-Lok® Steel | Triple-Lok® Stainless Steel | PN (bar) | |
|------------|-------|---------------------|--------------------|-------|------|-------|------|-------|-------|------|--------------------------|-------------------|-----------------------------|----------|-----|
| mm | in. | | | | | | | | | | | | | S | SS |
| 6 | 1/4 | 7/16-20 | 7/16-20 | 14.3 | 4.4 | 4.4 | 23 | 26 | 15 | 11.0 | 46 | 4 S50X-S | 4 S50X-SS | 420 | 350 |
| 8 | 5/16 | 1/2-20 | 1/2-20 | 16.0 | 5.8 | 5.8 | 24 | 29 | 18 | 14.0 | 66 | 5 S50X-S | 5 S50X-SS | 420 | 350 |
| 10 | 3/8 | 9/16-18 | 9/16-18 | 17.5 | 7.5 | 7.5 | 27 | 32 | 20 | 14.0 | 76 | 6 S50X-S | 6 S50X-SS | 420 | 350 |
| 12 | 1/2 | 3/4-16 | 3/4-16 | 22.0 | 9.9 | 10.0 | 32 | 37 | 23 | 19.0 | 150 | 8S50MXS | 8 S50X-SS | 420 | 350 |
| 14, 15, 16 | 5/8 | 7/8-14 | 7/8-14 | 27.0 | 12.3 | 12.5 | 37 | 43 | 28 | 22.0 | 224 | 10S50MXS | 10 S50X-SS | 350 | 350 |
| 18, 20 | 3/4 | 1 1/16-12 | 1 1/16-12 | 31.8 | 15.5 | 15.5 | 42 | 49 | 31 | 27.0 | 367 | 12 S50X-S | 12 S50X-SS | 350 | 350 |
| 25 | 1 | 1 5/16-12 | 1 5/16-12 | 38.0 | 21.4 | 21.4 | 46 | 52 | 34 | 33.3 | 506 | 16 S50X-S | 16 S50X-SS | 280 | 280 |
| 28, 30, 32 | 1 1/4 | 1 5/8-12 | 1 5/8-12 | 47.6 | 27.4 | 27.4 | 52 | 57 | 40 | 41.0 | 1053 | 20 S50X-S | 20 S50X-SS | 280 | 280 |
| 35, 38 | 1 1/2 | 1 7/8-12 | 1 7/8-12 | 54.0 | 33.3 | 33.3 | 59 | 61 | 43 | 47.6 | 1296 | 24 S50X-S | | 210 | — |
| | 2 | 2 1/2-12 | 2 1/2-12 | 69.8 | 45.2 | 45.2 | 78 | 73 | 56 | 63.5 | 2000 | 32 S50X-S | | 140 | — |

Steel, stainless steel and brass Triple-Lok® parts are delivered with NBR elastomeric seals as standard. For more details on other seal materials see page K92.

Order codes shown are part of our current manufacturing programme.

Imperial and metric parts may vary in hexagon dimensions.

$$\frac{\text{PN (bar)}}{10} = \text{PN (MPa)}$$

Do not create drawings from these dimensions, they are subject to change and ISO manufacturing allowances.



Triple-Lok®

S40MX Male stud branch tee

Triple-Lok® 37° Flare end / Adjustable BSPP thread O-ring + retaining ring (ISO 1179)

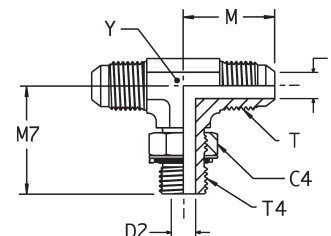

| Tube O.D. | | Thread BSPP T4 | Thread UN/UNF-2A T | C4 mm | D mm | D2 mm | M mm | M7 mm | XX mm | Y mm | Weight (steel) g/1 piece | Triple-Lok® Steel | Triple-Lok® Stainless Steel | PN (bar) | |
|------------|-------|----------------|--------------------|-------|------|-------|------|-------|-------|------|--------------------------|--------------------|-----------------------------|----------|-----|
| mm | in. | | | | | | | | | | | | | S | SS |
| 6 | 1/4 | 1/8-28 | 7/16-20 | 14 | 4.4 | 4.4 | 23 | 27 | 17 | 11 | 47 | 4S40MXS | 4S40MXSS | 250 | 250 |
| 10 | 3/8 | 1/4-19 | 9/16-18 | 19 | 7.5 | 7.5 | 27 | 32 | 19 | 14 | 78 | 6S40MXS | 6S40MXSS | 250 | 200 |
| 12 | 1/2 | 3/8-19 | 3/4-16 | 22 | 9.9 | 10.0 | 32 | 37 | 24 | 19 | 154 | 8S40MXS | 8S40MXSS | 250 | 200 |
| 12 | 1/2 | 1/2-14 | 3/4-16 | 27 | 9.9 | 12.3 | 34 | 44 | 28 | 22 | 186 | 8-8-8S40MXS | 8-8-8S40MXSS | 250 | 200 |
| 14, 15, 16 | 5/8 | 1/2-14 | 7/8-14 | 27 | 12.3 | 12.3 | 37 | 43 | 27 | 22 | 231 | 10S40MXS | 10S40MXSS | 250 | 200 |
| 18, 20 | 3/4 | 3/4-14 | 1 1/16-12 | 36 | 15.5 | 15.5 | 42 | 50 | 34 | 27 | 379 | 12S40MXS | 12S40MXSS | 250 | 200 |
| 25 | 1 | 1-11 | 1 5/16-12 | 41 | 21.5 | 21.5 | 46 | 52 | 35 | 33 | 569 | 16S40MXS | 16S40MXSS | 250 | 200 |
| 28, 30, 32 | 1 1/4 | 1 1/4-11 | 1 5/8-12 | 50 | 27.5 | 27.5 | 52 | 57 | 39 | 41 | 1075 | 20S40MXS | 20S40MXSS | 210 | 160 |

Steel, stainless steel and brass Triple-Lok® parts are delivered with NBR elastomeric seals as standard. For more details on other seal materials see page K92.

Order codes shown are part of our current manufacturing programme.

Imperial and metric parts may vary in hexagon dimensions.

$$\frac{\text{PN (bar)}}{10} = \text{PN (MPa)}$$

Do not create drawings from these dimensions, they are subject to change and ISO manufacturing allowances.

S80MX Male stud branch tee

Triple-Lok® 37° Flare ends / Male metric thread – O-ring + retaining ring

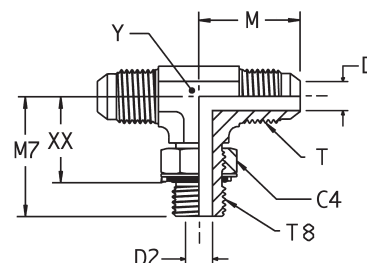

| Tube O.D. | | Thread Metric T8 | Thread UN/UNF-2A T | C4 mm | D mm | D2 mm | M mm | M7 mm | XX mm | Y mm | Weight (steel) g/1 piece | Triple-Lok® Steel | PN (bar) |
|------------|------|------------------|--------------------|-------|------|-------|------|-------|-------|------|--------------------------|--------------------|----------|
| mm | in. | | | | | | | | | | | | |
| 6 | 1/4 | M 10×1.0 | 7/16-20 | 14 | 4.4 | 4.5 | 23 | 27 | 18 | 11 | 27 | 4M10S80MXS | 250 |
| 8 | 5/16 | M 12×1.5 | 1/2-20 | 17 | 6.0 | 6.0 | 24 | 31 | 19 | 13 | 42 | 5M12S80MXS | 250 |
| 10 | 3/8 | M 14×1.5 | 9/16-18 | 17 | 7.5 | 7.5 | 27 | 34 | 22 | 14 | 53 | 6M14S80MXS | 250 |
| 12 | 1/2 | M 16×1.5 | 3/4-16 | 19 | 9.9 | 9.0 | 32 | 38 | 26 | 19 | 95 | 8M16S80MXS | 250 |
| 12 | 1/2 | M 18×1.5 | 3/4-16 | 22 | 9.9 | 11.0 | 32 | 38 | 26 | 19 | 114 | 8M18S80MXS | 250 |
| 14, 15, 16 | 5/8 | M 22×1.5 | 7/8-14 | 27 | 12.3 | 14.0 | 37 | 43 | 30 | 22 | 175 | 10M22S80MXS | 250 |
| 18, 20 | 3/4 | M 27×2.0 | 1 1/16-12 | 32 | 15.5 | 18.0 | 42 | 51 | 35 | 27 | 304 | 12M27S80MXS | 175 |
| 25 | 1 | M 33×2.0 | 1 5/16-12 | 38 | 21.5 | 23.0 | 46 | 53 | 37 | 33 | 491 | 16M33S80MXS | 140 |

Steel, stainless steel and brass Triple-Lok® parts are delivered with NBR elastomeric seals as standard. For more details on other seal materials see page K92.

Order codes shown are part of our current manufacturing programme.

Imperial and metric parts may vary in hexagon dimensions.

$$\frac{\text{PN (bar)}}{10} = \text{PN (MPa)}$$

Do not create drawings from these dimensions, they are subject to change and ISO manufacturing allowances.

K

Triple-Lok®

SMTX Male stud branch tee

Triple-Lok® 37° Flare ends / Male NPTF* thread (SAE 476)

SAE 070425 MS51512

*Stainless Steel = NPT to prevent galling

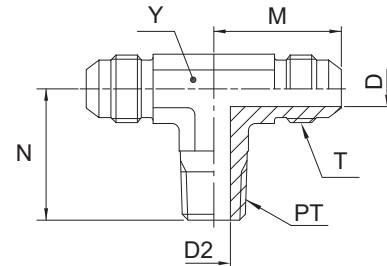

| Tube O.D. | | Thread NPT/NPTF PT | Thread UN/UNF-2A T | D mm | D2 mm | M mm | N mm | Y mm | Weight (steel) g/1 piece | Triple-Lok® Steel | Triple-Lok® Stainless Steel | Triple-Lok® Brass | PN (bar) | |
|------------|-------|--------------------|--------------------|------|-------|------|------|------|--------------------------|--------------------|-----------------------------|--------------------|----------|-----|
| mm | in. | | | | | | | | | | | | S | SS |
| 6 | 3/16 | 1/8-27 | 3/8-24 | 3.0 | 4.7 | 21 | 18 | 11.0 | 25 | 3 STX-S | 3 STX-SS | 3 STX-B | 420 | 350 |
| | 1/4 | 1/8-27 | 7/16-20 | 4.4 | 4.7 | 23 | 20 | 11.0 | 31 | 4 STX-S | 4 STX-SS | 4 STX-B | 420 | 350 |
| 6 | 1/4 | 1/4-18 | 7/16-20 | 4.4 | 7.0 | 27 | 28 | 14.0 | 49 | 4-4-4 STX-S | 4-4-4 STX-SS | 4-4-4 STX-B | 420 | 350 |
| 8 | 5/16 | 1/8-27 | 1/2-20 | 6.0 | 4.7 | 25 | 21 | 14.0 | 37 | 5 STX-S | 5 STX-SS | 5 STX-B | 420 | 350 |
| 10 | 3/8 | 1/4-18 | 9/16-18 | 7.5 | 7.0 | 27 | 28 | 14.0 | 57 | 6 STX-S | 6 STX-SS | 6 STX-B | 420 | 350 |
| 10 | 3/8 | 3/8-18 | 9/16-18 | 7.5 | 10.3 | 29 | 31 | 19.0 | 77 | 6-6-6 STX-S | 6-6-6 STX-SS | 6-6-6 STX-B | 420 | 350 |
| 12 | 1/2 | 3/8-18 | 3/4-16 | 9.9 | 10.3 | 32 | 31 | 19.0 | 113 | 8 STX-S | 8 STX-SS | 8 STX-B | 420 | 350 |
| 12 | 1/2 | 1/2-14 | 3/4-16 | 9.9 | 13.5 | 34 | 37 | 22.0 | 164 | 8-8-8 STX-S | 8-8-8 STX-SS | 8-8-8 STX-B | 420 | 350 |
| 14, 15, 16 | 5/8 | 1/2-14 | 7/8-14 | 12.3 | 13.5 | 37 | 37 | 22.0 | 173 | 10 STX-S | 10 STX-SS | 10 STX-B | 350 | 350 |
| 18, 20 | 3/4 | 3/4-14 | 1 1/16-12 | 18.0 | 18.3 | 42 | 40 | 27.0 | 272 | 12 STX-S | 12 STX-SS | 12 STX-B | 280 | 280 |
| 22 | 7/8 | 3/4-14 | 1 3/16-12 | 18.3 | 18.3 | 46 | 43 | 33.3 | 323 | 14 STX-S | | | 280 | — |
| 25 | 1 | 1-11.5 | 1 5/16-12 | 21.4 | 23.8 | 46 | 50 | 33.3 | 413 | 16 STX-S | 16 STX-SS | 16 STX-B | 210 | 210 |
| 28, 30, 32 | 1 1/4 | 1 1/4-11.5 | 1 5/8-12 | 27.4 | 31.8 | 52 | 60 | 41.0 | 681 | 20 STX-S | 20 STX-SS | 20 STX-B | 170 | 170 |
| | 2 | 1 1/2-11.5 | 1 7/8-12 | 33.3 | 38.0 | 59 | 67 | 47.6 | 905 | 24 STX-S | 24 STX-SS | 24 STX-B | 170 | 170 |

Order codes shown are part of our current manufacturing programme.

Imperial and metric parts may vary in hexagon dimensions.

$$\frac{\text{PN (bar)}}{10} = \text{PN (MPa)}$$

Pressure ratings – PN shown, apply to Steel and Stainless Steel versions of the product.

For Brass parts reduce pressures by 35 %.

Do not create drawings from these dimensions, they are subject to change and ISO manufacturing allowances.

S3MX Male stud branch tee

Triple-Lok® 37° Flare ends / Male BSPT thread (ISO 7)

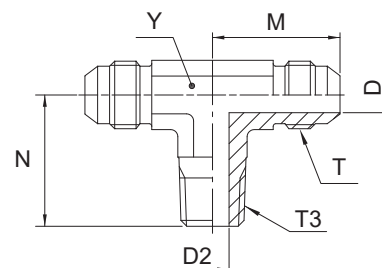

| Tube O.D. | | Thread BSPT T3 | Thread UN/UNF-2A T | D mm | D2 mm | M mm | N mm | Y mm | Weight (steel) g/1 piece | Triple-Lok® Steel | Triple-Lok® Stainless Steel | PN (bar) | |
|------------|-----|----------------|--------------------|------|-------|------|------|------|--------------------------|-------------------|-----------------------------|----------|-----|
| mm | in. | | | | | | | | | | | S | SS |
| 6 | 1/4 | 1/8-28 | 7/16-20 | 4.4 | 5.0 | 23 | 20 | 11 | 30 | 4S3MXS | 4S3MXSS | 315 | 315 |
| 10 | 3/8 | 1/4-19 | 7/16-20 | 7.5 | 7.0 | 27 | 28 | 14 | 55 | 6S3MXS | 6S3MXSS | 315 | 315 |
| 12 | 1/2 | 3/8-19 | 3/4-16 | 9.9 | 10.0 | 32 | 31 | 19 | 111 | 8S3MXS | 8S3MXSS | 315 | 315 |
| 14, 15, 16 | 5/8 | 1/2-14 | 7/8-14 | 12.3 | 13.5 | 37 | 37 | 22 | 169 | 10S3MXS | 10S3MXSS | 315 | 315 |
| 18, 20 | 3/4 | 3/4-14 | 1 1/16-12 | 15.5 | 18.0 | 42 | 40 | 27 | 267 | 12S3MXS | 12S3MXSS | 160 | 160 |
| 25 | 1 | 1-11 | 1 5/16-12 | 21.5 | 24.0 | 46 | 50 | 33 | 407 | 16S3MXS | 16S3MXSS | 160 | 160 |

Order codes shown are part of our current manufacturing programme.

Imperial and metric parts may vary in hexagon dimensions.

$$\frac{\text{PN (bar)}}{10} = \text{PN (MPa)}$$

Do not create drawings from these dimensions, they are subject to change and ISO manufacturing allowances.

K

Triple-Lok®

R87OMX Male stud run tee

Triple-Lok® 37° Flare ends / Male metric thread – O-ring (ISO 6149)

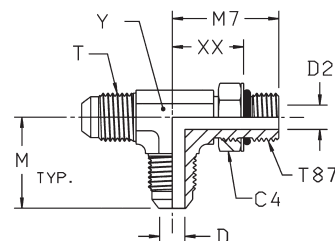

| Tube O.D. | | Thread Metric T87 | Thread UN/UNF-2A T | C4 mm | D mm | D2 mm | M mm | M7 mm | XX mm | Y mm | Weight (steel) g/1 piece | Triple-Lok® Steel | PN (bar) |
|------------|-----|-------------------|--------------------|-------|------|-------|------|-------|-------|------|--------------------------|---------------------|----------|
| mm | in. | | | | | | | | | | | | |
| 6 | 1/4 | M 10×1.0 | 7/16-20 | 14 | 4.4 | 4.5 | 23 | 27 | 18 | 11 | 27 | 4M10R87OMXS | 420 |
| 10 | 3/8 | M 14×1.5 | 9/16-18 | 19 | 7.5 | 7.5 | 27 | 34 | 22 | 14 | 53 | 6M14R87OMXS | 420 |
| 12 | 1/2 | M 16×1.5 | 3/4-16 | 22 | 9.9 | 9.0 | 32 | 38 | 26 | 19 | 113 | 8M16R87OMXS | 350 |
| 12 | 1/2 | M 18×1.5 | 3/4-16 | 24 | 9.9 | 11.0 | 32 | 38 | 26 | 19 | 114 | 8M18R87OMXS | 350 |
| 14, 15, 16 | 5/8 | M 18×1.5 | 7/8-14 | 24 | 12.3 | 11.0 | 37 | 42 | 29 | 22 | 174 | 10M18R87OMXS | 350 |
| 14, 15, 16 | 5/8 | M 22×1.5 | 7/8-14 | 27 | 12.3 | 14.0 | 37 | 43 | 29 | 22 | 175 | 10M22R87OMXS | 350 |
| 18, 20 | 3/4 | M 27×2.0 | 1 1/16-12 | 32 | 15.5 | 18.0 | 42 | 51 | 35 | 27 | 315 | 12M27R87OMXS | 350 |
| 25 | 1 | M 33×2.0 | 1 5/16-12 | 41 | 22.5 | 23.0 | 46 | 53 | 38 | 33 | 495 | 16M33R87OMXS | 280 |

Steel, stainless steel and brass Triple-Lok® parts are delivered with NBR elastomeric seals as standard. For more details on other seal materials see page K92.

Order codes shown are part of our current manufacturing programme.

Imperial and metric parts may vary in hexagon dimensions.

$$\frac{\text{PN (bar)}}{10} = \text{PN (MPa)}$$

Do not create drawings from these dimensions, they are subject to change and ISO manufacturing allowances.

R50MX Male stud run tee

Triple-Lok® 37° Flare ends / Male UNF thread O-ring (ISO 11926)
SAE 070428 MS51530

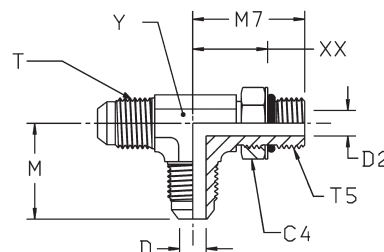

| Tube O.D. | | Thread UN/UNF-2A T5 | Thread UN/UNF-2A T | C4 mm | D mm | D2 mm | M mm | M7 mm | XX mm | Y mm | Weight (steel) g/1 piece | Triple-Lok® Steel | Triple-Lok® Stainless Steel | PN (bar) | |
|------------|-------|---------------------|--------------------|-------|------|-------|------|-------|-------|------|--------------------------|-------------------|-----------------------------|----------|-----|
| mm | in. | | | | | | | | | | | | | S | SS |
| 6 | 1/4 | 7/16-20 | 7/16-20 | 14.0 | 4.4 | 4.4 | 23 | 26 | 16 | 11.0 | 46 | 4 R50X-S | 4 R50X-SS | 420 | 350 |
| 8 | 5/16 | 1/2-20 | 1/2-20 | 16.0 | 6.0 | 6.0 | 24 | 29 | 18 | 14.0 | 66 | 5 R50X-S | 5 R50X-SS | 420 | 350 |
| 10 | 3/8 | 9/16-18 | 9/16-18 | 17.5 | 7.5 | 7.5 | 27 | 32 | 20 | 14.0 | 76 | 6 R50X-S | 6 R50X-SS | 420 | 350 |
| 12 | 1/2 | 3/4-16 | 3/4-16 | 22.2 | 9.9 | 10.0 | 32 | 37 | 23 | 19.0 | 151 | 8 R50X-S | 8 R50X-SS | 420 | 350 |
| 14, 15, 16 | 5/8 | 7/8-14 | 7/8-14 | 25.0 | 12.3 | 12.3 | 37 | 43 | 28 | 22.0 | 226 | 10 R50X-S | 10 R50X-SS | 350 | 350 |
| 18, 20 | 3/4 | 1 1/16-12 | 1 1/16-12 | 32.0 | 15.5 | 15.5 | 42 | 49 | 32 | 27.0 | 372 | 12 R50X-S | 12 R50X-SS | 350 | 350 |
| 25 | 1 | 1 5/16-12 | 1 5/16-12 | 38.0 | 21.4 | 21.4 | 46 | 52 | 35 | 33.3 | 557 | 16 R50X-S | 16 R50X-SS | 280 | 280 |
| 28, 30, 32 | 1 1/4 | 1 5/8-12 | 1 5/8-12 | 48.0 | 27.4 | 27.4 | 52 | 57 | 40 | 41.0 | 1053 | 20 R50X-S | 20 R50X-SS | 280 | 280 |
| 35, 38 | 1 1/2 | 1 7/8-12 | 1 7/8-12 | 54.0 | 33.3 | 33.3 | 59 | 61 | 43 | 47.6 | 1296 | 24 R50X-S | 24 R50X-SS | 210 | 210 |
| | 2 | 2 1/2-12 | 2 1/2-12 | 70.0 | 45.2 | 45.2 | 78 | 73 | 56 | 66.0 | 2000 | 32 R50X-S | 32 R50X-SS | 140 | 140 |

Steel, stainless steel and brass Triple-Lok® parts are delivered with NBR elastomeric seals as standard. For more details on other seal materials see page K92.

Order codes shown are part of our current manufacturing programme.

Imperial and metric parts may vary in hexagon dimensions.

$\frac{\text{PN (bar)}}{10} = \text{PN (MPa)}$

Do not create drawings from these dimensions, they are subject to change and ISO manufacturing allowances.



Triple-Lok®

R4OMX Male stud run tee

Triple-Lok® 37° Flare end / Adjustable BSPP thread O-ring + retaining ring (ISO 1179)

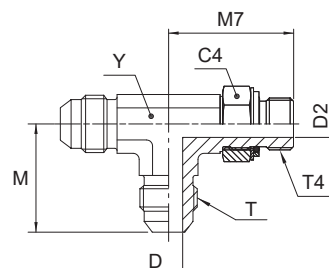

| Tube O.D. | | Thread BSPP T4 | Thread UN/UNF-2A T | C4 mm | D mm | D2 mm | M mm | M7 mm | XX mm | Y mm | Weight (steel) g/1 piece | Triple-Lok® Steel | Triple-Lok® Stainless Steel | PN (bar) | |
|------------|-------|----------------|--------------------|-------|------|-------|------|-------|-------|------|--------------------------|-------------------|-----------------------------|----------|-----|
| mm | in. | | | | | | | | | | | | | S | SS |
| 6 | 1/4 | 1/8-28 | 7/16-20 | 14 | 4.4 | 4.4 | 23 | 27 | 17 | 11 | 47 | 4R4OMXS | 4R4OMXSS | 250 | 200 |
| 10 | 3/8 | 1/4-19 | 9/16-18 | 19 | 7.5 | 7.5 | 27 | 32 | 19 | 14 | 78 | 6R4OMXS | 6R4OMXSS | 250 | 200 |
| 12 | 1/2 | 3/8-19 | 3/4-16 | 22 | 9.9 | 9.9 | 32 | 37 | 24 | 19 | 154 | 8R4OMXS | 8R4OMXSS | 250 | 200 |
| 14, 15, 16 | 5/8 | 1/2-14 | 7/8-14 | 27 | 12.3 | 12.3 | 37 | 43 | 27 | 22 | 231 | 10R4OMXS | 10R4OMXSS | 250 | 200 |
| 18, 20 | 3/4 | 3/4-14 | 1 1/16-12 | 36 | 15.5 | 15.5 | 42 | 50 | 34 | 27 | 379 | 12R4OMXS | 12R4OMXSS | 250 | 200 |
| 25 | 1 | 1-11 | 1 5/16-12 | 41 | 21.5 | 21.5 | 46 | 52 | 34 | 33 | 569 | 16R4OMXS | 16R4OMXSS | 250 | 200 |
| 28, 30, 32 | 1 1/4 | 1 1/4-11 | 1 5/8-12 | 50 | | | | | | | 1075 | 20R4OMXS | 20R4OMXSS | 210 | 160 |

Steel, stainless steel and brass Triple-Lok® parts are delivered with NBR elastomeric seals as standard. For more details on other seal materials see page K92.

Order codes shown are part of our current manufacturing programme.

Imperial and metric parts may vary in hexagon dimensions.

$$\frac{\text{PN (bar)}}{10} = \text{PN (MPa)}$$

Do not create drawings from these dimensions, they are subject to change and ISO manufacturing allowances.

R80MX Male stud run tee

Triple-Lok® 37° Flare ends / Male metric thread – O-ring + retaining ring

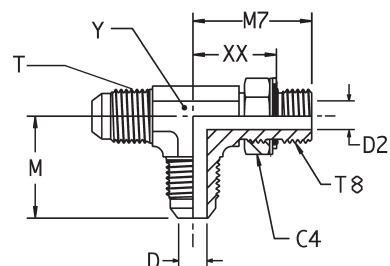

| Tube O.D. | | Thread Metric T8 | Thread UN/UNF-2A T | C4 mm | D mm | D2 mm | M mm | M7 mm | XX mm | Y mm | Weight (steel) g/1 piece | Triple-Lok® Steel | PN (bar) |
|------------|------|------------------|--------------------|-------|------|-------|------|-------|-------|------|--------------------------|--------------------|----------|
| mm | in. | | | | | | | | | | | | |
| 6 | 1/4 | M 10×1.0 | 7/16-20 | 14 | 4.4 | 4.5 | 23 | 27 | 18 | 11 | 27 | 4M10R80MXS | 250 |
| 8 | 5/16 | M 12×1.5 | 1/2-20 | 17 | 6.0 | 6.0 | 24 | 31 | 20 | 13 | 42 | 5M12R80MXS | 250 |
| 10 | 3/8 | M 14×1.5 | 9/16-18 | 17 | 7.5 | 7.5 | 27 | 34 | 23 | 14 | 53 | 6M14R80MXS | 250 |
| 12 | 1/2 | M 16×1.5 | 3/4-16 | 19 | 9.9 | 9.0 | 32 | 38 | 27 | 19 | 95 | 8M16R80MXS | 250 |
| 12 | 1/2 | M 18×1.5 | 3/4-16 | 22 | 9.9 | 9.9 | 32 | 38 | 26 | 19 | 114 | 8M18R80MXS | 250 |
| 14, 15, 16 | 5/8 | M 22×1.5 | 7/8-14 | 27 | 12.3 | 14.0 | 37 | 43 | 29 | 22 | 175 | 10M22R80MXS | 250 |
| 18, 20 | 3/4 | M 27×2.0 | 1 1/16-12 | 32 | 15.5 | 18.0 | 42 | 51 | 35 | 27 | 304 | 12M27R80MXS | 175 |
| 25 | 1 | M 33×2.0 | 1 5/16-12 | 38 | 22.5 | 23.0 | 46 | 53 | 38 | 33 | 491 | 16M33R80MXS | 140 |

Steel, stainless steel and brass Triple-Lok® parts are delivered with NBR elastomeric seals as standard. For more details on other seal materials see page K92.

Order codes shown are part of our current manufacturing programme.

Imperial and metric parts may vary in hexagon dimensions.

$$\frac{\text{PN (bar)}}{10} = \text{PN (MPa)}$$

Do not create drawings from these dimensions, they are subject to change and ISO manufacturing allowances.

K

Triple-Lok®

RMTX Male stud run tee

Triple-Lok® 37° Flare ends / Male NPTF* thread (SAE 476)

SAE 070424 MS51511

*Stainless Steel = NPT to prevent galling

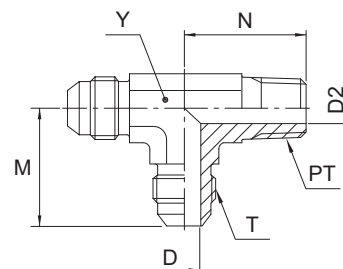

| Tube O.D. | | Thread NPT/NPTF PT | Thread UN/UNF-2A T | D mm | D2 mm | M mm | N mm | Y mm | Weight (steel) g/1 piece | Triple-Lok® Steel | Triple-Lok® Stainless Steel | Triple-Lok® Brass | PN (bar) | |
|------------|-------|--------------------|--------------------|------|-------|------|------|------|--------------------------|--------------------|-----------------------------|--------------------|----------|-----|
| mm | in. | | | | | | | | | | | | S | SS |
| 6 | 3/16 | 1/8-27 | 3/8-24 | 3.2 | 4.7 | 21 | 18 | 11.0 | 25 | 3 RTX-S | 3 RTX-SS | 4 RTX-B | 420 | 350 |
| | 1/4 | 1/8-27 | 7/16-20 | 4.4 | 4.7 | 23 | 20 | 11.0 | 31 | 4 RTX-S | 4 RTX-SS | 4 RTX-B | 420 | 350 |
| 6 | 1/4 | 1/4-18 | 7/16-20 | 4.4 | 7.0 | 27 | 28 | 14.0 | 49 | 4-4-4 RTX-S | 4-4-4 RTX-SS | 4-4-4 RTX-B | 420 | 350 |
| | 5/16 | 1/8-27 | 1/2-20 | 6.0 | 4.7 | 24 | 20 | 14.0 | 37 | 5 RTX-S | 5 RTX-SS | 5 RTX-B | 420 | 350 |
| 10 | 3/8 | 1/4-18 | 9/16-18 | 7.5 | 7.0 | 27 | 28 | 14.0 | 57 | 6 RTX-S | 6 RTX-SS | 6 RTX-B | 420 | 350 |
| | 3/8 | 3/8-18 | 9/16-18 | 7.5 | 10.3 | 29 | 31 | 19.0 | 77 | 6-6-6 RTX-S | 6-6-6 RTX-SS | 6-6-6 RTX-B | 420 | 350 |
| 12 | 1/2 | 3/8-18 | 3/4-16 | 9.9 | 10.3 | 32 | 31 | 19.0 | 109 | 8 RTX-S | 8 RTX-SS | 8 RTX-B | 420 | 350 |
| | 1/2 | 1/2-14 | 3/4-16 | 9.9 | 13.5 | 34 | 37 | 22.0 | 163 | 8-8-8 RTX-S | 8-8-8 RTX-SS | 8-8-8 RTX-B | 420 | 350 |
| 14, 15, 16 | 5/8 | 1/2-14 | 7/8-14 | 12.3 | 13.5 | 37 | 37 | 22.0 | 172 | 10 RTX-S | 10 RTX-SS | 10 RTX-B | 350 | 350 |
| | 3/4 | 3/4-14 | 1 1/16-12 | 15.5 | 18.3 | 42 | 40 | 27.0 | 268 | 12 RTX-S | 12 RTX-SS | 12 RTX-B | 280 | 280 |
| 22 | 7/8 | 3/4-14 | 1 3/16-12 | 18.3 | 18.3 | 46 | 43 | 33.3 | 323 | 14 RTX-S | | | 280 | — |
| | 1 | 1-11.5 | 1 5/16-12 | 21.4 | 23.8 | 46 | 50 | 33.3 | 413 | 16 RTX-S | 16 RTX-SS | 16 RTX-B | 210 | 210 |
| 28, 30, 32 | 1 1/4 | 1 1/4-11.5 | 1 5/8-12 | 27.4 | 31.8 | 52 | 60 | 41.0 | 681 | 20 RTX-S | 20 RTX-SS | 20 RTX-B | 170 | 170 |
| | 1 1/2 | 1 1/2-11.5 | 1 7/8-12 | 33.3 | 38.0 | 59 | 67 | 47.6 | 905 | 24 RTX-S | 24 RTX-SS | | 170 | 140 |

Order codes shown are part of our current manufacturing programme.

Imperial and metric parts may vary in hexagon dimensions.

$$\frac{\text{PN (bar)}}{10} = \text{PN (MPa)}$$

Pressure ratings – PN shown, apply to Steel and Stainless Steel versions of the product.

For Brass parts reduce pressures by 35 %.

Do not create drawings from these dimensions, they are subject to change and ISO manufacturing allowances.

R3MX Male stud run tee

Triple-Lok® 37° Flare ends / Male BSPT thread (ISO 7)

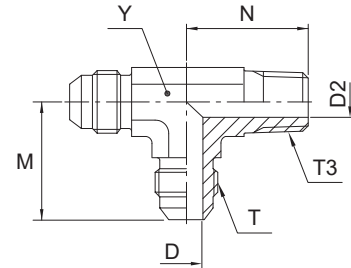

| Tube O.D. | | Thread BSPT T3 | Thread UN/UNF-2A T | D mm | D2 mm | M mm | N mm | Y mm | Weight (steel) g/1 piece | Triple-Lok® Steel | Triple-Lok® Stainless Steel | PN (bar) | |
|------------|------|----------------|--------------------|------|-------|------|------|------|--------------------------|-------------------|-----------------------------|----------|-----|
| mm | in. | | | | | | | | | | | S | SS |
| 6 | 1/4 | 1/8-28 | 7/16-20 | 4.4 | 5.0 | 23 | 20 | 11 | 30 | 4R3MXS | 4R3MXSS | 315 | 315 |
| 8 | 5/16 | 1/8-28 | 1/2-20 | 6.0 | 5.0 | 24 | 20 | 13 | 36 | 5R3MXS | 5R3MXSS | 315 | 315 |
| 10 | 3/8 | 1/4-19 | 9/16-18 | 7.5 | 7.0 | 27 | 28 | 14 | 55 | 6R3MXS | 6R3MXSS | 315 | 315 |
| 12 | 1/2 | 3/8-19 | 3/4-16 | 9.9 | 10.0 | 32 | 31 | 19 | 107 | 8R3MXS | 8R3MXSS | 315 | 315 |
| 14, 15, 16 | 5/8 | 1/2-14 | 7/8-14 | 12.3 | 13.5 | 37 | 37 | 22 | 170 | 10R3MXS | 10R3MXSS | 315 | 315 |

Order codes shown are part of our current manufacturing programme.

Imperial and metric parts may vary in hexagon dimensions.

$$\frac{\text{PN (bar)}}{10} = \text{PN (MPa)}$$

Do not create drawings from these dimensions, they are subject to change and ISO manufacturing allowances.

K

Triple-Lok®

G4MX Female connector

Triple-Lok® 37° Flare end / Female BSPP thread (ISO 1179-1)

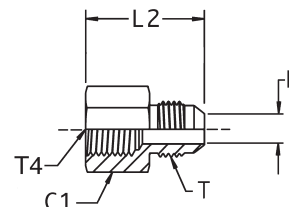

| Tube O.D. | | Thread BSPP T4 | Thread UN/UNF-2A T | C1 mm | D mm | L2 mm | Weight (steel) g/1 piece | Triple-Lok® Steel | Triple-Lok® Stainless Steel | PN (bar) | |
|------------|-------|----------------|--------------------|-------|------|-------|--------------------------|-------------------|-----------------------------|----------|-----|
| mm | in. | | | | | | | | | S | SS |
| 6 | 1/4 | 1/8-28 | 7/16-20 | 17 | 4.4 | 30 | 15 | 4G4MXS | 4G4MXSS | 315 | 315 |
| 6 | 1/4 | 1/4-19 | 7/16-20 | 19 | 4.4 | 35 | 42 | 4-4G4MXS | 4-4G4MXSS | 400 | 350 |
| 8 | 5/16 | 1/8-28 | 1/2-20 | 17 | 6.0 | 30 | 22 | 5G4MXS | 5G4MXSS | 315 | 315 |
| 8 | 5/16 | 1/4-19 | 1/2-20 | 19 | 6.0 | 35 | 40 | 5-4G4MXS | 5-4G4MXSS | 400 | 350 |
| 10 | 3/8 | 1/4-19 | 9/16-18 | 19 | 7.5 | 36 | 40 | 6G4MXS | 6G4MXSS | 400 | 350 |
| 10 | 3/8 | 3/8-19 | 9/16-18 | 22 | 7.5 | 37 | 50 | 6-6G4MXS | 6-6G4MXSS | 350 | 350 |
| 12 | 1/2 | 3/8-19 | 3/4-16 | 22 | 9.9 | 40 | 64 | 8G4MXS | 8G4MXSS | 350 | 350 |
| 12 | 1/2 | 1/2-14 | 3/4-16 | 30 | 9.9 | 46 | 116 | 8-8G4MXS | 8-8G4MXSS | 400 | 350 |
| 14, 15, 16 | 5/8 | 1/2-14 | 7/8-14 | 30 | 12.3 | 48 | 121 | 10G4MXS | 10G4MXSS | 350 | 350 |
| 18, 20 | 3/4 | 3/4-14 | 1 1/16-12 | 36 | 15.5 | 52 | 188 | 12G4MXS | 12G4MXSS | 315 | 315 |
| 25 | 1 | 1 1/11 | 1 5/16-12 | 46 | 21.5 | 60 | 340 | 16G4MXS | 16G4MXSS | 280 | 280 |
| 28, 30, 32 | 1 1/4 | 1 1/4-11 | 1 5/8-12 | 50 | 27.5 | 63 | 438 | 20G4MXS | 20G4MXSS | 210 | 210 |
| 35, 38 | 1 1/2 | 1 1/2-11 | 1 7/8-12 | 55 | 33.0 | 67 | 526 | 24G4MXS | 24G4MXSS | 140 | 140 |

Order codes shown are part of our current manufacturing programme.

Imperial and metric parts may vary in hexagon dimensions.

$$\frac{\text{PN (bar)}}{10} = \text{PN (MPa)}$$

Do not create drawings from these dimensions, they are subject to change and ISO manufacturing allowances.

GMTX Female connector

Triple-Lok® 37° Flare end / Female NPTF* thread (SAE J476)

SAE 070103 MS51503

*Stainless Steel = NPT to prevent galling

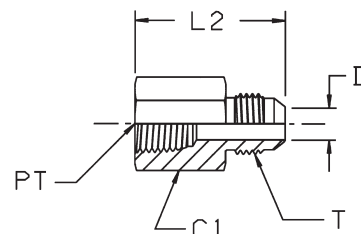

| Tube O.D. | | Thread NPT/NPTF PT | Thread UN/UNF-2A T | C1 mm | D mm | L2 mm | Weight (steel) g/1 piece | Triple-Lok® Steel | Triple-Lok® Stainless Steel | PN (bar) | |
|------------|-------|--------------------|--------------------|-------|------|-------|--------------------------|--------------------|-----------------------------|----------|-----|
| mm | in. | | | | | | | | | S | SS |
| 2 | 1/8 | 1/8-27 | 5/16-24 | 14.3 | 1.6 | 28.0 | 18 | 2 GTX-S | | 420 | |
| 6 | 1/4 | 1/8-27 | 7/16-20 | 14.3 | 4.4 | 30.0 | 42 | 4 GTX-S | 4GMTXSS | 420 | 350 |
| 6 | 1/4 | 1/4-18 | 7/16-20 | 19.0 | 4.4 | 35.0 | 40 | 4-4 GTX-S | 4-4GMTXSS | 420 | 350 |
| 8 | 5/16 | 1/8-27 | 1/2-20 | 14.3 | 6.0 | 30.0 | 40 | 5 GTX-S | 5GMTXSS | 420 | 350 |
| 8 | 5/16 | 1/4-18 | 1/2-20 | 19.0 | 6.0 | 35.5 | 42 | 5-4 GTX-S | 5-4GMTXSS | 420 | 350 |
| 10 | 3/8 | 1/4-18 | 9/16-18 | 19.0 | 7.5 | 36.0 | 40 | 6 GTX-S | 6GMTXSS | 420 | 350 |
| 10 | 3/8 | 3/8-18 | 9/16-18 | 22.3 | 7.5 | 37.0 | 62 | 6-6 GTX-S | 6-6GMTXSS | 420 | 350 |
| 10 | 3/8 | 1/2-14 | 9/16-18 | 22.3 | 7.5 | 43.0 | 90 | 6-8 GTX-S | 6-8GMTXSS | 350 | 350 |
| 12 | 1/2 | 3/8-18 | 3/4-16 | 22.3 | 9.9 | 40.0 | 45 | 8 GTX-S | 8GMTXSS | 420 | 350 |
| 12 | 1/2 | 1/4-18 | 3/4-16 | 20.6 | 9.9 | 36.0 | 80 | 8-4 GTX-S | 8-4GMTXSS | 420 | 350 |
| 12 | 1/2 | 1/2-14 | 3/4-16 | 28.6 | 9.9 | 46.0 | 116 | 8-8 GTX-S | 8-8GMTXSS | 350 | 350 |
| 12 | 1/2 | 3/4-14 | 3/4-16 | 35.0 | 9.9 | 47.0 | 150 | 8-12 GTX-S | 8-12GMTXSS | 280 | 280 |
| 14, 15, 16 | 5/8 | 1/2-14 | 7/8-14 | 28.6 | 12.3 | 48.0 | 121 | 10 GTX-S | 10GMTXSS | 350 | 350 |
| 14, 15, 16 | 5/8 | 3/4-14 | 7/8-14 | 35.0 | 12.3 | 50.0 | 182 | 10-12 GTX-S | 10-12GMTXSS | 280 | 280 |
| 18, 20 | 3/4 | 3/4-14 | 1 1/16-12 | 35.0 | 15.5 | 52.0 | 188 | 12 GTX-S | 12GMTXSS | 280 | 280 |
| 18, 20 | 3/4 | 1/2-14 | 1 1/16-12 | 28.6 | 15.5 | 52.0 | 133 | 12-8 GTX-S | 12-8GMTXSS | 350 | 350 |
| 25 | 1 | 1-11.5 | 1 5/16-12 | 41.3 | 21.4 | 60.0 | 280 | 16 GTX-S | 16GMTXSS | 210 | 210 |
| 28, 30, 32 | 1 1/4 | 1 1/4-11.5 | 1 5/8-12 | 51.0 | 27.4 | 63.0 | 408 | 20 GTX-S | 20GMTXSS | 170 | 170 |
| 35, 38 | 1 1/2 | 1 1/2-11.5 | 1 7/8-12 | 60.3 | 33.3 | 67.0 | 370 | 24 GTX-S | 24GMTXSS | 140 | 140 |

Order codes shown are part of our current manufacturing programme.

Imperial and metric parts may vary in hexagon dimensions.

PN (bar)
10 = PN (MPa)

Do not create drawings from these dimensions, they are subject to change and ISO manufacturing allowances.

K

Triple-Lok®

WGMTX Female bulkhead connector

Triple-Lok® 37° Flare end / Female NPTF* thread (SAE J476)

*Stainless Steel = NPT to prevent galling

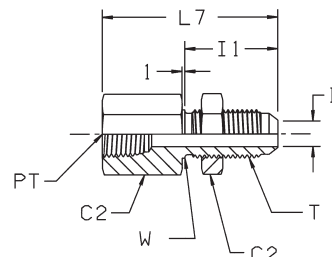

| Tube O.D. | | Thread NPT/NPTF PT | Thread UN/UNF-2A T | C2 mm | D mm | I1 mm | L7 mm | W mm | Weight (steel) g/1 piece | Triple-Lok® | | PN (bar) | |
|------------|-----|--------------------|--------------------|-------|------|-------|-------|------|--------------------------|-----------------------|----------------------|----------|-----|
| mm | in. | | | | | | | | | Steel | Stainless Steel | S | SS |
| 6 | 1/4 | 1/8-27 | 7/16-20 | 17.5 | 4.4 | 31 | 47 | 11 | 42 | 4 WGTX-WLN-S | 4WGMTXWLNMS | 420 | 350 |
| 6 | 1/4 | 1/4-18 | 7/16-20 | 19.0 | 4.4 | 31 | 54 | 11 | 62 | 4-4 WGTX-WLN-S | 4-4WGMTXWLNMS | 420 | 350 |
| 10 | 3/8 | 1/4-18 | 9/16-18 | 20.6 | 7.5 | 33 | 54 | 14 | 72 | 6 WGTX-WLN-S | 6WGMTXWLNMS | 420 | 350 |
| 12 | 1/2 | 3/8-18 | 3/4-16 | 25.4 | 9.9 | 37 | 59 | 19 | 117 | 8 WGTX-WLN-S | 8WGMTXWLNMS | 420 | 350 |
| 14, 15, 16 | 5/8 | 1/2-14 | 7/8-14 | 28.6 | 12.3 | 41 | 69 | 22 | 179 | 10 WGTX-WLN-S | 10WGMTXWLNMS | 350 | 350 |
| 18, 20 | 3/4 | 3/4-14 | 1 1/16-12 | 35.0 | 15.5 | 45 | 75 | 27 | 284 | 12 WGTX-WLN-S | 12WGMTXWLNMS | 280 | 280 |
| 25 | 1 | 1-11.5 | 1 5/16-12 | 41.3 | 21.4 | 45 | 81 | 33 | 415 | 16 WGTX-WLN-S | 16WGMTXWLNMS | 210 | 210 |

Order codes shown are part of our current manufacturing programme.

Imperial and metric parts may vary in hexagon dimensions.

For the version without the locknut remove "WLN" (e.g. 10 WGTX)

$$\frac{\text{PN (bar)}}{10} = \text{PN (MPa)}$$

Do not create drawings from these dimensions, they are subject to change and ISO manufacturing allowances.

Maximum bulkhead wallthickness

| Size | Tube O.D. | | Straight bulkhead union Max. thickness mm | Shape bulkhead union Max. thickness mm |
|------|-----------|--------|---|--|
| | inch | metric | | |
| 4 | 1/4 | 6 | 8.4 | 5.3 |
| 5 | 5/16 | 8 | 8.4 | 5.3 |
| 6 | 3/8 | 10 | 10.7 | 7.1 |
| 8 | 1/2 | 12 | 11.2 | 8.4 |
| 10 | 5/8 | 14-16 | 10.9 | 8.1 |
| 12 | 3/4 | 18-20 | 11.2 | 8.6 |
| 14 | 7/8 | | 10.4 | 7.9 |
| 16 | 1 | 22-25 | 9.9 | 7.4 |
| 20 | 1 1/4 | 28-32 | 10.2 | 7.4 |
| 24 | 1 1/2 | 35-38 | 7.1 | — |
| 32 | 2 | | 7.1 | — |



DMTX Female elbow connector

Triple-Lok® 37° Flare end / Female NPTF* thread (SAE J476)

SAE 070203 MS51506

*Stainless Steel = NPT to prevent galling

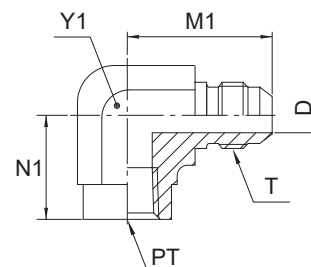

| Tube O.D. | | Thread NPT/NPTF PT | Thread UN/UNF-2A T | D mm | M1 mm | N1 mm | Y1 mm | Weight (steel) g/1 piece | Triple-Lok® Steel | Triple-Lok® Stainless Steel | Triple-Lok® Brass | PN (bar) | |
|------------|-------|--------------------|--------------------|------|-------|-------|-------|--------------------------|-------------------|-----------------------------|-------------------|----------|-----|
| mm | in. | | | | | | | | | | | S | SS |
| 6 | 1/4 | 1/8-27 | 7/16-20 | 4.4 | 27 | 17 | 14.0 | 33 | 4 DTX-S | 4 DTX-SS | 4 DTX-B | 350 | 350 |
| 6 | 1/4 | 1/4-18 | 7/16-20 | 4.4 | 31 | 22 | 19.0 | 70 | 4-4 DTX-S | 4-4 DTX-SS | 4-4 DTX-B | 350 | 350 |
| 8 | 5/16 | 1/8-27 | 1/2-20 | 6.0 | 27 | 17 | 14.0 | 33 | 5 DTX-S | 5 DTX-SS | 5 DTX-B | 350 | 350 |
| 8 | 5/16 | 1/4-18 | 1/2-20 | 6.0 | 31 | 22 | 19.0 | 67 | 5-4 DTX-S | 5-4 DTX-SS | 5-4 DTX-B | 350 | 350 |
| 10 | 3/8 | 1/4-18 | 9/16-18 | 7.5 | 31 | 22 | 19.0 | 67 | 6 DTX-S | 6 DTX-SS | 6 DTX-B | 350 | 350 |
| 10 | 3/8 | 1/8-27 | 9/16-18 | 7.5 | 31 | 17 | 14.0 | 39 | 6-2 DTX-S | 6-2 DTX-SS | 6-2 DTX-B | 350 | 350 |
| 10 | 3/8 | 3/8-18 | 9/16-18 | 7.5 | 33 | 26 | 22.0 | 103 | 6-6 DTX-S | 6-6 DTX-SS | 6-6 DTX-B | 310 | 310 |
| 12 | 1/2 | 3/8-18 | 3/4-16 | 9.9 | 36 | 26 | 22.0 | 115 | 8 DTX-S | 8 DTX-SS | 8 DTX-B | 310 | 310 |
| 12 | 1/2 | 1/4-18 | 3/4-16 | 9.9 | 36 | 26 | 19.0 | 190 | 8-4 DTX-S | 8-4 DTX-SS | 8-4 DTX-B | 350 | 350 |
| 12 | 1/2 | 1/2-14 | 3/4-16 | 9.9 | 39 | 31 | 27.0 | 178 | 8-8 DTX-S | 8-8 DTX-SS | 8-8 DTX-B | 210 | 210 |
| 14, 15, 16 | 5/8 | 1/2-14 | 7/8-14 | 12.3 | 42 | 31 | 27.0 | 180 | 10 DTX-S | 10 DTX-SS | 10 DTX-B | 210 | 210 |
| 18, 20 | 3/4 | 3/4-14 | 1 1/16-12 | 15.5 | 48 | 35 | 33.3 | 315 | 12 DTX-S | 12 DTX-SS | 12 DTX-B | 210 | 210 |
| 18, 20 | 3/4 | 1/2-14 | 1 1/16-12 | 15.5 | 48 | 34 | 27.0 | 175 | 12-8 DTX-S | 12-8 DTX-SS | 12-8 DTX-B | 210 | 210 |
| 22 | 7/8 | 3/4-14 | 1 3/16-12 | 18.3 | 47 | 36 | 33.3 | 285 | 14 DTX-S | 14 DTX-SS | | 125 | 125 |
| 25 | 1 | 1-11.5 | 1 5/16-12 | 21.4 | 55 | 41 | 41.0 | 506 | 16 DTX-S | 16 DTX-SS | 16 DTX-B | 125 | 125 |
| 28, 30, 32 | 1 1/4 | 1 1/4-11.5 | 1 5/8-12 | 27.4 | 59 | 43 | 47.7 | 619 | 20 DTX-S | 20 DTX-SS | 20 DTX-B | 100 | 100 |
| 35, 38 | 1 1/2 | 1 1/2-11.5 | 1 7/8-12 | 33.3 | 73 | 53 | 64.0 | 1725 | 24 DTX-S | 24 DTX-SS | | 100 | 100 |

Order codes shown are part of our current manufacturing programme.

Imperial and metric parts may vary in hexagon dimensions.

$$\frac{\text{PN (bar)}}{10} = \text{PN (MPa)}$$

Pressure ratings – PN shown, apply to Steel and Stainless Steel versions of the product.

For Brass parts reduce pressures by 35 %.

Do not create drawings from these dimensions, they are subject to change and ISO manufacturing allowances.

K

Triple-Lok®
OTX Female branch tee

Triple-Lok® 37° Flare ends / Female NPTF* thread (SAE J476)

SAE 070427 MS51513

*Stainless Steel = NPT to prevent galling

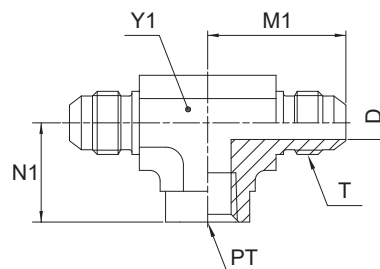

| Tube O.D. | | Thread NPT/NPTF PT | Thread UN/UNF-2A T | D mm | M1 mm | N1 mm | Y1 mm | Weight (steel) g/1 piece | Triple-Lok® Steel | Triple-Lok® Stainless Steel | Triple-Lok® Brass | PN (bar) | |
|------------|-------|--------------------|--------------------|------|-------|-------|-------|--------------------------|-------------------|-----------------------------|-------------------|----------|-----|
| mm | in. | | | | | | | | | | | S | SS |
| 6 | 1/4 | 1/8-27 | 7/16-20 | 4.4 | 27 | 17 | 14.0 | 53 | 4 OTX-S | 4 OTX-SS | 4 OTX-B | 350 | 350 |
| 8 | 5/16 | 1/8-27 | 1/2-20 | 6.0 | 27 | 17 | 14.0 | 53 | 5 OTX-S | 5 OTX-SS | 5 OTX-B | 350 | 350 |
| 10 | 3/8 | 1/4-18 | 9/16-18 | 7.5 | 32 | 22 | 19.0 | 98 | 6 OTX-S | 6 OTX-SS | 6 OTX-B | 350 | 350 |
| 12 | 1/2 | 3/8-18 | 3/4-16 | 9.9 | 36 | 26 | 22.0 | 145 | 8 OTX-S | 8 OTX-SS | 8 OTX-B | 310 | 310 |
| 14, 15, 16 | 5/8 | 1/2-14 | 7/8-14 | 12.3 | 42 | 32 | 27.0 | 240 | 10 OTX-S | 10 OTX-SS | 10 OTX-B | 210 | 210 |
| 18, 20 | 3/4 | 3/4-14 | 1 1/16-12 | 15.5 | 48 | 35 | 33.3 | 390 | 12 OTX-S | 12 OTX-SS | 12 OTX-B | 210 | 210 |
| 25 | 1 | 1-11.5 | 1 5/16-12 | 21.4 | 55 | 41 | 41.0 | 745 | 16 OTX-S | 16 OTX-SS | 16 OTX-B | 125 | 125 |
| 28, 30, 32 | 1 1/4 | 1 1/4-11.5 | 1 5/8-12 | 27.4 | 59 | 43 | 47.7 | 930 | 20 OTX-S | 20 OTX-SS | | 100 | 100 |
| 35, 38 | 1 1/2 | 1 1/2-11.5 | 1 7/8-12 | 33.3 | 73 | 53 | 64.0 | 2255 | 24 OTX-S | 24 OTX-SS | | 100 | 100 |

Order codes shown are part of our current manufacturing programme.

Imperial and metric parts may vary in hexagon dimensions.

$$\frac{\text{PN (bar)}}{10} = \text{PN (MPa)}$$

Pressure ratings – PN shown, apply to Steel and Stainless Steel versions of the product.

For Brass parts reduce pressures by 35 %.

Do not create drawings from these dimensions, they are subject to change and ISO manufacturing allowances.

MTX Female run tee

Triple-Lok® 37° Flare ends / Female NPTF* thread (SAE J476)

SAE 070426 MS51514

*Stainless Steel = NPT to prevent galling

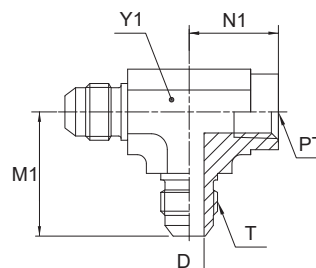

| Tube O.D. | | Thread NPT/NPTF PT | Thread UN/UNF-2A T | D mm | M1 mm | N1 mm | Y1 mm | Weight (steel) g/1 piece | Triple-Lok® Steel | Triple-Lok® Stainless Steel | Triple-Lok® Brass | PN (bar) | |
|------------|-------|--------------------|--------------------|------|-------|-------|-------|--------------------------|-------------------|-----------------------------|-------------------|----------|-----|
| mm | in. | | | | | | | | | | | S | SS |
| 6 | 1/4 | 1/8-27 | 7/16-20 | 4.4 | 27 | 17 | 14.0 | 45 | 4 MTX-S | 4 MTX-SS | 4 MTX-B | 350 | 350 |
| 10 | 3/8 | 1/4-18 | 9/16-18 | 7.5 | 32 | 22 | 19.0 | 88 | 6 MTX-S | 6 MTX-SS | 6 MTX-B | 350 | 350 |
| 12 | 1/2 | 3/8-18 | 3/4-16 | 9.9 | 36 | 26 | 22.0 | 125 | 8 MTX-S | 8 MTX-SS | 8 MTX-B | 310 | 310 |
| 14, 15, 16 | 5/8 | 1/2-14 | 7/8-14 | 12.3 | 42 | 32 | 27.0 | 210 | 10 MTX-S | 10 MTX-SS | 10 MTX-B | 210 | 210 |
| 18, 20 | 3/4 | 3/4-14 | 1 1/16-12 | 15.5 | 48 | 35 | 33.3 | 280 | 12 MTX-S | 12 MTX-SS | 12 MTX-B | 210 | 210 |
| 22 | 7/8 | 3/4-14 | 1 3/16-12 | 18.3 | 47 | 36 | 33.3 | 446 | 14 MTX-S | | | 210 | — |
| 25 | 1 | 1-11.5 | 1 5/16-12 | 21.4 | 55 | 41 | 41.0 | 620 | 16 MTX-S | 16 MTX-SS | | 125 | 125 |
| 28, 30, 32 | 1 1/4 | 1 1/4-11.5 | 1 5/8-12 | 27.4 | 59 | 43 | 47.7 | 805 | 20 MTX-S | 20 MTX-SS | | 100 | 100 |

Order codes shown are part of our current manufacturing programme.

Imperial and metric parts may vary in hexagon dimensions.

$$\frac{\text{PN (bar)}}{10} = \text{PN (MPa)}$$

Pressure ratings – PN shown, apply to Steel and Stainless Steel versions of the product.

For Brass parts reduce pressures by 35 %.

Do not create drawings from these dimensions, they are subject to change and ISO manufacturing allowances.

K

Triple-Lok®
G6X Swivel connector

Triple-Lok® 37° Flare female swivel end / Female NPTF* thread (SAE J476)

*Stainless Steel = NPT to prevent galling

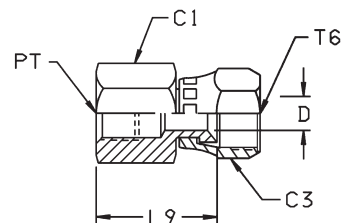

| Tube O.D. | | Thread NPT/NPTF PT | Thread UN/UNF-2B T6 | C1 mm | C3 mm | D mm | L9 mm | Weight (steel) g/1 piece | Triple-Lok® Steel | Triple-Lok® Stainless Steel | PN (bar) | |
|------------|-------|--------------------|---------------------|-------|-------|------|-------|--------------------------|-------------------|-----------------------------|----------|-----|
| mm | in. | | | | | | | | | | S | SS |
| 6 | 1/4 | 1/8-27 | 7/16-20 | 14.3 | 14.3 | 4.4 | 23 | 29 | 4 G6X-S | 4 G6X-SS | 420 | 420 |
| 6 | 1/4 | 1/4-18 | 7/16-20 | 19.0 | 14.3 | 4.4 | 27 | 33 | 4-4 G6X-S | 4-4 G6X-SS | 420 | 420 |
| 10 | 3/8 | 1/4-18 | 9/16-18 | 19.0 | 17.5 | 7.5 | 27 | 38 | 6 G6X-S | 6 G6X-SS | 350 | 350 |
| 10 | 3/8 | 3/8-18 | 9/16-18 | 22.2 | 17.5 | 7.5 | 29 | 45 | 6-6 G6X-S | 6-6 G6X-SS | 350 | 350 |
| 12 | 1/2 | 3/8-18 | 3/4-16 | 22.2 | 22.2 | 9.9 | 31 | 47 | 8 G6X-S | 8 G6X-SS | 350 | 350 |
| 12 | 1/2 | 1/2-14 | 3/4-16 | 28.6 | 22.2 | 9.9 | 38 | 99 | 8-8 G6X-S | 8-8 G6X-SS | 350 | 350 |
| 14, 15, 16 | 5/8 | 1/2-14 | 7/8-14 | 28.6 | 25.4 | 12.3 | 37 | 99 | 10 G6X-S | 10 G6X-SS | 350 | 350 |
| 18, 20 | 3/4 | 3/4-14 | 1 1/16-12 | 35.0 | 31.6 | 15.5 | 38 | 147 | 12 G6X-S | 12 G6X-SS | 280 | 280 |
| 25 | 1 | 1-11.5 | 1 5/16-12 | 41.3 | 38.0 | 21.4 | 47 | 248 | 16 G6X-S | 16 G6X-SS | 210 | 210 |
| 28, 30, 32 | 1 1/4 | 1 1/4-11.5 | 1 5/8-12 | 51.0 | 50.8 | 27.4 | 55 | 370 | 20 G6X-S | 20 G6X-SS | 170 | 170 |
| 35, 38 | 1 1/2 | 1 1/2-11.5 | 1 7/8-12 | 60.3 | 57.2 | 33.3 | 57 | 510 | 24 G6X-S | 24 G6X-SS | 140 | 140 |

Order codes shown are part of our current manufacturing programme.

Imperial and metric parts may vary in hexagon dimensions.

$$\frac{\text{PN (bar)}}{10} = \text{PN (MPa)}$$

Do not create drawings from these dimensions, they are subject to change and ISO manufacturing allowances.

G4MXMO Pressure gauge connector

Triple-Lok® 37° Flare end / Female BSPP gauge thread (ISO 1179-1)

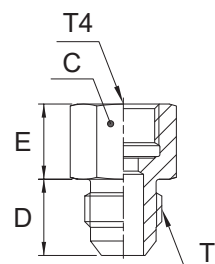

| Tube O.D. | | Thread BSPP T4 | Thread UN/UNF-2A T | D mm | E mm | C mm | Weight (steel) g/1 piece | Triple-Lok® Steel | Triple-Lok® Stainless Steel | PN (bar) | |
|-----------|------|----------------|--------------------|------|------|------|--------------------------|-------------------|-----------------------------|----------|-----|
| mm | in. | | | | | | | | | S | SS |
| 6 | 1/4 | 1/4-19 | 7/16-20 | 14 | 21 | 19 | 86 | 4-4G4MXSMO | 4-4G4MXSSMO | 350 | 350 |
| 6 | 1/4 | 1/2-14 | 7/16-20 | 14 | 25 | 27 | 246 | 4-8G4MXSMO | 4-8G4MXSSMO | 315 | 315 |
| 8 | 5/16 | 1/4-19 | 1/2-20 | 14 | 21 | 19 | 49 | 5-4G4MXSMO | 5-4G4MXSSMO | 350 | 350 |
| 8 | 5/16 | 1/2-14 | 1/2-20 | 14 | 27 | 27 | 246 | 5-8G4MXSMO | 5-8G4MXSSMO | 315 | 315 |
| 10 | 3/8 | 1/4-19 | 9/16-20 | 14 | 22 | 19 | 49 | 6G4MXSMO | 6G4MXSSMO | 350 | 350 |
| 10 | 3/8 | 1/2-14 | 9/16-20 | 14 | 29 | 30 | 239 | 6-8G4MXSMO | 6-8G4MXSSMO | 315 | 315 |
| 12 | 1/2 | 1/4-19 | 3/4-16 | 17 | 22 | 22 | 74 | 8-4G4MXSMO | 8-4G4MXSSMO | 400 | 350 |
| 12 | 1/2 | 1/2-14 | 3/4-16 | 17 | 28 | 30 | 263 | 8-8G4MXSMO | 8-8G4MXSSMO | 315 | 315 |

This part requires a copper washer. For more details on other seal materials see page K92.

Order codes shown are part of our current manufacturing programme.

Imperial and metric parts may vary in hexagon dimensions.

$\frac{PN \text{ (bar)}}{10} = PN \text{ (MPa)}$

Do not create drawings from these dimensions, they are subject to change and ISO manufacturing allowances.

K

Triple-Lok®

TT4MX Test point connector

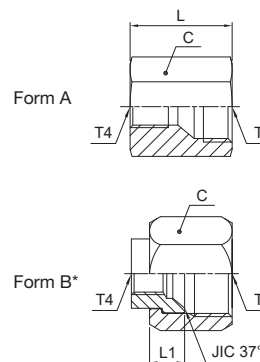
 Triple-Lok® 37° Flare female end / Female BSPP thread (ISO 1179-1)
 for EMA3 test point

* Form B has to be assembled with a nut
 BMTX / BTX (to be ordered separately).

| Tube O.D. | | Thread BSPP T4 | Thread UN/UNF-2B T | Form | L mm | L1 mm | C mm | Weight (steel) g/1 piece | Triple-Lok® Steel | Triple-Lok® Stainless Steel | PN (bar) | |
|------------|-------|----------------------|--------------------------|------|---------|----------|---------|--------------------------------|----------------------|--------------------------------|----------|-----|
| mm | in. | | | | | | | | | | S | SS |
| 6 | 1/4 | 1/4-19 | 7/16-20 | A | 29 | - | 19 | 42 | 4TT4MXS | 4TT4MXSS | 400 | 350 |
| 8 | 5/16 | 1/4-19 | 1/2-20 | A | 29 | - | 19 | 46 | 5TT4MXS | 5TT4MXSS | 400 | 350 |
| 10 | 3/8 | 1/4-19 | 9/16-18 | A | 29 | - | 19 | 43 | 6TT4MXS | 6TT4MXSS | 400 | 350 |
| 12 | 1/2 | 1/4-19 | 3/4-16 | A | 32 | - | 22 | 62 | 8TT4MXS | 8TT4MXSS | 400 | 350 |
| 14, 15, 16 | 5/8 | 1/4-19 | 7/8-14 | A | 32 | - | 27 | 102 | 10TT4MXS | 10TT4MXSS | 350 | 350 |
| 18, 20 | 3/4 | 1/4-19 | 1 1/16-12 | B | - | 11 | 32 | 42 | 12TT4XS | 12TT4XSS | 350 | 350 |
| 25 | 1 | 1/4-19 | 1 5/16-12 | B | - | 12 | 41 | 56 | 16TT4XS | 16TT4XSS | 280 | 280 |
| 28, 30, 32 | 1 1/4 | 1/4-19 | 1 5/8-12 | B | - | 15 | 50 | 98 | 20TT4XS | 20TT4XSS | 280 | 210 |
| 35, 38 | 1 1/2 | 1/4-19 | 1 7/8-12 | B | - | 17 | 60 | 185 | 24TT4XS | 24TT4XSS | 210 | 210 |

Order codes shown are part of our current manufacturing programme.

Imperial and metric parts may vary in hexagon dimensions.

$$\frac{\text{PN (bar)}}{10} = \text{PN (MPa)}$$

Do not create drawings from these dimensions, they are subject to change and ISO manufacturing allowances.

TTP4MX Test point connection

Triple-Lok® 37° Flare female end / EMA3 test point

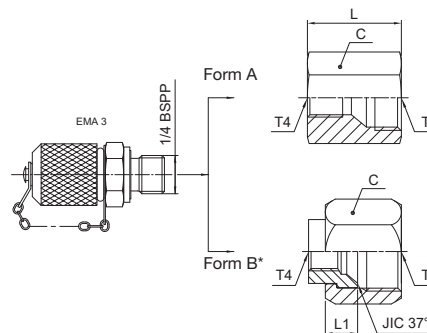

* Form B versions delivered complete with BMTXS nut.

| Tube O.D. | | Thread BSPP T4 | Thread UN/UNF-2B T | Form | L mm | L1 mm | C mm | Weight (steel) g/1 piece | Triple-Lok® Steel | PN (bar) |
|------------|----------|----------------------|--------------------------|------|---------|----------|---------|--------------------------------|----------------------|-------------|
| mm | T in. | | | | | | | | | |
| 6 | 1/4 | 1/4-19 | 7/16-20 | A | 29 | – | 19 | 132 | 4TTP4MXS | 400 |
| 8 | 5/16 | 1/4-19 | 1/2-20 | A | 29 | – | 19 | 136 | 5TTP4MXS | 400 |
| 10 | 3/8 | 1/4-19 | 9/16-18 | A | 29 | – | 19 | 133 | 6TTP4MXS | 400 |
| 12 | 1/2 | 1/4-19 | 3/4-16 | A | 32 | – | 22 | 152 | 8TTP4MXS | 400 |
| 14, 15, 16 | 5/8 | 1/4-19 | 7/8-14 | A | 32 | – | 27 | 192 | 10TTP4MXS | 350 |
| 18, 20 | 3/4 | 1/4-19 | 1 1/16-12 | B | – | 11 | 32 | 132 | 12TTP4XS | 350 |
| 25 | 1 | 1/4-19 | 1 5/16-12 | B | – | 12 | 41 | 146 | 16TTP4XS | 280 |
| 28, 30, 32 | 1 1/4 | 1/4-19 | 1 5/8-12 | B | – | 15 | 50 | 188 | 20TTP4XS | 280 |
| 35, 38 | 1 1/2 | 1/4-19 | 1 7/8-12 | B | – | 17 | 60 | 275 | 24TTP4XS | 210 |

Order codes shown are part of our current manufacturing programme.

Imperial and metric parts may vary in hexagon dimensions.

$$\frac{\text{PN (bar)}}{10} = \text{PN (MPa)}$$

Do not create drawings from these dimensions, they are subject to change and ISO manufacturing allowances.



Triple-Lok®
R604MX Test point connector

Male / Female swivel Triple-Lok® 37° flare end / Female BSPP thread (ISO 1179-1)

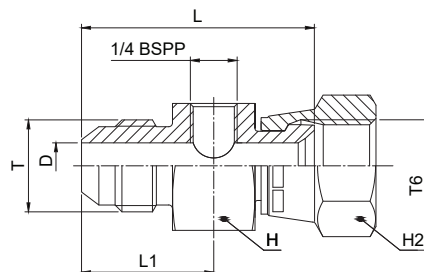

| Tube O.D. | | Thread | Thread | D | L | L1 | H | H2 | Weight (steel) g/1 piece | Triple-Lok® Steel | PN (bar) |
|------------|----------|----------------|-----------------|------|----|----|----|----|--------------------------------|----------------------|-------------|
| mm | T in. | UN/UNF-2A T | UN/UNF-2B T6 | | | | | | | | |
| 6 | 1/4 | 7/16-20 | 7/16-20 | 4.4 | 45 | 26 | 36 | 14 | 180 | 4-4R604MXS | 500 |
| 8 | 5/16 | 1/2-20 | 1/2-20 | 6.0 | 46 | 26 | 36 | 17 | 200 | 5-4R604MXS | 420 |
| 10 | 3/8 | 9/16-18 | 9/16-18 | 7.5 | 47 | 26 | 36 | 19 | 210 | 6-4R604MXS | 350 |
| 12 | 1/2 | 3/4-16 | 3/4-16 | 9.9 | 50 | 28 | 36 | 22 | 218 | 8-4R604MXS | 350 |
| 14, 15, 16 | 5/8 | 7/8-14 | 7/8-14 | 12.3 | 54 | 31 | 36 | 27 | 247 | 10-4R604MXS | 350 |
| 18, 20 | 3/4 | 1 1/16-12 | 1 1/16-12 | 15.5 | 56 | 34 | 41 | 32 | 326 | 12-4R604MXS | 350 |
| 25 | 1 | 1 5/16-12 | 1 5/16-12 | 21.4 | 60 | 35 | 46 | 38 | 416 | 16-4R604MXS | 250 |
| 28, 30, 32 | 1 1/4 | 1 5/8-12 | 1 5/8-12 | 27.4 | 64 | 36 | 50 | 50 | 601 | 20-4R604MXS | 250 |
| 35, 38 | 1 1/2 | 1 7/8-12 | 1 7/8-12 | 33.3 | 69 | 39 | 60 | 60 | 905 | 24-4R604MXS | 170 |

Order codes shown are part of our current manufacturing programme.

Imperial and metric parts may vary in hexagon dimensions.

$$\frac{\text{PN (bar)}}{10} = \text{PN (MPa)}$$

Do not create drawings from these dimensions, they are subject to change and ISO manufacturing allowances.

R6P4MX Test point connector

Male / Female swivel Triple-Lok® 37° flare end / EMA3 test point

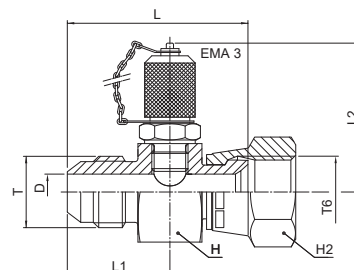

| Tube O.D. | | Thread UN/UNF-2A T | Thread UN/UNF-2B T6 | D mm | L mm | L1 mm | L2 mm | H mm | H2 mm | Weight (steel) g/1 piece | Triple-Lok® Steel | PN (bar) |
|------------|----------|--------------------------|---------------------------|---------|---------|----------|----------|---------|----------|--------------------------------|----------------------|-------------|
| mm | T in. | | | | | | | | | | | |
| 6 | 1/4 | 7/16-20 | 7/16-20 | 4.4 | 45 | 26 | 54 | 36 | 14 | 270 | 4-4R6P4MXS | 500 |
| 8 | 5/16 | 1/2-20 | 1/2-20 | 6.0 | 46 | 26 | 54 | 36 | 17 | 290 | 5-4R6P4MXS | 420 |
| 10 | 3/8 | 9/16-18 | 9/16-18 | 7.5 | 47 | 26 | 54 | 36 | 19 | 300 | 6-4R6P4MXS | 350 |
| 12 | 1/2 | 3/4-16 | 3/4-16 | 9.9 | 50 | 28 | 54 | 36 | 22 | 308 | 8-4R6P4MXS | 350 |
| 14, 15, 16 | 5/8 | 7/8-14 | 7/8-14 | 12.3 | 54 | 31 | 54 | 36 | 27 | 337 | 10-4R6P4MXS | 350 |
| 18, 20 | 3/4 | 1 1/16-12 | 1 1/16-12 | 15.5 | 56 | 34 | 54 | 41 | 32 | 416 | 12-4R6P4MXS | 350 |
| 25 | 1 | 1 5/16-12 | 1 5/16-12 | 21.4 | 60 | 35 | 54 | 46 | 38 | 506 | 16-4R6P4MXS | 250 |
| 28, 30, 32 | 1 1/4 | 1 5/8-12 | 1 5/8-12 | 27.4 | 64 | 36 | 54 | 50 | 50 | 691 | 20-4R6P4MXS | 250 |
| 35, 38 | 1 1/2 | 1 7/8-12 | 1 7/8-12 | 33.3 | 69 | 39 | 54 | 60 | 60 | 995 | 24-4R6P4MXS | 170 |

Order codes shown are part of our current manufacturing programme.

Imperial and metric parts may vary in hexagon dimensions.

$$\frac{\text{PN (bar)}}{10} = \text{PN (MPa)}$$

Do not create drawings from these dimensions, they are subject to change and ISO manufacturing allowances.

K

Triple-Lok®

K6004MX Test point connector

Male / Female swivel Triple-Lok® 37° flare end / 2 BSPP female threads

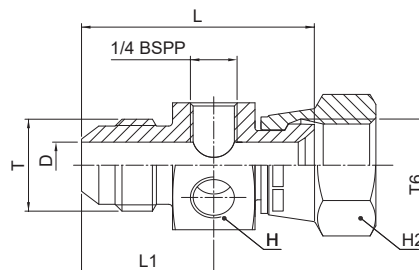

| Tube O.D. | | Thread UN/UNF-2A T | Thread UN/UNF-2B T6 | D mm | L mm | L1 mm | H mm | H2 mm | Weight (steel) g/1 piece | Triple-Lok® Steel | PN (bar) |
|------------|----------|--------------------------|---------------------------|---------|---------|----------|---------|----------|--------------------------------|----------------------|-------------|
| mm | T in. | | | | | | | | | | |
| 6 | 1/4 | 7/16-20 | 7/16-20 | 4.4 | 45 | 26 | 36 | 14 | 170 | 4-4K6004MXS | 500 |
| 8 | 5/16 | 1/2-20 | 1/2-20 | 6.0 | 46 | 26 | 36 | 17 | 190 | 5-4K6004MXS | 420 |
| 10 | 3/8 | 9/16-18 | 9/16-18 | 7.5 | 47 | 26 | 36 | 19 | 200 | 6-4K6004MXS | 350 |
| 12 | 1/2 | 3/4-16 | 3/4-16 | 9.9 | 50 | 28 | 36 | 22 | 208 | 8-4K6004MXS | 350 |
| 14, 15, 16 | 5/8 | 7/8-14 | 7/8-14 | 12.3 | 54 | 31 | 36 | 27 | 237 | 10-4K6004MXS | 350 |
| 18, 20 | 3/4 | 1 1/16-12 | 1 1/16-12 | 15.5 | 56 | 34 | 41 | 32 | 316 | 12-4K6004MXS | 350 |
| 25 | 1 | 1 5/16-12 | 1 5/16-12 | 21.4 | 60 | 35 | 46 | 38 | 406 | 16-4K6004MXS | 250 |

Order codes shown are part of our current manufacturing programme.

Imperial and metric parts may vary in hexagon dimensions.

$$\frac{\text{PN (bar)}}{10} = \text{PN (MPa)}$$

Do not create drawings from these dimensions, they are subject to change and ISO manufacturing allowances.

K6PP4MX Test point connector

Male / female swivel Triple-Lok® 37° flare end / EMA3 test point & blanking plug

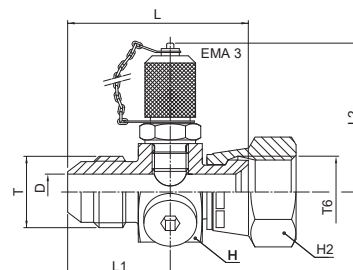

| Tube O.D. | | Thread UN/UNF-2A T | Thread UN/UNF-2B T6 | D mm | L mm | L1 mm | L2 mm | H mm | H2 mm | Weight (steel) g/1 piece | Triple-Lok® Steel | PN (bar) |
|------------|------|--------------------------|---------------------------|---------|---------|----------|----------|---------|----------|--------------------------------|----------------------|-------------|
| mm | in. | | | | | | | | | | | |
| 6 | 1/4 | 7/16-20 | 7/16-20 | 4.4 | 45 | 26 | 54 | 36 | 14 | 270 | 4-4K6PP4MXS | 500 |
| 8 | 5/16 | 1/2-20 | 1/2-20 | 6.0 | 46 | 26 | 54 | 36 | 17 | 290 | 5-4K6PP4MXS | 420 |
| 10 | 3/8 | 9/16-18 | 9/16-20 | 7.5 | 47 | 26 | 54 | 36 | 19 | 300 | 6-4K6PP4MXS | 350 |
| 12 | 1/2 | 3/4-16 | 3/4-16 | 9.9 | 50 | 28 | 54 | 36 | 22 | 308 | 8-4K6PP4MXS | 350 |
| 14, 15, 16 | 5/8 | 7/8-14 | 7/8-14 | 12.3 | 54 | 31 | 54 | 36 | 27 | 337 | 10-4K6PP4MXS | 350 |
| 18, 20 | 3/4 | 1 1/16-12 | 1 1/16-12 | 15.5 | 56 | 34 | 54 | 41 | 32 | 416 | 12-4K6PP4MXS | 350 |
| 25 | 1 | 1 5/16-12 | 1 5/16-12 | 21.4 | 60 | 35 | 54 | 46 | 38 | 506 | 16-4K6PP4MXS | 250 |

Order codes shown are part of our current manufacturing programme.

Imperial and metric parts may vary in hexagon dimensions.

$$\frac{\text{PN (bar)}}{10} = \text{PN (MPa)}$$

Do not create drawings from these dimensions, they are subject to change and ISO manufacturing allowances.

K

Triple-Lok®

FNMTX Cap

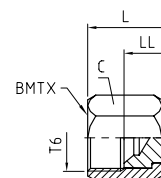
 Triple-Lok® 37° Flare female swivel cap end
 SAE 070112 MS51532

| Tube O.D. | | Thread UN/UNF-2B T6 | C mm | LL mm | L mm | Weight (steel) g/1 piece | Triple-Lok® Steel | Triple-Lok® Stainless Steel | Triple-Lok® Brass | PN (bar) | |
|------------|--------|---------------------|------|-------|------|--------------------------|-------------------|-----------------------------|-------------------|----------|-----|
| mm | in. | | | | | | | | | S | SS |
| 6 | 1/8 | 5/16-24 | 9.5 | 10 | 15 | 10 | 2 FNTX-S | | | 500 | — |
| | 3/16 | 3/8-24 | 11.0 | 10 | 17 | 11 | 3 FNTX-S | | | 500 | — |
| | 1/4 | 7/16-20 | 14.0 | 9 | 17 | 14 | 4FNMTXS | 4FNMTXSS | 4 FNTX-B | 500 | 350 |
| | 5/16 | 1/2-20 | 17.0 | 10 | 21 | 19 | 5FNMTXS | 5FNMTXSS | 5 FNTX-B | 420 | 350 |
| 10 | 3/8 | 9/16-18 | 19.0 | 12 | 21 | 31 | 6FNMTXS | 6FNMTXSS | 6 FNTX-B | 420 | 350 |
| | 1/2 | 3/4-16 | 22.0 | 14 | 23 | 45 | 8FNMTXS | 8FNMTXSS | 8 FNTX-B | 420 | 350 |
| 14, 15, 16 | 5/8 | 7/8-14 | 27.0 | 14 | 27 | 75 | 10FNMTXS | 10FNMTXSS | 10 FNTX-B | 350 | 350 |
| | 3/4 | 1 1/16-12 | 32.0 | 17 | 30 | 114 | 12FNMTXS | 12FNMTXSS | 12 FNTX-B | 350 | 350 |
| 18, 20 | 7/8 | 1 3/16-12 | 35.0 | 16 | 32 | 133 | 14 FNTX-S | 14FNMTXSS | 14 FNTX-B | 310 | 280 |
| | 1 | 1 5/16-12 | 41.0 | 16 | 33 | 200 | 16FNMTXS | 16FNMTXSS | 16 FNTX-B | 310 | 280 |
| 25 | 1 1/4 | 1 5/8-12 | 50.0 | 19 | 37 | 272 | 20FNMTXS | 20FNMTXSS | 20 FNTX-B | 280 | 210 |
| | 1 1/2 | 1 7/8-12 | 60.0 | 24 | 45 | 553 | 24FNMTXS | 24FNMTXSS | 24 FNTX-B | 210 | 140 |
| 28, 30, 32 | 2 | 2 1/2-12 | 73.0 | 28 | 52 | 930 | 32 FNTX-S | | | 140 | — |
| | 35, 38 | | | | | | | | | | |

Order codes shown are part of our current manufacturing programme.

Imperial and metric parts may vary in hexagon dimensions.

$$\frac{\text{PN (bar)}}{10} = \text{PN (MPa)}$$

Pressure ratings – PN shown, apply to Steel and Stainless Steel versions of the product.

For Brass parts reduce pressures by 35 %.

Do not create drawings from these dimensions, they are subject to change and ISO manufacturing allowances.

PNMTX Plug

Triple-Lok® 37° Flare end plug
SAE 070109 MS51518

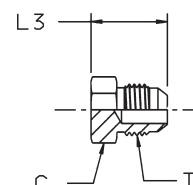

| Tube O.D. | | Thread UN/UNF-2A T | C mm | L mm | Weight (steel) g/1 piece | Triple-Lok® Steel | Triple-Lok® Stainless Steel | PN (bar) | |
|------------|-------|--------------------|-------|------|--------------------------|-------------------|-----------------------------|----------|-----|
| mm | in. | | | | | | | S | SS |
| 6 | 1/8 | 5/16-24 | 11.00 | 18 | 9 | 2 PNTX-S | | 500 | — |
| | 3/16 | 3/8-24 | 11.00 | 19 | 10 | 3 PNTX-S | | 500 | — |
| | 1/4 | 7/16-20 | 13.00 | 21 | 10 | 4PNMTXS | 4PNMTXSS | 500 | 350 |
| | 5/16 | 1/2-20 | 14.00 | 21 | 14 | 5PNMTXS | 5PNMTXSS | 420 | 350 |
| 8 | 3/8 | 9/16-18 | 16.00 | 21 | 19 | 6 PNTX-S | 6PNMTXSS | 420 | 350 |
| 12 | 1/2 | 3/4-16 | 19.00 | 24 | 39 | 8PNMTXS | 8PNMTXSS | 420 | 350 |
| | 5/8 | 7/8-14 | 24.00 | 28 | 60 | 10PNMTXS | 10PNMTXSS | 350 | 350 |
| 14, 15, 16 | 3/4 | 1 1/16-12 | 27.00 | 33 | 93 | 12PNMTXS | 12PNMTXSS | 350 | 350 |
| | 7/8 | 1 3/16-12 | 31.75 | 33 | 95 | 14 PNTX-S | 14PNMTXSS | 280 | 280 |
| 18, 20 | 1 | 1 5/16-12 | 35.00 | 34 | 98 | 16 PNTX-S | 16PNMTXSS | 280 | 280 |
| 22 | 1 1/4 | 1 5/8-12 | 42.80 | 37 | 269 | 20 PNTX-S | 20PNMTXSS | 280 | 210 |
| | 7/8 | 1 7/8-12 | 51.00 | 42 | 360 | 24 PNTX-S | 24PNMTXSS | 210 | 140 |
| 25 | 2 | 2 1/2-12 | 66.60 | 52 | 470 | 32 PNTX-S | 32PNMTXSS | 140 | — |
| 28, 30, 32 | 1 1/4 | 1 5/8-12 | 42.80 | 37 | 269 | 20 PNTX-S | 20PNMTXSS | 280 | 210 |
| 35, 38 | 1 1/2 | 1 7/8-12 | 51.00 | 42 | 360 | 24 PNTX-S | 24PNMTXSS | 210 | 140 |
| | 2 | 2 1/2-12 | 66.60 | 52 | 470 | 32 PNTX-S | 32PNMTXSS | 140 | — |

Order codes shown are part of our current manufacturing programme.

Imperial and metric parts may vary in hexagon dimensions.

$$\frac{\text{PN (bar)}}{10} = \text{PN (MPa)}$$

Do not create drawings from these dimensions, they are subject to change and ISO manufacturing allowances.



Triple-Lok®

XHMLO Conversion union

Triple-Lok® 37° Flare End / O-Lok ORFS end

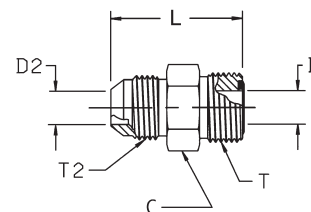

| Tube O.D. T2/T | | Thread UN/UNF-2A T2 | Thread UN/UNF-2A T | D mm | D2 mm | L mm | C mm | Weight (steel) g/1 piece | Triple-Lok® Steel | Triple-Lok® Stainless Steel | PN (bar) | |
|-------------------|-----------|---------------------------|--------------------------|---------|----------|---------|---------|--------------------------------|----------------------|--------------------------------|----------|-----|
| mm | in. | | | | | | | | | | S | SS |
| 6 | 1/4 | 7/16-20 | 9/16-18 | 4.4 | 4.4 | 32 | 16.00 | 29 | 4 XHLO-S | 4XHMLOSS | 500 | 350 |
| 8, 10 | 5/16, 3/8 | 9/16-18 | 11/16-16 | 6.7 | 6.7 | 34 | 19.00 | 45 | 6 XHLO-S | 6XHMLOSS | 420 | 350 |
| 12 | 1/2 | 3/4-16 | 13/16-16 | 9.6 | 10.0 | 39 | 22.20 | 70 | 8 XHLO-S | 8XHMLOSS | 420 | 350 |
| 14, 15, 16 | 5/8 | 7/8-14 | 1-14 | 12.3 | 12.3 | 46 | 27.00 | 119 | 10 XHLO-S | 10XHMLOSS | 350 | 350 |
| 18, 20 | 3/4 | 1 1/16-12 | 1 3/16-12 | 15.5 | 15.5 | 52 | 31.75 | 181 | 12 XHLO-S | 12XHMLOSS | 350 | 350 |
| 22, 25 | 1 | 1 5/16-12 | 1 7/16-12 | 20.5 | 20.5 | 55 | 38.00 | 265 | 16 XHLO-S | 16XHMLOSS | 280 | 280 |
| 28, 30, 32 | 1 1/4 | 1 5/8-12 | 1 11/16-12 | 26.0 | 26.0 | 58 | 44.45 | 383 | 20 XHLO-S | 20XHMLOSS | 280 | 210 |
| 35, 38 | 1 1/2 | 1 7/8-12 | 2-12 | 32.0 | 32.0 | 63 | 54.00 | 562 | 24 XHLO-S | 24XHMLOSS | 210 | 140 |

Steel, stainless steel and brass Triple-Lok® parts are delivered with NBR elastomeric seals as standard. For more details on other seal materials see page K92.

Order codes shown are part of our current manufacturing programme.

Imperial and metric parts may vary in hexagon dimensions.

$$\frac{\text{PN (bar)}}{10} = \text{PN (MPa)}$$

Do not create drawings from these dimensions, they are subject to change and ISO manufacturing allowances.

XHML6 Conversion swivel nut connector

Triple-Lok® 37° Flare end / O-Lok ORFS female swivel end

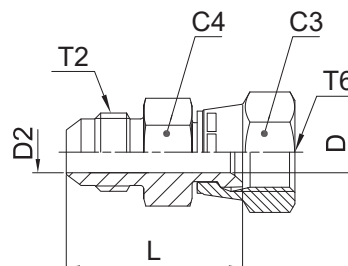

| Tube O.D. T2/T6 | | Thread UN/UNF-2A T2 | Thread UN/UNF-2B T6 | C3 | D | D2 | L | C4 | Weight (steel) g/1 piece | Triple-Lok® Steel | Triple-Lok® Stainless Steel | PN (bar) | |
|--------------------|-----------|---------------------------|---------------------------|------|------|------|----|------|--------------------------------|----------------------|--------------------------------|----------|-----|
| mm | in. | | | mm | mm | mm | mm | mm | | | | S | SS |
| 6 | 1/4 | 7/16-20 | 9/16-18 | 17.5 | 4.2 | 4.2 | 38 | 16.0 | 29 | 4 XHL6-S | 4XHML6SS | 500 | 350 |
| 8, 10 | 5/16, 3/8 | 9/16-18 | 11/16-16 | 20.6 | 6.7 | 6.7 | 41 | 19.0 | 46 | 6 XHL6-S | 6XHML6SS | 420 | 350 |
| 12 | 1/2 | 3/4-16 | 13/16-16 | 23.8 | 9.0 | 9.0 | 48 | 22.2 | 73 | 8 XHL6-S | 8XHML6SS | 420 | 350 |
| 14, 15, 16 | 5/8 | 7/8-14 | 1-14 | 28.6 | 11.5 | 11.5 | 56 | 27.0 | 126 | 10 XHL6-S | 10XHML6SS | 350 | 350 |
| 18, 20 | 3/4 | 1 1/16-12 | 1 3/16-12 | 35.0 | 14.0 | 14.0 | 64 | 31.8 | 205 | 12 XHL6-S | 12XHML6SS | 350 | 350 |
| 22, 25 | 1 | 1 5/16-12 | 1 7/16-12 | 41.3 | 19.8 | 19.8 | 68 | 38.0 | 285 | 16 XHL6-S | 16XHML6SS | 280 | 280 |
| 28, 30, 32 | 1 1/4 | 1 5/8-12 | 1 11/16-12 | 47.6 | 26.0 | 26.0 | 71 | 43.0 | 360 | 20 XHL6-S | 20XHML6SS | 280 | 280 |

Order codes shown are part of our current manufacturing programme.

Imperial and metric parts may vary in hexagon dimensions.

$$\frac{\text{PN (bar)}}{10} = \text{PN (MPa)}$$

Do not create drawings from these dimensions, they are subject to change and ISO manufacturing allowances.

K

Triple-Lok®

LOHMX6 Conversion swivel nut connector

Triple-Lok® 37° Flare female swivel end / O-Lok ORFS end

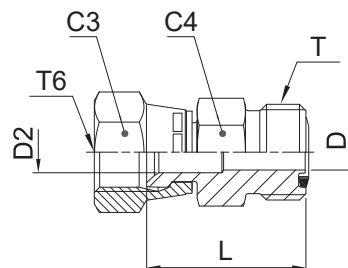

| Tube O.D. T6/T | | Thread UN/UNF-2B T6 | Thread UN/UNF-2A T | C3 mm | D mm | D2 mm | C4 mm | L mm | Weight (steel) g/1 piece | Triple-Lok® Steel | Triple-Lok® Stainless Steel | PN (bar) | |
|-------------------|-----------|---------------------------|--------------------------|----------|---------|----------|----------|---------|--------------------------------|----------------------|--------------------------------|----------|-----|
| mm | in. | | | | | | | | | | | S | SS |
| 6 | 1/4 | 7/16-20 | 9/16-18 | 14.3 | 4.4 | 4.4 | 16 | 24.0 | 26 | 4 LOHX6-S | 4LOHMX6SS | 500 | 350 |
| 8, 10 | 5/16, 3/8 | 9/16-18 | 11/16-16 | 17.5 | 6.7 | 6.7 | 19 | 30.0 | 40 | 6 LOHX6-S | 6LOHMX6SS | 350 | 350 |
| 12 | 1/2 | 3/4-16 | 13/16-16 | 22.2 | 9.5 | 9.5 | 22 | 34.0 | 63 | 8 LOHX6-S | 8LOHMX6SS | 350 | 350 |
| 14, 15, 16 | 5/8 | 7/8-14 | 1-14 | 25.4 | 12.3 | 12.3 | 27 | 39.0 | 103 | 10 LOHX6-S | 10LOHMX6SS | 350 | 350 |
| 18, 20 | 3/4 | 1 1/16-12 | 1 3/16-12 | 31.8 | 15.5 | 15.5 | 32 | 31.8 | 162 | 12 LOHX6-S | 12LOHMX6SS | 350 | 350 |
| 22, 25 | 1 | 1 5/16-12 | 1 7/16-12 | 38.0 | 20.5 | 20.5 | 38 | 46.0 | 229 | 16 LOHX6-S | 16LOHMX6SS | 250 | 250 |

Steel, stainless steel and brass Triple-Lok® parts are delivered with NBR elastomeric seals as standard. For more details on other seal materials see page K92.

Order codes shown are part of our current manufacturing programme.

Imperial and metric parts may vary in hexagon dimensions.

$$\frac{\text{PN (bar)}}{10} = \text{PN (MPa)}$$

Do not create drawings from these dimensions, they are subject to change and ISO manufacturing allowances.

WLNМ Bulkhead locknut

Bulkhead fitting locknut
SAE 080118 MS51860

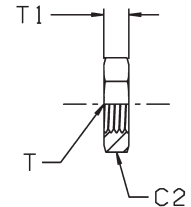

| Thread UN/UNF-2B T | C2 mm | T1 mm | Weight (steel) g/1 piece | Triple-Lok® Steel | Triple-Lok® Stainless Steel | Triple-Lok® Brass |
|--------------------------|----------|----------|--------------------------------|----------------------|--------------------------------|----------------------|
| 3/8-24 | 17 | 6 | 9 | 3 WLN-S | | |
| 7/16-20 | 17 | 7 | 9 | 4WLNMS | 4WLNМSS | 4WLNMB |
| 1/2-20 | 19 | 7 | 9 | 5WLNMS | 5WLNМSS | 5WLNMB |
| 9/16-18 | 22 | 7 | 11 | 6WLNMS | 6WLNМSS | 6WLNMB |
| 3/4-16 | 24 | 8 | 18 | 8WLNMS | 8WLNМSS | 8WLNMB |
| 7/8-14 | 30 | 9 | 24 | 10WLNMS | 10WLNМSS | 10WLNMB |
| 1 1/16-12 | 36 | 10 | 42 | 12WLNMS | 12WLNМSS | 12WLNMB |
| 1 3/16-12 | 38 | 10 | 45 | 14 WLN-S | 14WLNМSS | 14WLNMB |
| 1 5/16-12 | 41 | 10 | 49 | 16WLNMS | 16WLNМSS | 16WLNMB |
| 1 5/8-12 | 50 | 10 | 50 | 20WLNMS | 20WLNМSS | 20WLNMB |
| 1 7/8-12 | 55 | 10 | 68 | 24WLNMS | 24WLNМSS | 24WLNMB |
| 2 1/2-12 | 70 | 10 | 80 | 32 WLN-S | | |

Order codes shown are part of our current manufacturing programme.

Imperial and metric parts may vary in hexagon dimensions.

Do not create drawings from these dimensions, they are subject to change and ISO manufacturing allowances.

K

Triple-Lok®
Spare parts guide – Triple-Lok® retaining rings and seals
BSPB male threads – ISO 1179

| BSPB Thread | ED seal Order code | | O-ring order code* | | O-ring ID × section mm | Retainer ring Order code Steel | Retainer ring Order code Stainless Steel | Copper washer Order code |
|-------------|--------------------|--------------|--------------------|--------------|------------------------|--------------------------------|--|--------------------------|
| | NBR | FKM | NBR | FKM | | | | |
| 1/8 | ED10X1X | ED10X1VITX | 6-002-N552-9 | 6-002-V894-9 | 8.00 × 2.00 | 8207-1/8 | 8207SS1/8 | - |
| 1/4 | ED14X1.5X | ED14X1.5VITX | 2-111-N552-9 | 2-111-V894-9 | 10.77 × 2.62 | 8207-1/4 | 8207SS1/4A | M25180 |
| 3/8 | ED3/8X | ED3/8VITX | 2-113-N552-9 | 2-113-V894-9 | 13.94 × 2.62 | 8207-3/8 | 8207SS3/8A | - |
| 1/2 | ED1/2X | ED1/2VITX | 5-256-N552-9 | 5-256-V894-9 | 17.96 × 2.62 | 8207-1/2 | 8207SS1/2 | M25182 |
| 3/4 | ED26X1.5X | ED26X1.5VITX | 2-119-N552-9 | 2-119-V894-9 | 23.47 × 2.62 | 8207-3/4 | 8207SS3/4 | - |
| 1 | ED33X2X | ED33X2VITX | 2-217-N552-9 | 2-217-V894-9 | 29.74 × 3.53 | 8207-1 | 8207SS1A | - |
| 1 1/4 | ED42X2X | ED42X2VITX | 2-222-N552-9 | 2-222-V894-9 | 37.69 × 3.53 | 8207-1-1/4 | 8207SS1 1/4 | - |
| 1 1/2 | ED48X2X | ED48X2VITX | 2-224-N552-9 | 2-224-V894-9 | 44.04 × 3.53 | 8207-1-1/2 | 8207SS1 1/2 | - |

Typical fittings using these parts: F42EDMX / F4OMX / C4OMX / V4OMX etc.

* Must be used with correct retainer ring

Metric male threads – ISO 9974

| Metric Thread | ED seal order code | | O-ring Order code* | | O-ring ID × section mm | Retainer ring Order code Steel | Retainer ring Order code Stainless Steel |
|---------------|--------------------|--------------|--------------------|--------------|------------------------|--------------------------------|--|
| | NBR | FKM | NBR | FKM | | | |
| M 10×1.0 | ED10X1X | ED10X1VITX | 6-074-N552-9 | 6-074-V894-9 | 8.00 × 1.50 | M10RR | RRM10X1SS |
| M 12×1.5 | ED12X1.5X | ED12X1.5VITX | 2-012-N552-9 | 2-012-V894-9 | 9.25 × 1.78 | M12RR | RRM12X1.5SS |
| M 14×1.5 | ED14X1.5X | ED14X1.5VITX | 2-013-N552-9 | 2-013-V894-9 | 10.82 × 1.78 | M14RR | RRM14X1.5SS |
| M 16×1.5 | ED16X1.5X | ED16X1.5VITX | 3-907-N552-9 | 3-907-V894-9 | 13.46 × 2.08 | M16RR | RRM16X1.5SS |
| M 18×1.5 | ED18X1.5X | ED18X1.5VITX | 2-114-N552-9 | 2-114-V894-9 | 15.54 × 2.62 | M18RR | RRM18X1.5SS |
| M 22×2.0 | ED22X1.5X | ED22X1.5VITX | 2-018-N552-9 | 2-018-V894-9 | 18.77 × 1.78 | M22RR | RRM22X1.5SS |
| M 27×2.0 | ED26X1.5X** | ED26X1.5VITX | 2-119-N552-9 | 2-119-V894-9 | 23.47 × 2.62 | M27RR | RRM27X2SS |
| M 33×2.0 | ED33X2X | ED33X2VITX | 2-122-N552-9 | 2-122-V894-9 | 28.24 × 2.62 | M33RR | RRM33X2SS |
| M 42×2.0 | ED42X2X | ED42X2VITX | 2-128-N552-9 | 2-128-V894-9 | 37.77 × 2.62 | M42RR | RRM42X2SS |
| M 48×2.0 | ED48X2X | ED48X2VITX | 2-132-N552-9 | 2-132-V894-9 | 44.12 × 2.62 | M48RR | RRM48X2SS |

Typical fittings using these parts: F82EDMX / F8OMX / C8OMX / V8OMX etc.

* Must be used with correct retainer ring

** Same seal used for M 26×1.5 and M 27×2.0 Threads

UN / UNF male threads – ISO 11926

| UN / UNF Thread | Dash size | O-ring Order code | | O-Ring ID × section (mm) |
|-----------------|-----------|-------------------|--------------|--------------------------|
| | | NBR | FKM | |
| 5/16-24 | 2 | 3-902-N552-9 | 3-902-V894-9 | 6.07 × 1.63 |
| 3/8-24 | 3 | 3-903-N552-9 | 3-903-V894-9 | 7.65 × 1.63 |
| 7/16-20 | 4 | 3-904-N552-9 | 3-904-V894-9 | 8.92 × 1.83 |
| 1/2-20 | 5 | 3-905-N552-9 | 3-905-V894-9 | 10.52 × 1.83 |
| 9/16-18 | 6 | 3-906-N552-9 | 3-906-V894-9 | 11.89 × 1.98 |
| 3/4-16 | 8 | 3-908-N552-9 | 3-908-V894-9 | 16.36 × 2.21 |
| 7/8-14 | 10 | 3-910-N552-9 | 3-910-V894-9 | 19.18 × 2.46 |
| 1 1/16-12 | 12 | 3-912-N552-9 | 3-912-V894-9 | 23.47 × 2.95 |
| 1 3/16-12 | 14 | 3-914-N552-9 | 3-914-V894-9 | 26.59 × 2.95 |
| 1 5/16-12 | 16 | 3-916-N552-9 | 3-916-V894-9 | 29.74 × 2.95 |
| 1 5/8-12 | 20 | 3-920-N552-9 | 3-920-V894-9 | 37.47 × 3.00 |
| 1 7/8-12 | 24 | 3-924-N552-9 | 3-924-V894-9 | 43.69 × 3.00 |
| 2 1/2-12 | 32 | 3-932-N552-9 | 3-932-V894-9 | 59.36 × 3.00 |

Typical fittings using these parts: F5OMX / C5OMX / R5OMX etc.

Metric male threads – ISO 6149

| Metric Thread | O-ring Order code | | O-Ring ID × section (mm) |
|---------------|-------------------|--------------|--------------------------|
| | NBR | FKM | |
| M 10×1.0 | 6-345-N552-9 | 6-345-V894-9 | 8.20 × 1.50 |
| M 12×1.5 | 6-346-N552-9 | 6-346-V894-9 | 9.40 × 2.10 |
| M 14×1.5 | 6-347-N552-9 | 6-347-V894-9 | 11.40 × 2.10 |
| M 16×1.5 | 6-348-N552-9 | 6-348-V894-9 | 13.40 × 2.10 |
| M 18×1.5 | 6-349-N552-9 | 6-349-V894-9 | 15.40 × 2.10 |
| M 22×1.5 | 6-350-N552-9 | 6-350-V894-9 | 19.40 × 2.10 |
| M 27×2.0 | 6-351-N552-9 | 6-351-V894-9 | 23.70 × 2.80 |
| M 33×2.0 | 6-352-N552-9 | 6-352-V894-9 | 29.70 × 2.80 |
| M 42×2.0 | 6-353-N552-9 | 6-353-V894-9 | 38.70 × 2.80 |
| M 48×2.0 | 6-354-N552-9 | 6-354-V894-9 | 46.70 × 2.80 |

Typical fittings using these parts: F87OMX / S87OMX etc.

Other seal compounds available on request for alternative applications















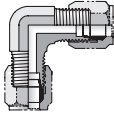
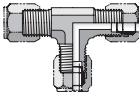

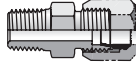
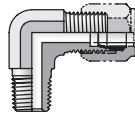
Ferulok[®] Flareless

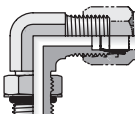
Bite Type Fittings

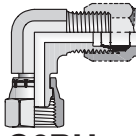
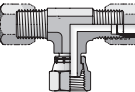
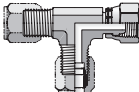

Ferulok®

Visual index

| | | | | | |
|---|---|---|---|---|---|
| Tube-Tube |  |  |  | | |
| | HBU p. L6 | EBU p. L6 | JBU p. L7 | | |
| Bulkhead unions |  | | | | |
| | WBU p. L7 | | | | |
| Tube to male NPTF |  |  | | | |
| | FBU p. L11 | CBU p. L12 | | | |
| Tube to straight thread UNF |  |  | | | |
| | F5BU p. L10 | C5BU p. L12 | | | |
| Tube to female NPTF |  | | | | |
| | GBU p. L13 | | | | |
| Tube to Flareless Swivel |  |  |  | | |
| | C6BU p. L8 | S6BU p. L8 | R6BU p. L9 | | |
| Nuts & Sleeves Reducers, Caps & Plugs |  |  |  |  |  |
| | BU p. L5 | TU p. L5 | TRBU p. L9 | FNU p. L13 | PNU p. L14 |



Ferulok®

How to order Ferulok® fittings

Example Order code **12-8 FB U S**

1 2 3 4 5 6 7 8

1 Order codes for tube and port thread ends

| Dash Size | Tube Size (inch) | Tube Size (mm) | Port Thread Size (inch) BSPP/BSPT/NPT | Port Thread Size UN / UNF |
|-----------|------------------|----------------|---------------------------------------|---------------------------|
| 4 | 1/4 | 6 | 1/4 | 7/16-20 |
| 5 | | | | 1/2-20 |
| 6 | 3/8 | 8,10 | 3/8 | 9/16-18 |
| 8 | 1/2 | 12 | 1/2 | 3/4-16 |
| 10 | 5/8 | 14,15,16 | 5/8 | 7/8-14 |
| 12 | 3/4 | 18,20 | 3/4 | 1 1/6-12 |
| 14 | | | | 1 3/6-12 |
| 16 | 1 | 25 | 1 | 1 5/6-12 |
| 20 | 1 1/4 | 28,30,32 | 1 1/4 | 1 5/8-12 |
| 24 | 1 1/2 | 35,38 | 1 1/2 | 1 7/8-12 |
| 32 | 2 | 50 | 2 | 2 1/2-12 |

Example:

stud adaptor with nut and ferrule - 3/4" tube to 1/2" NPT port 12-8 FBU-S

2 Codes for fitting styles/shapes

| Code | Description |
|--------|-----------------------------------|
| AE6 | Straight Thread Swivel |
| B | Nut |
| C | Male Stud elbow |
| CC | Extended Male Stud elbow |
| C6 | Swivel Nut Elbow |
| E | Union elbow |
| F | Male Stud connector |
| FF | Extended Male Stud connector |
| F6 | Male Stud Swivel |
| FN | Cap |
| FNLBAS | Bleed Adapter Cap |
| G | Female Connector |
| H | Straight union |
| H6 | Swivel/Swivel Adapter |
| J | Union Tee |
| K | Union Cross |
| LOHB3 | Braze Adapter |
| LOHX6 | Triple-Lok® Swivel/O-Lok® adaptor |
| M | Female Run Tee |
| O | Female Branch Tee |
| PN | Plug |
| PNLOBA | Bleed Adapter Plug |
| R | Male Stud Run Tee |
| R6 | Swivel Run Tee |
| S | Male Stud Branch Tee |
| S6 | Swivel Branch Tee |
| SBR | Braze Ring |
| TPL | Parflange® sleeve |
| TL | Brazed sleeve |
| TR | Tube End Reducer |
| TT | Test Point Adapter |
| TW3 | Weld Nipple |
| V | 45° male stud elbow |
| V6 | Swivel Nut 45° Elbow |
| W | Bulkhead Union |
| WE | Bulkhead Union Elbow |
| WJJ | Bulkhead Run Tee |
| WJT | Bulkhead Branch Tee |
| WLNML | Bulkhead Locknut |
| WN | Bulkhead 45° union elbow |
| XHL6 | Triple Lok®/Swivel O-Lok® adaptor |
| XHLO | Triple Lok®/O-Lok® male adaptor |

3 Threads and sealing methods

| Code | Description |
|------|--|
| None | NPT/NPTF Thread |
| 3 | BSPT Thread |
| 4 | BSPP Thread O-Ring & Retainer Ring |
| 42 | BSPP Thread EOLASTIC seal 'ED' |
| 5 | UN/UNF Thread (O-Ring Seal) |
| 8 | Metric Thread O-Ring & Retainer Ring |
| 82 | Metric Thread EOLASTIC seal 'ED' |
| 87 | Metric ISO 6149 Thread (O-Ring Seal) |
| 63 | Swivel Connector BSPT end |
| 64 | Swivel Connector BSPP end (O-Ring & Retainer Ring) |
| 642 | Swivel Connector BSPP end (EOLASTIC Seal 'ED') |
| 65 | Swivel Connector UN/UNF end (O-Ring seal) |
| 68 | Swivel Connector Metric end (O-Ring & Retainer Ring) |
| 682 | Swivel Connector Metric end (EOLASTIC Seal 'ED') |
| 687 | Swivel Connector Metric ISO 6149 end |

4 Stud connector seal

| Code | Description |
|---------|--|
| O | O-Ring Seal (Assembled on fitting) |
| ED | Captive EOLASTIC Seal (Assembled on fitting) |
| No Code | No Seal (O-Ring not assembled on fitting) |

5 Hexagon/ Across flats style

| Code | Description |
|---------|--------------------------|
| M | Metric Hexagon Dimension |
| No Code | inch Hexagon Dimension |

6 Fitting type

| Code | Description |
|------|-----------------|
| U | Parker Ferulok® |

7 Tube connection seal ORFS

| Code | Description |
|---------|------------------------------------|
| O | O-Ring Seal (Assembled on Fitting) |
| No Code | No Seal/O-Ring |

8 Fitting material

| Code | Description |
|------|-----------------|
| S | Steel |
| SS | Stainless Steel |
| B | Brass |

BU Nut

Flareless
SAE 080110

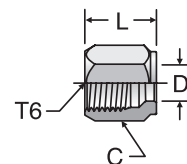

| Tube O.D. inch | Thread UN/UNF-2B T6 | Hex C inch | Drill D inch | L inch | Weight steel g/1 piece | Ferulok® steel | Ferulok® stainless steel |
|----------------|---------------------|------------|--------------|--------|------------------------|----------------|--------------------------|
| 1/8 | 5/16-24 | 3/8 | 0.13 | 0.53 | 5 | 2 BU-S | 2 BU-SS |
| 3/16 | 3/8-24 | 7/16 | 0.19 | 0.61 | 5 | 3 BU-S | 3 BU-SS |
| 1/4 | 7/16-20 | 9/16 | 0.26 | 0.70 | 14 | 4 BU-S | 4 BU-SS |
| 3/8 | 9/16-18 | 11/16 | 0.38 | 0.75 | 18 | 6 BU-S | 6 BU-SS |
| 1/2 | 3/4-16 | 7/8 | 0.51 | 0.84 | 32 | 8 BU-S | 8 BU-SS |
| 5/8 | 7/8-14 | 1 | 0.63 | 0.92 | 41 | 10 BU-S | 10 BU-SS |
| 3/4 | 1 1/16-12 | 1 1/4 | 0.76 | 0.97 | 73 | 12 BU-S | 12 BU-SS |
| 1 | 1 5/16-12 | 1 1/2 | 1.01 | 1.05 | 104 | 16 BU-S | 16 BU-SS |
| 1 1/4 | 1 5/8-12 | 2 | 1.26 | 1.05 | 222 | 20 BU-S | 20 BU-SS |
| 1 1/2 | 1 7/8-12 | 2 1/4 | 1.51 | 1.03 | 254 | 24 BU-S | 24 BU-SS |

TU Ferrule

Flareless
SAE 08115A

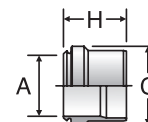

| Tube O.D. inch | C inch | A inch | H inch | Ferulok® steel | Ferulok® stainless steel |
|----------------|--------|--------|--------|----------------|--------------------------|
| 1/8 | 0.24 | 0.13 | 0.29 | 2 TU-S | 2 TU-SS |
| 3/16 | 0.31 | 0.19 | 0.33 | 3 TU-S | 3 TU-SS |
| 1/4 | 0.37 | 0.26 | 0.36 | 4 TU-S | 4 TU-SS |
| 3/8 | 0.5 | 0.38 | 0.39 | 6 TU-S | 6 TU-SS |
| 1/2 | 0.66 | 0.51 | 0.43 | 8 TU-S | 8 TU-SS |
| 5/8 | 0.78 | 0.63 | 0.44 | 10 TU-S | 10 TU-SS |
| 3/4 | 0.93 | 0.76 | 0.48 | 12 TU-S | 12 TU-SS |
| 1 | 1.19 | 1.01 | 0.48 | 16 TU-S | 16 TU-SS |
| 1 1/4 | 1.45 | 1.26 | 0.48 | 20 TU-S | 20 TU-SS |
| 1 1/2 | 1.69 | 1.51 | 0.48 | 24 TU-S | 24 TU-SS |

Ferulok®
HBU Union

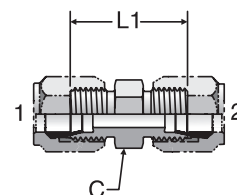
 Flareless / Flareless
 SAE 080101

| Tube O.D. End 1 inch | Tube O.D. End 2 inch | Hex C inch | L1 inch | Weight steel g/1 piece | Ferulok® steel | Ferulok® stainless steel | Pressure steel bar | Pressure stainless steel bar |
|----------------------------|----------------------------|------------------|------------|------------------------------|-------------------|-----------------------------|--------------------------|------------------------------------|
| 1/8 | 1/8 | 7/16 | 1.02 | 18 | 2 HBU-S | 2 HBU-SS | 413 | 413 |
| 3/16 | 3/16 | 7/16 | 1.11 | 23 | 3 HBU-S | 3 HBU-SS | 413 | 413 |
| 1/4 | 1/4 | 1/2 | 1.19 | 41 | 4 HBU-S | 4 HBU-SS | 413 | 413 |
| 3/8 | 3/8 | 5/8 | 1.24 | 64 | 6 HBU-S | 6 HBU-SS | 413 | 413 |
| 1/2 | 1/2 | 13/16 | 1.42 | 109 | 8 HBU-S | 8 HBU-SS | 345 | 345 |
| 5/8 | 5/8 | 15/16 | 1.61 | 150 | 10 HBU-S | 10 HBU-SS | 345 | 345 |
| 3/4 | 3/4 | 1 1/8 | 1.81 | 281 | 12 HBU-S | 12 HBU-SS | 310 | 310 |
| 1 | 1 | 1 3/8 | 1.81 | 400 | 16 HBU-S | 16 HBU-SS | 276 | 276 |
| 1 1/4 | 1 1/4 | 1 11/16 | 1.89 | 658 | 20 HBU-S | 20 HBU-SS | 207 | 207 |
| 1 1/2 | 1 1/2 | 2 | 1.96 | 785 | 24 HBU-S | 24 HBU-SS | 138 | 138 |

EBU Union Elbow

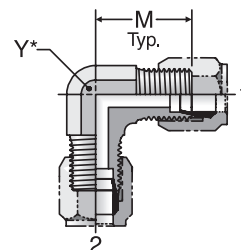
 Flareless / Flareless
 SAE 080201

| Tube O.D. End 1 inch | Tube O.D. End 2 inch | M inch | Y inch | Weight steel g/1 piece | Ferulok® steel | Ferulok® stainless steel | Pressure steel bar | Pressure stainless steel bar |
|----------------------------|----------------------------|-----------|-----------|------------------------------|-------------------|-----------------------------|--------------------------|------------------------------------|
| 1/4 | 1/4 | 0.89 | 7/16 | 50 | 4 EBU-S | 4 EBU-SS | 345 | 345 |
| 3/8 | 3/8 | 1.05 | 9/16 | 86 | 6 EBU-S | 6 EBU-SS | 345 | 345 |
| 1/2 | 1/2 | 1.25 | 3/4 | 150 | 8 EBU-S | 8 EBU-SS | 345 | 345 |
| 5/8 | 5/8 | 1.42 | 7/8 | 218 | 10 EBU-S | 10 EBU-SS | 310 | 310 |
| 3/4 | 3/4 | 1.58 | 1 1/16 | 350 | 12 EBU-S | 12 EBU-SS | 276 | 276 |
| 1 | 1 | 1.73 | 1 5/16 | 518 | 16 EBU-S | 16 EBU-SS | 207 | 207 |
| 1 1/4 | 1 1/4 | 1.89 | 1 5/8 | 981 | 20 EBU-S | 20 EBU-SS | 172 | 172 |
| 1 1/2 | 1 1/2 | 2.02 | 1 7/8 | 1189 | 24 EBU-S | 24 EBU-SS | 138 | 138 |

JBU Union Tee

Flareless (all three ends)
SAE 080401

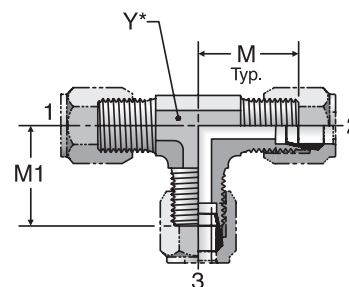

| Tube O.D. End 1 inch | Tube O.D. End 2 inch | Tube O.D. End 3 inch | M inch | M1 inch | Y inch | Weight steel g/1 piece | Ferulok® steel | Ferulok® stainless steel | Pressure steel bar | Pressure stainless steel bar |
|----------------------------|----------------------------|----------------------------|-----------|------------|-----------|---------------------------|-------------------|-----------------------------|--------------------------|------------------------------------|
| 1/4 | 1/4 | 1/4 | 0.89 | 0.89 | 7/16 | 77 | 4 JBU-S | 4 JBU-SS | 345 | 345 |
| 3/8 | 3/8 | 3/8 | 1.05 | 1.05 | 9/16 | 123 | 6 JBU-S | 6 JBU-SS | 345 | 345 |
| 1/2 | 1/2 | 1/2 | 1.25 | 1.25 | 3/4 | 104 | 8 JBU-S | 8 JBU-SS | 345 | 345 |
| 5/8 | 5/8 | 5/8 | 1.42 | 1.42 | 7/8 | 300 | 10 JBU-S | 10 JBU-SS | 310 | 310 |
| 3/4 | 3/4 | 3/4 | 1.58 | 1.58 | 1 1/16 | 518 | 12 JBU-S | 12 JBU-SS | 276 | 276 |
| 1 | 1 | 1 | 1.73 | 1.73 | 1 5/16 | 713 | 16 JBU-S | 16 JBU-SS | 207 | 207 |
| 1 1/4 | 1 1/4 | 1 1/4 | 1.89 | 1.89 | 1 5/8 | 1312 | 20 JBU-S | 20 JBU-SS | 172 | 172 |
| 1 1/2 | 1 1/2 | 1 1/2 | 2.02 | 2.02 | 1 7/8 | 1580 | 24 JBU-S | 24 JBU-SS | 138 | 138 |

WBU Bulkhead Union

Flareless / Flareless
SAE 080601

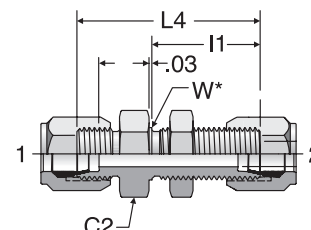

| Tube O.D. End 1 inch | Tube O.D. End 2 inch | Hex C2 inch | l1 inch | L4 inch | W inch | Weight steel g/1 piece | Ferulok® steel | Ferulok® stainless steel | Pressure steel bar | Pressure stainless steel bar |
|----------------------------|----------------------------|-------------------|------------|------------|-----------|------------------------------|-------------------|-----------------------------|--------------------------|------------------------------------|
| 1/4 | 1/4 | 11/16 | 1.12 | 1.89 | 0.44 | 68.10 | 4 WBU-S | 4 WBU-SS | 413 | 413 |
| 3/8 | 3/8 | 13/16 | 1.17 | 1.98 | 0.56 | 108.96 | 6 WBU-S | 6 WBU-SS | 413 | 413 |
| 1/2 | 1/2 | 1 | 1.31 | 2.22 | 0.75 | 167.98 | 8 WBU-S | 8 WBU-SS | 345 | 345 |
| 5/8 | 5/8 | 1 1/8 | 1.45 | 2.48 | 0.88 | 222.46 | 10 WBU-S | 10 WBU-SS | 345 | 345 |
| 3/4 | 3/4 | 1 3/8 | 1.55 | 2.72 | 1.06 | 372.28 | 12 WBU-S | 12 WBU-SS | 310 | 310 |
| 1 | 1 | 1 5/8 | 1.56 | 2.72 | 1.31 | 499.40 | 16 WBU-S | 16 WBU-SS | 276 | 276 |

Ferulok®

C6BU Swivel Nut Elbow

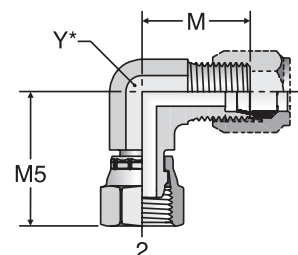
 Flareless / Flareless Swivel
 SAE 080221

| Tube O.D. End 1 inch | Tube O.D. End 2 inch | M inch | M5 inch | Y inch | Weight steel g/1 piece | Ferulok® steel | Ferulok® stainless steel | Pressure steel bar | Pressure stainless steel bar |
|----------------------------|----------------------------|-----------|------------|-----------|------------------------------|-------------------|-----------------------------|--------------------------|------------------------------------|
| 1/4 | 1/4 | 0.89 | 1.00 | 7/16 | 36 | 4 C6BU-S | 4 C6BU-SS | 345 | 345 |
| 3/8 | 3/8 | 1.05 | 1.25 | 9/16 | 64 | 6 C6BU-S | 6 C6BU-SS | 345 | 345 |
| 1/2 | 1/2 | 1.25 | 1.38 | 3/4 | 114 | 8 C6BU-S | 8 C6BU-SS | 345 | 345 |
| 5/8 | 5/8 | 1.42 | 1.62 | 7/8 | 159 | 10 C6BU-S | 10 C6BU-SS | 310 | 310 |
| 3/4 | 3/4 | 1.58 | 1.75 | 1 1/16 | 254 | 12 C6BU-S | 12 C6BU-SS | 276 | 276 |
| 1 | 1 | 1.73 | 2.00 | 1 5/16 | 381 | 16 C6BU-S | 16 C6BU-SS | 207 | 207 |
| 1 1/4 | 1 1/4 | 1.89 | 2.31 | 1 5/8 | 518 | 20 C6BU-S | 20 C6BU-SS | 172 | 172 |
| 1 1/2 | 1 1/2 | 2.02 | 2.42 | 1 7/8 | 531 | 24 C6BU-S | 24 C6BU-SS | 138 | 138 |

S6BU Swivel Nut Branch Tee

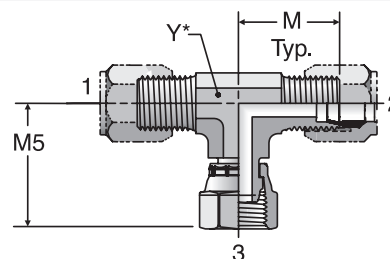
 Flareless / Flareless Swivel
 SAE 080202

| Tube O.D. End 1 inch | Tube O.D. End 2 inch | Tube O.D. End 3 inch | M inch | M5 inch | Y inch | Weight steel g/1 piece | Ferulok® steel | Ferulok® stainless steel | Pressure steel bar | Pressure stainless steel bar |
|----------------------------|----------------------------|----------------------------|-----------|------------|-----------|------------------------------|-------------------|-----------------------------|--------------------------|------------------------------------|
| 1/4 | 1/4 | 1/4 | 0.89 | 1.00 | 7/16 | 59 | 4 S6BU-S | 4 S6BU-SS | 345 | 345 |
| 3/8 | 3/8 | 3/8 | 1.05 | 1.25 | 9/16 | 95 | 6 S6BU-S | 6 S6BU-SS | 345 | 345 |
| 1/2 | 1/2 | 1/2 | 1.25 | 1.38 | 3/4 | 173 | 8 S6BU-S | 8 S6BU-SS | 345 | 345 |
| 3/4 | 3/4 | 3/4 | 1.58 | 1.75 | 1 1/16 | 390 | 12 S6BU-S | 12 S6BU-SS | 276 | 276 |
| 1 | 1 | 1 | 1.73 | 2.00 | 1 5/16 | 454 | 16 S6BU-S | 16 S6BU-SS | 207 | 207 |

R6BU Swivel Nut Run Tee

Flareless / Flareless Swivel
SAE 080432

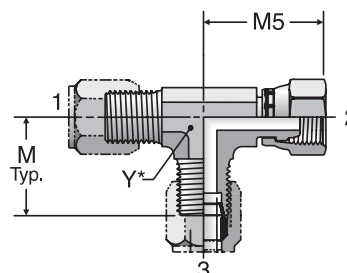

| Tube O.D. End 1 inch | Tube O.D. End 2 inch | Tube O.D. End 3 inch | M inch | M5 inch | Y inch | Weight steel g/1 piece | Ferulok® steel | Ferulok® stainless steel | Pressure steel bar | Pressure stainless steel bar |
|----------------------------|----------------------------|----------------------------|-----------|------------|-----------|------------------------------|-------------------|-----------------------------|--------------------------|------------------------------------|
| 1/4 | 1/4 | 1/4 | 0.89 | 1.00 | 7/16 | 59 | 4 R6BU-S | 4 R6BU-SS | 345 | 345 |
| 3/8 | 3/8 | 3/8 | 1.05 | 1.25 | 9/16 | 100 | 6 R6BU-S | 6 R6BU-SS | 345 | 345 |
| 1/2 | 1/2 | 1/2 | 1.25 | 1.38 | 3/4 | 177 | 8 R6BU-S | 8 R6BU-SS | 345 | 345 |
| 3/4 | 3/4 | 3/4 | 1.58 | 1.75 | 1 1/16 | 495 | 12 R6BU-S | 12 R6BU-SS | 276 | 276 |
| 1 | 1 | 1 | 1.73 | 2.00 | 1 5/16 | 826 | 16 R6BU-S | 16 R6BU-SS | 207 | 207 |

TRBU Tube End Reducer

Tube / Flareless
SAE 080123

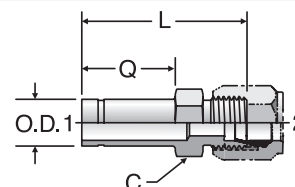

| Tube O.D. End 1 inch | Tube O.D. End 2 inch | Hex C inch | L inch | Q inch | Weight steel g/1 piece | Ferulok® steel | Ferulok® stainless steel | Pressure steel bar | Pressure stainless steel bar |
|----------------------------|----------------------------|------------------|-----------|-----------|------------------------------|---------------------|-----------------------------|--------------------------|------------------------------------|
| 3/8 | 1/4 | 1/2 | 1.61 | 0.88 | 27 | 6-4 TRBU-S | 6-4 TRBU-SS | 413 | 413 |
| 1/2 | 1/4 | 9/16 | 1.73 | 1 | 36 | 8-4 TRBU-S | 8-4 TRBU-SS | 345 | 345 |
| 1/2 | 3/8 | 5/8 | 1.77 | 1 | 45 | 8-6 TRBU-S | 8-6 TRBU-SS | 345 | 345 |
| 5/8 | 3/8 | 11/16 | 1.86 | 1.09 | 54 | 10-6 TRBU-S | 10-6 TRBU-SS | 345 | 345 |
| 5/8 | 1/2 | 13/16 | 1.95 | 1.09 | 73 | 10-8 TRBU-S | 10-8 TRBU-SS | 310 | 310 |
| 3/4 | 3/8 | 13/16 | 1.94 | 1.16 | 68 | 12-6 TRBU-S | 12-6 TRBU-SS | 310 | 310 |
| 3/4 | 1/2 | 13/16 | 2.03 | 1.16 | 77 | 12-8 TRBU-S | 12-8 TRBU-SS | 310 | 310 |
| 3/4 | 5/8 | 15/16 | 2.16 | 1.16 | 100 | 12-10 TRBU-S | 12-10 TRBU-SS | 310 | 310 |
| 1 | 1/2 | 1 1/16 | 2.05 | 1.13 | 114 | 16-8 TRBU-S | 16-8 TRBU-SS | 276 | 276 |
| 1 | 5/8 | 1 1/16 | 2.11 | 1.13 | 132 | 16-10 TRBU-S | 16-10 TRBU-SS | 276 | 276 |
| 1 | 3/4 | 1 1/8 | 2.25 | 1.13 | 168 | 16-12 TRBU-S | 16-12 TRBU-SS | 276 | 276 |
| 1 1/4 | 1 | 1 3/8 | 2.28 | 1.16 | 250 | 20-16 TRBU-S | 20-16 TRBU-SS | 207 | 207 |
| 1 1/2 | 3/4 | 1 5/8 | 2.45 | 1.25 | 268 | 24-12 TRBU-S | 24-12 TRBU-SS | 138 | 138 |
| 1 1/2 | 1 | 1 5/8 | 2.45 | 1.25 | 336 | 24-16 TRBU-S | 24-16 TRBU-SS | 138 | 138 |
| 1 1/2 | 1 1/4 | 1 7/8 | 2.45 | 1.25 | 440 | 24-20 TRBU-S | 24-20 TRBU-SS | 138 | 138 |

F5BU Straight Thread Connector

Flareless / SAE-ORB
SAE 080120

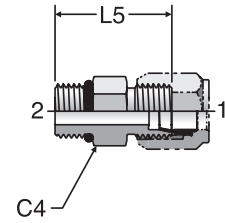

| End 1 inch | End 2 UN/UNF-2A inch | Hex C4 inch | L5 inch | Weight steel g/1 piece | Ferulok® steel | Ferulok® stainless steel | Pressure steel bar | Pressure stainless steel bar |
|---------------|----------------------------|-------------------|------------|------------------------------|-------------------|-----------------------------|--------------------------|------------------------------------|
| 1/4 | 7/16-20 | 9/16 | 1.13 | 27 | 4 F5BU-S | 4 F5BU-SS | 413 | 413 |
| 3/8 | 9/16-18 | 11/16 | 1.22 | 50 | 6 F5BU-S | 6 F5BU-SS | 413 | 413 |
| 1/2 | 3/4-16 | 7/8 | 1.38 | 82 | 8 F5BU-S | 8 F5BU-SS | 345 | 345 |
| 5/8 | 7/8-14 | 1 | 1.56 | 109 | 10 F5BU-S | 10 F5BU-SS | 345 | 345 |
| 3/4 | 1 1/16-12 | 1 1/4 | 1.78 | 195 | 12 F5BU-S | 12 F5BU-SS | 310 | 310 |
| 1 | 1 5/16-12 | 1 1/2 | 1.81 | 250 | 16 F5BU-S | 16 F5BU-SS | 276 | 276 |

FBU Male Connector

Flareless / NPTF
SAE 080102

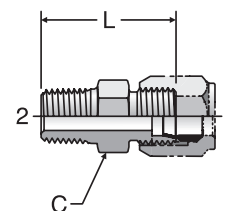

| End 1 inch | End 2 NPTF inch | Hex C inch | L inch | Weight steel g/1 piece | Ferulok® steel | Ferulok® stainless steel | Pressure steel bar | Pressure stainless steel bar |
|---------------|-----------------------|------------------|-----------|------------------------------|--------------------|-----------------------------|--------------------------|------------------------------------|
| 1/8 | 1/8-27 | 7/16 | 1.04 | 18 | 2 FBU-S | 2 FBU-SS | 413 | 413 |
| 1/8 | 1/4-18 | 9/16 | 1.24 | 32 | 2-4 FBU-S | 2-4 FBU-SS | 413 | 413 |
| 1/4 | 1/8-27 | 1/2 | 1.12 | 27 | 4 FBU-S | 4 FBU-SS | 413 | 413 |
| 1/4 | 1/4-18 | 9/16 | 1.32 | 36 | 4-4 FBU-S | 4-4 FBU-SS | 413 | 413 |
| 1/4 | 3/8-18 | 3/4 | 1.33 | 36 | 4-6 FBU-S | 4-6 FBU-SS | 413 | 413 |
| 1/4 | 1/2-14 | 7/8 | 1.58 | 64 | 4-8 FBU-S | 4-8 FBU-SS | 413 | 413 |
| 3/8 | 1/4-18 | 5/8 | 1.34 | 45 | 6 FBU-S | 6 FBU-SS | 413 | 413 |
| 3/8 | 1/8-27 | 5/8 | 1.15 | 45 | 6-2 FBU-S | 6-2 FBU-SS | 413 | 413 |
| 3/8 | 3/8-18 | 3/4 | 1.35 | 59 | 6-6 FBU-S | 6-6 FBU-SS | 413 | 413 |
| 3/8 | 1/2-14 | 15/16 | 1.6 | 91 | 6-8 FBU-S | 6-8 FBU-SS | 413 | 413 |
| 1/2 | 3/8-18 | 13/16 | 1.44 | 77 | 8 FBU-S | 8 FBU-SS | 345 | 345 |
| 1/2 | 1/4-18 | 13/16 | 1.44 | 73 | 8-4 FBU-S | 8-4 FBU-SS | 345 | 345 |
| 1/2 | 1/2-14 | 7/8 | 1.69 | 100 | 8-8 FBU-S | 8-8 FBU-SS | 345 | 345 |
| 1/2 | 3/4-14 | 1 1/8 | 1.76 | 118 | 8-12 FBU-S | 8-12 FBU-SS | 276 | 276 |
| 3/4 | 3/4-14 | 1 1/8 | 1.88 | 182 | 12 FBU-S | 12 FBU-SS | 276 | 276 |
| 3/4 | 1/2-14 | 1 1/8 | 1.88 | 168 | 12-8 FBU-S | 12-8 FBU-SS | 276 | 276 |
| 1 | 1-11 1/2 | 1 3/8 | 2.07 | 272 | 16 FBU-S | 16 FBU-SS | 207 | 207 |
| 1 | 3/4-14 | 1 3/8 | 1.88 | 236 | 16-12 FBU-S | 16-12 FBU-SS | 207 | 207 |
| 1 1/4 | 1 1/4-11 1/2 | 1 11/16 | 2.18 | 499 | 20 FBU-S | 20 FBU-SS | 172 | 172 |
| 1 1/2 | 1 1/2-11 1/2 | 2 | 2.28 | 499 | 24 FBU-S | 24 FBU-SS | 172 | 172 |



Ferulok®

C5BU Straight Thread Elbow

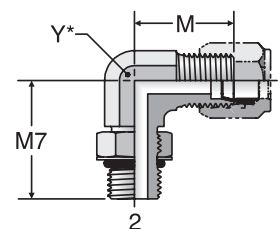
 Flareless / SAE-ORB
 SAE 080220

| End 1 inch | End 2 UN/UNF-2A inch | M inch | M7 inch | Y inch | Weight steel g/1 piece | Ferulok® steel | Ferulok® stainless steel | Pressure steel bar | Pressure stainless steel bar |
|---------------|----------------------------|-----------|------------|-----------|------------------------------|-------------------|-----------------------------|--------------------------|------------------------------------|
| 1/4 | 7/16-20 | 0.89 | 1.03 | 7/16 | 36 | 4 C5BU-S | 4 C5BU-SS | 345 | 345 |
| 3/8 | 9/16-18 | 1.05 | 1.25 | 9/16 | 59 | 6 C5BU-S | 6 C5BU-SS | 345 | 345 |
| 1/2 | 3/4-16 | 1.25 | 1.45 | 3/4 | 132 | 8 C5BU-S | 8 C5BU-SS | 345 | 345 |
| 5/8 | 7/8-14 | 1.42 | 1.70 | 7/8 | 191 | 10 C5BU-S | 10 C5BU-SS | 310 | 310 |
| 3/4 | 1 1/16-12 | 1.58 | 1.94 | 1 1/16 | 263 | 12 C5BU-S | 12 C5BU-SS | 276 | 276 |
| 1 | 1 5/16-12 | 1.73 | 2.05 | 1 5/16 | 463 | 16 C5BU-S | 16 C5BU-SS | 207 | 207 |
| 1 1/4 | 1 5/8-12 | 1.89 | 2.25 | 1 5/8 | 772 | 20 C5BU-S | 20 C5BU-SS | 172 | 172 |
| 1 1/2 | 1 7/8-12 | 2.02 | 2.39 | 1 7/8 | 944 | 24 C5BU-S | 24 C5BU-SS | 138 | 138 |

CBU Male Elbow

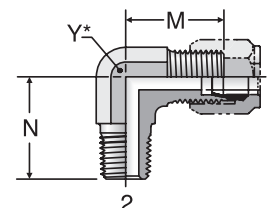
 Flareless / NPTF
 SAE 080202

| End 1 inch | End 2 NPTF inch | M inch | N inch | Y inch | Weight steel g/1 piece | Ferulok® steel | Ferulok® stainless steel | Pressure steel bar | Pressure stainless steel bar |
|---------------|-----------------------|-----------|-----------|-----------|------------------------------|-------------------|-----------------------------|--------------------------|------------------------------------|
| 1/4 | 1/8-27 | 0.89 | 0.78 | 7/16 | 36 | 4 CBU-S | 4 CBU-SS | 345 | 345 |
| 3/8 | 1/4-18 | 1.05 | 1.09 | 9/16 | 64 | 6 CBU-S | 6 CBU-SS | 345 | 345 |
| 3/8 | 3/8-18 | 1.14 | 1.22 | 3/4 | 95 | 6-6 CBU-S | 6 CBU-SS | 345 | 345 |
| 1/2 | 3/8-18 | 1.25 | 1.22 | 3/4 | 114 | 8 CBU-S | 8 CBU-SS | 345 | 345 |
| 1/2 | 1/2-14 | 1.35 | 1.47 | 7/8 | 149 | 8-8 CBU-S | 8-8CBU-SS | 345 | 345 |
| 5/8 | 1/2-14 | 1.42 | 1.47 | 7/8 | 168 | 10 CBU-S | 10 CBU-SS | 310 | 310 |
| 3/4 | 3/4-14 | 1.58 | 1.59 | 1 1/16 | 272 | 12 CBU-S | 12 CBU-SS | 276 | 276 |
| 1 | 1-11 1/2 | 1.73 | 1.97 | 1 5/16 | 413 | 16 CBU-S | 16 CBU-SS | 207 | 207 |
| 1 1/4 | 1 1/4-11 1/2 | 1.89 | 2.38 | 1 5/8 | 754 | 20 CBU-S | 20 CBU-SS | 172 | 172 |
| 1 1/2 | 1 1/2-11 1/2 | 2.02 | 2.64 | 1 7/8 | 926 | 24 CBU-S | 24 CBU-SS | 172 | 172 |

GBU Female Connector

Flareless / NPTF
SAE 080103

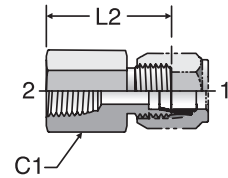

| End 1 inch | End 2 inch | Hex C1 inch | L2 inch | Weight steel g/1 piece | Ferulok® steel | Ferulok® stainless steel | Pressure steel bar | Pressure stainless steel bar |
|---------------|---------------|-------------------|------------|------------------------------|-------------------|-----------------------------|--------------------------|------------------------------------|
| 1/4 | 1/8-27 | 9/16 | 1.09 | 32 | 4 GBU-S | 4 GBU-SS | 345 | 345 |
| 3/8 | 1/4-18 | 3/4 | 1.31 | 59 | 6 GBU-S | 6 GBU-SS | 345 | 345 |
| 1/2 | 3/8-18 | 7/8 | 1.47 | 91 | 8 GBU-S | 8 GBU-SS | 345 | 345 |
| 5/8 | 1/2-14 | 1 1/8 | 1.77 | 159 | 10 GBU-S | 10 GBU-SS | 310 | 310 |
| 3/4 | 3/4-14 | 1 3/8 | 1.89 | 250 | 12 GBU-S | 12 GBU-SS | 276 | 276 |
| 1 | 1-11 1/2 | 1 5/8 | 2.13 | 359 | 16 GBU-S | 16 GBU-SS | 207 | 207 |
| 1 1/4 | 1 1/4-11 1/2 | 2 | 2.22 | 636 | 20 GBU-S | 20 GBU-SS | 172 | 172 |
| 1 1/2 | 1 1/2-11 1/2 | 2 3/8 | 2.23 | 667 | 24 GBU-S | 24 GBU-SS | 172 | 172 |

FNU Cap

Flareless Swivel
SAE 080112

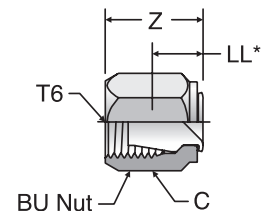

| Tube O.D. inch | T6UN/UNF-2B inch | Hex C inch | LL inch | Z inch | Weight steel g/1 piece | Ferulok® steel | Ferulok® stainless steel |
|----------------------|---------------------|------------------|------------|-----------|------------------------------|-------------------|-----------------------------|
| 1/4 | 7/16-24 | 9/16 | 0.36 | 0.73 | 4.54 | 4 FNU-S | 4 FNU-SS |
| 3/8 | 9/16-18 | 11/16 | 0.42 | 0.80 | 13.62 | 6 FNU-S | 6 FNU-SS |
| 1/2 | 3/4-16 | 7/8 | 0.44 | 0.87 | 27.24 | 8 FNU-S | 8 FNU-SS |
| 5/8 | 7/8-14 | 1 | 0.47 | 0.98 | 40.86 | 10 FNU-S | 10 FNU-SS |
| 3/4 | 1 1/16-12 | 1 1/4 | 0.48 | 1.00 | 59.02 | 12 FNU-S | 12 FNU-SS |
| 1 | 1 5/16-12 | 1 1/2 | 0.58 | 1.08 | 72.64 | 16 FNU-S | 16 FNU-SS |
| 1 1/4 | 1 5/8-12 | 2 | 0.64 | 1.11 | 104.42 | 20 FNU-S | 20 FNU-SS |

Ferulok®
PNU Plug

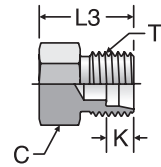
 Flareless
 SAE 080109

| Tube O.D. inch | T Tube End UN/UNF 2A inch | Hex C inch | K inch | L3 inch | Weight steel g/1 piece | Ferulok® steel | Ferulok® stainless steel | Pressure steel bar | Pressure stainless steel bar |
|----------------|---------------------------|------------|--------|---------|------------------------|-----------------|--------------------------|--------------------|------------------------------|
| 1/4 | 7/16-20 | 1/2 | 0.24 | 0.72 | 9 | 4 PNU-S | 4 PNU-SS | 413 | 413 |
| 3/8 | 9/16-18 | 5/8 | 0.26 | 0.75 | 18 | 6 PNU-S | 6 PNU-SS | 413 | 413 |
| 1/2 | 3/4-16 | 13/16 | 0.31 | 0.84 | 36 | 8 PNU-S | 8 PNU-SS | 345 | 345 |
| 5/8 | 7/8-14 | 15/16 | 0.36 | 0.97 | 54 | 10 PNU-S | 10 PNU-SS | 345 | 345 |
| 3/4 | 1 1/16-12 | 1 1/8 | 0.36 | 1.09 | 91 | 12 PNU-S | 12 PNU-SS | 310 | 310 |
| 1 | 1 5/16-12 | 1 3/8 | 0.42 | 1.09 | 168 | 16 PNU-S | 16 PNU-SS | 276 | 276 |



 **Ermeto Original**
Weld fittings



Weld fittings

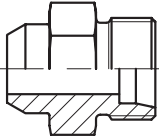
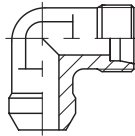
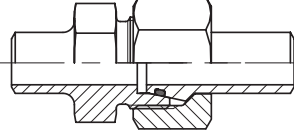
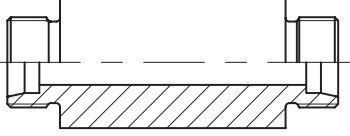
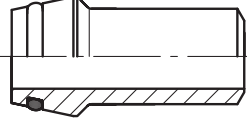
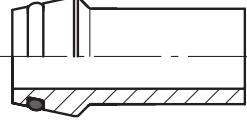
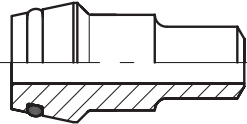
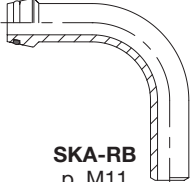
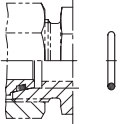

Visual index

| | | |
|------------------------------|---|--|
| <p>Tube to weld</p> |  <p>AS p. M3</p> |  <p>WAS p. M4</p> |
| <p>Weld fitting</p> |  <p>ASK p. M5</p> | |
| <p>Weld bulkhead</p> |  <p>ESV p. M6</p> | |
| <p>Weld nipple</p> |  <p>SKA p. M7</p> |  <p>SKA-ORB p. M10</p> |
| <p>Reducing weld nipple</p> |  <p>SKAR p. M8/9</p> | |
| <p>Tube bend weld nipple</p> |  <p>SKA-RB p. M11</p> | |
| <p>O-ring</p> |  <p>O-ring p. M12</p> | |



AS Weld connector

Butt weld / EO 24° cone end

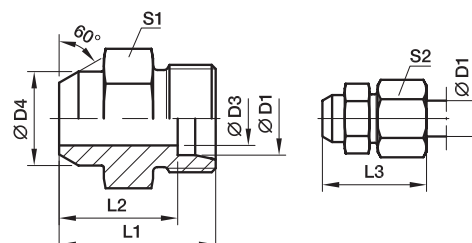

| Series | D1 | D3 | D4 | L1 | L2 | L3 | S1 | S2 | Weight g/1 piece | Order code | PN (bar) ¹⁾ | |
|-----------------|--------|----|----|----|------|----|----|----|---------------------|--------------|------------------------|-----------------|
| | | | | | | | | | | | Steel | Stainless Steel |
| L ³⁾ | 06 | 4 | 10 | 21 | 14.0 | 29 | 12 | 14 | 11 | AS06L | 315 | 315 |
| | 08 | 6 | 12 | 23 | 16.0 | 31 | 14 | 17 | 15 | AS08L | 315 | 315 |
| | 10 | 8 | 14 | 25 | 18.0 | 33 | 17 | 19 | 22 | AS10L | 315 | 315 |
| | 12 | 10 | 16 | 25 | 18.0 | 33 | 19 | 22 | 25 | AS12L | 315 | 315 |
| | 15 | 12 | 19 | 29 | 22.0 | 37 | 22 | 27 | 44 | AS15L | 315 | 315 |
| | 18 | 15 | 22 | 31 | 23.5 | 40 | 27 | 32 | 67 | AS18L | 315 | 315 |
| | 22 | 19 | 27 | 36 | 28.5 | 45 | 32 | 36 | 98 | AS22L | 160 | 160 |
| | 28 | 24 | 32 | 38 | 30.5 | 47 | 41 | 41 | 165 | AS28L | 160 | 160 |
| | 35 | 30 | 40 | 43 | 32.5 | 54 | 46 | 50 | 232 | AS35L | 160 | 160 |
| | 42 | 36 | 46 | 46 | 35.0 | 58 | 55 | 60 | 342 | AS42L | 160 | 160 |
| S ⁴⁾ | 06 | 4 | 11 | 26 | 19.0 | 34 | 14 | 17 | 21 | AS06S | 630 | 630 |
| | 08 | 5 | 13 | 28 | 21.0 | 36 | 17 | 19 | 31 | AS08S | 630 | 630 |
| | 10 | 7 | 15 | 30 | 22.5 | 39 | 19 | 22 | 41 | AS10S | 630 | 630 |
| | 12 | 8 | 17 | 32 | 24.5 | 41 | 22 | 24 | 93 | AS12S | 630 | 630 |
| | 16 | 12 | 21 | 35 | 26.5 | 45 | 27 | 30 | 82 | AS16S | 400 | 400 |
| | 20 | 16 | 26 | 40 | 29.5 | 51 | 32 | 36 | 131 | AS20S | 400 | 400 |
| | 25 | 20 | 31 | 44 | 32.0 | 56 | 41 | 46 | 219 | AS25S | 400 | 400 |
| | 30 | 25 | 36 | 49 | 35.5 | 62 | 46 | 50 | 297 | AS30S | 400 | 400 |
| | 38 | 32 | 44 | 54 | 38.0 | 69 | 55 | 60 | 448 | AS38S | 315 | 315 |

¹⁾ Pressure shown = item deliverable

³⁾ L = light series; ⁴⁾ S = heavy series

$\frac{PN(\text{bar})}{10} = PN(\text{MPa})$

Delivery without nut and ring. Information on ordering complete fittings or alternative sealing materials see page 17.



| Order code suffixes | | |
|---------------------|-----------------------------|----------|
| Material | Suffix surface and material | Example |
| Steel | | AS16SX |
| Stainless Steel | 71X | AS16S71X |

*Please add the **suffixes** below according to the material/surface required.



Weld fittings

WAS Weld elbow

Butt weld / EO 24° cone end

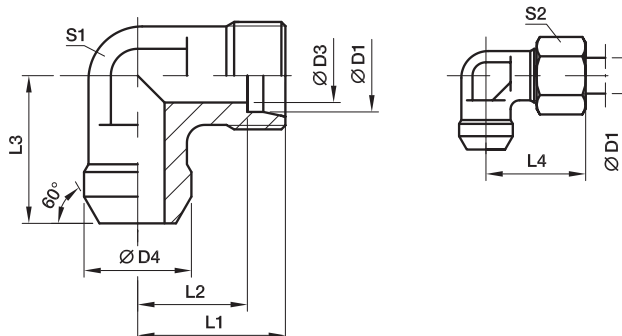

| Series | D1 | D3 | D4 | L1 | L2 | L3 | L4 | S1 | S2 | Weight g/1 piece | Order code | PN (bar) ¹⁾ | |
|-----------------|----|----|----|----|------|----|----|----|----|---------------------|---------------|------------------------|-----------------|
| | | | | | | | | | | | | Steel | Stainless Steel |
| L ³⁾ | 06 | 4 | 10 | 19 | 12.0 | 19 | 27 | 12 | 14 | 20 | WAS06L | 315 | 315 |
| | 08 | 6 | 12 | 21 | 14.0 | 23 | 29 | 12 | 17 | 25 | WAS08L | 315 | 315 |
| | 10 | 8 | 14 | 22 | 15.0 | 24 | 30 | 14 | 19 | 34 | WAS10L | 315 | 315 |
| | 12 | 10 | 16 | 24 | 17.0 | 25 | 32 | 17 | 22 | 45 | WAS12L | 315 | 315 |
| | 15 | 12 | 19 | 28 | 21.0 | 30 | 36 | 19 | 27 | 81 | WAS15L | 315 | 315 |
| | 18 | 15 | 22 | 31 | 23.5 | 33 | 40 | 24 | 32 | 113 | WAS18L | 315 | 315 |
| | 22 | 19 | 27 | 35 | 27.5 | 37 | 44 | 27 | 36 | 151 | WAS22L | 160 | 160 |
| | 28 | 24 | 32 | 38 | 30.5 | 42 | 47 | 36 | 41 | 271 | WAS28L | 160 | 160 |
| | 35 | 30 | 40 | 45 | 34.5 | 49 | 56 | 41 | 50 | 113 | WAS35L | 160 | 160 |
| | 42 | 36 | 46 | 51 | 40.0 | 57 | 63 | 50 | 60 | 420 | WAS42L | 160 | 160 |
| S ⁴⁾ | 06 | 4 | 11 | 23 | 16.0 | 23 | 31 | 12 | 17 | 31 | WAS06S | 630 | 630 |
| | 08 | 5 | 13 | 24 | 17.0 | 24 | 32 | 14 | 19 | 44 | WAS08S | 630 | 630 |
| | 10 | 7 | 15 | 25 | 17.5 | 25 | 34 | 17 | 22 | 59 | WAS10S | 630 | 630 |
| | 12 | 8 | 17 | 29 | 21.5 | 29 | 38 | 17 | 24 | 78 | WAS12S | 630 | 630 |
| | 16 | 12 | 21 | 33 | 24.5 | 33 | 43 | 24 | 30 | 133 | WAS16S | 400 | 400 |
| | 20 | 16 | 26 | 37 | 26.5 | 37 | 48 | 27 | 36 | 192 | WAS20S | 400 | 400 |
| | 25 | 20 | 31 | 42 | 30.0 | 42 | 54 | 36 | 46 | 351 | WAS25S | 400 | 400 |
| | 30 | 25 | 36 | 49 | 35.5 | 49 | 62 | 41 | 50 | 525 | WAS30S | 400 | 400 |
| | 38 | 32 | 44 | 57 | 41.0 | 57 | 72 | 50 | 60 | 785 | WAS38S | 315 | 315 |

¹⁾Pressure shown = item deliverable

³⁾L = light series; ⁴⁾S = heavy series

 PN (bar) = PN (MPa)
10

Delivery without nut and ring. Information on ordering complete fittings or alternative sealing materials see page 17.

 *Please add the **suffixes** below according to the material/surface required.

| Order code suffixes | | |
|---------------------|-----------------------------|-----------|
| Material | Suffix surface and material | Example |
| Steel | | WAS16SX |
| Stainless Steel | 71X | WAS16S71X |



ASK Weld fitting for tubes

Butt weld / Butt weld

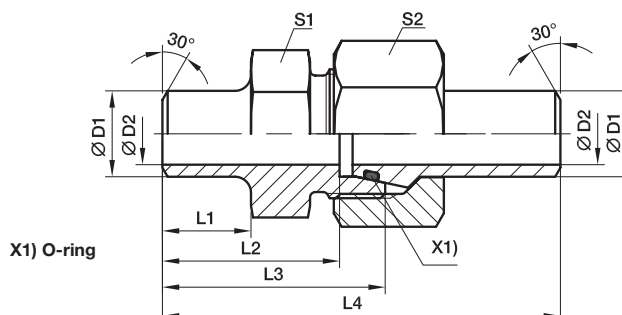

| Series | D1 ⊕ ±0.1 | D2 | L1 | L2 | L3 | L4 | S1 | S2 | recommended tube | Weight g/1 piece | Order code | PN (bar) ¹⁾ | |
|-----------------|-----------------|------|------|------|-------|-------|----|--------|------------------|------------------|--------------------|------------------------|-----------------|
| | | | | | | | | | | | | Steel | Stainless Steel |
| S ⁴⁾ | 10 | 8 | 10.0 | 24.5 | 32.0 | 58.0 | 19 | 22 | 10×1.0 | 75 | ASK610X1S | 249 | 242 |
| | 10 | 7 | 10.0 | 24.5 | 32.0 | 58.0 | 19 | 22 | 10×1.5 | 81 | ASK610X1.5S | 358 | 349 |
| | 10 | 6 | 10.0 | 24.5 | 32.0 | 58.0 | 19 | 22 | 10×2.0 | 86 | ASK610X2S | 460 | 447 |
| | 12 | 9 | 15.0 | 29.5 | 37.0 | 63.0 | 22 | 24 | 12×1.5 | 106 | ASK612X1.5S | 305 | 297 |
| | 12 | 8 | 15.0 | 29.5 | 37.0 | 63.0 | 22 | 24 | 12×2.0 | 107 | ASK612X2S | 393 | 383 |
| | 12 | 7 | 15.0 | 29.5 | 37.0 | 63.0 | 22 | 24 | 12×2.5 | 109 | ASK612X2.5S | 476 | 463 |
| | 16 | 13 | 16.5 | 33.0 | 41.5 | 73.5 | 27 | 30 | 16×1.5 | 166 | ASK616X1.5S | 234 | 228 |
| | 16 | 12 | 16.5 | 33.0 | 41.5 | 73.5 | 27 | 30 | 16×2.0 | 175 | ASK616X2S | 305 | 297 |
| | 16 | 11 | 16.5 | 33.0 | 41.5 | 73.5 | 27 | 30 | 16×2.5 | 184 | ASK616X2.5S | 372 | 362 |
| | 16 | 10 | 16.5 | 33.0 | 41.5 | 73.5 | 27 | 30 | 16×3.0 | 193 | ASK616X3S | 400 | 400 |
| | 20 | 16 | 19.0 | 36.5 | 47.0 | 83.5 | 32 | 36 | 20×2.0 | 301 | ASK620X2S | 249 | 242 |
| | 20 | 15 | 19.0 | 36.5 | 47.0 | 83.5 | 32 | 36 | 20×2.5 | 311 | ASK620X2.5S | 305 | 297 |
| | 20 | 14 | 19.0 | 36.5 | 47.0 | 83.5 | 32 | 36 | 20×3.0 | 316 | ASK620X3S | 358 | 349 |
| | 20 | 12 | 19.0 | 36.5 | 47.0 | 83.5 | 32 | 36 | 20×4.0 | 322 | ASK620X4S | 400 | 400 |
| | 25 | 19 | 19.5 | 39.5 | 51.5 | 92.5 | 41 | 46 | 25×3.0 | 551 | ASK625X3S | 294 | 286 |
| | 25 | 17 | 19.5 | 39.5 | 51.5 | 92.5 | 41 | 46 | 25×4.0 | 559 | ASK625X4S | 379 | 369 |
| | 25 | 15 | 19.5 | 39.5 | 51.5 | 92.5 | 41 | 46 | 25×5.0 | 589 | ASK625X5S | 400 | 400 |
| | 30 | 24 | 23.0 | 44.5 | 58.0 | 101.5 | 46 | 50 | 30×3.0 | 671 | ASK630X3S | 249 | 242 |
| | 30 | 22 | 23.0 | 44.5 | 58.0 | 101.5 | 46 | 50 | 30×4.0 | 679 | ASK630X4S | 323 | 314 |
| | 30 | 20 | 23.0 | 44.5 | 58.0 | 101.5 | 46 | 50 | 30×5.0 | 726 | ASK630X5S | 393 | 383 |
| 30 | 18 | 23.0 | 44.5 | 58.0 | 101.5 | 46 | 50 | 30×6.0 | 791 | ASK630X6S | 400 | 400 | |
| 38 | 30 | 22.0 | 44.0 | 60.0 | 108.0 | 55 | 60 | 38×4.0 | 988 | ASK638X4S | 261 | 254 | |
| 38 | 28 | 22.0 | 44.0 | 60.0 | 108.0 | 55 | 60 | 38×5.0 | 1044 | ASK638X5S | 315 | 311 | |
| 38 | 26 | 22.0 | 44.0 | 60.0 | 108.0 | 55 | 60 | 38×6.0 | 1108 | ASK638X6S | 315 | 315 | |
| 38 | 24 | 22.0 | 44.0 | 60.0 | 108.0 | 55 | 60 | 38×7.0 | 1205 | ASK638X7S | 315 | 315 | |

¹⁾ Pressure shown = item deliverable

⁴⁾ S = heavy series

$\frac{\text{PN (bar)}}{10} = \text{PN (MPa)}$



| Order code suffixes | | | |
|---------------------|-----------------------------|-------------|---|
| Material | Suffix surface and material | Example | Standard sealing material (no additional suffix needed) |
| Steel | | ASK616X2S | NBR |
| Stainless Steel | 71 | ASK616X2S71 | VIT |

*Please add the **suffixes** below according to the material/surface required.



Weld fittings

ESV Weld bulkhead fitting

EO 24° cone end / EO 24° cone end

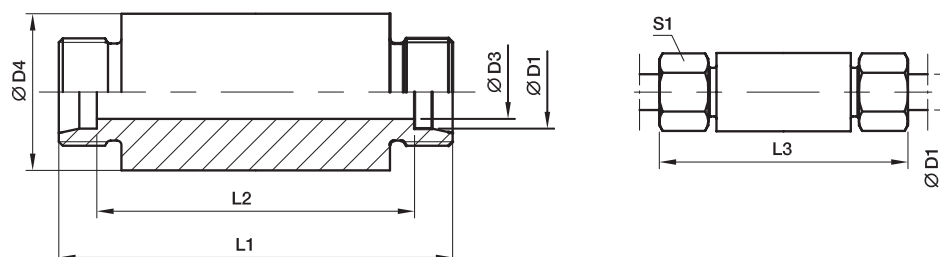

| Series | D1 ⌀ | D3 | D4 | L1 | L2 | L3 | S1 | Weight g/1 piece | Order code | PN (bar) ¹⁾ | |
|-----------------|---------|----|----|-----|----|-----|----|---------------------|---------------|------------------------|-----------------|
| | | | | | | | | | | Steel | Stainless Steel |
| L ³⁾ | 06 | 4 | 18 | 70 | 56 | 85 | 14 | 103 | ESV06L | 500 | 315 |
| | 08 | 6 | 20 | 70 | 56 | 85 | 17 | 121 | ESV08L | 500 | 315 |
| | 10 | 8 | 22 | 72 | 58 | 87 | 19 | 142 | ESV10L | 500 | 315 |
| | 12 | 10 | 25 | 72 | 58 | 87 | 22 | 176 | ESV12L | 400 | 315 |
| | 15 | 12 | 28 | 84 | 70 | 100 | 27 | 262 | ESV15L | 400 | 315 |
| | 18 | 15 | 32 | 84 | 69 | 101 | 32 | 333 | ESV18L | 400 | 315 |
| | 22 | 19 | 36 | 88 | 73 | 105 | 36 | 394 | ESV22L | 250 | 160 |
| | 28 | 24 | 40 | 88 | 73 | 106 | 41 | 448 | ESV28L | 250 | 160 |
| | 35 | 30 | 50 | 92 | 71 | 114 | 50 | 713 | ESV35L | 250 | 160 |
| | 42 | 36 | 60 | 92 | 70 | 115 | 60 | 997 | ESV42L | 250 | 160 |
| S ⁴⁾ | 06 | 4 | 20 | 74 | 60 | 89 | 17 | 135 | ESV06S | 800 | 630 |
| | 08 | 5 | 22 | 74 | 60 | 89 | 19 | 163 | ESV08S | 800 | 630 |
| | 10 | 7 | 25 | 74 | 59 | 91 | 22 | 201 | ESV10S | 800 | 630 |
| | 12 | 8 | 28 | 74 | 59 | 91 | 24 | 249 | ESV12S | 630 | 630 |
| | 16 | 12 | 35 | 88 | 71 | 107 | 30 | 441 | ESV16S | 630 | 400 |
| | 20 | 16 | 38 | 92 | 71 | 114 | 36 | 509 | ESV20S | 420 | 400 |
| | 25 | 20 | 45 | 96 | 72 | 120 | 46 | 720 | ESV25S | 420 | 400 |
| | 30 | 25 | 50 | 100 | 73 | 126 | 50 | 873 | ESV30S | 420 | 400 |
| | 38 | 32 | 60 | 104 | 72 | 133 | 60 | 1248 | ESV38S | 420 | 315 |

¹⁾ Pressure shown = item deliverable

³⁾ L = light series; ⁴⁾ S = heavy series

 $\frac{\text{PN (bar)}}{10} = \text{PN (MPa)}$

Delivery without nut and ring. Information on ordering complete fittings or alternative sealing materials see page 17.

 *Please add the **suffixes** below according to the material/surface required.

| Order code suffixes | | |
|---------------------|-----------------------------|-----------|
| Material | Suffix surface and material | Example |
| Steel | | ESV16SX |
| Stainless Steel | 71X | ESV16S71X |



SKA Weld nipple

EO 24° O-ring weld nipple / butt weld

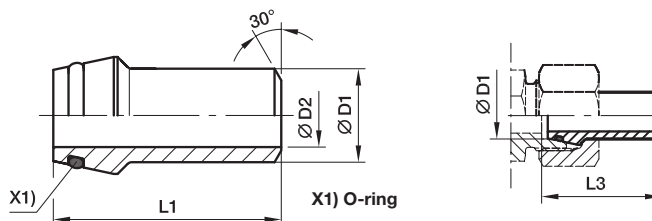

| Series | D1 | D2 | L1 | L3 | recommended tube | Weight g/1 piece | Order code | PN (bar) ¹⁾ | | |
|----------------------------------|-----------------|------|------|------|------------------|------------------|------------|------------------------|-----------------|-----|
| | | | | | | | | Steel | Stainless Steel | |
| L ³⁾ /S ⁴⁾ | 06 | 3.0 | 31.0 | 31.5 | 06×1.5 | 7 | SKA06X1.5 | 528 | 539 | |
| | 08 | 4.5 | 31.0 | 31.5 | 08×1.5 | 11 | SKA08X1.5 | 414 | 424 | |
| | 08 | 4.0 | 31.0 | 31.5 | 08×2.0 | 11 | SKA08X2 | 528 | 539 | |
| | 10 | 8.0 | 32.5 | 33.5 | 10×1.0 | 13 | SKA10X1 | 249 | 242 | |
| | 10 | 7.0 | 32.5 | 33.5 | 10×1.5 | 13 | SKA10X1.5 | 358 | 349 | |
| | 10 | 6.0 | 32.5 | 33.5 | 10×2.0 | 16 | SKA10X2 | 460 | 447 | |
| | 12 | 8.0 | 32.5 | 33.5 | 12×1.5 | 21 | SKA12X1.5 | 305 | 297 | |
| | 12 | 8.0 | 32.5 | 33.5 | 12×2.0 | 20 | SKA12X2 | 393 | 383 | |
| | 12 | 7.0 | 32.5 | 33.5 | 12×2.5 | 22 | SKA12X2.5 | 476 | 463 | |
| | L ³⁾ | 15 | 11.0 | 34.0 | 34.5 | 15×2.0 | 29 | SKA15X2 | 315 | 315 |
| | | 15 | 10.0 | 34.0 | 34.5 | 15×2.5 | 31 | SKA15X2.5 | 315 | 315 |
| | | 18 | 13.0 | 35.5 | 36.5 | 18×2.5 | 40 | SKA18X2.5 | 315 | 315 |
| 22 | | 17.0 | 38.5 | 39.5 | 22×2.5 | 57 | SKA22X2.5 | 160 | 160 | |
| 28 | | 23.0 | 41.5 | 42.5 | 28×2.5 | 73 | SKA28X2.5 | 160 | 160 | |
| 28 | | 22.0 | 41.5 | 42.5 | 28×3.0 | 89 | SKA28X3 | 160 | 160 | |
| 35 | | 28.0 | 47.5 | 49.5 | 35×3.5 | 140 | SKA35X3.5 | 160 | 160 | |
| 35 | | 27.0 | 47.5 | 49.5 | 35×4.0 | 150 | SKA35X4 | 160 | 160 | |
| 42 | | 36.0 | 47.5 | 50.0 | 42×3.0 | 155 | SKA42X3 | 160 | 160 | |
| 42 | | 34.0 | 47.5 | 50.0 | 42×4.0 | 190 | SKA42X4 | 160 | 160 | |
| S ⁴⁾ | | 16 | 13.0 | 39.0 | 40.5 | 16×1.5 | 32 | SKA16X1.5 | 234 | 228 |
| | | 16 | 12.0 | 39.0 | 40.5 | 16×2.0 | 31 | SKA16X2 | 305 | 297 |
| | 16 | 11.0 | 39.0 | 40.5 | 16×2.5 | 38 | SKA16X2.5 | 372 | 362 | |
| | 16 | 10.0 | 39.0 | 40.5 | 16×3.0 | 41 | SKA16X3 | 400 | 400 | |
| | 20 | 16.0 | 45.0 | 47.0 | 20×2.0 | 57 | SKA20X2 | 249 | 242 | |
| | 20 | 15.0 | 45.0 | 47.0 | 20×2.5 | 57 | SKA20X2.5 | 305 | 297 | |
| | 20 | 14.0 | 45.0 | 47.0 | 20×3.0 | 64 | SKA20X3 | 358 | 349 | |
| | 20 | 13.0 | 45.0 | 47.0 | 20×3.5 | 71 | SKA20X3.5 | 400 | 400 | |
| | 20 | 12.0 | 45.0 | 47.0 | 20×4.0 | 78 | SKA20X4 | 400 | 400 | |
| | 25 | 19.0 | 49.5 | 53.0 | 25×3.0 | 89 | SKA25X3 | 294 | 286 | |
| | 25 | 18.0 | 49.5 | 53.0 | 25×3.5 | 100 | SKA25X3.5 | 337 | 328 | |
| | 25 | 17.0 | 49.5 | 53.0 | 25×4.0 | 111 | SKA25X4 | 379 | 369 | |
| | 25 | 15.0 | 49.5 | 53.0 | 25×5.0 | 125 | SKA25X5 | 400 | 400 | |
| | 30 | 24.0 | 52.0 | 57.0 | 30×3.0 | 113 | SKA30X3 | 249 | 242 | |
| | 30 | 22.0 | 52.0 | 57.0 | 30×4.0 | 141 | SKA30X4 | 323 | 314 | |
| | 30 | 20.0 | 52.0 | 57.0 | 30×5.0 | 166 | SKA30X5 | 393 | 383 | |
| | 30 | 18.0 | 52.0 | 57.0 | 30×6.0 | 188 | SKA30X6 | 400 | 400 | |
| | 38 | 32.0 | 56.5 | 64.0 | 38×3.0 | 163 | SKA38X3 | 200 | 195 | |
| | 38 | 30.0 | 56.5 | 64.0 | 38×4.0 | 209 | SKA38X4 | 261 | 254 | |
| | 38 | 28.0 | 56.5 | 64.0 | 38×5.0 | 247 | SKA38X5 | 315 | 315 | |
| | 38 | 26.0 | 56.5 | 64.0 | 38×6.0 | 270 | SKA38X6 | 315 | 370 | |
| | 38 | 24.0 | 56.5 | 64.0 | 38×7.0 | 270 | SKA38X7 | 315 | 420 | |

¹⁾ Pressure shown = item deliverable

³⁾ L = light series; ⁴⁾ S = heavy series

PN (bar)
10 = PN (MPa)

*Please add the **suffixes** below according to the material/surface required.

| Order code suffixes | | | |
|---------------------|-----------------------------|-----------|---|
| Material | Suffix surface and material | Example | Standard sealing material (no additional suffix needed) |
| Steel | | SKA16X2 | NBR |
| Stainless Steel | 71 | SKA16X271 | VIT |

M

Weld fittings

SKAR Reducing weld nipple

EO 24° O-ring weld nipple / butt weld

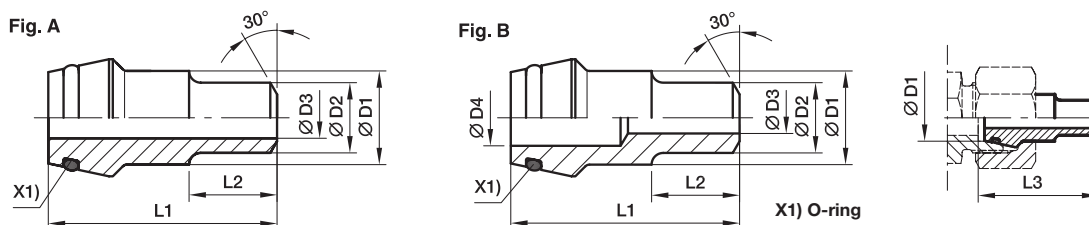

| Series | D1 | D2 | D3 | D4 | L1 | L2 | L3 | Fig. | Weight g/1 piece | Order code | PN (bar) ¹⁾ | |
|----------------------------------|----|----|----|------|------|------|------|------|---------------------|---------------|------------------------|-----------------|
| | | | | | | | | | | | Steel | Stainless Steel |
| L ³ /S ⁴) | 08 | 06 | 3 | | 31.0 | 12 | 31.5 | A | 14 | SKAR08/06X1.5 | 528 | 539 |
| | 10 | 06 | 3 | 5 | 32.5 | 12 | 33.5 | B | 15 | SKAR10/06X1.5 | 528 | 539 |
| | 10 | 08 | 5 | | 32.5 | 12 | 33.5 | A | 16 | SKAR10/08X1.5 | 414 | 424 |
| | 10 | 08 | 4 | | 32.5 | 12 | 33.5 | A | 17 | SKAR10/08X2 | 528 | 539 |
| | 12 | 08 | 5 | | 32.5 | 14 | 33.5 | A | 18 | SKAR12/08X1.5 | 414 | 424 |
| | 12 | 08 | 4 | 6 | 32.5 | 14 | 33.5 | B | 20 | SKAR12/08X2 | 528 | 539 |
| | 12 | 10 | 7 | | 32.5 | 14 | 33.5 | A | 18 | SKAR12/10X1.5 | 358 | 349 |
| S ⁴) | 16 | 10 | 6 | | 39.0 | 15 | 40.5 | A | 43 | SKAR16/10X2 | 400 | 400 |
| | 16 | 12 | 9 | | 39.0 | 15 | 40.5 | A | 45 | SKAR16/12X1.5 | 305 | 297 |
| | 16 | 12 | 8 | | 39.0 | 15 | 40.5 | A | 47 | SKAR16/12X2 | 393 | 383 |
| | 16 | 12 | 7 | | 39.0 | 15 | 40.5 | A | 49 | SKAR16/12X2.5 | 400 | 400 |
| | 20 | 12 | 9 | | 45.0 | 17 | 47.0 | A | 76 | SKAR20/12X1.5 | 305 | 297 |
| | 20 | 12 | 8 | | 45.0 | 17 | 47.0 | A | 78 | SKAR20/12X2 | 393 | 383 |
| | 20 | 12 | 7 | | 45.0 | 17 | 47.0 | A | 80 | SKAR20/12X2.5 | 400 | 400 |
| | 20 | 12 | 6 | | 45.0 | 17 | 47.0 | A | 86 | SKAR20/12X3 | 400 | 400 |
| | 20 | 16 | 12 | | 45.0 | 17 | 47.0 | A | 74 | SKAR20/16X2 | 305 | 297 |
| | 20 | 16 | 11 | | 45.0 | 17 | 47.0 | A | 76 | SKAR20/16X2.5 | 372 | 362 |
| | 20 | 16 | 10 | | 45.0 | 17 | 47.0 | A | 78 | SKAR20/16X3 | 400 | 400 |
| | 25 | 12 | 9 | | 49.5 | 20 | 53.0 | A | 117 | SKAR25/12X1.5 | 305 | 297 |
| | 25 | 12 | 8 | | 49.5 | 20 | 53.0 | A | 121 | SKAR25/12X2 | 393 | 383 |
| | 25 | 12 | 7 | | 49.5 | 20 | 53.0 | A | 125 | SKAR25/12X2.5 | 400 | 400 |
| | 25 | 12 | 6 | 15 | 49.5 | 20 | 53.0 | B | 129 | SKAR25/12X3 | 400 | 400 |
| | 25 | 16 | 12 | | 49.5 | 20 | 53.0 | A | 115 | SKAR25/16X2 | 305 | 297 |
| | 25 | 16 | 11 | | 49.5 | 20 | 53.0 | A | 120 | SKAR25/16X2.5 | 372 | 362 |
| | 25 | 16 | 10 | | 49.5 | 20 | 53.0 | A | 123 | SKAR25/16X3 | 400 | 400 |
| | 25 | 20 | 16 | | 49.5 | 20 | 53.0 | A | 94 | SKAR25/20X2 | 249 | 242 |
| | 25 | 20 | 15 | | 49.5 | 20 | 53.0 | A | 104 | SKAR25/20X2.5 | 305 | 297 |
| | 25 | 20 | 14 | | 49.5 | 20 | 53.0 | A | 114 | SKAR25/20X3 | 358 | 349 |
| | 25 | 20 | 12 | | 49.5 | 20 | 53.0 | A | 124 | SKAR25/20X4 | 400 | 400 |
| | 30 | 12 | 9 | 22 | 52.0 | 22 | 57.0 | B | 135 | SKAR30/12X1.5 | 305 | 297 |
| | 30 | 12 | 8 | 22 | 52.0 | 22 | 57.0 | B | 145 | SKAR30/12X2 | 323 | 383 |
| | 30 | 12 | 6 | 22 | 52.0 | 22 | 57.0 | B | 155 | SKAR30/12X3 | 400 | 400 |
| | 30 | 16 | 12 | | 52.0 | 22 | 57.0 | A | 166 | SKAR30/16X2 | 305 | 297 |
| | 30 | 16 | 11 | | 52.0 | 22 | 57.0 | A | 176 | SKAR30/16X2.5 | 323 | 362 |
| | 30 | 20 | 16 | | 52.0 | 22 | 57.0 | A | 149 | SKAR30/20X2 | 249 | 242 |
| | 30 | 20 | 15 | | 52.0 | 22 | 57.0 | A | 159 | SKAR30/20X2.5 | 305 | 297 |
| | 30 | 20 | 14 | | 52.0 | 22 | 57.0 | A | 169 | SKAR30/20X3 | 358 | 349 |
| | 30 | 20 | 12 | | 52.0 | 22 | 57.0 | A | 184 | SKAR30/20X4 | 400 | 400 |
| | 30 | 25 | 20 | | 52.0 | 22 | 57.0 | A | 141 | SKAR30/25X2.5 | 249 | 242 |
| 30 | 25 | 19 | | 52.0 | 22 | 57.0 | A | 156 | SKAR30/25X3 | 294 | 286 | |
| 30 | 25 | 17 | | 52.0 | 22 | 57.0 | A | 168 | SKAR30/25X4 | 379 | 369 | |



SKAR Reducing weld nipple

EO 24° O-ring weld nipple / butt weld

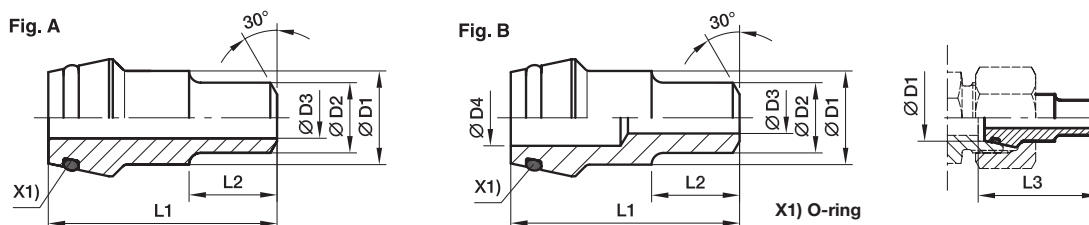

| Series | D1 | D2 | D3 | D4 | L1 | L2 | L3 | Fig. | Weight g/1 piece | Order code | PN (bar) ¹⁾ | |
|-----------------|----|----|----|----|------|----|------|------|---------------------|----------------------|------------------------|-----------------|
| | | | | | | | | | | | Steel | Stainless Steel |
| S ⁴⁾ | 38 | 12 | 9 | 28 | 56.5 | 26 | 64.0 | B | 219 | SKAR38/12X1.5 | 305 | 297 |
| | 38 | 12 | 8 | 28 | 56.5 | 26 | 64.0 | B | 234 | SKAR38/12X2 | 315 | 315 |
| | 38 | 12 | 6 | 28 | 56.5 | 26 | 64.0 | B | 249 | SKAR38/12X3 | 315 | 315 |
| | 38 | 16 | 12 | | 56.5 | 26 | 64.0 | A | 279 | SKAR38/16X2 | 305 | 297 |
| | 38 | 16 | 11 | | 56.5 | 26 | 64.0 | A | 294 | SKAR38/16X2.5 | 315 | 315 |
| | 38 | 16 | 10 | | 56.5 | 26 | 64.0 | A | 309 | SKAR38/16X3 | 315 | 315 |
| | 38 | 20 | 16 | | 56.5 | 26 | 64.0 | A | 263 | SKAR38/20X2 | 249 | 242 |
| | 38 | 20 | 15 | | 56.5 | 26 | 64.0 | A | 278 | SKAR38/20X2.5 | 305 | 297 |
| | 38 | 20 | 14 | | 56.5 | 26 | 64.0 | A | 293 | SKAR38/20X3 | 315 | 315 |
| | 38 | 20 | 12 | | 56.5 | 26 | 64.0 | A | 299 | SKAR38/20X4 | 315 | 315 |
| | 38 | 25 | 20 | | 56.5 | 26 | 64.0 | A | 242 | SKAR38/25X2.5 | 249 | 242 |
| | 38 | 25 | 19 | | 56.5 | 26 | 64.0 | A | 262 | SKAR38/25X3 | 294 | 286 |
| | 38 | 25 | 17 | | 56.5 | 26 | 64.0 | B | 285 | SKAR38/25X4 | 315 | 315 |
| | 38 | 30 | 24 | | 56.5 | 26 | 64.0 | A | 256 | SKAR38/30X3 | 249 | 242 |
| | 38 | 30 | 22 | | 56.5 | 26 | 64.0 | A | 286 | SKAR38/30X4 | 315 | 315 |
| | 38 | 30 | 20 | | 56.5 | 26 | 64.0 | A | 316 | SKAR38/30X5 | 315 | 315 |

¹⁾ Pressure shown = item deliverable

³⁾ L = light series; ⁴⁾ S = heavy series

$$\frac{\text{PN (bar)}}{10} = \text{PN (MPa)}$$

M

*Please add the **suffixes** below according to the material/surface required.

| Order code suffixes | | | |
|---------------------|-----------------------------|---------------|---|
| Material | Suffix surface and material | Example | Standard sealing material (no additional suffix needed) |
| Steel | | SKAR16/12X2 | NBR |
| Stainless Steel | 71 | SKAR16/12X271 | VIT |

Weld fittings

SKA-ORB Weld nipple (orbital)

EO 24° O-ring weld nipple / butt weld (orbital)

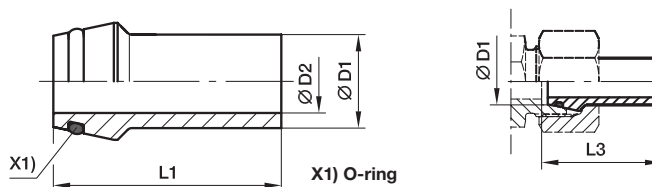

| Series | D1 ⌀ | D2 | L1 | L3 | recommended tube | Weight g/1 piece | Order code | PN (bar) ¹⁾ Stainless Steel |
|----------------------------------|---------|------|------|------|------------------|------------------|---------------------|---|
| L ³⁾ /S ⁴⁾ | 10 | 6.0 | 37.5 | 38.5 | 10×1.5 | 13 | SKA10X1.5ORB | 358 |
| | 12 | 8.0 | 37.5 | 38.5 | 12×1.5 | 21 | SKA12X1.5ORB | 305 |
| | 12 | 8.0 | 37.5 | 38.5 | 12×2.0 | 255 | SKA12X2ORB | 393 |
| L ³⁾ | 18 | 13.0 | 38.0 | 39.0 | 18×2.0 | 43 | SKA18X2ORB | 290 |
| | 22 | 17.0 | 38.5 | 39.5 | 22×2.0 | 50 | SKA22X2ORB | 250 |
| | 28 | 22.0 | 41.5 | 42.5 | 28×2.0 | 69 | SKA28X2ORB | 204 |
| | 42 | 36.0 | 47.5 | 50.0 | 42×3.0 | 160 | SKA42X3ORB | 182 |
| S ⁴⁾ | 16 | 12.0 | 39.0 | 40.5 | 16×2.0 | 310 | SKA16X2ORB | 305 |
| | 20 | 14.0 | 45.0 | 47.0 | 20×3.0 | 640 | SKA20X3ORB | 358 |
| | 25 | 19.0 | 49.5 | 53.0 | 25×3.0 | 890 | SKA25X3ORB | 294 |

¹⁾Pressure shown = item deliverable

³⁾L = light series; ⁴⁾S = heavy series

 $\frac{PN \text{ (bar)}}{10} = PN \text{ (MPa)}$

*Please add the **suffixes** below according to the material/surface required.

| Order code suffixes | | | |
|---------------------|-----------------------------|--------------|---|
| Material | Suffix surface and material | Example | Standard sealing material (no additional suffix needed) |
| Stainless Steel | 71 | SKA16X2ORB71 | VIT |



SKA-RB Tube bend weld nipple

EO 24° O-ring weld nipple / butt weld

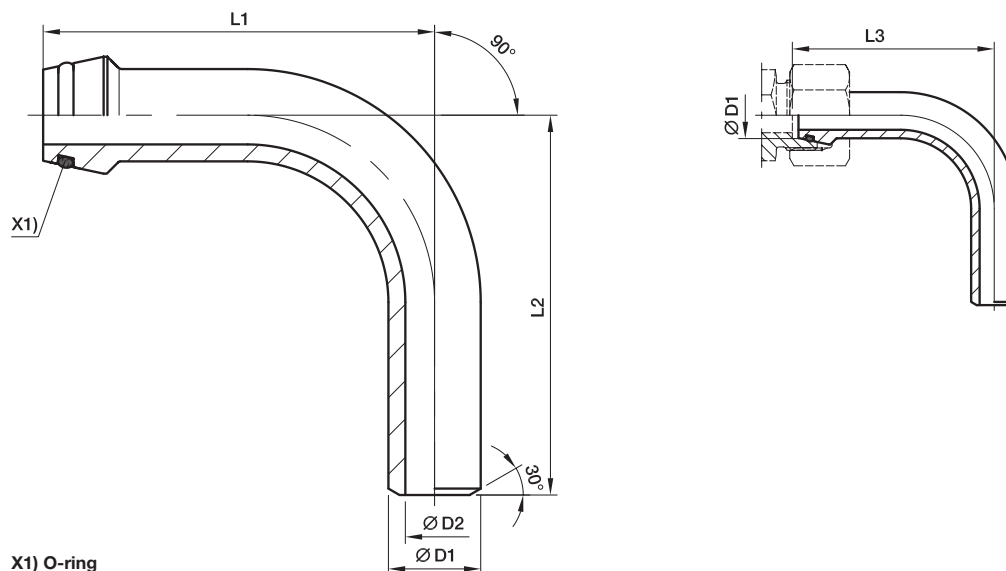

X1) O-ring

| Series | D1 | D2 | L1 | L2 | L3 | recommended tube | Weight g/1 piece | Order code | PN (bar) ¹⁾ | |
|-----------------|----|----|-----|-----|-------|------------------|------------------|--------------------|------------------------|-----------------|
| | | | | | | | | | Steel | Stainless Steel |
| S ⁴⁾ | 10 | 6 | 49 | 45 | 50.0 | 10x2.0 | 38 | SKA10X2RB | 460 | 447 |
| | 12 | 7 | 51 | 50 | 52.0 | 12x2.5 | 50 | SKA12X2.5RB | 476 | 463 |
| | 16 | 10 | 67 | 60 | 68.5 | 16x3.0 | 105 | SKA16X3RB | 400 | 400 |
| | 20 | 12 | 85 | 65 | 87.0 | 20x4.0 | 217 | SKA20X4RB | 400 | 400 |
| | 25 | 17 | 85 | 85 | 88.5 | 25x4.0 | 295 | SKA25X4RB | 379 | 369 |
| | 25 | 15 | 85 | 85 | 88.5 | 25x5.0 | 353 | SKA25X5RB | 400 | 400 |
| | 30 | 22 | 111 | 110 | 116.0 | 30x4.0 | 469 | SKA30X4RB | 323 | 314 |
| | 30 | 20 | 111 | 110 | 116.0 | 30x5.0 | 568 | SKA30X5RB | 393 | 383 |
| | 38 | 28 | 136 | 130 | 143.5 | 38x5.0 | 876 | SKA38X5RB | 315 | 315 |
| | 38 | 26 | 136 | 130 | 143.5 | 38x6.0 | 1045 | SKA38X6RB | 315 | 315 |

¹⁾ Pressure shown = item deliverable

⁴⁾ S = heavy series

$\frac{PN \text{ (bar)}}{10} = PN \text{ (MPa)}$



*Please add the **suffixes** below according to the material/surface required.

| Order code suffixes | | | |
|---------------------|-----------------------------|-------------|---|
| Material | Suffix surface and material | Example | Standard sealing material (no additional suffix needed) |
| Steel | | SKA16X3RB | NBR |
| Stainless Steel | 71 | SKA16X3RB71 | VIT |



Weld fittings
OR O-ring for weld nipple

For Type: SKA, SKAR, SKA-RB

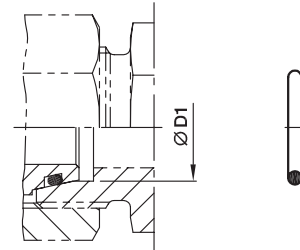

| Series | D1 | O-ring NBR Shore-Hardness approx. 90 | O-ring FKM Shore-Hardness approx. 90 |
|-----------------|-----------|--|--|
| L ³⁾ | 06 | OR4.5X1.5X | OR4.5X1.5VITX |
| | 08 | OR6.5X1.5X | OR6.5X1.5VITX |
| | 10 | OR8.5X1.5X | OR8X1.5VITX |
| | 12 | OR10.5X1.5X | OR10X1.5VITX |
| | 15 | OR12.5X1.5X | OR12X2VITX |
| | 18 | OR16X2X | OR15X2VITX |
| | 22 | OR20X2X | OR20X2VITX |
| S ⁴⁾ | 28 | OR26X2X | OR26X2VITX |
| | 35 | OR32X2.5X | OR32X2.5VITX |
| | 42 | OR39X2.5X | OR38X2.5VITX |
| | 06 | OR4.5X1.5X | OR4.5X1.5VITX |
| | 08 | OR6.5X1.5X | OR6.5X1.5VITX |
| | 10 | OR8.5X1.5X | OR8X1.5VITX |
| | 12 | OR10.5X1.5X | OR10X1.5VITX |
| | 16 | OR14X2X | OR13X2VITX |
| | 20 | OR17X2.5X | OR16.3X2.4VITX |
| | 25 | OR22X2.5X | OR20.3X2.4VITX |
| 30 | OR27X2.5X | OR25.3X2.4VITX | |
| 38 | OR35X2.5X | OR33.3X2.4VITX | |

³⁾L = light series; ⁴⁾S = heavy series



**EO[®] Ermeto Original
High Pressure
Hydraulic Flanges**

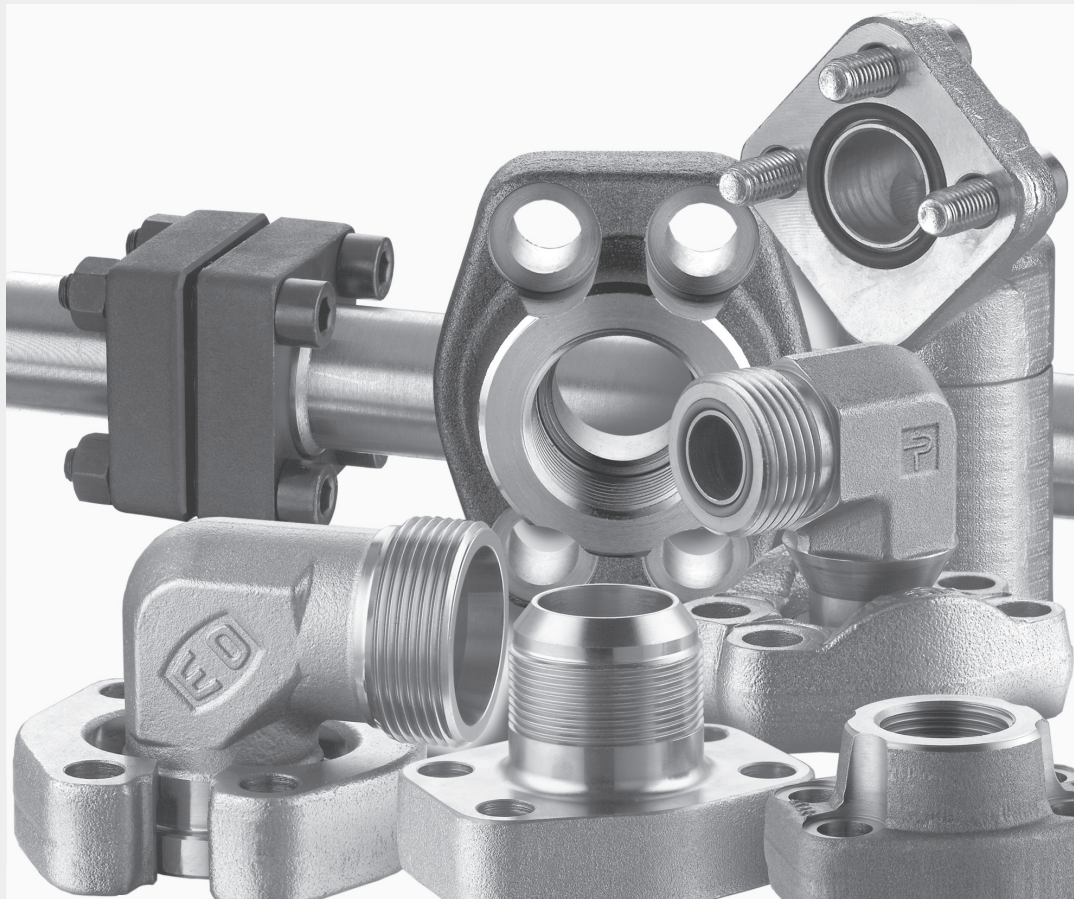

High pressure hydraulic flanges





Table of contents

| | Page |
|--|------|
| Introduction | 4 |
| Design and construction | 4 |
| Methods of connection | 5 |
| How flange connections work | 6 |
| Assembly of flanges | 7 |
| Bolt torques for SAE flanges | 8 |
| Technical data | 9 |
| Order codes bolts and O-rings | 10 |
| Features, advantages and benefits | 11 |
| How to order | 12 |
| Visual index | 13 |
| SAE Flanges clamps | 16 |
| SAE Flange adapters | |
| EO 24° cone end..... | 21 |
| BSPP 60° cone end..... | 25 |
| Male NPT thread..... | 27 |
| O-Lok® ORFS end..... | 28 |
| Triple-Lok® 37° flare end..... | 31 |
| Butt weld end..... | 34 |
| Socket weld end..... | 39 |
| SAE Full flanges | |
| Female BSPP thread..... | 42 |
| Female NPT thread..... | 46 |
| EO 24° cone end..... | 49 |
| BSPP 60° cone end..... | 51 |
| Triple-Lok® 37° flare end..... | 53 |
| O-Lok® ORFS end..... | 55 |
| Butt weld end..... | 57 |
| Socket weld end..... | 60 |
| Complete flange connections..... | 64 |
| SAE Flange accessories | 67 |
| Gear pump flanges | |
| EO 24° cone end..... | 75 |
| O-Lok® ORFS end..... | 78 |
| Male/Female BSPP thread..... | 80 |
| Socket weld end..... | 82 |
| Special pump size flanges..... | 83 |
| Aluminium flanges..... | 86 |
| ISO 6164 Square flanges | 88 |

N

High pressure hydraulic flanges

Introduction

The 4 bolt flange connections conforming to ISO 6162-1/2 (SAE J518 Code 61/62) and ISO 6164 are proven, leak-free connections, especially suited for larger sizes, high pressures and assembly in tight quarters. Threaded port connections such as SAE straight thread O-ring and ISO 6149 are reasonably easy to assemble and provide 6000 psi and higher pressure capability up to size 12 (M27). Beyond this size the pressure rating starts to decrease and assembly torques increase rapidly.

The 4 bolt flange port connections provide ability to connect larger sizes and achieve higher-pressure capability at reasonable assembly torques. Because of the lower assembly torques compared to an equivalent size threaded port, these connections are well suited for tight quarters where wrench clearances are limited.

Design and construction

Parker 4 bolt flange products are designed to provide different methods of connecting a tube, hose, pipe or another fitting to the SAE standard 4-bolt flange port.

Flange fittings – All Parker flange fittings, except for those with square mounting hole pattern, are designed to conform to O-ring groove, bolt holes and bolt pattern dimensions of either ISO 6162-1 (SAE J518 Code 61), ISO 6162-2 (SAE J518 Code 62) and ISO 6164.

The counter fittings have a flat face (no O-ring groove) and the mounting holes are tapped. Where these fittings are used, the seal is in the mating part (flange adapter, flange hose fitting, flange block fitting, etc.) as shown in Fig. 1.

Dimensions other than the O-ring groove, bolt holes, bolt pattern, and the flange foot print are not governed by any industry standard. However, Parker product design follows common industry practice and sound engineering.

Flange clamps – Clamps are used for providing the holding power to the 4 bolt flange connection. They are offered in split and captive (one-piece) versions. The captive ones are also offered with either drilled or tapped bolt holes. The captive flange clamp with tapped holes is used while connecting a tube to another tube or a hose.

Parker flange clamps are forged for higher strength and durability. They meet all requirements of ISO 6162-1 (SAE J518 Code 61), ISO 6162-2 (SAE J518 Code 62) and ISO 6164. The split clamps make it easy to assemble the connection in close quarters. They also make removal of the flange head component, such as a hose assembly, easy by loosening all four bolts and removing one clamp half.

Connector plate – Connector plate is used as a middle plate to connect two flange heads with O-ring grooves, such as two hose assemblies with flange connection ends. The flat surface of the plate provides sealing surface on each side for the O-ring housed in the hose ends.

Spacer plate – Spacer plate provides access to the system fluid via the gage port on the side. The plate is sandwiched in the flange connection to provide this access.

Plugs – Plugs provide a means to block off the 4 bolt flange port with and without clamps, and to plug the end of a pipe (via welding).

Fig. 1 – Flange pad fitting

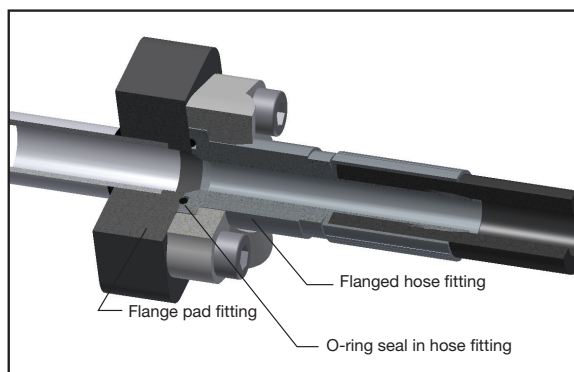



Methods of connection – Parker flange products

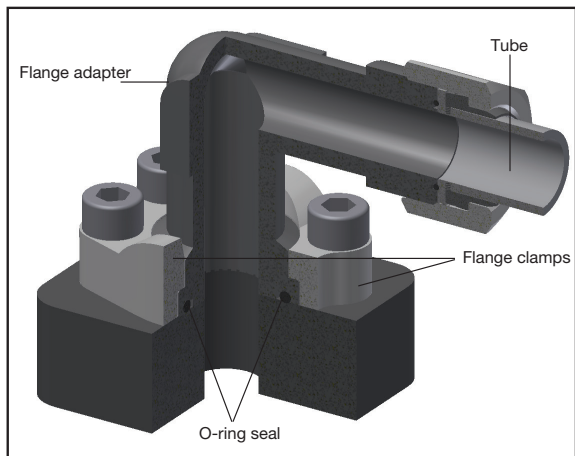

Connecting tube and hose via a threaded tube/hose end connection: The flange adapters provide means of connecting tubes or hoses to a 4 bolt flange port via threaded connection such as Seal-Lok (ORFS), Triple-Lok® (37° flare), etc.

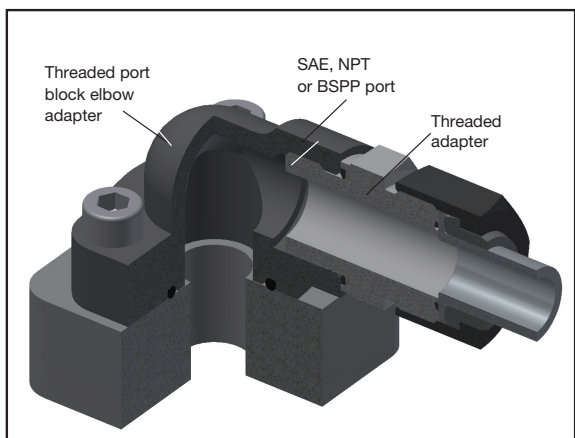

Connecting tube, hose and pipe via threaded port connection. The flange head and flange block conversion adapters provide the means of converting a flange port to either SAE, NPT or BSPP port. A user can then use appropriate threaded adapters to connect tube and hose, or connect threaded pipe directly into NPT and BSPP ports.

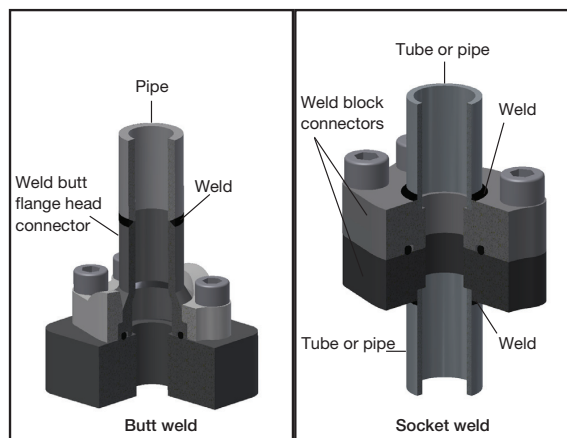

Connecting tube and pipe via welding. The flange head and flange block weld fittings provide the means of connecting tubes and pipes to 4 bolt flange port via socket welding for tubes and socket and butt welding for pipes.

N

High pressure hydraulic flanges

How flange connections work

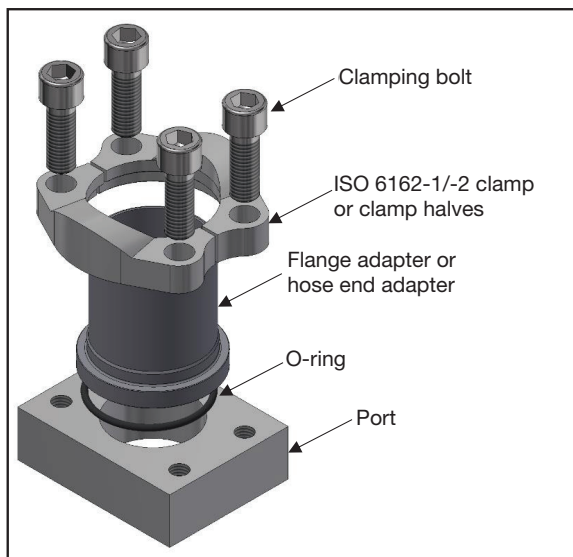

4 bolt flange connection ISO 6162-1/2 (SAE J518 Code 61/62) and ISO 6164 is a proven leak-free connection, especially suited for larger sizes. As a result, it has achieved worldwide acceptance.

The connection's success is in its simplicity. It is a static face seal using a high durometer O-ring (90 shore A) for the seal and clamps and bolts for holding power as shown here.

The (O-ring) seal is compressed between the bottom of the groove in the flange head and the flat surface of the port or flange pad, providing a reliable soft seal. The alternate seal plate has a high durometer bonded rubber seal on the inside edge, which compresses between the two flat surfaces, providing a soft seal with the same reliability. A metal-to-metal contact at the outer face of the flange with the port face keeps the seal from extruding under pressure. This metal-to-metal contact is maintained by the clamping force provided by tightening of the bolts via the clamps.

This simple design provides several advantages over threaded port connections, such as NPT, SAE, BSPP, ISO 6149, etc., in larger sizes:

- Ability to connect up to 5 inch O.D. tube (ISO 6162-1 only)
- Much lower tightening torque required from the four bolts compared to that required for equivalent size threaded port.
- Less tightening torque means smaller wrenches and wrench swing clearances – providing ease of assembly in tight quarters.
- Up to 6000 psi capability through 3" size (ISO 6162-2 only)
- Use up to 400 bar at the ISO 6164 flange sizes from 3/8" to 4".
- Single seal point between tube/pipe/hose assembly and the port
- Ease of disassembly through use of split clamps



Flanges

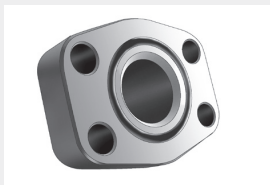

Assembly of flanges

- SAE flange adapters
- SAE 4 bolt flanges
- Gear pump flanges
- ISO 6164 Square flanges

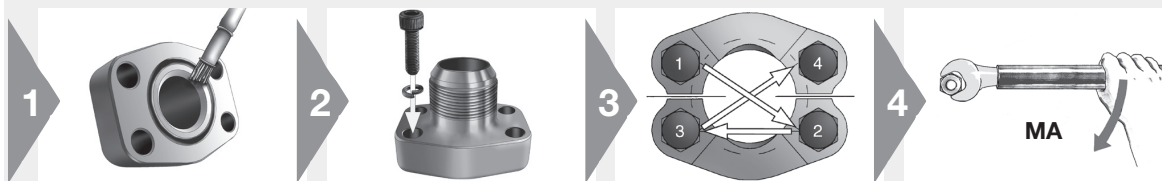

- Make sure sealing surfaces are free of burrs, nicks, scratches or any contamination
- Lubricate the O-ring with system fluid or compatible lubricant
- Parker recommends to lubricate the bolts on contact surface (head) and lower third of thread (MOLYKOTE G-RAPID PLUS) just before use to avoid any contamination

- Position flange or flange adapter with clamp halves
- Placement of the spring washer on the bolt and connect both to the flange (only for gear pump flanges)

- Hand tighten bolts
- Torque bolts in diagonal sequence in small increments to the appropriate torque level listed in chart

- Tighten bolts according to chart

N

High pressure hydraulic flanges

Bolt torques for SAE-Flanges
Recommended torques for metric bolts ISO 4762-10.9 at the specified coefficient of friction μ_{tot}^1
for SAE Flange connections according ISO 6162-1 (3000 PSI Serie)

| DN size | Flange size | Metric bolts (ISO 4762-10.9) | Torque $\mu_{tot} = 0.08$ Nm ² | Torque $\mu_{tot} = 0.14$ Nm ² |
|---------|-------------|------------------------------|---|---|
| 13 | 1/2 | M8 | 23 | 36 |
| 19 | 3/4 | M10 | 44 | 70 |
| 25 | 1 | M10 | 44 | 70 |
| 32 | 1 1/4 | M10 | 44 | 70 |
| 38 | 1 1/2 | M12 / M14 ³⁾ | 75 / 90 | 120 / 140 |
| 51 | 2 | M12 / M14 ³⁾ | 75 / 90 | 120 / 140 |
| 64 | 2 1/2 | M12 / M14 ³⁾ | 75 / 90 | 120 / 140 |
| 76 | 3 | M16 | 155 | 250 |
| 89 | 3 1/2 | M16 | 155 | 250 |
| 102 | 4 | M16 | 155 | 250 |
| 127 | 5 | M16 | 155 | 250 |

for SAE Flange connections according ISO 6162-2 (6000 PSI Serie)

| DN size | Flange size | Metric bolts (ISO 4762-10.9) | Torque $\mu_{tot} = 0.08$ Nm ² | Torque $\mu_{tot} = 0.14$ Nm ² |
|---------|-------------|------------------------------|---|---|
| 13 | 1/2 | M8 | 23 | 36 |
| 19 | 3/4 | M10 | 44 | 70 |
| 25 | 1 | M12 | 75 | 120 |
| 32 | 1 1/4 | M12 / M14 ³⁾ | 75 / 90 | 120 / 140 |
| 38 | 1 1/2 | M16 | 155 | 250 |
| 51 | 2 | M20 | 270 | 440 |
| 64 | 2 1/2 | M24 | 450 | 700 |
| 76 | 3 | M30 | 875 | 1420 |

Recommended torques for inch bolts (UNC thread) ANSI/ASME B18.3 at the specified coefficient of friction μ_{tot}^1
for SAE Flange connections according ISO 6162-1 (3000 PSI Serie)

| DN size | Flange size | Inch bolts (ANSI/ASME B18.3) | Torque $\mu_{tot} = 0.17$ Nm ² |
|---------|-------------|------------------------------|---|
| 13 | 1/2 | 5/16-18 | 45 |
| 19 | 3/4 | 3/8-16 | 80 |
| 25 | 1 | 3/8-16 | 80 |
| 32 | 1 1/4 | 7/16-14 | 130 |
| 38 | 1 1/2 | 1/2-13 | 210 |
| 51 | 2 | 1/2-13 | 210 |
| 64 | 2 1/2 | 1/2-13 | 210 |
| 76 | 3 | 5/8-11 | 300 |
| 89 | 3 1/2 | 5/8-11 | 300 |
| 102 | 4 | 5/8-11 | 300 |
| 127 | 5 | 5/8-11 | 300 |

for SAE Flange connections according ISO 6162-2 (6000 PSI Serie)

| DN size | Flange size | Inch bolts (ANSI/ASME B18.3) | Torque $\mu_{tot} = 0.17$ Nm ² |
|---------|-------------|------------------------------|---|
| 13 | 1/2 | 5/16-18 | 45 |
| 19 | 3/4 | 3/8-16 | 80 |
| 25 | 1 | 7/16-14 | 130 |
| 32 | 1 1/4 | 1/2-13 | 210 |
| 38 | 1 1/2 | 5/8-11 | 300 |
| 51 | 2 | 3/4-10 | 510 |

Gear Pump Flange recommend torque

| Socket bolt bolt circle (LK) | Socket head cap bolts | Tightening torques Nm ² |
|------------------------------|-----------------------|------------------------------------|
| LK30 | M6 | 10 |
| LK35 | M6 | 10 |
| LK40 | M6 | 10 |
| LK51 | M10 | 49 |
| LK55 | M8 | 25 |
| LK56 | M10 | 49 |
| LK62 | M10 | 49 |
| LK72.5 | M12 | 85 |

¹⁾ The specified friction coefficients are valid for supplied bolts by Parker.

For lubricated bolts (MOLYKOTE G-RAPIDE PLUS) the friction coefficient $\mu_{tot} = 0.08$ has been determined.

For Zinc flaked metric bolts (...ZNFLX) as delivered the friction coefficient $\mu_{tot} = 0.14$ has been determined.

For phosphated bolts we are referring to the ISO 6162.1 and -2 for $\mu_{tot} = 0.17$.

²⁾ Torque tolerances max. 10%, min. 0%

³⁾ Bolt size M14 is no longer mentioned in the ISO 6162-1 and -2 and should not be used for new constructions.



Technical data

Flange bolts

SAE Flanges according to ISO 6162-1 and -2 (SAE J518)

- metric bolts according to ISO 4762-10.9 (DIN 912-10.9) or higher quality
 - UNC bolts according to ANSI/ASME B 18.3
- UNC bolts acc. to ISO 6162-1 and -2 should not be used for new designs.

Square flanges according to ISO 6164 (1994)

- metric bolts according to ISO 4762-8.8 (DIN 912-8.8) or ISO 4762-10.9 (DIN 912-10.9)

Gear pump flanges

- metric bolts according to ISO 4762-8.8 (DIN 912-8.8)

Surface protection bolts

- ISO 4762-8.8 - zinc plated A3K (VZX)
- ISO 4762-10.9 - zinc flaked (ZNFLX)

We reserve the right to deliver black phosphated bolts ISO 4762-10.9, for achieving the best lead time if not specifically designated in the order.

Used Sealing

Materials

Flanges according **SAE J518 (ISO 6162-1 and -2)**, **ISO 6164** and all **gear pump flanges** in this catalogue are sealed with an O-ring. The seals of our flanges are out of the following materials:

- NBR (e.g. perbunan) 90 shore A durometer is our standard seal material for hydraulic **steel** flange applications.
- FKM 85 or 90 shore A durometer is our standard seal material for hydraulic **stainless steel** flange applications.

Perbunan = registered trademark of Bayer

Dimensions

O-ring dimensions of ISO 6164 flanges, and gear pump flanges are shown direct on the product catalogue page. For all flanges according to **ISO 6162-1/2 (SAE J518 Code 61/62)** the O-ring dimension are according to the following table:

| Nominal flange size | Nominal-inch tube size (in inches) | ISO 3601-1 SAE J515 O-ring | O-ring size number |
|---------------------|------------------------------------|----------------------------|--------------------|
| 13 | 1/2 | 18.64×3.53 | 210 |
| 19 | 3/4 | 24.99×3.53 | 214 |
| 25 | 1 | 32.92×3.53 | 219 |
| 32 | 1 1/4 | 37.69×3.53 | 222 |
| 38 | 1 1/2 | 47.22×3.53 | 225 |
| 51 | 2 | 56.74×3.53 | 228 |
| 64 | 2 1/2 | 69.44×3.53 | 232 |
| 76 | 3 | 85.32×3.53 | 237 |
| 89 | 3 1/2 | 98.02×3.53 | 241 |
| 102 | 4 | 110.72×3.53 | 245 |
| 127 | 5 | 136.12×3.53 | 253 |

Pressure ratings

The maximum recommended working pressure is indicated for each article.

Before using a part, please take notice of the pressure ratings.

All pressure indications are based on a working temperature from –20° celsius up to +100° celsius (resp. ambient temperature from –40° celsius up to +120° celsius). Outside of this temperature range the physical properties of the material is affected and the maximum recommended working pressure is reduced.

The indicated working pressures refer only to the flange itself. For the tubes, fittings and connections the pressure ratings of the specific manufacturer must also be taken into account.

Materials

SAE flanges according to ISO 6162-1 and -2 (SAE 518)

Flange clamps, flange adapter and forged 4 bolt flanges are made of the material ST 52.3 or compatible for **steel** construction. For **stainless steel** constructions we are using for flange clamps, flange adapters and 4 bolt forged flanges the material 1.4401 (316) or compatible. For special applications it is also possible to get the flange adapters made from the material 1.4571 (316Ti).

Square flanges according to ISO 6164 (1994)

Steel construction: ST52.3, C40 or compatible

Stainless steel construction: 1.4571 (316Ti) or compatible

Gear pump flanges

Cast steel construction: GTW40 or compatible

Steel construction: ST52.3, 11SMnPb30 or compatible

Forged steel construction: ST52.3 or compatible

If different materials are used for manufacturing, this will be shown on the catalogue product page.



Surface protection

All surface order possibilities are described on each catalogue page!

Surface possibilities are:

1. Oil dipped, phosphated
2. Cr(VI)-free surface protection CF (type CF, CR3, CFL) with same or better corrosion resistance than yellow zinc chromated surface protection (A3C).

High pressure hydraulic flanges

Order codes bolts and O-rings

Bolts for flanges

according ISO 6162-1 and -2 (SAE J518)

| Nominal flange size | | | Bolts for flanges and flange halves | | Bolts for full flanges | |
|---------------------|-----|-------|-------------------------------------|-------------------|------------------------|-------------------|
| Series | ISO | SAE | metr. Order code | UNC Order code | metr. Order code | UNC Order code |
| 3000 PSI | 13 | 1/2 | ZYLS8X25109ZNFLX | UNC5/16-18X11/4 | ZYLS8X30109ZNFLX * | UNC5/16-18X11/4 |
| 3000 PSI | 19 | 3/4 | ZYLS10X30109ZNFLX | UNC3/8-16X11/4 | ZYLS10X35109ZNFLX * | UNC3/8-16X11/2 * |
| 3000 PSI | 25 | 1 | ZYLS10X30109ZNFLX | UNC3/8-16X11/4 | ZYLS10X35109ZNFLX * | UNC3/8-16X11/2 * |
| 3000 PSI | 32 | 1 1/4 | ZYLS10X30109ZNFLX | UNC7/16-14X11/2 | ZYLS10X40109ZNFLX * | UNC7/16-14X11/2 |
| 3000 PSI | 32 | 1 1/4 | ZYLS10X35109ZNFLX * | — | — | — |
| 3000 PSI | 32 | 1 1/4 | ZYLS12X35109ZNFLX * | — | — | — |
| 3000 PSI | 38 | 1 1/2 | ZYLS12X35109ZNFLX | UNC1/2-13X11/2 | ZYLS12X45109ZNFLX * | UNC1/2-13X13/4 * |
| 3000 PSI | 38 | 1 1/2 | ZYLS14X35109ZNFLX * | — | — | — |
| 3000 PSI | 51 | 2 | ZYLS12X35109ZNFLX | UNC1/2-13X11/2 | ZYLS12X45109ZNFLX * | UNC1/2-13X13/4 * |
| 3000 PSI | 51 | 2 | ZYLS14X35109ZNFLX * | — | — | — |
| 3000 PSI | 64 | 2 1/2 | ZYLS12X40109ZNFLX | UNC1/2-13X13/4 | ZYLS12X45109ZNFLX * | UNC1/2-13X13/4 * |
| 3000 PSI | 64 | 2 1/2 | ZYLS14X35109ZNFLX * | UNC1/2-13X11/2 * | — | — |
| 3000 PSI | 76 | 3 | ZYLS16X50109ZNFLX | UNC5/8-11X13/4 | ZYLS16X55109ZNFLX * | UNC5/8-11X21/4 * |
| 3000 PSI | 76 | 3 | ZYLS16X45109ZNFLX * | UNC5/8-11X2 * | — | — |
| 3000 PSI | 89 | 3 1/2 | ZYLS16X50109ZNFLX | UNC5/8-11X2 | ZYLS16X55109ZNFLX * | UNC5/8-11X21/4 * |
| 3000 PSI | 89 | 3 1/2 | ZYLS16X45109ZNFLX * | — | — | — |
| 3000 PSI | 102 | 4 | ZYLS16X50109ZNFLX | UNC5/8-11X2 | ZYLS16X55109ZNFLX * | UNC5/8-11X21/4 * |
| 3000 PSI | 102 | 4 | ZYLS16X45109ZNFLX * | — | — | — |
| 3000 PSI | 127 | 5 | ZYLS16X55109ZNFLX | UNC5/8-11X21/4 | ZYLS16X55109ZNFLX | UNC5/8-11X21/4 |
| 3000 PSI | 127 | 5 | ZYLS16X50109ZNFLX * | UNC5/8-11X2 * | — | — |
| 6000 PSI | 13 | 1/2 | ZYLS8X30109ZNFLX | UNC5/16-18X11/4 | ZYLS8X30109ZNFLX | UNC5/16-18X11/4 |
| 6000 PSI | 19 | 3/4 | ZYLS10X35109ZNFLX | UNC3/8-16X11/2 | ZYLS10X35109ZNFLX | UNC3/8-16X11/2 |
| 6000 PSI | 25 | 1 | ZYLS12X45109ZNFLX | UNC7/16-14X13/4 | ZYLS12X45109ZNFLX | UNC7/16-14X11/2 * |
| 6000 PSI | 25 | 1 | — | UNC7/16-14X11/2 * | — | — |
| 6000 PSI | 32 | 1 1/4 | ZYLS12X45109ZNFLX | UNC1/2-13X13/4 | ZYLS12X50109ZNFLX | UNC1/2-13X13/4 |
| 6000 PSI | 32 | 1 1/4 | ZYLS14X50109ZNFLX * | — | ZYLS14X50109ZNFLX * | — |
| 6000 PSI | 38 | 1 1/2 | ZYLS16X55109ZNFLX | UNC5/8-11X21/4 | ZYLS16X55109ZNFLX | UNC5/8-11X21/4 |
| 6000 PSI | 38 | 1 1/2 | — | UNC5/8-11X2 * | — | — |
| 6000 PSI | 51 | 2 | ZYLS20X70109ZNFLX | UNC3/4-10X23/4 | ZYLS20X70109ZNFLX | UNC3/4-10X23/4 |
| 6000 PSI | 51 | 2 | ZYLS20X65109ZNFLX * | UNC3/4-10X21/2 * | — | — |
| 6000 PSI | 64 | 2 1/2 | ZYLS24X75109ZNFLX * | — | ZYLS24X90109ZNFLX * | — |
| 6000 PSI | 76 | 3 | ZYLS30X90109ZNFLX | — | ZYLS30X110109ZNFLX * | — |

* = are not implemented in the ISO 6162 -1 and ISO 6162-2.

Bolts for gear pump flanges

(BFG, BFW)

| Typ | Bolts Order code | Description |
|---------------|------------------|-------------|
| BFG (10L-28L) | ZYLS6X22VZX | 4 pieces |
| BFG (20S) | ZYLS8X25VZX | 4 pieces |

| Type | LK | Bolts | | Description | |
|------|-----|------------|-------------|-------------|-----------------------|
| | | Order code | Order code | | |
| BFW | 10L | 35 | ZYLS6X22VZX | ZYLS6X35VZX | 2 Pieces of each bolt |
| BFW | 12L | 35 | ZYLS6X22VZX | ZYLS6X35VZX | 2 Pieces of each bolt |
| BFW | 15L | 35 | ZYLS6X22VZX | ZYLS6X35VZX | 2 Pieces of each bolt |
| BFW | 16S | 35 | ZYLS6X22VZX | ZYLS6X40VZX | 2 Pieces of each bolt |
| BFW | 20S | 35 | ZYLS6X22VZX | ZYLS6X45VZX | 2 Pieces of each bolt |
| BFW | 15L | 40 | ZYLS6X22VZX | — | 4 Pieces |
| BFW | 18L | 40 | ZYLS6X22VZX | — | 4 Pieces |
| BFW | 22L | 40 | ZYLS6X22VZX | — | 4 Pieces |
| BFW | 28L | 40 | ZYLS6X20VZX | ZYLS6X50VZX | 2 Pieces of each bolt |
| BFW | 35L | 40 | ZYLS6X22VZX | ZYLS6X60VZX | 2 Pieces of each bolt |
| BFW | 20S | 40 | ZYLS6X22VZX | ZYLS6X45VZX | 2 Pieces of each bolt |
| BFW | 35L | 55 | ZYLS8X25VZX | ZYLS8X60VZX | 2 Pieces of each bolt |
| BFW | 42L | 55 | ZYLS8X25VZX | ZYLS8X70VZX | 2 Pieces of each bolt |
| BFW | 20S | 55 | ZYLS8X25VZX | ZYLS8X50VZX | 2 Pieces of each bolt |
| BFW | 25S | 55 | ZYLS8X25VZX | ZYLS8X55VZX | 2 Pieces of each bolt |
| BFW | 30S | 55 | ZYLS8X25VZX | ZYLS8X50VZX | 2 Pieces of each bolt |

O-rings for flanges

SAE J518

| ISO (DN) | SAE (Inch) | O-ring | |
|----------|------------|----------------|-------------------|
| | | NBR Order code | FKM Order code |
| 13 | 1/2 | OR18.64X3.53X | OR18.64X3.53VITX |
| 19 | 3/4 | OR25X3.53X | OR25X3.53VITX |
| 25 | 1 | OR32.92X3.53X | OR32.92X3.53VITX |
| 32 | 1 1/4 | OR37.69X3.53X | OR37.69X3.53VITX |
| 38 | 1 1/2 | OR47.22X3.53X | OR47.22X3.53VITX |
| 51 | 2 | OR56.75X3.53X | OR56.75X3.53VITX |
| 64 | 2 1/2 | OR69.44X3.53X | OR69.44X3.53VITX |
| 76 | 3 | OR85.32X3.53X | OR85.32X3.53VITX |
| 89 | 3 1/2 | OR98.02X3.53X | OR98.02X3.53VITX |
| 102 | 4 | OR110.72X3.53X | OR110.72X3.53VITX |
| 127 | 5 | OR136.12X3.53X | OR136.12X3.53VITX |

O-rings for hydraulic flanges

(BFG, BFW)

| LK | O-ring size | Order code |
|----|-------------|------------|
| 35 | 20×2.5 | OR20X2.5X |
| 40 | 26×2.5 | OR26X2.5X |
| 55 | 32×2.5 | OR32X2.5X |



Features, advantages and benefits

- 1. Manufacture** – ISO 6162-1/2 fittings conform to SAE J518 and Code 61/62. This international standards control dimensions and tolerances of high pressure hydraulic flanges.
- 2. Available configurations** – Over 60 different configurations are standard in a range of sizes. The breadth of product provides flexibility in plumbing to insure the best solution possible.
- 3. Materials** – All configurations are available as standard in steel, with commonly used styles available in stainless steel.
- 4. Available sizes** – Most configurations are available as standard in 1/2" through 2" with sizes as large as 5" available in some styles.
- 5. Construction** – Parker offers a completely forged steel product line to insure our products hold up in the most rigorous applications.
- 6. Envelope size** – Forged construction provides a compact design compared to flanges machined from block steel.
- 7. Pressure ratings** – ISO 6162-1/2 fittings and flanges have pressure ratings up to 6000 psi. The recommended working pressure can be found directly on each catalogue page. This is a quick and easy way to verify the part in question meets the application pressure requirements.
- 8. Flange kits** – To reduce ordering and assembly errors, kits that include mounting hardware (bolts, O-ring, and if needed flange halves) are available.
- 9. Mounting hardware** – Bolts used in mounting kits are designated at least grade 8.8 to provide long dependable use.

N

High pressure hydraulic flanges

How to order

SAE Flange adapters



WFS SAE 90° Elbow flange adapter

SAE Flange / EO 24° cone end (ISO 6162-1/-2)

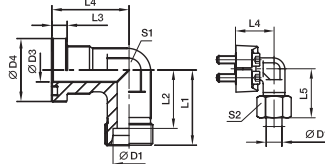

3000 PSI Series

| Nom. flange size SAE (in.) | ISO (DN) | D1 ¹⁾ | D3 | D4 | L1 | L2 | L3 | L4 | L5 | S1 | S2 | Screws | | Weight (steel) kg/piece | Order code* | PN (bar) ¹⁾ | |
|-------------------------------|----------|------------------|----|------|----|------|-----|----|------|----|----|---------|------------|----------------------------|----------------------------------|------------------------|-----|
| | | | | | | | | | | | | (metr.) | (unc.) | | | CF | 71 |
| 1/2 | 13 | 12S | 12 | 30.2 | 50 | 42.5 | 6.7 | 44 | 58.5 | 22 | 24 | M 08x25 | 5/16x1 1/4 | 0.38 | WFS32/12S | 210 | 210 |
| 1/2 | 13 | 15L | 12 | 30.2 | 36 | 29.0 | 6.7 | 36 | 44.0 | 24 | 27 | M 08x25 | 5/16x1 1/4 | 0.40 | WFS32/15L | 315 | 315 |
| 1/2 | 13 | 16S | 12 | 30.2 | 36 | 29.5 | 6.7 | 36 | 46.0 | 24 | 30 | M 08x25 | 5/16x1 1/4 | 0.43 | WFS32/16S | 350 | 350 |
| 1/2 | 13 | 18L | 12 | 30.2 | 50 | 42.5 | 6.7 | 44 | 59.0 | 22 | 32 | M 08x25 | 5/16x1 1/4 | 0.44 | WFS32/18L | 315 | 315 |
| 3/4 | 19 | 16S | 19 | 38.1 | 64 | 55.5 | 6.7 | 53 | 73.5 | 27 | 30 | M 10x30 | 3/8x1 1/4 | 0.60 | WFS33/16S | 350 | 350 |
| 3/4 | 19 | 18L | 19 | 38.1 | 39 | 31.5 | 6.7 | 42 | 48.0 | 30 | 32 | M 10x30 | 3/8x1 1/4 | 0.66 | WFS33/18L | 315 | 315 |
| 3/4 | 19 | 22L | 19 | 38.1 | 41 | 33.5 | 6.7 | 42 | 50.0 | 30 | 36 | M 10x30 | 3/8x1 1/4 | 0.66 | WFS33/22L | 160 | 160 |
| 3/4 | 19 | 20S | 17 | 38.1 | 43 | 32.5 | 6.7 | 42 | 54.0 | 30 | 36 | M 10x30 | 3/8x1 1/4 | 0.76 | WFS33/20S | 350 | 350 |
| 3/4 | 19 | 25S | 17 | 38.1 | 45 | 33.0 | 6.7 | 42 | 57.0 | 30 | 46 | M 10x30 | 3/8x1 1/4 | 0.89 | WFS33/25S | 350 | 350 |
| 1 | 25 | 20S | 20 | 44.5 | 65 | 54.5 | 8.0 | 60 | 77.0 | 34 | 36 | M 10x30 | 3/8x1 1/4 | 0.74 | WFS34/20S | 350 | 350 |
| 1 | 25 | 22L | 18 | 44.5 | 65 | 57.5 | 8.0 | 60 | 74.0 | 34 | 36 | M 10x30 | 3/8x1 1/4 | 0.74 | WFS34/22L | 160 | 160 |
| 1 | 25 | 28L | 25 | 44.5 | 44 | 36.5 | 8.0 | 45 | 53.0 | 36 | 41 | M 10x30 | 3/8x1 1/4 | 0.74 | WFS34/28L | 160 | 160 |
| 1 | 25 | 25S | 20 | 44.5 | 48 | 36.5 | 8.0 | 45 | 57.0 | 36 | 46 | M 10x30 | 3/8x1 1/4 | 0.74 | WFS34/25S | 160 | 160 |
| 1 | 25 | 30S | 24 | 44.5 | 50 | 36.5 | 8.0 | 45 | 63.0 | 36 | 50 | M 10x30 | 3/8x1 1/4 | 0.74 | WFS34/30S | 160 | 160 |
| 1 1/4 | 32 | 35L | 32 | 50.8 | 57 | 46.5 | 8.0 | 50 | 68.0 | 41 | 50 | M 10x35 | 3/8x1 1/4 | 0.74 | WFS35/35L/10³⁾ | 200 | 200 |
| 1 1/4 | 32 | 25S | 27 | 50.8 | 55 | 43.0 | 8.0 | 50 | 67.0 | 41 | 46 | M 10x35 | 3/8x1 1/4 | 0.74 | WFS35/25S/10 | 200 | 200 |
| 1 1/4 | 32 | 30S | 28 | 50.8 | 57 | 43.5 | 8.0 | 50 | 70.0 | 41 | 50 | M 10x35 | 3/8x1 1/4 | 1.13 | WFS35/30S/10 | 160 | 160 |
| 1 1/4 | 32 | 38S | 28 | 50.8 | 59 | 43.0 | 8.0 | 50 | 74.0 | 46 | 60 | M 10x35 | 3/8x1 1/4 | 1.13 | WFS35/38S | 200 | 200 |
| 1 1/4 | 32 | 35L | 32 | 50.8 | 57 | 46.5 | 8.0 | 50 | 68.0 | 41 | 50 | M 12x40 | 7/16x1 1/2 | 1.35 | WFS35/35S/10 | 160 | 160 |
| 1 1/4 | 32 | 25S | 27 | 50.8 | 55 | 43.0 | 8.0 | 50 | 67.0 | 41 | 46 | M 12x40 | 7/16x1 1/2 | 1.35 | WFS35/25S/10 | 200 | 200 |
| 1 1/4 | 32 | 30S | 28 | 50.8 | 57 | 43.5 | 8.0 | 50 | 70.0 | 41 | 50 | M 12x40 | 7/16x1 1/2 | 1.40 | WFS35/30S/10 | 200 | 200 |
| 1 1/4 | 32 | 38S | 28 | 50.8 | 59 | 43.0 | 8.0 | 50 | 74.0 | 41 | 60 | M 12x40 | 7/16x1 1/2 | 1.53 | WFS35/38S | 200 | 200 |
| 1 1/2 | 38 | 35L | 30 | 60.3 | 78 | 67.5 | 8.0 | 66 | 93.0 | 50 | 50 | M 12x35 | 1/2x1 1/2 | 1.55 | WFS36/35L | 160 | 160 |
| 1 1/2 | 38 | 42L | 36 | 60.3 | 58 | 47.0 | 8.0 | 55 | 70.0 | 50 | 60 | M 12x35 | 1/2x1 1/2 | 1.60 | WFS36/42L | 160 | 160 |
| 1 1/2 | 38 | 38S | 36 | 60.3 | 64 | 48.0 | 8.0 | 55 | 79.0 | 50 | 60 | M 12x35 | 1/2x1 1/2 | 1.95 | WFS36/38S | 200 | 200 |

¹⁾ Pressure shown = item deliverable

²⁾ L = light series; S = heavy series

PN (bar) = PN (MPa)

10

Delivery without nut and ring. Information on ordering complete fittings or alternative sealing materials see page N11.

³⁾ Order code for the elbow flange adapter assembled with WFS35/10CFX and M10x35 screws.

*Please add the suffixes below to the material/surface required

| Material | Standard sealing material (no additional suffix needed) |
|---------------------------------|---|
| Steel, zinc plated, Cr(VI)-free | MDCFU NBR |
| Stainless steel | VIT |



Catalogue 4100-10/UK

The right way to order made easy!

Step 1 Selecting order code

1. All flange sizes available in our program of supply are clearly listed in the index at the front of this catalogue.
2. Open the catalogue at the corresponding page containing detailed information of the product of your choice.
3. Select the required flange size! The basic order code is printed in bold type on the right-hand side of the table of dimensions. Example: **WFS34/30S**

Step 2 Selecting material and surface ...

Now simply add the corresponding ID code for the surface and material variant of the product you require to the basic order code. This ID code is contained in the table printed at the bottom of every page. Example: **WFS34/30S + CFX = WFS34/30SCFX**

4. **Ordering single parts**
Example: single part, Cr(VI)-free galvanized
WFS34/30S + CFX = WFS34/30SCFX
5. **Ordering complete types**
Example: order incl. splitflanges, metric-bolt pack and O-ring
WFS34/30S + OMDCF = WFS34/30SOMDCF
6. **Order containing nut and cutting ring**
Example: flange incl. splitflanges, metric-bolt pack, O-ring, nut and cutting ring
WFS34/30S + CF = WFS34/30SCF
7. **Order with functional nut**
Example: flange incl. splitflanges, metric-bolt pack, O-ring, nut and functional nut
WFS34/30 (+Z) S + CF = WFS34/30ZSCF
8. **Other sealing materials**
Example: flange made of steel incl. splitflanges, metric-bolt pack and O-ring made of **FKM**.
WFS34/30S + VITOMDCF = WFS34/30SVITOMDCF

Example: flange made of stainless steel incl. splitflanges, metric-bolt pack and O-ring made of **NBR** (for example, Perbunan).
WFS34/30S + NBR0MD71 = WFS34/30SNBR0MD71

Perbunan = registered trademark of Bayer

The corresponding order variant is contained in the table printed at the bottom of every page in the catalogue.



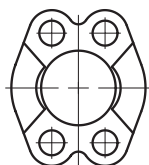
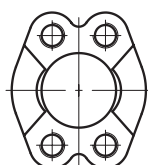

SAE Flange clamps

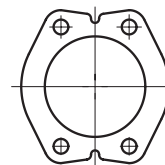
FHS – p. N16

FUS – p. N17

FUSM – p. N18

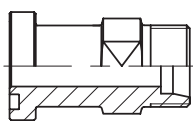
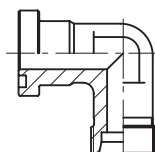
FHSF – p. N19

FUSF – p. N20

SAE Flange adapters

EO 24° cone end

GFS – p. N21

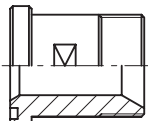
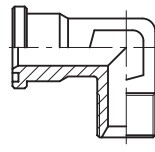
WFS – p. N23

BSPP 60° cone end

GFS-G – p. N25

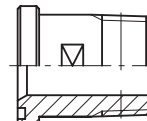
WFS-G – p. N26

Male NPT thread

GFS-N – p. N27

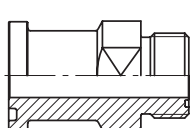
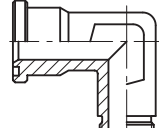
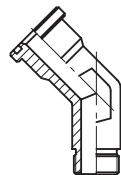
O-Lok® ORFS end

L(O)HQ – p. N28

L(O)EMQ – p. N29

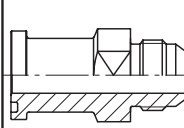
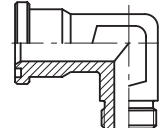
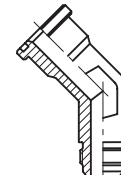
L(O)VQ – p. N30

Triple-Lok® 37° flare end

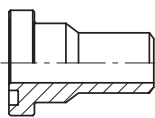
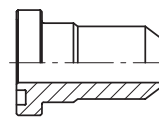
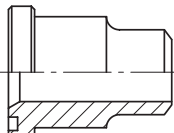
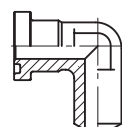
XHQ – p. N31

XEMQ – p. N32

XVQ – p. N33

Butt weld end

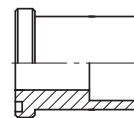
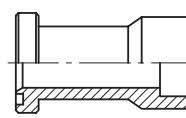

ASR – p. N34

AS – p. N35

ASL – p. N37

WAS – p. N38

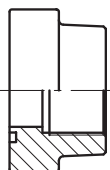
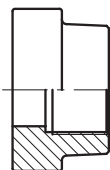
Socket weld end

ES – p. N39

ESL – p. N41

SAE Full flanges

Female BSPP thread

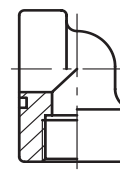
PFF-G – p. N42

PCFF-G – p. N43

PAFSF-G – p. N44

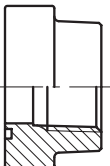
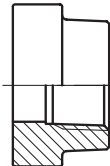
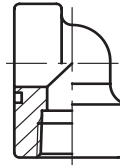
PEFF-G – p. N45

Female NPT thread

PFF-N – p. N46

PCFF-N – p. N47

PEFF-N – p. N48

N



Visual index

SAE Full flanges

EO 24° cone end

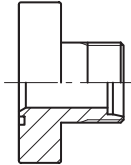

PFF...S/L – p. N49

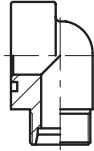

PAFG-90M – p. N50

BSPP 60° cone end

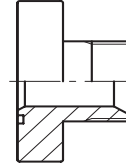

PAFG-G – p. N51



PAFG-90G – p. N52

Triple-Lok® 37° flare end

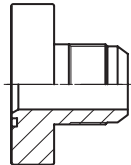

PAFG-X – p. N53



PAFG-90X – p. N54

O-Lok® ORFS end

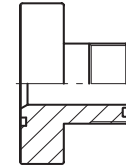

PAFG-L – p. N55



PAFG-90L – p. N56

Butt weld end

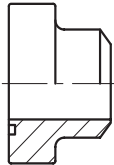

PAFS-B – p. N57

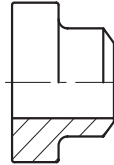

PGFS-B – p. N58

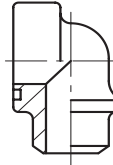

PAFS-90B – p. N59

Socket weld end

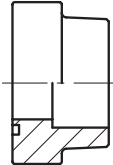

PAFS-S – p. N60

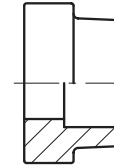

PGFS-S – p. N61



PAFSF-S – p. N62

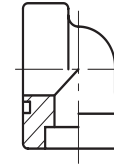

PAFS-90S – p. N63

Complete flange connections

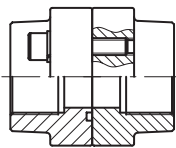

PDFS-G – p. N64

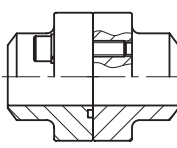

PDFS-B – p. N65

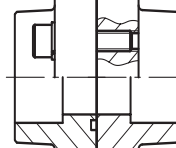

PDFS-S – p. N66

SAE Flange accessories

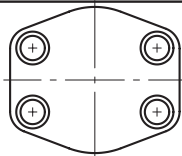

PCFF – p. N67

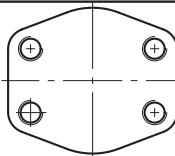

PCCFF – p. N68

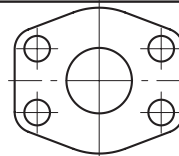

CPM – p. N69

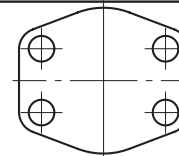

AP – p. N70



PMQ flat – p. N71

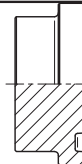

PMQ – p. N72

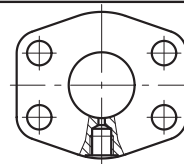

PAGL-(G/M) – p. N73

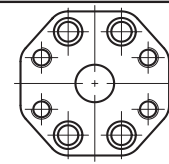

PRF – p. N74

Gear pump flanges

EO 24° cone end

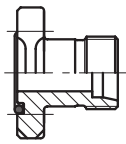
BFG – p. N75

BFW – p. N76

BFW3 – p. N77

O-Lok® ORFS end

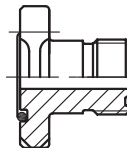
BFGL – p. N78

BFWL – p. N79

Male/Female BSPP thread

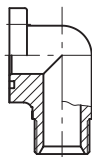

BFW-G – p. N80

BFW-GI – p. N81

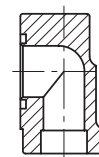
Socket weld end

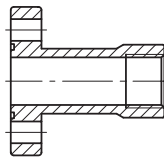
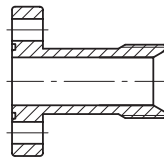
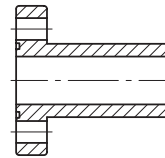
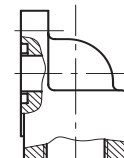

BFW-S – p. N82

Special pump size flanges

PF – p. N83

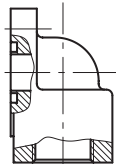
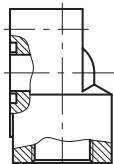
PFL – p. N83

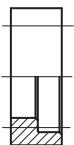
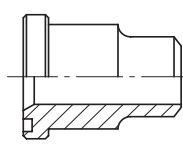
PFE – p. N84

PFB – p. N84

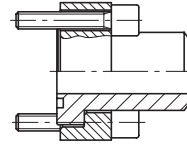
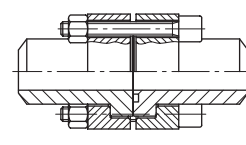
BFW3-G – p. N85

Aluminium flanges

PWDS-G – p. N86

PWDA – p. N87

ISO 6164 Square flanges

PSFC – p. N88

PSFA-B – p. N89

PSFP – p. N90

PSF-B – p. N91

PDSF-B – p. N92

N

SAE Flange clamps

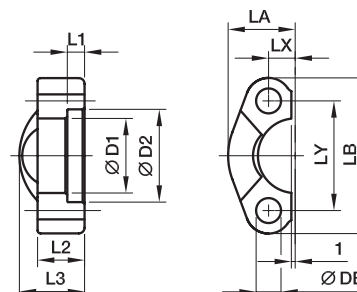
FHS SAE Split flange halves

ISO 6162-1/-2

3000 PSI Series

| Nom. flange size | | | | | | | | | | | | Bolts | | Weight (steel) kg/piece | Order code* | PN (bar) ¹⁾ | |
|------------------|----------|-------|-------|------|----|----|------|-------|------|-------|------|---------|------------|-------------------------|-------------|------------------------|-----|
| SAE (in.) | ISO (DN) | D1 | D2 | L1 | L2 | L3 | LA | LB | LX | LY | DB | (metr.) | (unc.) | | | CF | SS |
| 1/2 | 13 | 24.3 | 31.0 | 6.2 | 13 | 19 | 23.0 | 54.0 | 8.7 | 38.1 | 8.9 | M 08x25 | 5/16x1 1/4 | 0.07 | FHS32 | 345 | 345 |
| 3/4 | 19 | 32.2 | 38.9 | 6.2 | 14 | 22 | 25.9 | 65.0 | 11.1 | 47.6 | 10.6 | M 10x30 | 3/8x1 1/4 | 0.09 | FHS33 | 345 | 345 |
| 1 | 25 | 38.5 | 45.2 | 7.5 | 16 | 24 | 29.2 | 69.9 | 13.1 | 52.4 | 10.6 | M 10x30 | 3/8x1 1/4 | 0.11 | FHS34 | 345 | 345 |
| 1 1/4 | 32 | 43.7 | 51.6 | 7.5 | 16 | 22 | 36.3 | 79.4 | 15.1 | 58.7 | 10.6 | M 10x35 | - | 0.17 | FHS35/10 | 276 | 276 |
| 1 1/4 | 32 | 43.7 | 51.6 | 7.5 | 16 | 22 | 36.3 | 79.4 | 15.1 | 58.7 | 12.0 | - | 7/16x1 1/2 | 0.17 | FHS35/12 | 276 | 276 |
| 1 1/4 | 32 | 43.7 | 51.6 | 7.5 | 16 | 22 | 36.3 | 79.4 | 15.1 | 58.7 | 12.5 | M 12x35 | - | 0.17 | FHS35 | 276 | 276 |
| 1 1/2 | 38 | 50.8 | 61.1 | 7.5 | 16 | 25 | 41.1 | 93.8 | 17.9 | 69.9 | 13.5 | M 12x35 | 1/2x1 1/2 | 0.24 | FHS36 | 207 | 207 |
| 1 1/2 | 38 | 50.8 | 61.1 | 7.5 | 16 | 25 | 41.1 | 93.8 | 17.9 | 69.9 | 14.5 | M 14x35 | - | 0.24 | FHS36/14 | 207 | 207 |
| 2 | 51 | 62.8 | 72.3 | 9.0 | 16 | 26 | 48.2 | 101.6 | 21.4 | 77.8 | 13.5 | M 12x35 | 1/2x1 1/2 | 0.27 | FHS38/12 | 207 | 207 |
| 2 | 51 | 62.8 | 72.3 | 9.0 | 16 | 26 | 48.2 | 101.6 | 21.4 | 77.8 | 14.5 | M 14x35 | - | 0.27 | FHS38 | 207 | 207 |
| 2 1/2 | 64 | 74.9 | 84.9 | 9.0 | 19 | 38 | 54.1 | 114.3 | 25.4 | 88.9 | 13.5 | M 12x40 | 1/2x1 3/4 | 0.45 | FHS310 | 172 | 172 |
| 2 1/2 | 64 | 74.9 | 84.9 | 9.0 | 19 | 38 | 54.1 | 114.3 | 25.4 | 88.9 | 14.5 | M 14x40 | - | 0.45 | FHS310/14 | 172 | 172 |
| 3 | 76 | 90.9 | 102.4 | 9.0 | 22 | 41 | 65.3 | 135.0 | 31.0 | 106.4 | 16.7 | M 16x45 | 5/8x1 3/4 | 0.71 | FHS312 | 138 | 138 |
| 3 1/2 | 89 | 102.4 | 115.0 | 10.7 | 22 | 28 | 68.6 | 152.4 | 34.9 | 120.7 | 16.7 | M 16x45 | 5/8x2 | 0.65 | FHS314 | 34 | 34 |
| 4 | 102 | 115.1 | 127.8 | 10.7 | 25 | 35 | 74.9 | 162.0 | 38.9 | 130.2 | 16.7 | M 16x50 | 5/8x2 | 0.87 | FHS316 | 34 | 34 |
| 5 | 127 | 140.5 | 153.2 | 10.7 | 28 | 41 | 89.4 | 184.2 | 46.0 | 152.4 | 16.7 | M 16x50 | 5/8x2 1/4 | 1.25 | FHS320 | 34 | 34 |

6000 PSI Series

| | | | | | | | | | | | | | | | | | |
|-------|----|-------|-------|------|----|----|------|-------|------|-------|------|---------|------------|------|----------|-----|-----|
| 1/2 | 13 | 24.6 | 32.5 | 7.2 | 16 | 22 | 24.0 | 56.4 | 9.1 | 40.5 | 9.0 | M 08x30 | 5/16x1 1/4 | 0.08 | FHS62 | 420 | 420 |
| 3/4 | 19 | 32.5 | 42.0 | 8.3 | 19 | 28 | 30.0 | 72.0 | 11.9 | 50.8 | 11.0 | M 10x35 | 3/8x1 1/2 | 0.18 | FHS63 | 420 | 420 |
| 1 | 25 | 38.8 | 48.4 | 9.0 | 24 | 33 | 34.8 | 81.0 | 13.9 | 57.2 | 13.0 | M 12x45 | - | 0.27 | FHS64 | 420 | 420 |
| 1 | 25 | 38.9 | 48.4 | 9.0 | 24 | 33 | 34.8 | 81.0 | 13.9 | 57.2 | 12.0 | - | 7/16x1 3/4 | 0.27 | FHS64/12 | 420 | 420 |
| 1 1/4 | 32 | 44.5 | 54.8 | 9.8 | 27 | 38 | 38.6 | 95.3 | 15.9 | 66.6 | 15.0 | M 14x50 | - | 0.27 | FHS65 | 420 | 420 |
| 1 1/4 | 32 | 44.5 | 54.8 | 9.8 | 27 | 38 | 38.6 | 95.3 | 15.9 | 66.6 | 13.0 | M 12x45 | 1/2x1 3/4 | 0.27 | FHS65/12 | 420 | 420 |
| 1 1/2 | 38 | 51.6 | 64.3 | 12.1 | 30 | 43 | 47.5 | 112.8 | 18.3 | 79.3 | 17.0 | M 16x55 | 5/8x2 1/4 | 0.40 | FHS66 | 420 | 420 |
| 2 | 51 | 67.6 | 80.2 | 12.1 | 37 | 52 | 56.9 | 133.4 | 22.2 | 96.8 | 22.0 | M 20x65 | 3/4x2 3/4 | 0.40 | FHS68 | 420 | 420 |
| 2 1/2 | 64 | 90.0 | 108.0 | 20.0 | 45 | 45 | 75.1 | 180.0 | 29.4 | 123.8 | 25.0 | M 24x75 | - | 0.68 | FHS610 | 420 | 420 |
| 3 | 76 | 115.0 | 132.5 | 25.0 | 55 | 55 | 99.1 | 215.0 | 35.7 | 152.4 | 31.5 | M 30x90 | - | 1.05 | FHS612 | 420 | 420 |

¹⁾ Pressure shown = Item deliverable

 $\frac{PN \text{ (bar)}}{10} = PN \text{ (MPa)}$

*Please add the suffixes below according to the material/surface required.

| Order code suffixes | | | |
|---------------------------------|-----------------------------|----------|------------------|
| Material | Suffix surface and material | Example | Description |
| Steel, zinc plated, Cr(VI)-free | CF | FHS32CFX | only flange half |
| Stainless steel | SS | FHS32SSX | only flange half |



FUS SAE Full flanges

ISO 6162-1/-2

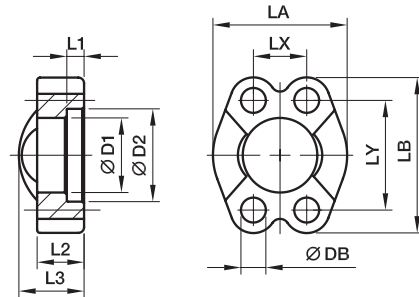

3000 PSI Series

| Nom. flange size | | D1 | D2 | L1 | L2 | L3 | LA | LB | LX | LY | DB | Bolts | | Weight (steel) kg/piece | Order code* | PN (bar) ¹⁾ | |
|------------------|----------|-------|-------|------|----|----|-----|-------|------|-------|------|---------|------------|-------------------------|------------------|------------------------|-----|
| SAE (in.) | ISO (DN) | | | | | | | | | | | (metr.) | (unc.) | | | CF | SS |
| 1/2 | 13 | 24.3 | 31.0 | 6.2 | 13 | 19 | 46 | 54.0 | 17.5 | 38.1 | 8.9 | M 08x25 | 5/16x1 1/4 | 0.13 | FUS32 | 345 | 345 |
| 3/4 | 19 | 32.2 | 38.9 | 6.2 | 14 | 22 | 52 | 65.0 | 22.3 | 47.6 | 10.6 | M 10x30 | 3/8x1 1/4 | 0.18 | FUS33 | 345 | 345 |
| 1 | 25 | 38.5 | 45.2 | 7.5 | 16 | 24 | 59 | 69.9 | 26.2 | 52.4 | 10.6 | M 10x30 | 3/8x1 1/4 | 0.22 | FUS34 | 345 | 345 |
| 1 1/4 | 32 | 43.7 | 51.6 | 7.5 | 16 | 22 | 73 | 79.4 | 30.2 | 58.7 | 10.6 | M 10x35 | - | 0.30 | FUS35/10 | 276 | 276 |
| 1 1/4 | 32 | 43.7 | 51.6 | 7.5 | 16 | 22 | 73 | 79.4 | 30.2 | 58.7 | 12.0 | - | 7/16x1 1/2 | 0.29 | FUS35/12 | 276 | 276 |
| 1 1/4 | 32 | 43.7 | 51.6 | 7.5 | 16 | 22 | 73 | 79.4 | 30.2 | 58.7 | 12.5 | M 12x35 | - | 0.29 | FUS35 | 276 | 276 |
| 1 1/2 | 38 | 50.8 | 61.1 | 7.5 | 16 | 25 | 83 | 93.8 | 35.8 | 69.9 | 13.5 | M 12x35 | 1/2x1 1/2 | 0.45 | FUS36 | 207 | 207 |
| 1 1/2 | 38 | 50.8 | 61.1 | 7.5 | 16 | 25 | 83 | 93.8 | 35.8 | 69.9 | 14.5 | M 14x35 | - | 0.44 | FUS36/14 | 207 | 207 |
| 2 | 51 | 62.8 | 72.3 | 9.0 | 16 | 26 | 97 | 101.6 | 42.8 | 77.8 | 13.5 | M 12x35 | 1/2x1 1/2 | 0.53 | FUS38/12 | 207 | 207 |
| 2 | 51 | 62.8 | 72.3 | 9.0 | 16 | 26 | 97 | 101.6 | 42.8 | 77.8 | 14.5 | M 14x35 | - | 0.51 | FUS38 | 207 | 207 |
| 2 1/2 | 64 | 74.9 | 84.9 | 9.0 | 19 | 38 | 109 | 114.3 | 50.8 | 88.9 | 13.5 | M 12x40 | 1/2x1 3/4 | 0.85 | FUS310 | 172 | 172 |
| 2 1/2 | 64 | 74.9 | 84.9 | 9.0 | 19 | 38 | 109 | 114.3 | 50.8 | 88.9 | 14.5 | M 14x40 | - | 0.82 | FUS310/14 | 172 | 172 |
| 3 | 76 | 90.9 | 102.4 | 9.0 | 22 | 41 | 131 | 135.0 | 61.9 | 106.4 | 16.7 | M 16x45 | 5/8x1 3/4 | 1.30 | FUS312 | 138 | 138 |
| 3 1/2 | 89 | 102.4 | 115.0 | 10.7 | 22 | 28 | 140 | 152.4 | 69.9 | 120.7 | 16.7 | M 16x45 | 5/8x2 | 1.57 | FUS314 | 34 | 34 |
| 4 | 102 | 115.1 | 127.8 | 10.7 | 25 | 35 | 150 | 162.0 | 77.8 | 130.2 | 16.7 | M 16x50 | 5/8x2 | 1.82 | FUS316 | 34 | 34 |
| 5 | 127 | 140.5 | 153.2 | 10.7 | 28 | 41 | 180 | 184.2 | 92.1 | 152.4 | 16.7 | M 16x50 | 5/8x2 1/4 | 2.63 | FUS320 | 34 | 34 |

6000 PSI Series

| | | | | | | | | | | | | | | | | | |
|-------|----|-------|-------|------|----|----|-----|-------|------|-------|------|---------|------------|------|-----------------|-----|-----|
| 1/2 | 13 | 24.6 | 32.5 | 7.2 | 16 | 22 | 48 | 56.4 | 18.2 | 40.5 | 8.9 | M 08x30 | 5/16x1 1/4 | 0.16 | FUS62 | 420 | 420 |
| 3/4 | 19 | 32.5 | 42.0 | 8.3 | 19 | 28 | 60 | 71.4 | 23.8 | 50.8 | 10.6 | M 10x35 | 3/8x1 1/2 | 0.31 | FUS63 | 420 | 420 |
| 1 | 25 | 38.8 | 48.4 | 9.0 | 24 | 33 | 70 | 81.0 | 27.8 | 57.2 | 13.3 | M 12x45 | - | 0.49 | FUS64 | 420 | 420 |
| 1 | 25 | 38.9 | 48.4 | 9.0 | 24 | 33 | 70 | 81.0 | 27.8 | 57.2 | 12.0 | - | 7/16x1 3/4 | 0.51 | FUS64/12 | 420 | 420 |
| 1 1/4 | 32 | 44.5 | 54.8 | 9.8 | 27 | 38 | 78 | 95.3 | 31.8 | 66.6 | 15.0 | M 14x50 | - | 0.77 | FUS65 | 420 | 420 |
| 1 1/4 | 32 | 44.5 | 54.8 | 9.8 | 27 | 38 | 78 | 95.3 | 31.8 | 66.6 | 13.3 | M 12x45 | 1/2x1 3/4 | 0.81 | FUS65/12 | 420 | 420 |
| 1 1/2 | 38 | 51.6 | 64.3 | 12.1 | 30 | 43 | 96 | 112.8 | 36.5 | 79.3 | 16.7 | M 16x55 | 5/8x2 1/4 | 1.31 | FUS66 | 420 | 420 |
| 2 | 51 | 67.6 | 80.2 | 12.1 | 37 | 52 | 114 | 133.4 | 44.5 | 96.8 | 20.6 | M 20x65 | 3/4x2 3/4 | 2.00 | FUS68 | 420 | 420 |
| 2 1/2 | 64 | 90.0 | 108.9 | 20.5 | 45 | 45 | 150 | 180.0 | 58.7 | 123.8 | 25.0 | M 24x75 | - | 3.95 | FUS610 | 420 | 420 |
| 3 | 76 | 115.0 | 132.5 | 25.5 | 55 | 55 | 178 | 215.0 | 71.4 | 152.4 | 31.0 | M 30x90 | - | 6.73 | FUS612 | 420 | 420 |

1) Pressure shown = Item deliverable

$$\frac{PN \text{ (bar)}}{10} = PN \text{ (MPa)}$$

*Please add the suffixes below according to the material/surface required.

| Order code suffixes | | | |
|---------------------------------|-----------------------------|----------|-------------------|
| Material | Suffix surface and material | Example | Description |
| Steel, zinc plated, Cr(VI)-free | CF | FUS32CFX | only flange clamp |
| Stainless steel | SS | FUS32SSX | only flange clamp |



SAE Flange clamps

FUSM SAE Full flanges with metric tapped holes

ISO 6162-1/-2

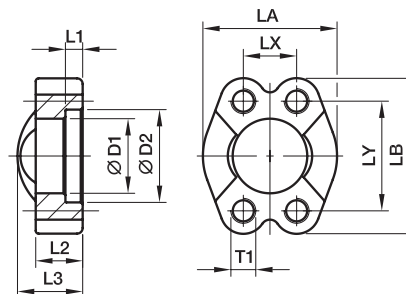
3000 PSI Series

| Nom. flange size | | D1 | D2 | L1 | L2 | L3 | LA | LB | LX | LY | T1 | Weight (steel) kg/piece | Order code* | PN (bar) ¹⁾ | |
|------------------|----------|-------|-------|------|----|----|-----|-------|------|-------|------------|-------------------------|-------------------|------------------------|-----|
| SAE (in.) | ISO (DN) | | | | | | | | | | | | | CF | SS |
| 1/2 | 13 | 24.3 | 31.0 | 6.2 | 13 | 20 | 46 | 54.0 | 17.5 | 38.1 | M 8 | 0.13 | FUSM32 | 345 | 345 |
| 3/4 | 19 | 32.1 | 38.9 | 6.2 | 14 | 22 | 52 | 65.0 | 22.3 | 47.6 | M10 | 0.19 | FUSM33 | 345 | 345 |
| 1 | 25 | 38.5 | 45.2 | 7.5 | 16 | 24 | 59 | 69.9 | 26.2 | 52.4 | M10 | 0.23 | FUSM34 | 345 | 345 |
| 1 1/4 | 32 | 43.7 | 51.6 | 7.5 | 16 | 22 | 73 | 79.4 | 30.2 | 58.7 | M10 | 0.31 | FUSM35/10 | 276 | 276 |
| 1 1/4 | 32 | 43.7 | 51.6 | 7.5 | 16 | 22 | 73 | 79.4 | 30.2 | 58.7 | M12 | 0.30 | FUSM35/12 | 276 | 276 |
| 1 1/2 | 38 | 50.8 | 61.1 | 7.5 | 16 | 25 | 83 | 93.8 | 35.7 | 69.9 | M12 | 0.44 | FUSM36 | 207 | 207 |
| 1 1/2 | 38 | 50.8 | 61.1 | 7.5 | 16 | 25 | 83 | 93.8 | 35.7 | 69.9 | M14 | 0.47 | FUSM36/14 | 207 | 207 |
| 2 | 51 | 62.8 | 72.3 | 9.0 | 16 | 26 | 97 | 101.6 | 42.9 | 77.8 | M12 | 0.56 | FUSM38/12 | 207 | 207 |
| 2 | 51 | 62.8 | 72.3 | 9.0 | 16 | 26 | 97 | 101.6 | 42.9 | 77.8 | M14 | 0.54 | FUSM38 | 207 | 207 |
| 2 1/2 | 64 | 74.9 | 84.9 | 9.0 | 19 | 38 | 109 | 114.3 | 50.8 | 88.9 | M12 | 0.85 | FUSM310 | 172 | 172 |
| 2 1/2 | 64 | 74.9 | 84.9 | 9.0 | 19 | 38 | 109 | 114.3 | 50.8 | 88.9 | M14 | 0.73 | FUSM310/14 | 172 | 172 |
| 3 | 76 | 90.9 | 102.4 | 9.0 | 22 | 41 | 131 | 135.0 | 61.9 | 106.4 | M16 | 1.25 | FUSM312 | 138 | 138 |
| 3 1/2 | 89 | 102.4 | 115.0 | 10.7 | 23 | 28 | 140 | 152.4 | 69.9 | 120.7 | M16 | 1.66 | FUSM314 | 34 | 34 |
| 4 | 102 | 115.1 | 127.8 | 10.7 | 25 | 35 | 150 | 162.0 | 77.8 | 130.2 | M16 | 1.83 | FUSM316 | 34 | 34 |
| 5 | 127 | 140.5 | 153.2 | 10.7 | 28 | 41 | 180 | 184.2 | 92.1 | 152.4 | M16 | 2.50 | FUSM320 | 34 | 34 |

6000 PSI Series

| | | | | | | | | | | | | | | | |
|-------|----|-------|-------|------|----|----|-----|-------|------|-------|------------|------|------------------|-----|-----|
| 1/2 | 13 | 24.6 | 32.5 | 7.2 | 16 | 22 | 48 | 56.4 | 18.2 | 40.5 | M 8 | 0.18 | FUSM62 | 420 | 420 |
| 3/4 | 19 | 32.5 | 42.0 | 8.2 | 19 | 28 | 60 | 71.4 | 23.8 | 50.8 | M10 | 0.34 | FUSM63 | 420 | 420 |
| 1 | 25 | 38.9 | 48.4 | 9.0 | 24 | 33 | 70 | 81.0 | 27.8 | 57.2 | M12 | 0.55 | FUSM64 | 420 | 420 |
| 1 1/4 | 32 | 44.5 | 54.8 | 9.8 | 27 | 38 | 78 | 95.3 | 31.8 | 66.6 | M14 | 0.87 | FUSM65 | 420 | 420 |
| 1 1/4 | 32 | 44.5 | 54.8 | 9.8 | 27 | 38 | 78 | 95.3 | 31.8 | 66.6 | M12 | 0.87 | FUSM65/12 | 420 | 420 |
| 1 1/2 | 38 | 51.6 | 64.3 | 12.1 | 30 | 43 | 96 | 112.8 | 36.5 | 79.3 | M16 | 1.33 | FUSM66 | 420 | 420 |
| 2 | 51 | 67.6 | 80.2 | 12.1 | 37 | 52 | 114 | 133.4 | 44.5 | 96.8 | M20 | 2.31 | FUSM68 | 420 | 420 |
| 2 1/2 | 64 | 90.0 | 108.9 | 20.5 | 45 | 45 | 150 | 180.0 | 58.7 | 123.8 | M24 | 4.02 | FUSM610 | 420 | 420 |
| 3 | 76 | 115.0 | 132.5 | 25.5 | 55 | 55 | 178 | 215.0 | 71.4 | 152.4 | M30 | 7.05 | FUSM612 | 420 | 420 |

1) Pressure shown = Item deliverable

$$\frac{\text{PN (bar)}}{10} = \text{PN (MPa)}$$

 *Please add the **suffixes** below according to the material/surface required.

| Order code suffixes | | | |
|---------------------------------|-----------------------------|--|-------------------|
| Material | Suffix surface and material | Example only flange clamp with metr. threads | Description |
| Steel, zinc plated, Cr(VI)-free | CF | FUSM32CFM | only flange clamp |
| Stainless steel | SS | FUSM32SSM | only flange clamp |



FHSF SAE Flange halves flat

ISO 6162-1/-2

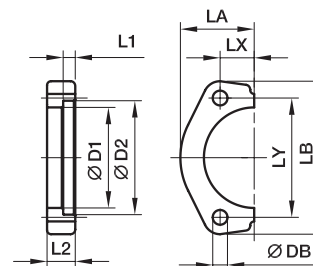
3000 PSI Series

| Nom. flange size | | D1 | D2 | L1 | L2 | LA | LB | LX | LY | DB | Bolts | | Weight (steel) kg/piece | Order code* | PN (bar) ¹⁾ CF |
|------------------|----------|------|-------|-----|----|------|-----|------|-------|------|---------|------------|-------------------------|-------------------|---------------------------|
| SAE (in.) | ISO (DN) | | | | | | | | | | (metr.) | (unc.) | | | |
| 1/2 | 13 | 24.3 | 31.0 | 6.2 | 13 | 22.8 | 56 | 8.7 | 38.1 | 8.9 | M 08×25 | 5/16×1 1/4 | 0.06 | FHSF32 | 345 |
| 3/4 | 19 | 32.1 | 38.9 | 6.2 | 14 | 25.9 | 65 | 11.1 | 47.6 | 10.6 | M 10×30 | 3/8×1 1/4 | 0.07 | FHSF33 | 345 |
| 1 | 25 | 38.5 | 45.3 | 7.5 | 16 | 29.2 | 70 | 13.1 | 52.4 | 10.6 | M 10×30 | 3/8×1 1/4 | 0.10 | FHSF34 | 345 |
| 1 1/4 | 32 | 43.7 | 51.6 | 7.5 | 16 | 36.6 | 79 | 15.1 | 58.7 | 10.6 | M 10×35 | – | 0.16 | FHSF35/10 | 276 |
| 1 1/4 | 32 | 43.7 | 51.6 | 7.5 | 16 | 36.6 | 79 | 15.1 | 58.7 | 12.5 | M 12×35 | 7/16×1 1/2 | 0.16 | FHSF35/12 | 276 |
| 1 1/2 | 38 | 50.8 | 61.1 | 7.5 | 16 | 41.1 | 94 | 17.9 | 69.9 | 13.5 | M 12×35 | 1/2×1 1/2 | 0.21 | FHSF36 | 207 |
| 1 1/2 | 38 | 50.8 | 61.1 | 7.5 | 16 | 41.1 | 94 | 17.9 | 69.9 | 14.5 | M 14×35 | – | 0.20 | FHSF36/14 | 207 |
| 2 | 51 | 62.8 | 72.3 | 9.0 | 16 | 48.2 | 104 | 21.4 | 77.8 | 13.5 | M 12×35 | 1/2×1 1/2 | 0.26 | FHSF38 | 207 |
| 2 | 51 | 62.8 | 72.3 | 9.0 | 16 | 48.2 | 104 | 21.4 | 77.8 | 14.5 | M 14×35 | – | 0.25 | FHSF38/14 | 207 |
| 2 1/2 | 64 | 74.9 | 84.9 | 9.0 | 19 | 53.0 | 114 | 25.4 | 88.9 | 13.5 | M 12×40 | 1/2×1 3/4 | 0.38 | FHSF310 | 172 |
| 2 1/2 | 64 | 74.9 | 84.9 | 9.0 | 19 | 53.0 | 114 | 25.4 | 88.9 | 14.5 | M 14×40 | – | 0.36 | FHSF310/14 | 172 |
| 3 | 76 | 90.9 | 102.4 | 9.0 | 22 | 64.3 | 135 | 31.0 | 106.4 | 16.7 | M 16×45 | 5/8×1 3/4 | 0.57 | FHSF312 | 138 |

6000 PSI Series

| | | | | | | | | | | | | | | | |
|-------|----|------|------|------|----|------|-----|------|------|------|---------|------------|------|------------------|-----|
| 1/2 | 13 | 24.6 | 32.5 | 7.2 | 16 | 23.6 | 56 | 9.1 | 40.5 | 8.9 | M 08×30 | 5/16×1 1/4 | 0.08 | FHSF62 | 420 |
| 3/4 | 19 | 32.5 | 42.0 | 8.3 | 20 | 30.0 | 71 | 11.9 | 50.8 | 10.6 | M 10×35 | 3/8×1 1/2 | 0.14 | FHSF63 | 420 |
| 1 | 25 | 38.8 | 48.4 | 9.0 | 25 | 34.8 | 81 | 13.9 | 57.2 | 13.3 | M 12×45 | – | 0.23 | FHSF64 | 420 |
| 1 1/4 | 32 | 44.5 | 54.8 | 9.8 | 27 | 38.6 | 95 | 15.9 | 66.6 | 15.0 | M 14×50 | – | 0.34 | FHSF65 | 420 |
| 1 1/4 | 32 | 44.5 | 54.8 | 9.8 | 27 | 38.6 | 95 | 15.9 | 66.6 | 13.3 | M 12×50 | 1/2×1 3/4 | 0.34 | FHSF65/12 | 420 |
| 1 1/2 | 38 | 51.6 | 64.3 | 12.1 | 30 | 47.5 | 113 | 18.3 | 79.3 | 16.7 | M 16×55 | 5/8×2 1/4 | 0.59 | FHSF66 | 420 |
| 2 | 51 | 67.6 | 80.2 | 12.1 | 37 | 56.9 | 133 | 22.2 | 96.8 | 20.6 | M 20×65 | 3/4×2 3/4 | 0.93 | FHSF68 | 420 |

¹⁾Pressure shown = Item deliverable

$$\frac{\text{PN (bar)}}{10} = \text{PN (MPa)}$$

Material for steel: C60

 *Please add the **suffixes** below according to the material/surface required.

| Order code suffixes | | | |
|---------------------------------|-----------------------------|----------|------------------|
| Material | Suffix surface and material | Example | Description |
| Steel, zinc plated, Cr(VI)-free | CF | FHSF32CF | only flange half |



SAE Flange clamps

FUSF SAE Full flanges flat

ISO 6162-1/-2

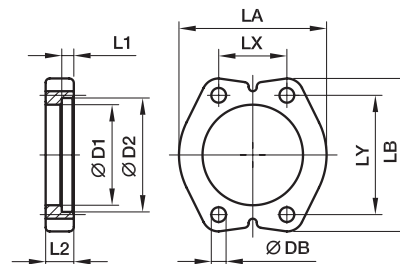
3000 PSI Series

| Nom. flange size | | | | | | | | | | | Bolts | | Weight (steel) kg/piece | Order code* | PN (bar) ¹⁾ CF |
|------------------|----------|------|-------|-----|----|-----|-----|------|-------|------|---------|------------|-------------------------|-------------------|---------------------------|
| SAE (in.) | ISO (DN) | D1 | D2 | L1 | L2 | LA | LB | LX | LY | DB | (metr.) | (unc.) | | | |
| 1/2 | 13 | 24.3 | 31.0 | 6.2 | 13 | 46 | 56 | 17.4 | 38.1 | 8.9 | M 08×25 | 5/16×1 1/4 | 0.12 | FUSF32 | 345 |
| 3/4 | 19 | 32.1 | 38.9 | 6.2 | 14 | 52 | 65 | 22.2 | 47.6 | 10.6 | M 10×30 | 3/8×1 1/4 | 0.18 | FUSF33 | 345 |
| 1 | 25 | 38.5 | 45.3 | 7.5 | 16 | 59 | 70 | 26.2 | 52.4 | 10.6 | M 10×30 | 3/8×1 1/4 | 0.23 | FUSF34 | 345 |
| 1 1/4 | 32 | 43.7 | 51.6 | 7.5 | 16 | 73 | 79 | 30.2 | 58.7 | 10.6 | M 10×35 | – | 0.33 | FUSF35/10 | 276 |
| 1 1/4 | 32 | 43.7 | 51.6 | 7.5 | 16 | 73 | 79 | 30.2 | 58.7 | 12.5 | M 12×35 | 7/16×1 1/2 | 0.32 | FUSF35/12 | 276 |
| 1 1/2 | 38 | 50.8 | 61.1 | 7.5 | 16 | 83 | 94 | 35.8 | 69.9 | 13.5 | M 12×35 | 1/2×1 1/2 | 0.42 | FUSF36 | 207 |
| 1 1/2 | 38 | 50.8 | 61.1 | 7.5 | 16 | 83 | 94 | 35.8 | 69.9 | 14.5 | M 14×35 | – | 0.41 | FUSF36/14 | 207 |
| 2 | 51 | 62.8 | 72.3 | 9.0 | 16 | 97 | 104 | 42.8 | 77.8 | 13.5 | M 12×35 | 1/2×1 1/2 | 0.56 | FUSF38/12 | 207 |
| 2 | 51 | 62.8 | 72.3 | 9.0 | 16 | 97 | 104 | 42.8 | 77.8 | 14.5 | M 14×35 | – | 0.51 | FUSF38 | 207 |
| 2 1/2 | 64 | 74.9 | 84.9 | 9.0 | 19 | 109 | 114 | 50.8 | 88.9 | 13.5 | M 12×40 | 1/2×1 3/4 | 0.77 | FUSF310 | 172 |
| 2 1/2 | 64 | 74.9 | 84.9 | 9.0 | 19 | 109 | 114 | 50.8 | 88.9 | 14.5 | M 14×40 | – | 0.72 | FUSF310/14 | 172 |
| 3 | 76 | 90.9 | 102.4 | 9.0 | 22 | 131 | 135 | 61.9 | 106.4 | 16.7 | M 16×45 | 5/8×1 3/4 | 1.13 | FUSF312 | 138 |

6000 PSI Series

| | | | | | | | | | | | | | | | |
|-------|----|------|------|------|----|-----|-----|------|------|------|---------|------------|------|------------------|-----|
| 1/2 | 13 | 24.6 | 32.5 | 7.2 | 16 | 48 | 56 | 18.2 | 40.5 | 8.9 | M 08×30 | 5/16×1 1/4 | 0.17 | FUSF62 | 420 |
| 3/4 | 19 | 32.5 | 42.0 | 8.3 | 20 | 60 | 71 | 23.8 | 50.8 | 10.6 | M 10×35 | 3/8×1 1/2 | 0.32 | FUSF63 | 420 |
| 1 | 25 | 38.8 | 48.4 | 9.0 | 25 | 70 | 81 | 27.8 | 57.2 | 13.3 | M 12×45 | – | 0.56 | FUSF64 | 420 |
| 1 | 25 | 38.8 | 48.4 | 9.0 | 25 | 70 | 81 | 27.8 | 57.2 | 12.0 | M 12×45 | 7/16×1 3/4 | 0.56 | FUSF64/12 | 420 |
| 1 1/4 | 32 | 44.5 | 54.8 | 9.8 | 27 | 78 | 95 | 31.8 | 66.6 | 15.0 | M 14×50 | – | 0.76 | FUSF65 | 420 |
| 1 1/4 | 32 | 44.5 | 54.8 | 9.8 | 27 | 78 | 95 | 31.8 | 66.6 | 13.3 | M 12×50 | 1/2×1 3/4 | 0.76 | FUSF65/12 | 420 |
| 1 1/2 | 38 | 51.6 | 64.3 | 12.1 | 30 | 95 | 113 | 36.5 | 79.3 | 16.7 | M 16×55 | 5/8×2 1/4 | 1.30 | FUSF66 | 420 |
| 2 | 51 | 67.6 | 80.2 | 12.1 | 37 | 114 | 133 | 44.5 | 96.8 | 20.6 | M 20×65 | 3/4×2 3/4 | 1.88 | FUSF68 | 420 |

¹⁾ Pressure shown = Item deliverable

$$\frac{\text{PN (bar)}}{10} = \text{PN (MPa)}$$

Material for steel: C60

 *Please add the **suffixes** below according to the material/surface required.

| Order code suffixes | | | |
|---------------------------------|-----------------------------|----------|-------------------|
| Material | Suffix surface and material | Example | Description |
| Steel, zinc plated, Cr(VI)-free | CF | FUSF32CF | only flange clamp |



GFS SAE Straight flange adapter

SAE Flange / EO 24° cone end
(ISO 6162-1/-2)

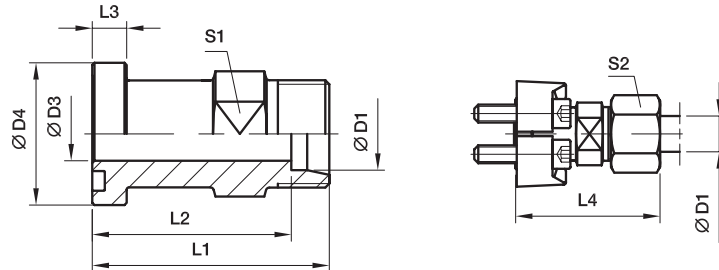

3000 PSI Series

| Nom. flange size | | D1 ²⁾ | | | | | | | | | | | Bolts | | Weight (steel) kg/piece | Order code* | PN (bar) ¹⁾ | |
|------------------|----------|------------------|------|------|------|------|-----|------|----|----|---------|------------|-------|----------------------------|-------------------------|-------------|------------------------|--|
| SAE (in.) | ISO (DN) | | D3 | D4 | L1 | L2 | L3 | L4 | S1 | S2 | (metr.) | (unc.) | CF | 71 | | | | |
| 1/2 | 13 | 15L | 12.0 | 30.2 | 48.0 | 41.0 | 6.7 | 56.0 | 24 | 27 | M 08×25 | 5/16×1 1/4 | 0.13 | GFS32/15L | 315 | 315 | | |
| 1/2 | 13 | 16S | 12.0 | 30.2 | 50.0 | 41.5 | 6.7 | 60.0 | 24 | 30 | M 08×25 | 5/16×1 1/4 | 0.14 | GFS32/16S | 350 | 350 | | |
| 1/2 | 13 | 18L | 14.0 | 30.2 | 50.0 | 42.5 | 6.7 | 61.0 | 19 | 32 | M 08×25 | 5/16×1 1/4 | 0.12 | GFS32/18L | 315 | 315 | | |
| 3/4 | 19 | 16S | 12.0 | 38.1 | 55.0 | 46.5 | 6.7 | 64.5 | 27 | 30 | M 10×30 | 3/8×1 1/4 | 0.22 | GFS33/16S | 350 | 350 | | |
| 3/4 | 19 | 18L | 17.0 | 38.1 | 53.0 | 45.5 | 6.7 | 62.0 | 30 | 32 | M 10×30 | 3/8×1 1/4 | 0.22 | GFS33/18L | 315 | 315 | | |
| 3/4 | 19 | 22L | 19.0 | 38.1 | 53.0 | 45.5 | 6.7 | 62.0 | 30 | 36 | M 10×30 | 3/8×1 1/4 | 0.20 | GFS33/22L | 160 | 160 | | |
| 3/4 | 19 | 28L | 19.0 | 38.1 | 55.0 | 41.0 | 6.7 | 64.0 | 32 | 41 | M 10×30 | 3/8×1 1/4 | 0.23 | GFS33/28L | 160 | 160 | | |
| 3/4 | 19 | 20S | 17.0 | 38.1 | 57.0 | 46.5 | 6.7 | 68.0 | 30 | 36 | M 10×30 | 3/8×1 1/4 | 0.25 | GFS33/20S | 350 | 350 | | |
| 3/4 | 19 | 25S | 17.0 | 38.1 | 57.0 | 45.0 | 6.7 | 69.0 | 30 | 46 | M 10×30 | 3/8×1 1/4 | 0.27 | GFS33/25S | 350 | 350 | | |
| 1 | 25 | 20S | 25.0 | 44.5 | 60.0 | 48.5 | 8.0 | 71.0 | 32 | 36 | M 10×30 | 3/8×1 1/4 | 0.34 | GFS34/20S | 350 | 350 | | |
| 1 | 25 | 28L | 24.0 | 44.5 | 54.0 | 46.5 | 8.0 | 63.0 | 36 | 41 | M 10×30 | 3/8×1 1/4 | 0.28 | GFS34/28L | 160 | 160 | | |
| 1 | 25 | 25S | 20.0 | 44.5 | 58.0 | 46.5 | 8.0 | 60.0 | 36 | 46 | M 10×30 | 3/8×1 1/4 | 0.35 | GFS34/25S | 350 | 350 | | |
| 1 | 25 | 30S | 24.0 | 44.5 | 63.0 | 49.5 | 8.0 | 76.0 | 36 | 50 | M 10×30 | 3/8×1 1/4 | 0.36 | GFS34/30S | 250 | 250 | | |
| 1 | 25 | 42L | 24.0 | 44.5 | 76.0 | 65.0 | 8.0 | 87.5 | 41 | 60 | M 10×30 | 3/8×1 1/4 | 0.49 | GFS34/42L | 160 | 160 | | |
| 1 1/4 | 32 | 35L | 32.0 | 50.8 | 58.0 | 47.5 | 8.0 | 69.0 | 41 | 50 | M 10×35 | - | 0.36 | GFS35/35L/10 ³⁾ | 160 | 160 | | |
| 1 1/4 | 32 | 25S | 27.0 | 50.8 | 60.0 | 48.0 | 8.0 | 72.0 | 41 | 46 | M 10×35 | - | 0.44 | GFS35/25S/10 ³⁾ | 200 | 200 | | |
| 1 1/4 | 32 | 30S | 28.5 | 50.8 | 62.0 | 48.5 | 8.0 | 75.0 | 41 | 50 | M 10×35 | - | 0.44 | GFS35/30S/10 ³⁾ | 200 | 200 | | |
| 1 1/4 | 32 | 38S | 28.0 | 50.8 | 66.0 | 50.0 | 8.0 | 81.0 | 46 | 60 | M 10×35 | - | 0.46 | GFS35/38S/10 ³⁾ | 200 | 200 | | |
| 1 1/4 | 32 | 28L | 23.0 | 50.8 | 60.0 | 52.5 | 8.0 | 67.0 | 36 | 41 | M 12×40 | 7/16×1 1/2 | 0.41 | GFS35/28L | 160 | 160 | | |
| 1 1/4 | 32 | 35L | 32.0 | 50.8 | 58.0 | 47.5 | 8.0 | 69.0 | 41 | 50 | M 12×40 | 7/16×1 1/2 | 0.36 | GFS35/35L | 160 | 160 | | |
| 1 1/4 | 32 | 25S | 27.0 | 50.8 | 60.0 | 48.0 | 8.0 | 72.0 | 41 | 46 | M 12×40 | 7/16×1 1/2 | 0.44 | GFS35/25S | 200 | 200 | | |
| 1 1/4 | 32 | 30S | 28.5 | 50.8 | 62.0 | 48.5 | 8.0 | 75.0 | 41 | 50 | M 12×40 | 7/16×1 1/2 | 0.44 | GFS35/30S | 200 | 200 | | |
| 1 1/4 | 32 | 38S | 28.0 | 50.8 | 66.0 | 50.0 | 8.0 | 81.0 | 46 | 60 | M 12×40 | 7/16×1 1/2 | 0.46 | GFS35/38S | 200 | 200 | | |
| 1 1/2 | 38 | 35L | 30.0 | 60.3 | 65.0 | 54.5 | 8.0 | 76.0 | 46 | 50 | M 12×35 | 1/2×1 1/2 | 0.55 | GFS36/35L | 160 | 160 | | |
| 1 1/2 | 38 | 42L | 36.0 | 60.3 | 64.0 | 53.0 | 8.0 | 76.0 | 46 | 60 | M 12×35 | 1/2×1 1/2 | 0.49 | GFS36/42L | 160 | 160 | | |
| 1 1/2 | 38 | 38S | 32.0 | 60.3 | 70.0 | 54.0 | 8.0 | 85.0 | 46 | 60 | M 12×35 | 1/2×1 1/2 | 0.64 | GFS36/38S | 200 | 200 | | |

¹⁾ Pressure shown = Item deliverable

²⁾ L = light series; S = heavy series

$\frac{PN \text{ (bar)}}{10} = PN \text{ (MPa)}$

Delivery without nut and ring.

Information on ordering complete fittings or alternative sealing materials see page N12.

³⁾ Order code for the flange adapter assembled with FHS35/10CFX and M10×35 bolts.

See pages N16 and N19 for related flange halves depending on bolt sets.

Stainless steel parts may have dimensional deviations. Additional information on request.

*Please add the suffixes below according to the material/surface required.

| Order code suffixes | | | | | |
|---------------------------------|-----------------------------|-----------------------------|--|--|---|
| Material | Suffix surface and material | Example only flange adapter | Example incl. splitflanges, metr. bolts and O-ring | Example incl. splitflanges, UNC bolts and O-ring | Standard sealing material (no additional suffix needed) |
| Steel, zinc plated, Cr(VI)-free | CF | GFS32/16SCFX | GFS32/16SOMDCF | GFS32/16SOMDCFU | NBR |
| Stainless steel | 71 | GFS32/16S71X | GFS32/16SOMD71 | - | VIT |



SAE Flange adapters

GFS SAE Straight flange adapter

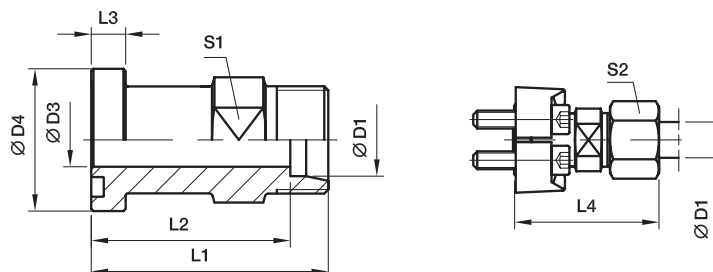
 SAE Flange / EO 24° cone end
(ISO 6162-1/-2)

6000 PSI Series

| Nom. flange size | | D1 ²⁾ | | | | | | | | | | | Bolts | | Weight (steel) kg/piece | Order code* | PN (bar) ¹⁾ | |
|------------------|----------|------------------|----|------|------|------|------|-------|----|----|---------|------------|-------|----------------------------------|----------------------------|-------------|------------------------|--|
| SAE (in.) | ISO (DN) | | D3 | D4 | L1 | L2 | L3 | L4 | S1 | S2 | (metr.) | (unc.) | CF | 71 | | | | |
| 1/2 | 13 | 12S | 8 | 31.8 | 50.0 | 42.5 | 7.7 | 57.5 | 19 | 24 | M 08×30 | 5/16×1 1/4 | 0.14 | GFS62/12S | 420 | 420 | | |
| 1/2 | 13 | 14S | 10 | 31.8 | 50.0 | 42.0 | 7.7 | 59.5 | 19 | 27 | M 08×30 | 5/16×1 1/4 | 0.17 | GFS62/14S | 420 | 420 | | |
| 1/2 | 13 | 16S | 12 | 31.8 | 50.0 | 41.5 | 7.7 | 49.5 | 19 | 30 | M 08×30 | 5/16×1 1/4 | 0.15 | GFS62/16S | 420 | 420 | | |
| 3/4 | 19 | 16S | 17 | 41.3 | 59.0 | 50.5 | 8.7 | 68.5 | 30 | 30 | M 10×35 | 3/8×1 1/2 | 0.28 | GFS63/16S | 420 | 420 | | |
| 3/4 | 19 | 20S | 17 | 41.3 | 61.0 | 50.5 | 8.7 | 72.0 | 30 | 36 | M 10×35 | 3/8×1 1/2 | 0.27 | GFS63/20S | 420 | 400 | | |
| 3/4 | 19 | 25S | 17 | 41.3 | 63.0 | 51.0 | 8.7 | 75.0 | 30 | 46 | M 10×35 | 3/8×1 1/2 | 0.31 | GFS63/25S | 420 | 400 | | |
| 3/4 | 19 | 30S | 18 | 41.3 | 76.0 | 62.0 | 8.7 | 89.0 | 30 | 50 | M 10×35 | 3/8×1 1/2 | 0.42 | GFS63/30S | 420 | 400 | | |
| 3/4 | 19 | 38S | 19 | 41.3 | 80.0 | 64.0 | 8.7 | 94.5 | 41 | 60 | M 10×35 | 3/8×1 1/2 | 0.57 | GFS63/38S | 420 | 315 | | |
| 1 | 25 | 20S | 16 | 47.6 | 75.0 | 64.5 | 9.5 | 88.0 | 36 | 36 | M 12×45 | 7/16×1 3/4 | 0.49 | GFS64/20S | 420 | 400 | | |
| 1 | 25 | 25S | 20 | 47.6 | 72.0 | 60.0 | 9.5 | 84.0 | 36 | 46 | M 12×45 | 7/16×1 3/4 | 0.46 | GFS64/25S | 420 | 400 | | |
| 1 | 25 | 30S | 24 | 47.6 | 74.0 | 62.0 | 9.5 | 87.0 | 36 | 50 | M 12×45 | 7/16×1 3/4 | 0.43 | GFS64/30S | 420 | 400 | | |
| 1 | 25 | 38S | 25 | 47.6 | 90.0 | 74.0 | 9.5 | 105.0 | 41 | 60 | M 12×45 | 7/16×1 3/4 | 0.65 | GFS64/38S | 420 | 315 | | |
| 1 1/4 | 32 | 25S | 20 | 54.0 | 80.0 | 68.0 | 10.2 | 92.0 | 41 | 46 | M 14×50 | - | 0.68 | GFS65/25S | 420 | 400 | | |
| 1 1/4 | 32 | 25S | 20 | 54.0 | 80.0 | 68.0 | 10.2 | 92.0 | 41 | 46 | M 12×50 | 1/2×1 3/4 | 0.68 | GFS65/25S/12³⁾ | 420 | 400 | | |
| 1 1/4 | 32 | 30S | 30 | 54.0 | 79.0 | 65.5 | 10.2 | 92.0 | 41 | 50 | M 12×50 | 1/2×1 3/4 | 0.58 | GFS65/30S/12³⁾ | 420 | 400 | | |
| 1 1/4 | 32 | 38S | 31 | 54.0 | 80.0 | 64.0 | 10.2 | 94.5 | 46 | 60 | M 12×50 | 1/2×1 3/4 | 0.58 | GFS65/38S/12³⁾ | 420 | 315 | | |
| 1 1/4 | 32 | 30S | 30 | 54.0 | 79.0 | 65.5 | 10.2 | 92.0 | 41 | 50 | M 14×50 | - | 0.58 | GFS65/30S | 420 | 400 | | |
| 1 1/4 | 32 | 38S | 31 | 54.0 | 80.0 | 64.0 | 10.2 | 94.5 | 46 | 60 | M 14×50 | - | 0.58 | GFS65/38S | 420 | 315 | | |
| 1 1/2 | 38 | 30S | 30 | 63.5 | 90.0 | 76.5 | 12.5 | 103.0 | 46 | 50 | M 16×55 | 5/8×2 1/4 | 1.00 | GFS66/30S | 420 | 400 | | |
| 1 1/2 | 38 | 38S | 32 | 63.5 | 90.0 | 74.0 | 12.5 | 104.5 | 46 | 60 | M 16×55 | 5/8×2 1/4 | 0.93 | GFS66/38S | 420 | 315 | | |

¹⁾ Pressure shown = Item deliverable

²⁾ S = heavy series

 $\frac{\text{PN (bar)}}{10} = \text{PN (MPa)}$
Delivery without nut and ring.
Information on ordering complete fittings or alternative sealing materials see page N12.
³⁾ Order code for the flange adapter assembled with FHS65/12CFX and M12×50 bolts.

See pages N16 and N19 for related flange halves depending on bolt sets.

Stainless steel parts may have dimensional deviations. Additional information on request.

*Please add the suffixes below according to the material/surface required.

| Order code suffixes | | | | | |
|---------------------------------|-----------------------------|-----------------------------|--|--|---|
| Material | Suffix surface and material | Example only flange adapter | Example incl. splitflanges, metr. bolts and O-ring | Example incl. splitflanges, UNC bolts and O-ring | Standard sealing material (no additional suffix needed) |
| Steel, zinc plated, Cr(VI)-free | CF | GFS62/16SCFX | GFS62/16SOMDCF | GFS62/16SOMDCFU | NBR |
| Stainless steel | 71 | GFS62/16S71X | GFS62/16SOMD71 | - | VIT |



WFS SAE 90° Elbow flange adapter

SAE Flange / EO 24° cone end
(ISO 6162-1/-2)

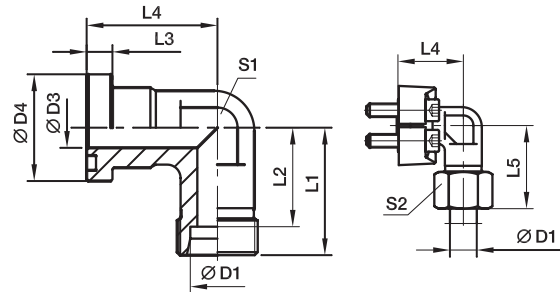

3000 PSI Series

| Nom. flange size | | D1 ²⁾ | | | | | | | | | | | Bolts | | Weight (steel) kg/piece | Order code* | PN (bar) ¹⁾ | |
|------------------|----------|------------------|-------|------|----|------|-----|----|------|----|----|---------|------------|------|----------------------------------|-------------|------------------------|--|
| SAE (in.) | ISO (DN) | | D3 | D4 | L1 | L2 | L3 | L4 | L5 | S1 | S2 | (metr.) | (unc.) | CF | | | 71 | |
| 1/2 | 13 | 12S | 12 | 30.2 | 50 | 42.5 | 6.7 | 44 | 58.5 | 22 | 24 | M 08×25 | 5/16×1 1/4 | 0.24 | WFS32/12S | 210 | 210 | |
| 1/2 | 13 | 15L | 12 | 30.2 | 36 | 29.0 | 6.7 | 36 | 44.0 | 24 | 27 | M 08×25 | 5/16×1 1/4 | 0.16 | WFS32/15L | 315 | 315 | |
| 1/2 | 13 | 16S | 12 | 30.2 | 38 | 29.5 | 6.7 | 36 | 48.0 | 24 | 30 | M 08×25 | 5/16×1 1/4 | 0.17 | WFS32/16S | 350 | 350 | |
| 1/2 | 13 | 18L | 12 | 30.2 | 50 | 42.5 | 6.7 | 44 | 59.0 | 22 | 32 | M 08×25 | 5/16×1 1/4 | 0.20 | WFS32/18L | 315 | 315 | |
| 3/4 | 19 | 16S | 19 | 38.1 | 64 | 55.5 | 6.7 | 53 | 73.5 | 27 | 30 | M 10×30 | 3/8×1 1/4 | 0.36 | WFS33/16S | 350 | 350 | |
| 3/4 | 19 | 18L | 19 | 38.1 | 39 | 31.5 | 6.7 | 42 | 48.0 | 30 | 32 | M 10×30 | 3/8×1 1/4 | 0.30 | WFS33/18L | 315 | 315 | |
| 3/4 | 19 | 22L | 19 | 38.1 | 41 | 33.5 | 6.7 | 42 | 50.0 | 30 | 36 | M 10×30 | 3/8×1 1/4 | 0.28 | WFS33/22L | 160 | 160 | |
| 3/4 | 19 | 20S | 17 | 38.1 | 43 | 32.5 | 6.7 | 42 | 54.0 | 30 | 36 | M 10×30 | 3/8×1 1/4 | 0.33 | WFS33/20S | 350 | 350 | |
| 3/4 | 19 | 25S | 17 | 38.1 | 45 | 33.0 | 6.7 | 42 | 57.0 | 30 | 46 | M 10×30 | 3/8×1 1/4 | 0.32 | WFS33/25S | 350 | 350 | |
| 1 | 25 | 20S | 16/23 | 44.5 | 65 | 54.5 | 8.0 | 60 | 77.0 | 34 | 36 | M 10×30 | 3/8×1 1/4 | 0.55 | WFS34/20S | 350 | 350 | |
| 1 | 25 | 22L | 18 | 44.5 | 65 | 57.5 | 8.0 | 60 | 74.0 | 34 | 36 | M 10×30 | 3/8×1 1/4 | 0.53 | WFS34/22L | 160 | 160 | |
| 1 | 25 | 28L | 25 | 44.5 | 44 | 36.5 | 8.0 | 45 | 53.0 | 36 | 41 | M 10×30 | 3/8×1 1/4 | 0.41 | WFS34/28L | 160 | 160 | |
| 1 | 25 | 25S | 20 | 44.5 | 48 | 36.5 | 8.0 | 45 | 57.0 | 36 | 46 | M 10×30 | 3/8×1 1/4 | 0.52 | WFS34/25S | 350 | 350 | |
| 1 | 25 | 30S | 24 | 44.5 | 50 | 36.5 | 8.0 | 45 | 63.0 | 36 | 50 | M 10×30 | 3/8×1 1/4 | 0.48 | WFS34/30S | 250 | 250 | |
| 1 1/4 | 32 | 35L | 32 | 50.8 | 57 | 46.5 | 8.0 | 50 | 68.0 | 41 | 50 | M 10×35 | - | 0.53 | WFS35/35L/10³⁾ | 160 | 160 | |
| 1 1/4 | 32 | 25S | 27 | 50.8 | 55 | 43.0 | 8.0 | 60 | 67.0 | 41 | 46 | M 10×35 | - | 0.72 | WFS35/25S/10³⁾ | 200 | 200 | |
| 1 1/4 | 32 | 30S | 28 | 50.8 | 57 | 43.5 | 8.0 | 50 | 70.0 | 41 | 50 | M 10×35 | - | 0.67 | WFS35/30S/10³⁾ | 200 | 200 | |
| 1 1/4 | 32 | 38S | 28 | 50.8 | 59 | 43.0 | 8.0 | 50 | 74.0 | 46 | 60 | M 10×35 | - | 0.71 | WFS35/38S/10³⁾ | 200 | 200 | |
| 1 1/4 | 32 | 35L | 32 | 50.8 | 57 | 46.5 | 8.0 | 50 | 68.0 | 41 | 50 | M 12×40 | 7/16×1 1/2 | 0.53 | WFS35/35L | 160 | 160 | |
| 1 1/4 | 32 | 25S | 27 | 50.8 | 55 | 43.0 | 8.0 | 50 | 67.0 | 41 | 46 | M 12×40 | 7/16×1 1/2 | 0.72 | WFS35/25S | 200 | 200 | |
| 1 1/4 | 32 | 30S | 28 | 50.8 | 57 | 43.5 | 8.0 | 50 | 70.0 | 41 | 50 | M 12×40 | 7/16×1 1/2 | 0.67 | WFS35/30S | 200 | 200 | |
| 1 1/4 | 32 | 38S | 28 | 50.8 | 59 | 43.0 | 8.0 | 50 | 74.0 | 41 | 60 | M 12×40 | 7/16×1 1/2 | 0.71 | WFS35/38S | 200 | 200 | |
| 1 1/2 | 38 | 35L | 30 | 60.3 | 78 | 67.5 | 8.0 | 66 | 83.0 | 50 | 50 | M 12×35 | 1/2×1 1/2 | 1.36 | WFS36/35L | 160 | 160 | |
| 1 1/2 | 38 | 42L | 36 | 60.3 | 58 | 47.0 | 8.0 | 55 | 70.0 | 50 | 60 | M 12×35 | 1/2×1 1/2 | 0.73 | WFS36/42L | 160 | 160 | |
| 1 1/2 | 38 | 38S | 36 | 60.3 | 64 | 48.0 | 8.0 | 55 | 79.0 | 50 | 60 | M 12×35 | 1/2×1 1/2 | 0.95 | WFS36/38S | 200 | 200 | |

¹⁾ Pressure shown = Item deliverable

²⁾ L = light series; S = heavy series

PN (bar) = PN (MPa) / 10

Delivery without nut and ring.

Information on ordering complete fittings or alternative sealing materials see page N12.

³⁾ Order code for the elbow flange adapter assembled with FHS35/10CFX and M10×35 bolts.

See pages N16 and N19 for related flange halves depending on bolt sets.

Stainless steel parts may have dimensional deviations. Additional information on request.

*Please add the **suffixes** below according to the material/surface required.

| Order code suffixes | | | | | |
|---------------------------------|-----------------------------|-----------------------------|--|--|---|
| Material | Suffix surface and material | Example only flange adapter | Example incl. splitflanges, metr. bolts and O-ring | Example incl. splitflanges, UNC bolts and O-ring | Standard sealing material (no additional suffix needed) |
| Steel, zinc plated, Cr(VI)-free | CF | WFS32/16SCFX | WFS32/16SOMDCF | WFS32/16SOMDCFU | NBR |
| Stainless steel | 71 | WFS32/16S71X | WFS32/16SOMD71 | - | VIT |



SAE Flange adapters

WFS SAE 90° Elbow flange adapter

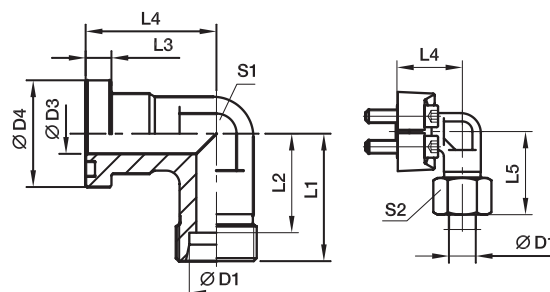
 SAE Flange / EO 24° cone end
 (ISO 6162-1/-2)

6000 PSI Series

| Nom. flange size | | D1 ²⁾ | | | | | | | | | | | Bolts | | Weight (steel) kg/piece | Order code* | PN (bar) ¹⁾ | |
|------------------|-------------|------------------|-------|------|----|------|------|----|------|----|----|---------|------------|------|----------------------------------|-------------|---------------------------|--|
| SAE (in.) | ISO (DN) | | D3 | D4 | L1 | L2 | L3 | L4 | L5 | S1 | S2 | (metr.) | (unc.) | CF | | | 71 | |
| 1/2 | 13 | 12S | 12 | 31.8 | 50 | 42.5 | 7.7 | 44 | 58.5 | 22 | 24 | M 08×30 | 5/16×1 1/4 | 0.22 | WFS62/12S | 420 | 420 | |
| 1/2 | 13 | 14S | 12 | 31.8 | 50 | 42.0 | 7.7 | 44 | 59.5 | 22 | 27 | M 08×30 | 5/16×1 1/4 | 0.27 | WFS62/14S | 420 | 420 | |
| 1/2 | 13 | 16S | 12 | 31.8 | 38 | 29.5 | 7.7 | 39 | 48.0 | 24 | 30 | M 08×30 | 5/16×1 1/4 | 0.19 | WFS62/16S | 420 | 420 | |
| 3/4 | 19 | 16S | 17 | 41.3 | 45 | 36.5 | 8.7 | 48 | 55.0 | 32 | 30 | M 10×35 | 3/8×1 1/2 | 0.42 | WFS63/16S | 420 | 420 | |
| 3/4 | 19 | 20S | 17 | 41.3 | 46 | 35.5 | 8.7 | 48 | 57.0 | 32 | 36 | M 10×35 | 3/8×1 1/2 | 0.42 | WFS63/20S | 420 | 400 | |
| 3/4 | 19 | 25S | 17 | 41.3 | 48 | 36.0 | 8.7 | 48 | 60.0 | 32 | 46 | M 10×35 | 3/8×1 1/2 | 0.46 | WFS63/25S | 420 | 400 | |
| 1 | 25 | 20S | 16 | 47.6 | 65 | 54.5 | 9.5 | 62 | 75.0 | 34 | 36 | M 12×45 | 7/16×1 3/4 | 0.60 | WFS64/20S | 420 | 400 | |
| 1 | 25 | 25S | 20 | 47.6 | 53 | 41.0 | 9.5 | 60 | 65.0 | 41 | 46 | M 12×45 | 7/16×1 3/4 | 0.74 | WFS64/25S | 420 | 400 | |
| 1 | 25 | 30S | 25 | 47.6 | 55 | 41.5 | 9.5 | 60 | 68.0 | 41 | 50 | M 12×45 | 7/16×1 3/4 | 0.64 | WFS64/30S | 420 | 400 | |
| 1 1/4 | 32 | 25S | 25 | 54.0 | 72 | 60.0 | 10.2 | 70 | 84.0 | 42 | 46 | M 12×50 | 1/2×1 3/4 | 1.06 | WFS65/25S/12³⁾ | 420 | 400 | |
| 1 1/4 | 32 | 30S | 30 | 54.0 | 58 | 44.5 | 10.2 | 68 | 71.0 | 46 | 50 | M 12×50 | 1/2×1 3/4 | 0.88 | WFS65/30S/12³⁾ | 420 | 400 | |
| 1 1/4 | 32 | 38S | 30 | 54.0 | 72 | 56.0 | 10.2 | 70 | 87.0 | 46 | 60 | M 12×50 | 1/2×1 3/4 | 0.93 | WFS65/38S/12³⁾ | 420 | 315 | |
| 1 1/4 | 32 | 25S | 20/28 | 54.0 | 72 | 60.0 | 10.3 | 70 | 84.0 | 42 | 46 | M 14×50 | - | 1.06 | WFS65/25S | 420 | 400 | |
| 1 1/4 | 32 | 30S | 30 | 54.0 | 58 | 44.5 | 10.2 | 68 | 71.0 | 46 | 50 | M 14×50 | - | 0.88 | WFS65/30S | 420 | 400 | |
| 1 1/4 | 32 | 38S | 30 | 54.0 | 72 | 56.0 | 10.2 | 70 | 87.0 | 46 | 60 | M 14×50 | - | 0.93 | WFS65/38S | 420 | 315 | |
| 1 1/2 | 38 | 30S | 25 | 63.5 | 76 | 63.5 | 12.5 | 77 | 90.0 | 50 | 50 | M 16×55 | 5/8×2 1/4 | 1.75 | WFS66/30S | 420 | 400 | |
| 1 1/2 | 38 | 38S | 32 | 63.5 | 84 | 68.0 | 12.5 | 80 | 99.0 | 50 | 60 | M 16×55 | 5/8×2 1/4 | 1.46 | WFS66/38S | 420 | 315 | |

¹⁾ Pressure shown = item deliverable

²⁾ S = heavy series

 $\frac{PN \text{ (bar)}}{10} = PN \text{ (MPa)}$
Delivery without nut and ring.
Information on ordering complete fittings or alternative sealing materials see page N12.
³⁾ Order code for the elbow flange adapter assembled with FHS65/12CFX and M12×50 bolts.

See pages N16 and N19 for related flange halves depending on bolt sets.

Stainless steel parts may have dimensional deviations. Additional information on request.

*Please add the suffixes below according to the material/surface required.

| Order code suffixes | | | | | |
|---------------------------------|-----------------------------|-----------------------------|--|--|---|
| Material | Suffix surface and material | Example only flange adapter | Example incl. splitflanges, metr. bolts and O-ring | Example incl. splitflanges, UNC bolts and O-ring | Standard sealing material (no additional suffix needed) |
| Steel, zinc plated, Cr(VI)-free | CF | WFS62/16SCFX | WFS62/16SOMDCF | WFS62/16SOMDCFU | NBR |
| Stainless steel | 71 | WFS62/16S71X | WFS62/16SOMD71 | - | VIT |



GFS-G SAE Straight flange adapter

SAE Flange / BSPP 60° cone end
(ISO 6162-1/-2) (ISO 8434-6)

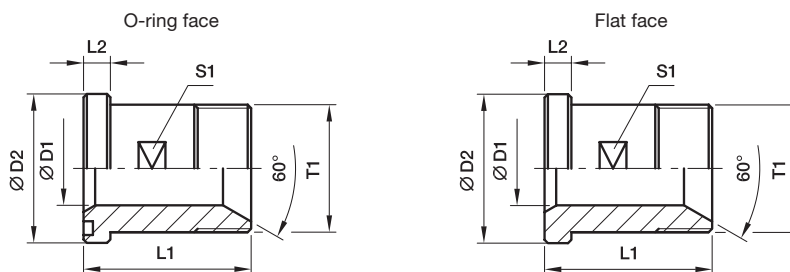

3000 PSI Series

| Nom. flange size | | T1 | D1 | D2 | L1 | L2 | S1 | Weight (steel) kg/piece | O-ring face Order code* | Flat face Order code* | PN (bar) ¹⁾ | |
|------------------|----------|----------------|----|------|----|-----|----|-------------------------|-------------------------|-----------------------|------------------------|-----|
| SAE (in.) | ISO (DN) | | | | | | | | | | CF | SS |
| 1/2 | 13 | G 1/2 | 12 | 30.2 | 50 | 6.7 | 19 | 0.11 | GFS32/12G | GFSG32/12G | 345 | 345 |
| 1/2 | 13 | G 3/8 | 10 | 30.2 | 50 | 6.7 | 19 | 0.12 | GFS32/38G | GFSG32/38G | 345 | 345 |
| 3/4 | 19 | G 3/4 | 17 | 38.1 | 55 | 6.7 | 27 | 0.18 | GFS33/34G | GFSG33/34G | 345 | 345 |
| 3/4 | 19 | G 1/2 | 12 | 38.1 | 55 | 6.7 | 27 | 0.21 | GFS33/12G | GFSG33/12G | 345 | 345 |
| 1 | 25 | G 1 | 22 | 44.4 | 60 | 8.0 | 32 | 0.28 | GFS34/1G | GFSG34/1G | 345 | 345 |
| 1 | 25 | G 3/4 | 17 | 44.4 | 60 | 8.0 | 32 | 0.31 | GFS34/34G | GFSG34/34G | 345 | 345 |
| 1 1/4 | 32 | G 1 1/4 | 27 | 50.8 | 65 | 8.0 | 41 | 0.41 | GFS35/114G | GFSG35/114G | 276 | 276 |
| 1 1/4 | 32 | G 1 | 22 | 50.8 | 65 | 8.0 | 41 | 0.44 | GFS35/1G | GFSG35/1G | 276 | 276 |
| 1 1/2 | 38 | G 1 1/2 | 32 | 60.3 | 70 | 8.0 | 46 | 0.58 | GFS36/112G | GFSG36/112G | 207 | 207 |
| 1 1/2 | 38 | G 1 1/4 | 27 | 60.3 | 70 | 8.0 | 46 | 0.64 | GFS36/114G | GFSG36/114G | 207 | 207 |
| 2 | 51 | G 2 | 40 | 71.4 | 75 | 9.5 | 55 | 0.89 | GFS38/2G | GFSG38/2G | 207 | 207 |
| 2 | 51 | G 1 1/2 | 32 | 71.4 | 75 | 9.5 | 55 | 1.01 | GFS38/112G | GFSG38/112G | 207 | 207 |

6000 PSI Series

| | | | | | | | | | | | | |
|-------|----|----------------|----|------|----|------|----|------|-----------------------------------|------------------------------------|-----|-----|
| 1/2 | 13 | G 1/2 | 12 | 31.8 | 50 | 7.7 | 19 | 0.12 | GFS62/12G | GFSG62/12G | 420 | 420 |
| 1/2 | 13 | G 3/8 | 10 | 31.8 | 50 | 7.7 | 19 | 0.13 | GFS62/38G | GFSG62/38G | 420 | 420 |
| 3/4 | 19 | G 3/4 | 17 | 41.3 | 60 | 8.7 | 26 | 0.24 | GFS63/34G | GFSG63/34G | 420 | 420 |
| 3/4 | 19 | G 1/2 | 12 | 41.3 | 60 | 8.7 | 26 | 0.22 | GFS63/12G | GFSG63/12G | 420 | 420 |
| 1 | 25 | G 1 | 22 | 47.6 | 70 | 9.5 | 32 | 0.35 | GFS64/1G | GFSG64/1G | 420 | 420 |
| 1 | 25 | G 3/4 | 17 | 47.6 | 70 | 9.5 | 32 | 0.40 | GFS64/34G | GFSG64/34G | 420 | 420 |
| 1 1/4 | 32 | G 1 1/4 | 27 | 54.0 | 75 | 10.3 | 36 | 0.50 | GFS65/114G | GFSG65/114G | 420 | 420 |
| 1 1/4 | 32 | G 1 1/4 | 27 | 54.0 | 75 | 10.3 | 36 | 0.50 | GFS65/114G/12³⁾ | GFSG65/114G/12³⁾ | 420 | 420 |
| 1 1/4 | 32 | G 1 | 22 | 54.0 | 75 | 10.3 | 36 | 0.54 | GFS65/1G | GFSG65/1G | 420 | 420 |
| 1 1/4 | 32 | G 1 | 22 | 54.0 | 75 | 10.3 | 36 | 0.54 | GFS65/1G/12³⁾ | GFSG65/1G/12³⁾ | 420 | 420 |
| 1 1/2 | 38 | G 1 1/2 | 32 | 63.5 | 80 | 12.5 | 46 | 0.73 | GFS66/112G | GFSG66/112G | 420 | 420 |
| 1 1/2 | 38 | G 1 1/4 | 27 | 63.5 | 80 | 12.5 | 46 | 0.80 | GFS66/114G | GFSG66/114G | 420 | 420 |
| 2 | 51 | G 2 | 40 | 79.4 | 90 | 12.5 | 55 | 1.34 | GFS68/2G | GFSG68/2G | 420 | 420 |
| 2 | 51 | G 1 1/2 | 32 | 79.4 | 90 | 12.5 | 55 | 1.54 | GFS68/112G | GFSG68/112G | 420 | 420 |

¹⁾ Pressure shown = Item deliverable

$$\frac{\text{PN (bar)}}{10} = \text{PN (MPa)}$$

³⁾ Order code for the straight flange adapter assembled with FHS65/12CFX and M12x45 bolts.

See pages N16 and N19 for related flange halves depending on bolt sets.

Stainless steel parts may have dimensional deviations. Additional information on request.

*Please add the **suffixes** below according to the material/surface required.

| Order code suffixes | | | | | |
|---------------------------------|-----------------------------|-----------------------------|--|--|---|
| Material | Suffix surface and material | Example only flange adapter | Example incl. splitflanges, metr. bolts and O-ring | Example incl. splitflanges, UNC bolts and O-ring | Standard sealing material (no additional suffix needed) |
| Steel, zinc plated, Cr(VI)-free | CF | GFS32/12GCF | GFS32/12GCFM | GFS32/12GCFU | NBR |
| Stainless steel | SS | GFS32/12GSS | GFS32/12GSSM | - | VIT |



SAE Flange adapters

WFS-G SAE 90° Elbow flange adapter

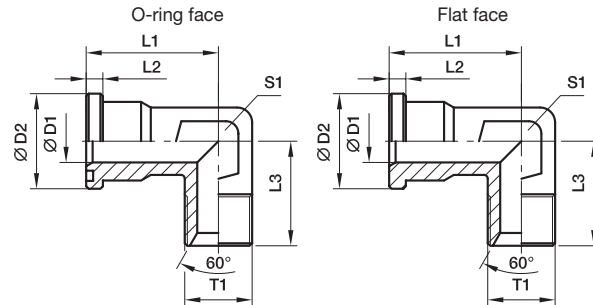
 SAE Flange / BSPP 60° cone end
 (ISO 6162-1/-2) (ISO 8434-6)

3000 PSI Series

| Nom. flange size | | T1 | D1 | D2 | L1 | L2 | L3 | S1 | Weight (steel) kg/piece | O-ring face Order code* | Flat face Order code* | PN (bar) ¹⁾ | |
|------------------|----------|----------------|----|------|----|-----|----|----|-------------------------|-------------------------|-----------------------|------------------------|-----|
| SAE (in.) | ISO (DN) | | | | | | | | | | | CF | SS |
| 1/2 | 13 | G 1/2 | 12 | 30.2 | 44 | 6.7 | 50 | 22 | 0.19 | WFS32/12G | WFSG32/12G | 345 | 345 |
| 1/2 | 13 | G 3/8 | 10 | 30.2 | 44 | 6.7 | 50 | 22 | 0.20 | WFS32/38G | WFSG32/38G | 345 | 345 |
| 3/4 | 19 | G 1/2 | 12 | 38.1 | 53 | 6.7 | 64 | 27 | 0.42 | WFS33/12G | WFSG33/12G | 345 | 345 |
| 3/4 | 19 | G 3/4 | 17 | 38.1 | 53 | 6.7 | 64 | 27 | 0.35 | WFS33/34G | WFSG33/34G | 345 | 345 |
| 3/4 | 19 | G 1 | 19 | 38.1 | 53 | 6.7 | 64 | 27 | 0.36 | WFS33/1G | WFSG33/1G | 345 | 345 |
| 1 | 25 | G 3/4 | 17 | 44.4 | 60 | 8.0 | 65 | 34 | 0.71 | WFS34/34G | WFSG34/34G | 345 | 345 |
| 1 | 25 | G 1 | 22 | 44.4 | 60 | 8.0 | 65 | 34 | 0.52 | WFS34/1G | WFSG34/1G | 345 | 345 |
| 1 | 25 | G 1 1/4 | 25 | 44.4 | 60 | 8.0 | 65 | 34 | 0.62 | WFS34/114G | WFSG34/114G | 345 | 345 |
| 1 1/4 | 32 | G 1 | 22 | 50.8 | 55 | 8.0 | 64 | 42 | 0.84 | WFS35/1G | WFSG35/1G | 276 | 276 |
| 1 1/4 | 32 | G 1 1/4 | 28 | 50.8 | 55 | 8.0 | 64 | 42 | 0.76 | WFS35/114G | WFSG35/114G | 276 | 276 |
| 1 1/2 | 38 | G 1 1/4 | 28 | 60.3 | 66 | 8.0 | 78 | 50 | 1.49 | WFS36/114G | WFSG36/114G | 207 | 207 |
| 1 1/2 | 38 | G 1 1/2 | 34 | 60.3 | 66 | 8.0 | 78 | 50 | 1.23 | WFS36/112G | WFSG36/112G | 207 | 207 |

6000 PSI Series

| | | | | | | | | | | | | | |
|-------|----|----------------|----|------|----|------|----|----|------|-----------------------------------|------------------------------------|-----|-----|
| 1/2 | 13 | G 1/2 | 12 | 31.8 | 44 | 7.7 | 50 | 22 | 0.22 | WFS62/12G | WFSG62/12G | 420 | 420 |
| 1/2 | 13 | G 3/8 | 10 | 31.8 | 44 | 7.7 | 50 | 22 | 0.37 | WFS62/34G | WFSG62/34G | 420 | 420 |
| 3/4 | 19 | G 1/2 | 14 | 41.3 | 53 | 8.7 | 64 | 27 | 0.88 | WFS63/12G | WFSG63/12G | 420 | 420 |
| 3/4 | 19 | G 3/4 | 17 | 41.3 | 53 | 8.7 | 64 | 27 | 0.37 | WFS63/34G | WFSG63/34G | 420 | 420 |
| 3/4 | 19 | G 1 | 19 | 41.3 | 53 | 8.7 | 64 | 27 | 0.41 | WFS63/1G | WFSG63/1G | 420 | 420 |
| 1 | 25 | G 3/4 | 17 | 47.6 | 60 | 9.5 | 62 | 34 | 0.69 | WFS64/34G | WFSG64/34G | 420 | 420 |
| 1 | 25 | G 1 | 22 | 47.6 | 60 | 9.5 | 62 | 34 | 0.59 | WFS64/1G | WFSG64/1G | 420 | 420 |
| 1 | 25 | G 1 1/4 | 25 | 47.6 | 60 | 9.5 | 62 | 34 | 1.70 | WFS64/114G | WFSG64/114G | 420 | 420 |
| 1 1/4 | 32 | G 1 | 22 | 54.0 | 70 | 10.3 | 72 | 42 | 1.17 | WFS65/1G | WFSG65/1G | 420 | 420 |
| 1 1/4 | 32 | G 1 | 22 | 54.0 | 70 | 10.3 | 72 | 42 | 1.17 | WFS65/1G/12³⁾ | WFSG65/1G/12³⁾ | 420 | 420 |
| 1 1/4 | 32 | G 1 1/4 | 27 | 54.0 | 70 | 10.3 | 72 | 42 | 0.99 | WFS65/114G | WFSG65/114G | 420 | 420 |
| 1 1/4 | 32 | G 1 1/4 | 27 | 54.0 | 70 | 10.3 | 72 | 42 | 0.99 | WFS65/114G/12³⁾ | WFSG65/114G/12³⁾ | 420 | 420 |
| 1 1/2 | 38 | G 1 1/4 | 27 | 63.5 | 80 | 12.5 | 84 | 50 | 1.70 | WFS66/114G | WFSG66/114G | 420 | 420 |
| 1 1/2 | 38 | G 1 1/2 | 32 | 63.5 | 80 | 12.5 | 84 | 50 | 1.47 | WFS66/112G | WFSG66/112G | 420 | 420 |

1) Pressure shown = Item deliverable

$$\frac{\text{PN (bar)}}{10} = \text{PN (MPa)}$$

3) Order code for the elbow flange adapter assembled with FHS65/12CFX and M12x45 bolts.

See pages N16 and N19 for related flange halves depending on bolt sets.

Stainless steel parts may have dimensional deviations. Additional information on request.

 *Please add the **suffixes** below according to the material/surface required.

| Order code suffixes | | | | | |
|---------------------------------|-----------------------------|-----------------------------|--|--|---|
| Material | Suffix surface and material | Example only flange adapter | Example incl. splitflanges, metr. bolts and O-ring | Example incl. splitflanges, UNC bolts and O-ring | Standard sealing material (no additional suffix needed) |
| Steel, zinc plated, Cr(VI)-free | CF | WFS32/12GCF | WFS32/12GCFM | WFS32/12GCFU | NBR |
| Stainless steel | SS | WFS32/12GSS | WFS32/12GSSM | - | VIT |



GFS-N SAE Flange adapters straight

SAE Flange / Male NPT thread
(ISO 6162-1/-2) (SAE J476)

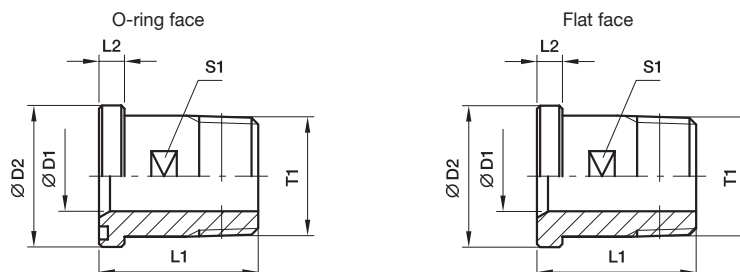

3000 PSI Series

| Nom. flange size | | T1 | D1 | D2 | L1 | L2 | S1 | Weight (steel) kg/piece | O-ring face Order code* | Flat face Order code* | PN (bar) ¹⁾ | |
|------------------|----------|-----------|----|------|----|-----|----|-------------------------|-------------------------|-----------------------|------------------------|-----|
| SAE (in.) | ISO (DN) | | | | | | | | | | CF | SS |
| 1/2 | 13 | 1/2 NPT | 12 | 30.2 | 50 | 6.7 | 19 | 0.12 | GFS32/12N | GFSG32/12N | 345 | 345 |
| 1/2 | 13 | 3/8 NPT | 10 | 30.2 | 50 | 6.7 | 19 | 0.12 | GFS32/38N | GFSG32/38N | 345 | 345 |
| 3/4 | 19 | 3/4 NPT | 17 | 38.1 | 55 | 6.7 | 27 | 0.18 | GFS33/34N | GFSG33/34N | 345 | 345 |
| 3/4 | 19 | 1/2 NPT | 12 | 38.1 | 55 | 6.7 | 27 | 0.16 | GFS33/12N | GFSG33/12N | 345 | 345 |
| 1 | 25 | 1 NPT | 22 | 44.4 | 60 | 8.0 | 32 | 0.29 | GFS34/1N | GFSG34/1N | 345 | 345 |
| 1 | 25 | 3/4 NPT | 17 | 44.4 | 60 | 8.0 | 32 | 0.32 | GFS34/34N | GFSG34/34N | 345 | 345 |
| 1 1/4 | 32 | 1 1/4 NPT | 27 | 50.8 | 65 | 8.0 | 41 | 0.42 | GFS35/114N | GFSG35/114N | 276 | 276 |
| 1 1/4 | 32 | 1 NPT | 22 | 50.8 | 65 | 8.0 | 41 | 0.44 | GFS35/1N | GFSG35/1N | 276 | 276 |
| 1 1/2 | 38 | 1 1/2 NPT | 32 | 60.3 | 70 | 8.0 | 46 | 0.62 | GFS36/112N | GFSG36/112N | 207 | 207 |
| 1 1/2 | 38 | 1 1/4 NPT | 27 | 60.3 | 70 | 8.0 | 46 | 0.66 | GFS36/114N | GFSG36/114N | 207 | 207 |
| 2 | 51 | 2 NPT | 40 | 71.4 | 75 | 9.5 | 55 | 0.99 | GFS38/2N | GFSG38/2N | 207 | 207 |
| 2 | 51 | 1 1/2 NPT | 32 | 71.4 | 75 | 9.5 | 55 | 1.05 | GFS38/112N | GFSG38/112N | 207 | 207 |

6000 PSI Series

| | | | | | | | | | | | | |
|-------|----|-----------|----|------|----|------|----|------|-----------------------------|------------------------------|-----|-----|
| 1/2 | 13 | 1/2 NPT | 12 | 31.8 | 50 | 7.7 | 19 | 0.09 | GFS62/12N | GFSG62/12N | 420 | 420 |
| 1/2 | 13 | 3/8 NPT | 10 | 31.8 | 50 | 7.7 | 19 | 0.13 | GFS62/38N | GFSG62/38N | 420 | 420 |
| 3/4 | 19 | 3/4 NPT | 17 | 41.3 | 60 | 8.7 | 26 | 0.24 | GFS63/34N | GFSG63/34N | 420 | 420 |
| 3/4 | 19 | 1/2 NPT | 12 | 41.3 | 60 | 8.7 | 26 | 0.25 | GFS63/12N | GFSG63/12N | 420 | 420 |
| 1 | 25 | 1 NPT | 22 | 47.6 | 70 | 9.5 | 32 | 0.41 | GFS64/1N | GFSG64/1N | 420 | 420 |
| 1 | 25 | 3/4 NPT | 17 | 47.6 | 70 | 9.5 | 32 | 0.43 | GFS64/34N | GFSG64/34N | 420 | 420 |
| 1 1/4 | 32 | 1 1/4 NPT | 27 | 54.0 | 75 | 10.3 | 36 | 0.57 | GFS65/114N | GFSG65/114N | 420 | 420 |
| 1 1/4 | 32 | 1 1/4 NPT | 27 | 54.0 | 75 | 10.3 | 36 | 0.57 | GFS65/114N/12 ³⁾ | GFSG65/114N/12 ³⁾ | 420 | 420 |
| 1 1/4 | 32 | 1 NPT | 22 | 54.0 | 75 | 10.3 | 36 | 0.57 | GFS65/1N | GFSG65/1N | 420 | 420 |
| 1 1/4 | 32 | 1 NPT | 22 | 54.0 | 75 | 10.3 | 36 | 0.57 | GFS65/1N/12 ³⁾ | GFSG65/1N/12 ³⁾ | 420 | 420 |
| 1 1/2 | 38 | 1 1/2 NPT | 32 | 63.5 | 80 | 12.5 | 46 | 0.77 | GFS66/112N | GFSG66/112N | 420 | 420 |
| 1 1/2 | 38 | 1 1/4 NPT | 27 | 63.5 | 80 | 12.5 | 46 | 0.81 | GFS66/114N | GFSG66/114N | 420 | 420 |
| 2 | 51 | 2 NPT | 40 | 79.4 | 90 | 12.5 | 55 | 1.41 | GFS68/2N | GFSG68/2N | 420 | 420 |
| 2 | 51 | 1 1/2 NPT | 32 | 79.4 | 90 | 12.5 | 55 | 1.57 | GFS68/112N | GFSG68/112N | 420 | 420 |

¹⁾ Pressure shown = Item deliverable

$\frac{PN \text{ (bar)}}{10} = PN \text{ (MPa)}$

³⁾ Order code for the straight flange adapter assembled with FHS65/12CFX and M12x45 bolts.

See pages N16 and N19 for related flange halves depending on bolt sets.

Stainless steel parts may have dimensional deviations. Additional information on request.

*Please add the suffixes below according to the material/surface required.

| Order code suffixes | | | | | |
|---------------------------------|-----------------------------|-----------------------------|--|--|---|
| Material | Suffix surface and material | Example only flange adapter | Example incl. splitflanges, metr. bolts and O-ring | Example incl. splitflanges, UNC bolts and O-ring | Standard sealing material (no additional suffix needed) |
| Steel, zinc plated, Cr(VI)-free | CF | GFS32/12NCF | GFS32/12NCFM | GFS32/12NCFU | NBR |
| Stainless steel | SS | GFS32/12NSS | GFS32/12NSSM | - | VIT |



SAE Flange adapters

L(O)HQ SAE Straight flange adapter

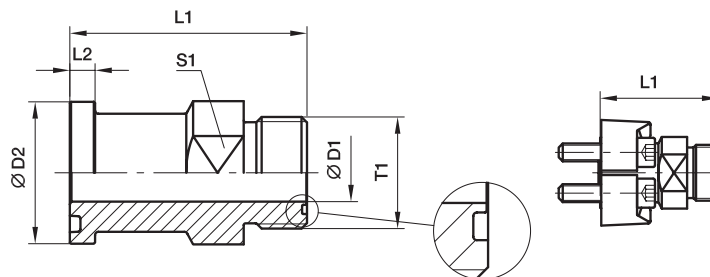
 SAE Flange / O-Lok® ORFS end
 (ISO 6162-1/-2)

3000 PSI Series

| Nom. flange size | | Tube | | T1 | D1 | D2 | L1 | L2 | S1 | Weight (steel) kg/piece | O-ring face without ORFS O-ring | O-ring face include ORFS O-ring | PN (bar) ¹⁾ |
|------------------|----------|------------|--------|---------------------|------|------|------|-----|------|-------------------------|---------------------------------|---------------------------------|------------------------|
| SAE (in.) | ISO (DN) | (metr.) | (in.) | | | | | | | | Order code* | Order code* | S |
| 3/4 | 19 | 18, 20 | 3/4 | 1 3/16-12UN | 15.5 | 38.1 | 70.9 | 6.7 | 35.0 | 0.21 | 12LHQ1 | 12LOHQ1 | 350 |
| 1 | 25 | 22, 25 | 7/8, 1 | 1 7/16-12UN | 20.6 | 44.5 | 71.4 | 8.0 | 41.0 | 0.30 | 16LHQ1 | 16LOHQ1 | 350 |
| 1 1/4 | 32 | 28, 30, 32 | 1 1/4 | 1 11/16-12UN | 26.0 | 50.8 | 81.5 | 8.0 | 47.5 | 0.31 | 20LHQ1 | 20LOHQ1 | 280 |
| 1 1/2 | 38 | 35, 38 | 1 1/2 | 2-12UN | 32.0 | 60.3 | 83.6 | 8.0 | 54.0 | 0.56 | 24LHQ1 | 24LOHQ1 | 210 |

6000 PSI Series

| | | | | | | | | | | | | | |
|-------|----|------------|----------|---------------------|------|------|-------|------|------|------|------------------|-------------------|-----|
| 3/4 | 19 | 18, 20 | 3/4 | 1 3/16-12UN | 15.5 | 41.3 | 76.7 | 8.8 | 35.0 | 0.21 | 12LHQ2 | 12LOHQ2 | 420 |
| 1 | 25 | 18, 20 | 3/4 | 1 3/16-12UN | 15.5 | 47.6 | 84.8 | 9.5 | 35.0 | 0.26 | 12-16LHQ2 | 12-16LOHQ2 | 420 |
| 1 | 25 | 22, 27 | 3/4, 7/8 | 1 7/16-12UN | 20.6 | 47.6 | 85.3 | 9.5 | 41.0 | 0.30 | 16LHQ2 | 16LOHQ2 | 420 |
| 1 1/4 | 32 | 28, 30, 32 | 1 1/4 | 1 11/16-12UN | 26.0 | 54.0 | 88.4 | 10.3 | 47.5 | 0.31 | 20LHQ2 | 20LOHQ2 | 345 |
| 1 1/2 | 38 | 35, 38 | 1 1/2 | 2-12UN | 32.0 | 63.5 | 105.2 | 12.6 | 54.0 | 0.56 | 24LHQ2 | 24LOHQ2 | 310 |

¹⁾Pressure shown = Item deliverable

$$\frac{PN \text{ (bar)}}{10} = PN \text{ (MPa)}$$

See pages N16 and N19 for related flange halves depending on bolt sets.

Stainless steel parts may have dimensional deviations. Additional information on request.

 *Please add the **suffixes** below according to the material/surface required.

| Material | Suffix surface and material | Order code suffixes | | Standard sealing material (no additional suffix needed) |
|--------------|-----------------------------|---|---|---|
| | | Example only flange adapter without ORFS O-ring | Example only flange adapter incl. ORFS O-ring | |
| Steel, oiled | S | 12LHQ1-S | 12LOHQ1-S | NBR |



L(O)EMQ SAE 90° Elbow flange adapter

SAE Flange / O-Lok® ORFS end
(ISO 6162-1/-2)

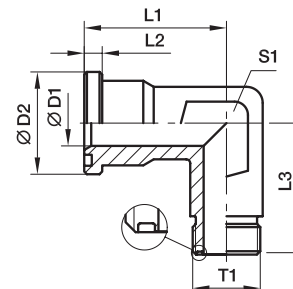

3000 PSI Series

| Nom. flange size | | Tube | | T1 | D1 | D2 | L1 | L2 | L3 | S1 | Weight (steel) kg/piece | O-ring face without ORFS | O-ring face include ORFS | PN (bar) ¹⁾ | |
|------------------|----------|------------|--------|---------------------|----|------|----|-----|----|----|-------------------------|--------------------------|--------------------------|------------------------|-----|
| SAE (in.) | ISO (DN) | (metr.) | (in.) | | | | | | | | | Order code* | Order code* | CF | SS |
| 1/2 | 13 | 8, 10 | 3/8 | 11/16-16UN | 6 | 30.2 | 44 | 6.7 | 50 | 22 | 0.40 | 6-8LEMQ1 | 6-8LOEMQ1 | 350 | 350 |
| 1/2 | 13 | 12 | 1/2 | 13/16-16UN | 9 | 30.2 | 44 | 6.7 | 50 | 22 | 0.36 | 8LEMQ1 | 8LOEMQ1 | 350 | 350 |
| 1/2 | 13 | 14, 15, 16 | 5/8 | 1-14UN | 12 | 30.2 | 44 | 6.7 | 50 | 22 | 0.32 | 10-8LEMQ1 | 10-8LOEMQ1 | 350 | 350 |
| 3/4 | 19 | 14, 15, 16 | 5/8 | 1-14UN | 12 | 38.1 | 53 | 6.7 | 64 | 27 | 0.47 | 10-12LEMQ1 | 10-12LOEMQ1 | 350 | 350 |
| 3/4 | 19 | 18, 20 | 3/4 | 1 3/16-12UN | 15 | 38.1 | 53 | 6.7 | 64 | 27 | 0.44 | 12LEMQ1 | 12LOEMQ1 | 350 | 350 |
| 1 | 25 | 18, 20 | 3/4 | 1 3/16-12UN | 15 | 44.4 | 60 | 8.0 | 65 | 34 | 0.52 | 12-16LEMQ1 | 12-16LOEMQ1 | 350 | 350 |
| 1 | 25 | 22, 25 | 7/8, 1 | 1 7/16-12UN | 20 | 44.4 | 60 | 8.0 | 65 | 34 | 0.50 | 16LEMQ1 | 16LOEMQ1 | 350 | 350 |
| 1 1/4 | 32 | 22, 25 | 7/8, 1 | 1 7/16-12UN | 20 | 50.8 | 55 | 8.0 | 64 | 42 | 0.48 | 16-20LEMQ1 | 16-20LOEMQ1 | 278 | 278 |
| 1 1/4 | 32 | 28, 30, 32 | 1 1/4 | 1 11/16-12UN | 26 | 50.8 | 55 | 8.0 | 64 | 42 | 0.56 | 20LEMQ1 | 20LOEMQ1 | 278 | 278 |
| 1 1/2 | 38 | 28, 30, 32 | 1 1/4 | 1 11/16-12UN | 26 | 60.3 | 66 | 8.0 | 78 | 50 | 0.73 | 20-24LEMQ1 | 20-24LOEMQ1 | 207 | 207 |
| 1 1/2 | 38 | 35, 38 | 1 1/2 | 2-12UN | 32 | 60.3 | 66 | 8.0 | 78 | 50 | 0.69 | 24LEMQ1 | 24LOEMQ1 | 207 | 207 |

6000 PSI Series

| | | | | | | | | | | | | | | | |
|-------|----|------------|--------|---------------------|----|------|----|------|----|----|------|-------------------|--------------------|-----|-----|
| 1/2 | 13 | 8, 10 | 3/8 | 11/16-16UN | 6 | 31.8 | 44 | 7.7 | 50 | 22 | 0.40 | 6-8LEMQ2 | 6-8LOEMQ2 | 420 | 420 |
| 1/2 | 13 | 12 | 1/2 | 13/16-16UN | 9 | 31.8 | 44 | 7.7 | 50 | 22 | 0.36 | 8LEMQ2 | 8LOEMQ2 | 420 | 420 |
| 1/2 | 13 | 14, 15, 16 | 5/8 | 1-14UN | 12 | 31.8 | 44 | 7.7 | 50 | 22 | 0.32 | 10-8LEMQ2 | 10-8LOEMQ2 | 420 | 420 |
| 3/4 | 19 | 14, 15, 16 | 5/8 | 1-14UN | 12 | 41.3 | 53 | 8.7 | 64 | 27 | 0.47 | 10-12LEMQ2 | 10-12LOEMQ2 | 420 | 420 |
| 3/4 | 19 | 18, 20 | 3/4 | 1 3/16-12UN | 15 | 41.3 | 53 | 8.7 | 64 | 27 | 0.44 | 12LEMQ2 | 12LOEMQ2 | 420 | 420 |
| 1 | 25 | 18, 20 | 3/4 | 1 3/16-12UN | 15 | 47.6 | 60 | 9.5 | 62 | 34 | 0.52 | 12-16LEMQ2 | 12-16LOEMQ2 | 420 | 420 |
| 1 | 25 | 22, 25 | 7/8, 1 | 1 7/16-12UN | 20 | 47.6 | 60 | 9.5 | 62 | 34 | 0.50 | 16LEMQ2 | 16LOEMQ2 | 420 | 420 |
| 1 1/4 | 32 | 22, 25 | 7/8, 1 | 1 7/16-12UN | 20 | 54.0 | 70 | 10.3 | 72 | 42 | 0.48 | 16-20LEMQ2 | 16-20LOEMQ2 | 420 | 420 |
| 1 1/4 | 32 | 28, 30, 32 | 1 1/4 | 1 11/16-12UN | 26 | 54.0 | 70 | 10.3 | 72 | 42 | 0.56 | 20LEMQ2 | 20LOEMQ2 | 345 | 345 |
| 1 1/2 | 38 | 28, 30, 32 | 1 1/4 | 1 11/16-12UN | 26 | 63.5 | 80 | 12.5 | 84 | 50 | 0.73 | 20-24LEMQ2 | 20-24LOEMQ2 | 345 | 345 |
| 1 1/2 | 38 | 35, 38 | 1 1/2 | 2-12UN | 32 | 63.5 | 80 | 12.5 | 84 | 50 | 0.69 | 24LEMQ2 | 24LOEMQ2 | 310 | 310 |

¹⁾ Pressure shown = Item deliverable

$$\frac{\text{PN (bar)}}{10} = \text{PN (MPa)}$$

See pages N16 and N19 for related flange halves depending on bolt sets.

Stainless steel parts may have dimensional deviations. Additional information on request.

*Please add the **suffixes** below according to the material/surface required.

| Order code suffixes | | | | |
|---------------------------------|-----------------------------|---|---|---|
| Material | Suffix surface and material | Example only flange adapter without ORFS O-ring | Example only flange adapter incl. ORFS O-ring | Standard sealing material (no additional suffix needed) |
| Steel, zinc plated, Cr(VI)-free | CF | 12LEMQ1CF | 12LOEMQ1CF | NBR |
| Stainless steel | SS | 12LEMQ1SS | 12LOEMQ1SS | VIT |



SAE Flange adapters

L(O)VQ SAE 45° Elbow flange adapter

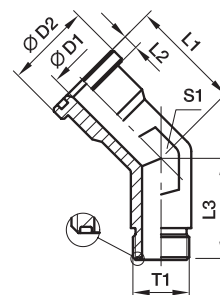
 SAE Flange / O-Lok® ORFS end
 (ISO 6162-1/-2)

3000 PSI Series

| Nom. flange size | | Tube | | T1 | D1 | D2 | L1 | L2 | L3 | S1 | Weight (steel) kg/piece | O-ring face without ORFS O-ring | O-ring face include ORFS O-ring | PN (bar) ¹⁾ |
|------------------|----------|------------|--------|---------------------|------|------|------|-----|------|------|-------------------------|---------------------------------|---------------------------------|------------------------|
| SAE (in.) | ISO (DN) | (metr.) | (in.) | | | | | | | | | Order code* | Order code* | S |
| 3/4 | 19 | 18, 20 | 3/4 | 1 3/16-12UN | 15.5 | 38.1 | 40.0 | 6.7 | 30.5 | 36.0 | 0.29 | 12LVQ1 | 12LOVQ1 | 350 |
| 1 | 25 | 22, 25 | 7/8, 1 | 1 7/16-12UN | 20.5 | 44.5 | 47.0 | 8.0 | 32.0 | 41.0 | 0.39 | 16LVQ1 | 16LOVQ1 | 350 |
| 1 1/4 | 32 | 28, 30, 32 | 1 1/4 | 1 11/16-12UN | 26.0 | 50.8 | 61.0 | 8.0 | 32.8 | 47.5 | 0.45 | 20LVQ1 | 20LOVQ1 | 280 |
| 1 1/2 | 38 | 35, 38 | 1 1/2 | 2-12UN | 32.0 | 60.3 | 73.7 | 8.0 | 36.8 | 63.5 | 0.57 | 24LVQ1 | 24LOVQ1 | 210 |

6000 PSI Series

| | | | | | | | | | | | | | | |
|-------|----|------------|--------|---------------------|------|------|------|------|------|------|------|---------------|----------------|-----|
| 3/4 | 19 | 18, 20 | 3/4 | 1 3/16-12UN | 15.5 | 41.3 | 46.5 | 8.8 | 30.5 | 36.0 | 0.29 | 12LVQ2 | 12LOVQ2 | 420 |
| 1 | 25 | 22, 25 | 7/8, 1 | 1 7/16-12UN | 20.5 | 47.6 | 52.6 | 9.5 | 32.0 | 41.0 | 0.39 | 16LVQ2 | 16LOVQ2 | 420 |
| 1 1/4 | 32 | 28, 30, 32 | 1 1/4 | 1 11/16-12UN | 26.0 | 54.0 | 61.0 | 10.3 | 32.8 | 47.5 | 0.45 | 20LVQ2 | 20LOVQ2 | 345 |
| 1 1/2 | 38 | 35, 38 | 1 1/2 | 2-12UN | 32.0 | 63.5 | 73.7 | 12.6 | 36.8 | 63.5 | 0.57 | 24LVQ2 | 24LOVQ2 | 310 |

1) Pressure shown = Item deliverable

$$\frac{PN \text{ (bar)}}{10} = PN \text{ (MPa)}$$

Stainless steel on request.

See pages N16 and N19 for related flange halves depending on bolt sets.

Stainless steel parts may have dimensional deviations. Additional information on request.

 *Please add the **suffixes** below according to the material/surface required.

| Order code suffixes | | | | |
|---------------------|-----------------------------|---|---|---|
| Material | Suffix surface and material | Example only flange adapter without ORFS O-ring | Example only flange adapter incl. ORFS O-ring | Standard sealing material (no additional suffix needed) |
| Steel, oiled | S | 12LVQ1-S | 12LOVQ1-S | NBR |



XHQ SAE Straight flange adapter

SAE Flange / Triple-Lok® 37° flare end
(ISO 6162-1/-2)

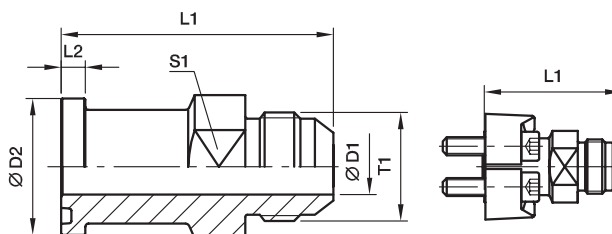

3000 PSI Series

| Nom. flange size | | Tube | | T1 | D1 | D2 | L1 | L2 | S1 | Weight (steel) kg/piece | Order code* | PN (bar) ¹⁾ |
|------------------|----------|------------|--------|--------------------|------|------|-------|-----|------|-------------------------|---------------|------------------------|
| SAE (in.) | ISO (DN) | (metr.) | (in.) | | | | | | | | | S |
| 3/4 | 19 | 18, 20 | 3/4 | 1 1/16-12UN | 15.5 | 38.1 | 70.4 | 6.7 | 35.0 | 0.21 | 12XHQ1 | 350 |
| 1 | 25 | 22, 25 | 7/8, 1 | 1 5/16-12UN | 21.5 | 44.5 | 73.9 | 8.0 | 41.0 | 0.30 | 16XHQ1 | 350 |
| 1 1/4 | 32 | 28, 30, 32 | 1 1/4 | 1 5/8-12UN | 27.5 | 50.8 | 85.3 | 8.0 | 47.5 | 0.31 | 20XHQ1 | 275 |
| 1 1/2 | 38 | 35, 38 | 1 1/2 | 1 7/8-12UN | 33.5 | 60.3 | 90.7 | 8.0 | 54.0 | 0.56 | 24XHQ1 | 210 |
| 2 | 51 | 50 | 2 | 2 1/2-12UN | 45.0 | 71.4 | 102.6 | 9.5 | 66.5 | 1.10 | 32XHQ1 | 138 |

6000 PSI Series

| | | | | | | | | | | | | |
|-------|----|------------|--------|--------------------|------|------|-------|------|------|------|---------------|-----|
| 3/4 | 19 | 18, 20 | 3/4 | 1 1/16-12UN | 15.5 | 41.3 | 78.2 | 8.8 | 35.0 | 0.21 | 12XHQ2 | 350 |
| 1 | 25 | 22, 25 | 7/8, 1 | 1 5/16-12UN | 21.5 | 47.6 | 87.1 | 9.5 | 41.0 | 0.30 | 16XHQ2 | 350 |
| 1 1/4 | 32 | 28, 30, 32 | 1 1/4 | 1 5/8-12UN | 27.5 | 54.0 | 91.4 | 10.3 | 47.5 | 0.31 | 20XHQ2 | 275 |
| 1 1/2 | 38 | 35, 38 | 1 1/2 | 1 7/8-12UN | 33.5 | 63.5 | 110.2 | 12.6 | 54.0 | 0.56 | 24XHQ2 | 210 |

¹⁾Pressure shown = Item deliverable

$\frac{PN \text{ (bar)}}{10} = PN \text{ (MPa)}$

Stainless steel on request.

See pages N16 and N19 for related flange halves depending on bolt sets.

N

*Please add the **suffixes** below according to the material/surface required.

| Material | Order code suffixes | | |
|--------------|-----------------------------|-----------------------------|---|
| | Suffix surface and material | Example only flange adapter | Standard sealing material (no additional suffix needed) |
| Steel, oiled | S | 12XHQ1-S | NBR |



SAE Flange adapters

XEMQ SAE 90° Elbow flange adapter

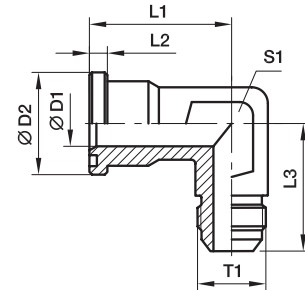
 SAE Flange / Triple-Lok® 37° flare end
 (ISO 6162-1/-2)

3000 PSI Series

| Nom. flange size | | Tube | | T1 | D1 | D2 | L1 | L2 | L3 | S1 | Weight (steel) kg/piece | Order code* | PN (bar) ¹⁾ | |
|------------------|----------|------------|-------|--------------------|----|------|----|-----|----|----|-------------------------|-------------------|------------------------|-----|
| SAE (in.) | ISO (DN) | (metr.) | (in.) | | | | | | | | | | S | SS |
| 1/2 | 13 | 12 | 1/2 | 3/4-16UNF | 10 | 30.2 | 44 | 6.7 | 50 | 22 | 0.20 | 8XEMQ1 | 350 | 350 |
| 1/2 | 13 | 14, 15, 16 | 5/8 | 7/8-14UNF | 12 | 30.2 | 44 | 6.7 | 50 | 22 | 0.20 | 10-8XEMQ1 | 350 | 350 |
| 3/4 | 19 | 14, 15, 16 | 5/8 | 7/8-14UNF | 19 | 38.1 | 53 | 6.7 | 64 | 27 | 0.29 | 10-12XEMQ1 | 350 | 350 |
| 3/4 | 19 | 18, 20 | 3/4 | 1 1/16-12UN | 19 | 38.1 | 53 | 6.7 | 64 | 27 | 0.29 | 12XEMQ1 | 350 | 350 |
| 3/4 | 19 | 25 | 1 | 1 5/16-12UN | 19 | 38.1 | 53 | 6.7 | 64 | 27 | 0.29 | 16-12XEMQ1 | 350 | 350 |
| 1 | 25 | 18, 20 | 3/4 | 1 1/16-12UN | 22 | 44.4 | 60 | 8.0 | 65 | 34 | 0.39 | 12-16XEMQ1 | 350 | 350 |
| 1 | 25 | 25 | 1 | 1 5/16-12UN | 22 | 44.4 | 60 | 8.0 | 65 | 34 | 0.39 | 16XEMQ1 | 350 | 350 |
| 1 | 25 | 30, 32 | 1 1/4 | 1 5/8-12UN | 22 | 44.4 | 60 | 8.0 | 65 | 34 | 0.39 | 20-16XEMQ1 | 275 | 275 |
| 1 1/4 | 32 | 25 | 1 | 1 5/16-12UN | 28 | 50.8 | 55 | 8.0 | 64 | 42 | 0.45 | 16-20XEMQ1 | 275 | 275 |
| 1 1/4 | 32 | 30, 32 | 1 1/4 | 1 5/8-12UN | 28 | 50.8 | 55 | 8.0 | 64 | 42 | 0.45 | 20XEMQ1 | 275 | 275 |
| 1 1/2 | 38 | 30, 32 | 1 1/4 | 1 5/8-12UN | 38 | 60.3 | 66 | 8.0 | 78 | 50 | 0.57 | 20-24XEMQ1 | 210 | 210 |
| 1 1/2 | 38 | 38 | 1 1/2 | 1 7/8-12UN | 38 | 60.3 | 66 | 8.0 | 78 | 50 | 0.57 | 24XEMQ1 | 210 | 210 |

6000 PSI Series

| | | | | | | | | | | | | | | |
|-------|----|------------|-------|--------------------|----|------|----|------|----|----|------|-------------------|-----|-----|
| 1/2 | 13 | 12 | 1/2 | 3/4-16UNF | 12 | 31.8 | 44 | 7.7 | 50 | 22 | 0.20 | 8XEMQ2 | 350 | 350 |
| 1/2 | 13 | 14, 15, 16 | 5/8 | 7/8-14UNF | 12 | 31.8 | 44 | 7.7 | 50 | 22 | 0.20 | 10-8XEMQ2 | 350 | 350 |
| 3/4 | 19 | 14, 15, 16 | 5/8 | 7/8-14UNF | 18 | 41.3 | 53 | 8.7 | 64 | 27 | 0.29 | 10-12XEMQ2 | 350 | 350 |
| 3/4 | 19 | 18, 20 | 3/4 | 1 1/16-12UN | 18 | 41.3 | 53 | 8.7 | 64 | 27 | 0.29 | 12XEMQ2 | 350 | 350 |
| 3/4 | 19 | 25 | 1 | 1 5/16-12UN | 18 | 41.3 | 53 | 8.7 | 64 | 27 | 0.29 | 16-12XEMQ2 | 350 | 350 |
| 1 | 25 | 18, 20 | 3/4 | 1 1/16-12UN | 22 | 47.6 | 60 | 9.5 | 62 | 34 | 0.39 | 12-16XEMQ2 | 350 | 350 |
| 1 | 25 | 25 | 1 | 1 5/16-12UN | 22 | 47.6 | 60 | 9.5 | 62 | 34 | 0.39 | 16XEMQ2 | 350 | 350 |
| 1 | 25 | 30, 32 | 1 1/4 | 1 5/8-12UN | 22 | 47.6 | 60 | 9.5 | 62 | 34 | 0.39 | 20-16XEMQ2 | 275 | 275 |
| 1 1/4 | 32 | 25 | 1 | 1 5/16-12UN | 27 | 54.0 | 70 | 10.3 | 70 | 42 | 0.45 | 16-20XEMQ2 | 350 | 350 |
| 1 1/4 | 32 | 30, 32 | 1 1/4 | 1 5/8-12UN | 27 | 54.0 | 70 | 10.3 | 72 | 42 | 0.45 | 20XEMQ2 | 275 | 275 |
| 1 1/2 | 38 | 30, 32 | 1 1/4 | 1 5/8-12UN | 32 | 63.5 | 80 | 12.5 | 87 | 50 | 0.57 | 20-24XEMQ2 | 275 | 275 |
| 1 1/2 | 38 | 38 | 1 1/2 | 1 7/8-12UN | 32 | 63.5 | 80 | 12.5 | 87 | 50 | 0.57 | 24XEMQ2 | 210 | 210 |

¹⁾Pressure shown = Item deliverable

$$\frac{\text{PN (bar)}}{10} = \text{PN (MPa)}$$

See pages N16 and N19 for related flange halves depending on bolt sets.

Stainless steel parts may have dimensional deviations. Additional information on request.

*Please add the suffixes below according to the material/surface required.

| Order code suffixes | | | |
|---------------------------------|-----------------------------|-----------------------------|---|
| Material | Suffix surface and material | Example only flange adapter | Standard sealing material (no additional suffix needed) |
| Steel, zinc plated, Cr(VI)-free | CF | 8XEMQ1CF | NBR |
| Stainless steel | SS | 8XEMQ1SS | VIT |



XVQ SAE 45° Elbow flange adapter

SAE Flange / Triple-Lok® 37° flare end
(ISO 6162-1/-2)

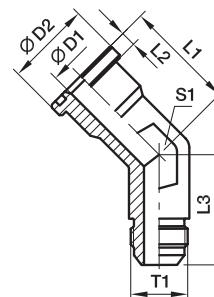

3000 PSI Series

| Nom. flange size | | Tube | | T1 | D1 | D2 | L1 | L2 | L3 | S1 | Weight (steel) kg/piece | Order code* | PN (bar) ¹⁾ |
|------------------|----------|------------|--------|--------------------|------|------|------|-----|------|------|-------------------------|---------------|------------------------|
| SAE (in.) | ISO (DN) | (metr.) | (in.) | | | | | | | | | | S |
| 3/4 | 19 | 18, 20 | 3/4 | 1 1/16-12UN | 15.5 | 38.1 | 40.1 | 6.7 | 32.3 | 36.0 | 0.29 | 12XVQ1 | 350 |
| 1 | 25 | 22, 25 | 7/8, 1 | 1 5/16-12UN | 21.4 | 44.5 | 47.0 | 8.0 | 37.3 | 41.0 | 0.39 | 16XVQ1 | 350 |
| 1 1/4 | 32 | 28, 30, 32 | 1 1/4 | 1 5/8-12UN | 27.4 | 50.8 | 61.0 | 8.0 | 40.4 | 47.5 | 0.45 | 20XVQ1 | 275 |
| 1 1/2 | 38 | 35, 38 | 1 1/2 | 1 7/8-12UN | 33.3 | 60.3 | 73.7 | 8.0 | 45.2 | 63.5 | 0.57 | 24XVQ1 | 210 |
| 2 | 51 | 50 | 2 | 2 1/2-12UN | 45.2 | 71.4 | 76.2 | 9.5 | 56.4 | 73.0 | 1.15 | 32XVQ1 | 138 |

6000 PSI Series

| | | | | | | | | | | | | | |
|-------|----|------------|--------|--------------------|------|------|------|------|------|------|------|---------------|-----|
| 3/4 | 19 | 18, 20 | 3/4 | 1 1/16-12UN | 15.5 | 41.3 | 46.5 | 8.8 | 32.3 | 36.0 | 0.42 | 12XVQ2 | 350 |
| 1 | 25 | 22, 25 | 7/8, 1 | 1 5/16-12UN | 21.4 | 47.6 | 52.6 | 9.5 | 37.3 | 41.0 | 0.52 | 16XVQ2 | 350 |
| 1 1/4 | 32 | 28, 30, 32 | 1 1/4 | 1 5/8-12UN | 27.4 | 54.0 | 61.0 | 10.3 | 40.4 | 47.5 | 0.56 | 20XVQ2 | 275 |
| 1 1/2 | 38 | 35, 38 | 1 1/2 | 1 7/8-12UN | 33.3 | 63.5 | 73.7 | 12.6 | 45.2 | 63.5 | 0.69 | 24XVQ2 | 210 |

¹⁾Pressure shown = Item deliverable

$\frac{PN \text{ (bar)}}{10} = PN \text{ (MPa)}$

Stainless steel on request.

See pages N16 and N19 for related flange halves depending on bolt sets.

N

*Please add the **suffixes** below according to the material/surface required.

| Material | Order code suffixes | | |
|--------------|-----------------------------|-----------------------------|---|
| | Suffix surface and material | Example only flange adapter | Standard sealing material (no additional suffix needed) |
| Steel, oiled | S | 12XVQ1-S | NBR |



SAE Flange adapters

ASR SAE Straight flange adapter

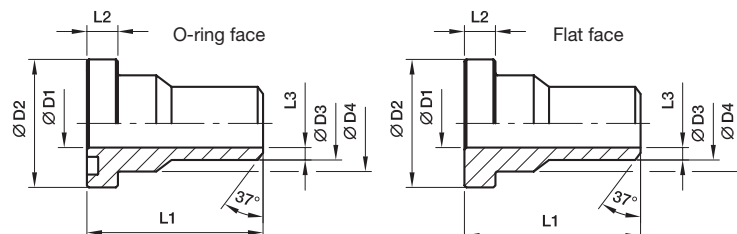
 SAE Flange / Butt weld reducer tube end
 (ISO 6162-1/-2)

3000 PSI Series

| Nom. flange size | | Tube | D1 | D2 | D3 | D4 | L1 | L2 | L3 | Weight (steel) kg/piece | O-ring face | Flat face | PN (bar) ¹⁾ | |
|------------------|----------|---------|----|-------|-------|-------|-----|------|------|-------------------------|---------------|----------------|------------------------|-----|
| SAE (in.) | ISO (DN) | | | | | | | | | | Order code* | Order code* | S | SS |
| 1/2 | 13 | 18x4.5 | 10 | 30.2 | 18.0 | 24.0 | 45 | 6.7 | 4.0 | 0.12 | ASR32/18X4.5 | ASRG32/18X4.5 | 345 | 345 |
| 3/4 | 19 | 22x4.5 | 13 | 38.1 | 22.0 | 31.5 | 50 | 6.7 | 4.5 | 0.18 | ASR33/22X4.5 | ASRG33/22X4.5 | 345 | 345 |
| 1 | 25 | 28x4.5 | 19 | 44.4 | 28.0 | 38.0 | 55 | 8.0 | 4.5 | 0.26 | ASR34/28X4.5 | ASRG34/28X4.5 | 345 | 345 |
| 1 1/4 | 32 | 35x5.0 | 25 | 50.8 | 35.0 | 43.0 | 60 | 8.0 | 5.0 | 0.31 | ASR35/35X5 | ASRG35/35X5 | 276 | 276 |
| 1 1/2 | 38 | 43x6.0 | 31 | 60.3 | 43.0 | 50.0 | 65 | 8.0 | 6.0 | 0.51 | ASR36/43X6 | ASRG36/43X6 | 207 | 207 |
| 2 | 51 | 50x6.0 | 38 | 71.4 | 50.0 | 62.0 | 70 | 9.5 | 6.0 | 0.80 | ASR38/50X6 | ASRG38/50X6 | 207 | 207 |
| 2 1/2 | 64 | 62x7.5 | 47 | 84.1 | 62.0 | 74.0 | 75 | 9.5 | 7.5 | 1.24 | ASR310/62X7.5 | ASRG310/62X7.5 | 172 | 172 |
| 3 | 76 | 76x9.0 | 58 | 101.6 | 76.0 | 90.0 | 85 | 9.5 | 9.0 | 1.95 | ASR312/76X9 | ASRG312/76X9 | 138 | 138 |
| 3 1/2 | 89 | 90x10.0 | 70 | 114.3 | 90.0 | 102.0 | 90 | 11.2 | 10.0 | 2.15 | ASR314/90X10 | ASRG314/90X10 | 34 | 34 |
| 4 | 102 | 102x7.0 | 88 | 127.0 | 102.0 | 114.0 | 100 | 11.2 | 7.0 | 2.62 | ASR316/102X7 | ASRG316/102X7 | 34 | 34 |

6000 PSI Series

| | | | | | | | | | | | | | | |
|-------|----|--------|----|------|------|------|----|------|-----|------|--------------|---------------|-----|-----|
| 1/2 | 13 | 18x4.0 | 10 | 31.8 | 18.0 | 24.0 | 45 | 7.7 | 4.0 | 0.12 | ASR62/18X4 | ASRG62/18X4 | 420 | 420 |
| 3/4 | 19 | 22x4.5 | 13 | 41.3 | 22.0 | 32.0 | 50 | 8.7 | 4.5 | 0.20 | ASR63/22X4.5 | ASRG63/22X4.5 | 420 | 420 |
| 1 | 25 | 28x5.0 | 18 | 47.6 | 28.0 | 38.0 | 55 | 9.5 | 5.0 | 0.31 | ASR64/28X5 | ASRG64/28X5 | 420 | 420 |
| 1 1/4 | 32 | 35x6.5 | 22 | 54.0 | 35.0 | 44.0 | 60 | 10.3 | 6.5 | 0.46 | ASR65/35X6.5 | ASRG65/35X6.5 | 420 | 420 |
| 1 1/2 | 38 | 44x7.5 | 29 | 63.5 | 44.0 | 51.0 | 65 | 12.5 | 7.5 | 0.69 | ASR66/44X7.5 | ASRG66/44X7.5 | 420 | 420 |
| 2 | 51 | 51x8.0 | 35 | 79.4 | 51.0 | 67.0 | 70 | 12.5 | 8.0 | 1.24 | ASR68/51X8 | ASRG68/51X8 | 420 | 420 |

¹⁾ Pressure shown = Item deliverable

$$\frac{\text{PN (bar)}}{10} = \text{PN (MPa)}$$

The pressures given here are the maximum allowable for the flange fittings. If the pipe or tube used has a lower pressure rating, then the welded assembly rating will be the lower one, assuming the weld is adequately strong.

See pages N16 - N20 for related flanges or flange halves depending on bolt sets.

Stainless steel parts may have dimensional deviations. Additional information on request.

*Please add the suffixes below according to the material/surface required.

| Order code suffixes | | | | | |
|---------------------|-----------------------------|-----------------------------|--|--|---|
| Material | Suffix surface and material | Example only flange adapter | Example incl. splitflanges, metr. bolts and O-ring | Example incl. splitflanges, UNC bolts and O-ring | Standard sealing material (no additional suffix needed) |
| Steel, oil dipped | S | ASR32/18X4.5S | ASR32/18X4.5SM | ASR32/18X4.5SU | NBR |
| Stainless steel | SS | ASR32/18X4.5SS | ASR32/18X4.5SSM | - | VIT |



AS SAE Straight flange adapter

SAE Flange / Butt weld tube end
(ISO 6162-1/-2)

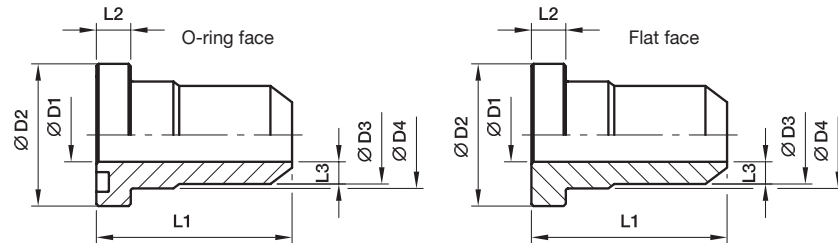

3000 PSI Series

| Nom. flange size | | Tube | D1 | D2 | D3 | D4 | L1 | L2 | L3 | Weight (steel) kg/piece | O-ring face | Flat face | PN (bar) ¹⁾ | |
|------------------|----------|------------|-----|-------|-----|-------|-----|------|------|-------------------------|---------------|----------------|------------------------|-----|
| SAE (in.) | ISO (DN) | | | | | | | | | | Order code* | Order code* | S | SS |
| 1/2 | 13 | 15x2.0 | 11 | 30.2 | 15 | 23.9 | 45 | 6.8 | 2.0 | 0.09 | AS32/15X2 | ASG32/15X2 | 345 | 345 |
| 1/2 | 13 | 16x3.0 | 10 | 30.2 | 16 | 23.9 | 45 | 6.8 | 3.0 | 0.10 | AS32/16X3 | ASG32/16X3 | 345 | 345 |
| 1/2 | 13 | 21.3x2.6 | 13 | 30.2 | 22 | 23.9 | 45 | 6.8 | 4.5 | 0.12 | AS32/21.3X2.6 | ASG32/21.3X2.6 | 345 | 345 |
| 3/4 | 19 | 18x1.5 | 15 | 38.1 | 18 | 31.5 | 50 | 6.8 | 1.5 | 0.14 | AS33/18X1.5 | ASG33/18X1.5 | 345 | 345 |
| 3/4 | 19 | 22x2.0 | 18 | 38.1 | 22 | 31.5 | 50 | 6.8 | 2.0 | 0.12 | AS33/22X2 | ASG33/22X2 | 345 | 345 |
| 3/4 | 19 | 20x3.0 | 14 | 38.1 | 20 | 31.5 | 50 | 6.8 | 3.0 | 0.14 | AS33/20X3 | ASG33/20X3 | 345 | 345 |
| 3/4 | 19 | 25x4.0 | 17 | 38.1 | 25 | 31.5 | 50 | 6.8 | 4.0 | 0.17 | AS33/25X4 | ASG33/25X4 | 345 | 345 |
| 3/4 | 19 | 26.9x2.6 | 19 | 38.1 | 28 | 31.5 | 50 | 6.8 | 4.5 | 0.18 | AS33/26.9X2.6 | ASG33/26.9X2.6 | 345 | 345 |
| 1 | 25 | 20x2.5 | 15 | 44.5 | 20 | 38.0 | 55 | 8.0 | 2.5 | 0.26 | AS34/20X2.5 | ASG34/20X2.5 | 345 | 345 |
| 1 | 25 | 28x2.0 | 24 | 44.5 | 28 | 38.0 | 55 | 8.0 | 2.0 | 0.19 | AS34/28X2 | ASG34/28X2 | 345 | 345 |
| 1 | 25 | 30x4.5 | 21 | 44.5 | 30 | 38.0 | 55 | 8.0 | 4.5 | 0.26 | AS34/30X4.5 | ASG34/30X4.5 | 345 | 345 |
| 1 | 25 | 33.7x4.0 | 25 | 44.4 | 35 | 38.0 | 55 | 8.0 | 5.0 | 0.26 | AS34/33.7X4 | ASG34/33.7X4 | 345 | 345 |
| 1 1/4 | 32 | 35x2.0 | 31 | 50.8 | 35 | 43.0 | 60 | 8.0 | 2.0 | 0.31 | AS35/35X2 | ASG35/35X2 | 276 | 276 |
| 1 1/4 | 32 | 25x3.0 | 19 | 50.8 | 25 | 43.0 | 60 | 8.0 | 3.0 | 0.45 | AS35/25X3 | ASG35/25X3 | 276 | 276 |
| 1 1/4 | 32 | 30x4.0 | 22 | 50.8 | 30 | 43.0 | 60 | 8.0 | 4.0 | 0.45 | AS35/30X4 | ASG35/30X4 | 276 | 276 |
| 1 1/4 | 32 | 38x5.0 | 28 | 50.8 | 38 | 43.0 | 60 | 8.0 | 5.0 | 0.40 | AS35/38X5 | ASG35/38X5 | 276 | 276 |
| 1 1/4 | 32 | 42.4x6.0 | 31 | 50.8 | 43 | 43.0 | 60 | 8.0 | 6.0 | 0.34 | AS35/42.4X5 | ASG35/42.4X5 | 276 | 276 |
| 1 1/2 | 38 | 42x3.0 | 36 | 60.3 | 42 | 50.0 | 65 | 8.0 | 3.0 | 0.47 | AS36/42X3 | ASG36/42X3 | 207 | 207 |
| 1 1/2 | 38 | 38x4.0 | 30 | 60.3 | 38 | 50.0 | 65 | 8.0 | 4.0 | 0.57 | AS36/38X4 | ASG36/38X4 | 207 | 207 |
| 1 1/2 | 38 | 48.3x6.0 | 38 | 60.3 | 50 | 50.0 | 65 | 8.0 | 6.0 | 0.48 | AS36/48.3X6 | ASG36/48.3X6 | 207 | 207 |
| 2 | 51 | 50x6.0 | 38 | 71.4 | 50 | 62.0 | 70 | 9.5 | 6.0 | 0.96 | AS38/50X6 | ASG38/50X6 | 207 | 207 |
| 2 | 51 | 65x8.0 | 49 | 71.4 | 65 | 62.0 | 70 | 9.5 | 8.0 | 0.64 | AS38/65X8 | ASG38/65X8 | 207 | 207 |
| 2 | 51 | 60.3x7.5 | 47 | 71.4 | 62 | 62.0 | 70 | 9.5 | 7.5 | 0.78 | AS38/62X7.5 | ASG38/62X7.5 | 207 | 207 |
| 2 1/2 | 64 | 76.1x5.5 | 63 | 84.1 | 74 | 74.0 | 75 | 9.5 | 5.5 | 0.80 | AS310/74X5.5 | ASG310/74X5.5 | 172 | 172 |
| 3 | 76 | 88.9x10.0 | 70 | 101.6 | 90 | 90.0 | 85 | 9.5 | 10.0 | 1.78 | AS312/90X10 | ASG312/90X10 | 138 | 138 |
| 3 1/2 | 89 | 101.6x7.0 | 88 | 114.3 | 102 | 102.0 | 90 | 11.2 | 7.0 | 1.65 | AS314/102X7 | ASG314/102X7 | 34 | 34 |
| 4 | 102 | 114x8.0 | 98 | 127.0 | 114 | 114.0 | 100 | 11.2 | 8.0 | 2.34 | AS316/115X8.5 | ASG316/115X8.5 | 34 | 34 |
| 5 | 127 | 139.7x10.0 | 120 | 152.4 | 140 | 140.0 | 100 | 11.2 | 10.0 | 3.61 | AS320/140X10 | ASG320/140X10 | 34 | 34 |

¹⁾ Pressure shown = Item deliverable

$$\frac{\text{PN (bar)}}{10} = \text{PN (MPa)}$$

The pressures given here are the maximum allowable for the flange fittings. If the pipe or tube used has a lower pressure rating, then the welded assembly rating will be the lower one, assuming the weld is adequately strong.

See pages N16 - N20 for related flanges or flange halves depending on bolt sets.

Stainless steel parts may have dimensional deviations. Additional information on request.

*Please add the suffixes below according to the material/surface required.

| Order code suffixes | | | | | |
|---------------------|-----------------------------|-----------------------------|--|--|---|
| Material | Suffix surface and material | Example only flange adapter | Example incl. splitflanges, metr. bolts and O-ring | Example incl. splitflanges, UNC bolts and O-ring | Standard sealing material (no additional suffix needed) |
| Steel, oil dipped | S | AS32/15X2S | AS32/15X2SM | AS32/15X2SU | NBR |
| Stainless steel | SS | AS32/15X2SS | AS32/15X2SSM | - | VIT |



SAE Flange adapters

AS SAE Straight flange adapter

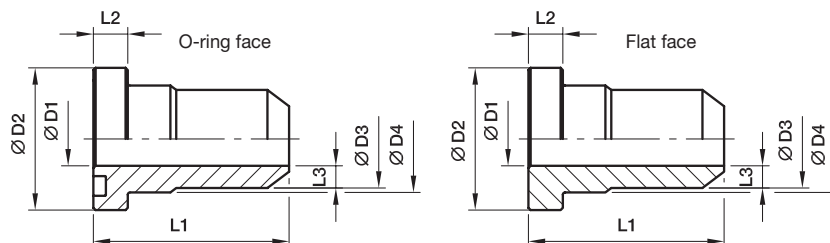
 SAE Flange / Butt weld tube end
 (ISO 6162-1/-2)

6000 PSI Series

| Nom. flange size | | Tube | D1 | D2 | D3 | D4 | L1 | L2 | L3 | Weight (steel) kg/piece | O-ring face Order code* | Flat face Order code* | PN (bar) ¹⁾ | |
|------------------|----------|-----------|----|-------|----|-------|-----|------|------|-------------------------|-------------------------|-----------------------|------------------------|-----|
| SAE (in.) | ISO (DN) | | | | | | | | | | | | S | SS |
| 1/2 | 13 | 16×3.0 | 10 | 31.8 | 16 | 24.0 | 45 | 7.8 | 3.0 | 0.12 | AS62/16X3 | ASG62/16X3 | 420 | 420 |
| 1/2 | 13 | 21.3×3.2 | 13 | 31.8 | 22 | 24.0 | 45 | 7.8 | 4.5 | 0.12 | AS62/21.3X3.2 | ASG62/21.3X3.2 | 420 | 420 |
| 3/4 | 19 | 16×3.0 | 10 | 41.3 | 16 | 31.8 | 50 | 8.8 | 3.0 | 0.20 | AS63/16X3 | ASG63/16X3 | 420 | 420 |
| 3/4 | 19 | 20×4.0 | 12 | 41.3 | 20 | 31.8 | 50 | 8.8 | 4.0 | 0.19 | AS63/20X4 | ASG63/20X4 | 420 | 420 |
| 3/4 | 19 | 26.9×4.0 | 18 | 41.3 | 28 | 32.0 | 50 | 8.8 | 5.0 | 0.21 | AS63/26.9X4 | ASG63/26.9X4 | 420 | 420 |
| 3/4 | 19 | 25×5.0 | 15 | 41.3 | 25 | 31.8 | 50 | 8.8 | 5.0 | 0.21 | AS63/25X5 | ASG63/25X5 | 420 | 420 |
| 1 | 25 | 25×5.0 | 15 | 47.6 | 25 | 38.0 | 55 | 9.5 | 5.0 | 0.30 | AS64/25X5 | ASG64/25X5 | 420 | 420 |
| 1 | 25 | 30×4.0 | 22 | 47.6 | 30 | 38.0 | 55 | 9.5 | 4.0 | 0.27 | AS64/30X4 | ASG64/30X4 | 420 | 420 |
| 1 | 25 | 30×6.0 | 18 | 47.3 | 30 | 38.0 | 67 | 9.5 | 6.0 | 0.33 | AS64/30X6 | ASG64/30X6 | 420 | 420 |
| 1 | 25 | 33.7×6.3 | 22 | 47.6 | 35 | 38.0 | 55 | 9.5 | 6.5 | 0.32 | AS64/33.7X6.3 | ASG64/33.7X6.3 | 420 | 420 |
| 1 1/4 | 32 | 30×4.0 | 22 | 54.0 | 30 | 44.0 | 60 | 10.3 | 4.0 | 0.48 | AS65/30X4 | ASG65/30X4 | 420 | 420 |
| 1 1/4 | 32 | 30×6.0 | 18 | 54.0 | 30 | 44.0 | 60 | 10.3 | 6.0 | 0.54 | AS65/30X6 | ASG65/30X6 | 420 | 420 |
| 1 1/4 | 32 | 38×5.0 | 28 | 54.0 | 38 | 44.0 | 60 | 10.3 | 5.0 | 0.45 | AS65/38X5 | ASG65/38X5 | 420 | 420 |
| 1 1/4 | 32 | 38×8.0 | 22 | 54.0 | 38 | 44.0 | 60 | 10.3 | 8.0 | 0.54 | AS65/38X8 | ASG65/38X8 | 420 | 420 |
| 1 1/4 | 32 | 42.4×6.3 | 29 | 54.0 | 44 | 44.0 | 60 | 10.3 | 7.5 | 0.48 | AS65/42.4X6.3 | ASG65/42.4X6.3 | 420 | 420 |
| 1 1/2 | 38 | 38×5.0 | 28 | 63.5 | 38 | 50.8 | 65 | 12.5 | 5.0 | 0.72 | AS66/38X5 | ASG66/38X5 | 420 | 420 |
| 1 1/2 | 38 | 38×8.0 | 22 | 63.5 | 38 | 50.8 | 65 | 12.5 | 8.0 | 0.85 | AS66/38X8 | ASG66/38X8 | 420 | 420 |
| 1 1/2 | 38 | 48.3×8.0 | 35 | 63.5 | 51 | 51.0 | 65 | 12.5 | 8.0 | 0.66 | AS66/48.3X8 | ASG66/48.3X8 | 420 | 420 |
| 2 | 51 | 50×9.0 | 32 | 79.4 | 50 | 66.6 | 70 | 12.5 | 9.0 | 1.24 | AS68/50X9 | ASG68/50X9 | 420 | 420 |
| 2 | 51 | 65×8.0 | 49 | 79.4 | 65 | 66.6 | 70 | 12.5 | 8.0 | 0.98 | AS68/65X8 | ASG68/65X8 | 420 | 420 |
| 2 | 51 | 60.3×10.0 | 43 | 79.4 | 61 | 67.0 | 70 | 12.5 | 9.0 | 1.12 | AS68/60.3X10 | ASG68/60.3X10 | 420 | 420 |
| 2 1/2 | 64 | 73×14.0 | 45 | 107.8 | 74 | 88.9 | 90 | 20.6 | 14.5 | 3.38 | AS610/73X14 | ASG610/73X14 | 420 | 420 |
| 3 | 76 | 88.6×16.0 | 58 | 131.7 | 90 | 113.8 | 110 | 25.6 | 16.0 | 6.70 | AS612/88.6X16 | ASG612/88.6X16 | 420 | 420 |

¹⁾Pressure shown = Item deliverable

$$\frac{\text{PN (bar)}}{10} = \text{PN (MPa)}$$

The pressures given here are the maximum allowable for the flange fittings. If the pipe or tube used has a lower pressure rating, then the welded assembly rating will be the lower one, assuming the weld is adequately strong.

See pages N16 - N20 for related flanges or flange halves depending on bolt sets.

Stainless steel parts may have dimensional deviations. Additional information on request.

*Please add the suffixes below according to the material/surface required.

| Order code suffixes | | | | | |
|---------------------|-----------------------------|-----------------------------|--|--|---|
| Material | Suffix surface and material | Example only flange adapter | Example incl. splitflanges, metr. bolts and O-ring | Example incl. splitflanges, UNC bolts and O-ring | Standard sealing material (no additional suffix needed) |
| Steel, oil dipped | S | AS62/16X3S | AS62/16X3SM | AS62/16X3SU | NBR |
| Stainless steel | SS | AS62/16X3SS | AS62/16X3SSM | - | VIT |



ASL SAE Straight flange adapter

SAE Flange / Butt weld tube end
(ISO 6162-1/-2)

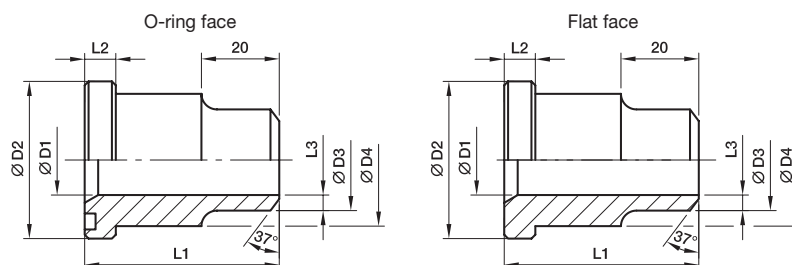

3000 PSI Series

| Nom. flange size | | Tube | D1 | D2 | D3 | D4 | L1 | L2 | L3 | Weight (steel) kg/piece | O-ring face Order code* | Flat face Order code* | PN (bar) ¹⁾ | |
|------------------|----------|---------|-----|-------|-----|-------|----|------|-----|-------------------------|-------------------------|-----------------------|------------------------|-----|
| SAE (in.) | ISO (DN) | | | | | | | | | | | | S | SS |
| 1/2 | 13 | 16x2.0 | 12 | 30.2 | 16 | 23.9 | 41 | 6.7 | 2.5 | 0.26 | ASL32/16X2 | ASLG32/16X2 | 210 | 210 |
| 3/4 | 19 | 25x3.0 | 19 | 38.1 | 25 | 31.7 | 50 | 6.7 | 3.0 | 0.45 | ASL33/25X3 | ASLG33/25X3 | 210 | 210 |
| 1 | 25 | 30x4.0 | 22 | 44.4 | 30 | 38.0 | 50 | 8.0 | 4.0 | 0.25 | ASL34/30X4 | ASLG34/30X4 | 210 | 210 |
| 1 1/4 | 32 | 38x5.0 | 28 | 50.8 | 38 | 43.0 | 55 | 8.0 | 5.0 | 0.36 | ASL35/38X5 | ASLG35/38X5 | 210 | 210 |
| 1 1/2 | 38 | 45x5.0 | 35 | 60.3 | 45 | 50.0 | 57 | 8.0 | 5.0 | 0.45 | ASL36/45X5 | ASLG36/45X5 | 210 | 210 |
| 2 | 51 | 60x7.0 | 45 | 71.4 | 60 | 62.0 | 57 | 9.5 | 7.5 | 0.65 | ASL38/60X7 | ASLG38/60X7 | 210 | 210 |
| 2 1/2 | 64 | 70x7.5 | 55 | 84.1 | 70 | 74.0 | 58 | 9.5 | 7.5 | 0.89 | ASL310/70X7.5 | ASLG310/70X7.5 | 175 | 175 |
| 3 | 76 | 80x6.0 | 68 | 101.6 | 80 | 90.0 | 60 | 9.5 | 6.0 | 1.18 | ASL312/80X6 | ASLG312/80X6 | 138 | 138 |
| 3 1/2 | 89 | 100x6.0 | 88 | 114.3 | 100 | 102.0 | 60 | 11.2 | 6.0 | 1.10 | ASL314/100X6 | ASLG314/100X6 | 35 | 35 |
| 4 | 102 | 110x6.0 | 98 | 127.0 | 110 | 114.0 | 60 | 11.2 | 6.0 | 1.43 | ASL316/110X6 | ASLG316/110X6 | 35 | 35 |
| 5 | 127 | 133x6.5 | 120 | 152.4 | 133 | 140.0 | 60 | 11.2 | 6.5 | 2.22 | ASL320/133X6.5 | ASLG320/133X6.5 | 35 | 35 |

6000 PSI Series

| | | | | | | | | | | | | | | |
|-------|----|---------|----|-------|----|-------|-----|------|------|------|----------------|-----------------|-----|-----|
| 1/2 | 13 | 16x2.0 | 12 | 31.8 | 17 | 24.0 | 34 | 7.7 | 2.0 | 0.09 | ASL62/16X2 | ASLG62/16X2 | 420 | 420 |
| 3/4 | 19 | 25x3.5 | 18 | 41.3 | 25 | 32.0 | 38 | 8.7 | 3.5 | 0.16 | ASL63/25X3.5 | ASLG63/25X3.5 | 420 | 420 |
| 1 | 25 | 30x4.0 | 22 | 47.6 | 30 | 38.5 | 40 | 9.5 | 4.0 | 0.22 | ASL64/30X4 | ASLG64/30X4 | 420 | 420 |
| 1 1/4 | 32 | 38x5.5 | 27 | 54.0 | 38 | 44.0 | 45 | 10.3 | 5.5 | 0.35 | ASL65/38X5.5 | ASLG65/38X5.5 | 420 | 420 |
| 1 1/2 | 38 | 45x6.5 | 32 | 63.5 | 45 | 51.0 | 50 | 12.5 | 6.5 | 0.53 | ASL66/45X6.5 | ASLG66/45X6.5 | 420 | 420 |
| 2 | 51 | 60x7.5 | 45 | 79.4 | 60 | 67.0 | 58 | 12.5 | 7.5 | 0.91 | ASL68/60X7.5 | ASLG68/60X7.5 | 420 | 420 |
| 2 1/2 | 64 | 74x14.5 | 45 | 107.8 | 74 | 88.9 | 90 | 20.6 | 14.5 | 3.45 | ASL610/74X14.5 | ASLG610/74X14.5 | 420 | 420 |
| 3 | 76 | 90x16.0 | 58 | 131.7 | 90 | 113.8 | 110 | 25.6 | 16.0 | 9.62 | ASL612/90X16 | ASLG612/90X16 | 420 | 420 |

⁴⁾ Pressure shown = Item deliverable

$$\frac{\text{PN (bar)}}{10} = \text{PN (MPa)}$$

The pressures given here are the maximum allowable for the flange fittings. If the pipe or tube used has a lower pressure rating, then the welded assembly rating will be the lower one, assuming the weld is adequately strong.

See pages N16 - N20 for related flanges or flange halves depending on bolt sets.

Stainless steel parts may have dimensional deviations. Additional information on request.

*Please add the suffixes below according to the material/surface required.

| Order code suffixes | | | | | |
|---------------------|-----------------------------|-----------------------------|--|--|---|
| Material | Suffix surface and material | Example only flange adapter | Example incl. splitflanges, metr. bolts and O-ring | Example incl. splitflanges, UNC bolts and O-ring | Standard sealing material (no additional suffix needed) |
| Steel, oil dipped | S | ASL32/16X2S | ASL32/16X2SM | ASL32/16X2SU | NBR |
| Stainless steel | SS | ASL32/16X2SS | ASL32/16X2SSM | - | VIT |



SAE Flange adapters

WAS SAE 90° Elbow flange adapter

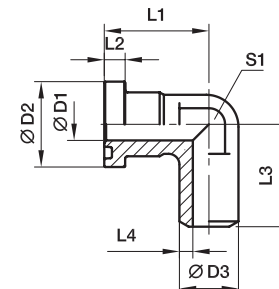
 SAE Flange / Butt weld tube end
 (ISO 6162-1/-2)

3000 PSI Series

| Nom. flange size | | max. | D1 | D2 | D3 | L1 | L2 | L3 | L4 | S1 | Weight (steel) kg/piece | Order code* | PN (bar ¹⁾) | |
|------------------|----------|------|----|------|------|----|-----|----|-----|----|-------------------------|-------------------|-------------------------|-----|
| SAE (in.) | ISO (DN) | | | | | | | | | | | | S | SS |
| 1/2 | 13 | 21.3 | 13 | 30.2 | 21.6 | 44 | 6.7 | 50 | 4.3 | 22 | 0.22 | WAS32/21.6 | 345 | 345 |
| 3/4 | 19 | 26.9 | 19 | 38.1 | 27.2 | 53 | 6.7 | 64 | 4.1 | 27 | 0.35 | WAS33/27.2 | 345 | 345 |
| 1 | 25 | 33.7 | 25 | 44.4 | 34.5 | 60 | 8.0 | 65 | 4.7 | 34 | 0.52 | WAS34/34.5 | 345 | 345 |
| 1 1/4 | 32 | 42.4 | 30 | 50.8 | 42.8 | 55 | 8.0 | 64 | 6.4 | 42 | 0.78 | WAS35/42.8 | 276 | 276 |
| 1 1/2 | 38 | 48.3 | 38 | 60.3 | 48.6 | 66 | 8.0 | 78 | 5.3 | 50 | 1.04 | WAS36/48.6 | 207 | 207 |

6000 PSI Series

| | | | | | | | | | | | | | | |
|-------|----|------|----|------|------|----|------|----|-----|----|------|-------------------|-----|-----|
| 1/2 | 13 | 21.3 | 13 | 31.8 | 21.6 | 44 | 7.7 | 50 | 4.3 | 22 | 0.35 | WAS62/21.6 | 420 | 420 |
| 3/4 | 19 | 26.9 | 18 | 41.3 | 27.2 | 53 | 8.7 | 64 | 4.6 | 27 | 0.41 | WAS63/27.2 | 420 | 420 |
| 1 | 25 | 33.7 | 22 | 47.6 | 34.5 | 60 | 9.5 | 62 | 6.3 | 34 | 0.64 | WAS64/34.5 | 420 | 420 |
| 1 1/4 | 32 | 42.4 | 28 | 54.0 | 42.8 | 70 | 10.3 | 72 | 7.4 | 42 | 1.05 | WAS65/42.8 | 420 | 420 |
| 1 1/2 | 38 | 48.3 | 32 | 63.5 | 48.6 | 80 | 12.5 | 84 | 8.3 | 50 | 1.58 | WAS66/48.6 | 420 | 420 |

¹⁾Pressure shown = Item deliverable

$$\frac{PN \text{ (bar)}}{10} = PN \text{ (MPa)}$$

The pressures given here are the maximum allowable for the flange fittings. If the pipe or tube used has a lower pressure rating, then the welded assembly rating will be the lower one, assuming the weld is adequately strong.

See pages N16 - N20 for related flanges or flange halves depending on bolt sets.

Stainless steel parts may have dimensional deviations. Additional information on request.

 *Please add the **suffixes** below according to the material/surface required.

| Order code suffixes | | | | | |
|---------------------|-----------------------------|-----------------------------|---|---|---|
| Material | Suffix surface and material | Example only flange adapter | Example incl. splitflanges, metr. bolt and O-ring | Example incl. splitflanges, UNC bolt and O-ring | Standard sealing material (no additional suffix needed) |
| Steel, oil dipped | S | WAS32/21.6S | WAS32/21.6SM | WAS32/21.6SU | NBR |
| Stainless steel | SS | WAS32/21.6SS | WAS32/21.6SSM | – | VIT |



ES SAE Straight flange adapter

SAE Flange / Socket weld tube end
(ISO 6162-1/-2)

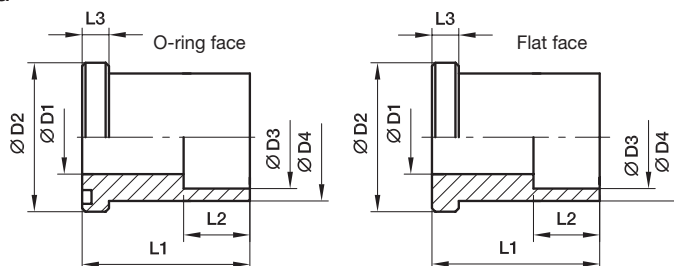

3000 PSI Series

| Nom. flange size | | ⌀ | max. | D1 | D2 | D3 | D4 | L1 | L2 | L3 | Weight (steel) kg/piece | O-ring face Order code* | Flat face Order code* | PN (bar) ¹⁾ | |
|------------------|----------|------|------|-------|------|------|----|----|-----|------|-------------------------|-------------------------|-----------------------|------------------------|----|
| SAE (in.) | ISO (DN) | | | | | | | | | | | | | S | SS |
| 1/2 | 13 | 16.0 | 12.5 | 30.2 | 16.5 | 24.0 | 35 | 12 | 6.7 | 0.11 | ES32/16.5 | ESG32/16.5 | 345 | 345 | |
| 1/2 | 13 | 17.3 | 12.5 | 30.2 | 17.6 | 24.0 | 35 | 12 | 6.7 | 0.12 | ES32/17.6 | ESG32/17.6 | 345 | 345 | |
| 3/4 | 19 | 20.0 | 15.0 | 38.1 | 20.5 | 31.5 | 40 | 13 | 6.7 | 0.20 | ES33/20.5 | ESG33/20.5 | 345 | 345 | |
| 3/4 | 19 | 21.3 | 15.0 | 38.1 | 21.7 | 31.5 | 40 | 13 | 6.7 | 0.20 | ES33/21.7 | ESG33/21.7 | 345 | 345 | |
| 1 | 25 | 25.0 | 20.0 | 44.4 | 25.5 | 38.0 | 45 | 14 | 8.0 | 0.30 | ES34/25.5 | ESG34/25.5 | 345 | 345 | |
| 1 | 25 | 26.9 | 20.0 | 44.4 | 27.3 | 38.0 | 45 | 14 | 8.0 | 0.28 | ES34/27.3 | ESG34/27.3 | 345 | 345 | |
| 1 1/4 | 32 | 30.0 | 25.0 | 50.8 | 30.5 | 43.0 | 50 | 16 | 8.0 | 0.39 | ES35/30.5 | ESG35/30.5 | 276 | 276 | |
| 1 1/4 | 32 | 32.0 | 25.0 | 50.8 | 32.5 | 43.0 | 50 | 16 | 8.0 | 0.37 | ES35/32.5 | ESG35/32.5 | 276 | 276 | |
| 1 1/4 | 32 | 33.7 | 25.0 | 50.8 | 34.2 | 43.0 | 50 | 16 | 8.0 | 0.35 | ES35/34.2 | ESG35/34.2 | 276 | 276 | |
| 1 1/2 | 38 | 38.0 | 32.0 | 60.3 | 38.5 | 50.0 | 55 | 18 | 8.0 | 0.52 | ES36/38.5 | ESG36/38.5 | 207 | 207 | |
| 1 1/2 | 38 | 40.0 | 32.0 | 60.3 | 40.7 | 50.0 | 55 | 18 | 8.0 | 0.49 | ES36/40.7 | ESG36/40.7 | 207 | 207 | |
| 1 1/2 | 38 | 42.4 | 32.0 | 60.3 | 43.0 | 50.0 | 55 | 18 | 8.0 | 0.47 | ES36/43 | ESG36/43 | 207 | 207 | |
| 2 | 51 | 48.3 | 32.0 | 71.4 | 49.0 | 62.0 | 65 | 20 | 9.5 | 0.95 | ES38/49 | ESG38/49 | 207 | 207 | |
| 2 | 51 | 50.0 | 38.0 | 71.4 | 50.7 | 62.0 | 65 | 20 | 9.5 | 0.87 | ES38/50.7 | ESG38/50.7 | 207 | 207 | |
| 2 1/2 | 64 | 60.3 | 38.0 | 84.1 | 61.0 | 74.0 | 75 | 22 | 9.5 | 1.46 | ES310/61 | ESG310/61 | 172 | 172 | |
| 2 1/2 | 64 | 63.5 | 47.0 | 84.1 | 64.0 | 74.0 | 75 | 22 | 9.5 | 1.37 | ES310/64 | ESG310/64 | 172 | 172 | |
| 3 | 76 | 73.5 | 47.0 | 101.6 | 74.0 | 90.0 | 85 | 24 | 9.5 | 2.30 | ES312/74 | ESG312/74 | 138 | 138 | |
| 3 | 76 | 76.1 | 58.0 | 101.6 | 77.0 | 90.0 | 85 | 24 | 9.5 | 2.23 | ES312/77 | ESG312/77 | 138 | 138 | |
| 3 | 76 | 80.0 | 58.0 | 101.6 | 81.0 | 90.0 | 85 | 24 | 9.5 | 2.13 | ES312/81 | ESG312/81 | 138 | 138 | |

¹⁾ Pressure shown = Item deliverable

$$\frac{PN \text{ (bar)}}{10} = PN \text{ (MPa)}$$

The pressures given here are the maximum allowable for the flange fittings. If the pipe or tube used has a lower pressure rating, then the welded assembly rating will be the lower one, assuming the weld is adequately strong.

See pages N16 - N20 for related flanges or flange halves depending on bolt sets.

Stainless steel parts may have dimensional deviations. Additional information on request.



*Please add the **suffixes** below according to the material/surface required.

| Order code suffixes | | | | | |
|---------------------|-----------------------------|-----------------------------|--|--|---|
| Material | Suffix surface and material | Example only flange adapter | Example incl. splitflanges, metr. bolts and O-ring | Example incl. splitflanges, UNC bolts and O-ring | Standard sealing material (no additional suffix needed) |
| Steel, oil dipped | S | ES32/16.5S | ES32/16.5SM | ES32/16.5SU | NBR |
| Stainless steel | SS | ES32/16.5SS | ES32/16.5SSM | - | VIT |



SAE Flange adapters

ES SAE Straight flange adapter

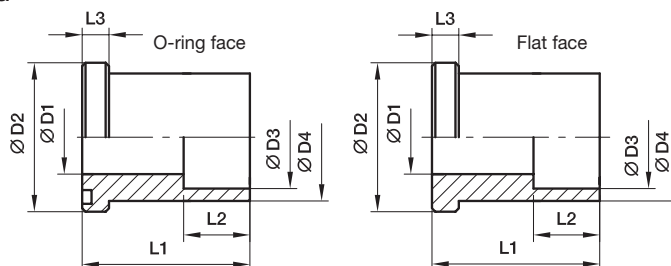
 SAE Flange / Socket weld tube end
(ISO 6162-1/-2)

6000 PSI Series

| Nom. flange size | | ⌀ | max. | D1 | D2 | D3 | D4 | L1 | L2 | L3 | Weight (steel) kg/piece | O-ring face Order code* | Flat face Order code* | PN (bar) ¹⁾ | |
|------------------|----------|------|------|------|------|------|----|----|------|------|-------------------------|-------------------------|-----------------------|------------------------|----|
| SAE (in.) | ISO (DN) | | | | | | | | | | | | | S | SS |
| 1/2 | 13 | 16.0 | 11.0 | 31.8 | 16.5 | 24.0 | 35 | 13 | 7.7 | 0.26 | ES62/16.5 | ESG62/16.5 | 420 | 420 | |
| 1/2 | 13 | 17.3 | 11.0 | 31.8 | 17.6 | 24.0 | 35 | 13 | 7.7 | 0.24 | ES62/17.6 | ESG62/17.6 | 420 | 420 | |
| 3/4 | 13 | 20.0 | 15.0 | 41.3 | 20.5 | 31.8 | 40 | 13 | 8.7 | 0.22 | ES63/20.5 | ESG63/20.5 | 420 | 420 | |
| 3/4 | 19 | 21.3 | 15.0 | 41.3 | 21.7 | 31.8 | 40 | 13 | 8.7 | 0.19 | ES63/21.7 | ESG63/21.7 | 420 | 420 | |
| 1 | 25 | 25.0 | 20.0 | 47.6 | 25.5 | 38.0 | 45 | 13 | 9.5 | 0.32 | ES64/25.5 | ESG64/25.5 | 420 | 420 | |
| 1 | 25 | 26.9 | 20.0 | 47.6 | 27.3 | 38.0 | 45 | 13 | 9.5 | 0.31 | ES64/27.3 | ESG64/27.3 | 420 | 420 | |
| 1 1/4 | 32 | 30.0 | 24.0 | 54.0 | 30.5 | 44.0 | 50 | 16 | 10.3 | 0.43 | ES65/30.5 | ESG65/30.5 | 420 | 420 | |
| 1 1/4 | 32 | 32.0 | 24.0 | 54.0 | 32.5 | 44.0 | 50 | 16 | 10.3 | 0.43 | ES65/32.5 | ESG65/32.5 | 420 | 420 | |
| 1 1/4 | 32 | 33.7 | 24.0 | 54.0 | 34.2 | 44.0 | 50 | 16 | 10.3 | 0.45 | ES65/34.2 | ESG65/34.2 | 420 | 420 | |
| 1 1/2 | 38 | 38.0 | 31.0 | 63.5 | 38.5 | 51.0 | 55 | 18 | 12.5 | 0.63 | ES66/38.5 | ESG66/38.5 | 420 | 420 | |
| 1 1/2 | 38 | 40.0 | 31.0 | 63.5 | 40.7 | 51.0 | 55 | 18 | 12.5 | 0.60 | ES66/40.7 | ESG66/40.7 | 420 | 420 | |
| 1 1/2 | 38 | 42.4 | 31.0 | 63.5 | 42.8 | 51.0 | 55 | 18 | 12.5 | 0.57 | ES66/42.8 | ESG66/42.8 | 420 | 420 | |
| 2 | 51 | 48.3 | 38.0 | 79.4 | 49.0 | 67.0 | 65 | 20 | 12.5 | 1.24 | ES68/49 | ESG68/49 | 420 | 420 | |
| 2 | 51 | 50.0 | 38.0 | 79.4 | 50.7 | 67.0 | 65 | 20 | 12.5 | 1.22 | ES68/50.7 | ESG68/50.7 | 420 | 420 | |

¹⁾Pressure shown = Item deliverable

 PN (bar) = PN (MPa)
10

The pressures given here are the maximum allowable for the flange fittings. If the pipe or tube used has a lower pressure rating, then the welded assembly rating will be the lower one, assuming the weld is adequately strong.

See pages N16 - N20 for related flanges or flange halves depending on bolt sets.

Stainless steel parts may have dimensional deviations. Additional information on request.

*Please add the suffixes below according to the material/surface required.

| Order code suffixes | | | | | |
|---------------------|-----------------------------|-----------------------------|--|--|---|
| Material | Suffix surface and material | Example only flange adapter | Example incl. splitflanges, metr. bolts and O-ring | Example incl. splitflanges, UNC bolts and O-ring | Standard sealing material (no additional suffix needed) |
| Steel, oil dipped | S | ES62/16.5S | ES62/16.5SM | ES62/16.5SU | NBR |
| Stainless steel | SS | ES62/16.5SS | ES62/16.5SSM | - | VIT |



ESL SAE Straight flange adapter

SAE Flange / Socket weld tube end
(ISO 6162-1/-2)

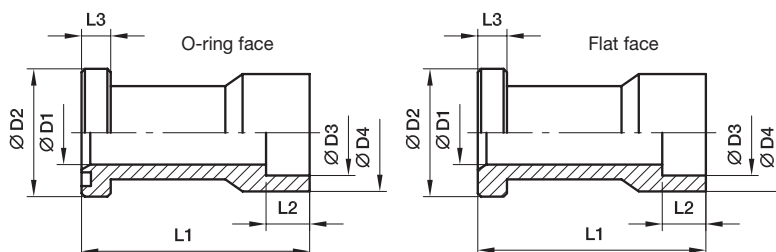

3000 PSI Series

| Nom. flange size | | ⌀ | D1 | D2 | D3 | D4 | L1 | L2 | L3 | Weight (steel) kg/piece | O-ring face Order code* | Flat face Order code* | PN (bar) ¹⁾ | |
|------------------|----------|------|----|-------|------|-----|-----|----|-----|-------------------------|-------------------------|-----------------------|------------------------|-----|
| SAE (in.) | ISO (DN) | | | | | | | | | | | | max. | S |
| 1/2 | 13 | 20.0 | 15 | 30.2 | 20.5 | 30 | 60 | 13 | 6.7 | 0.45 | ESL32/20.5 | ESLG32/20.5 | 345 | 345 |
| 1/2 | 13 | 21.3 | 15 | 30.2 | 21.7 | 30 | 60 | 13 | 6.7 | 0.44 | ESL32/21.7 | ESLG32/21.7 | 345 | 345 |
| 3/4 | 19 | 25.0 | 19 | 38.1 | 25.5 | 35 | 68 | 13 | 6.7 | 0.60 | ESL33/25.5 | ESLG33/25.5 | 345 | 345 |
| 3/4 | 19 | 26.9 | 19 | 38.1 | 27.3 | 35 | 68 | 13 | 6.7 | 0.30 | ESL33/27.3 | ESLG33/27.3 | 345 | 345 |
| 1 | 25 | 30.0 | 23 | 44.4 | 30.5 | 44 | 75 | 16 | 8.0 | 0.75 | ESL34/30.5 | ESLG34/30.5 | 345 | 345 |
| 1 | 25 | 32.0 | 24 | 44.4 | 32.5 | 44 | 75 | 16 | 8.0 | 0.72 | ESL34/32.5 | ESLG34/32.5 | 345 | 345 |
| 1 | 25 | 33.7 | 25 | 44.4 | 34.0 | 44 | 75 | 16 | 8.0 | 0.44 | ESL34/34 | ESLG34/34 | 345 | 345 |
| 1 | 25 | 35.0 | 25 | 44.4 | 35.5 | 44 | 75 | 16 | 8.0 | 0.42 | ESL34/35.5 | ESLG34/35.5 | 345 | 345 |
| 1 1/4 | 32 | 38.0 | 32 | 50.8 | 38.5 | 55 | 95 | 18 | 8.0 | 0.67 | ESL35/38.5 | ESLG35/38.5 | 276 | 276 |
| 1 1/4 | 32 | 40.0 | 32 | 50.8 | 40.5 | 55 | 95 | 18 | 8.0 | 0.95 | ESL35/40.5 | ESLG35/40.5 | 276 | 276 |
| 1 1/4 | 32 | 42.4 | 32 | 50.8 | 43.0 | 55 | 95 | 18 | 8.0 | 0.63 | ESL35/43 | ESLG35/43 | 276 | 276 |
| 1 1/2 | 38 | 48.3 | 38 | 60.3 | 49.0 | 68 | 100 | 20 | 8.0 | 0.94 | ESL36/49 | ESLG36/49 | 207 | 207 |
| 1 1/2 | 38 | 50.0 | 38 | 60.3 | 50.4 | 68 | 100 | 20 | 8.0 | 0.88 | ESL36/50.4 | ESLG36/50.4 | 207 | 207 |
| 2 | 51 | 60.3 | 50 | 71.4 | 61.0 | 79 | 107 | 22 | 9.5 | 1.34 | ESL38/61 | ESLG38/61 | 207 | 207 |
| 2 | 51 | 65.0 | 50 | 71.4 | 65.8 | 79 | 107 | 22 | 9.5 | 1.80 | ESL38/65.8 | ESLG38/65.8 | 207 | 207 |
| 2 1/2 | 64 | 73.0 | 58 | 84.1 | 74.0 | 98 | 130 | 24 | 9.5 | 2.30 | ESL310/74 | ESLG310/74 | 172 | 172 |
| 2 1/2 | 64 | 76.1 | 58 | 84.1 | 77.0 | 98 | 130 | 24 | 9.5 | 2.25 | ESL310/77 | ESLG310/77 | 172 | 172 |
| 2 1/2 | 64 | 80.0 | 58 | 84.1 | 81.0 | 98 | 130 | 24 | 9.5 | 2.15 | ESL310/81 | ESLG310/81 | 172 | 172 |
| 3 | 76 | 88.9 | 70 | 101.6 | 90.5 | 116 | 150 | 28 | 9.5 | 3.00 | ESL312/90.5 | ESLG312/90.5 | 138 | 138 |

6000 PSI Series

| | | | | | | | | | | | | | | |
|-----|----|------|----|------|------|----|----|----|-----|------|------------|-------------|-----|-----|
| 1/2 | 13 | 20.0 | 15 | 31.8 | 20.5 | 32 | 60 | 13 | 7.7 | 0.45 | ESL62/20.5 | ESLG62/20.5 | 420 | 420 |
| 1/2 | 13 | 21.3 | 15 | 31.8 | 21.7 | 32 | 60 | 13 | 7.7 | 0.44 | ESL62/21.7 | ESLG62/21.7 | 420 | 420 |
| 1/2 | 13 | 22.0 | 15 | 31.8 | 22.5 | 32 | 60 | 13 | 7.7 | 0.65 | ESL62/22.5 | ESLG62/22.5 | 420 | 420 |
| 3/4 | 19 | 25.0 | 19 | 41.3 | 25.7 | 40 | 68 | 13 | 8.7 | 0.38 | ESL63/25.7 | ESLG63/25.7 | 420 | 420 |
| 3/4 | 19 | 26.9 | 19 | 41.3 | 27.3 | 40 | 68 | 13 | 8.7 | 0.61 | ESL63/27.3 | ESLG63/27.3 | 420 | 420 |
| 3/4 | 19 | 28.0 | 19 | 41.3 | 28.7 | 40 | 68 | 13 | 8.7 | 0.37 | ESL63/28.7 | ESLG63/28.7 | 420 | 420 |
| 1 | 25 | 33.7 | 25 | 47.6 | 34.0 | 48 | 75 | 16 | 9.5 | 0.75 | ESL64/34 | ESLG64/34 | 420 | 420 |
| 1 | 25 | 35.0 | 25 | 47.6 | 35.5 | 48 | 75 | 16 | 9.5 | 0.73 | ESL64/35.5 | ESLG64/35.5 | 420 | 420 |

¹⁾Pressure shown = Item deliverable

PN (bar) / 10 = PN (MPa)

The pressures given here are the maximum allowable for the flange fittings. If the pipe or tube used has a lower pressure rating, then the welded assembly rating will be the lower one, assuming the weld is adequately strong.

See pages N16 and N19 for related flange halves depending on bolt sets.

Stainless steel parts may have dimensional deviations. Additional information on request.

*Please add the suffixes below according to the material/surface required.

| Order code suffixes | | | | | |
|---------------------|-----------------------------|-----------------------------|--|--|---|
| Material | Suffix surface and material | Example only flange adapter | Example incl. splitflanges, metr. bolts and O-ring | Example incl. splitflanges, UNC bolts and O-ring | Standard sealing material (no additional suffix needed) |
| Steel, oil dipped | S | ESL32/20.5S | ESL32/20.5SM | ESL32/20.5SU | NBR |
| Stainless steel | SS | ESL32/20.5SS | ESL32/20.5SSM | - | VIT |



SAE Full flanges

PFF-G SAE Straight 4 bolt flange with BSPP thread

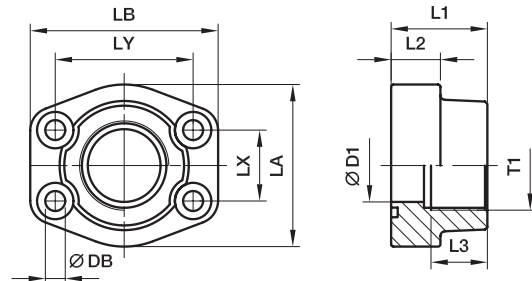
 SAE Flange / Female BSPP thread
(ISO 6162-1/-2)

3000 PSI Series

| Nom. flange size | | T1 | D1 | L1 | L2 | L3 | LA | LB | LX | LY | DB | Weight (steel) kg/piece | Order code* | PN (bar ¹) | |
|------------------|----------|----------------|-----|----|----|----|-----|-----|------|-------|---------|-------------------------|-------------------|------------------------|-----|
| SAE (in.) | ISO (DN) | | | | | | | | | | | | | S | SS |
| 1/2 | 13 | G 3/8 | 13 | 36 | 16 | 18 | 46 | 57 | 17.5 | 38.1 | 8.9 | 0.31 | PFF32G38 | 345 | 345 |
| 1/2 | 13 | G 1/2 | 13 | 36 | 16 | 18 | 46 | 54 | 17.5 | 38.1 | 8.9 | 0.28 | PFF32G | 345 | 345 |
| 3/4 | 19 | G 3/4 | 19 | 36 | 18 | 18 | 52 | 65 | 22.2 | 47.6 | 10.6 | 0.39 | PFF33G | 345 | 345 |
| 3/4 | 19 | G 1/2 | 13 | 36 | 18 | 18 | 52 | 65 | 22.2 | 47.6 | 10.6 | 0.42 | PFF33G12 | 345 | 345 |
| 1 | 25 | G 1 | 25 | 38 | 18 | 20 | 59 | 70 | 26.2 | 52.4 | 10.6 | 0.48 | PFF34G | 345 | 345 |
| 1 | 25 | G 3/4 | 19 | 38 | 18 | 18 | 59 | 70 | 26.2 | 52.4 | 10.6 | 0.56 | PFF34G34 | 345 | 345 |
| 1 1/4 | 32 | G 1 1/4 | 31 | 41 | 21 | 22 | 68 | 79 | 30.2 | 58.7 | 10.6*** | 0.76 | PFF35G | 276 | 276 |
| 1 1/4 | 32 | G 1 | 25 | 41 | 21 | 20 | 68 | 79 | 30.2 | 58.7 | 10.6*** | 0.89 | PFF35G1 | 276 | 276 |
| 1 1/2 | 38 | G 1 1/2 | 38 | 44 | 25 | 24 | 78 | 93 | 35.7 | 69.9 | 13.3 | 1.12 | PFF36G | 207 | 207 |
| 1 1/2 | 38 | G 1 1/4 | 32 | 45 | 27 | 22 | 78 | 93 | 35.7 | 69.9 | 13.3 | 1.21 | PFF36G114 | 207 | 207 |
| 2 | 51 | G 2 | 50 | 45 | 25 | 26 | 89 | 103 | 42.9 | 77.8 | 13.5 | 1.32 | PFF38G | 207 | 207 |
| 2 | 51 | G 1 1/2 | 38 | 45 | 25 | 24 | 89 | 103 | 42.9 | 77.8 | 13.5 | 1.65 | PFF38G112 | 207 | 207 |
| 2 1/2 | 64 | G 2 1/2 | 63 | 50 | 25 | 30 | 108 | 114 | 50.8 | 88.9 | 13.5 | 1.73 | PFF310G | 172 | 172 |
| 2 1/2 | 64 | G 2 | 51 | 50 | 25 | 30 | 108 | 114 | 50.8 | 88.9 | 13.5 | 2.20 | PFF310G2 | 172 | 172 |
| 3 | 76 | G 3 | 73 | 50 | 27 | 34 | 124 | 135 | 61.9 | 106.4 | 17.5 | 2.38 | PFF312G | 138 | 138 |
| 3 | 76 | G 2 1/2 | 63 | 50 | 27 | 30 | 124 | 135 | 61.9 | 106.4 | 16.7 | 2.57 | PFF312G212 | 138 | 138 |
| 3 1/2 | 89 | G 3 1/2 | 89 | 48 | 27 | 34 | 136 | 152 | 69.9 | 120.7 | 16.7 | 2.50 | PFF314G | 34 | 34 |
| 3 1/2 | 89 | G 3 | 73 | 48 | 27 | 34 | 136 | 152 | 69.9 | 120.7 | 16.7 | 3.10 | PFF314G3 | 34 | 34 |
| 4 | 102 | G 4 | 99 | 48 | 27 | 34 | 146 | 162 | 77.8 | 130.2 | 16.7 | 2.65 | PFF316G | 34 | 34 |
| 4 | 102 | G 3 1/2 | 89 | 48 | 27 | 34 | 146 | 162 | 77.8 | 130.2 | 16.7 | 3.30 | PFF316G312 | 34 | 34 |
| 5 | 127 | G 5 | 120 | 50 | 28 | 30 | 180 | 184 | 92.1 | 152.4 | 16.7 | 5.80 | PFF320G | 34 | 34 |

6000 PSI Series

| | | | | | | | | | | | | | | | |
|-------|----|----------------|----|----|----|----|-----|-----|------|-------|--------|------|-------------------|-----|-----|
| 1/2 | 13 | G 3/8 | 13 | 36 | 16 | 18 | 46 | 57 | 18.2 | 40.5 | 8.9 | 0.29 | PFF62G38 | 420 | 420 |
| 1/2 | 13 | G 1/2 | 13 | 36 | 16 | 15 | 46 | 57 | 18.2 | 40.5 | 8.9 | 0.30 | PFF62G | 420 | 420 |
| 3/4 | 19 | G 3/4 | 19 | 36 | 19 | 18 | 55 | 71 | 23.8 | 50.8 | 10.6 | 0.53 | PFF63G | 420 | 420 |
| 3/4 | 19 | G 1/2 | 13 | 35 | 21 | 19 | 55 | 71 | 23.8 | 50.8 | 10.6 | 0.58 | PFF63G12 | 420 | 420 |
| 1 | 25 | G 1 | 25 | 44 | 24 | 20 | 69 | 81 | 27.8 | 57.2 | 13.3 | 0.86 | PFF64G | 420 | 420 |
| 1 | 25 | G 3/4 | 19 | 44 | 24 | 18 | 69 | 81 | 27.8 | 57.2 | 13.3 | 0.94 | PFF64G34 | 420 | 420 |
| 1 1/4 | 32 | G 1 1/4 | 31 | 44 | 27 | 22 | 79 | 95 | 31.8 | 66.7 | 15.0** | 1.16 | PFF65G | 420 | 420 |
| 1 1/4 | 32 | G 1 1/4 | 32 | 45 | 27 | 25 | 78 | 95 | 31.8 | 66.7 | 13.5 | 1.23 | PFF65/12G | 420 | 420 |
| 1 1/4 | 32 | G 1 | 25 | 45 | 27 | 24 | 78 | 95 | 31.8 | 66.7 | 15.0** | 1.26 | PFF65G1 | 420 | 420 |
| 1 1/4 | 32 | G 1 | 25 | 45 | 27 | 25 | 78 | 95 | 31.8 | 66.7 | 13.3 | 1.26 | PFF65/12G1 | 420 | 420 |
| 1 1/2 | 38 | G 1 1/2 | 38 | 51 | 30 | 24 | 88 | 107 | 36.5 | 79.4 | 16.7 | 1.98 | PFF66G | 420 | 420 |
| 1 1/2 | 38 | G 1 1/4 | 32 | 50 | 30 | 25 | 95 | 114 | 36.5 | 79.4 | 16.7 | 2.08 | PFF66G114 | 420 | 420 |
| 2 | 51 | G 2 | 50 | 70 | 37 | 33 | 117 | 136 | 44.5 | 96.8 | 20.6 | 3.31 | PFF68G | 420 | 420 |
| 2 | 51 | G 1 1/2 | 38 | 65 | 37 | 28 | 114 | 134 | 44.5 | 96.8 | 20.6 | 3.76 | PFF68G112 | 420 | 420 |
| 2 1/2 | 64 | G 2 1/2 | 63 | 80 | 45 | 32 | 152 | 180 | 58.7 | 123.8 | 25.0 | 3.05 | PFF610G | 420 | 420 |
| 3 | 76 | G 3 | 73 | 90 | 55 | 40 | 178 | 208 | 71.4 | 152.4 | 32.0 | 3.45 | PFF612G | 420 | 420 |

*Please add the suffixes below according to the material/surface required.

**DB = 13.3 for UNC Bolts

*** = 12 for UNC Bolts

1) Pressure shown = Item deliverable

| Order code suffixes | | | | | |
|---------------------------------|-----------------------------|----------------------------|--|--|---|
| Material | Suffix surface and material | Example only 4 bolt flange | Example 4 bolt flange incl. metr. bolts and O-ring | Example 4 bolt flange incl. UNC bolts and O-ring | Standard sealing material (no additional suffix needed) |
| Steel, zinc plated, Cr(VI)-free | CF | PFF32G38CF | PFF32G38CFM | PFF32G38CFU | NBR |
| Stainless steel | SS | PFF32G38SS | PFF32G38SSM | - | VIT |

Stainless steel parts may have dimensional deviations. Additional information on request.

$$\frac{\text{PN (bar)}}{10} = \text{PN (MPa)}$$



PCFF-G SAE Straight 4 bolt flange with BSPP thread

SAE Counter flange / Female BSPP thread
(ISO 6162-1/-2)

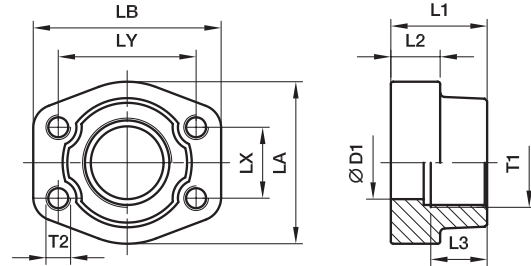

3000 PSI Series

| Nom. flange size | | T1 | D1 | L1 | L2 | L3 | LA | LB | LX | LY | T2 | | Weight (steel) kg/piece | Order code* | PN (bar) ¹⁾ | |
|------------------|----------|---------|-----|----|----|------|-----|-----|------|-------|---------|--------|-------------------------|-------------|------------------------|-----|
| SAE (in.) | ISO (DN) | | | | | | | | | | (metr.) | (unc.) | | | S | SS |
| 1/2 | 13 | G 3/8 | 13 | 36 | 16 | 15.0 | 46 | 57 | 17.5 | 38.1 | M 8 | 5/16 | 0.33 | PCFF32G38 | 345 | 345 |
| 1/2 | 13 | G 1/2 | 13 | 36 | 16 | 18.0 | 46 | 54 | 17.5 | 38.1 | M 8 | 5/16 | 0.29 | PCFF32G | 345 | 345 |
| 3/4 | 19 | G 3/4 | 19 | 36 | 18 | 19.0 | 52 | 65 | 22.3 | 47.6 | M10 | 3/8 | 0.34 | PCFF33G | 345 | 345 |
| 3/4 | 19 | G 1/2 | 13 | 36 | 18 | 19.0 | 50 | 65 | 22.3 | 47.6 | M10 | 3/8 | 0.42 | PCFF33G12 | 345 | 345 |
| 1 | 25 | G 1 | 25 | 38 | 18 | 20.5 | 59 | 70 | 26.2 | 52.4 | M10 | 3/8 | 0.47 | PCFF34G | 345 | 345 |
| 1 | 25 | G 3/4 | 19 | 35 | 21 | 19.0 | 55 | 70 | 26.2 | 52.4 | M10 | 3/8 | 0.56 | PCFF34G34 | 345 | 345 |
| 1 1/4 | 32 | G 1 1/4 | 32 | 40 | 21 | 22.0 | 68 | 79 | 30.2 | 58.7 | M10 | 7/16 | 0.68 | PCFF35G | 276 | 276 |
| 1 1/4 | 32 | G 1 | 25 | 42 | 25 | 22.0 | 65 | 80 | 30.2 | 58.7 | M10 | 7/16 | 0.84 | PCFF35G1 | 276 | 276 |
| 1 1/2 | 38 | G 1 1/2 | 38 | 45 | 25 | 24.0 | 78 | 93 | 35.7 | 69.9 | M12 | 1/2 | 1.12 | PCFF36G | 207 | 207 |
| 1 1/2 | 38 | G 1 1/4 | 32 | 45 | 27 | 22.0 | 78 | 95 | 35.7 | 69.9 | M12 | 1/2 | 1.22 | PCFF36G114 | 207 | 207 |
| 2 | 51 | G 2 | 50 | 45 | 25 | 26.0 | 89 | 103 | 42.9 | 77.8 | M12 | 1/2 | 1.38 | PCFF38G | 207 | 207 |
| 2 | 51 | G 1 1/2 | 38 | 45 | 25 | 24.0 | 89 | 103 | 42.9 | 77.8 | M12 | 1/2 | 1.59 | PCFF38G112 | 207 | 207 |
| 2 1/2 | 64 | G 2 1/2 | 63 | 50 | 25 | 30.0 | 101 | 115 | 50.8 | 88.9 | M12 | 1/2 | 1.66 | PCFF310G | 172 | 172 |
| 2 1/2 | 64 | G 2 | 51 | 50 | 25 | 30.0 | 101 | 115 | 50.8 | 88.9 | M12 | 1/2 | 2.09 | PCFF310G2 | 172 | 172 |
| 3 | 76 | G 3 | 73 | 50 | 27 | 30.0 | 124 | 135 | 61.9 | 106.4 | M16 | 5/8 | 2.37 | PCFF312G | 138 | 138 |
| 3 | 76 | G 2 1/2 | 63 | 50 | 27 | 30.0 | 124 | 135 | 61.9 | 106.4 | M16 | 5/8 | 2.65 | PCFF312G212 | 138 | 138 |
| 3 1/2 | 89 | G 3 1/2 | 89 | 50 | 27 | 30.0 | 136 | 152 | 69.9 | 120.7 | M16 | 5/8 | 2.51 | PCFF314G | 34 | 34 |
| 3 1/2 | 89 | G 3 | 73 | 48 | 27 | 34.0 | 136 | 152 | 69.9 | 120.7 | M16 | 5/8 | 3.37 | PCFF314G3 | 34 | 34 |
| 4 | 102 | G 4 | 99 | 50 | 27 | 30.0 | 146 | 162 | 77.8 | 130.2 | M16 | 5/8 | 2.87 | PCFF316G | 34 | 34 |
| 4 | 102 | G 3 1/2 | 89 | 48 | 27 | 34.0 | 146 | 162 | 77.8 | 130.2 | M16 | 5/8 | 3.39 | PCFF316G312 | 34 | 34 |
| 5 | 127 | G 5 | 120 | 50 | 28 | 30.0 | 180 | 184 | 92.1 | 152.4 | M16 | 5/8 | 5.80 | PCFF320G | 34 | 34 |

6000 PSI Series

| | | | | | | | | | | | | | | | | |
|-------|----|---------|----|----|----|------|-----|-----|------|-------|-----|------|-------|-------------|-----|-----|
| 1/2 | 13 | G 3/8 | 13 | 36 | 16 | 13.0 | 46 | 57 | 18.2 | 40.5 | M 8 | 5/16 | 0.33 | PCFF62G38 | 420 | 420 |
| 1/2 | 13 | G 1/2 | 13 | 36 | 16 | 19.0 | 46 | 57 | 18.2 | 40.5 | M 8 | 5/16 | 0.29 | PCFF62G | 420 | 420 |
| 3/4 | 19 | G 3/4 | 19 | 35 | 21 | 22.0 | 55 | 71 | 23.8 | 50.8 | M10 | 3/8 | 0.58 | PCFF63G | 420 | 420 |
| 3/4 | 19 | G 1/2 | 13 | 35 | 21 | 19.0 | 55 | 71 | 23.8 | 50.8 | M10 | 3/8 | 0.58 | PCFF63G12 | 420 | 420 |
| 1 | 25 | G 1 | 25 | 42 | 25 | 24.0 | 65 | 81 | 27.8 | 57.2 | M12 | 7/16 | 0.82 | PCFF64G | 420 | 420 |
| 1 | 25 | G 3/4 | 19 | 42 | 25 | 22.0 | 65 | 81 | 27.8 | 57.2 | M12 | 7/16 | 0.88 | PCFF64G34 | 420 | 420 |
| 1 1/4 | 32 | G 1 1/4 | 32 | 45 | 27 | 25.0 | 78 | 95 | 31.8 | 66.6 | M14 | 1/2 | 1.18 | PCFF65G | 420 | 420 |
| 1 1/4 | 32 | G 1 1/4 | 32 | 45 | 27 | 25.0 | 78 | 95 | 31.8 | 66.6 | M12 | - | 1.18 | PCFF65/12G | 420 | 420 |
| 1 1/4 | 32 | G 1 | 25 | 45 | 27 | 24.0 | 78 | 95 | 31.8 | 66.6 | M14 | 1/2 | 1.24 | PCFF65G1 | 420 | 420 |
| 1 1/4 | 32 | G 1 | 25 | 45 | 27 | 24.0 | 78 | 95 | 31.8 | 66.6 | M12 | - | 1.24 | PCFF65/12G1 | 420 | 420 |
| 1 1/2 | 38 | G 1 1/2 | 38 | 50 | 30 | 28.0 | 94 | 112 | 36.5 | 79.3 | M16 | 5/8 | 1.90 | PCFF66G | 420 | 420 |
| 1 1/2 | 38 | G 1 1/4 | 32 | 50 | 30 | 25.0 | 94 | 112 | 36.5 | 79.3 | M16 | 5/8 | 2.03 | PCFF66G114 | 420 | 420 |
| 2 | 51 | G 2 | 50 | 70 | 37 | 33.0 | 116 | 135 | 44.5 | 96.8 | M20 | 3/4 | 3.68 | PCFF68G | 420 | 420 |
| 2 | 51 | G 1 1/2 | 38 | 65 | 37 | 28.0 | 114 | 134 | 44.5 | 96.8 | M20 | 3/4 | 3.86 | PCFF68G112 | 420 | 420 |
| 2 1/2 | 64 | G 2 1/2 | 63 | 80 | 45 | 32.0 | 152 | 180 | 58.7 | 123.8 | M24 | - | 6.98 | PCFF610G | 420 | 420 |
| 3 | 76 | G 3 | 73 | 90 | 55 | 40.0 | 178 | 208 | 71.4 | 152.4 | M30 | - | 13.00 | PCFF612G | 420 | 420 |

*Please add the suffixes below according to the material/surface required.

¹⁾ Pressure shown = Item deliverable

| Material | Suffix surface and material | Order code suffixes | | Standard sealing material (no additional suffix needed) |
|---------------------------------|-----------------------------|--|--|---|
| | | Example 4 bolt flange with metr. threads | Example 4 bolt flange with UNC threads | |
| Steel, zinc plated, Cr(VI)-free | CF | PCFF32G38CFM | PCFF32G38CFU | NBR |
| Stainless steel | SS | PCFF32G38SSM | PCFF32G38SSU | VIT |

$\frac{PN \text{ (bar)}}{10} = PN \text{ (MPa)}$
Stainless steel parts may have dimensional deviations. Additional information on request.



SAE Full flanges

PAFSF-G SAE Straight 4 bolt flange flat with BSPP thread

 SAE Flange / Female BSPP thread
(ISO 6162-1/-2)

only for low pressure applications

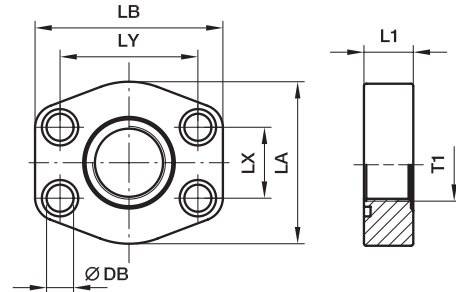
3000 PSI Series

| Nom. flange size | | T1 | L1 | LA | LB | LX | LY | DB | Bolts | | O-ring | Weight (steel) kg/piece | Order code* | PN (bar) ¹⁾ | |
|------------------|----------|----------------|----|-----|-----|------|-------|---------|---------|------------|---------------|-------------------------|--------------|------------------------|----|
| SAE (in.) | ISO (DN) | | | | | | | | (metr.) | (unc.) | | | | S | SS |
| 1/2 | 13 | G 3/8 | 16 | 46 | 58 | 17.5 | 38.1 | 8.9 | M 08x30 | 5/16x1 1/4 | Standard | 0.20 | PAFSF080G38 | 40 | 40 |
| 1/2 | 13 | G 1/2 | 16 | 46 | 58 | 17.5 | 38.1 | 8.9 | M 08x30 | 5/16x1 1/4 | OR25.07x2.62X | 0.27 | PAFSF080G | 40 | 40 |
| 3/4 | 19 | G 1/2 | 18 | 49 | 66 | 22.3 | 47.6 | 10.6 | M 10x35 | 3/8x1 1/2 | Standard | 0.29 | PAFSF100G12 | 40 | 40 |
| 3/4 | 19 | G 3/4 | 18 | 49 | 66 | 22.3 | 47.6 | 10.6 | M 10x35 | 3/8x1 1/2 | OR31.34X3.53X | 0.27 | PAFSF100G | 40 | 40 |
| 1 | 25 | G 3/4 | 19 | 53 | 71 | 26.2 | 52.4 | 10.6 | M 10x35 | 3/8x1 1/2 | Standard | 0.37 | PAFSF102G34 | 40 | 40 |
| 1 | 25 | G 1 | 19 | 53 | 71 | 26.2 | 52.4 | 10.6 | M 10x35 | 3/8x1 1/2 | OR37.7X3.53X | 0.32 | PAFSF102G | 40 | 40 |
| 1 1/4 | 32 | G 1 | 21 | 69 | 80 | 30.2 | 58.7 | 10.6*** | M 10x35 | 7/16x1 1/2 | Standard | 0.57 | PAFSF104G1 | 40 | 40 |
| 1 1/4 | 32 | G 1 1/4 | 21 | 69 | 80 | 30.2 | 58.7 | 10.6*** | M 10x35 | 7/16x1 1/2 | OR44.45X3.53X | 0.62 | PAFSF104G | 40 | 40 |
| 1 1/2 | 38 | G 1 1/4 | 24 | 77 | 95 | 35.7 | 69.9 | 13.3 | M 12x45 | 1/2x1 3/4 | Standard | 0.83 | PAFSF106G114 | 40 | 40 |
| 1 1/2 | 38 | G 1 1/2 | 24 | 77 | 95 | 35.7 | 69.9 | 13.3 | M 12x45 | 1/2x1 3/4 | OR52.39X3.53X | 0.79 | PAFSF106G | 40 | 40 |
| 2 | 51 | G 1 1/2 | 24 | 89 | 103 | 42.9 | 77.8 | 13.5 | M 12x45 | 1/2x1 3/4 | Standard | 1.00 | PAFSF108G112 | 40 | 40 |
| 2 | 51 | G 2 | 24 | 89 | 103 | 42.9 | 77.8 | 13.5 | M 12x45 | 1/2x1 3/4 | OR65.09X3.53X | 0.90 | PAFSF108G | 40 | 40 |
| 2 1/2 | 64 | G 2 | 25 | 101 | 116 | 50.8 | 88.9 | 13.5 | M 12x45 | 1/2x1 3/4 | Standard | 1.30 | PAFSF110G2 | 40 | 40 |
| 2 1/2 | 64 | G 2 1/2 | 25 | 101 | 116 | 50.8 | 88.9 | 13.5 | M 12x45 | 1/2x1 3/4 | OR78.97X3.53X | 1.25 | PAFSF110G | 40 | 40 |
| 3 | 76 | G 2 1/2 | 25 | 124 | 136 | 61.9 | 106.4 | 16.7 | M 16x55 | 5/8x2 1/4 | Standard | 1.86 | PAFSF112G212 | 30 | 30 |
| 3 | 76 | G 3 | 25 | 124 | 136 | 61.9 | 106.4 | 16.7 | M 16x55 | 5/8x2 1/4 | OR94.84X3.53X | 1.49 | PAFSF112G | 30 | 30 |
| 3 1/2 | 89 | G 3 | 25 | 136 | 152 | 69.9 | 120.7 | 16.7 | M 16x55 | 5/8x2 1/4 | Standard | 1.68 | PAFSF114G3 | 30 | 30 |
| 3 1/2 | 89 | G 3 1/2 | 25 | 136 | 152 | 69.9 | 120.7 | 16.7 | M 16x55 | 5/8x2 1/4 | OR107.5X3.53X | 1.59 | PAFSF114G | 30 | 30 |
| 4 | 102 | G 3 1/2 | 25 | 146 | 162 | 77.8 | 130.2 | 16.7 | M 16x55 | 5/8x2 1/4 | Standard | 2.35 | PAFSF116G312 | 30 | 30 |
| 4 | 102 | G 4 | 25 | 146 | 162 | 77.8 | 130.2 | 16.7 | M 16x55 | 5/8x2 1/4 | OR117.1X3.53X | 2.25 | PAFSF116G | 30 | 30 |
| 5 | 127 | G 4 | 25 | 180 | 184 | 92.1 | 152.4 | 16.7 | M 16x55 | 5/8x2 1/4 | Standard | 3.45 | PAFSF118G4 | 30 | 30 |
| 5 | 127 | G 5 | 25 | 180 | 184 | 92.1 | 152.4 | 16.7 | M 16x55 | 5/8x2 1/4 | OR145.6X3.53X | 3.15 | PAFSF118G | 30 | 30 |

6000 PSI Series

| | | | | | | | | | | | | | | | |
|-------|----|----------------|----|-----|-----|------|------|---------|---------|------------|---------------|------|---------------|----|----|
| 1/2 | 13 | G 3/8 | 16 | 46 | 58 | 18.2 | 40.5 | 8.9 | M 08x30 | 5/16x1 1/4 | Standard | 0.25 | PAFSF401G38 | 40 | 40 |
| 1/2 | 13 | G 1/2 | 16 | 46 | 58 | 18.2 | 40.5 | 8.9 | M 08x30 | 5/16x1 1/4 | OR25.07X2.62X | 0.20 | PAFSF401G | 40 | 40 |
| 3/4 | 19 | G 1/2 | 19 | 53 | 71 | 23.8 | 50.8 | 10.6 | M 10x35 | 3/8x1 1/2 | Standard | 0.37 | PAFSF402G12 | 40 | 40 |
| 3/4 | 19 | G 3/4 | 19 | 60 | 71 | 23.8 | 50.8 | 10.6 | M 10x35 | 3/8x1 1/2 | OR32.92X3.53X | 0.36 | PAFSF402G | 40 | 40 |
| 1 | 25 | G 3/4 | 24 | 66 | 80 | 27.8 | 57.2 | 13.3*** | M 12x45 | 7/16x1 1/2 | Standard | 0.64 | PAFSF403G34 | 40 | 40 |
| 1 | 25 | G 1 | 24 | 66 | 80 | 27.8 | 57.2 | 13.3*** | M 12x45 | 7/16x1 1/2 | OR37.7X3.53X | 0.60 | PAFSF403G | 40 | 40 |
| 1 1/4 | 32 | G 1 | 27 | 77 | 94 | 31.8 | 66.6 | 15.0** | M 14x50 | 1/2x1 3/4 | Standard | 0.88 | PAFSF404G1 | 40 | 40 |
| 1 1/4 | 32 | G 1 | 27 | 77 | 94 | 31.8 | 66.6 | 13.3 | M 12x50 | - | Standard | 0.88 | PAFSF404/12G1 | 40 | 40 |
| 1 1/4 | 32 | G 1 1/4 | 27 | 77 | 94 | 31.8 | 66.6 | 15.0** | M 14x50 | 1/2x1 3/4 | OR44.45X3.53X | 0.87 | PAFSF404G | 40 | 40 |
| 1 1/4 | 32 | G 1 1/4 | 27 | 77 | 94 | 31.8 | 66.6 | 13.3 | M 12x50 | - | OR44.45X3.53X | 0.87 | PAFSF404/12G | 40 | 40 |
| 1 1/2 | 38 | G 1 1/4 | 30 | 89 | 103 | 36.5 | 79.3 | 16.7 | M 16x55 | 5/8x2 1/4 | Standard | 1.14 | PAFSF405G114 | 40 | 40 |
| 1 1/2 | 38 | G 1 1/2 | 30 | 89 | 103 | 36.5 | 79.3 | 16.7 | M 16x55 | 5/8x2 1/4 | OR52.39X3.53X | 1.01 | PAFSF405G | 40 | 40 |
| 2 | 51 | G 1 1/2 | 35 | 123 | 135 | 44.5 | 96.8 | 20.6 | M 20x70 | 3/4x2 3/4 | Standard | 2.94 | PAFSF406G112 | 40 | 40 |
| 2 | 51 | G 2 | 35 | 123 | 135 | 44.5 | 96.8 | 20.6 | M 20x70 | 3/4x2 3/4 | OR65.09X3.53X | 2.84 | PAFSF406G | 40 | 40 |

*Please add the suffixes below according to the material/surface required.

| Order code suffixes | | | | | |
|---------------------------------|-----------------------------|----------------------------|--|--|---|
| Material | Suffix surface and material | Example only 4 bolt flange | Example 4 bolt flange incl. metr. bolts and O-ring | Example 4 bolt flange incl. UNC bolts and O-ring | Standard sealing material (no additional suffix needed) |
| Steel, zinc plated, Cr(VI)-free | CF | PAFSF080GCF | PAFSF080GCFM | PAFSF080GCFU | NBR |
| Stainless steel | SS | PAFSF080GSS | PAFSF080GSSM | - | VIT |

 ** DB = 13.3 for UNC Bolts
 *** = 12 for UNC Bolts
 1) Pressure shown = Item deliverable

$$\frac{PN \text{ (bar)}}{10} = PN \text{ (MPa)}$$
 Stainless steel parts may have dimensional deviations. Additional information on request.



PEFF-G SAE 90° 4 bolt flange with BSPP thread

SAE 90° Flange / Female BSPP thread
(ISO 6162-1/-2)

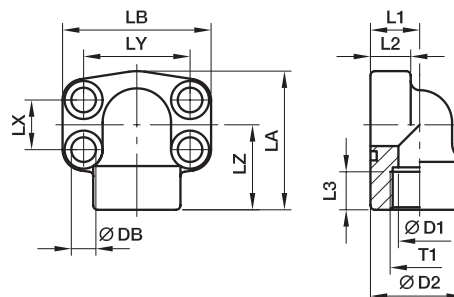

3000 PSI Series

| Nom. flange size | | T1 | D1 | D2 | L1 | L2 | L3 | LA | LB | LX | LY | LZ | DB | Bolt | | Weight (steel) kg/piece | Order code* | PN (bar) ¹⁾ | |
|------------------|----------|----------------|----|------|----|----|----|-----|-----|------|------|----|---------|---------|------------|-------------------------|-----------------|------------------------|-----|
| SAE (in.) | ISO (DN) | | | | | | | | | | | | | (metr.) | (unc.) | | | S | SS |
| 1/2 | 13 | G 1/2 | 13 | 34.0 | 18 | 16 | 16 | 59 | 57 | 17.5 | 38.1 | 36 | 8.9 | M 08x30 | 5/16x1 1/4 | 0.33 | PEFF32G | 348 | 348 |
| 3/4 | 19 | G 3/4 | 19 | 38.5 | 22 | 18 | 19 | 63 | 68 | 22.3 | 47.6 | 38 | 10.6 | M 10x35 | 3/8x1 1/2 | 0.52 | PEFF33G | 348 | 348 |
| 1 | 25 | G 1 | 25 | 44.5 | 28 | 19 | 19 | 68 | 72 | 26.2 | 52.4 | 41 | 10.6 | M 10x35 | 3/8x1 1/2 | 0.64 | PEFF34G | 348 | 348 |
| 1 1/4 | 32 | G 1 1/4 | 31 | 53.5 | 30 | 22 | 22 | 84 | 81 | 30.2 | 58.7 | 50 | 10.6*** | M 10x35 | 7/16x1 1/2 | 0.99 | PEFF35G | 278 | 278 |
| 1 1/2 | 38 | G 1 1/2 | 38 | 62.5 | 36 | 25 | 24 | 97 | 93 | 35.7 | 69.9 | 58 | 13.3 | M 12x45 | 1/2x1 3/4 | 1.42 | PEFF36G | 210 | 210 |
| 2 | 51 | G 2 | 50 | 77.0 | 41 | 25 | 26 | 109 | 105 | 42.9 | 77.8 | 65 | 13.5 | M 12x45 | 1/2x1 3/4 | 2.00 | PEFF38G | 210 | 210 |
| 2 1/2 | 64 | G 2 1/2 | 60 | 89.0 | 50 | 25 | 30 | 127 | 115 | 50.8 | 88.9 | 77 | 13.5 | M 12x45 | 1/2x1 3/4 | 2.90 | PEFF310G | 175 | 175 |

6000 PSI Series

| | | | | | | | | | | | | | | | | | | | |
|-------|----|----------------|----|------|----|----|----|-----|-----|------|------|----|---------|---------|------------|------|-------------------|-----|-----|
| 1/2 | 13 | G 1/2 | 13 | 34.0 | 18 | 16 | 16 | 59 | 57 | 18.2 | 40.5 | 36 | 8.9 | M 08x30 | 5/16x1 1/4 | 0.33 | PEFF62G | 420 | 420 |
| 3/4 | 19 | G 3/4 | 19 | 44.5 | 28 | 20 | 22 | 68 | 72 | 23.8 | 50.8 | 41 | 10.6 | M 10x35 | 3/8x1 1/2 | 0.80 | PEFF63G | 420 | 420 |
| 1 | 25 | G 1 | 25 | 53.5 | 30 | 24 | 24 | 84 | 82 | 27.8 | 57.2 | 50 | 13.3*** | M 12x45 | 7/16x1 1/2 | 1.16 | PEFF64G | 420 | 420 |
| 1 1/4 | 32 | G 1 1/4 | 31 | 62.5 | 36 | 25 | 25 | 97 | 95 | 31.8 | 66.6 | 58 | 15.0** | M 14x50 | 1/2x1 3/4 | 1.66 | PEFF65G | 420 | 420 |
| 1 1/4 | 32 | G 1 1/4 | 31 | 62.5 | 36 | 25 | 25 | 97 | 95 | 31.8 | 66.6 | 58 | 13.3 | M 12x50 | - | 1.66 | PEFF65/12G | 420 | 420 |
| 1 1/2 | 38 | G 1 1/2 | 38 | 62.0 | 41 | 26 | 23 | 109 | 105 | 36.5 | 79.3 | 65 | 16.7 | M 16x55 | 5/8x2 1/4 | 2.24 | PEFF66G | 420 | 420 |
| 2 | 51 | G 2 | 50 | 87.0 | 45 | 35 | 34 | 133 | 134 | 44.5 | 96.8 | 75 | 20.6 | M 20x70 | 3/4x2 3/4 | 3.85 | PEFF68G | 420 | 420 |

**DB = 13.3 for UNC Bolts

***DB = 12 for UNC Bolts

¹⁾Pressure shown = Item deliverable

$$\frac{\text{PN (bar)}}{10} = \text{PN (MPa)}$$

Stainless steel parts may have dimensional deviations. Additional information on request.



*Please add the suffixes below according to the material/surface required.

| Order code suffixes | | | | | |
|---------------------------------|-----------------------------|----------------------------|--|--|---|
| Material | Suffix surface and material | Example only 4 bolt flange | Example 4 bolt flange incl. metr. bolts and O-ring | Example 4 bolt flange incl. UNC bolts and O-ring | Standard sealing material (no additional suffix needed) |
| Steel, zinc plated, Cr(VI)-free | CF | PEFF32GCF | PEFF32GCFM | PEFF32GCFU | NBR |
| Stainless steel | SS | PEFF32GSS | PEFF32GSSM | - | VIT |



SAE Full flanges

PFF-N SAE Straight 4 bolt flange with NPT thread

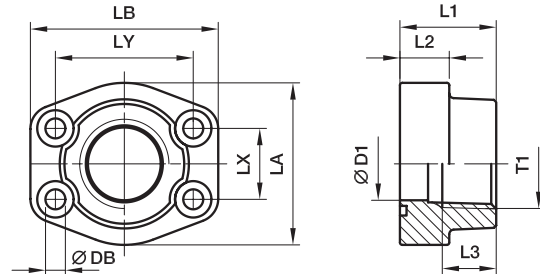
 SAE Flange / Female NPT thread
 (ISO 6162-1/-2) (SAE 476)

3000 PSI Series

| Nom. flange size | | T1 | D1 | L1 | L2 | L3 | LA | LB | LX | LY | DB | Bolts | | Weight (steel) kg/piece | Order code* | PN (bar) ¹⁾ | |
|------------------|----------|-----------|-----|----|----|----|-----|-----|------|-------|---------|---------|------------|-------------------------|-------------|------------------------|-----|
| SAE (in.) | ISO (DN) | | | | | | | | | | | (metr.) | (unc.) | | | S | SS |
| 1/2 | 13 | 3/8 NPT | 13 | 36 | 16 | 15 | 46 | 58 | 17.5 | 38.1 | 8.9 | M 08x30 | 5/16x1 1/4 | 0.25 | PFF32N38 | 345 | 345 |
| 1/2 | 13 | 1/2 NPT | 13 | 36 | 16 | 15 | 46 | 58 | 17.5 | 38.1 | 8.9 | M 08x30 | 5/16x1 1/4 | 0.28 | PFF32N | 345 | 345 |
| 3/4 | 19 | 3/4 NPT | 19 | 36 | 18 | 19 | 49 | 66 | 22.3 | 47.6 | 10.6 | M 10x35 | 3/8x1 1/2 | 0.39 | PFF33N | 345 | 345 |
| 1 | 25 | 1 NPT | 25 | 38 | 18 | 19 | 53 | 71 | 26.2 | 52.4 | 10.6 | M 10x35 | 3/8x1 1/2 | 0.46 | PFF34N | 345 | 345 |
| 1 1/4 | 32 | 1 1/4 NPT | 31 | 41 | 21 | 22 | 69 | 80 | 30.2 | 58.7 | 10.6*** | M 10x40 | 7/16x1 1/2 | 0.66 | PFF35N | 276 | 276 |
| 1 1/2 | 38 | 1 1/2 NPT | 38 | 44 | 25 | 24 | 77 | 94 | 35.7 | 69.9 | 13.3 | M 12x45 | 1/2x1 3/4 | 1.05 | PFF36N | 207 | 207 |
| 2 | 51 | 2 NPT | 50 | 45 | 25 | 26 | 89 | 103 | 42.9 | 77.8 | 13.5 | M 12x45 | 1/2x1 3/4 | 1.19 | PFF38N | 207 | 207 |
| 2 1/2 | 64 | 2 1/2 NPT | 63 | 50 | 25 | 30 | 101 | 115 | 50.8 | 88.9 | 13.5 | M 12x45 | 1/2x1 3/4 | 1.70 | PFF310N | 172 | 172 |
| 3 | 76 | 3 NPT | 73 | 50 | 27 | 34 | 124 | 135 | 61.9 | 106.4 | 16.7 | M 16x55 | 5/8x2 1/4 | 2.22 | PFF312N | 138 | 138 |
| 3 1/2 | 89 | 3 1/2 NPT | 89 | 50 | 27 | 36 | 136 | 152 | 69.9 | 120.7 | 16.7 | M 16x55 | 5/8x2 1/4 | 2.40 | PFF314N | 34 | 34 |
| 4 | 102 | 4 NPT | 99 | 50 | 27 | 36 | 146 | 162 | 77.8 | 130.2 | 16.7 | M 16x55 | 5/8x2 1/4 | 2.71 | PFF316N | 34 | 34 |
| 5 | 127 | 5 NPT | 120 | 50 | 28 | 36 | 180 | 184 | 92.1 | 152.4 | 16.7 | M 16x55 | 5/8x2 1/4 | 3.25 | PFF320N | 34 | 34 |

6000 PSI Series

| | | | | | | | | | | | | | | | | | |
|-------|----|-----------|----|----|----|----|-----|-----|------|-------|---------|----------|------------|------|-----------|-----|-----|
| 1/2 | 13 | 3/8 NPT | 13 | 36 | 16 | 15 | 46 | 58 | 18.2 | 40.5 | 8.9 | M 08x30 | 5/16x1 1/4 | 0.26 | PFF62N38 | 420 | 420 |
| 1/2 | 13 | 1/2 NPT | 13 | 36 | 16 | 15 | 46 | 58 | 18.2 | 40.5 | 8.9 | M 08x30 | 5/16x1 1/4 | 0.29 | PFF62N | 420 | 420 |
| 3/4 | 19 | 3/4 NPT | 19 | 36 | 19 | 22 | 53 | 71 | 23.8 | 50.8 | 10.6 | M 10x35 | 3/8x1 1/2 | 0.50 | PFF63N | 420 | 420 |
| 1 | 25 | 1 NPT | 25 | 44 | 24 | 24 | 69 | 80 | 27.8 | 57.2 | 13.3*** | M 12x45 | 7/16x1 1/2 | 0.76 | PFF64N | 420 | 420 |
| 1 1/4 | 32 | 1 1/4 NPT | 31 | 44 | 27 | 25 | 77 | 94 | 31.8 | 66.6 | 15.0** | M 14x50 | 1/2x1 3/4 | 1.20 | PFF65N | 420 | 420 |
| 1 1/4 | 32 | 1 1/4 NPT | 31 | 44 | 27 | 25 | 77 | 94 | 31.8 | 66.6 | 13.3 | M 12x50 | - | 1.20 | PFF65/12N | 420 | 420 |
| 1 1/2 | 38 | 1 1/2 NPT | 38 | 51 | 30 | 24 | 89 | 106 | 36.5 | 79.3 | 16.7 | M 16x55 | 5/8x2 1/4 | 1.91 | PFF66N | 420 | 420 |
| 2 | 51 | 2 NPT | 50 | 70 | 37 | 33 | 116 | 135 | 44.5 | 96.8 | 20.6 | M 20x70 | 3/4x2 3/4 | 3.37 | PFF68N | 420 | 420 |
| 2 1/2 | 64 | 2 1/2 NPT | 63 | 75 | 45 | 35 | 150 | 166 | 58.7 | 123.8 | 25.0 | M 24x90 | - | 3.05 | PFF610N | 420 | 420 |
| 3 | 76 | 3 NPT | 73 | 90 | 55 | 40 | 178 | 208 | 71.4 | 152.4 | 31.0 | M 30x110 | - | 3.45 | PFF612N | 420 | 420 |

**DB = 13.3 for UNC Bolts

***DB = 12 for UNC Bolts

¹⁾Pressure shown = Item deliverable

 $\frac{\text{PN (bar)}}{10} = \text{PN (MPa)}$

Stainless steel parts may have dimensional deviations. Additional information on request.

*Please add the suffixes below according to the material/surface required.

| Order code suffixes | | | | | |
|---------------------|-----------------------------|----------------------------|--|--|---|
| Material | Suffix surface and material | Example only 4 bolt flange | Example 4 bolt flange incl. metr. bolts and O-ring | Example 4 bolt flange incl. UNC bolts and O-ring | Standard sealing material (no additional suffix needed) |
| Steel, oil dipped | S | PFF32N38S | PFF32N38SM | PFF32N38SU | NBR |
| Stainless steel | SS | PFF32N38SS | PFF32N38SSM | - | VIT |



PCFF-N SAE Straight 4 bolt flange with NPT thread

SAE Counter flange / Female NPT thread
(ISO 6162-1/-2) (SAE 476)

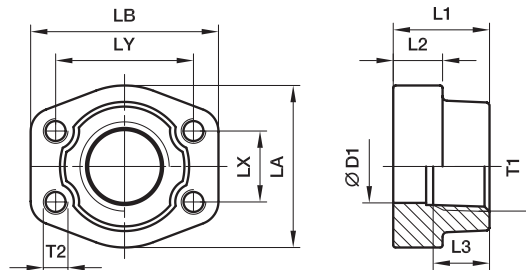

3000 PSI Series

| Nom. flange size | | T1 | D1 | L1 | L2 | L3 | LA | LB | LX | LY | T2 | | Weight (steel) kg/piece | Order code* | PN (bar) ¹⁾ | |
|------------------|----------|-----------|-----|----|----|----|-----|-----|------|-------|---------|--------|-------------------------|-------------|------------------------|-----|
| SAE (in.) | ISO (DN) | | | | | | | | | | (metr.) | (unc.) | | | S | SS |
| 1/2 | 13 | 3/8 NPT | 13 | 36 | 16 | 19 | 47 | 57 | 17.5 | 38.1 | M 8 | 5/16 | 0.25 | PCFF32N38 | 345 | 345 |
| 1/2 | 13 | 1/2 NPT | 13 | 36 | 16 | 19 | 47 | 57 | 17.5 | 38.1 | M 8 | 5/16 | 0.28 | PCFF32N | 345 | 345 |
| 3/4 | 19 | 3/4 NPT | 19 | 36 | 18 | 19 | 49 | 66 | 22.3 | 47.6 | M10 | 3/8 | 0.44 | PCFF33N | 345 | 345 |
| 1 | 25 | 1 NPT | 25 | 38 | 18 | 19 | 53 | 71 | 26.2 | 52.4 | M10 | 3/8 | 0.53 | PCFF34N | 345 | 345 |
| 1 1/4 | 32 | 1 1/4 NPT | 31 | 41 | 21 | 22 | 69 | 80 | 30.2 | 58.7 | M10 | 7/16 | 0.66 | PCFF35N | 276 | 276 |
| 1 1/2 | 38 | 1 1/2 NPT | 38 | 44 | 25 | 24 | 77 | 94 | 35.7 | 69.9 | M12 | 1/2 | 1.05 | PCFF36N | 207 | 207 |
| 2 | 51 | 2 NPT | 50 | 45 | 25 | 26 | 89 | 103 | 42.9 | 77.8 | M12 | 1/2 | 1.19 | PCFF38N | 207 | 207 |
| 2 1/2 | 64 | 2 1/2 NPT | 63 | 50 | 25 | 30 | 101 | 115 | 50.8 | 88.9 | M12 | 1/2 | 1.40 | PCFF310N | 172 | 172 |
| 3 | 76 | 3 NPT | 73 | 50 | 27 | 30 | 124 | 135 | 61.9 | 106.4 | M16 | 5/8 | 2.15 | PCFF312N | 138 | 138 |
| 3 1/2 | 89 | 3 1/2 NPT | 89 | 50 | 27 | 30 | 136 | 152 | 69.9 | 120.7 | M16 | 5/8 | 2.40 | PCFF314N | 34 | 34 |
| 4 | 102 | 4 NPT | 99 | 50 | 27 | 30 | 146 | 162 | 77.8 | 130.2 | M16 | 5/8 | 2.85 | PCFF316N | 34 | 34 |
| 5 | 127 | 5 NPT | 120 | 50 | 28 | 30 | 180 | 184 | 92.1 | 152.4 | M16 | 5/8 | 3.25 | PCFF320N | 34 | 34 |

6000 PSI Series

| | | | | | | | | | | | | | | | | |
|-------|----|-----------|----|----|----|----|-----|-----|------|-------|-----|------|------|------------|-----|-----|
| 1/2 | 13 | 3/8 NPT | 13 | 36 | 16 | 19 | 47 | 57 | 18.2 | 40.5 | M 8 | 5/16 | 0.26 | PCFF62N38 | 420 | 420 |
| 1/2 | 13 | 1/2 NPT | 13 | 36 | 16 | 19 | 47 | 57 | 18.2 | 40.5 | M 8 | 5/16 | 0.29 | PCFF62N | 420 | 420 |
| 3/4 | 19 | 3/4 NPT | 19 | 36 | 19 | 22 | 53 | 71 | 23.8 | 50.8 | M10 | 3/8 | 0.50 | PCFF63N | 420 | 420 |
| 1 | 25 | 1 NPT | 25 | 44 | 24 | 24 | 69 | 80 | 27.8 | 57.2 | M12 | 7/16 | 0.76 | PCFF64N | 420 | 420 |
| 1 1/4 | 32 | 1 1/4 NPT | 31 | 44 | 27 | 25 | 77 | 94 | 31.8 | 66.6 | M14 | 1/2 | 1.20 | PCFF65N | 420 | 420 |
| 1 1/4 | 32 | 1 1/4 NPT | 31 | 44 | 27 | 25 | 77 | 94 | 31.8 | 66.6 | M12 | - | 1.20 | PCFF65/12N | 420 | 420 |
| 1 1/2 | 38 | 1 1/2 NPT | 38 | 51 | 30 | 28 | 89 | 106 | 36.5 | 79.3 | M16 | 5/8 | 1.65 | PCFF66N | 420 | 420 |
| 2 | 51 | 2 NPT | 50 | 70 | 37 | 33 | 116 | 135 | 44.5 | 96.8 | M20 | 3/4 | 2.45 | PCFF68N | 420 | 420 |
| 2 1/2 | 64 | 2 1/2 NPT | 63 | 75 | 45 | 35 | 150 | 166 | 58.7 | 123.8 | M24 | - | 3.05 | PCFF610N | 420 | 420 |
| 3 | 76 | 3 NPT | 73 | 90 | 55 | 40 | 178 | 208 | 71.4 | 152.4 | M30 | - | 3.45 | PCFF612N | 420 | 420 |

¹⁾ Pressure shown = Item deliverable

PN (bar) = PN (MPa)
10

Stainless steel parts may have dimensional deviations. Additional information on request.

*Please add the suffixes below according to the material/surface required.

| Order code suffixes | | | | |
|---------------------|-----------------------------|--|--|---|
| Material | Suffix surface and material | Example 4 bolt flange with metr. threads | Example 4 bolt flange with UNC threads | Standard sealing material (no additional suffix needed) |
| Steel, oil dipped | S | PCFF32N38SM | PCFF32N38SU | NBR |
| Stainless steel | SS | PCFF32N38SSM | PCFF32N38SSU | VIT |



SAE Full flanges

PEFF-N SAE 90° 4 bolt flange with NPT thread

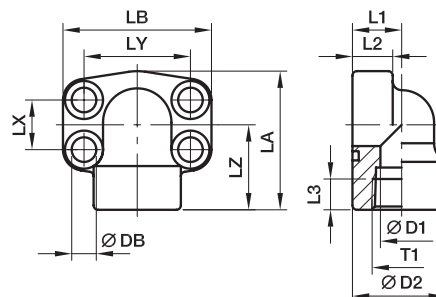
 SAE 90° Flange / Female NPT thread
 (ISO 6162-1/-2) (SAE 476)

3000 PSI Series

| Nom. flange size | | T1 | D1 | D2 | L1 | L2 | L3 | LA | LB | LX | LY | LZ | DB | Bolts | | Weight (steel) kg/piece | Order code* | PN (bar) ¹⁾ | |
|------------------|----------|-----------|----|------|----|----|----|-----|-----|------|------|----|---------|---------|------------|-------------------------|-------------|------------------------|-----|
| SAE (in.) | ISO (DN) | | | | | | | | | | | | | (metr.) | (unc.) | | | S | SS |
| 1/2 | 13 | 1/2 NPT | 13 | 34.0 | 18 | 16 | 16 | 59 | 56 | 17.5 | 38.1 | 36 | 8.9 | M 08×30 | 5/16×1 1/4 | 0.35 | PEFF32N | 348 | 348 |
| 3/4 | 19 | 3/4 NPT | 19 | 38.5 | 22 | 18 | 19 | 63 | 68 | 22.3 | 47.6 | 38 | 10.6 | M 10×35 | 3/8×1 1/2 | 0.55 | PEFF33N | 348 | 348 |
| 1 | 25 | 1 NPT | 25 | 44.5 | 28 | 19 | 19 | 68 | 74 | 26.2 | 52.4 | 41 | 10.6 | M 10×35 | 3/8×1 1/2 | 0.80 | PEFF34N | 348 | 348 |
| 1 1/4 | 32 | 1 1/4 NPT | 31 | 53.5 | 30 | 22 | 22 | 84 | 81 | 30.2 | 58.7 | 50 | 10.6*** | M 10×35 | 7/16×1 1/2 | 1.30 | PEFF35N | 278 | 278 |
| 1 1/2 | 38 | 1 1/2 NPT | 38 | 62.5 | 36 | 25 | 24 | 97 | 95 | 35.7 | 69.9 | 58 | 13.3 | M 12×45 | 1/2×1 3/4 | 1.60 | PEFF36N | 210 | 210 |
| 2 | 51 | 2 NPT | 50 | 77.0 | 41 | 25 | 26 | 109 | 105 | 42.9 | 77.8 | 65 | 13.5 | M 12×45 | 1/2×1 3/4 | 2.00 | PEFF38N | 210 | 210 |
| 2 1/2 | 64 | 2 1/2 NPT | 60 | 89.0 | 50 | 25 | 30 | 127 | 115 | 50.8 | 88.9 | 77 | 13.5 | M 12×45 | 1/2×1 3/4 | 2.40 | PEFF310N | 175 | 175 |

6000 PSI Series

| | | | | | | | | | | | | | | | | | | | |
|-------|----|-----------|----|------|----|----|----|-----|-----|------|------|----|---------|---------|------------|------|------------|-----|-----|
| 1/2 | 13 | 1/2 NPT | 13 | 34.0 | 18 | 16 | 16 | 59 | 56 | 18.2 | 40.5 | 36 | 8.9 | M 08×30 | 5/16×1 1/4 | 0.35 | PEFF62N | 420 | 420 |
| 3/4 | 19 | 3/4 NPT | 19 | 44.5 | 28 | 20 | 22 | 68 | 72 | 23.8 | 50.8 | 41 | 10.6 | M 10×35 | 3/8×1 1/2 | 0.80 | PEFF63N | 420 | 420 |
| 1 | 25 | 1 NPT | 25 | 53.5 | 30 | 24 | 24 | 84 | 82 | 27.8 | 57.2 | 50 | 13.3*** | M 12×45 | 7/16×1 1/2 | 1.30 | PEFF64N | 420 | 420 |
| 1 1/4 | 32 | 1 1/4 NPT | 31 | 62.5 | 36 | 25 | 25 | 97 | 95 | 31.8 | 66.6 | 58 | 15.0** | M 14×50 | 1/2×1 3/4 | 1.60 | PEFF65N | 420 | 420 |
| 1 1/4 | 32 | 1 1/4 NPT | 31 | 62.5 | 36 | 25 | 25 | 97 | 95 | 31.8 | 66.6 | 58 | 13.3 | M 12×50 | – | 1.60 | PEFF65/12N | 420 | 420 |
| 1 1/2 | 38 | 1 1/2 NPT | 38 | 77.0 | 51 | 26 | 28 | 109 | 110 | 36.5 | 79.3 | 65 | 16.7 | M 16×55 | 5/8×2 1/4 | 2.00 | PEFF66N | 420 | 420 |
| 2 | 51 | 2 NPT | 50 | 87.0 | 45 | 35 | 34 | 133 | 134 | 44.5 | 96.8 | 75 | 20.6 | M 20×70 | 3/4×2 3/4 | 2.50 | PEFF68N | 420 | 420 |

**DB = 13.3 for UNC Bolts

***DB = 12 for UNC Bolts

¹⁾Pressure shown = Item deliverable

$$\frac{\text{PN (bar)}}{10} = \text{PN (MPa)}$$

Stainless steel parts may have dimensional deviations. Additional information on request.

*Please add the suffixes below according to the material/surface required.

| Order code suffixes | | | | | |
|---------------------|-----------------------------|----------------------------|--|--|---|
| Material | Suffix surface and material | Example only 4 bolt flange | Example 4 bolt flange incl. metr. bolts and O-ring | Example 4 bolt flange incl. UNC bolts and O-ring | Standard sealing material (no additional suffix needed) |
| Steel, oil dipped | S | PEFF32NS | PEFF32NSM | PEFF32NSU | NBR |
| Stainless steel | SS | PEFF32NSS | PEFF32NSSM | – | VIT |

PFF-..S/L SAE Straight 4 bolt flange with EO 24° cone end

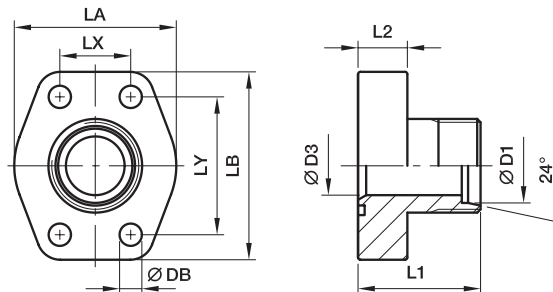
 SAE Flange / EO 24° cone end
 (ISO 6162-1/-2)

3000 PSI Series

| Nom. flange size | | D1 ²⁾ | | | | | | | | | Bolts | | Weight (steel) kg/piece | Order code* | PN (bar) ¹⁾ | |
|------------------|----------|------------------|----|----|----|----|-----|------|------|---------|---------|------------|----------------------------|-------------|------------------------|-----|
| SAE (in.) | ISO (DN) | | D3 | L1 | L2 | LA | LB | LX | LY | DB | (metr.) | (unc.) | | | CF | SS |
| 1/2 | 13 | 12S | 8 | 47 | 16 | 42 | 57 | 17.5 | 38.1 | 8.9 | M 08x30 | 5/16x1 1/4 | 0.27 | PFF32/12S | 348 | 348 |
| 1/2 | 13 | 15L | 11 | 47 | 16 | 42 | 57 | 17.5 | 38.1 | 8.9 | M 08x30 | 5/16x1 1/4 | 0.27 | PFF32/15L | 348 | 315 |
| 1/2 | 13 | 16S | 12 | 47 | 16 | 42 | 57 | 17.5 | 38.1 | 8.9 | M 08x30 | 5/16x1 1/4 | 0.27 | PFF32/16S | 348 | 348 |
| 3/4 | 19 | 16S | 12 | 52 | 18 | 50 | 66 | 22.3 | 47.6 | 10.6 | M 10x35 | 3/8x1 1/2 | 0.42 | PFF33/16S | 348 | 348 |
| 3/4 | 19 | 20S | 16 | 52 | 18 | 50 | 66 | 22.3 | 47.6 | 10.6 | M 10x35 | 3/8x1 1/2 | 0.45 | PFF33/20S | 348 | 348 |
| 3/4 | 19 | 22L | 18 | 52 | 18 | 50 | 66 | 22.3 | 47.6 | 10.6 | M 10x35 | 3/8x1 1/2 | 0.44 | PFF33/22L | 250 | 160 |
| 1 | 25 | 20S | 16 | 55 | 18 | 55 | 71 | 26.2 | 52.4 | 10.6 | M 10x35 | 3/8x1 1/2 | 0.54 | PFF34/20S | 348 | 348 |
| 1 | 25 | 25S | 20 | 55 | 18 | 55 | 71 | 26.2 | 52.4 | 10.6 | M 10x35 | 3/8x1 1/2 | 0.55 | PFF34/25S | 348 | 348 |
| 1 | 25 | 28L | 23 | 55 | 18 | 55 | 71 | 26.2 | 52.4 | 10.6 | M 10x35 | 3/8x1 1/2 | 0.53 | PFF34/28L | 250 | 160 |
| 1 1/4 | 32 | 25S | 20 | 60 | 21 | 66 | 80 | 30.2 | 58.7 | 10.6*** | M 10x40 | 7/16x1 1/2 | 0.83 | PFF35/25S | 278 | 278 |
| 1 1/4 | 32 | 30S | 25 | 60 | 21 | 66 | 80 | 30.2 | 58.7 | 10.6*** | M 10x40 | 7/16x1 1/2 | 0.85 | PFF35/30S | 278 | 278 |
| 1 1/4 | 32 | 35L | 30 | 60 | 21 | 66 | 80 | 30.2 | 58.7 | 10.6*** | M 10x40 | 7/16x1 1/2 | 0.79 | PFF35/35L | 278 | 278 |
| 1 1/2 | 38 | 35L | 30 | 70 | 25 | 77 | 94 | 35.7 | 69.9 | 13.3 | M 12x45 | 1/2x1 3/4 | 1.25 | PFF36/35L | 210 | 210 |
| 1 1/2 | 38 | 38S | 32 | 70 | 25 | 77 | 94 | 35.7 | 69.9 | 13.3 | M 12x45 | 1/2x1 3/4 | 1.30 | PFF36/38S | 210 | 210 |
| 1 1/2 | 38 | 42L | 36 | 70 | 25 | 77 | 94 | 35.7 | 69.9 | 13.3 | M 12x45 | 1/2x1 3/4 | 1.21 | PFF36/42L | 210 | 210 |
| 2 | 51 | 38S | 32 | 72 | 25 | 90 | 103 | 42.9 | 77.8 | 13.3 | M 12x45 | 1/2x1 3/4 | 1.80 | PFF38/38S | 210 | 210 |
| 2 | 51 | 42L | 36 | 72 | 25 | 90 | 103 | 42.9 | 77.8 | 13.3 | M 12x45 | 1/2x1 3/4 | 1.60 | PFF38/42L | 210 | 210 |

6000 PSI Series

| | | | | | | | | | | | | | | | | |
|-------|----|-----|----|----|----|----|-----|------|------|---------|---------|------------|------|--------------|-----|-----|
| 1/2 | 13 | 12S | 8 | 47 | 16 | 47 | 57 | 18.2 | 40.5 | 8.9 | M 08x30 | 5/16x1 1/4 | 0.27 | PFF62/12S | 420 | 420 |
| 1/2 | 13 | 14S | 10 | 47 | 16 | 47 | 57 | 18.2 | 40.5 | 8.9 | M 08x30 | 5/16x1 1/4 | 0.27 | PFF62/14S | 420 | 420 |
| 1/2 | 13 | 16S | 12 | 47 | 16 | 47 | 57 | 18.2 | 40.5 | 8.9 | M 08x30 | 5/16x1 1/4 | 0.27 | PFF62/16S | 420 | 420 |
| 3/4 | 19 | 16S | 12 | 52 | 18 | 53 | 71 | 23.8 | 50.8 | 10.6 | M 10x35 | 3/8x1 1/2 | 0.50 | PFF63/16S | 420 | 420 |
| 3/4 | 19 | 20S | 16 | 52 | 18 | 53 | 71 | 23.8 | 50.8 | 10.6 | M 10x35 | 3/8x1 1/2 | 0.51 | PFF63/20S | 420 | 400 |
| 3/4 | 19 | 22L | 18 | 52 | 18 | 53 | 71 | 23.8 | 50.8 | 10.6 | M 10x35 | 3/8x1 1/2 | 0.51 | PFF63/22L | 250 | 160 |
| 1 | 25 | 20S | 16 | 60 | 21 | 66 | 80 | 27.8 | 57.2 | 13.3*** | M 12x45 | 7/16x1 1/2 | 0.80 | PFF64/20S | 420 | 400 |
| 1 | 25 | 25S | 20 | 60 | 21 | 66 | 80 | 27.8 | 57.2 | 13.3*** | M 12x45 | 7/16x1 1/2 | 0.80 | PFF64/25S | 420 | 400 |
| 1 | 25 | 28L | 23 | 60 | 21 | 66 | 80 | 27.8 | 57.2 | 13.3*** | M 12x45 | 7/16x1 1/2 | 0.75 | PFF64/28L | 250 | 160 |
| 1 1/4 | 32 | 25S | 20 | 68 | 24 | 78 | 94 | 31.8 | 66.6 | 15.0** | M 14x50 | 1/2x1 3/4 | 1.15 | PFF65/25S | 420 | 400 |
| 1 1/4 | 32 | 25S | 20 | 68 | 24 | 78 | 94 | 31.8 | 66.6 | 13.3 | M 12x50 | - | 1.15 | PFF65/12/25S | 420 | 400 |
| 1 1/4 | 32 | 30S | 25 | 68 | 24 | 78 | 94 | 31.8 | 66.6 | 15.0** | M 14x50 | 1/2x1 3/4 | 1.18 | PFF65/30S | 420 | 400 |
| 1 1/4 | 32 | 30S | 25 | 68 | 24 | 78 | 94 | 31.8 | 66.6 | 13.3 | M 12x50 | - | 1.18 | PFF65/12/30S | 420 | 400 |
| 1 1/4 | 32 | 35L | 30 | 68 | 24 | 78 | 94 | 31.8 | 66.6 | 15.0** | M 14x50 | 1/2x1 3/4 | 1.15 | PFF65/35L | 250 | 160 |
| 1 1/4 | 32 | 35L | 30 | 68 | 24 | 78 | 94 | 31.8 | 66.6 | 13.3 | M 12x50 | - | 1.15 | PFF65/12/35L | 250 | 160 |
| 1 1/4 | 32 | 38S | 32 | 68 | 24 | 78 | 94 | 31.8 | 66.6 | 15.0** | M 14x50 | 1/2x1 3/4 | 1.28 | PFF65/38S | 420 | 315 |
| 1 1/4 | 32 | 38S | 32 | 68 | 24 | 78 | 94 | 31.8 | 66.6 | 13.3 | M 12x50 | - | 1.28 | PFF65/12/38S | 420 | 315 |
| 1 1/2 | 38 | 35L | 25 | 72 | 27 | 90 | 106 | 36.5 | 79.3 | 16.7 | M 16x55 | 5/8x2 1/4 | 1.60 | PFF66/35L | 250 | 160 |
| 1 1/2 | 38 | 38S | 32 | 72 | 27 | 90 | 106 | 36.5 | 79.3 | 16.7 | M 16x55 | 5/8x2 1/4 | 1.70 | PFF66/38S | 315 | 315 |
| 1 1/2 | 38 | 42L | 36 | 72 | 27 | 90 | 106 | 36.5 | 79.3 | 16.7 | M 16x55 | 5/8x2 1/4 | 1.60 | PFF66/42L | 250 | 160 |

²⁾ L = light series; S = heavy series

Delivery without nut and ring.
Information on ordering complete fittings
or alternative sealing materials see page N12.
****DB = 13.3 for UNC Bolts**
*****DB = 12 for UNC Bolts**

*Please add the suffixes below according to the material/surface required.

Stainless steel parts may have dimensional deviations.
Additional information on request.
¹⁾ Pressure shown = Item deliverable

| Order code suffixes | | | | | |
|---------------------------------|-----------------------------|----------------------------|--|--|---|
| Material | Suffix surface and material | Example only 4 bolt flange | Example 4 bolt flange incl. metr. bolts and O-ring | Example 4 bolt flange incl. UNC bolts and O-ring | Standard sealing material (no additional suffix needed) |
| Steel, zinc plated, Cr(VI)-free | CF | PF32/12SCF | PFF32/12SOMDCFM | PFF32/12SOMDCFU | NBR |
| Stainless steel | SS | PFF32/12S-SS | PFF32/12SOMDSSM | - | VIT |

$$\frac{\text{PN (bar)}}{10} = \text{PN (MPa)}$$



SAE Full flanges

PAFG-90M SAE 90° 4 bolt flange with EO 24° cone end

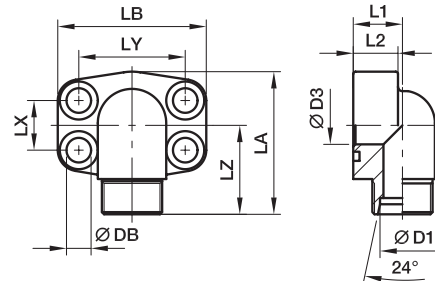
 SAE 90° Flange / EO 24° cone end
(ISO 6162-1/-2)

3000 PSI Series

| Nom. flange size | | D1 ²⁾ | D3 | L1 | L2 | LA | LB | LX | LY | LZ | DB | Bolts | | Weight (steel) kg/piece | Order code* | PN (bar ¹⁾) | |
|------------------|----------|------------------|----|----|----|----|----|------|------|----|---------|---------|------------|-------------------------|----------------|-------------------------|-----|
| SAE (in.) | ISO (DN) | | | | | | | | | | | (metr.) | (unc.) | | | CF | SS |
| 1/2 | 13 | 12S | 8 | 18 | 16 | 60 | 57 | 17.5 | 38.1 | 36 | 8.9 | M 08×30 | 5/16×1 1/4 | 0.31 | PAFG080/90M12S | 348 | 348 |
| 1/2 | 13 | 15L | 11 | 18 | 16 | 60 | 57 | 17.5 | 38.1 | 36 | 8.9 | M 08×30 | 5/16×1 1/4 | 0.30 | PAFG080/90M15L | 348 | 315 |
| 1/2 | 13 | 16S | 12 | 18 | 16 | 60 | 57 | 17.5 | 38.1 | 36 | 8.9 | M 08×30 | 5/16×1 1/4 | 0.30 | PAFG080/90M16S | 348 | 348 |
| 3/4 | 19 | 16S | 12 | 22 | 18 | 63 | 66 | 22.3 | 47.6 | 38 | 10.6 | M 10×35 | 3/8×1 1/2 | 0.48 | PAFG100/90M16S | 348 | 348 |
| 3/4 | 19 | 20S | 16 | 22 | 18 | 63 | 66 | 22.3 | 47.6 | 38 | 10.6 | M 10×35 | 3/8×1 1/2 | 0.44 | PAFG100/90M20S | 348 | 348 |
| 3/4 | 19 | 22L | 18 | 22 | 18 | 63 | 66 | 22.3 | 47.6 | 38 | 10.6 | M 10×35 | 3/8×1 1/2 | 0.45 | PAFG100/90M22L | 250 | 160 |
| 1 | 25 | 20S | 16 | 28 | 19 | 69 | 72 | 26.2 | 52.4 | 42 | 10.6 | M 10×35 | 3/8×1 1/2 | 0.68 | PAFG102/90M20S | 348 | 348 |
| 1 | 25 | 25S | 20 | 28 | 19 | 69 | 72 | 26.2 | 52.4 | 42 | 10.6 | M 10×35 | 3/8×1 1/2 | 0.64 | PAFG102/90M25S | 348 | 348 |
| 1 | 25 | 28L | 23 | 28 | 19 | 69 | 72 | 26.2 | 52.4 | 42 | 10.6 | M 10×35 | 3/8×1 1/2 | 0.62 | PAFG102/90M28L | 250 | 160 |
| 1 1/4 | 32 | 25S | 20 | 30 | 22 | 84 | 80 | 30.2 | 58.7 | 50 | 10.6*** | M 10×40 | 7/16×1 1/2 | 1.05 | PAFG104/90M25S | 278 | 278 |
| 1 1/4 | 32 | 30S | 25 | 30 | 22 | 84 | 80 | 30.2 | 58.7 | 50 | 10.6*** | M 10×40 | 7/16×1 1/2 | 1.02 | PAFG104/90M30S | 278 | 278 |
| 1 1/4 | 32 | 35L | 30 | 30 | 22 | 84 | 80 | 30.2 | 58.7 | 50 | 10.6*** | M 10×40 | 7/16×1 1/2 | 0.94 | PAFG104/90M35L | 278 | 278 |
| 1 1/2 | 38 | 35L | 30 | 36 | 25 | 88 | 94 | 35.7 | 69.9 | 58 | 13.3 | M 12×45 | 1/2×1 3/4 | 1.51 | PAFG106/90M35L | 210 | 210 |
| 1 1/2 | 38 | 38S | 32 | 36 | 25 | 88 | 94 | 35.7 | 69.9 | 58 | 13.3 | M 12×45 | 1/2×1 3/4 | 1.55 | PAFG106/90M38S | 210 | 210 |
| 1 1/2 | 38 | 42L | 36 | 36 | 25 | 88 | 94 | 35.7 | 69.9 | 58 | 13.3 | M 12×45 | 1/2×1 3/4 | 1.42 | PAFG106/90M42L | 210 | 210 |

6000 PSI Series

| | | | | | | | | | | | | | | | | | |
|-------|----|-----|-------|----|----|-----|-----|------|------|----|---------|---------|------------|------|-------------------|-----|-----|
| 1/2 | 13 | 12S | 8 | 20 | 16 | 60 | 57 | 18.2 | 40.5 | 36 | 8.9 | M 08×30 | 5/16×1 1/4 | 0.31 | PAFG401/90M12S | 420 | 420 |
| 1/2 | 13 | 14S | 10 | 20 | 16 | 60 | 57 | 18.2 | 40.5 | 36 | 8.9 | M 08×30 | 5/16×1 1/4 | 0.30 | PAFG401/90M14S | 420 | 420 |
| 1/2 | 13 | 16S | 12 | 20 | 16 | 60 | 57 | 18.2 | 40.5 | 36 | 8.9 | M 08×30 | 5/16×1 1/4 | 0.30 | PAFG401/90M16S | 420 | 420 |
| 3/4 | 19 | 16S | 12 | 26 | 22 | 68 | 72 | 23.8 | 50.8 | 41 | 10.6 | M 10×40 | 3/8×1 1/2 | 0.68 | PAFG402/90M16S | 420 | 420 |
| 3/4 | 19 | 20S | 16 | 26 | 22 | 77 | 72 | 23.8 | 50.8 | 50 | 10.6 | M 10×40 | 3/8×1 1/2 | 0.68 | PAFG402/90M20S | 420 | 400 |
| 3/4 | 19 | 22L | 18 | 26 | 22 | 68 | 72 | 23.8 | 50.8 | 41 | 10.6 | M 10×40 | 3/8×1 1/2 | 0.66 | PAFG402/90M22L | 250 | 160 |
| 1 | 25 | 20S | 16 | 30 | 24 | 83 | 80 | 27.8 | 57.2 | 50 | 13.3*** | M 12×45 | 7/16×1 1/2 | 1.11 | PAFG403/90M20S | 420 | 400 |
| 1 | 25 | 25S | 20 | 30 | 24 | 83 | 80 | 27.8 | 57.2 | 50 | 13.3*** | M 12×45 | 7/16×1 1/2 | 1.08 | PAFG403/90M25S | 420 | 400 |
| 1 | 25 | 28L | 23 | 30 | 24 | 83 | 80 | 27.8 | 57.2 | 50 | 13.3*** | M 12×45 | 7/16×1 1/2 | 1.05 | PAFG403/90M28L | 250 | 160 |
| 1 1/4 | 32 | 25S | 20 | 36 | 25 | 97 | 94 | 31.8 | 66.6 | 58 | 15.0** | M 14×50 | 1/2×1 3/4 | 1.70 | PAFG404/90M25S | 420 | 400 |
| 1 1/4 | 32 | 25S | 20 | 36 | 25 | 97 | 94 | 31.8 | 66.6 | 58 | 13.3 | M 12×50 | - | 1.70 | PAFG404/12/90M25S | 420 | 400 |
| 1 1/4 | 32 | 30S | 25 | 36 | 25 | 97 | 94 | 31.8 | 66.6 | 58 | 15.0** | M 14×50 | 1/2×1 3/4 | 1.45 | PAFG404/90M30S | 420 | 400 |
| 1 1/4 | 32 | 30S | 25 | 36 | 25 | 97 | 94 | 31.8 | 66.6 | 58 | 13.3 | M 12×50 | - | 1.45 | PAFG404/12/90M30S | 420 | 400 |
| 1 1/4 | 32 | 35L | 30 | 36 | 25 | 97 | 94 | 31.8 | 66.6 | 58 | 15.0** | M 14×50 | 1/2×1 3/4 | 1.50 | PAFG404/90M35L | 250 | 160 |
| 1 1/4 | 32 | 35L | 30 | 36 | 25 | 97 | 94 | 31.8 | 66.6 | 58 | 13.3 | M 12×50 | - | 1.50 | PAFG404/12/90M35L | 250 | 160 |
| 1 1/2 | 38 | 35L | 25 | 41 | 26 | 110 | 105 | 36.5 | 79.3 | 65 | 16.7 | M 16×55 | 5/8×2 1/4 | 2.44 | PAFG405/90M35L | 250 | 160 |
| 1 1/2 | 38 | 38S | 32/38 | 41 | 26 | 110 | 105 | 36.5 | 79.3 | 65 | 16.7 | M 16×55 | 5/8×2 1/4 | 2.38 | PAFG405/90M38S | 315 | 315 |
| 1 1/2 | 38 | 42L | 36 | 41 | 26 | 110 | 105 | 36.5 | 79.3 | 65 | 16.7 | M 16×55 | 5/8×2 1/4 | 2.37 | PAFG405/90M42L | 250 | 160 |

²⁾ L = light series; S = heavy series

Delivery without nut and ring.

** DB = 13.3 for UNC Bolts

Information on ordering complete fittings

***DB = 12 for UNC Bolts

or alternative sealing materials see page N12.
¹⁾ Pressure shown = Item deliverable

*Please add the suffixes below according to the material/surface required.

Stainless steel parts may have dimensional deviations.
Additional information on request.

$$\frac{PN(\text{bar})}{10} = PN(\text{MPa})$$

| Order code suffixes | | | | | |
|---------------------------------|-----------------------------|----------------------------|--|--|---|
| Material | Suffix surface and material | Example only 4 bolt flange | Example 4 bolt flange incl. metr. bolts and O-ring | Example 4 bolt flange incl. UNC bolts and O-ring | Standard sealing material (no additional suffix needed) |
| Steel, zinc plated, Cr(VI)-free | CF | PAFG080/90M12SCF | PAFG080/90M12SOMDCFM | PAFG080/90M12SOMDCFU | NBR |
| Stainless steel | SS | PAFG080/90M12S-SS | PAFG080/90M12SOMDSSM | - | VIT |



PAFG-G SAE Straight 4 bolt flange with BSPP 60° cone end

SAE Flange / BSPP 60° cone end
(ISO 6162-1/-2) (ISO 8434-6)

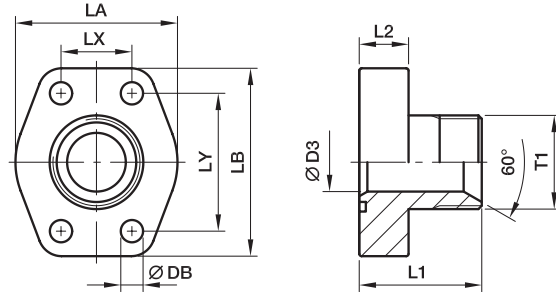

3000 PSI Series

| Nom. flange size | | T1 | D3 | L1 | L2 | LA | LB | LX | LY | DB | Bolts | | Weight (steel) kg/piece | Order code* | PN (bar) ¹⁾ | |
|------------------|----------|---------|----|----|----|----|-----|------|------|---------|---------|------------|-------------------------|-------------|------------------------|-----|
| SAE (in.) | ISO (DN) | | | | | | | | | | (metr.) | (unc.) | | | CF | SS |
| 1/2 | 13 | G 3/8 | 10 | 37 | 16 | 47 | 56 | 17.5 | 38.1 | 8.9 | M 08×30 | 5/16×1 1/4 | 0.25 | PAFG080G38 | 348 | 348 |
| 1/2 | 13 | G 1/2 | 12 | 39 | 16 | 47 | 56 | 17.5 | 38.1 | 8.9 | M 08×30 | 5/16×1 1/4 | 0.29 | PAFG080G | 348 | 348 |
| 1/2 | 13 | G 3/4 | 13 | 42 | 16 | 47 | 56 | 17.5 | 38.1 | 8.9 | M 08×30 | 5/16×1 1/4 | 0.28 | PAFG080G34 | 348 | 348 |
| 3/4 | 19 | G 1/2 | 12 | 42 | 18 | 50 | 66 | 22.3 | 47.6 | 10.6 | M 10×35 | 3/8×1 1/2 | 0.39 | PAFG100G12 | 348 | 348 |
| 3/4 | 19 | G 3/4 | 17 | 45 | 18 | 50 | 66 | 22.3 | 47.6 | 10.6 | M 10×35 | 3/8×1 1/2 | 0.40 | PAFG100G | 348 | 348 |
| 3/4 | 19 | G 1 | 19 | 47 | 18 | 50 | 66 | 22.3 | 47.6 | 10.6 | M 10×35 | 3/8×1 1/2 | 0.43 | PAFG100G1 | 348 | 348 |
| 1 | 25 | G 3/4 | 17 | 47 | 18 | 53 | 71 | 26.2 | 52.4 | 10.6 | M 10×35 | 3/8×1 1/2 | 0.44 | PAFG102G34 | 348 | 348 |
| 1 | 25 | G 1 | 22 | 49 | 18 | 53 | 71 | 26.2 | 52.4 | 10.6 | M 10×35 | 3/8×1 1/2 | 0.49 | PAFG102G | 348 | 348 |
| 1 | 25 | G 1 1/4 | 25 | 49 | 18 | 53 | 71 | 26.2 | 52.4 | 10.6 | M 10×35 | 3/8×1 1/2 | 0.57 | PAFG102G114 | 348 | 348 |
| 1 1/4 | 32 | G 1 | 22 | 53 | 21 | 69 | 80 | 30.2 | 58.7 | 10.6*** | M 10×40 | 7/16×1 1/2 | 0.74 | PAFG104G1 | 278 | 278 |
| 1 1/4 | 32 | G 1 1/4 | 27 | 53 | 21 | 69 | 80 | 30.2 | 58.7 | 10.6*** | M 10×40 | 7/16×1 1/2 | 0.73 | PAFG104G | 278 | 278 |
| 1 1/4 | 32 | G 1 1/2 | 31 | 55 | 21 | 69 | 80 | 30.2 | 58.7 | 10.6*** | M 10×40 | 7/16×1 1/2 | 0.90 | PAFG104G112 | 278 | 278 |
| 1 1/2 | 38 | G 1 1/4 | 27 | 59 | 24 | 77 | 94 | 35.7 | 69.9 | 13.3 | M 12×45 | 1/2×1 3/4 | 1.12 | PAFG106G114 | 210 | 210 |
| 1 1/2 | 38 | G 1 1/2 | 34 | 61 | 24 | 77 | 94 | 35.7 | 69.9 | 13.3 | M 12×45 | 1/2×1 3/4 | 1.10 | PAFG106G | 210 | 210 |
| 1 1/2 | 38 | G 2 | 38 | 63 | 24 | 77 | 94 | 35.7 | 69.9 | 13.3 | M 12×45 | 1/2×1 3/4 | 1.28 | PAFG106G2 | 210 | 210 |
| 2 | 51 | G 1 1/2 | 34 | 69 | 25 | 90 | 103 | 42.9 | 77.8 | 13.3 | M 12×45 | 1/2×1 3/4 | 1.59 | PAFG108G112 | 210 | 210 |
| 2 | 51 | G 2 | 42 | 69 | 25 | 90 | 103 | 42.9 | 77.8 | 13.3 | M 12×45 | 1/2×1 3/4 | 1.62 | PAFG108G | 210 | 210 |

6000 PSI Series

| | | | | | | | | | | | | | | | | |
|-------|----|---------|----|----|----|----|-----|------|------|---------|---------|------------|------|----------------|-----|-----|
| 1/2 | 13 | G 3/8 | 10 | 38 | 16 | 47 | 56 | 18.2 | 40.5 | 8.9 | M 08×30 | 5/16×1 1/4 | 0.24 | PAFG401G38 | 420 | 420 |
| 1/2 | 13 | G 1/2 | 12 | 40 | 16 | 47 | 56 | 18.2 | 40.5 | 8.9 | M 08×30 | 5/16×1 1/4 | 0.24 | PAFG401G | 420 | 420 |
| 1/2 | 13 | G 3/4 | 13 | 43 | 16 | 47 | 56 | 18.2 | 40.5 | 8.9 | M 08×30 | 5/16×1 1/4 | 0.28 | PAFG401G34 | 420 | 420 |
| 3/4 | 19 | G 1/2 | 12 | 44 | 18 | 53 | 71 | 23.8 | 50.8 | 10.6 | M 10×35 | 3/8×1 1/2 | 0.47 | PAFG402G12 | 420 | 420 |
| 3/4 | 19 | G 3/4 | 17 | 47 | 18 | 53 | 71 | 23.8 | 50.8 | 10.6 | M 10×35 | 3/8×1 1/2 | 0.48 | PAFG402G | 420 | 420 |
| 3/4 | 19 | G 1 | 19 | 49 | 18 | 53 | 71 | 23.8 | 50.8 | 10.6 | M 10×35 | 3/8×1 1/2 | 0.54 | PAFG402G1 | 420 | 420 |
| 1 | 25 | G 3/4 | 17 | 54 | 21 | 68 | 81 | 27.8 | 57.2 | 13.3*** | M 12×45 | 7/16×1 1/2 | 0.70 | PAFG403G34 | 420 | 420 |
| 1 | 25 | G 1 | 22 | 56 | 21 | 68 | 81 | 27.8 | 57.2 | 13.3*** | M 12×45 | 7/16×1 1/2 | 0.78 | PAFG403G | 420 | 420 |
| 1 | 25 | G 1 1/4 | 25 | 56 | 21 | 68 | 81 | 27.8 | 57.2 | 13.3*** | M 12×45 | 7/16×1 1/2 | 0.80 | PAFG403G114 | 420 | 420 |
| 1 1/4 | 32 | G 1 | 22 | 61 | 24 | 78 | 94 | 31.8 | 66.6 | 15.0** | M 14×50 | 1/2×1 3/4 | 1.08 | PAFG404G1 | 420 | 420 |
| 1 1/4 | 32 | G 1 | 22 | 61 | 24 | 78 | 94 | 31.8 | 66.6 | 13.3 | M 12×50 | – | 1.08 | PAFG404/12G1 | 420 | 420 |
| 1 1/4 | 32 | G 1 1/4 | 27 | 61 | 24 | 78 | 94 | 31.8 | 66.6 | 15.0** | M 14×50 | 1/2×1 3/4 | 1.13 | PAFG404G | 420 | 420 |
| 1 1/4 | 32 | G 1 1/4 | 27 | 61 | 24 | 78 | 94 | 31.8 | 66.6 | 13.3 | M 12×50 | – | 1.13 | PAFG404/12G | 420 | 420 |
| 1 1/4 | 32 | G 1 1/2 | 31 | 63 | 24 | 78 | 94 | 31.8 | 66.6 | 15.0** | M 14×50 | 1/2×1 3/4 | 1.15 | PAFG404G112 | 420 | 420 |
| 1 1/4 | 32 | G 1 1/2 | 31 | 63 | 24 | 78 | 94 | 31.8 | 66.6 | 13.3 | M 12×50 | – | 1.15 | PAFG404/12G112 | 420 | 420 |
| 1 1/2 | 38 | G 1 1/4 | 27 | 65 | 27 | 90 | 101 | 36.5 | 79.3 | 16.7 | M 16×55 | 5/8×2 1/4 | 1.58 | PAFG405G114 | 420 | 420 |
| 1 1/2 | 38 | G 1 1/2 | 32 | 67 | 27 | 90 | 101 | 36.5 | 79.3 | 16.7 | M 16×55 | 5/8×2 1/4 | 1.55 | PAFG405G | 420 | 420 |

Stainless steel parts may have dimensional deviations.

Additional information on request.

**DB = 13.3 for UNC Bolts

***DB = 12 for UNC Bolts

¹⁾ Pressure shown = Item deliverable

$\frac{PN(\text{bar})}{10} = PN(\text{MPa})$

*Please add the suffixes below according to the material/surface required.

| Order code suffixes | | | | | |
|---------------------------------|-----------------------------|----------------------------|--|--|---|
| Material | Suffix surface and material | Example only 4 bolt flange | Example 4 bolt flange incl. metr. bolts and O-ring | Example 4 bolt flange incl. UNC bolts and O-ring | Standard sealing material (no additional suffix needed) |
| Steel, zinc plated, Cr(VI)-free | CF | PAFG080GCF | PAFG080GCFFM | PAFG080GCFU | NBR |
| Stainless steel | SS | PAFG080GSS | PAFG080GSSM | – | VIT |



SAE Full flanges

PAFG-90G SAE 90° 4 bolt flange with BSPP 60° cone end

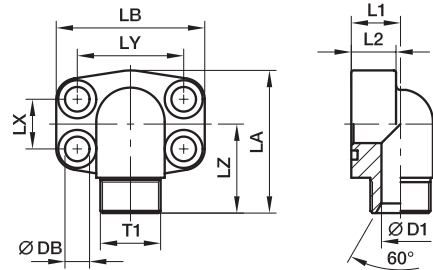
 SAE 90° Flange / BSPP 60° cone end
 (ISO 6162-1/-2) (ISO 8434-6)

3000 PSI Series

| Nom. flange size | | T1 | D3 | L1 | L2 | LA | LB | LX | LY | LZ | DB | Bolts | | Weight (steel) kg/piece | Order code* | PN (bar ¹⁾) | |
|------------------|----------|---------|----|----|----|----|----|------|------|----|---------|---------|------------|-------------------------|----------------|-------------------------|-----|
| SAE (in.) | ISO (DN) | | | | | | | | | | | (metr.) | (unc.) | | | CF | SS |
| 1/2 | 13 | G 3/8 | 10 | 17 | 16 | 60 | 57 | 17.5 | 38.1 | 37 | 8.9 | M 08x30 | 5/16x1 1/4 | 0.30 | PAFG080/90G38 | 348 | 348 |
| 1/2 | 13 | G 1/2 | 12 | 17 | 16 | 60 | 57 | 17.5 | 38.1 | 39 | 8.9 | M 08x30 | 5/16x1 1/4 | 0.33 | PAFG080/90G | 348 | 348 |
| 1/2 | 13 | G 3/4 | 13 | 20 | 16 | 60 | 57 | 17.5 | 38.1 | 40 | 8.9 | M 08x30 | 5/16x1 1/4 | 0.31 | PAFG080/90G34 | 348 | 348 |
| 3/4 | 19 | G 1/2 | 12 | 20 | 18 | 63 | 66 | 22.3 | 47.6 | 41 | 10.6 | M 10x35 | 3/8x1 1/2 | 0.47 | PAFG100/90G12 | 348 | 348 |
| 3/4 | 19 | G 3/4 | 17 | 20 | 18 | 63 | 66 | 22.3 | 47.6 | 44 | 10.6 | M 10x35 | 3/8x1 1/2 | 0.45 | PAFG100/90G | 348 | 348 |
| 3/4 | 19 | G 1 | 19 | 25 | 18 | 63 | 66 | 22.3 | 47.6 | 45 | 10.6 | M 10x35 | 3/8x1 1/2 | 0.60 | PAFG100/90G1 | 348 | 348 |
| 1 | 25 | G 3/4 | 17 | 20 | 19 | 80 | 71 | 26.2 | 52.4 | 47 | 10.6 | M 10x35 | 3/8x1 1/2 | 0.68 | PAFG102/90G34 | 348 | 348 |
| 1 | 25 | G 1 | 22 | 25 | 19 | 80 | 71 | 26.2 | 52.4 | 48 | 10.6 | M 10x35 | 3/8x1 1/2 | 0.64 | PAFG102/90G | 348 | 348 |
| 1 | 25 | G 1 1/4 | 25 | 31 | 19 | 80 | 71 | 26.2 | 52.4 | 49 | 10.6 | M 10x40 | 3/8x1 1/2 | 0.81 | PAFG102/90G114 | 348 | 348 |
| 1 1/4 | 32 | G 1 | 22 | 25 | 22 | 84 | 80 | 30.2 | 58.7 | 54 | 10.6*** | M 10x40 | 7/16x1 1/2 | 1.06 | PAFG104/90G1 | 278 | 278 |
| 1 1/4 | 32 | G 1 1/4 | 27 | 31 | 22 | 84 | 80 | 30.2 | 58.7 | 55 | 10.6*** | M 10x35 | 7/16x1 1/2 | 0.93 | PAFG104/90G | 278 | 278 |
| 1 1/4 | 32 | G 1 1/2 | 31 | 37 | 22 | 84 | 80 | 30.2 | 58.7 | 56 | 10.6*** | M 10x40 | 7/16x1 1/2 | 0.96 | PAFG104/90G112 | 278 | 278 |
| 1 1/2 | 38 | G 1 1/4 | 27 | 31 | 25 | 88 | 94 | 35.7 | 69.9 | 59 | 13.3 | M 12x45 | 1/2x1 3/4 | 1.44 | PAFG106/90G114 | 210 | 210 |
| 1 1/2 | 38 | G 1 1/2 | 34 | 37 | 25 | 88 | 94 | 35.7 | 69.9 | 61 | 13.3 | M 12x45 | 1/2x1 3/4 | 1.49 | PAFG106/90G | 210 | 210 |

6000 PSI Series

| | | | | | | | | | | | | | | | | | |
|-------|----|---------|----|----|----|-----|-----|------|------|----|---------|---------|------------|------|-------------------|-----|-----|
| 1/2 | 13 | G 3/8 | 10 | 17 | 16 | 60 | 57 | 18.2 | 40.5 | 37 | 8.9 | M 08x30 | 5/16x1 1/4 | 0.30 | PAFG401/90G38 | 420 | 420 |
| 1/2 | 13 | G 1/2 | 12 | 17 | 16 | 60 | 57 | 18.2 | 40.5 | 39 | 8.9 | M 08x30 | 5/16x1 1/4 | 0.32 | PAFG401/90G | 420 | 420 |
| 1/2 | 13 | G 3/4 | 13 | 20 | 16 | 60 | 57 | 18.2 | 40.5 | 40 | 8.9 | M 08x30 | 5/16x1 1/4 | 0.35 | PAFG401/90G34 | 420 | 420 |
| 3/4 | 19 | G 1/2 | 12 | 20 | 19 | 68 | 71 | 23.8 | 50.8 | 45 | 10.6 | M 10x35 | 3/8x1 1/2 | 0.73 | PAFG402/90G12 | 420 | 420 |
| 3/4 | 19 | G 3/4 | 17 | 20 | 19 | 68 | 71 | 23.8 | 50.8 | 48 | 10.6 | M 10x35 | 3/8x1 1/2 | 0.70 | PAFG402/90G | 420 | 420 |
| 3/4 | 19 | G 1 | 19 | 25 | 19 | 68 | 71 | 23.8 | 50.8 | 50 | 10.6 | M 10x35 | 3/8x1 1/2 | 0.75 | PAFG402/90G1 | 420 | 420 |
| 1 | 25 | G 3/4 | 17 | 25 | 24 | 83 | 80 | 27.8 | 57.2 | 52 | 13.3*** | M 12x45 | 7/16x1 1/2 | 0.89 | PAFG403/90G34 | 420 | 420 |
| 1 | 25 | G 1 | 22 | 25 | 24 | 83 | 80 | 27.8 | 57.2 | 54 | 13.3*** | M 12x45 | 7/16x1 1/2 | 0.90 | PAFG403/90G | 420 | 420 |
| 1 | 25 | G 1 1/4 | 25 | 31 | 24 | 83 | 80 | 27.8 | 57.2 | 55 | 13.3*** | M 12x45 | 7/16x1 1/2 | 1.07 | PAFG403/90G114 | 420 | 420 |
| 1 1/4 | 32 | G 1 | 22 | 31 | 25 | 97 | 94 | 31.8 | 66.6 | 59 | 15.0** | M 14x50 | 1/2x1 3/4 | 1.66 | PAFG404/90G1 | 420 | 420 |
| 1 1/4 | 32 | G 1 | 22 | 31 | 25 | 97 | 94 | 31.8 | 66.6 | 59 | 13.3 | M 12x50 | - | 1.66 | PAFG404/12/90G1 | 420 | 420 |
| 1 1/4 | 32 | G 1 1/4 | 27 | 31 | 25 | 97 | 94 | 31.8 | 66.6 | 59 | 15.0** | M 14x50 | 1/2x1 3/4 | 1.59 | PAFG404/90G | 420 | 420 |
| 1 1/4 | 32 | G 1 1/4 | 27 | 31 | 25 | 97 | 94 | 31.8 | 66.6 | 59 | 13.3 | M 12x50 | - | 1.59 | PAFG404/12/90G | 420 | 420 |
| 1 1/4 | 32 | G 1 1/2 | 31 | 37 | 25 | 97 | 94 | 31.8 | 66.6 | 61 | 15.0** | M 14x50 | 1/2x1 3/4 | 1.55 | PAFG404/90G112 | 420 | 420 |
| 1 1/4 | 32 | G 1 1/2 | 31 | 37 | 25 | 97 | 94 | 31.8 | 66.6 | 61 | 13.3 | M 12x50 | - | 1.55 | PAFG404/12/90G112 | 420 | 420 |
| 1 1/2 | 38 | G 1 1/4 | 27 | 37 | 26 | 110 | 106 | 36.5 | 79.3 | 64 | 16.7 | M 16x55 | 5/8x2 1/4 | 2.35 | PAFG405/90G114 | 420 | 420 |
| 1 1/2 | 38 | G 1 1/2 | 32 | 37 | 26 | 110 | 106 | 36.5 | 79.3 | 66 | 16.7 | M 16x55 | 5/8x2 1/4 | 2.35 | PAFG405/90G | 420 | 420 |

1) Pressure shown = Item deliverable

** DB = 13.3 for UNC Bolts

$$\frac{PN \text{ (bar)}}{10} = PN \text{ (MPa)}$$

***DB = 12 for UNC Bolts

*Please add the suffixes below according to the material/surface required.

 Stainless steel parts may have dimensional deviations.
 Additional information on request.

| Order code suffixes | | | | | |
|---------------------------------|-----------------------------|----------------------------|--|--|---|
| Material | Suffix surface and material | Example only 4 bolt flange | Example 4 bolt flange incl. metr. bolts and O-ring | Example 4 bolt flange incl. UNC bolts and O-ring | Standard sealing material (no additional suffix needed) |
| Steel, zinc plated, Cr(VI)-free | CF | PAFG080/90GCF | PAFG080/90GCFM | PAFG080/90GCFU | NBR |
| Stainless steel | SS | PAFG080/90GSS | PAFG080/90GSSM | - | VIT |



PAFG-X SAE Straight 4 bolt flange with Triple-Lok® 37° flare end

SAE Flange / Triple-Lok® 37° flare end
(ISO 6162-1/-2)

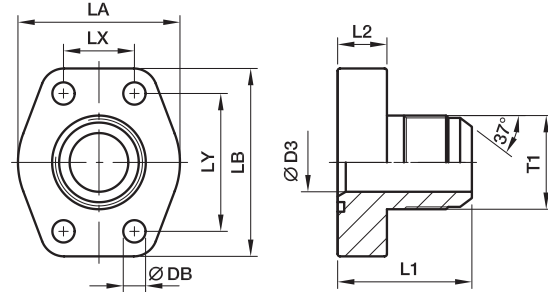

3000 PSI Series

| Nom. flange size | | T1 | D3 | L1 | L2 | LA | LB | LX | LY | DB | Bolts | | Weight (steel) kg/piece | Order code* | PN (bar) ¹⁾ | |
|------------------|----------|--------------------|------|----|----|----|----|------|------|---------|---------|------------|-------------------------|-------------------|------------------------|-----|
| SAE (in.) | ISO (DN) | | | | | | | | | | (metr.) | (unc.) | | | CF | SS |
| 1/2 | 13 | 3/4-16UNF | 9.9 | 41 | 16 | 47 | 57 | 17.5 | 38.1 | 8.9 | M 08x30 | 5/16x1 1/4 | 0.25 | PAFG080X-A | 348 | 348 |
| 1/2 | 13 | 7/8-14UNF | 12.3 | 41 | 16 | 47 | 57 | 17.5 | 38.1 | 8.9 | M 08x30 | 5/16x1 1/4 | 0.25 | PAFG080X-B | 348 | 348 |
| 1/2 | 13 | 1 1/16-12UN | 12.3 | 46 | 16 | 47 | 57 | 17.5 | 38.1 | 8.9 | M 08x30 | 5/16x1 1/4 | 0.28 | PAFG080X-C | 348 | 348 |
| 3/4 | 19 | 7/8-14UN | 12.3 | 47 | 18 | 50 | 66 | 22.3 | 47.6 | 10.6 | M 10x35 | 3/8x1 1/2 | 0.35 | PAFG100X-A | 348 | 348 |
| 3/4 | 19 | 1 1/16-12UN | 15.5 | 49 | 18 | 50 | 66 | 22.3 | 47.6 | 10.6 | M 10x35 | 3/8x1 1/2 | 0.40 | PAFG100X-B | 348 | 348 |
| 3/4 | 19 | 1 5/16-12UN | 21.5 | 50 | 18 | 50 | 66 | 22.3 | 47.6 | 10.6 | M 10x35 | 3/8x1 1/2 | 0.41 | PAFG100X-C | 348 | 348 |
| 1 | 25 | 1 1/16-12UN | 15.5 | 51 | 18 | 53 | 71 | 26.2 | 52.4 | 10.6 | M 10x35 | 3/8x1 1/2 | 0.44 | PAFG102X-A | 348 | 348 |
| 1 | 25 | 1 5/16-12UN | 21.5 | 52 | 18 | 53 | 71 | 26.2 | 52.4 | 10.6 | M 10x35 | 3/8x1 1/2 | 0.46 | PAFG102X-B | 348 | 348 |
| 1 | 25 | 1 5/8-12UN | 27.5 | 54 | 18 | 53 | 71 | 26.2 | 52.4 | 10.6 | M 10x35 | 3/8x1 1/2 | 0.56 | PAFG102X-C | 348 | 348 |
| 1 1/4 | 32 | 1 5/16-12UN | 21.5 | 56 | 21 | 69 | 81 | 30.2 | 58.7 | 10.6*** | M 10x40 | 7/16x1 1/2 | 0.73 | PAFG104X-A | 278 | 278 |
| 1 1/4 | 32 | 1 5/8-12UN | 27.5 | 58 | 21 | 69 | 81 | 30.2 | 58.7 | 10.6*** | M 10x40 | 7/16x1 1/2 | 0.80 | PAFG104X-B | 278 | 278 |
| 1 1/4 | 32 | 1 7/8-12UN | 33.0 | 61 | 21 | 69 | 81 | 30.2 | 58.7 | 10.6*** | M 10x40 | 7/16x1 1/2 | 0.92 | PAFG104X-C | 278 | 278 |
| 1 1/2 | 38 | 1 5/8-12UN | 27.5 | 64 | 24 | 77 | 94 | 35.7 | 69.9 | 13.3 | M 12x45 | 1/2x1 3/4 | 1.17 | PAFG106X-A | 210 | 210 |
| 1 1/2 | 38 | 1 7/8-12UN | 33.0 | 67 | 24 | 77 | 94 | 35.7 | 69.9 | 13.3 | M 12x45 | 1/2x1 3/4 | 1.19 | PAFG106X-B | 210 | 210 |

6000 PSI Series

| | | | | | | | | | | | | | | | | |
|-------|----|--------------------|------|----|----|----|-----|------|------|---------|---------|------------|------|----------------------|-----|-----|
| 1/2 | 13 | 3/4-16UNF | 9.9 | 42 | 16 | 47 | 57 | 18.2 | 40.5 | 8.9 | M 08x30 | 5/16x1 1/4 | 0.26 | PAFG401X-A | 350 | 350 |
| 1/2 | 13 | 7/8-14UNF | 12.3 | 45 | 16 | 47 | 57 | 18.2 | 40.5 | 8.9 | M 08x30 | 5/16x1 1/4 | 0.26 | PAFG401X-B | 350 | 350 |
| 1/2 | 13 | 1 1/16-12UN | 12.3 | 47 | 16 | 47 | 57 | 18.2 | 40.5 | 8.9 | M 08x30 | 5/16x1 1/4 | 0.29 | PAFG401X-C | 350 | 350 |
| 3/4 | 19 | 7/8-14UN | 12.3 | 49 | 18 | 53 | 71 | 23.8 | 50.8 | 10.6 | M 10x35 | 3/8x1 1/2 | 0.45 | PAFG402X-A | 350 | 350 |
| 3/4 | 19 | 1 1/16-12UN | 15.5 | 51 | 18 | 53 | 71 | 23.8 | 50.8 | 10.6 | M 10x35 | 3/8x1 1/2 | 0.52 | PAFG402X-B | 350 | 350 |
| 3/4 | 19 | 1 5/16-12UN | 21.5 | 52 | 18 | 53 | 71 | 23.8 | 50.8 | 10.6 | M 10x35 | 3/8x1 1/2 | 0.52 | PAFG402X-C | 350 | 350 |
| 1 | 25 | 1 1/16-12UN | 15.5 | 58 | 21 | 66 | 80 | 27.8 | 57.2 | 13.3*** | M 12x45 | 7/16x1 1/2 | 0.70 | PAFG403X-A | 350 | 350 |
| 1 | 25 | 1 5/16-12UN | 21.5 | 59 | 21 | 66 | 80 | 27.8 | 57.2 | 13.3*** | M 12x45 | 7/16x1 1/2 | 0.71 | PAFG403X-B | 350 | 350 |
| 1 | 25 | 1 5/8-12UN | 27.5 | 61 | 21 | 66 | 80 | 27.8 | 57.2 | 13.3*** | M 12x45 | 7/16x1 1/2 | 0.82 | PAFG403X-C | 275 | 275 |
| 1 1/4 | 32 | 1 5/16-12UN | 21.5 | 64 | 24 | 78 | 94 | 31.8 | 66.6 | 15.0** | M 14x50 | 1/2x1 3/4 | 1.07 | PAFG404X-A | 350 | 350 |
| 1 1/4 | 32 | 1 5/8-12UN | 21.5 | 64 | 24 | 78 | 94 | 31.8 | 66.6 | 13.3 | M 12x50 | - | 1.07 | PAFG404/12X-A | 350 | 350 |
| 1 1/4 | 32 | 1 5/8-12UN | 27.5 | 66 | 24 | 78 | 94 | 31.8 | 66.6 | 15.0** | M 14x50 | 1/2x1 3/4 | 1.13 | PAFG404X-B | 275 | 275 |
| 1 1/4 | 32 | 1 5/8-12UN | 27.5 | 66 | 24 | 78 | 94 | 31.8 | 66.6 | 13.3 | M 12x50 | - | 1.13 | PAFG404/12X-B | 275 | 275 |
| 1 1/4 | 32 | 1 7/8-12UN | 33.0 | 69 | 24 | 78 | 94 | 31.8 | 66.6 | 15.0** | M 14x50 | 1/2x1 3/4 | 1.10 | PAFG404X-C | 210 | 210 |
| 1 1/4 | 32 | 1 7/8-12UN | 33.0 | 69 | 24 | 78 | 94 | 31.8 | 66.6 | 13.3 | M 12x50 | - | 1.10 | PAFG404/12X-C | 210 | 210 |
| 1 1/2 | 38 | 1 5/8-12UN | 27.5 | 70 | 27 | 90 | 106 | 36.5 | 79.3 | 16.7 | M 16x55 | 5/8x2 1/4 | 1.60 | PAFG405X-A | 275 | 275 |
| 1 1/2 | 38 | 1 7/8-12UN | 33.0 | 73 | 27 | 90 | 106 | 36.5 | 79.3 | 16.7 | M 16x55 | 5/8x2 1/4 | 1.62 | PAFG405X-B | 210 | 210 |

¹⁾ Pressure shown = Item deliverable

**DB = 13.3 for UNC Bolts

PN (bar) = PN (MPa) / 10

***DB = 12 for UNC Bolts

*Please add the suffixes below according to the material/surface required.

Stainless steel parts may have dimensional deviations. Additional information on request.

| Order code suffixes | | | | | |
|---------------------------------|-----------------------------|----------------------------|--|--|---|
| Material | Suffix surface and material | Example only 4 bolt flange | Example 4 bolt flange incl. metr. bolts and O-ring | Example 4 bolt flange incl. UNC bolts and O-ring | Standard sealing material (no additional suffix needed) |
| Steel, zinc plated, Cr(VI)-free | CF | PAFG080X-ACF | PAFG080X-ACFM | PAFG080X-ACFU | NBR |
| Stainless steel | SS | PAFG080X-ASS | PAFG080X-ASSM | - | VIT |



SAE Full flanges

PAFG-90X SAE 90° 4 bolt flange with Triple-Lok® 37° flare end

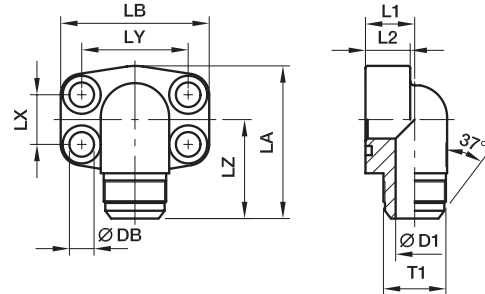
 SAE 90° Flange / Triple-Lok® 37° flare end
 (ISO 6162-1/-2)

3000 PSI Series

| Nom. flange size | | T1 | D1 | L1 | L2 | LA | LB | LX | LY | LZ | DB | Bolts | | Weight (steel) kg/piece | Order code* | PN (bar) ¹⁾ | |
|------------------|----------|-----------|------|----|----|----|----|------|------|----|---------|---------|------------|-------------------------|---------------|------------------------|-----|
| SAE (in.) | ISO (DN) | | | | | | | | | | | (metr.) | (unc.) | | | CF | SS |
| 1/2 | 13 | 3/4-16 | 9.9 | 17 | 16 | 60 | 56 | 17.5 | 38.1 | 40 | 8.9 | M 08x30 | 5/16x1 1/4 | 0.30 | PAFG080/90X-A | 348 | 348 |
| 1/2 | 13 | 7/8-14 | 12.3 | 17 | 16 | 60 | 56 | 17.5 | 38.1 | 42 | 8.9 | M 08x30 | 5/16x1 1/4 | 0.30 | PAFG080/90X-B | 348 | 348 |
| 1/2 | 13 | 1 1/16-12 | 12.3 | 20 | 16 | 60 | 57 | 17.5 | 38.1 | 43 | 8.9 | M 08x30 | 5/16x1 1/4 | 0.30 | PAFG080/90X-C | 348 | 348 |
| 3/4 | 19 | 7/8-14 | 12.3 | 20 | 18 | 63 | 66 | 22.3 | 47.6 | 45 | 10.6 | M 10x35 | 3/8x1 1/2 | 0.50 | PAFG100/90X-A | 348 | 348 |
| 3/4 | 19 | 1 1/16-12 | 15.5 | 20 | 18 | 63 | 66 | 22.3 | 47.6 | 47 | 10.6 | M 10x35 | 3/8x1 1/2 | 0.50 | PAFG100/90X-B | 348 | 348 |
| 3/4 | 19 | 1 5/16-12 | 21.5 | 25 | 18 | 63 | 66 | 22.3 | 47.6 | 48 | 10.6 | M 10x35 | 3/8x1 1/2 | 0.58 | PAFG100/90X-C | 348 | 348 |
| 1 | 25 | 1 1/16-12 | 15.5 | 20 | 19 | 80 | 71 | 26.2 | 52.4 | 50 | 10.6 | M 10x35 | 3/8x1 1/2 | 0.62 | PAFG102/90X-A | 348 | 348 |
| 1 | 25 | 1 5/16-12 | 21.5 | 25 | 19 | 80 | 71 | 26.2 | 52.4 | 51 | 10.6 | M 10x35 | 3/8x1 1/2 | 0.68 | PAFG102/90X-B | 348 | 348 |
| 1 1/4 | 32 | 1 5/16-12 | 21.5 | 25 | 22 | 84 | 80 | 30.2 | 58.7 | 56 | 10.6*** | M 10x40 | 7/16x1 1/2 | 1.06 | PAFG104/90X-A | 278 | 278 |
| 1 1/4 | 32 | 1 5/8-12 | 27.5 | 31 | 22 | 84 | 80 | 30.2 | 58.7 | 58 | 10.6*** | M 10x40 | 7/16x1 1/2 | 1.03 | PAFG104/90X-B | 278 | 278 |
| 1 1/4 | 32 | 1 7/8-12 | 33.0 | 37 | 22 | 84 | 80 | 30.2 | 58.7 | 61 | 10.6*** | M 10x40 | 7/16x1 1/2 | 0.96 | PAFG104/90X-C | 278 | 278 |
| 1 1/2 | 38 | 1 5/8-12 | 27.5 | 31 | 25 | 88 | 94 | 35.7 | 69.9 | 63 | 13.3 | M 12x45 | 1/2x1 3/4 | 1.62 | PAFG106/90X-A | 210 | 210 |
| 1 1/2 | 38 | 1 7/8-12 | 33.0 | 37 | 25 | 88 | 94 | 35.7 | 69.9 | 66 | 13.3 | M 12x45 | 1/2x1 3/4 | 1.53 | PAFG106/90X-B | 210 | 210 |

6000 PSI Series

| | | | | | | | | | | | | | | | | | |
|-------|----|-----------|---------|----|----|-----|-----|------|------|----|---------|---------|------------|------|------------------|-----|-----|
| 1/2 | 13 | 3/4-16 | 9.9 | 17 | 16 | 60 | 57 | 18.2 | 40.5 | 40 | 8.9 | M 08x30 | 5/16x1 1/4 | 0.30 | PAFG401/90X-A | 350 | 350 |
| 1/2 | 13 | 7/8-14 | 12.3 | 17 | 16 | 60 | 57 | 18.2 | 40.5 | 42 | 8.9 | M 08x30 | 5/16x1 1/4 | 0.32 | PAFG401/90X-B | 350 | 350 |
| 1/2 | 13 | 1 1/16-12 | 12.3 | 20 | 16 | 60 | 57 | 18.2 | 40.5 | 43 | 8.9 | M 08x30 | 5/16x1 1/4 | 0.35 | PAFG401/90X-C | 350 | 350 |
| 3/4 | 19 | 7/8-14 | 12.3 | 20 | 19 | 68 | 72 | 23.8 | 50.8 | 49 | 10.6 | M 10x35 | 3/8x1 1/2 | 0.71 | PAFG402/90X-A | 350 | 350 |
| 3/4 | 19 | 1 1/16-12 | 15.5 | 20 | 19 | 68 | 72 | 23.8 | 50.8 | 51 | 10.6 | M 10x35 | 3/8x1 1/2 | 0.67 | PAFG402/90X-B | 350 | 350 |
| 3/4 | 19 | 1 5/16-12 | 21.5 | 25 | 19 | 68 | 72 | 23.8 | 50.8 | 52 | 10.6 | M 10x35 | 3/8x1 1/2 | 0.71 | PAFG402/90X-C | 350 | 350 |
| 1 | 25 | 1 1/16-12 | 15.5 | 25 | 24 | 90 | 80 | 27.8 | 57.2 | 55 | 13.3*** | M 12x45 | 7/16x1 1/2 | 0.93 | PAFG403/90X-A | 350 | 350 |
| 1 | 25 | 1 5/16-12 | 25/21.5 | 25 | 24 | 90 | 80 | 27.8 | 57.2 | 56 | 13.3*** | M 12x45 | 7/16x1 1/2 | 0.88 | PAFG403/90X-B | 350 | 350 |
| 1 | 25 | 1 5/8-12 | 27.5 | 31 | 24 | 90 | 80 | 27.8 | 57.2 | 58 | 13.3*** | M 12x45 | 7/16x1 1/2 | 1.04 | PAFG403/90X-C | 275 | 275 |
| 1 1/4 | 32 | 1 5/16-12 | 21.5 | 31 | 25 | 97 | 94 | 31.8 | 66.6 | 56 | 15.0** | M 14x50 | 1/2x1 3/4 | 1.53 | PAFG404/90X-A | 350 | 350 |
| 1 1/4 | 32 | 1 5/16-12 | 21.5 | 31 | 25 | 97 | 94 | 31.8 | 66.6 | 56 | 13.3 | M 12x50 | - | 1.53 | PAFG404/12/90X-A | 350 | 350 |
| 1 1/4 | 32 | 1 5/8-12 | 27.5 | 31 | 25 | 97 | 94 | 31.8 | 66.6 | 63 | 15.0** | M 14x50 | 1/2x1 3/4 | 1.56 | PAFG404/90X-B | 275 | 275 |
| 1 1/4 | 32 | 1 5/8-12 | 27.5 | 31 | 25 | 97 | 94 | 31.8 | 66.6 | 63 | 13.3 | M 12x50 | - | 1.56 | PAFG404/12/90X-B | 275 | 275 |
| 1 1/4 | 32 | 1 7/8-12 | 33.0 | 37 | 25 | 97 | 94 | 31.8 | 66.6 | 63 | 15.0** | M 14x50 | 1/2x1 3/4 | 1.63 | PAFG404/90X-C | 210 | 210 |
| 1 1/4 | 32 | 1 7/8-12 | 33.0 | 37 | 25 | 97 | 94 | 31.8 | 66.6 | 63 | 13.3 | M 12x50 | - | 1.63 | PAFG404/12/90X-C | 210 | 210 |
| 1 1/2 | 38 | 1 5/8-12 | 27.5 | 37 | 26 | 110 | 106 | 36.5 | 79.3 | 67 | 16.7 | M 16x55 | 5/8x2 1/4 | 2.61 | PAFG405/90X-A | 275 | 275 |
| 1 1/2 | 38 | 1 7/8-12 | 33.0 | 37 | 26 | 110 | 106 | 36.5 | 79.3 | 70 | 16.7 | M 16x55 | 5/8x2 1/4 | 2.49 | PAFG405/90X-B | 210 | 210 |

1) Pressure shown = Item deliverable

** DB = 13.3 for UNC Bolts

***DB = 12 for UNC Bolts

$$\frac{\text{PN (bar)}}{10} = \text{PN (MPa)}$$

*Please add the suffixes below according to the material/surface required.

 Stainless steel parts may have dimensional deviations.
 Additional information on request.

| Order code suffixes | | | | | |
|---------------------------------|-----------------------------|----------------------------|--|--|---|
| Material | Suffix surface and material | Example only 4 bolt flange | Example 4 bolt flange incl. metr. bolts and O-ring | Example 4 bolt flange incl. UNC bolts and O-ring | Standard sealing material (no additional suffix needed) |
| Steel, zinc plated, Cr(VI)-free | CF | PAFG080/90X-ACF | PAFG080/90X-ACFM | PAFG080/90X-ACFU | NBR |
| Stainless steel | SS | PAFG080/90X-ASS | PAFG080/90X-ASSM | - | VIT |



PAFG-L SAE Straight 4 bolt flange with O-Lok® ORFS end

SAE Flange / O-Lok® ORFS end
(ISO 6162-1/-2)

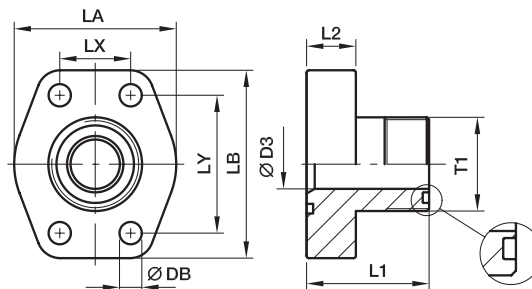

3000 PSI Series

| Nom. flange size | | T1 | D3 | L1 | L2 | LA | LB | LX | LY | DB | Bolts | | Weight (steel) kg/piece | Order code* | PN (bar) ¹⁾ | |
|------------------|----------|---------------------|------|----|----|----|----|------|------|---------|---------|------------|-------------------------|-------------------|------------------------|-----|
| SAE (in.) | ISO (DN) | | | | | | | | | | (metr.) | (unc.) | | | CF | SS |
| 1/2 | 13 | 11/16-16UN | 6.0 | 37 | 16 | 47 | 56 | 17.5 | 38.1 | 8.9 | M 08×30 | 5/16×1 1/4 | 0.24 | PAFG080L-A | 348 | 348 |
| 1/2 | 13 | 13/16-16UN | 9.0 | 39 | 16 | 47 | 56 | 17.5 | 38.1 | 8.9 | M 08×30 | 5/16×1 1/4 | 0.25 | PAFG080L-B | 348 | 348 |
| 1/2 | 13 | 1-14UN | 12.0 | 42 | 16 | 47 | 56 | 17.5 | 38.1 | 8.9 | M 08×30 | 5/16×1 1/4 | 0.27 | PAFG080L-C | 348 | 348 |
| 3/4 | 19 | 1-14UN | 12.0 | 45 | 18 | 50 | 66 | 22.3 | 47.6 | 10.6 | M 10×35 | 3/8×1 1/2 | 0.44 | PAFG100L-A | 348 | 348 |
| 3/4 | 19 | 1 3/16-12UN | 15.0 | 47 | 18 | 50 | 66 | 22.3 | 47.6 | 10.6 | M 10×35 | 3/8×1 1/2 | 0.46 | PAFG100L-B | 348 | 348 |
| 1 | 25 | 1 3/16-12UN | 15.0 | 49 | 18 | 53 | 71 | 26.2 | 52.4 | 10.6 | M 10×35 | 3/8×1 1/2 | 0.53 | PAFG102L-A | 348 | 348 |
| 1 | 25 | 1 7/16-12UN | 20.0 | 49 | 18 | 53 | 71 | 26.2 | 52.4 | 10.6 | M 10×35 | 3/8×1 1/2 | 0.54 | PAFG102L-B | 348 | 348 |
| 1 1/4 | 32 | 1 7/16-12UN | 20.0 | 53 | 21 | 69 | 80 | 30.2 | 58.7 | 10.6*** | M 10×40 | 7/16×1 1/2 | 0.80 | PAFG104L-A | 278 | 278 |
| 1 1/4 | 32 | 1 11/16-12UN | 26.0 | 53 | 21 | 69 | 80 | 30.2 | 58.7 | 10.6*** | M 10×40 | 7/16×1 1/2 | 0.83 | PAFG104L-B | 278 | 278 |
| 1 1/2 | 38 | 1 11/16-12UN | 26.0 | 61 | 24 | 77 | 94 | 35.7 | 69.9 | 13.3 | M 12×45 | 1/2×1 3/4 | 1.34 | PAFG106L-A | 210 | 210 |
| 1 1/2 | 38 | 2-12UN | 32.0 | 61 | 24 | 77 | 94 | 35.7 | 69.9 | 13.3 | M 12×45 | 1/2×1 3/4 | 1.20 | PAFG106L-B | 210 | 210 |

6000 PSI Series

| | | | | | | | | | | | | | | | | |
|-------|----|---------------------|------|----|----|----|-----|------|------|---------|---------|------------|------|----------------------|-----|-----|
| 1/2 | 13 | 11/16-16UN | 6.0 | 38 | 16 | 47 | 57 | 18.2 | 40.5 | 8.9 | M 08×30 | 5/16×1 1/4 | 0.25 | PAFG401L-A | 420 | 420 |
| 1/2 | 13 | 13/16-16UN | 9.0 | 40 | 16 | 47 | 57 | 18.2 | 40.5 | 8.9 | M 08×30 | 5/16×1 1/4 | 0.27 | PAFG401L-B | 420 | 420 |
| 1/2 | 13 | 1-14UN | 12.5 | 43 | 16 | 47 | 57 | 18.2 | 40.5 | 8.9 | M 08×30 | 5/16×1 1/4 | 0.28 | PAFG401L-C | 420 | 420 |
| 3/4 | 19 | 1-14UN | 12.5 | 47 | 18 | 53 | 72 | 23.8 | 50.8 | 10.6 | M 10×35 | 3/8×1 1/2 | 0.49 | PAFG402L-A | 420 | 420 |
| 3/4 | 19 | 1 3/16-12UN | 15.0 | 49 | 18 | 53 | 72 | 23.8 | 50.8 | 10.6 | M 10×35 | 3/8×1 1/2 | 0.51 | PAFG402L-B | 420 | 420 |
| 1 | 25 | 1 3/16-12UN | 15.0 | 56 | 21 | 68 | 80 | 27.8 | 57.2 | 13.3*** | M 12×45 | 7/16×1 1/2 | 0.75 | PAFG403L-A | 420 | 420 |
| 1 | 25 | 1 7/16-12UN | 20.0 | 56 | 21 | 68 | 80 | 27.8 | 57.2 | 13.3*** | M 12×45 | 7/16×1 1/2 | 0.77 | PAFG403L-B | 420 | 420 |
| 1 1/4 | 32 | 1 7/16-12UN | 20.0 | 61 | 24 | 78 | 94 | 31.8 | 66.6 | 15.0** | M 14×50 | 1/2×1 3/4 | 1.15 | PAFG404L-A | 345 | 345 |
| 1 1/4 | 32 | 1 7/16-12UN | 20.0 | 61 | 24 | 78 | 94 | 31.8 | 66.6 | 13.3 | M 12×50 | – | 1.15 | PAFG404/12L-A | 345 | 345 |
| 1 1/4 | 32 | 1 11/16-12UN | 26.0 | 61 | 24 | 78 | 94 | 31.8 | 66.6 | 15.0** | M 14×50 | 1/2×1 3/4 | 1.15 | PAFG404L-B | 345 | 345 |
| 1 1/4 | 32 | 1 11/16-12UN | 26.0 | 61 | 24 | 78 | 94 | 31.8 | 66.6 | 13.3 | M 12×50 | – | 1.15 | PAFG404/12L-B | 345 | 345 |
| 1 1/2 | 38 | 1 11/16-12UN | 26.0 | 65 | 27 | 90 | 106 | 36.5 | 79.3 | 16.7 | M 16×55 | 5/8×2 1/4 | 1.66 | PAFG405L-A | 310 | 310 |
| 1 1/2 | 38 | 2-12UN | 32.0 | 67 | 27 | 90 | 106 | 36.5 | 79.3 | 16.7 | M 16×55 | 5/8×2 1/4 | 1.75 | PAFG405L-B | 310 | 310 |

** DB = 13.3 for UNC Bolts

***DB = 12 for UNC Bolts

¹⁾Pressure shown = Item deliverable

PN (bar) / 10 = PN (MPa)

Stainless steel parts may have dimensional deviations. Additional information on request.

*Please add the suffixes below according to the material/surface required.

| Order code suffixes | | | | | |
|---------------------------------|-----------------------------|----------------------------|--|--|---|
| Material | Suffix surface and material | Example only 4 bolt flange | Example 4 bolt flange incl. metr. bolts and O-ring | Example 4 bolt flange incl. UNC bolts and O-ring | Standard sealing material (no additional suffix needed) |
| Steel, zinc plated, Cr(VI)-free | CF | PAFG080L-ACF | PAFG080L-ACFM | PAFG080L-ACFU | NBR |
| Stainless steel | SS | PAFG080L-ASS | PAFG080L-ASSM | – | VIT |



SAE Full flanges

PAFG-90L SAE 90° 4 bolt flange with O-Lok® ORFS end

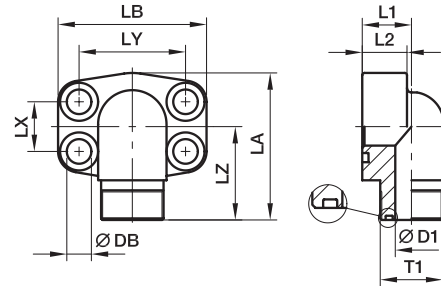
 SAE 90° Flange / O-Lok® ORFS end
 (ISO 6162-1/-2)

3000 PSI Series

| Nom. flange size | | T1 | D1 | L1 | L2 | LA | LB | LX | LY | LZ | DB | Bolts | | Weight (steel) kg/piece | Order code* | PN (bar) ¹⁾ CF SS | |
|------------------|----------|---------------------|------|----|----|----|----|------|------|------|---------|---------|------------|-------------------------|----------------------|------------------------------|-----|
| SAE (in.) | ISO (DN) | | | | | | | | | | | (metr.) | (unc.) | | | | |
| 1/2 | 13 | 11/16-16UN | 6.5 | 17 | 16 | 60 | 57 | 17.5 | 38.1 | 37.0 | 8.9 | M 08×30 | 5/16×1 1/4 | 0.31 | PAFG080/90L-A | 348 | 348 |
| 1/2 | 13 | 13/16-16UN | 9.5 | 17 | 16 | 60 | 57 | 17.5 | 38.1 | 39.0 | 8.9 | M 08×30 | 5/16×1 1/4 | 0.31 | PAFG080/90L-B | 348 | 348 |
| 1/2 | 13 | 1-14UN | 12.5 | 20 | 16 | 60 | 57 | 17.5 | 38.1 | 36.5 | 8.9 | M 08×30 | 5/16×1 1/4 | 0.31 | PAFG080/90L-C | 348 | 348 |
| 3/4 | 19 | 1-14UN | 12.5 | 20 | 18 | 63 | 66 | 22.3 | 47.6 | 44.0 | 10.6 | M 10×35 | 3/8×1 1/2 | 0.56 | PAFG100/90L-A | 348 | 348 |
| 3/4 | 19 | 1 3/16-12UN | 15.5 | 25 | 24 | 63 | 66 | 22.3 | 47.6 | 45.0 | 10.6 | M 10×35 | 3/8×1 1/2 | 0.60 | PAFG100/90L-B | 348 | 348 |
| 1 | 25 | 1 3/16-12UN | 15.5 | 25 | 22 | 80 | 72 | 26.2 | 52.4 | 48.0 | 10.6 | M 10×35 | 3/8×1 1/2 | 0.73 | PAFG102/90L-A | 348 | 348 |
| 1 | 25 | 1 7/16-12UN | 20.5 | 31 | 19 | 80 | 72 | 26.2 | 52.4 | 42.5 | 10.6 | M 10×35 | 3/8×1 1/2 | 0.64 | PAFG102/90L-B | 348 | 348 |
| 1 1/4 | 32 | 1 7/16-12UN | 20.5 | 31 | 22 | 84 | 80 | 30.2 | 58.7 | 55.0 | 10.6*** | M 10×40 | 7/16×1 1/2 | 1.15 | PAFG104/90L-A | 278 | 278 |
| 1 1/4 | 32 | 1 11/16-12UN | 26.5 | 31 | 22 | 84 | 80 | 30.2 | 58.7 | 55.0 | 10.6*** | M 10×40 | 7/16×1 1/2 | 1.08 | PAFG104/90L-B | 278 | 278 |
| 1 1/2 | 38 | 1 11/16-12UN | 26.5 | 36 | 25 | 88 | 94 | 35.7 | 69.9 | 59.0 | 13.3 | M 12×45 | 1/2×1 3/4 | 1.66 | PAFG106/90L-A | 210 | 210 |
| 1 1/2 | 38 | 2-12UN | 32.5 | 37 | 25 | 88 | 94 | 35.7 | 69.9 | 61.0 | 13.3 | M 12×45 | 1/2×1 3/4 | 1.60 | PAFG106/90L-B | 210 | 210 |

6000 PSI Series

| | | | | | | | | | | | | | | | | | |
|-------|----|---------------------|------|----|----|-----|-----|------|------|------|---------|---------|------------|------|-------------------------|-----|-----|
| 1/2 | 13 | 11/16-16UN | 6.5 | 17 | 16 | 60 | 57 | 17.5 | 38.1 | 37.0 | 8.9 | M 08×30 | 5/16×1 1/4 | 0.33 | PAFG401/90L-A | 420 | 420 |
| 1/2 | 13 | 13/16-16UN | 9.5 | 17 | 16 | 60 | 57 | 17.5 | 38.1 | 39.0 | 8.9 | M 08×30 | 5/16×1 1/4 | 0.33 | PAFG401/90L-B | 420 | 420 |
| 1/2 | 13 | 1-14UN | 12.5 | 20 | 16 | 60 | 57 | 17.5 | 38.1 | 40.0 | 8.9 | M 08×30 | 5/16×1 1/4 | 0.33 | PAFG401/90L-C | 420 | 420 |
| 3/4 | 19 | 1-14UN | 12.5 | 20 | 18 | 63 | 66 | 22.3 | 47.6 | 44.0 | 10.6 | M 10×35 | 3/8×1 1/2 | 0.70 | PAFG402/90L-A | 420 | 420 |
| 3/4 | 19 | 1 3/16-12UN | 15.5 | 25 | 24 | 63 | 66 | 22.3 | 47.6 | 45.0 | 10.6 | M 10×35 | 3/8×1 1/2 | 0.73 | PAFG402/90L-B | 420 | 420 |
| 1 | 25 | 1 3/16-12UN | 15.5 | 25 | 24 | 83 | 80 | 27.8 | 57.2 | 54.0 | 13.3*** | M 12×45 | 7/16×1 1/2 | 0.96 | PAFG403/90L-A | 420 | 420 |
| 1 | 25 | 1 7/16-12UN | 20.5 | 31 | 24 | 83 | 80 | 27.8 | 57.2 | 55.0 | 13.3*** | M 12×45 | 7/16×1 1/2 | 1.14 | PAFG403/90L-B | 420 | 420 |
| 1 1/4 | 32 | 1 7/16-12UN | 20.5 | 31 | 25 | 97 | 94 | 31.8 | 66.6 | 59.0 | 15.0** | M 14×50 | 1/2×1 3/4 | 1.76 | PAFG404/90L-A | 420 | 420 |
| 1 1/4 | 32 | 1 7/16-12UN | 25.0 | 31 | 25 | 97 | 94 | 31.8 | 66.6 | 59.0 | 13.3 | M 12×50 | – | 1.76 | PAFG404/12/90L-A | 420 | 420 |
| 1 1/4 | 32 | 1 11/16-12UN | 25.0 | 31 | 25 | 97 | 94 | 31.8 | 66.6 | 59.0 | 15.0** | M 14×50 | 1/2×1 3/4 | 1.71 | PAFG404/90L-B | 345 | 345 |
| 1 1/4 | 32 | 1 11/16-12UN | 25.0 | 31 | 25 | 97 | 94 | 31.8 | 66.6 | 59.0 | 13.3 | M 12×50 | – | 1.71 | PAFG404/12/90L-B | 345 | 345 |
| 1 1/2 | 38 | 1 11/16-12UN | 26.0 | 37 | 26 | 110 | 106 | 36.5 | 79.3 | 64.0 | 16.7 | M 16×55 | 5/8×2 1/4 | 2.69 | PAFG405/90L-A | 345 | 345 |
| 1 1/2 | 38 | 2-12UN | 26.0 | 37 | 26 | 110 | 106 | 36.5 | 79.3 | 66.0 | 16.7 | M 16×55 | 5/8×2 1/4 | 2.50 | PAFG405/90L-B | 310 | 310 |

** DB = 13.3 for UNC Bolts

***DB = 12 for UNC Bolts

1) Pressure shown = Item deliverable

 $\frac{PN \text{ (bar)}}{10} = PN \text{ (MPa)}$

Stainless steel parts may have dimensional deviations. Additional information on request.

*Please add the suffixes below according to the material/surface required.

| Order code suffixes | | | | | |
|---------------------------------|-----------------------------|----------------------------|--|--|---|
| Material | Suffix surface and material | Example only 4 bolt flange | Example 4 bolt flange incl. metr. bolts and O-ring | Example 4 bolt flange incl. UNC bolts and O-ring | Standard sealing material (no additional suffix needed) |
| Steel, zinc plated, Cr(VI)-free | CF | PAFG080/90L-ACF | PAFG080/90L-ACFM | PAFG080/90L-ACFU | NBR |
| Stainless steel | SS | PAFG080/90L-ASS | PAFG080/90L-ASSM | – | VIT |



PAFS-B SAE Straight 4 bolt flange (butt weld)

SAE Flange / Butt weld tube end
(ISO 6162-1/-2)

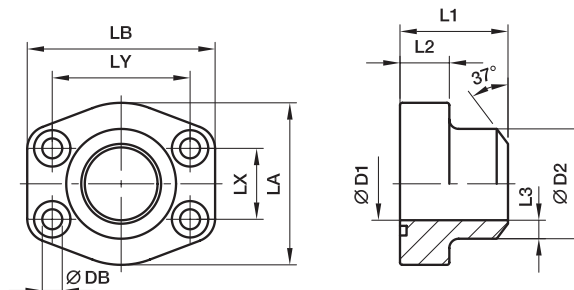

3000 PSI Series

| Nom. flange size | | max. | D1 | D2 | L1 | L2 | L3 | LA | LB | LX | LY | DB | Bolts | | Weight (steel) kg/piece | Order code* | PN (bar) ¹⁾ | |
|------------------|----------|-------|-----|-------|----|----|------|-----|-----|------|-------|---------|---------|------------|-------------------------|-----------------|------------------------|-----|
| SAE (in.) | ISO (DN) | | | | | | | | | | | | (metr.) | (unc.) | | | S | SS |
| 1/2 | 13 | 21.3 | 13 | 21.6 | 36 | 16 | 4.3 | 46 | 58 | 17.5 | 38.1 | 8.9 | M 08x30 | 5/16x1 1/4 | 0.28 | PAFS080B | 345 | 345 |
| 3/4 | 19 | 26.9 | 19 | 27.2 | 36 | 18 | 4.1 | 49 | 66 | 22.3 | 47.6 | 10.6 | M 10x35 | 3/8x1 1/2 | 0.36 | PAFS100B | 345 | 345 |
| 1 | 25 | 33.7 | 25 | 34.5 | 38 | 18 | 4.7 | 53 | 71 | 26.2 | 52.4 | 10.6 | M 10x35 | 3/8x1 1/2 | 0.46 | PAFS102B | 345 | 345 |
| 1 1/4 | 32 | 42.4 | 31 | 42.8 | 41 | 21 | 5.9 | 69 | 81 | 30.2 | 58.7 | 10.6*** | M 10x40 | 7/16x1 1/2 | 0.69 | PAFS104B | 276 | 276 |
| 1 1/2 | 38 | 48.3 | 38 | 48.6 | 44 | 25 | 5.3 | 77 | 94 | 35.7 | 69.9 | 13.3 | M 12x45 | 1/2x1 3/4 | 1.01 | PAFS106B | 207 | 207 |
| 2 | 51 | 60.3 | 50 | 61.0 | 45 | 25 | 5.5 | 89 | 103 | 42.9 | 77.8 | 13.3 | M 12x45 | 1/2x1 3/4 | 1.16 | PAFS108B | 207 | 207 |
| 2 1/2 | 64 | 76.1 | 63 | 76.6 | 50 | 25 | 6.8 | 101 | 115 | 50.8 | 88.9 | 13.3 | M 12x45 | 1/2x1 3/4 | 1.45 | PAFS110B | 172 | 172 |
| 3 | 76 | 88.9 | 73 | 89.0 | 50 | 27 | 8.0 | 124 | 135 | 61.9 | 106.4 | 16.7 | M 16x55 | 5/8x2 1/4 | 2.29 | PAFS112B | 138 | 138 |
| 3 1/2 | 89 | 101.6 | 89 | 103.0 | 50 | 27 | 7.0 | 134 | 153 | 69.9 | 120.7 | 16.7 | M 16x55 | 5/8x2 1/4 | 2.80 | PAFS114B | 34 | 34 |
| 4 | 102 | 114.3 | 99 | 115.0 | 50 | 27 | 8.0 | 147 | 163 | 77.8 | 130.2 | 16.7 | M 16x55 | 5/8x2 1/4 | 3.30 | PAFS116B | 34 | 34 |
| 5 | 127 | 140.0 | 120 | 141.0 | 50 | 28 | 10.5 | 180 | 184 | 92.1 | 152.4 | 16.7 | M 16x55 | 5/8x2 1/4 | 4.50 | PAFS118B | 34 | 34 |

6000 PSI Series

| | | | | | | | | | | | | | | | | | | |
|-------|----|------|----|------|----|----|------|-----|-----|------|-------|---------|----------|------------|-------|--------------------|-----|-----|
| 1/2 | 13 | 17.2 | 10 | 17.5 | 36 | 16 | 3.7 | 46 | 58 | 18.2 | 40.5 | 8.9 | M 08x30 | 5/16x1 1/4 | 0.28 | PAFS401B38 | 420 | 420 |
| 1/2 | 13 | 21.3 | 13 | 21.6 | 36 | 16 | 4.3 | 46 | 58 | 18.2 | 40.5 | 8.9 | M 08x30 | 5/16x1 1/4 | 0.28 | PAFS401B | 420 | 420 |
| 3/4 | 19 | 26.9 | 18 | 27.2 | 36 | 18 | 4.6 | 53 | 72 | 23.8 | 50.8 | 10.6 | M 10x35 | 3/8x1 1/2 | 0.48 | PAFS402B | 420 | 420 |
| 1 | 25 | 33.7 | 22 | 34.5 | 44 | 24 | 6.3 | 68 | 81 | 27.8 | 57.2 | 10.6*** | M 12x45 | 7/16x1 1/2 | 0.80 | PAFS403B | 420 | 420 |
| 1 1/4 | 32 | 42.4 | 28 | 42.8 | 44 | 27 | 7.4 | 78 | 95 | 31.8 | 66.6 | 15.0** | M 14x50 | 1/2x1 3/4 | 1.17 | PAFS404B | 420 | 420 |
| 1 1/4 | 32 | 42.4 | 28 | 42.8 | 44 | 27 | 7.4 | 78 | 95 | 31.8 | 66.6 | 13.3 | M 12x50 | - | 1.17 | PAFS404/12B | 420 | 420 |
| 1 1/2 | 38 | 48.3 | 32 | 48.6 | 51 | 30 | 8.3 | 89 | 106 | 36.5 | 79.4 | 16.7 | M 16x55 | 5/8x2 1/4 | 1.60 | PAFS405B | 420 | 420 |
| 2 | 51 | 60.3 | 41 | 61.0 | 70 | 37 | 10.0 | 116 | 135 | 44.5 | 96.8 | 20.6 | M 20x70 | 3/4x2 3/4 | 3.50 | PAFS406B | 420 | 420 |
| 2 1/2 | 64 | 76.1 | 50 | 76.6 | 75 | 45 | 13.0 | 150 | 166 | 58.7 | 123.8 | 25.0 | M 24x90 | - | 6.25 | PAFS407B | 420 | 420 |
| 3 | 76 | 88.9 | 58 | 90.0 | 90 | 55 | 16.0 | 178 | 208 | 71.4 | 152.4 | 32.0 | M 30x110 | - | 12.25 | PAFS408B | 420 | 420 |

** DB = 13.3 for UNC Bolts

***DB = 12 for UNC Bolts

¹⁾ Pressure shown = Item deliverable

PN (bar) = PN (MPa)
10

The pressures given here are the maximum allowable for the flange fittings. If the pipe or tube used has a lower pressure rating, then the welded assembly rating will be the lower one, assuming the weld is adequately strong.

Stainless steel parts may have dimensional deviations. Additional information on request.

*Please add the **suffixes** below according to the material/surface required.

| Order code suffixes | | | | | |
|-------------------------|-----------------------------|----------------------------|--|--|---|
| Material | Suffix surface and material | Example only 4 bolt flange | Example 4 bolt flange incl. metr. bolts and O-ring | Example 4 bolt flange incl. UNC bolts and O-ring | Standard sealing material (no additional suffix needed) |
| Steel, blanc oil dipped | S | PAFS080BS | PAFS080BSM | PAFS080BSU | NBR |
| Stainless steel | SS | PAFS080BSS | PAFS080BSSM | - | VIT |



SAE Full flanges

PGFS-B SAE Straight 4 bolt counter flange (butt weld)

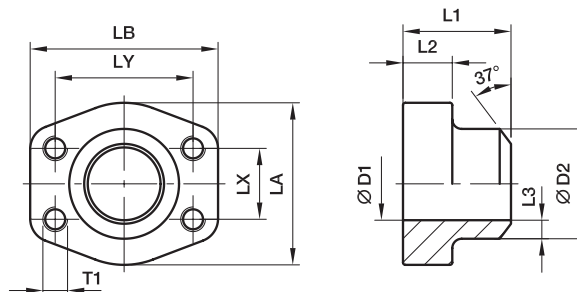
 SAE Counter flange / Butt weld tube end
(ISO 6162-1/-2)

3000 PSI Series

| Nom. flange size | | ⊕ max. | D1 | D2 | L1 | L2 | L3 | LA | LB | LX | LY | Bolts | | Weight (steel) kg/piece | Order code* | PN (bar) ¹⁾ | |
|------------------|-------------|-----------|-----|-------|----|----|------|-----|-----|------|-------|---------|--------|-------------------------------|-------------|---------------------------|-----|
| SAE (in.) | ISO (DN) | | | | | | | | | | | (metr.) | (unc.) | | | S | SS |
| 1/2 | 13 | 21.3 | 13 | 21.6 | 36 | 16 | 4.3 | 47 | 57 | 17.5 | 38.1 | M08 | 5/16 | 0.28 | PGFS080B | 345 | 345 |
| 3/4 | 19 | 26.9 | 19 | 27.2 | 36 | 18 | 4.1 | 49 | 66 | 22.3 | 47.6 | M10 | 3/8 | 0.38 | PGFS100B | 345 | 345 |
| 1 | 25 | 33.7 | 25 | 34.5 | 38 | 18 | 4.7 | 53 | 71 | 26.2 | 52.4 | M10 | 3/8 | 0.48 | PGFS102B | 345 | 345 |
| 1 1/4 | 32 | 42.4 | 31 | 42.8 | 41 | 21 | 5.9 | 69 | 80 | 30.2 | 58.7 | M10 | 7/16 | 0.74 | PGFS104B | 276 | 276 |
| 1 1/2 | 38 | 48.3 | 38 | 48.6 | 44 | 25 | 5.3 | 77 | 94 | 35.7 | 69.9 | M12 | 1/2 | 1.05 | PGFS106B | 207 | 207 |
| 2 | 51 | 60.3 | 50 | 61.0 | 45 | 25 | 5.5 | 89 | 103 | 42.9 | 77.8 | M12 | 1/2 | 1.21 | PGFS108B | 207 | 207 |
| 2 1/2 | 64 | 76.1 | 63 | 76.6 | 50 | 25 | 6.8 | 101 | 115 | 50.8 | 88.9 | M12 | 1/2 | 1.52 | PGFS110B | 172 | 172 |
| 3 | 76 | 88.9 | 73 | 89.0 | 50 | 27 | 8.0 | 124 | 135 | 61.9 | 106.4 | M16 | 5/8 | 2.34 | PGFS112B | 138 | 138 |
| 3 1/2 | 89 | 101.6 | 89 | 103.0 | 50 | 27 | 7.0 | 134 | 153 | 69.9 | 120.7 | M16 | 5/8 | 3.04 | PGFS114B | 34 | 34 |
| 4 | 102 | 114.3 | 99 | 115.0 | 50 | 27 | 8.0 | 147 | 163 | 77.8 | 130.2 | M16 | 5/8 | 3.36 | PGFS116B | 34 | 34 |
| 5 | 127 | 140.0 | 120 | 141.0 | 50 | 28 | 10.5 | 180 | 184 | 92.1 | 152.4 | M16 | 5/8 | 4.55 | PGFS118B | 34 | 34 |

6000 PSI Series

| | | | | | | | | | | | | | | | | | |
|-------|----|------|----|------|----|----|------|-----|-----|------|-------|-----|------|-------|-------------|-----|-----|
| 1/2 | 13 | 17.2 | 10 | 17.5 | 36 | 16 | 3.7 | 47 | 57 | 18.2 | 40.5 | M08 | 5/16 | 0.29 | PGFS401B38 | 420 | 420 |
| 1/2 | 13 | 21.3 | 13 | 21.6 | 36 | 16 | 4.3 | 47 | 57 | 18.2 | 40.5 | M08 | 5/16 | 0.29 | PGFS401B | 420 | 420 |
| 3/4 | 19 | 26.9 | 18 | 27.2 | 36 | 19 | 4.6 | 53 | 71 | 23.8 | 50.8 | M10 | 3/8 | 0.52 | PGFS402B | 420 | 420 |
| 1 | 25 | 33.7 | 22 | 34.5 | 44 | 24 | 6.3 | 66 | 82 | 27.8 | 57.2 | M12 | 7/16 | 0.85 | PGFS403B | 420 | 420 |
| 1 1/4 | 32 | 42.4 | 28 | 42.8 | 44 | 27 | 7.4 | 78 | 95 | 31.8 | 66.6 | M14 | 1/2 | 1.23 | PGFS404B | 420 | 420 |
| 1 1/4 | 32 | 42.4 | 28 | 42.8 | 44 | 27 | 7.4 | 78 | 95 | 31.8 | 66.6 | M12 | - | 1.23 | PGFS404/12B | 420 | 420 |
| 1 1/2 | 38 | 48.3 | 32 | 48.6 | 51 | 30 | 8.3 | 89 | 106 | 36.5 | 79.3 | M16 | 5/8 | 1.71 | PGFS405B | 420 | 420 |
| 2 | 51 | 60.3 | 41 | 61.0 | 70 | 37 | 10.0 | 116 | 135 | 44.5 | 96.8 | M20 | 3/4 | 3.56 | PGFS406B | 420 | 420 |
| 2 1/2 | 64 | 76.1 | 50 | 76.6 | 75 | 45 | 13.0 | 150 | 166 | 58.7 | 123.8 | M24 | - | 6.94 | PGFS407B | 420 | 420 |
| 3 | 76 | 88.9 | 58 | 90.0 | 90 | 55 | 16.0 | 178 | 208 | 71.4 | 152.4 | M30 | - | 12.60 | PGFS408B | 420 | 420 |

¹⁾Pressure shown = Item deliverable

$$\frac{\text{PN (bar)}}{10} = \text{PN (MPa)}$$

The pressures given here are the maximum allowable for the flange fittings. If the pipe or tube used has a lower pressure rating, then the welded assembly rating will be the lower one, assuming the weld is adequately strong.

Stainless steel parts may have dimensional deviations. Additional information on request.

*Please add the suffixes below according to the material/surface required.

| Order code suffixes | | | | |
|-------------------------|-----------------------------|--|--|---|
| Material | Suffix surface and material | Example 4 bolt flange with metr. threads | Example 4 bolt flange with UNC threads | Standard sealing material (no additional suffix needed) |
| Steel, blanc oil dipped | S | PGFS080BSM | PGFS080BSU | NBR |
| Stainless steel | SS | PGFS080BSSM | PGFS080BSSU | VIT |



PAFS-90B SAE 90° 4 bolt flange (butt weld)

SAE 90° Flange / Butt weld tube end
(ISO 6162-1/-2)

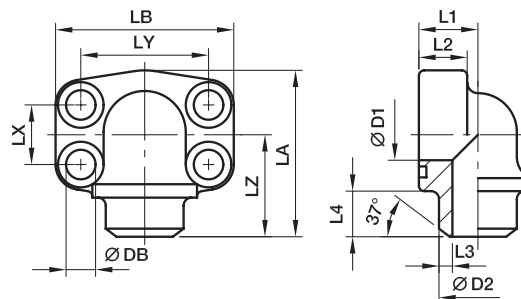

3000 PSI Series

| Nom. flange size | | max. | | | | | | | | | | | | | Bolts | | Weight (steel) kg/piece | Order code* | PN (bar) ¹⁾ | |
|------------------|----------|------|----|------|----|----|-----|----|-----|-----|------|------|----|---------|---------|------------|-------------------------|-------------|------------------------|-----|
| SAE (in.) | ISO (DN) | | D1 | D2 | L1 | L2 | L3 | L4 | LA | LB | LX | LY | LZ | DB | (metr.) | (unc.) | | | S | SS |
| 1/2 | 13 | 21.3 | 13 | 21.6 | 18 | 16 | 4.3 | 12 | 63 | 57 | 17.5 | 38.1 | 40 | 8.9 | M 08x30 | 5/16x1 1/4 | 0.31 | PAFS080/90B | 345 | 345 |
| 3/4 | 19 | 26.9 | 19 | 27.2 | 22 | 18 | 4.1 | 12 | 66 | 68 | 22.3 | 47.6 | 41 | 10.6 | M 10x35 | 3/8x1 1/2 | 0.48 | PAFS100/90B | 345 | 345 |
| 1 | 25 | 33.7 | 25 | 34.5 | 28 | 19 | 4.7 | 13 | 77 | 74 | 26.2 | 52.4 | 50 | 10.6 | M 10x35 | 3/8x1 1/2 | 0.72 | PAFS102/90B | 345 | 345 |
| 1 1/4 | 32 | 42.4 | 31 | 42.8 | 30 | 22 | 6.0 | 13 | 91 | 81 | 30.2 | 58.7 | 57 | 10.6*** | M 10x40 | 7/16x1 1/2 | 1.01 | PAFS104/90B | 276 | 276 |
| 1 1/2 | 38 | 48.3 | 38 | 48.6 | 36 | 25 | 5.3 | 14 | 105 | 95 | 35.7 | 69.9 | 66 | 13.3 | M 12x45 | 1/2x1 3/4 | 1.32 | PAFS106/90B | 207 | 207 |
| 2 | 51 | 60.3 | 50 | 61.0 | 41 | 25 | 5.5 | 15 | 110 | 105 | 42.9 | 77.8 | 66 | 13.3 | M 12x45 | 1/2x1 3/4 | 1.74 | PAFS108/90B | 207 | 207 |
| 2 1/2 | 64 | 76.1 | 60 | 76.6 | 50 | 25 | 8.0 | 25 | 127 | 115 | 50.8 | 88.9 | 77 | 13.3 | M 12x45 | 1/2x1 3/4 | 2.79 | PAFS110/90B | 172 | 172 |

6000 PSI Series

| | | | | | | | | | | | | | | | | | | | | |
|-------|----|------|----|------|----|----|------|----|-----|-----|------|------|----|---------|---------|------------|------|----------------|-----|-----|
| 1/2 | 13 | 21.3 | 13 | 21.6 | 18 | 16 | 4.3 | 12 | 63 | 56 | 18.2 | 40.5 | 40 | 8.9 | M 08x30 | 5/16x1 1/4 | 0.31 | PAFS401/90B | 420 | 420 |
| 3/4 | 19 | 26.9 | 18 | 27.2 | 28 | 20 | 4.6 | 12 | 77 | 72 | 23.8 | 50.8 | 50 | 10.6 | M 10x35 | 3/8x1 1/2 | 0.76 | PAFS402/90B | 420 | 420 |
| 1 | 25 | 33.7 | 22 | 34.5 | 26 | 24 | 6.3 | 13 | 91 | 82 | 27.8 | 57.2 | 57 | 13.3*** | M 12x45 | 7/16x1 1/2 | 0.91 | PAFS403/90B | 420 | 420 |
| 1 1/4 | 32 | 42.4 | 28 | 42.8 | 36 | 25 | 7.4 | 13 | 105 | 95 | 31.8 | 66.6 | 66 | 15.0** | M 14x50 | 1/2x1 3/4 | 1.65 | PAFS404/90B | 420 | 420 |
| 1 1/4 | 32 | 42.4 | 28 | 42.8 | 36 | 25 | 7.4 | 13 | 105 | 95 | 31.8 | 66.6 | 66 | 13.3* | M 12x50 | - | 1.65 | PAFS404/12/90B | 420 | 420 |
| 1 1/2 | 38 | 48.3 | 32 | 48.6 | 41 | 26 | 8.3 | 15 | 109 | 110 | 36.5 | 79.3 | 65 | 16.7 | M 16x55 | 5/8x2 1/4 | 2.37 | PAFS405/90B | 420 | 420 |
| 2 | 51 | 60.3 | 41 | 61.0 | 45 | 35 | 10.0 | 15 | 133 | 134 | 44.5 | 96.8 | 75 | 20.6 | M 20x70 | 3/4x2 3/4 | 4.06 | PAFS406/90B | 420 | 420 |

** DB = 13.3 for UNC Bolts

***DB = 12 for UNC Bolts

¹⁾ Pressure shown = Item deliverable

PN (bar) = PN (MPa) / 10

The pressures given here are the maximum allowable for the flange fittings. If the pipe or tube used has a lower pressure rating, then the welded assembly rating will be the lower one, assuming the weld is adequately strong.

Stainless steel parts may have dimensional deviations. Additional information on request.



*Please add the suffixes below according to the material/surface required.

| Order code suffixes | | | | | |
|-------------------------|-----------------------------|----------------------------|--|--|---|
| Material | Suffix surface and material | Example only 4 bolt flange | Example 4 bolt flange incl. metr. bolts and O-ring | Example 4 bolt flange incl. UNC bolts and O-ring | Standard sealing material (no additional suffix needed) |
| Steel, blanc oil dipped | S | PAFS080/90BS | PAFS080/90BSM | PAFS080/90BSU | NBR |
| Stainless steel | SS | PAFS080/90BSS | PAFS080/90BSSM | - | VIT |



SAE Full flanges

PAFS-S SAE Straight 4 bolt flange (socket weld)

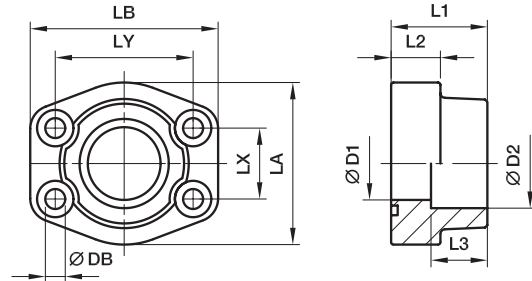
 SAE Flange / Socket weld tube end
(ISO 6162-1/-2)

3000 PSI Series

| Nom. flange size | | ⌀ | | | | | | | | | | | | Bolts | | Weight (steel) kg/piece | Order code* | PN (bar) ¹⁾ | |
|------------------|----------|-------|------|-------|----|----|----|-----|-----|------|-------|---------|---------|------------|--------|-------------------------|-------------|------------------------|----|
| SAE (in.) | ISO (DN) | | max. | D1 | D2 | L1 | L2 | L3 | LA | LB | LX | LY | DB | (metr.) | (unc.) | | | S | SS |
| 1/2 | 13 | 17.2 | 13 | 17.5 | 36 | 16 | 18 | 47 | 58 | 17.5 | 38.1 | 8.9 | M 08×30 | 5/16×1 1/4 | 0.30 | PAFS080S17.5 | 345 | 345 | |
| 1/2 | 13 | 21.3 | 13 | 21.6 | 36 | 16 | 18 | 47 | 58 | 17.5 | 38.1 | 8.9 | M 08×30 | 5/16×1 1/4 | 0.28 | PAFS080S21.6 | 345 | 345 | |
| 3/4 | 19 | 26.9 | 19 | 27.2 | 36 | 18 | 18 | 49 | 66 | 22.3 | 47.6 | 10.6 | M 10×35 | 3/8×1 1/2 | 0.40 | PAFS100S27.2 | 345 | 345 | |
| 1 | 25 | 33.7 | 25 | 34.1 | 38 | 18 | 18 | 53 | 70 | 26.2 | 52.4 | 10.6 | M 10×35 | 3/8×1 1/2 | 0.50 | PAFS102S34.1 | 345 | 345 | |
| 1 1/4 | 32 | 42.4 | 31 | 42.8 | 41 | 21 | 20 | 69 | 80 | 30.2 | 58.7 | 10.6*** | M 10×40 | 7/16×1 1/2 | 0.72 | PAFS104S42.8 | 276 | 276 | |
| 1 1/2 | 38 | 48.3 | 38 | 48.6 | 44 | 25 | 22 | 77 | 94 | 35.7 | 69.9 | 13.3 | M 12×45 | 1/2×1 3/4 | 1.08 | PAFS106S48.6 | 207 | 207 | |
| 2 | 51 | 60.3 | 50 | 61.0 | 45 | 25 | 24 | 89 | 103 | 42.9 | 77.8 | 13.3 | M 12×45 | 1/2×1 3/4 | 1.16 | PAFS108S61 | 207 | 207 | |
| 2 1/2 | 64 | 76.1 | 63 | 76.6 | 50 | 25 | 28 | 101 | 115 | 50.8 | 88.9 | 13.3 | M 12×45 | 1/2×1 3/4 | 1.40 | PAFS110S76.6 | 172 | 172 | |
| 3 | 76 | 88.9 | 73 | 90.5 | 50 | 27 | 28 | 124 | 135 | 61.9 | 106.4 | 16.7 | M 16×55 | 5/8×2 1/4 | 2.23 | PAFS112S90.5 | 138 | 138 | |
| 3 1/2 | 89 | 101.6 | 89 | 103.0 | 50 | 27 | 28 | 137 | 153 | 69.9 | 120.7 | 16.7 | M 16×55 | 5/8×2 1/4 | 2.92 | PAFS114S103 | 34 | 34 | |
| 4 | 102 | 114.3 | 99 | 115.5 | 50 | 27 | 28 | 147 | 163 | 77.8 | 130.2 | 16.7 | M 16×55 | 5/8×2 1/4 | 3.05 | PAFS116S115.5 | 34 | 34 | |
| 5 | 127 | 140.0 | 120 | 142.0 | 50 | 28 | 28 | 180 | 184 | 92.1 | 152.4 | 16.7 | M 16×55 | 5/8×2 1/4 | 4.21 | PAFS118S142 | 34 | 34 | |

6000 PSI Series

| | | | | | | | | | | | | | | | | | | |
|-------|----|------|----|------|----|----|----|-----|-----|------|-------|---------|----------|------------|-------|-----------------|-----|-----|
| 1/2 | 13 | 17.2 | 13 | 17.5 | 36 | 16 | 18 | 47 | 58 | 18.2 | 40.5 | 8.9 | M 08×30 | 5/16×1 1/4 | 0.30 | PAFS401S17.5 | 420 | 420 |
| 1/2 | 13 | 21.3 | 13 | 21.6 | 36 | 16 | 18 | 47 | 58 | 18.2 | 40.5 | 8.9 | M 08×30 | 5/16×1 1/4 | 0.29 | PAFS401S21.6 | 420 | 420 |
| 3/4 | 19 | 26.9 | 19 | 27.2 | 36 | 19 | 20 | 53 | 71 | 23.8 | 50.8 | 10.6 | M 10×35 | 3/8×1 1/2 | 0.53 | PAFS402S27.2 | 420 | 420 |
| 1 | 25 | 33.7 | 25 | 34.1 | 44 | 24 | 22 | 66 | 80 | 27.8 | 57.2 | 13.3*** | M 12×45 | 7/16×1 1/2 | 0.85 | PAFS403S34.1 | 420 | 420 |
| 1 1/4 | 32 | 42.4 | 31 | 42.8 | 44 | 27 | 22 | 77 | 94 | 31.8 | 66.6 | 15.0** | M 14×50 | 1/2×1 3/4 | 1.16 | PAFS404S42.8 | 420 | 420 |
| 1 1/4 | 32 | 42.4 | 31 | 42.8 | 44 | 27 | 22 | 77 | 94 | 31.8 | 66.6 | 13.3 | M 12×50 | – | 1.16 | PAFS404/12S42.8 | 420 | 420 |
| 1 1/2 | 38 | 48.3 | 38 | 48.6 | 51 | 30 | 24 | 89 | 106 | 36.5 | 79.3 | 16.7 | M 16×55 | 5/8×2 1/4 | 1.65 | PAFS405S48.6 | 420 | 420 |
| 2 | 51 | 60.3 | 50 | 61.0 | 70 | 37 | 25 | 116 | 135 | 44.5 | 96.8 | 20.6 | M 20×70 | 3/4×2 3/4 | 3.63 | PAFS406S61 | 420 | 420 |
| 2 1/2 | 64 | 76.1 | 63 | 76.6 | 75 | 45 | 28 | 150 | 166 | 58.7 | 123.8 | 25.0 | M 24×90 | – | 6.77 | PAFS407S76.6 | 420 | 420 |
| 3 | 76 | 88.9 | 73 | 90.5 | 90 | 55 | 30 | 178 | 208 | 71.4 | 152.4 | 32.0 | M 30×110 | – | 12.38 | PAFS408S90.5 | 420 | 420 |

** DB = 13.3 for UNC Bolts

***DB = 12 for UNC Bolts

1) Pressure shown = Item deliverable

$$\frac{PN \text{ (bar)}}{10} = PN \text{ (MPa)}$$

The pressures given here are the maximum allowable for the flange fittings. If the pipe or tube used has a lower pressure rating, then the welded assembly rating will be the lower one, assuming the weld is adequately strong.

Stainless steel parts may have dimensional deviations. Additional information on request.

*Please add the suffixes below according to the material/surface required.

| Order code suffixes | | | | | |
|-------------------------|-----------------------------|----------------------------|--|--|---|
| Material | Suffix surface and material | Example only 4 bolt flange | Example 4 bolt flange incl. metr. bolts and O-ring | Example 4 bolt flange incl. UNC bolts and O-ring | Standard sealing material (no additional suffix needed) |
| Steel, blanc oil dipped | S | PAFS080S17.5S | PAFS080S17.5SM | PAFS080S17.5SU | NBR |
| Stainless steel | SS | PAFS080S17.5SS | PAFS080S17.5SSM | – | VIT |



PGFS-S SAE Straight counter 4 bolt flange (socket weld)

SAE Counter flange / Socket weld tube end
(ISO 6162-1/-2)

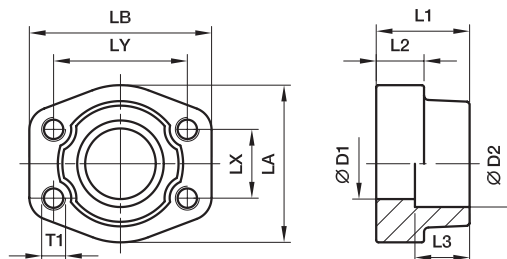

3000 PSI Series

| Nom. flange size | | ⌀ | D1 | D2 | L1 | L2 | L3 | LA | LB | LX | LY | DB | Bolts | | Weight (steel) kg/piece | Order code* | PN (bar) ¹⁾ | |
|------------------|----------|-------|-----|-------|----|----|----|-----|-----|------|-------|---------|---------|--------|-------------------------|---------------|------------------------|-----|
| SAE (in.) | ISO (DN) | | | | | | | | | | | | (metr.) | (unc.) | | | S | SS |
| 1/2 | 13 | 17.2 | 13 | 17.5 | 36 | 16 | 18 | 47 | 58 | 17.5 | 38.1 | 8.9 | M 8 | 5/16 | 0.33 | PGFS080S17.5 | 345 | 345 |
| 1/2 | 13 | 21.3 | 13 | 21.6 | 36 | 16 | 18 | 47 | 58 | 17.5 | 38.1 | 8.9 | M 8 | 5/16 | 0.32 | PGFS080S21.6 | 345 | 345 |
| 3/4 | 19 | 26.9 | 19 | 27.2 | 36 | 18 | 18 | 49 | 66 | 22.3 | 47.6 | 10.6 | M10 | 3/8 | 0.42 | PGFS100S27.2 | 345 | 345 |
| 1 | 25 | 33.7 | 25 | 34.1 | 38 | 18 | 18 | 53 | 70 | 26.2 | 52.4 | 10.6 | M10 | 3/8 | 0.53 | PGFS102S34.1 | 345 | 345 |
| 1 1/4 | 32 | 42.4 | 31 | 42.8 | 41 | 21 | 20 | 69 | 80 | 30.2 | 58.7 | 10.6*** | M10 | 7/16 | 0.77 | PGFS104S42.8 | 276 | 276 |
| 1 1/2 | 38 | 48.3 | 38 | 48.6 | 44 | 25 | 22 | 77 | 94 | 35.7 | 69.9 | 13.3 | M12 | 1/2 | 1.14 | PGFS106S48.6 | 207 | 207 |
| 2 | 51 | 60.3 | 50 | 61.0 | 45 | 25 | 24 | 89 | 103 | 42.9 | 77.8 | 13.3 | M12 | 1/2 | 1.22 | PGFS108S61 | 207 | 207 |
| 2 1/2 | 64 | 76.1 | 63 | 76.6 | 50 | 25 | 28 | 101 | 115 | 50.8 | 88.9 | 13.3 | M12 | 1/2 | 1.50 | PGFS110S76.6 | 172 | 172 |
| 3 | 76 | 88.9 | 73 | 90.5 | 50 | 27 | 28 | 124 | 135 | 61.9 | 106.4 | 16.7 | M16 | 5/8 | 2.30 | PGFS112S90.5 | 138 | 138 |
| 3 1/2 | 89 | 101.6 | 89 | 103.0 | 50 | 27 | 28 | 137 | 153 | 69.9 | 120.7 | 16.7 | M16 | 5/8 | 2.64 | PGFS114S103 | 34 | 34 |
| 4 | 102 | 114.3 | 99 | 115.5 | 50 | 27 | 28 | 147 | 163 | 77.8 | 130.2 | 16.7 | M16 | 5/8 | 3.11 | PGFS116S115.5 | 34 | 34 |
| 5 | 127 | 140.0 | 120 | 142.0 | 50 | 28 | 28 | 180 | 184 | 92.1 | 152.4 | 16.7 | M16 | 5/8 | 4.31 | PGFS118S142 | 34 | 34 |

6000 PSI Series

| | | | | | | | | | | | | | | | | | | |
|-------|----|------|----|------|----|----|----|-----|-----|------|-------|---------|-----|------|-------|-----------------|-----|-----|
| 1/2 | 13 | 17.2 | 13 | 17.5 | 36 | 16 | 18 | 47 | 58 | 18.2 | 40.5 | 8.9 | M 8 | 5/16 | 0.33 | PGFS401S17.5 | 420 | 420 |
| 1/2 | 13 | 21.3 | 13 | 21.6 | 36 | 16 | 18 | 47 | 58 | 18.2 | 40.5 | 8.9 | M 8 | 5/16 | 0.30 | PGFS401S21.6 | 420 | 420 |
| 3/4 | 19 | 26.9 | 19 | 27.2 | 36 | 19 | 20 | 53 | 71 | 23.8 | 50.8 | 10.6 | M10 | 3/8 | 0.57 | PGFS402S27.2 | 420 | 420 |
| 1 | 25 | 33.7 | 25 | 34.1 | 44 | 24 | 22 | 66 | 80 | 27.8 | 57.2 | 13.3*** | M12 | 7/16 | 0.89 | PGFS403S34.1 | 420 | 420 |
| 1 1/4 | 32 | 42.4 | 31 | 42.8 | 44 | 27 | 22 | 77 | 94 | 31.8 | 66.6 | 15.0** | M14 | 1/2 | 1.22 | PGFS404S42.8 | 420 | 420 |
| 1 1/4 | 32 | 42.4 | 31 | 42.8 | 44 | 27 | 22 | 77 | 94 | 31.8 | 66.6 | 13.3 | M12 | - | 1.22 | PGFS404/12S42.8 | 420 | 420 |
| 1 1/2 | 38 | 48.3 | 38 | 48.6 | 51 | 30 | 24 | 89 | 106 | 36.5 | 79.3 | 16.7 | M16 | 5/8 | 1.78 | PGFS405S48.6 | 420 | 420 |
| 2 | 51 | 60.3 | 50 | 61.0 | 50 | 37 | 25 | 116 | 135 | 44.5 | 96.8 | 20.6 | M20 | 3/4 | 3.76 | PGFS406S61 | 420 | 420 |
| 2 1/2 | 64 | 76.1 | 63 | 76.6 | 75 | 45 | 28 | 150 | 166 | 58.7 | 123.8 | 25.0 | M24 | - | 7.28 | PGFS407S76.6 | 420 | 420 |
| 3 | 76 | 88.9 | 73 | 90.5 | 90 | 55 | 30 | 178 | 208 | 71.4 | 152.4 | 30.0 | M30 | - | 12.60 | PGFS408S90.5 | 420 | 420 |

**DB = 13.3 for UNC Bolts

***DB = 12 for UNC Bolts

¹⁾Pressure shown = Item deliverable

PN (bar) = PN (MPa) / 10

The pressures given here are the maximum allowable for the flange fittings. If the pipe or tube used has a lower pressure rating, then the welded assembly rating will be the lower one, assuming the weld is adequately strong.

Stainless steel parts may have dimensional deviations. Additional information on request.

*Please add the suffixes below according to the material/surface required.

| Order code suffixes | | | | |
|-------------------------|-----------------------------|--|--|---|
| Material | Suffix surface and material | Example 4 bolt flange with metr. threads | Example 4 bolt flange with UNC threads | Standard sealing material (no additional suffix needed) |
| Steel, blanc oil dipped | S | PGFS080S17.5SM | PGFS080S17.5SU | NBR |
| Stainless steel | SS | PGFS080S17.5SSM | PGFS080S17.5SSU | VIT |



SAE Full flanges

PAFSF-S SAE Straight 4 bolt flange flat (socket weld)

 SAE Flange / Socket weld tube end
(ISO 6162-1/-2)

only for low pressure applications

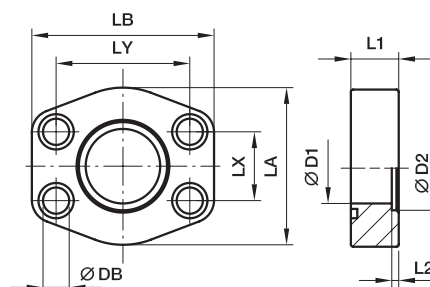
3000 PSI Series

| Nom. flange size | | ⌀ | | | | | | | | | | | Bolts | | Weight (steel) kg/piece | Order code* | PN (bar) ¹⁾ | |
|------------------|----------|-------|------|-------|----|----|-----|-----|------|-------|---------|---------|------------|--------|-------------------------|-------------|------------------------|----|
| SAE (in.) | ISO (DN) | | max. | D1 | D2 | L1 | L2 | LA | LB | LX | LY | DB | (metr.) | (unc.) | | | S | SS |
| 1/2 | 13 | 17.2 | 13 | 17.5 | 16 | 3 | 47 | 58 | 17.5 | 38.1 | 8.9 | M 08x30 | 5/16x1 1/4 | 0.12 | PAFSF080S17.5 | 40 | 40 | |
| 1/2 | 13 | 21.3 | 13 | 21.6 | 16 | 3 | 47 | 58 | 17.5 | 38.1 | 8.9 | M 08x30 | 5/16x1 1/4 | 0.12 | PAFSF080S21.6 | 40 | 40 | |
| 3/4 | 19 | 21.3 | 13 | 21.6 | 18 | 4 | 49 | 66 | 22.3 | 47.6 | 10.6 | M 10x35 | 3/8x1 1/2 | 0.20 | PAFSF100S21.6 | 40 | 40 | |
| 3/4 | 19 | 26.9 | 19 | 27.2 | 18 | 4 | 49 | 66 | 22.3 | 47.6 | 10.6 | M 10x35 | 3/8x1 1/2 | 0.20 | PAFSF100S27.2 | 40 | 40 | |
| 1 | 25 | 26.9 | 19 | 27.2 | 19 | 4 | 53 | 71 | 26.2 | 52.4 | 10.6 | M 10x35 | 3/8x1 1/2 | 0.38 | PAFSF102S27.2 | 40 | 40 | |
| 1 | 25 | 33.7 | 25 | 34.5 | 19 | 4 | 53 | 71 | 26.2 | 52.4 | 10.6 | M 10x35 | 3/8x1 1/2 | 0.35 | PAFSF102S34.5 | 40 | 40 | |
| 1 1/4 | 32 | 33.7 | 25 | 34.5 | 21 | 4 | 69 | 80 | 30.2 | 58.7 | 10.6*** | M 10x40 | 7/16x1 1/2 | 0.40 | PAFSF104S34.5 | 40 | 40 | |
| 1 1/4 | 32 | 42.4 | 31 | 42.8 | 21 | 4 | 69 | 80 | 30.2 | 58.7 | 10.6*** | M 10x40 | 7/16x1 1/2 | 0.56 | PAFSF104S42.8 | 40 | 40 | |
| 1 1/2 | 38 | 42.4 | 31 | 42.8 | 25 | 4 | 77 | 95 | 35.7 | 69.9 | 13.3 | M 12x45 | 1/2x1 3/4 | 0.94 | PAFSF106S42.8 | 40 | 40 | |
| 1 1/2 | 38 | 48.3 | 38 | 48.6 | 25 | 4 | 77 | 95 | 35.7 | 69.9 | 13.3 | M 12x45 | 1/2x1 3/4 | 0.88 | PAFSF106S48.6 | 40 | 40 | |
| 2 | 51 | 48.3 | 38 | 48.6 | 25 | 4 | 89 | 103 | 42.9 | 77.8 | 13.3 | M 12x45 | 1/2x1 3/4 | 1.08 | PAFSF108S48.6 | 40 | 40 | |
| 2 | 51 | 60.3 | 50 | 61.0 | 25 | 4 | 89 | 103 | 42.9 | 77.8 | 13.3 | M 12x45 | 1/2x1 3/4 | 0.95 | PAFSF108S61.0 | 40 | 40 | |
| 2 1/2 | 64 | 60.3 | 50 | 61.0 | 25 | 5 | 101 | 116 | 50.8 | 88.9 | 13.3 | M 12x45 | 1/2x1 3/4 | 1.41 | PAFSF110S61.0 | 40 | 40 | |
| 2 1/2 | 64 | 76.1 | 63 | 76.6 | 25 | 5 | 101 | 116 | 50.8 | 88.9 | 13.3 | M 12x45 | 1/2x1 3/4 | 1.39 | PAFSF110S76.6 | 40 | 40 | |
| 3 | 76 | 76.1 | 63 | 76.6 | 27 | 5 | 124 | 136 | 61.9 | 106.4 | 16.7 | M 16x55 | 5/8x2 1/4 | 2.12 | PAFSF112S76.6 | 30 | 30 | |
| 3 | 76 | 88.9 | 73 | 90.5 | 27 | 5 | 124 | 136 | 61.9 | 106.4 | 16.7 | M 16x55 | 5/8x2 1/4 | 1.85 | PAFSF112S90.5 | 30 | 30 | |
| 3 1/2 | 89 | 88.9 | 73 | 90.5 | 27 | 5 | 136 | 152 | 69.9 | 120.7 | 16.7 | M 16x55 | 5/8x2 1/4 | 2.75 | PAFSF114S90.5 | 30 | 30 | |
| 3 1/2 | 89 | 101.6 | 89 | 103.0 | 27 | 5 | 136 | 152 | 69.9 | 120.7 | 16.7 | M 16x55 | 5/8x2 1/4 | 2.30 | PAFSF114S103 | 30 | 30 | |
| 4 | 102 | 101.6 | 89 | 103.0 | 27 | 6 | 146 | 162 | 77.8 | 130.2 | 16.7 | M 16x55 | 5/8x2 1/4 | 2.89 | PAFSF116S103 | 30 | 30 | |
| 4 | 102 | 114.3 | 99 | 115.5 | 24 | 6 | 146 | 162 | 77.8 | 130.2 | 16.7 | M 16x55 | 5/8x2 1/4 | 2.62 | PAFSF116S115.5 | 30 | 30 | |
| 5 | 127 | 114.3 | 99 | 115.5 | 28 | 6 | 180 | 184 | 92.1 | 152.4 | 16.7 | M 16x55 | 5/8x2 1/4 | 3.50 | PAFSF118S115.5 | 30 | 30 | |
| 5 | 127 | 140.0 | 120 | 142.5 | 28 | 6 | 180 | 184 | 92.1 | 152.4 | 16.7 | M 16x55 | 5/8x2 1/4 | 3.42 | PAFSF118S142.5 | 30 | 30 | |

6000 PSI Series

| | | | | | | | | | | | | | | | | | |
|-------|----|------|----|------|----|---|-----|-----|------|------|---------|---------|------------|------|------------------|----|----|
| 1/2 | 13 | 17.2 | 13 | 17.5 | 16 | 4 | 47 | 58 | 18.2 | 40.5 | 8.9 | M 08x30 | 5/16x1 1/4 | 0.25 | PAFSF401S17.5 | 40 | 40 |
| 1/2 | 13 | 21.3 | 13 | 21.6 | 16 | 4 | 47 | 58 | 18.2 | 40.5 | 8.9 | M 08x30 | 5/16x1 1/4 | 0.25 | PAFSF401S21.6 | 40 | 40 |
| 3/4 | 19 | 21.3 | 13 | 21.6 | 19 | 4 | 53 | 71 | 23.8 | 50.8 | 10.6 | M 10x35 | 3/8x1 1/2 | 0.50 | PAFSF402S21.6 | 40 | 40 |
| 3/4 | 19 | 26.9 | 19 | 27.2 | 19 | 4 | 53 | 71 | 23.8 | 50.8 | 10.6 | M 10x35 | 3/8x1 1/2 | 0.50 | PAFSF402S27.2 | 40 | 40 |
| 1 | 25 | 26.9 | 19 | 27.2 | 24 | 4 | 66 | 80 | 27.8 | 57.2 | 13.3*** | M 12x45 | 7/16x1 1/2 | 0.73 | PAFSF403S27.2 | 40 | 40 |
| 1 | 25 | 33.7 | 25 | 34.5 | 24 | 4 | 66 | 80 | 27.8 | 57.2 | 13.3*** | M 12x45 | 7/16x1 1/2 | 0.68 | PAFSF403S34.5 | 40 | 40 |
| 1 1/4 | 32 | 33.7 | 25 | 34.5 | 27 | 4 | 77 | 94 | 31.8 | 66.6 | 15.0** | M 14x50 | 1/2x1 3/4 | 1.40 | PAFSF404S34.5 | 40 | 40 |
| 1 1/4 | 32 | 33.7 | 25 | 34.5 | 27 | 4 | 77 | 94 | 31.8 | 66.6 | 13.3 | M 12x50 | - | 1.40 | PAFSF404/12S34.5 | 40 | 40 |
| 1 1/4 | 32 | 42.4 | 31 | 42.8 | 27 | 4 | 77 | 94 | 31.8 | 66.6 | 15.0** | M 14x50 | 1/2x1 3/4 | 1.35 | PAFSF404S42.8 | 40 | 40 |
| 1 1/4 | 32 | 42.4 | 31 | 42.8 | 27 | 4 | 77 | 94 | 31.8 | 66.6 | 13.3 | M 12x50 | - | 1.35 | PAFSF404/12S42.8 | 40 | 40 |
| 1 1/2 | 38 | 42.4 | 31 | 42.8 | 30 | 4 | 89 | 103 | 36.5 | 79.3 | 16.7 | M 16x55 | 5/8x2 1/4 | 1.30 | PAFSF405S42.8 | 40 | 40 |
| 1 1/2 | 38 | 48.3 | 38 | 48.6 | 30 | 4 | 89 | 103 | 36.5 | 79.3 | 16.7 | M 16x55 | 5/8x2 1/4 | 1.27 | PAFSF405S48.6 | 40 | 40 |
| 2 | 51 | 48.3 | 38 | 48.6 | 37 | 4 | 123 | 135 | 44.5 | 96.8 | 20.6 | M 20x70 | 3/4x2 3/4 | 3.03 | PAFSF406S48.6 | 40 | 40 |
| 2 | 51 | 60.3 | 50 | 61.0 | 37 | 4 | 123 | 135 | 44.5 | 96.8 | 20.6 | M 20x70 | 3/4x2 3/4 | 2.89 | PAFSF406S61.0 | 40 | 40 |

The pressures given here are the maximum allowable for the flange fittings. If the pipe or tube used has a lower pressure rating, then the welded assembly rating will be the lower one, assuming the weld is adequately strong.

**DB = 13.3 for UNC Bolts

***DB = 12 for UNC Bolts

1) Pressure shown = Item deliverable

*Please add the suffixes below according to the material/surface required.

| Order code suffixes | | | | | |
|-------------------------|-----------------------------|----------------------------|--|--|---|
| Material | Suffix surface and material | Example only 4 bolt flange | Example 4 bolt flange incl. metr. bolts and O-ring | Example 4 bolt flange incl. UNC bolts and O-ring | Standard sealing material (no additional suffix needed) |
| Steel, blanc oil dipped | S | PAFSF080S17.5S | PAFSF080S17.5SM | PAFSF080S17.5SU | NBR |
| Stainless steel | SS | PAFSF080S17.5SS | PAFSF080S17.5SSM | - | VIT |

$$\frac{PN \text{ (bar)}}{10} = PN \text{ (MPa)}$$

Stainless steel parts may have dimensional deviations. Additional information on request.



PAFS-90S SAE 90° 4 bolt flange (socket weld)

SAE 90° Flange / Socket weld tube end
(ISO 6162-1/-2)

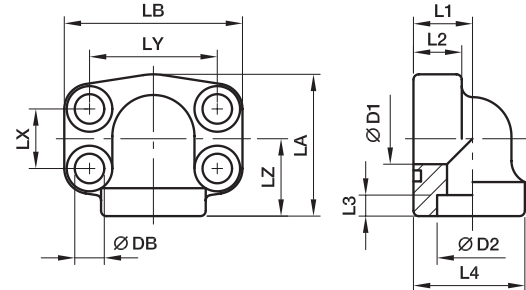

3000 PSI Series

| Nom. flange size | | max. | D1 | D2 | L1 | L2 | L3 | L4 | LA | LB | LX | LY | LZ | DB | Bolts | | Weight (steel) kg/piece | Order code* | PN (bar) ¹⁾ | |
|------------------|----------|------|----|------|----|----|----|------|-----|-----|------|------|----|---------|---------|------------|-------------------------|------------------------|------------------------|-----|
| SAE (in.) | ISO (DN) | | | | | | | | | | | | | | (metr.) | (unc.) | | | S | SS |
| 1/2 | 13 | 21.3 | 13 | 21.6 | 18 | 17 | 5 | 34.0 | 51 | 57 | 17.5 | 38.1 | 28 | 8.9 | M 08×30 | 5/16×1 1/4 | 0.45 | PAFS080/90S21.6 | 345 | 345 |
| 3/4 | 19 | 26.9 | 19 | 27.2 | 22 | 18 | 5 | 38.5 | 50 | 68 | 22.2 | 47.6 | 25 | 10.6 | M 10×35 | 3/8×1 1/2 | 0.50 | PAFS100/90S27.2 | 345 | 345 |
| 1 | 25 | 33.7 | 25 | 34.1 | 28 | 19 | 6 | 44.5 | 55 | 72 | 26.2 | 52.4 | 28 | 10.6 | M 10×35 | 3/8×1 1/2 | 0.55 | PAFS102/90S34.1 | 345 | 345 |
| 1 1/4 | 32 | 42.4 | 31 | 42.8 | 30 | 22 | 7 | 53.5 | 68 | 82 | 30.2 | 58.7 | 34 | 10.6*** | M 10×40 | 7/16×1 1/2 | 0.88 | PAFS104/90S42.8 | 276 | 276 |
| 1 1/2 | 38 | 48.3 | 38 | 48.6 | 36 | 25 | 8 | 62.5 | 82 | 95 | 35.7 | 69.9 | 43 | 13.3 | M 12×45 | 1/2×1 3/4 | 1.28 | PAFS106/90S48.6 | 207 | 207 |
| 2 | 51 | 60.3 | 50 | 61.0 | 41 | 25 | 10 | 77.0 | 94 | 105 | 42.9 | 77.8 | 50 | 13.3 | M 12×45 | 1/2×1 3/4 | 1.72 | PAFS108/90S61 | 207 | 207 |
| 2 1/2 | 64 | 76.1 | 60 | 76.6 | 50 | 25 | 28 | 85.0 | 127 | 115 | 50.8 | 88.9 | 77 | 13.3 | M 12×45 | 1/2×1 3/4 | 3.11 | PAFS110/90S76.6 | 172 | 172 |

6000 PSI Series

| | | | | | | | | | | | | | | | | | | | | |
|-------|----|------|----|------|----|----|----|------|-----|-----|------|------|----|---------|---------|------------|------|---------------------------|-----|-----|
| 1/2 | 13 | 21.3 | 13 | 21.6 | 18 | 17 | 5 | 34.0 | 51 | 57 | 18.2 | 40.5 | 28 | 8.9 | M 08×30 | 5/16×1 1/4 | 0.35 | PAFS401/90S21.6 | 420 | 420 |
| 3/4 | 19 | 26.9 | 19 | 27.2 | 22 | 19 | 6 | 44.5 | 55 | 72 | 23.8 | 50.8 | 28 | 10.6 | M 10×35 | 3/8×1 1/2 | 0.76 | PAFS402/90S27.2 | 420 | 420 |
| 1 | 25 | 33.7 | 25 | 34.1 | 30 | 24 | 7 | 53.5 | 68 | 82 | 27.8 | 57.2 | 34 | 13.3*** | M 12×50 | 7/16×1 1/2 | 0.96 | PAFS403/90S34.1 | 420 | 420 |
| 1 1/4 | 32 | 42.4 | 31 | 42.8 | 36 | 25 | 8 | 62.5 | 82 | 95 | 31.8 | 66.6 | 43 | 15.0** | M 14×45 | 1/2×1 3/4 | 1.77 | PAFS404/90S42.8 | 420 | 420 |
| 1 1/2 | 32 | 42.4 | 31 | 42.8 | 36 | 25 | 8 | 62.5 | 82 | 95 | 31.8 | 66.6 | 43 | 13.3 | M 12×45 | – | 1.77 | PAFS404/12/90S42.8 | 420 | 420 |
| 1 1/2 | 38 | 48.3 | 38 | 48.6 | 41 | 26 | 10 | 77.0 | 94 | 110 | 36.5 | 79.3 | 50 | 16.7 | M 16×55 | 5/8×2 1/4 | 2.24 | PAFS405/90S48.6 | 420 | 420 |
| 2 | 51 | 60.3 | 50 | 61.0 | 45 | 35 | 12 | 89.0 | 123 | 134 | 44.5 | 96.8 | 65 | 20.6 | M 20×70 | 3/4×2 3/4 | 3.48 | PAFS406/90S61 | 420 | 420 |

**DB = 13.3 for UNC Bolts

***DB = 12 for UNC Bolts

¹⁾Pressure shown = Item deliverable

$$\frac{\text{PN (bar)}}{10} = \text{PN (MPa)}$$

The pressures given here are the maximum allowable for the flange fittings. If the pipe or tube used has a lower pressure rating, then the welded assembly rating will be the lower one, assuming the weld is adequately strong.

Stainless steel parts may have dimensional deviations. Additional information on request.



*Please add the suffixes below according to the material/surface required.

| Order code suffixes | | | | | |
|-------------------------|-----------------------------|----------------------------|--|--|---|
| Material | Suffix surface and material | Example only 4 bolt flange | Example 4 bolt flange incl. metr. bolts and O-ring | Example 4 bolt flange incl. UNC bolts and O-ring | Standard sealing material (no additional suffix needed) |
| Steel, blanc oil dipped | S | PAFS080/90S21.6S | PAFS080/90S21.6SM | PAFS080/90S21.6SU | NBR |
| Stainless steel | SS | PAFS080/90S21.6SS | PAFS080/90S21.6SSM | – | VIT |



SAE Full flanges

PDFS-G SAE Straight 4 bolt flange connection

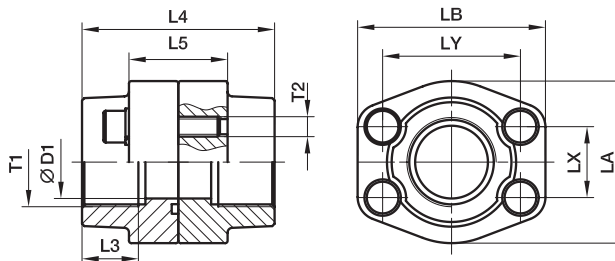
 SAE Flange / Female BSPP thread
(ISO 6162-1/-2)

3000 PSI Series

| Nom. flange size | | T1 | D1 | L3 | L4 | L5 | LA | LB | LX | LY | T2 | | Weight (steel) kg/piece | Order code* | PN (bar) ¹⁾ | |
|------------------|----------|----------------|-----|----|-----|----|-----|-----|------|-------|---------|--------|-------------------------|-------------------|------------------------|-----|
| SAE (in.) | ISO (DN) | | | | | | | | | | (metr.) | (unc.) | | | S | SS |
| 1/2 | 13 | G 3/8 | 13 | 19 | 72 | 32 | 47 | 57 | 17.5 | 38.1 | M 8 | 5/16 | 0.71 | PDFS080G38 | 345 | 345 |
| 1/2 | 13 | G 1/2 | 13 | 19 | 72 | 32 | 47 | 57 | 17.5 | 38.1 | M 8 | 5/16 | 0.67 | PDFS080G | 345 | 345 |
| 3/4 | 19 | G 3/4 | 19 | 19 | 72 | 36 | 49 | 66 | 22.3 | 47.6 | M10 | 3/8 | 0.97 | PDFS100G | 345 | 345 |
| 1 | 25 | G 1 | 25 | 19 | 76 | 36 | 53 | 71 | 26.2 | 52.4 | M10 | 3/8 | 1.13 | PDFS102G | 345 | 345 |
| 1 1/4 | 32 | G 1 1/4 | 31 | 22 | 82 | 42 | 69 | 80 | 30.2 | 58.7 | M10 | 7/16 | 1.63 | PDFS104G | 276 | 276 |
| 1 1/2 | 38 | G 1 1/2 | 38 | 24 | 88 | 48 | 77 | 94 | 35.7 | 69.9 | M12 | 1/2 | 2.49 | PDFS106G | 207 | 207 |
| 2 | 51 | G 2 | 50 | 26 | 90 | 48 | 89 | 103 | 42.9 | 77.8 | M12 | 1/2 | 2.68 | PDFS108G | 207 | 207 |
| 2 1/2 | 64 | G 2 1/2 | 63 | 30 | 100 | 48 | 101 | 115 | 50.8 | 88.9 | M12 | 1/2 | 3.22 | PDFS110G | 172 | 172 |
| 3 | 76 | G 3 | 73 | 34 | 100 | 53 | 124 | 135 | 61.9 | 106.4 | M16 | 5/8 | 3.10 | PDFS112G | 138 | 138 |
| 3 1/2 | 89 | G 3 1/2 | 89 | 27 | 100 | 54 | 136 | 152 | 69.9 | 120.7 | M16 | 5/8 | 4.20 | PDFS114G | 34 | 34 |
| 4 | 102 | G 4 | 99 | 30 | 100 | 54 | 146 | 162 | 77.8 | 130.2 | M16 | 5/8 | 6.76 | PDFS116G | 34 | 34 |
| 5 | 127 | G 5 | 120 | 30 | 100 | 54 | 180 | 184 | 92.1 | 152.4 | M16 | 5/8 | 7.00 | PDFS118G | 34 | 34 |

6000 PSI Series

| | | | | | | | | | | | | | | | | |
|-------|----|----------------|----|----|-----|-----|-----|-----|------|-------|-----|------|-------|--------------------|-----|-----|
| 1/2 | 13 | G 3/8 | 13 | 19 | 72 | 32 | 47 | 57 | 18.2 | 40.5 | M 8 | 5/16 | 0.68 | PDFS401G38 | 420 | 420 |
| 1/2 | 13 | G 1/2 | 13 | 19 | 72 | 32 | 47 | 57 | 18.2 | 40.5 | M 8 | 5/16 | 0.68 | PDFS401G | 420 | 420 |
| 3/4 | 19 | G 3/4 | 19 | 22 | 72 | 38 | 53 | 71 | 23.8 | 50.8 | M10 | 3/8 | 1.23 | PDFS402G | 420 | 420 |
| 1 | 25 | G 1 | 25 | 24 | 88 | 48 | 69 | 80 | 27.8 | 57.2 | M12 | 7/16 | 1.98 | PDFS403G | 420 | 420 |
| 1 1/4 | 32 | G 1 1/4 | 31 | 25 | 88 | 54 | 77 | 94 | 31.8 | 66.6 | M14 | 1/2 | 2.71 | PDFS404G | 420 | 420 |
| 1 1/4 | 32 | G 1 1/4 | 31 | 25 | 88 | 54 | 77 | 94 | 31.8 | 66.6 | M12 | - | 2.71 | PDFS404/12G | 420 | 420 |
| 1 1/2 | 38 | G 1 1/2 | 38 | 28 | 102 | 60 | 89 | 106 | 36.5 | 79.3 | M16 | 5/8 | 4.25 | PDFS405G | 420 | 420 |
| 2 | 51 | G 2 | 50 | 33 | 140 | 74 | 116 | 135 | 44.5 | 96.8 | M20 | 3/4 | 8.10 | PDFS406G | 420 | 420 |
| 2 1/2 | 64 | G 2 1/2 | 63 | 35 | 150 | 90 | 150 | 166 | 58.7 | 123.8 | M24 | - | 15.66 | PDFS407G | 420 | 420 |
| 3 | 76 | G 3 | 73 | 40 | 180 | 110 | 178 | 208 | 71.4 | 152.4 | M30 | - | 20.00 | PDFS408G | 420 | 420 |

1) Pressure shown = Item deliverable

$$\frac{\text{PN (bar)}}{10} = \text{PN (MPa)}$$

Stainless steel parts may have dimensional deviations. Additional information on request.

*Please add the suffixes below according to the material/surface required.

| Order code suffixes | | | | |
|---------------------------------|-----------------------------|---|---|---|
| Material | Suffix surface and material | Example 4 bolt flange coupling incl. metr. bolts and O-ring | Example 4 bolt flange coupling incl. UNC bolts and O-ring | Standard sealing material (no additional suffix needed) |
| Steel, zinc plated, Cr(VI)-free | CF | PDFS080GCF | PDFS080GCFU | NBR |
| Stainless steel | SS | PDFS080GSS | - | VIT |



PDFS-B SAE Straight 4 bolt flange connection (butt weld)

SAE Flange / Butt weld tube end
(ISO 6162-1/-2)

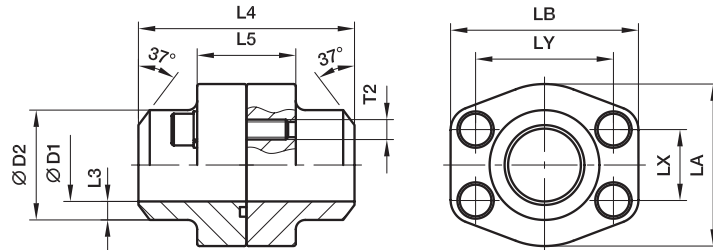

3000 PSI Series

| Nom. flange size | | T2 | Weight (steel) kg/piece | Order code* | PN (bar) ¹⁾ | | | | | | | | | | | | |
|------------------|----------|-------|-------------------------|-------------|------------------------|-----|----|-----|-----|------|-------|-----|------|------|----------|-----|-----|
| SAE (in.) | ISO (DN) | | | | S | SS | | | | | | | | | | | |
| 1/2 | 13 | 21.3 | 13 | 21.6 | 4.3 | 72 | 32 | 47 | 57 | 17.5 | 38.1 | M 8 | 5/16 | 0.64 | PDFS080B | 345 | 345 |
| 3/4 | 19 | 26.9 | 19 | 27.2 | 4.1 | 72 | 36 | 49 | 66 | 22.3 | 47.6 | M10 | 3/8 | 0.85 | PDFS100B | 345 | 345 |
| 1 | 25 | 33.7 | 25 | 34.5 | 4.7 | 76 | 36 | 53 | 71 | 26.2 | 52.4 | M10 | 3/8 | 1.05 | PDFS102B | 345 | 345 |
| 1 1/4 | 32 | 42.4 | 31 | 42.8 | 6.0 | 82 | 42 | 69 | 80 | 30.2 | 58.7 | M10 | 7/16 | 1.55 | PDFS104B | 276 | 276 |
| 1 1/2 | 38 | 48.3 | 38 | 48.6 | 5.3 | 88 | 48 | 77 | 94 | 35.7 | 69.9 | M12 | 1/2 | 2.31 | PDFS106B | 207 | 207 |
| 2 | 51 | 60.3 | 50 | 61.0 | 5.5 | 90 | 48 | 89 | 103 | 42.9 | 77.8 | M12 | 1/2 | 2.64 | PDFS108B | 207 | 207 |
| 2 1/2 | 64 | 76.1 | 63 | 76.6 | 6.8 | 100 | 48 | 101 | 115 | 50.8 | 88.9 | M12 | 1/2 | 3.32 | PDFS110B | 172 | 172 |
| 3 | 76 | 88.9 | 73 | 89.0 | 8.0 | 100 | 53 | 124 | 135 | 61.9 | 106.4 | M16 | 5/8 | 5.18 | PDFS112B | 138 | 138 |
| 3 1/2 | 89 | 101.6 | 89 | 103.0 | 7.0 | 100 | 54 | 137 | 153 | 69.9 | 120.7 | M16 | 5/8 | 6.00 | PDFS114B | 34 | 34 |
| 4 | 102 | 114.3 | 99 | 115.0 | 8.0 | 100 | 54 | 147 | 163 | 77.8 | 130.2 | M16 | 5/8 | 7.31 | PDFS116B | 34 | 34 |
| 5 | 127 | 140.0 | 120 | 141.0 | 10.5 | 100 | 54 | 180 | 184 | 92.1 | 152.4 | M16 | 5/8 | 9.18 | PDFS118B | 34 | 34 |

6000 PSI Series

| | | | | | | | | | | | | | | | | | |
|-------|----|------|----|------|------|-----|-----|-----|-----|------|-------|-----|------|-------|-------------|-----|-----|
| 1/2 | 13 | 17.2 | 10 | 17.5 | 3.7 | 72 | 32 | 47 | 57 | 18.2 | 40.5 | M 8 | 5/16 | 0.63 | PDFS401B38 | 420 | 420 |
| 1/2 | 13 | 21.3 | 13 | 21.6 | 4.3 | 72 | 32 | 47 | 57 | 18.2 | 40.5 | M 8 | 5/16 | 0.64 | PDFS401B | 420 | 420 |
| 3/4 | 19 | 26.9 | 18 | 27.2 | 4.6 | 72 | 38 | 53 | 71 | 23.8 | 50.8 | M10 | 3/8 | 1.34 | PDFS402B | 420 | 420 |
| 1 | 25 | 33.7 | 22 | 34.5 | 6.3 | 88 | 48 | 66 | 80 | 27.8 | 57.2 | M12 | 7/16 | 1.86 | PDFS403B | 420 | 420 |
| 1 1/4 | 32 | 42.4 | 28 | 42.8 | 7.4 | 88 | 54 | 77 | 94 | 31.8 | 66.5 | M14 | 1/2 | 2.81 | PDFS404B | 420 | 420 |
| 1 1/4 | 32 | 42.4 | 28 | 42.8 | 7.4 | 88 | 54 | 77 | 94 | 31.8 | 66.5 | M12 | - | 2.81 | PDFS404/12B | 420 | 420 |
| 1 1/2 | 38 | 48.3 | 32 | 48.6 | 8.3 | 102 | 60 | 89 | 106 | 36.5 | 79.3 | M16 | 5/8 | 3.84 | PDFS405B | 420 | 420 |
| 2 | 51 | 60.3 | 41 | 61.0 | 10.0 | 140 | 74 | 116 | 135 | 44.5 | 96.8 | M20 | 3/4 | 8.10 | PDFS406B | 420 | 420 |
| 2 1/2 | 64 | 76.1 | 50 | 76.6 | 13.0 | 150 | 90 | 150 | 166 | 58.7 | 123.8 | M24 | - | 14.72 | PDFS407B | 420 | 420 |
| 3 | 76 | 88.9 | 58 | 90.0 | 16.0 | 180 | 110 | 178 | 208 | 71.4 | 152.4 | M30 | - | 27.80 | PDFS408B | 420 | 420 |

¹⁾Pressure shown = Item deliverable

$$\frac{PN \text{ (bar)}}{10} = PN \text{ (MPa)}$$

The pressures given here are the maximum allowable for the flange fittings. If the pipe or tube used has a lower pressure rating, then the welded assembly rating will be the lower one, assuming the weld is adequately strong.

Stainless steel parts may have dimensional deviations. Additional information on request.

*Please add the suffixes below according to the material/surface required.

| Order code suffixes | | | | |
|-------------------------|-----------------------------|---|---|---|
| Material | Suffix surface and material | Example 4 bolt flange coupling incl. metr. bolts and O-ring | Example 4 bolt flange coupling incl. UNC bolts and O-ring | Standard sealing material (no additional suffix needed) |
| Steel, blanc oil dipped | S | PDFS080BS | PDFS080BSU | NBR |
| Stainless steel | SS | PDFS080BSS | - | VIT |



SAE Full flanges

PDFS-S SAE Straight 4 bolt flange connection (socket weld)

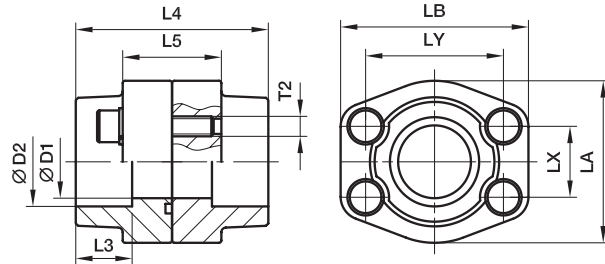
 SAE Flange / Socket weld tube end
(ISO 6162-1/-2)

3000 PSI Series

| Nom. flange size | | T2 | Weight (steel) kg/piece | Order code* | PN (bar) ¹⁾ | | | | | | | | | | | | |
|------------------|----------|-------|-------------------------|-------------|------------------------|-----|----|-----|-----|------|-------|-----|------|------|---------------|-----|-----|
| SAE (in.) | ISO (DN) | | | | S | SS | | | | | | | | | | | |
| 1/2 | 13 | 17.2 | 13 | 17.5 | 18 | 72 | 36 | 47 | 57 | 17.5 | 38.1 | M 8 | 5/16 | 0.70 | PDFS080S17.5 | 345 | 345 |
| 1/2 | 13 | 21.3 | 13 | 21.6 | 18 | 72 | 36 | 47 | 57 | 17.5 | 38.1 | M 8 | 5/16 | 0.67 | PDFS080S21.6 | 345 | 345 |
| 3/4 | 19 | 26.9 | 19 | 27.2 | 18 | 72 | 36 | 49 | 66 | 22.3 | 47.6 | M10 | 3/8 | 1.00 | PDFS100S27.2 | 345 | 345 |
| 1 | 25 | 33.7 | 25 | 34.1 | 18 | 76 | 36 | 53 | 71 | 26.2 | 52.4 | M10 | 3/8 | 1.13 | PDFS102S34.1 | 345 | 345 |
| 1 1/4 | 32 | 42.4 | 31 | 42.8 | 20 | 82 | 42 | 69 | 80 | 30.2 | 58.7 | M10 | 7/16 | 1.63 | PDFS104S42.8 | 276 | 276 |
| 1 1/2 | 38 | 48.3 | 38 | 48.6 | 22 | 88 | 48 | 77 | 94 | 35.7 | 69.9 | M12 | 1/2 | 2.47 | PDFS106S48.6 | 207 | 207 |
| 2 | 51 | 60.3 | 50 | 61.0 | 24 | 90 | 48 | 89 | 103 | 42.9 | 77.8 | M12 | 1/2 | 2.60 | PDFS108S61 | 207 | 207 |
| 2 1/2 | 64 | 76.1 | 63 | 76.6 | 28 | 100 | 48 | 101 | 116 | 50.8 | 88.9 | M12 | 1/2 | 3.21 | PDFS110S76.6 | 172 | 172 |
| 3 | 76 | 88.9 | 73 | 90.5 | 28 | 100 | 53 | 124 | 135 | 61.9 | 106.4 | M16 | 5/8 | 5.08 | PDFS112S90.5 | 138 | 138 |
| 3 1/2 | 89 | 101.6 | 89 | 103.0 | 28 | 100 | 54 | 137 | 153 | 69.9 | 120.7 | M16 | 5/8 | 5.91 | PDFS114S103 | 34 | 34 |
| 4 | 102 | 114.3 | 99 | 115.5 | 28 | 100 | 54 | 147 | 163 | 77.8 | 130.2 | M16 | 5/8 | 6.50 | PDFS116S115.5 | 34 | 34 |
| 5 | 127 | 140.0 | 120 | 142.0 | 28 | 100 | 54 | 180 | 184 | 92.1 | 152.4 | M16 | 5/8 | 8.62 | PDFS118S142 | 34 | 34 |

6000 PSI Series

| | | | | | | | | | | | | | | | | | |
|-------|----|------|----|------|----|-----|-----|-----|-----|------|-------|-----|------|-------|-----------------|-----|-----|
| 1/2 | 13 | 17.2 | 13 | 17.5 | 18 | 72 | 32 | 47 | 57 | 18.2 | 40.5 | M 8 | 5/16 | 0.66 | PDFS401S17.5 | 420 | 420 |
| 1/2 | 13 | 21.3 | 13 | 21.6 | 18 | 72 | 32 | 47 | 57 | 18.2 | 40.5 | M 8 | 5/16 | 0.60 | PDFS401S21.6 | 420 | 420 |
| 3/4 | 19 | 26.9 | 19 | 27.2 | 20 | 72 | 38 | 53 | 71 | 23.8 | 50.8 | M10 | 3/8 | 1.14 | PDFS402S27.2 | 420 | 420 |
| 1 | 25 | 33.7 | 25 | 34.1 | 22 | 88 | 48 | 66 | 80 | 27.8 | 57.2 | M12 | 7/16 | 1.78 | PDFS403S34.1 | 420 | 420 |
| 1 1/4 | 32 | 42.4 | 31 | 42.8 | 22 | 88 | 54 | 77 | 94 | 31.8 | 66.6 | M14 | 1/2 | 2.44 | PDFS404S42.8 | 420 | 420 |
| 1 1/4 | 32 | 42.4 | 31 | 42.8 | 22 | 88 | 54 | 77 | 94 | 31.8 | 66.6 | M12 | - | 2.44 | PDFS404/12S42.8 | 420 | 420 |
| 1 1/2 | 38 | 48.3 | 38 | 48.6 | 24 | 102 | 60 | 89 | 106 | 36.5 | 79.3 | M16 | 5/8 | 3.54 | PDFS405S48.6 | 420 | 420 |
| 2 | 51 | 60.3 | 50 | 61.0 | 25 | 140 | 74 | 116 | 135 | 44.5 | 96.8 | M20 | 3/4 | 7.52 | PDFS406S61 | 420 | 420 |
| 2 1/2 | 64 | 76.1 | 63 | 76.6 | 28 | 150 | 90 | 150 | 166 | 58.7 | 123.8 | M24 | - | 14.56 | PDFS407S76.6 | 420 | 420 |
| 3 | 76 | 88.9 | 73 | 90.5 | 30 | 180 | 110 | 178 | 208 | 71.4 | 152.4 | M30 | - | 25.20 | PDFS408S90.5 | 420 | 420 |

1) Pressure shown = Item deliverable

 $PN \text{ (bar)} = PN \text{ (MPa)} \times 10$

The pressures given here are the maximum allowable for the flange fittings. If the pipe or tube used has a lower pressure rating, then the welded assembly rating will be the lower one, assuming the weld is adequately strong.

Stainless steel parts may have dimensional deviations. Additional information on request.

*Please add the suffixes below according to the material/surface required.

| Order code suffixes | | | | |
|-------------------------|-----------------------------|---|---|---|
| Material | Suffix surface and material | Example 4 bolt flange coupling incl. metr. bolts and O-ring | Example 4 bolt flange coupling incl. UNC bolts and O-ring | Standard sealing material (no additional suffix needed) |
| Steel, blanc oil dipped | S | PDFS080S17.5S | PDFS080S17.5SU | NBR |
| Stainless steel | SS | PDFS080S17.5SS | - | VIT |



PCFF SAE Closed flange

SAE Closed flange
(ISO 6162-1/-2)

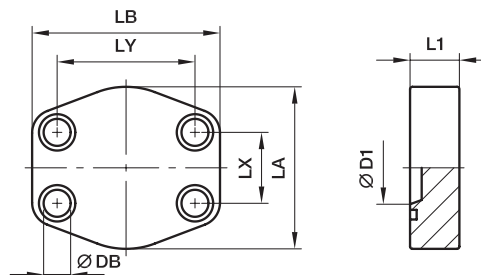

3000 PSI Series

| Nom. flange size | | D1 | L1 | LA | LB | LX | LY | DB | Bolts | | Weight (steel) kg/piece | Order code* | PN (bar) ¹⁾ | |
|------------------|----------|-----|----|-----|-----|------|-------|---------|---------|------------|-------------------------|----------------|------------------------|-----|
| SAE (in.) | ISO (DN) | | | | | | | | (metr.) | (unc.) | | | S | SS |
| 1/2 | 13 | 13 | 16 | 47 | 58 | 17.5 | 38.1 | 8.9 | M 08×30 | 5/16×1 1/4 | 0.25 | PCFF32 | 345 | 345 |
| 3/4 | 19 | 16 | 18 | 49 | 66 | 22.3 | 47.6 | 10.6 | M 10×35 | 3/8×1 1/2 | 0.36 | PCFF33 | 345 | 345 |
| 1 | 25 | 25 | 19 | 53 | 71 | 26.2 | 52.4 | 10.6 | M 10×35 | 3/8×1 1/2 | 0.43 | PCFF34 | 345 | 345 |
| 1 1/4 | 32 | 25 | 21 | 69 | 80 | 30.2 | 58.7 | 10.6*** | M 10×40 | 7/16×1 1/2 | 0.71 | PCFF35 | 276 | 276 |
| 1 1/2 | 38 | 34 | 25 | 77 | 95 | 35.7 | 69.9 | 13.3 | M 12×45 | 1/2×1 3/4 | 1.11 | PCFF36 | 207 | 207 |
| 2 | 51 | 43 | 25 | 89 | 103 | 42.9 | 77.8 | 13.3 | M 12×45 | 1/2×1 3/4 | 1.38 | PCFF38 | 207 | 207 |
| 2 1/2 | 64 | 61 | 25 | 101 | 116 | 50.8 | 88.9 | 13.3 | M 12×45 | 1/2×1 3/4 | 1.77 | PCFF310 | 172 | 172 |
| 3 | 76 | 58 | 27 | 124 | 136 | 61.9 | 106.4 | 16.7 | M 16×55 | 5/8×2 1/4 | 2.72 | PCFF312 | 138 | 138 |
| 3 1/2 | 89 | 73 | 27 | 136 | 152 | 69.9 | 120.7 | 16.7 | M 16×55 | 5/8×2 1/4 | 3.77 | PCFF314 | 34 | 34 |
| 4 | 102 | 87 | 27 | 146 | 162 | 77.8 | 130.2 | 16.7 | M 16×55 | 5/8×2 1/4 | 4.20 | PCFF316 | 34 | 34 |
| 5 | 127 | 127 | 25 | 180 | 184 | 92.1 | 152.4 | 16.7 | M 16×55 | 5/8×2 1/4 | 6.42 | PCFF320 | 34 | 34 |

6000 PSI Series

| | | | | | | | | | | | | | | |
|-------|----|----|----|-----|-----|------|-------|---------|----------|------------|-------|------------------|-----|-----|
| 1/2 | 13 | 13 | 16 | 47 | 58 | 18.2 | 40.5 | 8.9 | M 08×30 | 5/16×1 1/4 | 0.25 | PCFF62 | 420 | 420 |
| 3/4 | 19 | 20 | 19 | 53 | 71 | 23.8 | 50.8 | 10.6 | M 10×35 | 3/8×1 1/2 | 0.46 | PCFF63 | 420 | 420 |
| 1 | 25 | 25 | 24 | 66 | 80 | 27.8 | 57.2 | 13.3*** | M 12×45 | 7/16×1 1/2 | 0.78 | PCFF64 | 420 | 420 |
| 1 1/4 | 32 | 25 | 27 | 77 | 94 | 31.8 | 66.6 | 15.0** | M 14×50 | 1/2×1 3/4 | 1.17 | PCFF65 | 420 | 420 |
| 1 1/4 | 32 | 25 | 27 | 77 | 94 | 31.8 | 66.6 | 13.3 | M 12×50 | - | 1.17 | PCFF65/12 | 420 | 420 |
| 1 1/2 | 38 | 34 | 30 | 89 | 107 | 36.5 | 79.3 | 16.7 | M 16×55 | 5/8×2 1/4 | 1.62 | PCFF66 | 420 | 420 |
| 2 | 51 | 46 | 37 | 116 | 135 | 44.5 | 96.8 | 20.6 | M 20×70 | 3/4×2 3/4 | 3.40 | PCFF68 | 420 | 420 |
| 2 1/2 | 64 | 56 | 45 | 150 | 166 | 58.7 | 123.8 | 25.0 | M 24×90 | - | 6.77 | PCFF610 | 420 | 420 |
| 3 | 76 | 81 | 55 | 178 | 208 | 71.4 | 152.4 | 32.0 | M 30×110 | - | 12.36 | PCFF612 | 420 | 420 |

**DB = 13.3 for UNC Bolts

***DB = 12 for UNC Bolts

¹⁾Pressure shown = Item deliverable

$\frac{PN \text{ (bar)}}{10} = PN \text{ (MPa)}$

Stainless steel parts may have dimensional deviations. Additional information on request.



*Please add the suffixes below according to the material/surface required.

| Order code suffixes | | | | | |
|---------------------------------|-----------------------------|----------------------------|--|--|---|
| Material | Suffix surface and material | Example only closed flange | Example closed flange incl. metr. bolts and O-ring | Example closed flange incl. UNC bolts and O-ring | Standard sealing material (no additional suffix needed) |
| Steel, zinc plated, Cr(VI)-free | CF | PCFF32CF | PCFF32CFM | PCFF32CFU | NBR |
| Stainless steel | SS | PCFF32SS | PCFF32SSM | - | VIT |



SAE Flange accessories

PCCFF SAE Closed counter flange

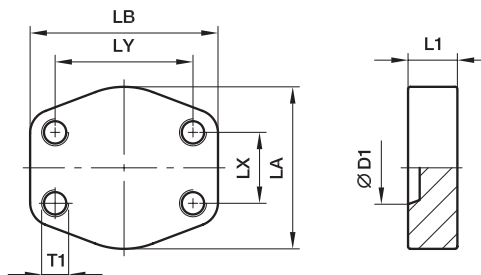
 SAE Closed counter flange
(ISO 6162-1/-2)

3000 PSI Series

| Nom. flange size | | D1 | L1 | LA | LB | LX | LY | T1 | | Weight (steel) kg/piece | Order code* | PN (bar) ¹⁾ | |
|------------------|----------|-----|----|-----|-----|------|-------|---------|--------|-------------------------|-----------------|------------------------|-----|
| SAE (in.) | ISO (DN) | | | | | | | (metr.) | (unc.) | | | S | SS |
| 1/2 | 13 | 13 | 16 | 47 | 58 | 17.5 | 38.1 | M 8 | 5/16 | 0.26 | PCCFF32 | 345 | 345 |
| 3/4 | 19 | 16 | 18 | 49 | 66 | 22.3 | 47.6 | M10 | 3/8 | 0.37 | PCCFF33 | 345 | 345 |
| 1 | 25 | 25 | 19 | 53 | 71 | 26.2 | 52.4 | M10 | 3/8 | 0.45 | PCCFF34 | 345 | 345 |
| 1 1/4 | 32 | 25 | 21 | 69 | 80 | 30.2 | 58.7 | M10 | 7/16 | 0.73 | PCCFF35 | 276 | 276 |
| 1 1/2 | 38 | 34 | 25 | 77 | 95 | 35.7 | 69.9 | M12 | 1/2 | 1.50 | PCCFF36 | 207 | 207 |
| 2 | 51 | 43 | 25 | 89 | 103 | 42.9 | 77.8 | M12 | 1/2 | 1.40 | PCCFF38 | 207 | 207 |
| 2 1/2 | 64 | 61 | 25 | 101 | 116 | 50.8 | 88.9 | M12 | 1/2 | 1.83 | PCCFF310 | 172 | 172 |
| 3 | 76 | 60 | 27 | 124 | 136 | 61.9 | 106.4 | M16 | 5/8 | 2.80 | PCCFF312 | 138 | 138 |
| 3 1/2 | 89 | 73 | 27 | 136 | 152 | 69.9 | 120.7 | M16 | 5/8 | 3.68 | PCCFF314 | 34 | 34 |
| 4 | 102 | 87 | 27 | 146 | 162 | 77.8 | 130.2 | M16 | 5/8 | 4.10 | PCCFF316 | 34 | 34 |
| 5 | 127 | 127 | 25 | 180 | 184 | 92.1 | 152.4 | M16 | 5/8 | 6.40 | PCCFF320 | 34 | 34 |

6000 PSI Series

| | | | | | | | | | | | | | |
|-------|----|----|----|-----|-----|------|-------|-----|------|-------|-------------------|-----|-----|
| 1/2 | 13 | 13 | 16 | 47 | 58 | 18.2 | 40.5 | M 8 | 5/16 | 0.30 | PCCFF62 | 420 | 420 |
| 3/4 | 19 | 20 | 19 | 53 | 71 | 23.8 | 50.8 | M10 | 3/8 | 0.49 | PCCFF63 | 420 | 420 |
| 1 | 25 | 25 | 24 | 66 | 80 | 27.8 | 57.2 | M12 | 7/16 | 0.82 | PCCFF64 | 420 | 420 |
| 1 1/4 | 32 | 25 | 27 | 77 | 94 | 31.8 | 66.6 | M14 | 1/2 | 1.22 | PCCFF65 | 420 | 420 |
| 1 1/4 | 32 | 25 | 27 | 77 | 94 | 31.8 | 66.6 | M12 | - | 1.22 | PCCFF65/12 | 420 | 420 |
| 1 1/2 | 38 | 34 | 30 | 89 | 103 | 36.5 | 79.3 | M16 | 5/8 | 1.69 | PCCFF66 | 420 | 420 |
| 2 | 51 | 46 | 37 | 123 | 135 | 44.5 | 96.8 | M20 | 3/4 | 3.48 | PCCFF68 | 420 | 420 |
| 2 1/2 | 64 | 56 | 45 | 150 | 166 | 58.7 | 123.8 | M24 | - | 7.08 | PCCFF610 | 420 | 420 |
| 3 | 76 | 71 | 55 | 178 | 208 | 71.4 | 152.4 | M30 | - | 12.67 | PCCFF612 | 420 | 420 |

¹⁾ Pressure shown = Item deliverable

$$\frac{PN \text{ (bar)}}{10} = PN \text{ (MPa)}$$

Stainless steel parts may have dimensional deviations. Additional information on request.

*Please add the suffixes below according to the material/surface required.

| Order code suffixes | | | | |
|---------------------------------|-----------------------------|--|--|---|
| Material | Suffix surface and material | Example closed flange with metr. threads | Example closed flange with UNC threads | Standard sealing material (no additional suffix needed) |
| Steel, zinc plated, Cr(VI)-free | CF | PCCF32CFM | PCCFF32CFU | NBR |
| Stainless steel | SS | PCCFF32SSM | PCCFF32SSU | VIT |



CPM SAE Flange connector plate

ISO 6162-1/-2

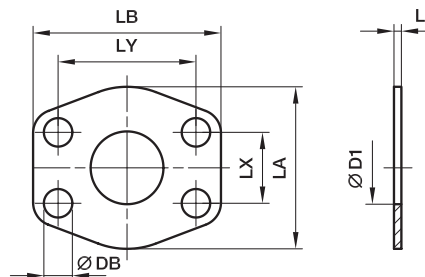
3000 PSI Series

| Nom. flange size | | D1 | L1 | LA | LB | LX | LY | DB | Weight (steel) kg/piece | Order code* | PN (bar) ¹⁾ | |
|------------------|----------|-----|----|-----|-----|------|-------|------|-------------------------|---------------|------------------------|-----|
| SAE (in.) | ISO (DN) | | | | | | | | | | CF | SS |
| 1/2 | 13 | 13 | 3 | 47 | 57 | 17.5 | 38.1 | 9.0 | 0.05 | 8CPM1 | 345 | 345 |
| 3/4 | 19 | 19 | 3 | 49 | 66 | 22.3 | 47.6 | 11.0 | 0.05 | 12CPM1 | 345 | 345 |
| 1 | 25 | 25 | 3 | 53 | 71 | 26.2 | 52.4 | 11.0 | 0.07 | 16CPM1 | 345 | 345 |
| 1 1/4 | 32 | 32 | 3 | 69 | 80 | 30.2 | 58.7 | 11.5 | 0.09 | 20CPM1 | 276 | 276 |
| 1 1/2 | 38 | 38 | 3 | 77 | 95 | 35.7 | 69.9 | 13.5 | 0.12 | 24CPM1 | 207 | 207 |
| 2 | 51 | 51 | 3 | 89 | 103 | 42.9 | 77.8 | 13.5 | 0.13 | 32CPM1 | 207 | 207 |
| 2 1/2 | 64 | 63 | 3 | 101 | 116 | 50.8 | 88.9 | 13.5 | 0.15 | 40CPM1 | 172 | 172 |
| 3 | 76 | 73 | 4 | 124 | 136 | 61.9 | 106.4 | 17.0 | 0.29 | 48CPM1 | 138 | 138 |
| 3 1/2 | 89 | 89 | 4 | 136 | 152 | 69.9 | 120.7 | 17.0 | 0.34 | 56CPM1 | 34 | 34 |
| 4 | 102 | 99 | 4 | 146 | 162 | 77.8 | 130.2 | 17.0 | 0.46 | 64CPM1 | 34 | 34 |
| 5 | 127 | 120 | 4 | 180 | 184 | 92.1 | 152.4 | 17.0 | 0.50 | 80CPM1 | 34 | 34 |

6000 PSI Series

| | | | | | | | | | | | | |
|-------|----|----|---|-----|-----|------|-------|------|------|---------------|-----|-----|
| 1/2 | 13 | 13 | 4 | 47 | 57 | 18.2 | 40.5 | 9.0 | 0.08 | 8CPM2 | 420 | 420 |
| 3/4 | 19 | 17 | 4 | 53 | 71 | 23.8 | 50.8 | 11.0 | 0.11 | 12CPM2 | 420 | 420 |
| 1 | 25 | 24 | 4 | 66 | 80 | 27.8 | 57.2 | 13.0 | 0.14 | 16CPM2 | 420 | 420 |
| 1 1/4 | 32 | 31 | 4 | 77 | 94 | 31.8 | 66.6 | 15.0 | 0.20 | 20CPM2 | 420 | 420 |
| 1 1/2 | 38 | 38 | 4 | 89 | 103 | 36.5 | 79.3 | 17.0 | 0.24 | 24CPM2 | 420 | 420 |
| 2 | 51 | 51 | 4 | 123 | 135 | 44.5 | 96.8 | 21.0 | 0.30 | 32CPM2 | 420 | 420 |
| 2 1/2 | 64 | 63 | 4 | 150 | 166 | 58.7 | 123.8 | 25.0 | 0.50 | 40CPM2 | 420 | 420 |
| 3 | 76 | 73 | 4 | 178 | 208 | 71.4 | 152.4 | 32.0 | 0.73 | 48CPM2 | 420 | 420 |

¹⁾Pressure shown = Item deliverable

$$\frac{\text{PN (bar)}}{10} = \text{PN (MPa)}$$

Stainless steel parts may have dimensional deviations. Additional information on request.

 *Please add the **suffixes** below according to the material/surface required.

| Order code suffixes | | | |
|---------------------------------|-----------------------------|---------|----------------------|
| Material | Suffix surface and material | Example | Description |
| Steel, zinc plated, Cr(VI)-free | CF | 8CPM1CF | only connector plate |
| Stainless steel | SS | 8CPM1SS | only connector plate |



SAE Flange accessories

AP SAE Flange locking plate

ISO 6162-1/-2

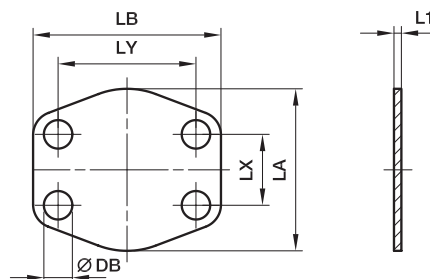
3000 PSI Series

| Nom. flange size | | L1 | LA | LB | LX | LY | DB | Weight (steel) kg/piece | Order code* | PN (bar) | |
|------------------|----------|----|-----|-----|------|-------|------|-------------------------|--------------|----------|----|
| SAE (in.) | ISO (DN) | | | | | | | | | CF | SS |
| 1/2 | 13 | 3 | 47 | 57 | 17.5 | 38.1 | 9.0 | 0.05 | 8AP1 | - | - |
| 3/4 | 19 | 3 | 49 | 66 | 22.3 | 47.6 | 11.0 | 0.06 | 12AP1 | - | - |
| 1 | 25 | 3 | 59 | 71 | 26.2 | 52.4 | 11.0 | 0.07 | 16AP1 | - | - |
| 1 1/4 | 32 | 3 | 69 | 80 | 30.2 | 58.7 | 11.5 | 0.10 | 20AP1 | - | - |
| 1 1/2 | 38 | 3 | 77 | 95 | 35.7 | 69.9 | 13.5 | 0.15 | 24AP1 | - | - |
| 2 | 51 | 3 | 97 | 103 | 42.9 | 77.8 | 13.5 | 0.19 | 32AP1 | - | - |
| 2 1/2 | 64 | 3 | 109 | 116 | 50.8 | 89.9 | 13.5 | 0.22 | 40AP1 | - | - |
| 3 | 76 | 4 | 131 | 136 | 61.9 | 106.4 | 17.0 | 0.40 | 48AP1 | - | - |
| 3 1/2 | 89 | 4 | 136 | 152 | 69.9 | 102.7 | 17.0 | 0.53 | 56AP1 | - | - |
| 4 | 102 | 4 | 146 | 162 | 77.8 | 130.2 | 17.0 | 0.61 | 64AP1 | - | - |
| 5 | 127 | 4 | 181 | 184 | 92.1 | 152.4 | 17.0 | 0.86 | 80AP1 | - | - |

6000 PSI Series

| | | | | | | | | | | | |
|-------|----|---|-----|-----|------|-------|------|------|--------------|---|---|
| 1/2 | 13 | 4 | 48 | 57 | 18.2 | 40.5 | 9.0 | 0.02 | 8AP2 | - | - |
| 3/4 | 19 | 4 | 60 | 71 | 23.8 | 50.8 | 11.0 | 0.10 | 12AP2 | - | - |
| 1 | 25 | 4 | 70 | 81 | 27.8 | 57.2 | 13.0 | 0.12 | 16AP2 | - | - |
| 1 1/4 | 32 | 4 | 78 | 95 | 31.8 | 66.6 | 15.0 | 0.17 | 20AP2 | - | - |
| 1 1/2 | 38 | 4 | 95 | 113 | 36.5 | 79.4 | 17.0 | 0.22 | 24AP2 | - | - |
| 2 | 51 | 4 | 117 | 135 | 44.5 | 96.8 | 21.0 | 0.36 | 32AP2 | - | - |
| 2 1/2 | 64 | 4 | 150 | 176 | 58.7 | 123.8 | 25.0 | 0.58 | 40AP2 | - | - |
| 3 | 76 | 4 | 178 | 210 | 71.4 | 152.4 | 32.0 | 0.86 | 48AP2 | - | - |

This flange locking plate is not used under pressure.

Stainless steel parts may have dimensional deviations. Additional information on request.

 *Please add the **suffixes** below according to the material/surface required.

| Order code suffixes | | | |
|---------------------------------|-----------------------------|---------|--------------------|
| Material | Suffix surface and material | Example | Description |
| Steel, zinc plated, Cr(VI)-free | CF | 8AP1CF | only locking plate |
| Stainless steel | SS | 8AP1SS | only locking plate |



PFMQ Flange head plug flat

(ISO 6162-1/-2)

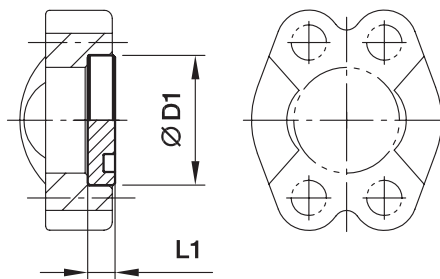

3000 PSI Series

| Nom. flange size SAE (in.) | D1 | L1 | Weight (steel) kg/piece | O-ring face Order code* | PN (bar) ¹⁾ CF |
|----------------------------|--------|------|-------------------------|-------------------------|---------------------------|
| 1/2 | 30.2 | 6.8 | 0.03 | 8PFMQ1 | 210 |
| 3/4 | 38.1 | 6.8 | 0.05 | 12PFMQ1 | 210 |
| 1 | 44.5 | 8.0 | 0.09 | 16PFMQ1 | 210 |
| 1 1/4 | 50.8 | 8.0 | 0.12 | 20PFMQ1 | 210 |
| 1 1/2 | 60.3 | 8.0 | 0.17 | 24PFMQ1 | 160 |
| 2 | 71.4 | 9.6 | 0.29 | 32PFMQ1 | 200 |
| 2 1/2 | 84.1 | 9.6 | 0.39 | 40PFMQ1 | - |
| 3 | 101.6 | 9.6 | 0.58 | 48PFMQ1 | - |
| 3 1/2 | 114.3 | 11.3 | 0.86 | 56PFMQ1 | - |
| 4 | 127.0 | 11.3 | 1.09 | 64PFMQ1 | - |
| 5 | 152.4 | 11.3 | 1.96 | 80PFMQ1 | - |

6000 PSI Series

| | | | | | |
|-------|-------|------|------|----------------|-----|
| 1/2 | 31.8 | 7.8 | 0.04 | 8PFMQ2 | 250 |
| 3/4 | 41.3 | 8.8 | 0.09 | 12PFMQ2 | 250 |
| 1 | 47.6 | 9.5 | 0.13 | 16PFMQ2 | 250 |
| 1 1/4 | 54.0 | 10.3 | 0.18 | 20PFMQ2 | 250 |
| 1 1/2 | 63.5 | 12.6 | 0.30 | 24PFMQ2 | 250 |
| 2 | 79.4 | 12.6 | 0.48 | 32PFMQ2 | 250 |
| 2 1/2 | 107.7 | 20.5 | 1.44 | 40PFMQ2 | - |
| 3 | 131.7 | 26.0 | 2.75 | 48PFMQ2 | - |

¹⁾ Pressure shown = Item deliverable

$$\frac{\text{PN (bar)}}{10} = \text{PN (MPa)}$$

Flange head plug in stainless steel on request.

N

*Please add the **suffixes** below according to the material/surface required.

| Order code suffixes | | | |
|---------------------------------|-----------------------------|----------|-----------------------|
| Material | Suffix surface and material | Example | Description |
| Steel, zinc plated, Cr(VI)-free | CF | 8PFMQ1CF | only flange head plug |



SAE Flange accessories

PMQ Flange head plug

(ISO 6162-1/-2)

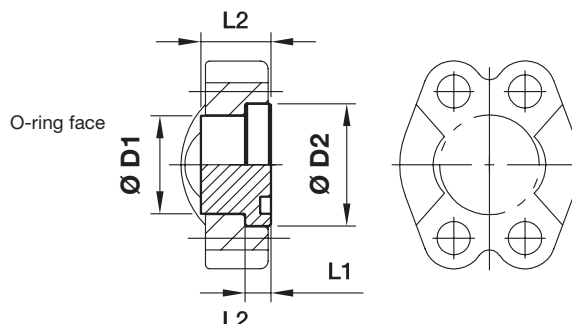
3000 PSI Series

| Nom. flange size SAE (in.) | D1 | D2 | L1 | L2 | Weight (steel) kg/piece | O-ring face Order code | Flat face Order code | PN (bar) ¹⁾ CF |
|----------------------------|-------|-------|------|----|-------------------------|------------------------|----------------------|---------------------------|
| 1/2 | 24.0 | 30.2 | 6.8 | 16 | 0.06 | 8PMQ1 | 8PCMQ1 | 350 |
| 3/4 | 31.8 | 38.1 | 6.8 | 17 | 0.12 | 12PMQ1 | 12PCMQ1 | 350 |
| 1 | 38.0 | 44.5 | 8.0 | 17 | 0.16 | 16PMQ1 | 16PCMQ1 | 315 |
| 1 1/4 | 43.0 | 50.8 | 8.0 | 17 | 0.22 | 20PMQ1 | 20PCMQ1 | 250 |
| 1 1/2 | 50.0 | 60.3 | 8.0 | 19 | 0.33 | 24PMQ1 | 24PCMQ1 | 200 |
| 2 | 62.0 | 71.4 | 9.6 | 19 | 0.51 | 32PMQ1 | 32PCMQ1 | 200 |
| 2 1/2 | 74.0 | 84.1 | 9.6 | 40 | 1.42 | 40PMQ1 | 40PCMQ1 | 160 |
| 3 | 90.0 | 101.6 | 9.6 | 45 | 2.35 | 48PMQ1 | 48PCMQ1 | 138 |
| 3 1/2 | 102.0 | 114.3 | 11.3 | 30 | 2.62 | 56PMQ1 | 56PCMQ1 | 35 |
| 4 | 114.5 | 127.0 | 11.3 | 36 | 3.14 | 64PMQ1 | 64PCMQ1 | 35 |
| 5 | 140.0 | 152.4 | 11.3 | 45 | 5.12 | 80PMQ1 | 80PCMQ1 | 35 |

6000 PSI Series

| | | | | | | | | |
|-------|-------|-------|------|----|------|---------------|----------------|-----|
| 1/2 | 24.0 | 31.8 | 7.8 | 14 | 0.07 | 8PMQ2 | 8PCMQ1 | 400 |
| 3/4 | 31.8 | 41.3 | 8.8 | 15 | 0.12 | 12PMQ2 | 12PCMQ1 | 400 |
| 1 | 38.0 | 47.6 | 9.5 | 16 | 0.18 | 16PMQ2 | 16PCMQ1 | 400 |
| 1 1/4 | 44.0 | 54.0 | 10.3 | 16 | 0.24 | 20PMQ2 | 20PCMQ1 | 400 |
| 1 1/2 | 50.8 | 63.5 | 12.6 | 19 | 0.40 | 24PMQ2 | 24PCMQ1 | 400 |
| 2 | 67.0 | 79.4 | 12.6 | 30 | 0.95 | 32PMQ2 | 32PCMQ1 | 400 |
| 2 1/2 | 89.0 | 108.0 | 21.2 | 45 | 2.67 | 40PMQ2 | 40PCMQ1 | 400 |
| 3 | 114.3 | 132.0 | 26.5 | 55 | 5.11 | 48PMQ2 | 48PCMQ1 | 400 |

¹⁾Pressure shown = Item deliverable

$$\frac{\text{PN (bar)}}{10} = \text{PN (MPa)}$$

Flange head plug in stainless steel on request.

 Please add the **suffixes** below according to the material/surface required.

| Material | Order code suffixes | | |
|---------------------------------|-----------------------------|---------|-----------------------|
| | Suffix surface and material | Example | Description |
| Steel, zinc plated, Cr(VI)-free | CF | 8PMQ1CF | only flange head plug |

PAGL-(G/M) SAE 4 bolt flange with test point port

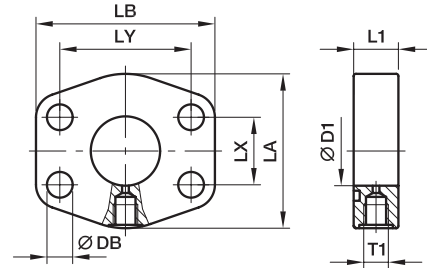
 SAE Flange with test point port
(ISO 6162-1/-2)

3000 PSI Series

| Nom. flange size | | T1 | D1 | L1 | LA | LB | LX | LY | DB | Weight (steel) kg/piece | Order code* | PN (bar) ¹⁾ | |
|------------------|----------|-----------------|-----|----|-----|-----|------|-------|------|-------------------------|-------------------|------------------------|-----|
| SAE (in.) | ISO (DN) | | | | | | | | | | | S | SS |
| 1 | 25 | G 1/4 | 25 | 22 | 53 | 71 | 26.2 | 52.4 | 10.6 | 0.43 | PAGL102G14 | 348 | 348 |
| 1 | 25 | M 10x1.0 | 25 | 19 | 53 | 71 | 26.2 | 52.4 | 10.6 | 0.50 | PAGL102M10 | 348 | 348 |
| 1 1/4 | 32 | G 1/4 | 31 | 20 | 69 | 82 | 30.2 | 58.7 | 10.6 | 0.56 | PAGL104G14 | 278 | 278 |
| 1 1/4 | 32 | M 10x1.0 | 31 | 20 | 69 | 82 | 30.2 | 58.7 | 10.6 | 0.55 | PAGL104M10 | 278 | 278 |
| 1 1/2 | 38 | G 1/4 | 38 | 25 | 77 | 94 | 35.7 | 69.9 | 13.3 | 0.86 | PAGL106G14 | 210 | 210 |
| 1 1/2 | 38 | M 10x1.0 | 38 | 25 | 77 | 94 | 35.7 | 69.9 | 13.3 | 0.90 | PAGL106M10 | 210 | 210 |
| 2 | 51 | G 1/4 | 50 | 25 | 89 | 103 | 42.9 | 77.8 | 13.3 | 0.95 | PAGL108G14 | 210 | 210 |
| 2 | 51 | M 10x1.0 | 50 | 25 | 89 | 103 | 42.9 | 77.8 | 13.3 | 0.96 | PAGL108M10 | 210 | 210 |
| 2 1/2 | 64 | G 1/4 | 63 | 25 | 101 | 115 | 50.8 | 88.9 | 13.3 | 1.21 | PAGL110G14 | 175 | 175 |
| 2 1/2 | 64 | M 10x1.0 | 63 | 25 | 101 | 115 | 50.8 | 88.9 | 13.3 | 1.23 | PAGL110M10 | 175 | 175 |
| 3 | 76 | G 1/4 | 73 | 27 | 124 | 135 | 61.9 | 106.4 | 16.7 | 2.00 | PAGL112G14 | 138 | 138 |
| 3 | 76 | M 10x1.0 | 73 | 27 | 124 | 135 | 61.9 | 106.4 | 16.7 | 2.01 | PAGL112M10 | 138 | 138 |
| 3 1/2 | 89 | G 1/4 | 89 | 27 | 136 | 152 | 69.9 | 120.7 | 16.7 | 2.42 | PAGL114G14 | 35 | 35 |
| 3 1/2 | 89 | M 10x1.0 | 89 | 27 | 136 | 152 | 69.9 | 120.7 | 16.7 | 2.43 | PAGL114M10 | 35 | 35 |
| 4 | 102 | G 1/4 | 99 | 27 | 146 | 162 | 77.8 | 130.2 | 16.7 | 2.73 | PAGL116G14 | 35 | 35 |
| 4 | 102 | M 10x1.0 | 99 | 27 | 146 | 162 | 77.8 | 130.2 | 16.7 | 2.73 | PAGL116M10 | 35 | 35 |
| 5 | 127 | G 1/4 | 120 | 28 | 180 | 184 | 92.1 | 152.4 | 16.7 | 3.76 | PAGL118G14 | 35 | 35 |
| 5 | 127 | M 10x1.0 | 120 | 28 | 180 | 184 | 92.1 | 152.4 | 16.7 | 3.76 | PAGL118M10 | 35 | 35 |

6000 PSI Series

| | | | | | | | | | | | | | |
|-------|----|-----------------|----|----|-----|-----|------|-------|------|------|----------------------|-----|-----|
| 1 | 25 | G 1/4 | 25 | 22 | 69 | 82 | 27.8 | 57.2 | 13.3 | 0.65 | PAGL403G14 | 420 | 420 |
| 1 | 25 | M 10x1.0 | 25 | 22 | 69 | 82 | 27.8 | 57.2 | 13.3 | 0.65 | PAGL403M10 | 420 | 420 |
| 1 1/4 | 32 | G 1/4 | 31 | 26 | 79 | 96 | 31.8 | 66.6 | 15.0 | 0.95 | PAGL404G14 | 420 | 420 |
| 1 1/4 | 32 | G 1/4 | 31 | 26 | 79 | 96 | 31.8 | 66.6 | 13.3 | 0.95 | PAGL404/12G14 | 420 | 420 |
| 1 1/4 | 32 | M 10x1.0 | 31 | 26 | 79 | 96 | 31.8 | 66.6 | 15.0 | 0.95 | PAGL404M10 | 420 | 420 |
| 1 1/4 | 32 | M 10x1.0 | 31 | 26 | 79 | 96 | 31.8 | 66.6 | 13.3 | 0.95 | PAGL404/12M10 | 420 | 420 |
| 1 1/2 | 38 | G 1/4 | 38 | 30 | 89 | 108 | 36.5 | 79.3 | 16.7 | 1.37 | PAGL405G14 | 420 | 420 |
| 1 1/2 | 38 | M 10x1.0 | 38 | 30 | 89 | 108 | 36.5 | 79.3 | 16.7 | 1.37 | PAGL405M10 | 420 | 420 |
| 2 | 51 | G 1/4 | 50 | 36 | 116 | 135 | 44.5 | 96.8 | 20.6 | 2.84 | PAGL406G14 | 420 | 420 |
| 2 | 51 | M 10x1.0 | 50 | 36 | 116 | 135 | 44.5 | 96.8 | 20.6 | 2.84 | PAGL406M10 | 420 | 420 |
| 2 1/2 | 64 | G 1/4 | 63 | 45 | 150 | 166 | 58.7 | 123.8 | 25.0 | 5.90 | PAGL408G14 | 420 | 420 |
| 2 1/2 | 64 | M 10x1.0 | 63 | 45 | 150 | 166 | 58.7 | 123.8 | 25.0 | 5.90 | PAGL408M10 | 420 | 420 |
| 3 | 76 | G 1/4 | 73 | 55 | 178 | 208 | 71.4 | 152.4 | 31.0 | 8.50 | PAGL410G14 | 420 | 420 |
| 3 | 76 | M 10x1.0 | 73 | 55 | 178 | 208 | 71.4 | 152.4 | 31.0 | 8.50 | PAGL410M10 | 420 | 420 |

¹⁾ Pressure shown = Item deliverable

$$\frac{\text{PN (bar)}}{10} = \text{PN (MPa)}$$

Stainless steel parts may have dimensional deviations. Additional information on request.

*Please add the suffixes below according to the material/surface required.

| Order code suffixes | | | |
|---------------------------------|-----------------------------|--------------|-------------|
| Material | Suffix surface and material | Example | Description |
| Steel, zinc plated, Cr(VI)-free | CF | PAGL102G14CF | only flange |
| Stainless steel | SS | PAGL102G14SS | only flange |



SAE Flange accessories

PRF SAE Straight reducing flange adapter

ISO 6162-1/-2

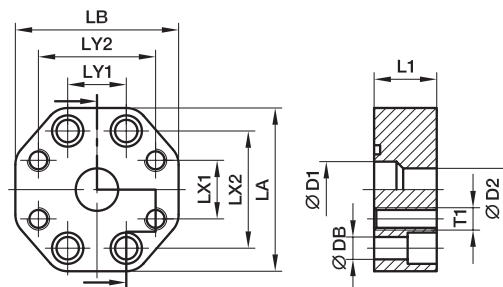
3000 PSI Series

| Nom. flange size | | D1 | D2 | L1 | LA | LB | LX1 | LX2 | LY1 | LY2 | DB | Bolts (metr.) | T1 | Weight (steel) kg/piece | Order code* | PN (bar) ¹⁾ S |
|------------------|-------------|----|----|----|-----|-----|------|-------|------|-------|------|------------------|-----|-------------------------------|-------------|--------------------------------|
| SAE (in.) | ISO (DN) | | | | | | | | | | | | | | | |
| 1x1 | 25/25 | 25 | 25 | 28 | 73 | 73 | 26.2 | 52.4 | 26.2 | 52.4 | 10.6 | M 10x30 | M10 | 0.75 | PRF102/102 | 210 |
| 1x3/4 | 25/19 | 25 | 19 | 28 | 73 | 73 | 22.3 | 52.4 | 26.2 | 47.6 | 10.6 | M 10x30 | M10 | 0.76 | PRF102/100 | 210 |
| 1 1/4x1 1/4 | 32/32 | 30 | 30 | 28 | 80 | 80 | 30.2 | 58.7 | 30.2 | 58.7 | 10.6 | M 10x30 | M10 | 0.83 | PRF104/104 | 210 |
| 1 1/4x1 | 32/25 | 30 | 25 | 28 | 80 | 71 | 26.2 | 58.7 | 30.2 | 52.4 | 10.6 | M 10x30 | M10 | 0.95 | PRF104/102 | 210 |
| 1 1/2x1 1/2 | 38/38 | 38 | 38 | 32 | 94 | 94 | 35.7 | 69.9 | 35.7 | 69.9 | 13.3 | M 12x35 | M12 | 1.20 | PRF106/106 | 210 |
| 1 1/2x1 1/4 | 38/32 | 38 | 30 | 32 | 94 | 80 | 30.2 | 69.9 | 35.7 | 58.7 | 13.3 | M 12x35 | M10 | 1.36 | PRF106/104 | 210 |
| 2x2 | 51/51 | 50 | 50 | 33 | 103 | 103 | 42.9 | 77.8 | 42.9 | 77.8 | 13.3 | M 12x35 | M12 | 1.56 | PRF108/108 | 210 |
| 2x1 1/2 | 51/38 | 50 | 38 | 33 | 103 | 94 | 35.7 | 77.8 | 42.9 | 70.0 | 13.3 | M 12x35 | M12 | 1.69 | PRF108/106 | 210 |
| 2 1/2x2 1/2 | 64/64 | 63 | 63 | 33 | 115 | 115 | 50.8 | 88.9 | 50.8 | 88.9 | 13.3 | M 12x35 | M12 | 2.05 | PRF110/110 | 175 |
| 2 1/2x2 | 64/51 | 63 | 50 | 33 | 115 | 103 | 42.9 | 88.9 | 50.8 | 77.8 | 13.3 | M 12x35 | M12 | 2.04 | PRF110/108 | 175 |
| 3x3 | 76/76 | 73 | 73 | 36 | 135 | 135 | 61.9 | 106.4 | 61.9 | 106.4 | 16.7 | M 16x40 | M16 | 2.61 | PRF112/112 | 138 |
| 3x2 1/2 | 76/64 | 73 | 63 | 36 | 135 | 115 | 50.8 | 106.4 | 61.9 | 89.0 | 16.7 | M 16x40 | M12 | 2.61 | PRF112/110 | 138 |

6000 PSI Series

| | | | | | | | | | | | | | | | | |
|-------------|-------|----|----|----|-----|-----|------|-------|------|------|------|---------|-----|-------|------------------|-----|
| 3/4x3/4 | 19/19 | 19 | 19 | 28 | 73 | 73 | 23.8 | 50.8 | 23.8 | 50.8 | 10.6 | M 10x30 | M10 | 0.80 | PRF402/402 | 420 |
| 1x1 | 25/25 | 25 | 25 | 33 | 80 | 80 | 27.8 | 57.2 | 27.8 | 57.2 | 13.3 | M 12x35 | M12 | 1.03 | PRF403/403 | 420 |
| 1x3/4 | 25/19 | 25 | 19 | 33 | 80 | 71 | 23.8 | 57.2 | 27.8 | 50.8 | 13.3 | M 12x35 | M10 | 0.98 | PRF403/402 | 420 |
| 1 1/4x1 1/4 | 32/32 | 30 | 30 | 33 | 94 | 94 | 31.8 | 66.6 | 31.8 | 66.6 | 15.0 | M 14x35 | M14 | 1.47 | PRF404/404 | 420 |
| 1 1/4x1 1/4 | 32/32 | 30 | 30 | 33 | 94 | 94 | 31.8 | 66.6 | 31.8 | 66.6 | 13.3 | M 12x35 | M12 | 1.47 | PRF404/12/404/12 | 420 |
| 1 1/4x1 | 32/25 | 30 | 25 | 33 | 94 | 80 | 27.8 | 66.6 | 31.8 | 57.2 | 15.0 | M 14x35 | M12 | 1.26 | PRF404/403 | 420 |
| 1 1/4x1 | 32/25 | 30 | 25 | 33 | 94 | 80 | 27.8 | 66.6 | 31.8 | 57.2 | 13.3 | M 12x35 | M12 | 1.26 | PRF404/12/403 | 420 |
| 1 1/2x1 1/2 | 38/38 | 38 | 38 | 48 | 106 | 106 | 36.5 | 79.3 | 36.5 | 79.3 | 16.7 | M 16x50 | M16 | 1.72 | PRF405/405 | 420 |
| 1 1/2x1 1/4 | 38/32 | 38 | 30 | 48 | 106 | 94 | 31.8 | 79.3 | 36.5 | 66.6 | 16.7 | M 16x50 | M14 | 2.32 | PRF405/404 | 420 |
| 1 1/2x1 1/4 | 38/32 | 38 | 30 | 48 | 106 | 94 | 31.8 | 79.3 | 36.5 | 66.6 | 16.7 | M 16x50 | M12 | 2.32 | PRF405/404/12 | 420 |
| 2x2 | 51/51 | 50 | 50 | 48 | 135 | 135 | 44.5 | 96.8 | 44.5 | 96.8 | 20.6 | M 20x55 | M20 | 4.20 | PRF406/406 | 420 |
| 2x1 1/2 | 51/38 | 50 | 38 | 48 | 135 | 106 | 36.5 | 96.8 | 44.5 | 79.3 | 20.6 | M 20x55 | M16 | 3.35 | PRF406/405 | 420 |
| 2 1/2x2 | 64/51 | 63 | 50 | 53 | 166 | 150 | 44.5 | 123.8 | 58.7 | 96.8 | 25.0 | M 24x60 | M20 | 6.40 | PRF408/406 | 420 |
| 3x2 | 76/51 | 73 | 50 | 58 | 208 | 178 | 44.5 | 152.4 | 71.4 | 96.8 | 31.0 | M 30x70 | M20 | 10.40 | PRF410/406 | 420 |

¹⁾ Pressure shown = Item deliverable

$$\frac{PN \text{ (bar)}}{10} = PN \text{ (MPa)}$$

Stainless steel parts may have dimensional deviations. Additional information on request.

*Please add the suffixes below according to the material/surface required.

| Order code suffixes | | | |
|---------------------------------|-----------------------------|--------------|-------------|
| Material | Suffix surface and material | Example | Description |
| Steel, zinc plated, Cr(VI)-free | CF | PRF102/102CF | only flange |
| Stainless steel | SS | PRF102/102SS | only flange |



BFG Gear pump flange straight

Hydraulic flange / EO 24° cone end

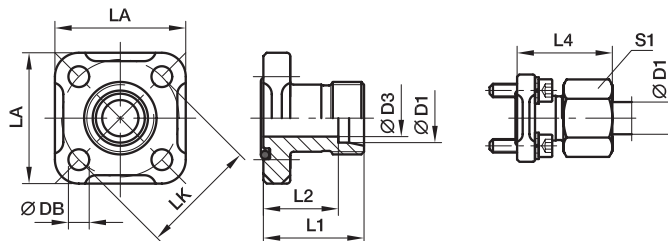

BFG Straight flange connection EO 24° cone end

| LK | D1 ²⁾ | D3 | L1 | L2 | L4 | LA | S1 | DB | Bolts (metr.) | O-ring | Weight (steel) kg/piece | Order code* | PN (bar) ¹⁾ CF |
|----|------------------|----|----|------|------|----|----|-----|------------------|--------|-------------------------------|--------------------|---------------------------------|
| 35 | 10L | 8 | 30 | 23.0 | 39.0 | 40 | 19 | 6.4 | M 06×22 | 20×2.5 | 0.15 | BFG10L/LK35 | 315 |
| 35 | 12L | 10 | 30 | 23.0 | 39.0 | 40 | 22 | 6.4 | M 06×22 | 20×2.5 | 0.16 | BFG12L/LK35 | 315 |
| 35 | 15L | 12 | 30 | 23.0 | 38.0 | 40 | 27 | 6.4 | M 06×22 | 20×2.5 | 0.19 | BFG15L/LK35 | 250 |
| 35 | 16S | 12 | 30 | 21.5 | 39.5 | 40 | 30 | 6.4 | M 06×22 | 20×2.5 | 0.21 | BFG16S/LK35 | 315 |
| 40 | 15L | 12 | 35 | 28.0 | 43.0 | 42 | 27 | 6.4 | M 06×22 | 26×2.5 | 0.17 | BFG15L/LK40 | 100 |
| 40 | 18L | 15 | 35 | 27.5 | 44.0 | 42 | 32 | 6.4 | M 06×22 | 26×2.5 | 0.22 | BFG18L/LK40 | 100 |
| 40 | 22L | 19 | 35 | 27.5 | 44.5 | 42 | 36 | 6.4 | M 06×22 | 26×2.5 | 0.26 | BFG22L/LK40 | 100 |
| 40 | 28L | 24 | 42 | 34.5 | 51.5 | 42 | 41 | 6.4 | M 06×22 | 26×2.5 | 0.30 | BFG28L/LK40 | 100 |
| 55 | 20S | 16 | 40 | 29.5 | 51.0 | 55 | 36 | 8.4 | M 08×25 | 32×2.5 | 0.49 | BFG20S/LK55 | 250 |

¹⁾ Pressure shown = Item deliverable

²⁾ L = light series; S = heavy series

$$\frac{\text{PN (bar)}}{10} = \text{PN (MPa)}$$

Delivery without nut and ring.

Information on ordering complete fittings
or alternative sealing materials see page N12.

N

*Please add the **suffixes** below according to the material/surface required.

| Order code suffixes | | | |
|---------------------------------|-----------------------------|--------------------------------------|---|
| Material | Suffix surface and material | Example incl. metr. bolts and O-ring | Standard sealing material (no additional suffix needed) |
| Steel, zinc plated, Cr(VI)-free | CF | BFG16S/LK35OMDCF | NBR |



Gear pump flanges

BFW Gear pump flange 90° elbow

Hydraulic flange / EO 24° cone end

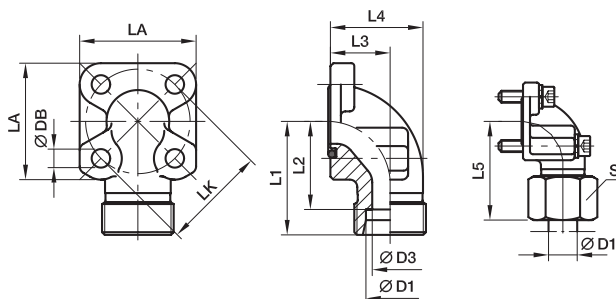
BFW 90° Flange connection EO 24° cone end

| LK | D1 ²⁾ | D3 | L1 | L2 | L3 | L4 | L5 | LA | S1 | DB | Bolts | | O-ring | Weight (steel) kg/piece | Order code* | PN (bar) ¹⁾ CF |
|----|------------------|----|----|------|------|------|------|----|----|-----|------------------|------------------|--------|-------------------------|--------------------|------------------------------|
| | | | | | | | | | | | 2 pieces (metr.) | 2 pieces (metr.) | | | | |
| 35 | 10L | 8 | 38 | 31.0 | 16.5 | 26.5 | 47.0 | 40 | 19 | 6.4 | M 06×22 | M 06×35 | 20×2.5 | 0.23 | BFW10L/LK35 | 315 |
| 35 | 12L | 10 | 38 | 31.0 | 16.5 | 26.5 | 47.0 | 40 | 22 | 6.4 | M 06×22 | M 06×35 | 20×2.5 | 0.26 | BFW12L/LK35 | 315 |
| 35 | 15L | 12 | 38 | 31.0 | 16.5 | 26.5 | 46.0 | 40 | 27 | 6.4 | M 06×22 | M 06×35 | 20×2.5 | 0.26 | BFW15L/LK35 | 250 |
| 35 | 16S | 12 | 38 | 29.5 | 20.0 | 31.0 | 48.0 | 40 | 30 | 6.4 | M 06×22 | M 06×40 | 20×2.5 | 0.30 | BFW16S/LK35 | 315 |
| 35 | 20S | 16 | 45 | 34.5 | 25.0 | 38.0 | 56.0 | 40 | 36 | 6.4 | M 06×22 | M 06×45 | 20×2.5 | 0.40 | BFW20S/LK35 | 315 |
| 35 | 22L | 19 | 45 | 37.5 | 25.0 | 38.0 | 54.5 | 40 | 36 | 6.4 | M 06×22 | M 06×45 | 20×2.5 | 0.25 | BFW22L/LK35 | 250 |
| 40 | 15L | 12 | 38 | 31.0 | 22.5 | 36.5 | 46.0 | 42 | 27 | 6.4 | M 06×22 | M 06×22 | 26×2.5 | 0.23 | BFW15L/LK40 | 100 |
| 40 | 18L | 15 | 38 | 30.5 | 22.5 | 36.5 | 47.0 | 42 | 32 | 6.4 | M 06×22 | M 06×22 | 26×2.5 | 0.30 | BFW18L/LK40 | 100 |
| 40 | 22L | 19 | 38 | 30.5 | 22.5 | 36.5 | 47.5 | 42 | 36 | 6.4 | M 06×22 | M 06×22 | 26×2.5 | 0.30 | BFW22L/LK40 | 100 |
| 40 | 28L | 22 | 40 | 32.5 | 28.0 | 43.0 | 49.0 | 42 | 41 | 6.4 | M 06×20 | M 06×50 | 26×2.5 | 0.40 | BFW28L/LK40 | 100 |
| 40 | 35L | 31 | 41 | 30.5 | 34.0 | 55.0 | 52.0 | 42 | 50 | 6.4 | M 06×22 | M 06×60 | 26×2.5 | 0.35 | BFW35L/LK40 | 100 |
| 40 | 20S | 16 | 40 | 29.5 | 22.5 | 35.5 | 50.0 | 42 | 36 | 6.4 | M 06×22 | M 06×45 | 26×2.5 | 0.35 | BFW20S/LK40 | 250 |
| 55 | 35L | 31 | 49 | 38.5 | 32.0 | 51.5 | 62.0 | 58 | 50 | 8.4 | M 08×25 | M 08×60 | 32×2.5 | 0.74 | BFW35L/LK55 | 100 |
| 55 | 42L | 38 | 49 | 38.0 | 40.0 | 64.5 | 61.0 | 58 | 60 | 8.4 | M 08×25 | M 08×70 | 32×2.5 | 0.60 | BFW42L/LK55 | 100 |
| 55 | 20S | 17 | 45 | 34.5 | 24.0 | 38.0 | 56.0 | 58 | 36 | 8.4 | M 08×25 | M 08×50 | 32×2.5 | 0.64 | BFW20S/LK55 | 250 |
| 55 | 25S | 20 | 49 | 37.0 | 30.0 | 46.0 | 61.0 | 58 | 46 | 8.4 | M 08×25 | M 08×55 | 32×2.5 | 0.80 | BFW25S/LK55 | 250 |
| 55 | 30S | 26 | 49 | 35.5 | 32.0 | 50.0 | 62.0 | 58 | 50 | 8.4 | M 08×25 | M 08×50 | 32×2.5 | 0.81 | BFW30S/LK55 | 250 |

¹⁾ Pressure shown = Item deliverable

²⁾ L = light series; S = heavy series

 $\frac{\text{PN (bar)}}{10} = \text{PN (MPa)}$
Delivery without nut and ring.
Information on ordering complete fittings or alternative sealing materials see page N12.

 *Please add the **suffixes** below according to the material/surface required.

| Order code suffixes | | | |
|---------------------------------|-----------------------------|--------------------------------------|---|
| Material | Suffix surface and material | Example incl. metr. bolts and O-ring | Standard sealing material (no additional suffix needed) |
| Steel, zinc plated, Cr(VI)-free | CF | BFW16S/LK35OMDCF | NBR |



BFW3 Gear pump flange 90° elbow 3 holes

Hydraulic flange / EO 24° cone end

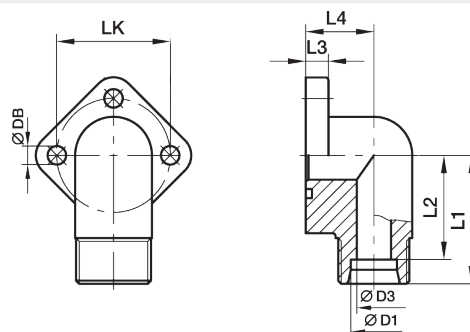

BFW-3 90° Flange connection EO 24° cone end

| LK | D1 ²⁾ | D3 | L1 | L2 | L3 | L4 | DB | Bolts (metr.) | O-ring | Weight (steel) kg/piece | Order code* | PN (bar) ¹⁾ CF |
|----|------------------|----|----|------|------|------|-----|------------------|--------|-------------------------------|----------------------|---------------------------------|
| 30 | 12L | 9 | 31 | 24.0 | 9.0 | 17.0 | 6.5 | M 06×22 | 16×2.5 | 0.20 | BFW3-12L/LK30 | 250 |
| 30 | 15L | 11 | 31 | 24.0 | 9.0 | 17.0 | 6.5 | M 06×22 | 16×2.5 | 0.22 | BFW3-15L/LK30 | 250 |
| 30 | 18L | 12 | 31 | 23.5 | 9.0 | 17.0 | 6.5 | M 06×22 | 16×2.5 | 0.25 | BFW3-18L/LK30 | 160 |
| 40 | 22L | 18 | 36 | 28.5 | 11.5 | 23.0 | 8.5 | M 08×30 | 24×2.5 | 0.44 | BFW3-22L/LK40 | 160 |
| 40 | 28L | 19 | 36 | 28.5 | 11.5 | 23.0 | 8.5 | M 08×30 | 24×2.5 | 0.45 | BFW3-28L/LK40 | 160 |

¹⁾ Pressure shown = Item deliverable

²⁾ L = light series

$\frac{PN \text{ (bar)}}{10} = PN \text{ (MPa)}$

Delivery without nut and ring.

Information on ordering complete fittings
or alternative sealing materials see page N12.

N

*Please add the **suffixes** below according to the material/surface required.

| Order code suffixes | | | |
|---------------------------------|-----------------------------|--------------------------------------|---|
| Material | Suffix surface and material | Example incl. metr. bolts and O-ring | Standard sealing material (no additional suffix needed) |
| Steel, zinc plated, Cr(VI)-free | CF | BFW3-12L/LK30OMDCF | NBR |



Gear pump flanges

BFGL Gear pump flange straight

Hydraulic flange / O-Lok®-connection straight

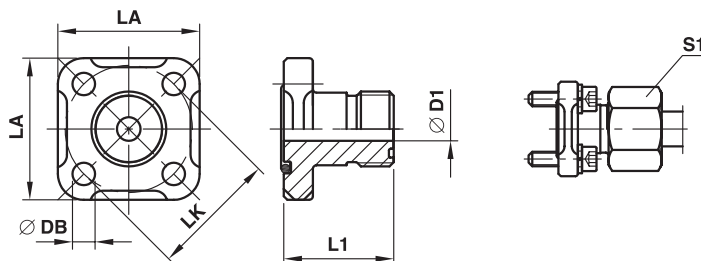
BFGL Straight flange connection O-Lok® end

| LK | D1 | S1 | Thread UN/UNF T1 | L1 | LA | DB | Bolts (metr.) | O-ring 1 | O-ring 2 | Weight (steel) kg/piece | Order code* | PN (bar) ¹⁾ CF |
|----|------|-----|------------------------|----|----|-----|------------------|----------|------------|-------------------------------|--------------------|---------------------------------|
| 35 | 6.5 | 10L | 11/16-16 | 30 | 40 | 6.4 | M 06×22 | 20×2.5 | 9.25×1.78 | 0.09 | 6BFGL/LK35 | 315 |
| 35 | 9.5 | 12L | 13/16-16 | 30 | 40 | 6.4 | M 06×22 | 20×2.5 | 12.42×1.78 | 0.10 | 8BFGL/LK35 | 315 |
| 35 | 12.5 | 15L | 1-14 | 30 | 40 | 6.4 | M 06×22 | 20×2.5 | 15.60×1.78 | 0.10 | 10BFGL/LK35 | 250 |
| 40 | 12.5 | 15L | 1-14 | 35 | 42 | 6.4 | M 06×22 | 26×2.5 | 15.60×1.78 | 0.10 | 10BFGL/LK40 | 100 |
| 40 | 15.5 | 18L | 1 3/16-12 | 35 | 42 | 6.4 | M 06×22 | 26×2.5 | 18.77×1.78 | 0.16 | 12BFGL/LK40 | 100 |
| 40 | 20.5 | 28L | 1 7/16-12 | 35 | 42 | 6.4 | M 06×22 | 26×2.5 | 23.52×1.78 | 0.17 | 16BFGL/LK40 | 100 |

¹⁾Pressure shown = Item deliverable

$$\frac{\text{PN (bar)}}{10} = \text{PN (MPa)}$$

Delivery without nut and ring.
**Information on ordering complete fittings
or alternative sealing materials see page N12.**

 *Please add the **suffixes** below according
to the material/surface required.

| Order code suffixes | | | |
|---------------------------------|-----------------------------------|--|--|
| Material | Suffix surface and material | Example incl. metr. bolts and O-ring | Standard sealing material (no additional suffix needed) |
| Steel, zinc plated, Cr(VI)-free | CF | 6BFGL/LK35OMDCF | NBR |



BFWL Gear pump flange 90° elbow

Hydraulic flange / O-Lok®-connection – 90°

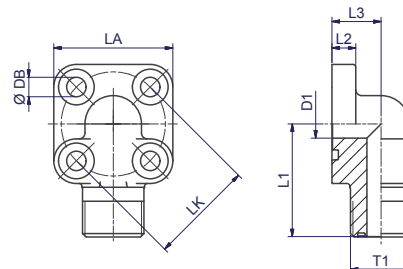

BFWL-90° O-Lok®-connection

| LK | D1 | Thread UN/UNF T1 | L1 | L2 | L3 | LA | DB | Bolts | | O-ring 1 | O-ring 2 | Weight kg/piece | Order code | PN (bar) ¹⁾ CF |
|----|------|------------------------|----|----|------|----|-----|---------------------|---------------------|----------|------------|--------------------|--------------------|---------------------------------|
| | | | | | | | | 2 pieces (metr.) | 2 pieces (metr.) | | | | | |
| 35 | 6.5 | 11/16-16 | 38 | 8 | 16.5 | 40 | 6.5 | M 06×22 | M 06×35 | 20×2.5 | 9.25×1.78 | 0.16 | 6BFWL/LK35 | 315 |
| 35 | 9.5 | 13/16-16 | 38 | 8 | 16.5 | 40 | 6.5 | M 06×22 | M 06×35 | 20×2.5 | 12.42×1.78 | 0.16 | 8BFWL/LK35 | 315 |
| 35 | 12.5 | 1-14 | 38 | 8 | 20.0 | 40 | 6.5 | M 06×22 | M 06×40 | 20×2.5 | 15.60×1.78 | 0.19 | 10BFWL/LK35 | 250 |
| 40 | 12.5 | 1-14 | 40 | 8 | 22.5 | 42 | 6.5 | M 06×22 | M 06×40 | 26×2.5 | 15.60×1.78 | 0.16 | 10BFWL/LK40 | 100 |
| 40 | 15.5 | 1 3/16-12 | 45 | 8 | 24.0 | 42 | 6.5 | M 06×22 | M 06×45 | 26×2.5 | 18.77×1.78 | 0.20 | 12BFWL/LK40 | 250 |

¹⁾ Pressure shown = Item deliverable

$\frac{\text{PN (bar)}}{10} = \text{PN (MPa)}$

Material: Steel

- Complete with O-ring and metric bolts
- Single part without accessories

N

*Please add the **suffixes** below according to the material/surface required.

| Order code suffixes | | | |
|---------------------------------|-----------------------------|--------------------------------------|---|
| Material | Suffix surface and material | Example incl. metr. bolts and O-ring | Standard sealing material (no additional suffix needed) |
| Steel, zinc plated, Cr(VI)-free | CF | 6BFWL/LK35CFM | NBR |



Gear pump flanges

BFW-G Gear pump flange 90° elbow

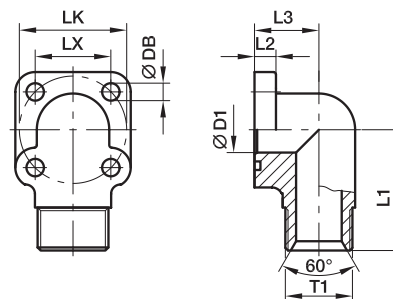
 Hydraulic flange / BSPP 60° cone end
(ISO 8434-6)

BFW-G 90° BSPP 60° cone end

| LK | T1 | D1 | L1 | L2 | L3 | LX | DB | Bolts | | O-ring | Weight (steel) kg/piece | Order code* | PN (bar) ¹⁾ CF |
|----|--------------|----|----|----|------|------|-----|------------------|------------------|------------|-------------------------|---------------------|------------------------------|
| | | | | | | | | 2 pieces (metr.) | 2 pieces (metr.) | | | | |
| 35 | G 3/8 | 10 | 40 | 8 | 20.0 | 24.8 | 6.5 | M 06×20 | M 06×35 | 18.72×2.62 | 0.20 | BFW-G38/LK35 | 315 |
| 35 | G 1/2 | 12 | 40 | 8 | 16.5 | 24.8 | 6.5 | M 06×20 | M 06×40 | 18.72×2.62 | 0.20 | BFW-G12/LK35 | 315 |
| 35 | G 3/4 | 12 | 40 | 8 | 20.0 | 24.8 | 6.5 | M 06×20 | M 06×40 | 18.72×2.62 | 0.25 | BFW-G34/LK35 | 315 |
| 40 | G 3/8 | 10 | 40 | 8 | 22.5 | 28.2 | 6.5 | M 06×20 | M 06×40 | 25.07×2.62 | 0.32 | BFW-G38/LK40 | 250 |
| 40 | G 1/2 | 12 | 45 | 8 | 24.0 | 28.2 | 6.5 | M 06×20 | M 06×40 | 25.07×2.62 | 0.26 | BFW-G12/LK40 | 250 |
| 40 | G 3/4 | 17 | 45 | 8 | 24.0 | 28.2 | 6.5 | M 06×20 | M 06×40 | 25.07×2.62 | 0.28 | BFW-G34/LK40 | 250 |
| 40 | G 1 | 19 | 40 | 8 | 28.0 | 28.2 | 6.5 | M 06×20 | M 06×50 | 25.07×2.62 | 0.30 | BFW-G1/LK40 | 250 |
| 55 | G 1/2 | 13 | 49 | 12 | 24.0 | 38.8 | 8.5 | M 08×25 | M 08×45 | 31.42×2.62 | 0.54 | BFW-G12/LK55 | 315 |
| 55 | G 3/4 | 17 | 46 | 12 | 31.0 | 38.8 | 8.5 | M 08×25 | M 08×60 | 31.42×2.62 | 0.48 | BFW-G34/LK55 | 315 |
| 55 | G 1 | 22 | 50 | 12 | 40.0 | 38.8 | 8.5 | M 08×25 | M 08×70 | 31.42×2.62 | 0.62 | BFW-G1/LK55 | 315 |

¹⁾Pressure shown = Item deliverable

 $\frac{\text{PN (bar)}}{10} = \text{PN (MPa)}$

 *Please add the **suffixes** below according to the material/surface required.

| Order code suffixes | | | |
|---------------------------------|-----------------------------|--------------------------------------|---|
| Material | Suffix surface and material | Example incl. metr. bolts and O-ring | Standard sealing material (no additional suffix needed) |
| Steel, zinc plated, Cr(VI)-free | CF | BFW-G38/LK35CFM | NBR |



BFW-GI Gear pump flange 90° elbow

Hydraulic flange / Female BSPP thread

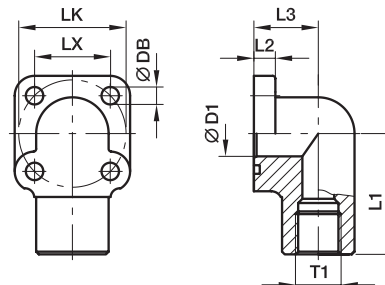

BFW-GI 90° Female BSPP thread

| LK | T1 | D1 | L1 | L2 | L3 | LX | DB | Bolts | | O-ring | Weight (steel) kg/piece | Order code* | PN (bar) ¹⁾ CF |
|----|--------------|----|----|----|------|------|-----|------------------|------------------|------------|-------------------------|----------------------|---------------------------|
| | | | | | | | | 2 pieces (metr.) | 2 pieces (metr.) | | | | |
| 35 | G 3/8 | 10 | 40 | 8 | 20.0 | 24.8 | 6.5 | M 06×20 | M 06×35 | 18.72×2.62 | 0.22 | BFW-GI38/LK35 | 315 |
| 35 | G 1/2 | 13 | 40 | 8 | 20.0 | 24.8 | 6.5 | M 06×20 | M 06×35 | 18.72×2.62 | 0.30 | BFW-GI12/LK35 | 315 |
| 40 | G 3/8 | 10 | 45 | 8 | 24.0 | 28.2 | 6.5 | M 06×20 | M 06×40 | 25.07×2.62 | 0.42 | BFW-GI38/LK40 | 250 |
| 40 | G 1/2 | 13 | 45 | 8 | 24.0 | 28.2 | 6.5 | M 06×20 | M 06×40 | 25.07×2.62 | 0.42 | BFW-GI12/LK40 | 250 |
| 40 | G 3/4 | 17 | 45 | 8 | 24.0 | 28.2 | 6.5 | M 06×20 | M 06×40 | 25.07×2.62 | 0.32 | BFW-GI34/LK40 | 250 |
| 55 | G 1/2 | 13 | 46 | 12 | 24.0 | 38.8 | 8.5 | M 08×25 | M 08×45 | 31.42×2.62 | 0.58 | BFW-GI12/LK55 | 315 |
| 55 | G 3/4 | 17 | 49 | 12 | 31.0 | 38.8 | 8.5 | M 08×25 | M 08×60 | 31.42×2.62 | 0.69 | BFW-GI34/LK55 | 315 |
| 55 | G 1 | 22 | 50 | 12 | 40.0 | 38.8 | 8.5 | M 08×25 | M 08×70 | 31.42×2.62 | 0.81 | BFW-G 11/LK55 | 315 |

¹⁾Pressure shown = Item deliverable

$\frac{\text{PN (bar)}}{10} = \text{PN (MPa)}$

N

*Please add the **suffixes** below according to the material/surface required.

| Order code suffixes | | | |
|---------------------------------|-----------------------------|--------------------------------------|---|
| Material | Suffix surface and material | Example incl. metr. bolts and O-ring | Standard sealing material (no additional suffix needed) |
| Steel, zinc plated, Cr(VI)-free | CF | BFW-GI38/LK35CFM | NBR |



Gear pump flanges

BFW-S Gear pump flange 90° elbow

Hydraulic flange / Socket weld end

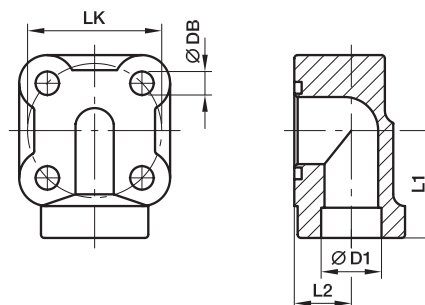
BFW-S 90° Socket weld end

| LK | D1 | L1 | L2 | DB | Bolts (metr.) | O-ring | Weight (steel) kg/piece | Order code* | PN (bar) ¹⁾ S |
|----|----|----|----|-----|------------------|------------|-------------------------------|------------------------|--------------------------------|
| 30 | 12 | 30 | 14 | 7.0 | M 06×30 | 15.88×2.62 | 0.30 | BFW-S12/LK30/M6 | 200 |
| 30 | 12 | 27 | 13 | 8.5 | M 08×35 | 15.88×2.62 | 0.29 | BFW-S12/LK30/M8 | 250 |
| 30 | 14 | 27 | 13 | 6.5 | M 06×30 | 15.88×2.62 | 0.29 | BFW-S14/LK30/M6 | 200 |
| 30 | 14 | 27 | 13 | 8.5 | M 08×35 | 15.88×2.62 | 0.28 | BFW-S14/LK30/M8 | 250 |
| 30 | 16 | 27 | 13 | 6.5 | M 06×30 | 15.88×2.62 | 0.29 | BFW-S16/LK30/M6 | 200 |
| 30 | 16 | 27 | 13 | 8.5 | M 08×35 | 15.88×2.62 | 0.28 | BFW-S16/LK30/M8 | 250 |
| 30 | 18 | 27 | 13 | 6.5 | M 06×30 | 15.88×2.62 | 0.27 | BFW-S18/LK30/M6 | 200 |
| 35 | 14 | 30 | 12 | 6.5 | M 06×35 | 18.72×2.62 | 0.40 | BFW-S14/LK35/M6 | 200 |
| 35 | 14 | 30 | 14 | 8.5 | M 08×40 | 18.72×2.62 | 0.39 | BFW-S14/LK35/M8 | 250 |
| 35 | 16 | 30 | 12 | 6.5 | M 06×35 | 18.72×2.62 | 0.27 | BFW-S16/LK35/M6 | 200 |
| 35 | 16 | 30 | 14 | 8.5 | M 08×40 | 18.72×2.62 | 0.27 | BFW-S16/LK35/M8 | 250 |
| 35 | 18 | 30 | 14 | 6.5 | M 06×35 | 18.72×2.62 | 0.26 | BFW-S18/LK35/M6 | 200 |
| 35 | 18 | 30 | 14 | 8.5 | M 08×40 | 18.72×2.62 | 0.25 | BFW-S18/LK35/M8 | 250 |
| 35 | 20 | 30 | 14 | 7.0 | M 06×35 | 18.72×2.62 | 0.27 | BFW-S20/LK35/M6 | 200 |
| 40 | 18 | 32 | 17 | 6.5 | M 06×40 | 23.81×2.62 | 0.37 | BFW-S18/LK40/M6 | 200 |
| 40 | 18 | 32 | 17 | 8.5 | M 08×40 | 23.81×2.62 | 0.36 | BFW-S18/LK40/M8 | 250 |
| 40 | 20 | 32 | 17 | 6.5 | M 06×40 | 23.81×2.62 | 0.36 | BFW-S20/LK40/M6 | 200 |
| 40 | 20 | 32 | 17 | 8.5 | M 08×40 | 23.81×2.62 | 0.35 | BFW-S20/LK40/M8 | 250 |
| 40 | 22 | 32 | 17 | 6.5 | M 06×40 | 23.81×2.62 | 0.35 | BFW-S22/LK40/M6 | 200 |
| 40 | 22 | 32 | 17 | 8.5 | M 08×40 | 23.81×2.62 | 0.35 | BFW-S22/LK40/M8 | 250 |
| 40 | 25 | 32 | 17 | 6.5 | M 06×40 | 23.81×2.62 | 0.34 | BFW-S25/LK40/M6 | 200 |
| 40 | 25 | 32 | 17 | 8.5 | M 08×40 | 23.81×2.62 | 0.33 | BFW-S25/LK40/M8 | 250 |

1) Pressure shown = Item deliverable

$$\frac{\text{PN (bar)}}{10} = \text{PN (MPa)}$$

The pressures given here are the maximum allowable for the flange fittings. If the pipe or tube used has a lower pressure rating, then the welded assembly rating will be the lower one, assuming the weld is adequately strong.

*Please add the **suffixes** below according to the material/surface required.

| Order code suffixes | | | |
|-------------------------|-----------------------------|--------------------------------------|---|
| Material | Suffix surface and material | Example incl. metr. bolts and O-ring | Standard sealing material (no additional suffix needed) |
| Steel, blanc oil dipped | S | BFW-S16/LK30/M6SM | NBR |



PF Gear pump flange straight

Hydraulic flange / Female BSPP thread

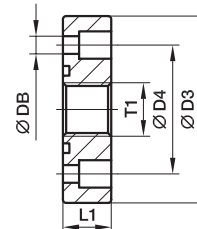
PF

| Pump size | LK | T1 | D3 | D4 | L1 | DB | Bolts (metr.) | O-ring | Weight (steel) kg/piece | Order code* | PN (bar) ¹⁾ CF |
|-----------|------|----------------|----|------|----|------|---------------|------------|-------------------------|---------------|---------------------------|
| 1.0 | 30.0 | G 3/8 | 45 | 30.0 | 13 | 6.5 | M 06×16 | 18.77×1.78 | 0.15 | PF1 | 315 |
| 2.0 | 40.0 | G 1/2 | 58 | 40.0 | 15 | 8.5 | M 08×20 | 25.12×1.78 | 0.29 | PF2 | 315 |
| 3.0 | 51.0 | G 3/4 | 75 | 51.0 | 18 | 10.5 | M 10×25 | 31.42×2.62 | 0.58 | PF3 | 315 |
| 3B | 56.0 | G 3/4 | 76 | 56.0 | 18 | 10.5 | M 10×25 | 31.42×2.62 | 0.61 | PF3B | 315 |
| 3.5 | 62.0 | G 1 | 88 | 62.0 | 20 | 10.5 | M 10×25 | 39.69×3.53 | 0.84 | PF3.5 | 315 |
| 3.5B | 62.0 | G 1 | 88 | 62.0 | 20 | 12.5 | M 12×35 | 39.69×3.53 | 0.82 | PF3.5B | 315 |
| 4.0 | 72.5 | G 1 1/4 | 98 | 72.5 | 22 | 12.5 | M 12×30 | 47.22×3.53 | 1.06 | PF4 | 315 |

PFL Gear pump flange straight

Hydraulic flange / Female BSPP thread – long version

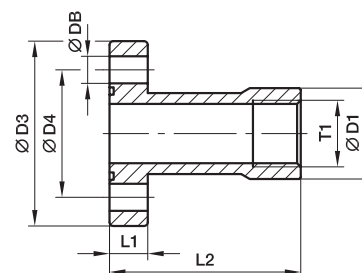
PFL

| Pump size | LK | T1 | D1 | D3 | D4 | L1 | L2 | DB | Bolts (metr.) | O-ring | Weight (steel) kg/piece | Order code* | PN (bar) ¹⁾ CF |
|-----------|------|--------------|------|----|------|----|----|------|---------------|------------|-------------------------|---------------|---------------------------|
| 1.0 | 30.0 | G 3/8 | 21.0 | 45 | 30.0 | 10 | 55 | 6.5 | M 06×20 | 18.77×1.78 | 0.20 | PFL1 | 315 |
| 2.0 | 40.0 | G 1/2 | 26.5 | 58 | 40.0 | 12 | 60 | 8.5 | M 08×25 | 25.12×1.78 | 0.39 | PFL2 | 315 |
| 3.0 | 51.0 | G 3/4 | 33.5 | 76 | 51.0 | 16 | 72 | 10.5 | M 10×35 | 31.42×2.62 | 0.79 | PFL3 | 315 |
| 3B | 56.0 | G 3/4 | 33.5 | 76 | 56.0 | 16 | 72 | 10.5 | M 10×35 | 31.42×2.62 | 0.79 | PFL3.5 | 315 |

¹⁾ Pressure shown = Item deliverable

$$\frac{\text{PN (bar)}}{10} = \text{PN (MPa)}$$

*Please add the **suffixes** below according to the material/surface required.

| Order code suffixes | | | |
|--|-----------------------------|--------------------------------------|---|
| Material | Suffix surface and material | Example incl. metr. bolts and O-ring | Standard sealing material (no additional suffix needed) |
| Steel, zinc plated, Cr(VI)-free PF | CF | PF1CFM | NBR |
| Steel, zinc plated, Cr(VI)-free PFL | CF | PFL1CFM | NBR |



Gear pump flanges

PFE Gear pump flange straight

Hydraulic flange / BSPP 60° cone end
(ISO 8434-6)

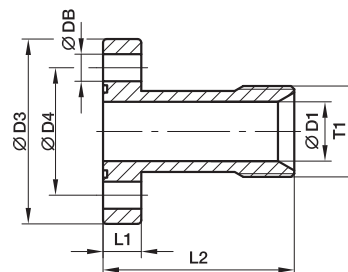

PFE

| Pump size | LK | T1 | D1 | D3 | D4 | L1 | L2 | DB | Bolts (metr.) | O-ring | Weight (steel) kg/piece | Order code* | PN (bar) ¹⁾ CF |
|-----------|------|-------|------|----|------|----|----|------|---------------|------------|-------------------------|---------------|---------------------------|
| 1.0 | 30.0 | G 1/2 | 14.0 | 45 | 30.0 | 10 | 55 | 6.5 | M 06×20 | 18.77×1.78 | 0.19 | PFE1 | 315 |
| 2.0 | 40.0 | G 3/4 | 19.0 | 58 | 40.0 | 12 | 60 | 8.5 | M 08×25 | 25.12×1.78 | 0.37 | PFE2 | 315 |
| 3.0 | 51.0 | G 1 | 24.0 | 76 | 51.0 | 16 | 72 | 10.5 | M 10×35 | 31.42×2.62 | 0.75 | PFE3 | 315 |
| 3B | 56.0 | G 1 | 24.0 | 76 | 56.0 | 16 | 72 | 10.5 | M 10×35 | 31.42×2.62 | 0.72 | PFE3.5 | 315 |

PFB Gear pump flange straight

Hydraulic flange / Butt weld tube end

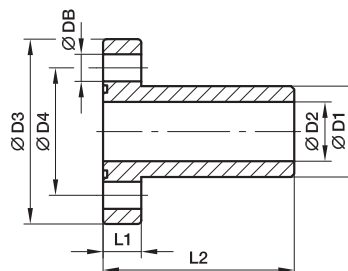

PFB

| Pump size | LK | D1 | D2 | D3 | D4 | L1 | L2 | DB | Bolts (metr.) | O-ring | Weight (steel) kg/piece | Order code* | PN (bar) ¹⁾ S |
|-----------|------|------|------|----|------|----|----|------|---------------|------------|-------------------------|---------------|--------------------------|
| 1.0 | 30.0 | 19.0 | 14.0 | 45 | 30.0 | 10 | 55 | 6.5 | M 06×20 | 18.77×1.78 | 0.19 | PFB1 | 250 |
| 2.0 | 40.0 | 25.4 | 19.0 | 58 | 40.0 | 12 | 60 | 8.5 | M 08×25 | 25.12×1.78 | 0.37 | PFB2 | 250 |
| 3.0 | 51.0 | 32.0 | 24.5 | 76 | 51.0 | 16 | 72 | 10.5 | M 10×35 | 31.42×2.62 | 0.78 | PFB3 | 250 |
| 3B | 56.0 | 32.0 | 24.5 | 76 | 56.0 | 16 | 72 | 10.5 | M 10×35 | 31.42×2.62 | 0.74 | PFB3.5 | 250 |

¹⁾ Pressure shown = Item deliverable

$$\frac{\text{PN (bar)}}{10} = \text{PN (MPa)}$$

The pressures (PFB) given here are the maximum allowable for the flange fittings. If the pipe or tube used has a lower pressure rating, then the welded assembly rating will be the lower one, assuming the weld is adequately strong.

*Please add the **suffixes** below according to the material/surface required.

| Order code suffixes | | | |
|---------------------------------|----------------------|------------------------------|--|
| Material | Suffix | Example | Standard |
| | surface and material | incl. metr. bolts and O-ring | sealing material (no additional suffix needed) |
| Steel, zinc plated, Cr(VI)-free | PFE CF | PFE1CFM | NBR |
| Steel, blanc oil dipped | PFB S | PFB1SM | NBR |



BFW3-G Gear pump flange 90° elbow 3 holes

Hydraulic flange / Female BSPP thread

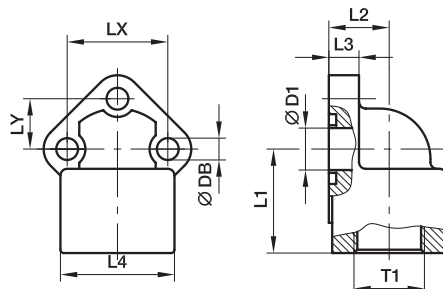

PWDS Female BSPP thread

| Pump size | LK | T1 | D1 | L1 | L2 | L3 | L4 | LX | LY | DB | Bolts | O-ring | Weight (steel) kg/piece | Order code* | PN (bar) ¹⁾ CF |
|-----------|------|-------|----|----|----|------|----|------|------|------|---------|------------|-------------------------|--------------------------|---------------------------|
| | | | | | | | | | | | (metr.) | | | | |
| 0.5 | 26.0 | 3/8 | 11 | 31 | 17 | 9.0 | 30 | 26.0 | 13.0 | 5.5 | M 05×18 | 15.60×1.78 | 0.17 | BFW3-G38/LK26 | 315 |
| 0.5 | 26.0 | 1/2 | 11 | 31 | 17 | 9.0 | 30 | 26.0 | 13.0 | 5.5 | M 05×18 | 15.60×1.78 | 0.18 | BFW3-G12/LK26 | 315 |
| 1.0 | 30.0 | 3/8 | 12 | 31 | 17 | 9.0 | 30 | 30.0 | 15.0 | 6.5 | M 06×20 | 15.88×2.62 | 0.19 | BFW3-G38/LK30 | 315 |
| 1.0 | 30.0 | 1/2 | 12 | 31 | 17 | 9.0 | 30 | 30.0 | 15.0 | 6.5 | M 06×20 | 15.88×2.62 | 0.18 | BFW3-G12/LK30 | 315 |
| 2.0 | 40.0 | 1/2 | 18 | 36 | 23 | 11.5 | 36 | 40.0 | 20.0 | 8.5 | M 08×25 | 23.81×2.62 | 0.37 | BFW3-G12/LK40 | 315 |
| 2.0 | 40.0 | 3/4 | 19 | 36 | 23 | 11.5 | 36 | 40.0 | 20.0 | 8.5 | M 08×25 | 23.81×2.62 | 0.33 | BFW3-G34/LK40 | 315 |
| 3.0 | 51.0 | 3/4 | 24 | 46 | 26 | 13.0 | 45 | 51.0 | 25.5 | 10.5 | M 10×30 | 29.75×3.53 | 0.67 | BFW3-G34/LK51 | 315 |
| 3.0 | 51.0 | 1 | 24 | 46 | 26 | 13.0 | 45 | 51.0 | 25.5 | 10.5 | M 10×30 | 29.75×3.53 | 0.56 | BFW3-G1/LK51 | 315 |
| 3B | 56.0 | 3/4 | 24 | 46 | 26 | 13.0 | 45 | 56.0 | 28.0 | 10.5 | M 10×30 | 29.75×3.53 | 0.61 | BFW3-G34/LK56 | 315 |
| 3B | 56.0 | 1 | 24 | 46 | 26 | 13.0 | 45 | 56.0 | 28.0 | 10.5 | M 10×30 | 29.75×3.53 | 0.57 | BFW3-G1/LK56 | 315 |
| 3.5 | 62.0 | 1 1/4 | 31 | 55 | 35 | 14.0 | 55 | 62.0 | 31.0 | 10.5 | M 10×30 | 37.69×3.53 | 0.95 | BFW3-G114/LK62 | 315 |
| 3.5 | 62.0 | 1 | 25 | 55 | 35 | 14.0 | 55 | 62.0 | 31.0 | 10.5 | M 10×30 | 37.69×3.53 | 1.00 | BFW3-G1/LK62 | 315 |
| 3.5 | 62.0 | 1 1/4 | 31 | 55 | 35 | 14.0 | 55 | 62.0 | 31.0 | 13.0 | M 12×35 | 37.69×3.53 | 0.95 | BFW3-G114/LK62/12 | 315 |
| 3.5 | 62.0 | 1 | 25 | 55 | 35 | 14.0 | 55 | 62.0 | 31.0 | 13.0 | M 12×35 | 37.69×3.53 | 1.20 | BFW3-G1/LK62/12 | 315 |
| 4.0 | 72.5 | 1 1/2 | 38 | 58 | 38 | 15.0 | 62 | 72.5 | 36.2 | 13.0 | M 12×35 | 47.22×3.53 | 1.12 | BFW3-G112/LK72.5 | 315 |
| 4.0 | 72.5 | 1 1/4 | 31 | 58 | 38 | 15.0 | 62 | 72.5 | 36.2 | 13.0 | M 12×35 | 47.22×3.53 | 1.14 | BFW3-G114/LK72.5 | 315 |

¹⁾ Pressure shown = Item deliverable

PN (bar)
10 = PN (MPa)

*Please add the **suffixes** below according to the material/surface required.

| Order code suffixes | | | |
|---------------------------------|-----------------------------|--------------------------------------|---|
| Material | Suffix surface and material | Example incl. metr. bolts and O-ring | Standard sealing material (no additional suffix needed) |
| Steel, zinc plated, Cr(VI)-free | CF | BFW3-G38/LK26CFM | NBR |



Gear pump flanges

PWDS-G Gear pump flange 90° elbow 4 holes – aluminium

Hydraulic flange / Female BSPP thread

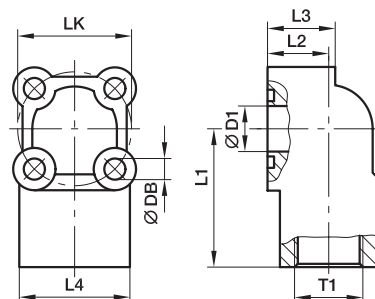
PWDS-G 90° Female BSPP thread

| LK | T1 | D1 | L1 | L2 | L3 | L4 | DB | Bolts | | O-ring | Weight (steel) kg/piece | Order code* | PN (bar) ¹⁾ A |
|----|--------------|------|------|----|----|----|-----|------------------|------------------|------------|-------------------------|----------------------|--------------------------|
| | | | | | | | | 2 pieces (metr.) | 2 pieces (metr.) | | | | |
| 30 | G 3/8 | 11.5 | 39.0 | 18 | 20 | 33 | 6.5 | M 06×30 | M 06×40 | 15.88×2.62 | 0.14 | PWDS-G38/LK30 | 180 |
| 30 | G 1/2 | 11.5 | 39.0 | 18 | 20 | 33 | 6.5 | M 06×30 | M 06×40 | 15.88×2.62 | 0.14 | PWDS-G12/LK30 | 180 |
| 35 | G 3/8 | 14.0 | 42.5 | 18 | 20 | 34 | 6.5 | M 06×30 | M 06×40 | 18.72×2.62 | 0.16 | PWDS-G38/LK35 | 180 |
| 35 | G 1/2 | 14.0 | 42.5 | 18 | 20 | 34 | 6.5 | M 06×30 | M 06×40 | 18.72×2.62 | 0.15 | PWDS-G12/LK35 | 180 |
| 40 | G 1/2 | 18.0 | 47.5 | 24 | 28 | 41 | 6.5 | M 06×40 | M 06×50 | 22.22×2.62 | 0.25 | PWDS-G12/LK40 | 180 |
| 40 | G 3/4 | 18.0 | 47.5 | 24 | 28 | 41 | 6.5 | M 06×40 | M 06×50 | 22.22×2.62 | 0.24 | PWDS-G34/LK40 | 180 |
| 55 | G 3/4 | 24.5 | 54.0 | 29 | 31 | 49 | 8.5 | M 08×45 | M 08×60 | 29.75×3.53 | 0.45 | PWDS-G34/LK55 | 180 |
| 55 | G 1 | 24.5 | 54.0 | 29 | 31 | 49 | 8.5 | M 08×45 | M 08×60 | 29.75×3.53 | 0.43 | PWDS-G1/LK55 | 180 |

¹⁾Pressure shown = Item deliverable

 $\frac{\text{PN (bar)}}{10} = \text{PN (MOPa)}$

 *Please add the **suffixes** below according to the material/surface required.

| Order code suffixes | | | |
|---------------------|-----------------------------|--------------------------------------|---|
| Material | Suffix surface and material | Example incl. metr. bolts and O-ring | Standard sealing material (no additional suffix needed) |
| Aluminium | A | PWDS-G38/LK30AM | NBR |

PWDA Gear pump flange 90° elbow 3 holes – aluminium

Hydraulic flange / Female BSPP thread

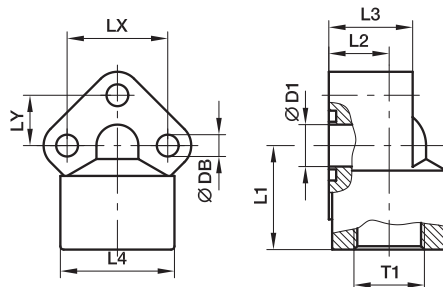
PWDA 90° Female BSPP thread

| Pump size | LK | T1 | D1 | L1 | L2 | L3 | L4 | LX | LY | DB | Bolts (metr.) | O-ring | Weight (steel) kg/piece | Order code* | PN (bar) ¹⁾ A |
|-----------|-----------|--------------|------|----|------|----|----|-----------|-------------|------|---------------|------------|-------------------------|-------------------|--------------------------|
| 0.5 | 26 | G 3/8 | 10.0 | 31 | 18.0 | 25 | 31 | 26 | 13.0 | 5.5 | M 05x35 | 14.00x1.78 | 0.10 | PWDA-05/38 | 180 |
| 0.5 | 26 | G 1/2 | 10.0 | 31 | 18.0 | 25 | 31 | 26 | 13.0 | 5.5 | M 05x35 | 14.00x1.78 | 0.10 | PWDA-05/12 | 180 |
| 1.0 | 30 | G 3/8 | 12.5 | 31 | 18.0 | 26 | 34 | 30 | 15.0 | 6.5 | M 06x35 | 15.88x2.62 | 0.13 | PWDA-1/38 | 180 |
| 1.0 | 30 | G 1/2 | 12.5 | 31 | 18.0 | 26 | 34 | 30 | 15.0 | 6.5 | M 06x35 | 15.88x2.62 | 0.14 | PWDA-1/12 | 180 |
| 2.0 | 40 | G 1/2 | 18.0 | 40 | 21.5 | 31 | 42 | 40 | 20.0 | 8.5 | M 08x45 | 22.22x2.62 | 0.26 | PWDA-2/12 | 180 |
| 2.0 | 40 | G 3/4 | 18.0 | 40 | 21.5 | 31 | 42 | 40 | 20.0 | 8.5 | M 08x45 | 22.22x2.62 | 0.26 | PWDA-2/34 | 180 |
| 3.0* | 51 -56 | G 3/4 | 24.5 | 46 | 26.0 | 42 | 49 | 51 -56 | 25.5 -28 | 11.0 | M 10x60 | 29.75x3.53 | 0.52 | PWDA-3/34 | 180 |
| 3.0* | 51 -56 | G 1 | 24.5 | 46 | 26.0 | 42 | 49 | 51 -56 | 25.5 -28 | 11.0 | M 10x60 | 29.75x3.53 | 0.50 | PWDA-3/100 | 180 |

¹⁾Pressure shown = Item deliverable

*Oval drill hole

 $\frac{\text{PN (bar)}}{10} = \text{PN (MPa)}$
N

 *Please add the **suffixes** below according to the material/surface required.

| Order code suffixes | | | |
|---------------------|-----------------------------|--------------------------------------|---|
| Material | Suffix surface and material | Example incl. metr. bolts and O-ring | Standard sealing material (no additional suffix needed) |
| Aluminium | A | PWDA-05/38AM | NBR |



ISO 6164 Square flanges

PSFC Square flange

ISO 6164

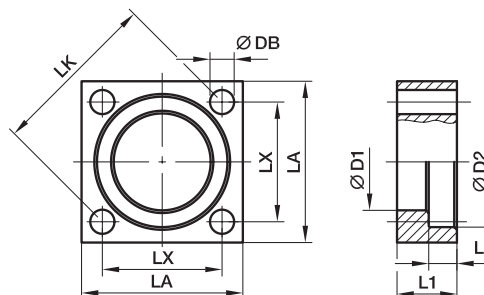
250 bar Series

| Series ²⁾ | Nom. flange size | | LK | D1 | D2 | L1 | L2 | LA | LX | DB | Weight (steel) kg/piece | Order code* | PN (bar) ¹⁾ S |
|----------------------|------------------|----------|-----|-------|-------|----|------|-----|-------|------|-------------------------|-------------|-----------------------------|
| | SAE (in.) | ISO (DN) | | | | | | | | | | | |
| L | 3/8 | 10 | 35 | 18.5 | 25.0 | 18 | 6.2 | 40 | 24.7 | 6.6 | 0.19 | PSFC/L/10 | 250 |
| L | 1/2 | 13 | 42 | 24.3 | 31.0 | 20 | 6.2 | 45 | 29.7 | 9.0 | 0.20 | PSFC/L/13 | 250 |
| L | 3/4 | 19 | 50 | 32.2 | 38.9 | 22 | 6.2 | 50 | 35.4 | 9.0 | 0.23 | PSFC/L/19 | 250 |
| L | 1 | 25 | 62 | 38.5 | 45.3 | 25 | 7.5 | 65 | 43.8 | 11.0 | 0.52 | PSFC/L/25 | 250 |
| L | 1 1/4 | 32 | 73 | 43.7 | 51.6 | 30 | 7.5 | 75 | 51.6 | 13.5 | 0.82 | PSFC/L/32 | 250 |
| L | 1 1/2 | 38 | 85 | 50.8 | 61.1 | 36 | 7.5 | 90 | 60.1 | 17.5 | 1.40 | PSFC/L/38 | 250 |
| L | 2 | 51 | 98 | 62.8 | 72.3 | 40 | 9.0 | 100 | 69.3 | 17.5 | 1.77 | PSFC/L/51 | 250 |
| L | 2 1/2 | 56 | 118 | 76.6 | 88.0 | 45 | 9.0 | 120 | 83.4 | 22.0 | 2.75 | PSFC/L/56 | 250 |
| L | 3 | 63 | 145 | 90.8 | 102.3 | 52 | 9.0 | 140 | 102.5 | 22.0 | 4.47 | PSFC/L/63 | 250 |
| L | 4 | 80 | 160 | 114.5 | 132.0 | 60 | 21.0 | 160 | 113.5 | 25.0 | 6.00 | PSFC/L/80 | 250 |

400 bar Series

| | | | | | | | | | | | | | |
|---|-------|----|-----|-------|-------|----|------|-----|-------|------|------|-----------|-----|
| S | 3/8 | 10 | 35 | 18.5 | 26.4 | 18 | 7.2 | 40 | 24.7 | 6.6 | 0.17 | PSFC/S/10 | 400 |
| S | 1/2 | 13 | 42 | 24.7 | 32.6 | 20 | 7.2 | 45 | 29.7 | 9.0 | 0.20 | PSFC/S/13 | 400 |
| S | 3/4 | 19 | 50 | 32.5 | 42.1 | 22 | 8.2 | 50 | 35.4 | 9.0 | 0.23 | PSFC/S/19 | 400 |
| S | 1 | 25 | 62 | 38.9 | 48.4 | 25 | 9.0 | 65 | 43.8 | 11.0 | 0.50 | PSFC/S/25 | 400 |
| S | 1 1/4 | 32 | 73 | 44.6 | 54.8 | 30 | 9.8 | 75 | 51.6 | 13.5 | 0.78 | PSFC/S/32 | 400 |
| S | 1 1/2 | 38 | 85 | 51.6 | 64.3 | 36 | 12.0 | 90 | 60.1 | 17.5 | 1.33 | PSFC/S/38 | 400 |
| S | 2 | 51 | 98 | 67.6 | 80.2 | 40 | 12.0 | 100 | 69.3 | 17.5 | 1.59 | PSFC/S/51 | 400 |
| S | 2 1/2 | 56 | 118 | 80.5 | 95.0 | 50 | 16.1 | 120 | 83.4 | 22.0 | 2.98 | PSFC/S/56 | 400 |
| S | 3 | 63 | 145 | 90.5 | 111.0 | 52 | 16.1 | 150 | 102.5 | 26.0 | 5.70 | PSFC/S/63 | 400 |
| S | 3 1/2 | 70 | 160 | 102.5 | 120.0 | 60 | 17.5 | 160 | 113.1 | 26.0 | 6.57 | PSFC/S/70 | 400 |
| S | 4 | 80 | 175 | 114.5 | 136.0 | 70 | 21.0 | 180 | 123.7 | 33.0 | 9.70 | PSFC/S/80 | 350 |

¹⁾Pressure shown = Item deliverable

²⁾L = light series; S = heavy series

$$\frac{PN \text{ (bar)}}{10} = PN \text{ (MPa)}$$

The pressures given here are the maximum allowable for the flange fittings. If the pipe or tube used has a lower pressure rating, then the welded assembly rating will be the lower one, assuming the weld is adequately strong.

*Please add the **suffixes** below according to the material/surface required.

| Order code suffixes | | | |
|---------------------------------|-----------------------------|-------------|-------------------|
| Material | Suffix surface and material | Example | Description |
| Steel, zinc plated, Cr(VI)-free | CF | PSFC/L/10CF | only flange clamp |

PSFA-B Square flange adapter (butt weld)

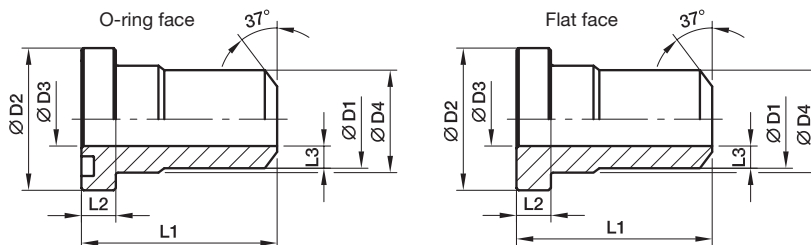
 Square flange / Butt weld end
(ISO 6164)

250 bar Series

| Se-ries ²⁾ | Nom. flange size | | D1 | D2 | D3 | D4 | L1 | L2 | L3 | O-ring | Weight (steel) kg/piece | O-ring face Order code* | Flat face Order code* | PN (bar) ¹⁾ S |
|-----------------------|------------------|----------|-------|-------|----|-------|-----|------|-------|------------|-------------------------|-------------------------|-----------------------|--------------------------|
| | SAE (in.) | ISO (DN) | | | | | | | | | | | | |
| L | 3/8 | 10 | 17.5 | 24.5 | 10 | 18.0 | 40 | 6.8 | 3.75 | 17.13×2.62 | 0.09 | PSFA10/L/17.5B | PSCFA10/L/17.5B | 250 |
| L | 1/2 | 13 | 21.6 | 30.2 | 13 | 24.0 | 50 | 6.8 | 4.30 | 18.64×3.53 | 0.13 | PSFA13/L/21.6B | PSCFA13/L/21.6B | 250 |
| L | 3/4 | 19 | 27.2 | 38.1 | 19 | 31.5 | 60 | 6.8 | 4.10 | 24.99×3.53 | 0.22 | PSFA19/L/27.2B | PSCFA19/L/27.2B | 250 |
| L | 1 | 25 | 34.5 | 44.5 | 25 | 38.0 | 70 | 8.0 | 4.75 | 32.93×3.53 | 0.35 | PSFA25/L/34.5B | PSCFA25/L/34.5B | 250 |
| L | 1 1/4 | 32 | 43.0 | 50.8 | 31 | 43.0 | 80 | 8.0 | 6.00 | 37.89×3.53 | 0.50 | PSFA32/L/43B | PSCFA32/L/43B | 250 |
| L | 1 1/2 | 38 | 48.6 | 60.4 | 38 | 50.0 | 90 | 8.0 | 5.30 | 47.22×3.53 | 0.62 | PSFA38/L/48.6B | PSCFA38/L/48.6B | 250 |
| L | 2 | 51 | 61.0 | 71.4 | 50 | 62.0 | 100 | 9.6 | 5.50 | 56.74×3.53 | 0.88 | PSFA51/L/61B | PSCFA51/L/61B | 250 |
| L | 2 1/2 | 56 | 76.6 | 87.2 | 63 | 76.0 | 110 | 12.0 | 6.80 | 69.44×3.53 | 1.40 | PSFA56/L/76.6B | PSCFA56/L/76.6B | 250 |
| L | 3 | 63 | 89.0 | 101.6 | 70 | 90.0 | 120 | 15.0 | 9.50 | 85.32×3.53 | 2.57 | PSFA63/L/89B | PSCFA63/L/89B | 250 |
| L | 4 | 80 | 114.0 | 131.0 | 90 | 114.0 | 140 | 23.5 | 12.00 | 97.79×5.34 | 6.03 | PSFA80/L/114B | PSCFA80/L/114B | 250 |

400 bar Series

| | | | | | | | | | | | | | | |
|---|-------|----|-------|-------|----|-------|-----|------|-------|------------|------|----------------|-----------------|-----|
| S | 3/8 | 10 | 17.5 | 26.0 | 10 | 18.0 | 40 | 7.8 | 3.75 | 17.13×2.62 | 0.08 | PSFA10/S/17.5B | PSCFA10/S/17.5B | 400 |
| S | 1/2 | 13 | 21.6 | 31.8 | 13 | 24.0 | 50 | 7.8 | 4.30 | 18.64×3.53 | 0.14 | PSFA13/S/21.6B | PSCFA13/S/21.6B | 400 |
| S | 3/4 | 19 | 27.2 | 41.3 | 18 | 32.0 | 60 | 8.8 | 4.60 | 24.99×3.53 | 0.26 | PSFA19/S/27.2B | PSCFA19/S/27.2B | 400 |
| S | 1 | 25 | 34.5 | 47.6 | 22 | 38.0 | 70 | 9.5 | 6.25 | 32.93×3.53 | 0.45 | PSFA25/S/34.5B | PSCFA25/S/34.5B | 400 |
| S | 1 1/4 | 32 | 43.0 | 54.0 | 28 | 44.0 | 90 | 10.3 | 7.50 | 37.89×3.53 | 0.65 | PSFA32/S/43B | PSCFA32/S/43B | 400 |
| S | 1 1/2 | 38 | 48.6 | 63.5 | 32 | 51.0 | 90 | 12.6 | 8.30 | 47.22×3.53 | 0.99 | PSFA38/S/48.6B | PSCFA38/S/48.6B | 400 |
| S | 2 | 51 | 61.0 | 79.4 | 41 | 67.0 | 100 | 12.6 | 10.00 | 56.52×5.34 | 1.73 | PSFA51/S/61B | PSCFA51/S/61B | 400 |
| S | 2 1/2 | 56 | 76.6 | 94.2 | 50 | 90.0 | 110 | 16.5 | 13.30 | 69.22×5.34 | 2.70 | PSFA56/S/76.6B | PSCFA56/S/76.6B | 400 |
| S | 3 | 63 | 89.0 | 104.0 | 58 | 90.0 | 120 | 18.0 | 15.50 | 75.57×5.34 | 3.64 | PSFA63/S/89B | PSCFA63/S/89B | 400 |
| S | 3 1/2 | 70 | 102.0 | 119.0 | 63 | 102.0 | 130 | 20.0 | 19.50 | 85.09×5.34 | 5.55 | PSFA70/S/102B | PSCFA70/S/102B | 400 |
| S | 4 | 80 | 114.0 | 131.0 | 74 | 114.0 | 140 | 23.5 | 20.00 | 88.27×5.34 | 7.10 | PSFA80/S/114B | PSCFA80/S/114B | 350 |

¹⁾Pressure shown = Item deliverable

²⁾L = light series; S = heavy series

PN (bar) = PN (MPa) / 10

The pressures given here are the maximum allowable for the flange fittings. If the pipe or tube used has a lower pressure rating, then the welded assembly rating will be the lower one, assuming the weld is adequately strong.

*Please add the suffixes below according to the material/surface required.

| Order code suffixes | | | |
|-------------------------|-----------------------------|-----------------|---------------------|
| Material | Suffix surface and material | Example | Description |
| Steel, blanc oil dipped | S | PSFA10/L/17.5BS | only flange adapter |



ISO 6164 Square flanges

PSFP Square flange plug

ISO 6164

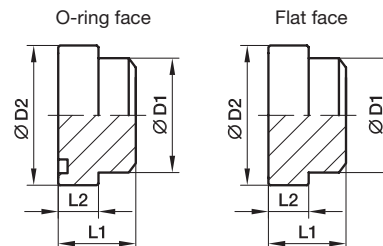
250 bar Series

| Series ²⁾ | Nom. flange size | | D1 | D2 | L1 | L2 | O-ring | Weight (steel) kg/piece | O-ring face Order code* | Flat face Order code* | PN (bar) ¹⁾ S |
|----------------------|------------------|----------|-------|-------|------|------|------------|-------------------------|-------------------------|-----------------------|--------------------------|
| | SAE (in.) | ISO (DN) | | | | | | | | | |
| L | 3/8 | 10 | 18.0 | 24.5 | 18.0 | 6.8 | 17.13×2.62 | 0.07 | PSFP10/L/18B | PSCFP10/L/18B | 250 |
| L | 1/2 | 13 | 24.0 | 30.2 | 20.0 | 6.8 | 18.64×3.53 | 0.08 | PSFP13/L/24B | PSCFP13/L/24B | 250 |
| L | 3/4 | 19 | 31.5 | 38.1 | 22.0 | 6.8 | 24.99×3.53 | 0.17 | PSFP19/L/31.5B | PSCFP19/L/31.5B | 250 |
| L | 1 | 25 | 38.0 | 44.5 | 25.0 | 8.0 | 32.93×3.53 | 0.24 | PSFP25/L/38B | PSCFP25/L/38B | 250 |
| L | 1 1/4 | 32 | 43.0 | 50.8 | 30.0 | 8.0 | 37.89×3.53 | 0.38 | PSFP32/L/43B | PSCFP32/L/43B | 250 |
| L | 1 1/2 | 38 | 50.0 | 60.4 | 36.0 | 8.0 | 47.22×3.53 | 0.63 | PSFP38/L/50B | PSCFP38/L/50B | 250 |
| L | 2 | 51 | 62.0 | 71.4 | 40.0 | 9.6 | 56.74×3.53 | 1.03 | PSFP51/L/62B | PSCFP51/L/62B | 250 |
| L | 2 1/2 | 56 | 76.0 | 87.2 | 45.0 | 12.0 | 69.44×3.53 | 1.75 | PSFP56/L/76B | PSCFP56/L/76B | 250 |
| L | 3 | 63 | 90.0 | 101.6 | 52.0 | 15.0 | 85.32×3.53 | 2.81 | PSFP63/L/90B | PSCFP63/L/90B | 250 |
| L | 4 | 80 | 114.0 | 131.0 | 61.5 | 23.5 | 97.79×5.34 | 4.50 | PSFP80/L/114B | PSCFP80/L/114B | 250 |

400 bar Series

| | | | | | | | | | | | |
|---|-------|----|-------|-------|------|------|------------|------|---------------|----------------|-----|
| S | 3/8 | 10 | 18.0 | 26.0 | 18.0 | 7.8 | 17.13×2.62 | 0.08 | PSFP10/S/18B | PSCFP10/S/18B | 400 |
| S | 1/2 | 13 | 24.0 | 31.8 | 20.0 | 7.8 | 18.64×3.53 | 0.10 | PSFP13/S/24B | PSCFP13/S/24B | 400 |
| S | 3/4 | 19 | 32.0 | 41.3 | 22.0 | 8.8 | 24.99×3.53 | 0.19 | PSFP19/S/32B | PSCFP19/S/32B | 400 |
| S | 1 | 25 | 38.0 | 47.6 | 25.0 | 9.5 | 32.93×3.53 | 0.28 | PSFP25/S/38B | PSCFP25/S/38B | 400 |
| S | 1 1/4 | 32 | 44.0 | 54.0 | 30.0 | 10.3 | 37.89×3.53 | 0.43 | PSFP32/S/44B | PSCFP32/S/44B | 400 |
| S | 1 1/2 | 38 | 51.0 | 63.5 | 36.0 | 12.6 | 47.22×3.53 | 0.70 | PSFP38/S/51B | PSCFP38/S/51B | 400 |
| S | 2 | 51 | 67.0 | 79.4 | 40.0 | 12.6 | 56.52×5.34 | 1.28 | PSFP51/S/67B | PSCFP51/S/67B | 400 |
| S | 2 1/2 | 56 | 80.0 | 94.2 | 45.0 | 16.5 | 69.22×5.34 | 2.21 | PSFP56/S/80B | PSCFP56/S/80B | 400 |
| S | 3 | 63 | 90.0 | 104.0 | 52.0 | 18.0 | 75.57×5.34 | 2.80 | PSFP63/S/90B | PSCFP63/S/90B | 400 |
| S | 3 1/2 | 70 | 102.0 | 119.0 | 60.0 | 20.0 | 85.09×5.34 | 4.29 | PSFP70/S/102B | PSCFP70/S/102B | 400 |
| S | 4 | 80 | 114.0 | 131.0 | 70.0 | 23.5 | 88.27×5.34 | 4.50 | PSFP80/S/114B | PSCFP80/S/114B | 350 |

¹⁾Pressure shown = Item deliverable

²⁾L = light series; S = heavy series

$$\frac{PN \text{ (bar)}}{10} = PN \text{ (MPa)}$$

The pressures given here are the maximum allowable for the flange fittings. If the pipe or tube used has a lower pressure rating, then the welded assembly rating will be the lower one, assuming the weld is adequately strong.

*Please add the **suffixes** below according to the material/surface required.

| Order code suffixes | | | |
|-------------------------|-----------------------------|---------------|------------------|
| Material | Suffix surface and material | Example | Description |
| Steel, blanc oil dipped | S | PSFP10/L/18BS | only flange plug |



PSF-B Square flange (butt weld adapter coupling)

Square flange / Butt weld end
(ISO 6164)

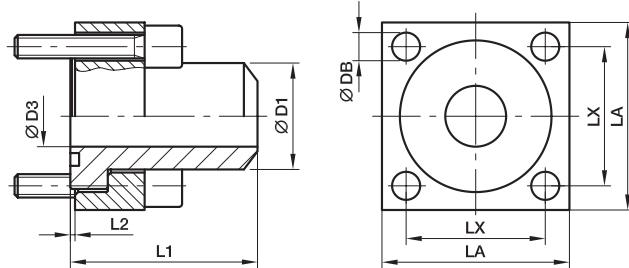

250 bar Series

| Series ²⁾ | Nom. flange size | | D1 | D3 | L1 | L2 | LA | LX | DB | Bolts (metr.) | O-ring | Weight (steel) kg/piece | Order code* | PN (bar) ¹⁾ S |
|----------------------|------------------|----------|-------|----|-----|-----|-----|-------|------|---------------|------------|-------------------------|----------------------|-----------------------------|
| | SAE (in.) | ISO (DN) | | | | | | | | | | | | |
| L | 3/8 | 10 | 17.5 | 10 | 40 | 0.4 | 40 | 24.7 | 6.6 | M 06×30 | 17.13×2.62 | 0.25 | PSF10/L/17.5B | 250 |
| L | 1/2 | 13 | 21.6 | 13 | 50 | 0.4 | 45 | 29.7 | 9.0 | M 08×35 | 18.64×3.53 | 0.30 | PSF13/L/21.6B | 250 |
| L | 3/4 | 19 | 27.2 | 19 | 60 | 0.4 | 50 | 35.4 | 9.0 | M 08×35 | 24.99×3.53 | 0.53 | PSF19/L/27.2B | 250 |
| L | 1 | 25 | 34.5 | 25 | 70 | 0.5 | 65 | 43.8 | 11.0 | M 10×40 | 32.93×3.53 | 0.98 | PSF25/L/34.5B | 250 |
| L | 1 1/4 | 32 | 43.0 | 31 | 80 | 0.5 | 75 | 51.6 | 13.5 | M 12×50 | 37.89×3.53 | 1.53 | PSF32/L/43B | 250 |
| L | 1 1/2 | 38 | 48.6 | 38 | 90 | 0.5 | 90 | 60.1 | 17.5 | M 16×60 | 47.22×3.53 | 2.52 | PSF38/L/48.6B | 250 |
| L | 2 | 51 | 61.0 | 50 | 100 | 0.6 | 100 | 69.3 | 17.5 | M 16×70 | 56.74×3.53 | 3.23 | PSF51/L/61B | 250 |
| L | 2 1/2 | 56 | 76.6 | 63 | 110 | 3.0 | 120 | 83.4 | 22.0 | M 20×80 | 69.44×3.53 | 5.82 | PSF56/L/76.6B | 250 |
| L | 3 | 63 | 89.0 | 70 | 120 | 6.0 | 140 | 102.5 | 22.0 | M 20×90 | 85.32×3.53 | 8.19 | PSF63/L/89B | 250 |
| L | 4 | 80 | 114.0 | 90 | 140 | 2.5 | 160 | 113.5 | 25.0 | M 24×100 | 97.79×5.34 | 12.45 | PSF80/L/114B | 250 |

400 bar Series

| | | | | | | | | | | | | | | |
|---|-------|----|-------|----|-----|-----|-----|-------|------|----------|------------|-------|----------------------|-----|
| S | 3/8 | 10 | 17.5 | 10 | 40 | 0.6 | 40 | 24.7 | 6.6 | M 06×30 | 17.13×2.62 | 0.26 | PSF10/S/17.5B | 400 |
| S | 1/2 | 13 | 21.6 | 13 | 50 | 0.6 | 45 | 29.7 | 9.0 | M 08×35 | 18.64×3.53 | 0.31 | PSF13/S/21.6B | 400 |
| S | 3/4 | 19 | 27.2 | 18 | 60 | 0.6 | 50 | 35.4 | 9.0 | M 08×35 | 24.99×3.53 | 0.55 | PSF19/S/27.2B | 400 |
| S | 1 | 25 | 34.5 | 22 | 70 | 0.5 | 65 | 43.8 | 11.0 | M 10×40 | 32.93×3.53 | 1.02 | PSF25/S/34.5B | 400 |
| S | 1 1/4 | 32 | 43.0 | 28 | 90 | 0.5 | 75 | 51.6 | 13.5 | M 12×50 | 37.89×3.53 | 1.70 | PSF32/S/43B | 400 |
| S | 1 1/2 | 38 | 48.6 | 32 | 90 | 0.6 | 90 | 60.1 | 17.5 | M 16×60 | 47.22×3.53 | 2.76 | PSF38/S/48.6B | 400 |
| S | 2 | 51 | 61.0 | 41 | 100 | 0.6 | 100 | 69.3 | 17.5 | M 16×70 | 56.52×5.34 | 3.81 | PSF51/S/61B | 400 |
| S | 2 1/2 | 56 | 76.6 | 50 | 110 | 0.4 | 120 | 83.4 | 22.0 | M 20×80 | 69.22×5.34 | 6.75 | PSF56/S/76.6B | 400 |
| S | 3 | 63 | 89.0 | 58 | 120 | 1.9 | 150 | 102.5 | 26.0 | M 24×90 | 75.57×5.34 | 11.00 | PSF63/S/89B | 400 |
| S | 3 1/2 | 70 | 102.0 | 63 | 130 | 2.5 | 160 | 113.1 | 26.0 | M 24×100 | 85.09×5.34 | 13.60 | PSF70/S/102B | 400 |
| S | 4 | 80 | 114.0 | 74 | 140 | 2.5 | 180 | 123.7 | 33.0 | M 30×120 | 88.27×5.34 | 19.97 | PSF80/S/114B | 350 |

¹⁾Pressure shown = Item deliverable

²⁾L = light series; S = heavy series

PN (bar) = PN (MPa)
10

The pressures given here are the maximum allowable for the flange fittings. If the pipe or tube used has a lower pressure rating, then the welded assembly rating will be the lower one, assuming the weld is adequately strong.

*Please add the **suffixes** below according to the material/surface required.

| Order code suffixes | | | |
|-------------------------|-----------------------------|--|---|
| Material | Suffix surface and material | Example incl. flange clamp, metr. bolts and O-ring | Standard sealing material (no additional suffix needed) |
| Steel, blanc oil dipped | S | PSF10/L/17.5BS | NBR |



ISO 6164 Square flanges

PDSF-B Square flange (butt weld connection)

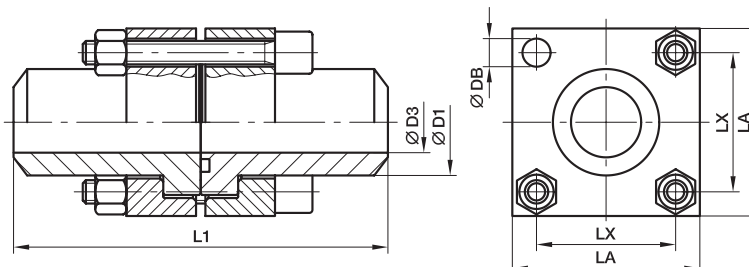
 Square flange / Butt weld tube end
(ISO 6164)

250 bar Series

| Series ²⁾ | Nom. flange size | | D1 | D3 | L1 | LA | LX | DB | Bolts (Metr.) | O-ring | Weight (steel) kg/piece | Order code* | PN (bar) ¹⁾ S |
|----------------------|------------------|-------------|-------|----|-----|-----|-------|------|------------------|------------|-------------------------------|-----------------------|--------------------------------|
| | SAE (in.) | ISO (DN) | | | | | | | | | | | |
| L | 3/8 | 10 | 17.5 | 10 | 80 | 40 | 24.7 | 6.6 | M 06×45 | 17.13×2.62 | 0.50 | PDSF10/L/17.5B | 250 |
| L | 1/2 | 13 | 21.6 | 13 | 100 | 45 | 29.7 | 9.0 | M 08×50 | 18.64×3.53 | 0.60 | PDSF13/L/21.6B | 250 |
| L | 3/4 | 19 | 27.2 | 19 | 120 | 50 | 35.4 | 9.0 | M 08×55 | 24.99×3.53 | 1.06 | PDSF19/L/27.2B | 250 |
| L | 1 | 25 | 34.5 | 25 | 140 | 65 | 43.8 | 11.0 | M 10×65 | 32.93×3.53 | 1.96 | PDSF25/L/34.5B | 250 |
| L | 1 1/4 | 32 | 43.0 | 31 | 160 | 75 | 51.6 | 13.5 | M 12×75 | 37.89×3.53 | 3.06 | PDSF32/L/43B | 250 |
| L | 1 1/2 | 38 | 48.6 | 38 | 180 | 90 | 60.1 | 17.5 | M 16×90 | 47.22×3.53 | 5.04 | PDSF38/L/48.6B | 250 |
| L | 2 | 51 | 61.0 | 50 | 200 | 100 | 69.3 | 17.5 | M 16×100 | 56.74×3.53 | 6.46 | PDSF51/L/61B | 250 |
| L | 2 1/2 | 56 | 76.6 | 63 | 220 | 120 | 83.4 | 22.0 | M 20×120 | 69.44×3.53 | 11.62 | PDSF56/L/76.6B | 250 |
| L | 3 | 63 | 89.0 | 70 | 240 | 140 | 102.5 | 22.0 | M 20×140 | 85.32×3.53 | 16.38 | PDSF63/L/89B | 250 |
| L | 4 | 80 | 114.0 | 90 | 280 | 160 | 113.5 | 25.0 | M 24×150 | 97.79×5.34 | 24.90 | PDSF80/L/114B | 250 |

400 bar Series

| | | | | | | | | | | | | | |
|---|-------|----|-------|----|-----|-----|-------|------|----------|------------|-------|-----------------------|-----|
| S | 3/8 | 10 | 17.5 | 10 | 80 | 40 | 24.7 | 6.6 | M 06×45 | 17.13×2.62 | 0.52 | PDSF10/S/17.5B | 400 |
| S | 1/2 | 13 | 21.6 | 13 | 100 | 45 | 29.7 | 9.0 | M 08×50 | 18.64×3.53 | 0.62 | PDSF13/S/21.6B | 400 |
| S | 3/4 | 19 | 27.2 | 18 | 120 | 50 | 35.4 | 9.0 | M 08×55 | 24.99×3.53 | 1.10 | PDSF19/S/27.2B | 400 |
| S | 1 | 25 | 34.5 | 22 | 140 | 65 | 43.8 | 11.0 | M 10×65 | 32.93×3.53 | 2.04 | PDSF25/S/34.5B | 400 |
| S | 1 1/4 | 32 | 43.0 | 28 | 180 | 75 | 51.6 | 13.5 | M 12×75 | 37.89×3.53 | 3.40 | PDSF32/S/43B | 400 |
| S | 1 1/2 | 38 | 48.6 | 32 | 180 | 90 | 60.1 | 17.5 | M 16×90 | 47.22×3.53 | 5.52 | PDSF38/S/48.6B | 400 |
| S | 2 | 51 | 61.0 | 41 | 200 | 100 | 69.3 | 17.5 | M 16×100 | 56.52×5.34 | 7.62 | PDSF51/S/61B | 400 |
| S | 2 1/2 | 56 | 76.6 | 50 | 220 | 120 | 83.4 | 22.0 | M 20×130 | 69.22×5.34 | 13.50 | PDSF56/S/76.6B | 400 |
| S | 3 | 63 | 89.0 | 58 | 240 | 150 | 102.5 | 26.0 | M 24×140 | 75.57×5.34 | 22.00 | PDSF63/S/89B | 400 |
| S | 3 1/2 | 70 | 102.0 | 63 | 260 | 160 | 113.1 | 26.0 | M 24×150 | 85.09×5.34 | 27.20 | PDSF70/S/102B | 400 |
| S | 4 | 80 | 114.0 | 74 | 280 | 180 | 123.7 | 33.0 | M 30×180 | 88.27×5.34 | 39.94 | PDSF80/S/114B | 350 |

¹⁾Pressure shown = Item deliverable

²⁾L = light series; S = heavy series

$$\frac{\text{PN (bar)}}{10} = \text{PN (M Pa)}$$

The pressures given here are the maximum allowable for the flange fittings. If the pipe or tube used has a lower pressure rating, then the welded assembly rating will be the lower one, assuming the weld is adequately strong.

 *Please add the **suffixes** below according to the material/surface required.

| Order code suffixes | | | |
|-------------------------|-----------------------------|---|---|
| Material | Suffix surface and material | Example Flange coupling incl. flange clamps, metr. bolts and O-ring | Standard sealing material (no additional suffix needed) |
| Steel, blanc oil dipped | S | PDSF10/L/17.5BS | NBR |







































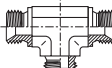

Adapters

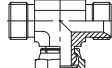

Adapters

Visual index

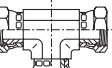
| | | | | | | |
|--|---|---|---|--|---|---|
| NPTF Adapters Male/male |  |  |  |  | | |
| | FF / p.04 | CR / p.05 | RRS / p.05 | FFFM / p.06 | | |
| NPTF Adapters Male/Female |  |  |  |  |  |  |
| | PTRM / p.07 | FGM / p.08 | CDM / p.09 | CD45 / p.010 | MRO / p.011 | MMS / p.012 |
| NPTF Adapters Female/Female |  |  |  |  |  | |
| | GG / p.013 | DD / p.014 | DD45 / p.014 | MMO / p.015 | KMMOO / p.015 | |
| NPTF Plug |  |  | UNF/NPTF Adapters |  |  |  |
| | HP / p.016 | HHP / p.016 | | F50G / p.017 | AOEG / p.018 | AOE4G / p.018 |
| UNF Adapters |  |  |  | UNF/ Plugs |  |  |
| | F50G5 / p.019 | F50HAO / p.020 | G5G5JG5 / p.020 | | P50NM / p.021 | HP50N / p.022 |
| BSPT-BSPP metric-UNF Conversion adapters |  |  |  | | | |
| | F3HG5 / p.023 | F4OHG5 / p.024 | F8OHG5 / p.025 | | | |
| Male/Male adapters BSPP 60° cone, BSPT, NPT |  |  |  |  |  |  |
| | HMK4 / p.026 | WMK4WL4NM / p.027 | EMK4 / p.028 | JMK4 / p.028 | F3MK4 / p.038 | FMK4 / p.040 |
| Male/Female swivel adapters BSPP 60° cone |  |  |  |  | | |
| | F6MK4 / p.030 | C6MK4 / p.031 | R6MK4 / p.032 | S6MK4 / p.033 | | |
| Female/Female swivel adapters BSPP 60° cone |  |  |  | | | |
| | H6MK4 / p.034 | E6MK4 / p.035 | J6MK4 / p.036 | | | |

Visual index

| | | | | | | | | | |
|--|------------------------------------|-----------------------------|----------------------|------------------------|----------------------|-------------------|----------------------|----------------------|---------------------|
| BSPP 60° cone Expander/Adapter cap | | | | | | | | | |
| | G4MK4 / p.037 | | FNMK4 / p.039 | | PNMK4 / p.029 | | | | |
| BSPP Adapters Female/Female | | | | | | | | | |
| | GG44M / p.041 | | | MMO444M / p.042 | | | | | |
| Reducing bushes BSPP/BSPT | | BSPT male union and plug | | | | | | | |
| | PTR34M / p.043 | | | FF33M / p.044 | | HP3M p.045 | | | |
| Female swivel NPSM / male NPTF | | | | | | | | | |
| | 0107 / p.046 | | 2107 / p.047 | | 3107 / p.048 | | | | |
| Female swivel NPSM / female NPTF | | | | | | | | | |
| | 0207 / p.049 | | 2207 / p.050 | | | | | | |
| Female swivel NPSM / male UNF | | | | | | | | | |
| | 0507 / p.051 | | 2507 / p.052 | | 3507 / p.053 | | | | |
| JIS Adapters Male to BSPT | | | | JIS Unions | | | | | |
| | F3T4 / p.054 | | C3T4 / p.055 | | V3T4 / p.055 | | HP4 / p.056 | HP46 / p.056 | |
| JIS Adapters Female cone to BSPT | | | | | | | | | |
| | F3P4 / p.057 | | C3P4 / p.057 | | V3P4 / p.058 | | F63P4 / p.058 | G63P4 / p.059 | G3P4 / p.059 |
| Seals/ Retaining ring | | | | | | | | | |
| | Adapter Components p.060 | | | | | | | | |



Adapters

FF Male nipple

Male NPTF* thread (SAE J476) / Male NPTF* thread (SAE J476)

SAE 140137

*Stainless Steel = NPT to prevent galling

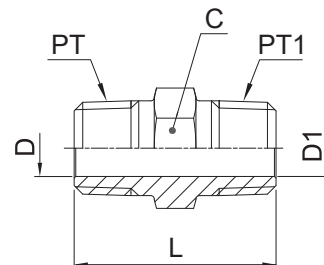

| Thread NPT/NPTF PT | Thread NPT/NPTF PT1 | C mm | D mm | D1 mm | L mm | Weight (steel) g/1 piece | Adapter Steel | Adapter Stainless Steel | PN (bar) | |
|--------------------------|---------------------------|---------|---------|----------|---------|--------------------------------|------------------|----------------------------|----------|-----|
| | | | | | | | | | S | SS |
| 1/8-27 | 1/8-27 | 11.0 | 4.8 | 4.8 | 27 | 11 | 1/8 FF-S | 1/8FFMSS | 420 | 420 |
| 1/4-18 | 1/8-27 | 16.0 | 7.1 | 4.8 | 32 | 31 | 1/4 X 1/8 FF-S | 1/4X1/8FFMSS | 420 | 420 |
| 1/4-18 | 1/4-18 | 16.0 | 7.1 | 7.1 | 37 | 28 | 1/4 FF-S | 1/4FFMSS | 420 | 420 |
| 3/8-18 | 1/8-27 | 19.0 | 10.3 | 4.8 | 32 | 45 | 3/8 X 1/8 FF-S | 3/8X1/8FFMSS | 420 | 420 |
| 3/8-18 | 1/4-18 | 19.0 | 10.3 | 7.0 | 37 | 51 | 3/8 X 1/4 FF-S | 3/8X1/4FFMSS | 420 | 420 |
| 3/8-18 | 3/8-18 | 19.0 | 10.3 | 10.3 | 37 | 40 | 3/8 FF-S | 3/8FFMSS | 420 | 420 |
| 1/2-14 | 1/8-27 | 22.2 | 13.5 | 4.8 | 39 | 58 | 1/2 X 1/8 FF-S | 1/2X1/8FFMSS | 420 | 420 |
| 1/2-14 | 1/4-18 | 22.2 | 13.5 | 7.1 | 43 | 88 | 1/2 X 1/4 FF-S | 1/2X1/4FFMSS | 420 | 420 |
| 1/2-14 | 3/8-18 | 22.2 | 13.5 | 10.3 | 43 | 71 | 1/2 X 3/8 FF-S | 1/2X3/8FFMSS | 420 | 420 |
| 1/2-14 | 1/2-14 | 22.2 | 13.5 | 13.5 | 48 | 71 | 1/2FFMS | 1/2FFMSS | 420 | 420 |
| 3/4-14 | 1/4-18 | 28.6 | 18.3 | 7.1 | 45 | 104 | 3/4 X 1/4 FF-S | 3/4X1/4FFMSS | 380 | 380 |
| 3/4-14 | 3/8-18 | 28.6 | 18.3 | 10.3 | 45 | 134 | 3/4 X 3/8 FF-S | 3/4X3/8FFMSS | 380 | 380 |
| 3/4-14 | 1/2-14 | 28.6 | 18.3 | 13.5 | 50 | 161 | 3/4 X 1/2 FF-S | 3/4X1/2FFMSS | 380 | 380 |
| 3/4-14 | 3/4-14 | 28.6 | 18.3 | 18.3 | 50 | 104 | 3/4 FF-S | 3/4FFMSS | 380 | 380 |
| 1-11.5 | 1-11.5 | 35.0 | 23.8 | 23.8 | 59 | 179 | 1 FF-S | 1FFMSS | 380 | 380 |
| 1-11.5 | 1/4-18 | 35.0 | 23.8 | 7.1 | 50 | 188 | 1 X 1/4 FF-S | 1X1/4FFMSS | 380 | 380 |
| 1-11.5 | 3/4-14 | 35.0 | 23.8 | 18.3 | 53 | 195 | 1 X 3/4 FF-S | 1X3/4FFMSS | 380 | 380 |
| 1 1/4-11.5 | 1-11.5 | 44.5 | 31.8 | 23.8 | 62 | 256 | 1 1/4 X 1 FF-S | 11/4X1FFMSS | 350 | 350 |
| 1 1/4-11.5 | 1 1/4-11.5 | 44.5 | 31.8 | 31.8 | 63 | 256 | 1 1/4 FF-S | 11/4FFMSS | 350 | 350 |
| 1 1/2-11.5 | 1-11.5 | 50.8 | 38.1 | 23.8 | 65 | 341 | 1 1/2 X 1 FF-S | 11/2X1FFMX | 210 | 210 |
| 1 1/2-11.5 | 1 1/2-11.5 | 50.8 | 38.1 | 38.1 | 66 | 364 | 1 1/2 FF-S | 11/2FFMSS | 210 | 210 |
| 2-11.5 | 2-11.5 | 63.5 | 49.2 | 49.2 | 72 | 848 | 2 FF-S | 2FFMSS | 170 | 170 |

Order codes shown are part of our current manufacturing programme.

Imperial and metric parts may vary in hexagon dimensions.

$\frac{\text{PN (bar)}}{10} = \text{PN (MPa)}$

Do not create drawings from these dimensions, they are subject to change and ISO manufacturing allowances.

CR Male thread elbow

Male NPTF* thread (SAE J476) / Male NPTF* thread (SAE J476)

SAE 140237

*Stainless Steel = NPT to prevent galling

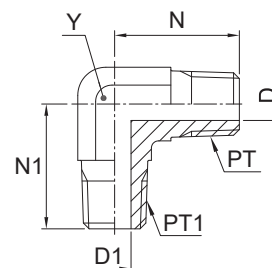

| Thread NPT/NPTF PT | Thread NPT/NPTF PT1 | D mm | D1 mm | N mm | N1 mm | Y mm | Weight (steel) g/1 piece | Adapter Steel | Adapter Stainless Steel | PN (bar) | |
|--------------------------|---------------------------|---------|----------|---------|----------|---------|--------------------------------|------------------|----------------------------|----------|-----|
| | | | | | | | | | | S | SS |
| 1/8-27 | 1/8-27 | 4.8 | 4.8 | 20 | 20 | 11.0 | 27 | 1/8 CR-S | 1/8 CR-SS | 420 | 420 |
| 1/4-18 | 1/4-18 | 7.1 | 7.1 | 28 | 28 | 14.0 | 54 | 1/4 CR-S | 1/4 CR-SS | 420 | 420 |
| 3/8-18 | 3/8-18 | 10.3 | 10.3 | 31 | 31 | 19.0 | 181 | 3/8 CR-S | 3/8 CR-SS | 420 | 420 |
| 3/8-18 | 1/4-18 | 10.3 | 7.1 | 31 | 31 | 19.0 | 66 | 3/8 X 1/4 CR-S | 3/8 X 1/4 CR-SS | 420 | 420 |
| 1/2-14 | 1/2-14 | 13.5 | 13.5 | 37 | 37 | 22.0 | 172 | 1/2 CR-S | 1/2 CR-SS | 420 | 420 |
| 1/2-14 | 3/8-18 | 13.5 | 10.3 | 37 | 33 | 22.0 | 103 | 1/2 X 3/8 CR-S | 1/2 X 3/8 CR-SS | 420 | 420 |
| 3/4-14 | 3/4-14 | 18.3 | 18.3 | 40 | 40 | 27.0 | 263 | 3/4 CR-S | 3/4 CR-SS | 280 | 280 |
| 3/4-14 | 1/2-14 | 18.3 | 13.5 | 40 | 37 | 27.0 | 164 | 3/4 X 1/2 CR-S | 3/4 X 1/2 CR-SS | 280 | 280 |
| 1-11.5 | 1-11.5 | 23.8 | 23.8 | 50 | 50 | 33.3 | 462 | 1 CR-S | 1 CR-SS | 210 | 210 |
| 1 1/4-11.5 | 1 1/4-11.5 | 31.8 | 31.8 | 56 | 56 | 47.6 | 782 | 1 1/4 CR-S | 1 1/4 CR-SS | 170 | 170 |
| 1 1/2-11.5 | 1 1/2-11.5 | 38.1 | 38.1 | 59 | 59 | 47.6 | 782 | 1 1/2 CR-S | 1 1/2 CR-SS | 170 | 170 |

Do not create drawings from these dimensions, they are subject to change and ISO manufacturing allowances.

RRS Male thread tee

Male NPTF* thread (SAE J476)

SAE 140437

*Stainless Steel = NPT to prevent galling

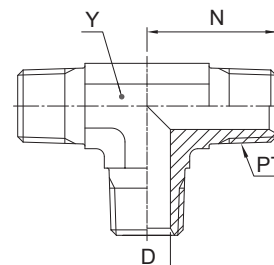

| Thread NPT/NPTF PT | D mm | N mm | Y mm | Weight (steel) g/1 piece | Adapter Steel | Adapter Stainless Steel | PN (bar) | |
|--------------------------|---------|---------|---------|--------------------------------|------------------|----------------------------|----------|-----|
| | | | | | | | S | SS |
| 1/8-27 | 4.8 | 20 | 11 | 33 | 1/8 RRS-S | 1/8 RRS-SS | 420 | 420 |
| 1/4-18 | 7.1 | 28 | 14 | 56 | 1/4 RRS-S | 1/4 RRS-SS | 420 | 420 |
| 3/8-18 | 10.3 | 31 | 19 | 92 | 3/8 RRS-S | 3/8 RRS-SS | 420 | 420 |
| 1/2-14 | 13.5 | 37 | 22 | 96 | 1/2 RRS-S | 1/2 RRS-SS | 420 | 420 |
| 3/4-14 | 18.3 | 40 | 27 | 235 | 3/4 RRS-S | 3/4 RRS-SS | 280 | 280 |

Order codes shown are part of our current manufacturing programme.

Imperial and metric parts may vary in hexagon dimensions.

PN (bar) = PN (MPa)
10

Do not create drawings from these dimensions, they are subject to change and ISO manufacturing allowances.

Adapters

FFFM Extended male nipple

Male NPTF* thread (SAE J476) / Male NPTF* thread (SAE J476)

*Stainless Steel = NPT to prevent galling

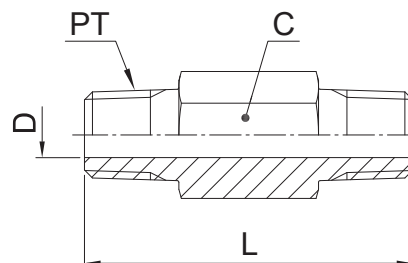

| Thread NPT/NPTF PT | C mm | D mm | L mm | Weight (steel) g/1 piece | Adapter Steel | Adapter Stainless Steel | PN (bar) | |
|--------------------------|---------|---------|---------|--------------------------------|------------------|----------------------------|----------|-----|
| | | | | | | | S | SS |
| 1/8-27 | 11.0 | 4.8 | 38 | 23 | 1/8 X 1.5 FFF-S | 1/8X1.5FFFMS | 420 | 420 |
| 1/8-27 | 11.0 | 4.8 | 51 | 33 | 1/8 X 2.0 FFF-S | 1/8X2.0FFFMS | 420 | 420 |
| 1/8-27 | 11.0 | 4.8 | 64 | 41 | 1/8 X 2.5 FFF-S | 1/8X2.5FFFMS | 420 | 420 |
| 1/8-27 | 11.0 | 4.8 | 76 | 50 | 1/8 X 3.0 FFF-S | 1/8X3.0FFFMS | 420 | 420 |
| 1/4-18 | 16.0 | 7.1 | 38 | 35 | 1/4 X 1.5 FFF-S | 1/4X1.5FFFMS | 420 | 420 |
| 1/4-18 | 16.0 | 7.1 | 51 | 51 | 1/4 X 2.0 FFF-S | 1/4X2.0FFFMS | 420 | 420 |
| 1/4-18 | 16.0 | 7.1 | 64 | 72 | 1/4 X 2.5 FFF-S | 1/4X2.5FFFMS | 420 | 420 |
| 1/4-18 | 16.0 | 7.1 | 76 | 93 | 1/4 X 3.0 FFF-S | 1/4X3.0FFFMS | 420 | 420 |
| 1/4-18 | 16.0 | 7.1 | 102 | 110 | 1/4 X 4.0 FFF-S | 1/4X4.0FFFMS | 420 | 420 |
| 1/2-14 | 22.2 | 13.5 | 51 | 91 | 1/2 X 2.0 FFF-S | 1/2X2.0FFFMS | 420 | 420 |
| 1/2-14 | 22.2 | 13.5 | 76 | 151 | 1/2 X 3.0 FFF-S | 1/2X3.0FFFMS | 420 | 420 |

Order codes shown are part of our current manufacturing programme.

Imperial and metric parts may vary in hexagon dimensions.

$$\frac{\text{PN (bar)}}{10} = \text{PN (MPa)}$$

Do not create drawings from these dimensions, they are subject to change and ISO manufacturing allowances.

PTRM Thread reducer

Male NPTF* thread (SAE J476) / Female NPTF* thread (SAE J476)

SAE 140140

*Stainless Steel = NPT to prevent galling

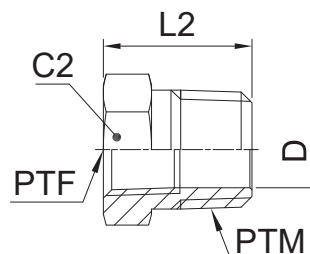

| Thread NPT/NPTF PTM | Thread NPT/NPTF PTF | C2 mm | D mm | L2 mm | Weight (steel) g/1 piece | Adapter Steel | Adapter Stainless Steel | PN (bar) | |
|---------------------------|---------------------------|----------|---------|----------|--------------------------------|-------------------|----------------------------|----------|-----|
| | | | | | | | | S | SS |
| 1/4-18 | 1/8-27 | 16.0 | 8.3 | 22 | 24 | 1/4 X 1/8 PTR-S | 1/4X1/8PTRMSS | 420 | 420 |
| 3/8-18 | 1/8-27 | 19.0 | 8.3 | 22 | 25 | 3/8 X 1/8 PTR-S | 3/8X1/8PTRMSS | 420 | 420 |
| 3/8-18 | 1/4-18 | 19.0 | 10.7 | 22 | 25 | 3/8 X 1/4 PTR-S | 3/8X1/4PTRMSS | 420 | 420 |
| 1/2-14 | 1/8-27 | 22.2 | 8.3 | 28 | 58 | 1/2 X 1/8 PTR-S | 1/2X1/8PTRMSS | 420 | 350 |
| 1/2-14 | 1/4-18 | 22.2 | 10.7 | 28 | 53 | 1/2 X 1/4 PTR-S | 1/2X1/4PTRMSS | 420 | 350 |
| 1/2-14 | 3/8-18 | 22.2 | 13.5 | 28 | 40 | 1/2 X 3/8 PTR-S | 1/2X3/8PTRMSS | 420 | 350 |
| 3/4-14 | 1/8-27 | 28.6 | 18.3 | 30 | 82 | 3/4 X 1/8 PTR-S | 3/4X1/8PTRMSS | 280 | 280 |
| 3/4-14 | 1/4-18 | 28.6 | 10.7 | 30 | 94 | 3/4 X 1/4 PTR-S | 3/4X1/4PTRMSS | 280 | 280 |
| 3/4-14 | 3/8-18 | 28.6 | 14.2 | 30 | 101 | 3/4 X 3/8 PTR-S | 3/4X3/8PTRMSS | 380 | 280 |
| 3/4-14 | 1/2-14 | 28.6 | 17.5 | 30 | 110 | 3/4 X 1/2 PTR-S | 3/4X1/2PTRMSS | 350 | 280 |
| 1-11.5 | 1/8-27 | 35.0 | 23.8 | 35 | 132 | 1 X 1/8 PTR-S | 1X1/8PTRMSS | 210 | 210 |
| 1-11.5 | 1/4-18 | 35.0 | 23.8 | 35 | 132 | 1 X 1/4 PTR-S | 1X1/4PTRMSS | 210 | 210 |
| 1-11.5 | 3/8-18 | 35.0 | 14.2 | 35 | 163 | 1 X 3/8 PTR-S | 1X3/8PTRMSS | 210 | 210 |
| 1-11.5 | 1/2-14 | 35.0 | 17.5 | 35 | 139 | 1 X 1/2 PTR-S | 1X1/2PTRMSS | 210 | 210 |
| 1-11.5 | 3/4-14 | 35.0 | 22.8 | 35 | 116 | 1 X 3/4 PTR-S | 1X3/4PTRMSS | 280 | 210 |
| 1 1/4-11.5 | 1/2-14 | 44.5 | 17.5 | 37 | 220 | 1 1/4 X 1/2 PTR-S | 11/4X1/2PTRMSS | 170 | 170 |
| 1 1/4-11.5 | 3/4-14 | 44.5 | 22.8 | 37 | 236 | 1 1/4 X 3/4 PTR-S | 11/4X3/4PTRMSS | 170 | 170 |
| 1 1/4-11.5 | 1-11.5 | 46.0 | 28.7 | 37 | 250 | 1 1/4X1PTRMS | 11/4X1PTRMSS | 210 | 175 |
| 1 1/2-11.5 | 3/4-14 | 50.8 | 22.8 | 40 | 306 | 1 1/2 X 3/4 PTR-S | 11/2X3/4PTRMSS | 140 | 140 |
| 1 1/2-11.5 | 1-11.5 | 50.0 | 29.0 | 40 | 360 | 1 1/2X1PTRMS | 11/2X1PTRMSS | 210 | 140 |
| 1 1/2-11.5 | 1 1/4-11.5 | 50.8 | 38.1 | 40 | 282 | 1 1/2X1 1/4 PTR-S | 11/2X11/4PTRMSS | 170 | 140 |
| 2-11.5 | 1/2-14 | 63.5 | 17.5 | 45 | 561 | 2 X 1/2 PTR-S | 2X1/2PTRMSS | 140 | 140 |
| 2-11.5 | 1-11.5 | 63.5 | 49.2 | 45 | 550 | 2 X 1 PTR-S | 2X1PTRMSS | 140 | 140 |
| 2-11.5 | 1 1/4-11.5 | 63.5 | 37.4 | 45 | 548 | 2 X 1 1/4 PTR-S | 2X11/4PTRMSS | 140 | 140 |

Order codes shown are part of our current manufacturing programme.

Imperial and metric parts may vary in hexagon dimensions.

$$\frac{\text{PN (bar)}}{10} = \text{PN (MPa)}$$

Do not create drawings from these dimensions, they are subject to change and ISO manufacturing allowances.

Adapters

FGM Thread expander / Adapter

Male NPTF* thread (SAE J476) / Female NPTF* thread (SAE J476)

SAE 140139

*Stainless Steel = NPT to prevent galling

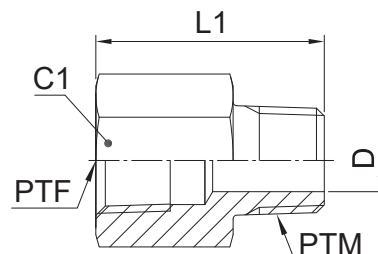

| Thread NPT/NPTF PTF | Thread NPT/NPTF PTM | C1 mm | D mm | L1 mm | Weight (steel) g/1 piece | Adapter Steel | Adapter Stainless Steel | PN (bar) | |
|---------------------------|---------------------------|----------|---------|----------|--------------------------------|------------------|----------------------------|----------|-----|
| | | | | | | | | S | SS |
| 1/8-27 | 1/8-27 | 16.0 | 4.8 | 26 | 30 | 1/8 FG-S | 1/8FGMSS | 420 | 420 |
| 1/4-18 | 1/8-27 | 19.0 | 4.8 | 31 | 57 | 1/4 X 1/8 FG-S | 1/4X1/8FGMSS | 420 | 420 |
| 1/4-18 | 1/4-18 | 19.0 | 7.1 | 35 | 44 | 1/4 FG-S | 1/4FGMSS | 420 | 420 |
| 3/8-18 | 1/8-27 | 22.2 | 4.8 | 32 | 50 | 3/8 X 1/8 FG-S | 3/8X1/8FGMSS | 420 | 420 |
| 3/8-18 | 1/4-18 | 22.2 | 7.1 | 37 | 108 | 3/8 X 1/4 FG-S | 3/8X1/4FGMSS | 420 | 420 |
| 3/8-18 | 3/8-18 | 22.2 | 10.3 | 37 | 55 | 3/8 FG-S | 3/8FGMSS | 420 | 420 |
| 1/2-14 | 1/8-27 | 28.6 | 4.8 | 38 | 98 | 1/2 X 1/8 FG-S | 1/2X1/8FGMSS | 350 | 350 |
| 1/2-14 | 1/4-18 | 28.6 | 7.1 | 43 | 104 | 1/2 X 1/4 FG-S | 1/2X1/4FGMSS | 350 | 350 |
| 1/2-14 | 3/8-18 | 28.6 | 10.3 | 43 | 108 | 1/2 X 3/8 FG-S | 1/2X3/8FGMSS | 350 | 350 |
| 1/2-14 | 1/2-14 | 28.6 | 13.5 | 48 | 108 | 1/2 FG-S | 1/2FGMSS | 350 | 350 |
| 3/4-14 | 3/4-14 | 35.0 | 18.3 | 49 | 178 | 3/4 FG-S | 3/4FGMSS | 280 | 280 |
| 3/4-14 | 1/4-18 | 35.0 | 7.1 | 45 | 129 | 3/4 X 1/4 FG-S | 3/4X1/4FGMSS | 280 | 280 |
| 3/4-14 | 1/2-14 | 35.0 | 13.5 | 49 | 129 | 3/4 X 1/2FG-S | 3/4X1/2FGMSS | 280 | 280 |
| 1-11.5 | 1-11.5 | 41.3 | 23.8 | 60 | 160 | 1 FG-S | 1FGMSS | 210 | 210 |
| 1-11.5 | 1/2-14 | 41.3 | 13.5 | 56 | 180 | 1 X 1/2FG-S | 1X1/2FGMSS | 210 | 210 |
| 1-11.5 | 3/4-14 | 41.3 | 18.3 | 55 | 98 | 1 X 3/4FG-S | 1X3/4FGMSS | 210 | 210 |
| 1 1/4-11.5 | 1-11.5 | 50.8 | 23.8 | 63 | 296 | 1 1/4 X 1FG-S | 11/4X1FGMSS | 170 | 170 |

Order codes shown are part of our current manufacturing programme.

Imperial and metric parts may vary in hexagon dimensions.

$$\frac{\text{PN (bar)}}{10} = \text{PN (MPa)}$$

Do not create drawings from these dimensions, they are subject to change and ISO manufacturing allowances.

CDM Male female thread elbow

Male NPTF* thread (SAE J476) / Female NPTF* thread (SAE J476)

SAE 140239

*Stainless Steel = NPT to prevent galling

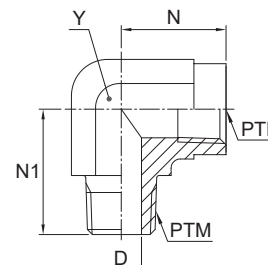

| Thread NPT/NPTF PTM | Thread NPT/NPTF PTF | D mm | N mm | N1 mm | Y mm | Weight (steel) g/1 piece | Adapter Steel | Adapter Stainless Steel | PN (bar) | |
|---------------------------|---------------------------|---------|---------|----------|---------|--------------------------------|------------------|----------------------------|----------|-----|
| | | | | | | | | | S | SS |
| 1/8-27 | 1/8-27 | 4.8 | 20 | 17 | 14.0 | 30 | 1/8 CD-S | 1/8 CD-SS | 350 | 350 |
| 1/4-18 | 1/4-18 | 7.0 | 28 | 22 | 19.0 | 77 | 1/4 CDMS | 1/4 CD-SS | 350 | 350 |
| 1/4-18 | 1/8-27 | 7.1 | 28 | 17 | 14.0 | 33 | 1/4 X 1/8 CD-S | 1/4 X 1/8 CD-SS | 350 | 350 |
| 3/8-18 | 3/8-18 | 10.0 | 31 | 26 | 22.0 | 96 | 3/8 CDMS | 3/8 CD-SS | 310 | 310 |
| 3/8-18 | 1/4-18 | 10.3 | 31 | 22 | 19.0 | 79 | 3/8 X 1/4 CD-S | 3/8 X 1/4 CD-SS | 350 | 350 |
| 3/8-18 | 1/2-14 | 10.3 | 33 | 31 | 27.0 | 260 | 3/8 X 1/2 CD-S | 3/8 X 1/2 CD-SS | 210 | 210 |
| 1/2-14 | 1/2-14 | 13.5 | 37 | 31 | 27.0 | 174 | 1/2 CD-S | 1/2 CD-SS | 210 | 210 |
| 1/2-14 | 3/8-18 | 13.5 | 38 | 32 | 22.0 | 96 | 1/2 X 3/8 CD-S | 1/2 X 3/8 CD-SS | 310 | 310 |
| 1/2-14 | 3/4-14 | 13.5 | 40 | 35 | 33.3 | 319 | 1/2 X 3/4 CD-S | 1/2 X 3/4 CD-SS | 210 | 210 |
| 3/4-14 | 3/4-14 | 18.3 | 40 | 35 | 33.3 | 285 | 3/4 CD-S | 3/4 CD-SS | 210 | 210 |
| 3/4-14 | 1/2-14 | 18.3 | 40 | 31 | 27.0 | 164 | 3/4 X 1/2 CD-S | 3/4 X 1/2 CD-SS | 210 | 210 |
| 1-11.5 | 1-11.5 | 23.8 | 50 | 41 | 47.6 | 515 | 1 CD-S | 1 CD-SS | 125 | 120 |
| 1 1/4-11.5 | 1 1/4-11.5 | 31.8 | 61 | 43 | 47.6 | 978 | 1 1/4 CD-S | 1 1/4 CD-SS | 100 | 100 |
| 1 1/2-11.5 | 1 1/2-11.5 | 38.1 | 67 | 53 | 63.5 | 1679 | 1 1/2 CD-S | 1 1/2 CD-SS | 100 | 100 |

Order codes shown are part of our current manufacturing programme.

Imperial and metric parts may vary in hexagon dimensions.

PN (bar) = PN (MPa)
10

Do not create drawings from these dimensions, they are subject to change and ISO manufacturing allowances.



Adapters

CD45 Male female thread 45° elbow

Male NPTF* thread (SAE J476) / Female NPTF* thread (SAE J476)

SAE 140339

*Stainless Steel = NPT to prevent galling

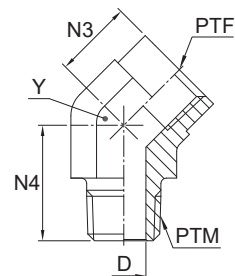

| Thread NPT/NPTF PTM | Thread NPT/NPTF PTF | D mm | N3 mm | N4 mm | Y mm | Weight (steel) g/1 piece | Adapter Steel | Adapter Stainless Steel | PN (bar) | |
|---------------------------|---------------------------|---------|----------|----------|---------|--------------------------------|------------------|----------------------------|----------|-----|
| | | | | | | | | | S | SS |
| 1/8-27 | 1/8-27 | 4.8 | 12 | 18 | 14.0 | 24 | 1/8 CD45-S | 1/8 CD45-SS | 350 | 350 |
| 1/4-18 | 1/4-18 | 7.1 | 16 | 27 | 19.0 | 57 | 1/4 CD45-S | 1/4 CD45-SS | 350 | 350 |
| 3/8-18 | 3/8-18 | 10.3 | 18 | 27 | 22.0 | 79 | 3/8 CD45-S | 3/8 CD45-SS | 310 | 310 |
| 1/2-14 | 1/2-14 | 13.5 | 23 | 34 | 27.0 | 141 | 1/2 CD45-S | 1/2 CD45-SS | 210 | 210 |
| 3/4-14 | 3/4-14 | 18.3 | 25 | 35 | 33.3 | 196 | 3/4 CD45-S | 3/4 CD45-SS | 210 | 210 |
| 1-11.5 | 1-11.5 | 23.8 | 29 | 44 | 41.0 | 380 | 1 CD45-S | 1 CD45-SS | 125 | 120 |
| 1 1/4-11.5 | 1 1/4-11.5 | 31.8 | 41 | 46 | 47.6 | 719 | 1 1/4 CD45-S | 1 1/4 CD45-SS | 100 | 100 |

Order codes shown are part of our current manufacturing programme.

Imperial and metric parts may vary in hexagon dimensions.

$\frac{\text{PN (bar)}}{10} = \text{PN (MPa)}$

Do not create drawings from these dimensions, they are subject to change and ISO manufacturing allowances.

MRO Male female thread tee

Male NPTF* thread (SAE J476) / Female NPTF* thread (SAE J476)

SAE 140424

*Stainless Steel = NPT to prevent galling

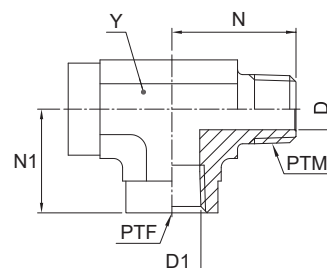

| Thread NPT/NPTF PTM | Thread NPT/NPTF PTF | D mm | D1 mm | N mm | N1 mm | Y mm | Weight (steel) g/1 piece | Adapter Steel | Adapter Stainless Steel | PN (bar) | |
|---------------------------|---------------------------|---------|----------|---------|----------|---------|--------------------------------|------------------|----------------------------|----------|-----|
| | | | | | | | | | | S | SS |
| 1/8-27 | 1/8-27 | 4.8 | 8.3 | 20 | 17 | 14.0 | 59 | 1/8 MRO-S | 1/8 MRO-SS | 350 | 350 |
| 1/4-18 | 1/4-18 | 7.1 | 10.7 | 28 | 22 | 19.0 | 115 | 1/4 MRO-S | 1/4 MRO-SS | 350 | 350 |
| 3/8-18 | 3/8-18 | 10.3 | 14.2 | 31 | 26 | 22.0 | 122 | 3/8 MRO-S | 3/8 MRO-SS | 310 | 310 |
| 1/2-14 | 1/2-14 | 13.5 | 17.5 | 37 | 31 | 27.0 | 285 | 1/2 MRO-S | 1/2 MRO-SS | 210 | 210 |
| 3/4-14 | 3/4-14 | 18.3 | 22.8 | 40 | 35 | 33.3 | 497 | 3/4 MRO-S | 3/4 MRO-SS | 210 | 210 |
| 1-11.5 | 1-11.5 | 23.8 | 28.6 | 50 | 41 | 41.0 | 987 | 1 MRO-S | 1 MRO-SS | 125 | 120 |

Order codes shown are part of our current manufacturing programme.

Imperial and metric parts may vary in hexagon dimensions.

$$\frac{\text{PN (bar)}}{10} = \text{PN (MPa)}$$

Do not create drawings from these dimensions, they are subject to change and ISO manufacturing allowances.



Adapters

MMS Male female thread tee

Male NPTF* thread (SAE J476) / Female NPTF* thread (SAE J476)

SAE 140425

*Stainless Steel = NPT to prevent galling

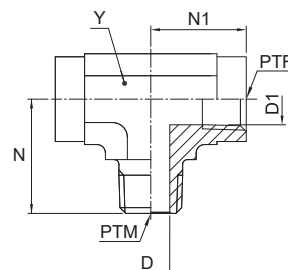

| Thread NPT/NPTF PTM | Thread NPT/NPTF PTF | D mm | D1 mm | N mm | N1 mm | Y mm | Weight (steel) g/1 piece | Adapter Steel | Adapter Stainless Steel | PN (bar) | |
|---------------------------|---------------------------|---------|----------|---------|----------|---------|--------------------------------|------------------|----------------------------|----------|-----|
| | | | | | | | | | | S | SS |
| 1/8-27 | 1/8-27 | 4.8 | 8.3 | 20 | 17 | 14.0 | 45 | 1/8 MMS-S | 1/8 MMS-SS | 350 | 350 |
| 1/4-18 | 1/4-18 | 7.1 | 10.7 | 28 | 22 | 19.0 | 118 | 1/4 MMS-S | 1/4 MMS-SS | 350 | 350 |
| 3/8-18 | 3/8-18 | 10.3 | 14.2 | 31 | 26 | 22.0 | 126 | 3/8 MMS-S | 3/8 MMS-SS | 310 | 310 |
| 1/2-14 | 1/2-14 | 13.5 | 17.5 | 37 | 31 | 27.0 | 272 | 1/2 MMS-S | 1/2 MMS-SS | 210 | 210 |
| 3/4-14 | 3/4-14 | 18.3 | 22.8 | 40 | 35 | 33.3 | 408 | 3/4 MMS-S | 3/4 MMS-SS | 210 | 210 |
| 1-11.5 | 1-11.5 | 23.8 | 28.6 | 50 | 41 | 41.0 | 606 | 1 MMS-S | 1 MMS-SS | 125 | 120 |

Order codes shown are part of our current manufacturing programme.

Imperial and metric parts may vary in hexagon dimensions.

$\frac{PN \text{ (bar)}}{10} = PN \text{ (MPa)}$

Do not create drawings from these dimensions, they are subject to change and ISO manufacturing allowances.

GG Female thread coupling

Female NPTF* thread (SAE J476) / Female NPTF* thread (SAE J476)

SAE 140138

*Stainless Steel = NPT to prevent galling

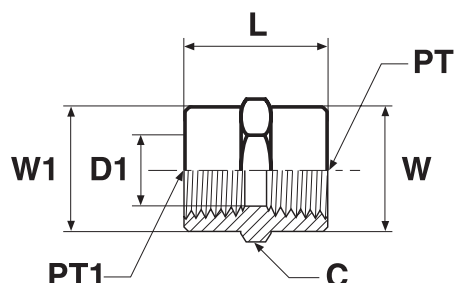

| Thread NPT/NPTF PT | Thread NPT/NPTF PT1 | C mm | D1 mm | L mm | W mm | W1 mm | Weight (steel) g/1 piece | Adapter Steel | Adapter Stainless Steel | PN (bar) | |
|--------------------------|---------------------------|---------|----------|---------|---------|----------|--------------------------------|--------------------|----------------------------|----------|-----|
| | | | | | | | | | | S | SS |
| 1/8-27 | 1/8-27 | 16.0 | 8.3 | 19 | 16 | 16 | 19 | 1/8 GG-S | 1/8 GG-SS | 420 | 420 |
| 1/4-18 | 1/8-27 | 19.0 | 8.3 | 24 | 19 | 16 | 35 | 1/4 X 1/8 GG-S | 1/4 X 1/8 GG-SS | 420 | 420 |
| 1/4-18 | 1/4-18 | 19.0 | 10.7 | 29 | 19 | 19 | 45 | 1/4 GG-S | 1/4 GG-SS | 420 | 420 |
| 3/8-18 | 1/8-27 | 22.2 | 8.3 | 26 | 22 | 16 | 56 | 3/8 X 1/8 GG-S | 3/8 X 1/8 GG-SS | 420 | 420 |
| 3/8-18 | 1/4-18 | 22.2 | 10.7 | 29 | 22 | 19 | 56 | 3/8 X 1/4 GG-S | 3/8 X 1/4 GG-SS | 420 | 420 |
| 3/8-18 | 3/8-18 | 22.2 | 14.2 | 29 | 22 | 22 | 62 | 3/8 GG-S | 3/8 GG-SS | 420 | 420 |
| 1/2-14 | 1/4-18 | 28.6 | 10.7 | 35 | 29 | 19 | 117 | 1/2 X 1/4 GG-S | 1/2 X 1/4 GG-SS | 350 | 350 |
| 1/2-14 | 3/8-18 | 28.6 | 14.2 | 38 | 29 | 22 | 100 | 1/2 X 3/8 GG-S | 1/2 X 3/8 GG-SS | 350 | 350 |
| 1/2-14 | 1/2-14 | 28.6 | 17.5 | 38 | 29 | 29 | 112 | 1/2 GG-S | 1/2 GG-SS | 350 | 350 |
| 3/4-14 | 1/4-18 | 35.0 | 10.7 | 39 | 35 | 19 | 150 | 3/4 X 1/4 GG-S | 3/4 X 1/4 GG-SS | 280 | 280 |
| 3/4-14 | 1/2-14 | 35.0 | 17.5 | 48 | 35 | 29 | 134 | 3/4 X 1/2 GG-S | 3/4 X 1/2 GG-SS | 280 | 280 |
| 3/4-14 | 3/4-14 | 35.0 | 22.8 | 39 | 35 | 35 | 156 | 3/4 GG-S | 3/4 GG-SS | 280 | 280 |
| 1-11.5 | 1-11.5 | 41.3 | 28.6 | 48 | 41 | 41 | 289 | 1 GG-S | 1 GG-SS | 210 | 210 |
| 1-11.5 | 1/2-14 | 41.3 | 17.5 | 45 | 41 | 29 | 235 | 1 X 1/2 GG-S | 1 X 1/2 GG-SS | 210 | 210 |
| 1-11.5 | 3/4-14 | 41.3 | 22.8 | 45 | 41 | 35 | 239 | 1 X 3/4 GG-S | 1 X 3/4 GG-SS | 210 | 210 |
| 1 1/4-11.5 | 1 1/4-11.5 | 50.8 | 37.4 | 49 | 51 | 51 | 340 | 1 1/4 GG-S | 1 1/4 GG-SS | 170 | 170 |
| 1 1/4-11.5 | 1-11.5 | 50.8 | 28.6 | 49 | 51 | 41 | 182 | 1 1/4 X 1 GG-S | 1 1/4 X 1 GG-SS | 170 | 170 |
| 1 1/2-11.5 | 1 1/2-11.5 | 60.3 | 43.4 | 49 | 60 | 60 | 706 | 1 1/2 GG-S | 1 1/2 GG-SS | 140 | 140 |
| 1 1/2-11.5 | 1 1/4-11.5 | 60.3 | 37.4 | 49 | 60 | 60 | 531 | 1 1/2 X 1 1/4 GG-S | 1 1/2 X 1 1/4 GG-SS | 140 | 140 |
| 2-11.5 | 2-11.5 | 73.0 | 55.5 | 50 | 73 | 73 | 814 | 2 GG-S | 2 GG-SS | 140 | 140 |

Order codes shown are part of our current manufacturing programme.

Imperial and metric parts may vary in hexagon dimensions.

$\frac{PN \text{ (bar)}}{10} = PN \text{ (MPa)}$

Do not create drawings from these dimensions, they are subject to change and ISO manufacturing allowances.



Adapters

DD Female thread elbow

Female NPTF* thread (SAE J476)

SAE 140238

*Stainless Steel = NPT to prevent galling

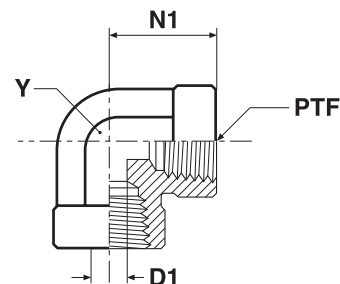

| Thread NPT/NPTF PTF | D1 mm | N1 mm | Y mm | Weight (steel) g/1 piece | Adapter Steel | Adapter Stainless Steel | PN (bar) | |
|---------------------------|----------|----------|---------|--------------------------------|------------------|----------------------------|----------|-----|
| | | | | | | | S | SS |
| 1/8-27 | 8.3 | 17 | 14.0 | 28 | 1/8 DD-S | 1/8 DD-SS | 350 | 350 |
| 1/4-18 | 10.7 | 22 | 19.0 | 72 | 1/4 DD-S | 1/4 DD-SS | 350 | 350 |
| 3/8-18 | 14.2 | 26 | 22.0 | 96 | 3/8 DD-S | 3/8 DD-SS | 310 | 310 |
| 1/2-14 | 17.5 | 31 | 27.0 | 159 | 1/2 DD-S | 1/2 DD-SS | 210 | 210 |
| 3/4-14 | 22.8 | 35 | 33.3 | 263 | 3/4 DD-S | 3/4 DD-SS | 210 | 210 |
| 1-11.5 | 28.6 | 41 | 41.0 | 488 | 1 DD-S | 1 DD-SS | 125 | 120 |
| 1 1/4-11.5 | 37.4 | 43 | 47.6 | 978 | 1 1/4 DD-S | 1 1/4 DD-SS | 100 | 100 |
| 1 1/2-11.5 | 43.4 | 53 | 63.5 | 1889 | 1 1/2 DD-S | 1 1/2 DD-SS | 100 | 100 |

Do not create drawings from these dimensions, they are subject to change and ISO manufacturing allowances.

DD45 Female thread 45° elbow

Female NPTF* thread (SAE J476)

SAE 140338

*Stainless Steel = NPT to prevent galling

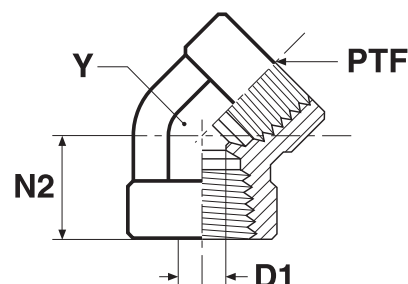

| Thread NPT/NPTF PTF | D1 mm | N2 mm | Y mm | Weight (steel) g/1 piece | Adapter Steel | Adapter Stainless Steel | PN (bar) | |
|---------------------------|----------|----------|---------|--------------------------------|------------------|----------------------------|----------|-----|
| | | | | | | | S | SS |
| 1/8-27 | 8.3 | 12 | 14.0 | 27 | 1/8 DD45-S | 1/8 DD45-SS | 350 | 350 |
| 1/4-18 | 10.7 | 18 | 19.0 | 69 | 1/4 DD45-S | 1/4 DD45-SS | 350 | 350 |
| 3/8-18 | 14.2 | 19 | 22.0 | 97 | 3/8 DD45-S | 3/8 DD45-SS | 310 | 310 |
| 1/2-14 | 17.5 | 24 | 27.0 | 172 | 1/2 DD45-S | 1/2 DD45-SS | 210 | 210 |
| 3/4-14 | 22.8 | 25 | 33.3 | 248 | 3/4 DD45-S | 3/4 DD45-SS | 210 | 210 |
| 1-11.5 | 28.6 | 30 | 41.0 | 479 | 1 DD45-S | 1 DD45-SS | 125 | 120 |

Order codes shown are part of our current manufacturing programme.

Imperial and metric parts may vary in hexagon dimensions.

$$\frac{\text{PN (bar)}}{10} = \text{PN (MPa)}$$

Do not create drawings from these dimensions, they are subject to change and ISO manufacturing allowances.

MMO Female thread tee

Female NPTF* threads (SAE J476)

SAE 140438

*Stainless Steel = NPT to prevent galling

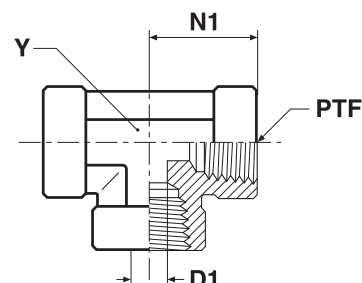

| Thread NPT/NPTF PTF | D1 mm | N1 mm | Y mm | Weight (steel) g/1 piece | Adapter Steel | Adapter Stainless Steel | PN (bar) | |
|---------------------------|----------|----------|---------|--------------------------------|------------------|----------------------------|----------|-----|
| | | | | | | | S | SS |
| 1/8-27 | 8.3 | 17 | 14.0 | 36 | 1/8 MMO-S | 1/8 MMO-SS | 350 | 350 |
| 1/4-18 | 10.7 | 22 | 19.0 | 94 | 1/4 MMO-S | 1/4 MMO-SS | 350 | 350 |
| 3/8-18 | 14.2 | 26 | 22.0 | 121 | 3/8 MMO-S | 3/8 MMO-SS | 210 | 210 |
| 1/2-14 | 17.5 | 31 | 27.0 | 202 | 1/2 MMO-S | 1/2 MMO-SS | 210 | 210 |
| 3/4-14 | 22.8 | 35 | 33.3 | 312 | 3/4 MMO-S | 3/4 MMO-SS | 210 | 210 |
| 1-11.5 | 28.6 | 41 | 41.0 | 606 | 1 MMO-S | 1 MMO-SS | 125 | 120 |
| 1 1/4-11.5 | 37.4 | 43 | 47.6 | 576 | 1 1/4 MMO-S | 1 1/4 MMO-SS | 100 | 100 |
| 1 1/2-11.5 | 43.4 | 53 | 63.5 | 576 | 1 1/2 MMO-S | 1 1/2 MMO-SS | 100 | 100 |

Do not create drawings from these dimensions, they are subject to change and ISO manufacturing allowances.

KMMOO Female thread cross

Female NPTF* threads (SAE J476)

SAE 140538

*Stainless Steel = NPT to prevent galling

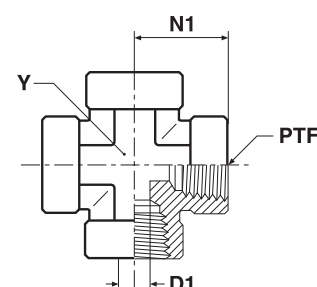

| Thread NPT/NPTF PTF | D1 mm | N1 mm | Y mm | Weight (steel) g/1 piece | Adapter Steel | Adapter Stainless Steel | PN (bar) | |
|---------------------------|----------|----------|---------|--------------------------------|------------------|----------------------------|----------|-----|
| | | | | | | | S | SS |
| 1/8-27 | 8.3 | 17 | 14.0 | 45 | 1/8 KMMOO-S | 1/8 KMMOO-SS | 350 | 350 |
| 1/4-18 | 10.7 | 22 | 19.0 | 113 | 1/4 KMMOO-S | 1/4 KMMOO-SS | 350 | 350 |
| 3/8-18 | 14.2 | 26 | 22.0 | 147 | 3/8 KMMOO-S | 3/8 KMMOO-SS | 210 | 210 |
| 1/2-14 | 17.5 | 31 | 27.0 | 257 | 1/2 KMMOO-S | 1/2 KMMOO-SS | 210 | 210 |
| 3/4-14 | 22.8 | 35 | 33.3 | 382 | 3/4 KMMOO-S | 3/4 KMMOO-SS | 210 | 210 |
| 1-11.5 | 28.6 | 41 | 41.0 | 690 | 1 KMMOO-S | 1 KMMOO-SS | 125 | 120 |

Order codes shown are part of our current manufacturing programme.

Imperial and metric parts may vary in hexagon dimensions.

$$\frac{PN \text{ (bar)}}{10} = PN \text{ (MPa)}$$

Do not create drawings from these dimensions, they are subject to change and ISO manufacturing allowances.

Adapters

HP Hexagon head plug

Male NPTF* Thread (SAE J476)

SAE 130109E

*Stainless Steel = NPT to prevent galling

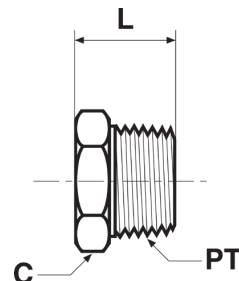

| Thread NPT/NPTF PT | C mm | L mm | Weight (steel) g/1 piece | Adapter Steel | Adapter Stainless Steel | PN (bar) | |
|--------------------------|---------|---------|--------------------------------|------------------|----------------------------|----------|-----|
| | | | | | | S | SS |
| 1/8-27 | 11.0 | 14 | 19 | 1/8 HP-S | 1/8HPMSS | 420 | 420 |
| 1/4-18 | 14.3 | 19 | 22 | 1/4 HP-S | 1/4HPMSS | 420 | 420 |
| 3/8-18 | 17.5 | 20 | 28 | 3/8 HP-S | 3/8HPMSS | 420 | 420 |
| 1/2-14 | 22.2 | 24 | 72 | 1/2 HP-S | 1/2HPMSS | 420 | 420 |
| 3/4-14 | 27.0 | 27 | 119 | 3/4 HP-S | 3/4HPMSS | 380 | 380 |
| 1-11.5 | 33.3 | 32 | 218 | 1 HP-S | 1HPMSS | 380 | 380 |
| 1 1/4-11.5 | 44.5 | 36 | 217 | 1 1/4 HP-S | 11/4HPMSS | 345 | 345 |
| 1 1/2-11.5 | 50.8 | 38 | 300 | 1 1/2 HP-S | 11/2HPMSS | 210 | 210 |

Do not create drawings from these dimensions, they are subject to change and ISO manufacturing allowances.

HHP Hexagon socket plug

Male NPTF* thread (SAE J476)

SAE 130109N

*Stainless Steel = NPT to prevent galling

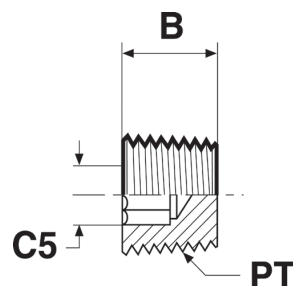

| Thread NPT/NPTF PT | B mm | C5 inch | Weight (steel) g/1 piece | Adapter Steel | Adapter Stainless Steel | PN (bar) | |
|--------------------------|---------|------------|--------------------------------|------------------|----------------------------|----------|-----|
| | | | | | | S | SS |
| 1/16-27 | 8 | 5/32 | 2 | 1/16 HHP-S | 1/16 HHP-SS | 420 | 420 |
| 1/8-27 | 8 | 3/16 | 3 | 1/8 HHP-S | 1/8 HHP-SS | 420 | 420 |
| 1/4-18 | 12 | 1/4 | 7 | 1/4 HHP-S | 1/4 HHP-SS | 420 | 420 |
| 3/8-18 | 12 | 5/16 | 13 | 3/8 HHP-S | 3/8 HHP-SS | 420 | 420 |
| 1/2-14 | 16 | 3/8 | 16 | 1/2 HHP-S | 1/2 HHP-SS | 420 | 420 |
| 3/4-14 | 16 | 9/16 | 66 | 3/4 HHP-S | 3/4 HHP-SS | 380 | 380 |
| 1-11.5 | 20 | 5/8 | 73 | 1 HHP-S | 1 HHP-SS | 380 | 380 |
| 1 1/4-11.5 | 21 | 3/4 | 127 | 1 1/4 HHP-S | 1 1/4 HHP-SS | 210 | 345 |
| 1 1/2-11.5 | 21 | 3/4 | 168 | 1 1/2 HHP-S | 1 1/2 HHP-SS | 210 | 210 |
| 2-11.5 | 22 | 3/4 | 264 | 2 HHP-S | 2 HHP-SS | 140 | 170 |

Order codes shown are part of our current manufacturing programme.
Imperial and metric parts may vary in hexagon dimensions.

$$\frac{PN \text{ (bar)}}{10} = PN \text{ (MPa)}$$

Do not create drawings from these dimensions, they are subject to change and ISO manufacturing allowances.

F50G Male female thread adapter

Male UN/UNF thread – O-ring (ISO 11926) / Female NPTF* thread (SAE 476)

*Stainless Steel = NPT to prevent galling

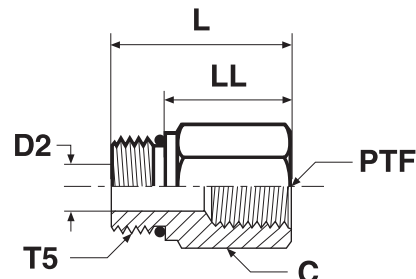

| Thread UN/UNF-2A T5 | Thread NPT/NPTF PTF | C mm | D2 mm | L mm | LL mm | Weight (steel) g/1 piece | Adapter Steel | Adapter Stainless Steel | PN (bar) | |
|---------------------------|---------------------------|---------|----------|---------|----------|--------------------------------|------------------|----------------------------|----------|-----|
| | | | | | | | | | S | SS |
| 7/16-20 | 1/8-27 | 14.3 | 4.4 | 25 | 16 | 18 | 4-1/8 F50G-S | 4-1/8 F50G-SS | 420 | 420 |
| 7/16-20 | 1/4-18 | 19.0 | 4.4 | 30 | 20 | 36 | 4-1/4 F50G-S | 4-1/4 F50G-SS | 420 | 420 |
| 1/2-20 | 1/8-27 | 16.0 | 6.0 | 27 | 18 | 45 | 5-1/8 F50G-S | 5-1/8 F50G-SS | 420 | 420 |
| 1/2-20 | 1/4-18 | 19.0 | 6.0 | 30 | 21 | 55 | 5-1/4 F50G-S | 5-1/4 F50G-SS | 420 | 420 |
| 9/16-18 | 1/4-18 | 19.0 | 7.5 | 30 | 20 | 36 | 6-1/4 F50G-S | 6-1/4 F50G-SS | 420 | 420 |
| 3/4-16 | 1/4-18 | 22.2 | 9.9 | 29 | 18 | 53 | 8-1/4 F50G-S | 8-1/4 F50G-SS | 420 | 420 |
| 3/4-16 | 3/8-18 | 22.2 | 9.9 | 33 | 21 | 67 | 8-3/8 F50G-S | 8-3/8 F50G-SS | 420 | 420 |
| 3/4-16 | 1/2-14 | 28.6 | 9.9 | 38 | 27 | 98 | 8-1/2 F50G-S | 8-1/2 F50G-SS | 350 | 350 |
| 7/8-14 | 1/4-18 | 25.4 | 12.7 | 21 | 8 | 78 | 10-1/4 F50G-S | 10-1/4 F50G-SS | 380 | 380 |
| 7/8-14 | 3/8-18 | 25.4 | 12.7 | 33 | 21 | 77 | 10-3/8 F50G-S | 10-3/8 F50G-SS | 380 | 380 |
| 7/8-14 | 1/2-14 | 28.6 | 12.7 | 39 | 26 | 98 | 10-1/2 F50G-S | 10-1/2 F50G-SS | 350 | 350 |
| 7/8-14 | 3/4-14 | 35.0 | 12.7 | 41 | 29 | 153 | 10-3/4 F50G-S | 10-3/4 F50G-SS | 280 | 280 |
| 1 1/16-12 | 1/2-14 | 31.8 | 15.5 | 36 | 21 | 114 | 12-1/2 F50G-S | 12-1/2 F50G-SS | 350 | 350 |
| 1 1/16-12 | 3/4-14 | 35.0 | 15.5 | 44 | 29 | 150 | 12-3/4 F50G-S | 12-3/4 F50G-SS | 280 | 280 |
| 1 3/16-12 | 1/2-14 | 35.0 | 18.3 | 27 | 12 | 159 | 14-1/2 F50G-S | 14-1/2 F50G-SS | 280 | 280 |
| 1 3/16-12 | 3/4-14 | 35.0 | 18.3 | 43 | 28 | 167 | 14-3/4 F50G-S | 14-3/4 F50G-SS | 280 | 280 |
| 1 5/16-12 | 1/2-14 | 38.0 | 21.4 | 25 | 10 | 137 | 16-1/2 F50G-S | 16-1/2 F50G-SS | 280 | 280 |
| 1 5/16-12 | 3/4-14 | 38.0 | 21.4 | 38 | 23 | 189 | 16-3/4 F50G-S | 16-3/4 F50G-SS | 280 | 280 |
| 1 5/16-12 | 1-11.5 | 41.3 | 22.2 | 48 | 33 | 216 | 16-1 F50G-S | 16-1 F50G-SS | 210 | 210 |
| 1 5/8-12 | 1-11.5 | 47.6 | 27.5 | 25 | 10 | 151 | 20-1 F50G-S | 20-1 F50G-SS | 210 | 210 |
| 1 5/8-12 | 1 1/4-11.5 | 50.8 | 27.5 | 50 | 35 | 191 | 20-1 1/4 F50G-S | 20-1 1/4 F50G-SS | 170 | 170 |
| 1 7/8-12 | 1-11.5 | 54.0 | 34.1 | 25 | 10 | 612 | 24-1 F50G-S | 24-1 F50G-SS | 170 | 170 |
| 1 7/8-12 | 1 1/2-11.5 | 57.4 | 34.1 | 51 | 36 | 653 | 24-1 1/2 F50G-S | 24-1 1/2 F50G-SS | 140 | 140 |

Parker Adapter are delivered with NBR elastomeric seals as standard. For more details on other seal materials see page O60.

Order codes shown are part of our current manufacturing programme.

Imperial and metric parts may vary in hexagon dimensions.

$$\frac{\text{PN (bar)}}{10} = \text{PN (MPa)}$$

Do not create drawings from these dimensions, they are subject to change and ISO manufacturing allowances.

Adapters

AOEG Elbow

Male UN/UNF thread O-ring (ISO 11926) / Female NPTF thread (SAE 476)

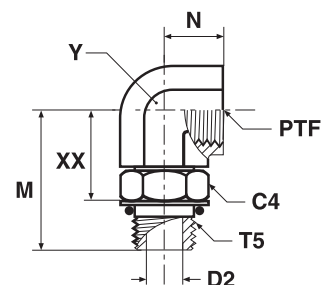

| Thread UN/UNF-2A T5 | Thread NPTF/NPTF PTF | C4 mm | D2 mm | M mm | N mm | XX mm | Y mm | Weight (steel) g/1 piece | Adapter Steel | PN (bar) |
|---------------------------|----------------------------|----------|----------|---------|---------|----------|---------|--------------------------------|------------------|-------------|
| 9/16-18 | 1/4-18 | 18 | 7.5 | 34 | 16 | 21 | 19 | 86 | 6-1/4 AOE4G-S | 350 |
| 3/4-16 | 3/8-18 | 22 | 9.9 | 37 | 16 | 24 | 22 | 100 | 8-3/8 AOE4G-S | 310 |
| 7/8-14 | 1/2-14 | 25 | 12.3 | 46 | 19 | 31 | 27 | 172 | 10-1/2 AOE4G-S | 210 |
| 1 1/16-12 | 3/4-14 | 32 | 15.5 | 51 | 21 | 34 | 33 | 274 | 12-3/4 AOE4G-S | 210 |
| 1 5/16-12 | 1-11.5 | 38 | 21.4 | 57 | 25 | 40 | 41 | 471 | 16-1 AOE4G-S | 125 |

Do not create drawings from these dimensions, they are subject to change and ISO manufacturing allowances.

AOE4G Extra long elbow

Male UN/UNF thread O-ring (ISO 11926) / Female NPTF thread (SAE 476)

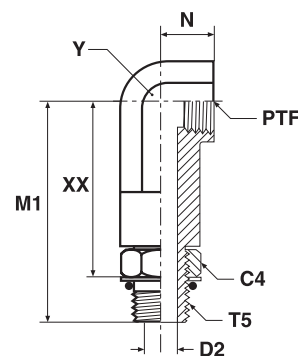

| Thread UN/UNF-2A T5 | Thread NPTF/NPTF PTF | C4 mm | D2 mm | M1 mm | N mm | XX mm | Y mm | Weight (steel) g/1 piece | Adapter Steel | PN (bar) |
|---------------------------|----------------------------|----------|----------|----------|---------|----------|---------|--------------------------------|------------------|-------------|
| 3/4-16 | 3/8-18 | 22 | 9.9 | 75 | 16 | 62 | 22.0 | 176 | 8-3/8 AOE4G-S | 310 |
| 7/8-14 | 1/2-14 | 25 | 12.3 | 90 | 19 | 76 | 27.0 | 246 | 10-1/2 AOE4G-S | 210 |
| 1 1/16-12 | 3/4-14 | 32 | 15.5 | 103 | 21 | 86 | 33.3 | 356 | 12-3/4 AOE4G-S | 210 |
| 1 5/16-12 | 1-11.5 | 38 | 21.4 | 118 | 25 | 101 | 41.0 | 956 | 16-1 AOE4G-S | 125 |

Parker Adapter are delivered with NBR elastomeric seals as standard. For more details on other seal materials see page O60.

Order codes shown are part of our current manufacturing programme.

Imperial and metric parts may vary in hexagon dimensions.

$\frac{PN \text{ (bar)}}{10} = PN \text{ (MPa)}$

Do not create drawings from these dimensions, they are subject to change and ISO manufacturing allowances.

F5OG5 Thread reducer / Expander

Male UN/UNF threads – O-ring (ISO 11926)
SAE 090136

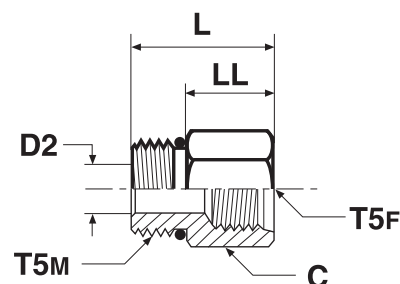

| Thread UN/UNF-2A T5M | Thread UN/UNF-2B T5F | C mm | D2 mm | L mm | LL mm | Weight (steel) g/1 piece | Adapter Steel | Adapter Stainless Steel | PN (bar) | |
|----------------------------|----------------------------|---------|----------|---------|----------|--------------------------------|------------------|----------------------------|----------|-----|
| | | | | | | | | | S | SS |
| 7/16-20 | 7/16-20 | 17.5 | 4.4 | 27 | 18 | 42 | 4-4 F5OG5-S | 4-4 F5OG5-SS | 500 | 315 |
| 7/16-20 | 9/16-18 | 20.6 | 4.4 | 30 | 20 | 49 | 4-6 F5OG5-S | 4-6 F5OG5-SS | 420 | 315 |
| 9/16-18 | 7/16-20 | 17.5 | 7.5 | 26 | 16 | 30 | 6-4 F5OG5-S | 6-4 F5OG5-SS | 500 | 315 |
| 9/16-18 | 3/4-16 | 27.0 | 7.5 | 35 | 25 | 64 | 6-8 F5OG5-S | 6-8 F5OG5-SS | 420 | 280 |
| 3/4-16 | 9/16-18 | 22.2 | 9.9 | 29 | 18 | 93 | 8-6 F5OG5-S | 8-6 F5OG5-SS | 420 | 315 |
| 3/4-16 | 7/8-14 | 28.6 | 9.9 | 40 | 29 | 73 | 8-10 F5OG5-S | 8-10 F5OG5-SS | 310 | 210 |
| 7/8-14 | 9/16-18 | 25.4 | 12.3 | 32 | 19 | 73 | 10-6 F5OG5-S | 10-6 F5OG5-SS | 420 | 350 |
| 7/8-14 | 3/4-16 | 25.4 | 12.3 | 33 | 21 | 75 | 10-8 F5OG5-S | 10-8 F5OG5-SS | 310 | 280 |
| 7/8-14 | 1 1/16-12 | 35.0 | 12.3 | 43 | 30 | 209 | 10-12 F5OG5-S | 10-12 F5OG5-SS | 310 | 245 |
| 1 1/16-12 | 3/4-16 | 31.8 | 15.5 | 37 | 22 | 114 | 12-8 F5OG5-S | 12-8 F5OG5-SS | 420 | 315 |
| 1 1/16-12 | 7/8-14 | 31.8 | 15.5 | 39 | 24 | 150 | 12-10 F5OG5-S | 12-10 F5OG5-SS | 350 | 210 |
| 1 1/16-12 | 1 5/16-12 | 41.3 | 15.5 | 48 | 33 | 170 | 12-16 F5OG5-S | 12-16 F5OG5-SS | 240 | 140 |
| 1 5/16-12 | 3/4-16 | 38.0 | 17.5 | 25 | 10 | 159 | 16-8 F5OG5-S | 16-8 F5OG5-SS | 310 | 310 |
| 1 5/16-12 | 7/8-14 | 38.0 | 20.6 | 25 | 10 | 240 | 16-10 F5OG5-S | 16-10 F5OG5-SS | 310 | 245 |
| 1 5/16-12 | 1 1/16-12 | 38.0 | 21.4 | 45 | 29 | 259 | 16-12 F5OG5-S | 16-12 F5OG5-SS | 310 | 245 |
| 1 5/16-12 | 1 5/8-12 | 54.0 | 21.4 | 50 | 35 | 280 | 16-20 F5OG5-S | 16-20 F5OG5-SS | 210 | 175 |
| 1 5/8-12 | 1 1/16-12 | 47.6 | 27.4 | 25 | 10 | 249 | 20-12 F5OG5-S | 20-12 F5OG5-SS | 280 | 210 |
| 1 5/8-12 | 1 5/16-12 | 47.6 | 27.4 | 44 | 29 | 249 | 20-16 F5OG5-S | 20-16 F5OG5-SS | 280 | 140 |
| 1 7/8-12 | 1 1/16-12 | 54.0 | 24.7 | 25 | 10 | 263 | 24-12 F5OG5-S | 24-12 F5OG5-SS | 210 | 140 |
| 1 7/8-12 | 1 5/16-12 | 54.0 | 30.9 | 25 | 10 | 268 | 24-16 F5OG5-S | 24-16 F5OG5-SS | 210 | 140 |
| 1 7/8-12 | 1 5/8-12 | 54.0 | 33.3 | 45 | 29 | 272 | 24-20 F5OG5-S | 24-20 F5OG5-SS | 210 | 140 |

Parker Adapter are delivered with NBR elastomeric seals as standard. For more details on other seal materials see page O60.

Order codes shown are part of our current manufacturing programme.

Imperial and metric parts may vary in hexagon dimensions.

$$\frac{\text{PN (bar)}}{10} = \text{PN (MPa)}$$

Do not create drawings from these dimensions, they are subject to change and ISO manufacturing allowances.

Adapters

F5OHAO Straight thread union

Male UN/UNF threads – O-ring (ISO 11926)

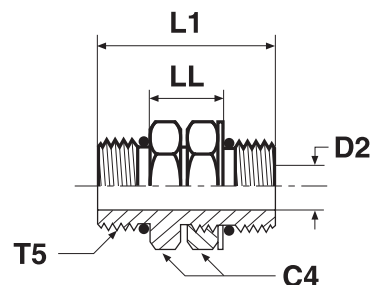

| Thread UN/UNF-2A T5 | C4 mm | D2 mm | L1 mm | LL mm | Weight (steel) g/1 piece | Adapter Steel | Adapter Stainless Steel | PN (bar) | |
|---------------------------|----------|----------|----------|----------|--------------------------------|--------------------|----------------------------|----------|-----|
| | | | | | | | | S | SS |
| 7/16-20 | 14.3 | 5.2 | 32 | 13 | 25 | 4 F5OHAO-S | 4 F5OHAO-SS | 350 | 350 |
| 9/16-18 | 17.5 | 7.5 | 36 | 14 | 52 | 6 F5OHAO-S | 6 F5OHAO-SS | 350 | 350 |
| 3/4-16 | 22.2 | 10.7 | 42 | 18 | 76 | 8 F5OHAO-S | 8 F5OHAO-SS | 350 | 350 |
| 7/8-14 | 25.4 | 12.3 | 46 | 19 | 118 | 10 F5OHAO-S | 10 F5OHAO-SS | 310 | 310 |
| 1 1/16-12 | 31.8 | 15.5 | 54 | 22 | 213 | 12 F5OHAO-S | 12 F5OHAO-SS | 280 | 280 |
| 1 5/16-12 | 38.0 | 21.5 | 62 | 30 | 235 | 16 F5OHAO-S | 16 F5OHAO-SS | 210 | 210 |
| 1 5/8-12 | 47.6 | 27.4 | 62 | 30 | 367 | 20 F5OHAO-S | 20 F5OHAO-SS | 170 | 170 |
| 1 7/8-12 | 54.0 | 34.1 | 62 | 30 | 538 | 24 F5OHAO-S | 24 F5OHAO-SS | 140 | 140 |

Do not create drawings from these dimensions, they are subject to change and ISO manufacturing allowances.

G5G5JG5 Female straight thread tee

Female UN/UNF threads – all 3 ends

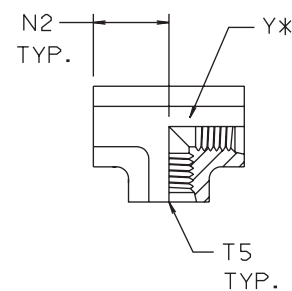

| Thread UN/UNF-2B T5 | N2 mm | Y mm | Weight (steel) g/1 piece | Adapter Steel | PN (bar) |
|---------------------------|----------|---------|--------------------------------|---------------------|-------------|
| 7/16-20 | 19 | 19 | 68 | 4 G5G5JG5-S | 350 |
| 9/16-18 | 22 | 22 | 47 | 6 G5G5JG5-S | 350 |
| 3/4-16 | 26 | 27 | 228 | 8 G5G5JG5-S | 350 |
| 7/8-14 | 30 | 27 | 228 | 10 G5G5JG5-S | 310 |

Parker Adapter are delivered with NBR elastomeric seals as standard. For more details on other seal materials see page O60.

Order codes shown are part of our current manufacturing programme.

Imperial and metric parts may vary in hexagon dimensions.

$$\frac{\text{PN (bar)}}{10} = \text{PN (MPa)}$$

Do not create drawings from these dimensions, they are subject to change and ISO manufacturing allowances.

P50NM Hexagon head plug

Male UN/UNF thread – O-ring (ISO 11926)
SAE 090109A

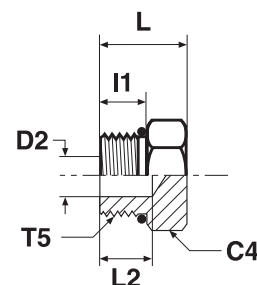

| Thread UN/UNF-2A T5 | C4 mm | D2 mm | I1 mm | L mm | L2 mm | Weight (steel) g/1 piece | Adapter Steel | Adapter Stainless Steel | PN (bar) | |
|---------------------------|----------|----------|----------|---------|----------|--------------------------------|------------------|----------------------------|----------|-----|
| | | | | | | | | | S | SS |
| 5/16-24 | 11.0 | 2.4 | 8 | 15 | 10 | 7 | 2 P50N-S | 2P50NMSS | 420 | 420 |
| 3/8-24 | 12.7 | 3.2 | 8 | 15 | 9 | 9 | 3 P50N-S | 3P50NMSS | 420 | 420 |
| 7/16-20 | 14.3 | 5.2 | 9 | 17 | 10 | 13 | 4 P50N-S | 4P50NMSS | 420 | 420 |
| 1/2-20 | 16.0 | 5.9 | 9 | 17 | 10 | 19 | 5 P50N-S | 5P50NMSS | 420 | 420 |
| 9/16-18 | 17.5 | 7.5 | 10 | 19 | 11 | 22 | 6 P50N-S | 6P50NMSS | 420 | 420 |
| 3/4-16 | 22.2 | 10.7 | 11 | 20 | 11 | 44 | 8 P50N-S | 8P50NMSS | 420 | 420 |
| 7/8-14 | 25.4 | 12.7 | 13 | 24 | 12 | 53 | 10 P50N-S | 10P50NMSS | 420 | 420 |
| 1 1/16-12 | 31.8 | 16.7 | 15 | 28 | 15 | 117 | 12 P50N-S | 12P50NMSS | 420 | 420 |
| 1 3/16-12 | 35.0 | 18.2 | 15 | 28 | 14 | 124 | 14 P50N-S | 14P50NMSS | 380 | 380 |
| 1 5/16-12 | 38.0 | 22.2 | 15 | 28 | 13 | 141 | 16 P50N-S | 16P50NMSS | 380 | 380 |
| 1 5/8-12 | 47.6 | 27.8 | 15 | 31 | 10 | 284 | 20 P50N-S | 20P50NMSS | 280 | 280 |
| 1 7/8-12 | 54.0 | 34.1 | 15 | 32 | 9 | 447 | 24 P50N-S | 24P50NMSS | 210 | 210 |
| 2 1/2-12 | 70.0 | 46.1 | 15 | 36 | 14 | 807 | 32 P50N-S | 32P50NMSS | 140 | 140 |

Parker Adapter are delivered with NBR elastomeric seals as standard. For more details on other seal materials see page O60.

Order codes shown are part of our current manufacturing programme.

Imperial and metric parts may vary in hexagon dimensions.

$$\frac{\text{PN (bar)}}{10} = \text{PN (MPa)}$$

Do not create drawings from these dimensions, they are subject to change and ISO manufacturing allowances.



Adapters

HP50N Hexagon socket plug

Male UN/UNF thread – O-ring (ISO 11926)
SAE 090109B

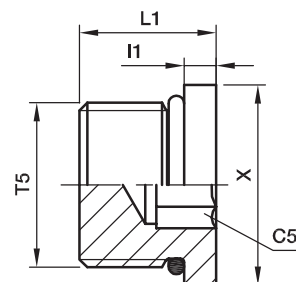

| Thread UN/UNF-2A T5 | C5 mm | l1 mm | L1 mm | X mm | Weight (steel) g/1 piece | Adapter Steel | Adapter Stainless Steel | PN (bar) | |
|---------------------------|----------|----------|----------|---------|--------------------------------|-------------------|----------------------------|----------|-----|
| | | | | | | | | S | SS |
| 5/16-24 | 1/8 | 3 | 10 | 11 | 5 | 2 HP50N-S | 2 HP50N-SS | 420 | 420 |
| 3/8-24 | 5/32 | 3 | 10 | 13 | 5 | 3 HP50N-S | 3 HP50N-SS | 420 | 420 |
| 7/16-20 | 3/16 | 3 | 12 | 14 | 7 | 4 HP50N-S | 4 HP50N-SS | 420 | 420 |
| 1/2-20 | 7/32 | 3 | 12 | 16 | 10 | 5 HP50N-S | 5 HP50N-SS | 420 | 420 |
| 9/16-18 | 1/4 | 3 | 13 | 18 | 12 | 6 HP50N-S | 6 HP50N-SS | 420 | 420 |
| 3/4-16 | 5/16 | 4 | 15 | 22 | 26 | 8 HP50N-S | 8 HP50N-SS | 420 | 420 |
| 7/8-14 | 3/8 | 4 | 17 | 25 | 39 | 10 HP50N-S | 10 HP50N-SS | 420 | 420 |
| 1 1/16-12 | 9/16 | 5 | 20 | 32 | 64 | 12 HP50N-S | 12 HP50N-SS | 420 | 420 |
| 1 3/16-12 | 9/16 | 5 | 20 | 35 | 85 | 14 HP50N-S | 14 HP50N-SS | 380 | 380 |
| 1 5/16-12 | 5/8 | 5 | 20 | 38 | 103 | 16 HP50N-S | 16 HP50N-SS | 380 | 380 |
| 1 5/8-12 | 3/4 | 5 | 20 | 48 | 165 | 20 HP50N-S | 20 HP50N-SS | 280 | 280 |
| 1 7/8-12 | 3/4 | 5 | 20 | 54 | 238 | 24 HP50N-S | 24 HP50N-SS | 210 | 210 |

Parker Adapter are delivered with NBR elastomeric seals as standard. For more details on other seal materials see page O60.

Order codes shown are part of our current manufacturing programme.

Imperial and metric parts may vary in hexagon dimensions.

$$\frac{\text{PN (bar)}}{10} = \text{PN (MPa)}$$

Do not create drawings from these dimensions, they are subject to change and ISO manufacturing allowances.

F3HG5 Male female thread adapter

Male BSPT thread (ISO 7) / Female UN/UNF thread – O-ring (ISO 11926-1)

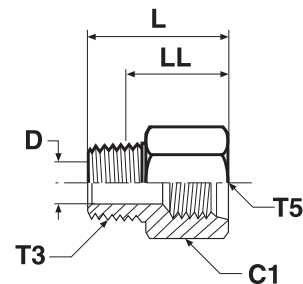

| Thread BSPT T3 | Thread UN/UNF-2B T5 | C1 mm | D mm | L mm | Weight (steel) g/1 piece | Adapter Steel | Adapter Stainless Steel | PN (bar) | |
|----------------------|---------------------------|----------|---------|---------|--------------------------------|---------------------|----------------------------|----------|-----|
| | | | | | | | | S | SS |
| 1/8-28 | 7/16-20 | 17.5 | 4.8 | 28 | 27 | 1/8-4F3HG5S | 1/8-4F3HMG5SS | 350 | 350 |
| 1/8-28 | 1/2-20 | 19.0 | 5.0 | 28 | 32 | 1/8-5F3HG5S | 1/8-5F3HMG5SS | 350 | 350 |
| 1/4-19 | 9/16-18 | 20.6 | 7.1 | 35 | 45 | 1/4-6F3HG5S | 1/4-6F3HMG5SS | 350 | 350 |
| 3/8-19 | 3/4-16 | 25.4 | 10.3 | 37 | 73 | 3/8-8F3HG5S | 3/8-8F3HMG5SS | 315 | 315 |
| 1/2-14 | 7/8-14 | 28.6 | 13.5 | 45 | 111 | 1/2-10F3HG5S | 1/2-10F3HMG5SS | 210 | 210 |
| 3/4-14 | 1 1/16-12 | 35.0 | 18.3 | 49 | 177 | 3/4-12F3HG5S | 3/4-12F3HMG5SS | 210 | 210 |
| 1-11 | 1 5/16-12 | 41.3 | 23.8 | 54 | 272 | 1-16F3HG5S | 1-16F3HMG5SS | 120 | 120 |

Order codes shown are part of our current manufacturing programme.

Imperial and metric parts may vary in hexagon dimensions.

$$\frac{\text{PN (bar)}}{10} = \text{PN (MPa)}$$

Do not create drawings from these dimensions, they are subject to change and ISO manufacturing allowances.



Adapters

F4OHG5 Male female thread adapter

Male BSPP thread O-ring + retaining ring (ISO 1179) /
 Female UN/UNF thread – O-ring (ISO 11926-1)

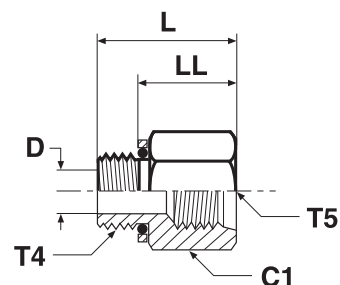

| Thread BSPP T4 | Thread UN/UNF-2B T5 | C1 mm | D mm | L mm | LL mm | Weight (steel) g/1 piece | Adapter Steel | Adapter Stainless Steel | PN (bar) | |
|----------------------|---------------------------|----------|---------|---------|----------|--------------------------------|------------------|----------------------------|----------|-----|
| | | | | | | | | | S | SS |
| 1/8-28 | 7/16-20 | 17.5 | 4.4 | 25 | 19 | 27 | 1/8-4F4OHG5S | 1/8-4F4OHMG5SS | 350 | 315 |
| 1/4-19 | 7/16-20 | 19.0 | 7.5 | 28 | 17 | 40 | 1/4-4F4OHG5S | 1/4-4F4OHMG5SS | 350 | 315 |
| 1/4-19 | 9/16-18 | 20.6 | 7.5 | 32 | 22 | 45 | 1/4-6F4OHG5S | 1/4-6F4OHMG5SS | 350 | 315 |
| 3/8-19 | 9/16-18 | 22.2 | 9.9 | 32 | 22 | 70 | 3/8-6F4OHG5S | 3/8-6F4OHMG5SS | 350 | 315 |
| 3/8-19 | 3/4-16 | 25.4 | 9.9 | 34 | 24 | 73 | 3/8-8F4OHG5S | 3/8-8F4OHMG5SS | 350 | 280 |
| 1/2-14 | 7/8-14 | 28.6 | 12.3 | 41 | 28 | 111 | 1/2-10F4OHG5S | 1/2-10F4OHMG5SS | 240 | 240 |
| 3/4-14 | 1 1/16-12 | 35.0 | 15.5 | 44 | 32 | 177 | 3/4-12F4OHG5S | 3/4-12F4OHMG5SS | 240 | 240 |
| 1-11 | 1 5/16-12 | 44.5 | 21.4 | 49 | 33 | 272 | 1-16F4OHG5S | 1-16F4OHMG5SS | 240 | 210 |
| 1 1/4-11 | 1 5/8-12 | 50.8 | 27.4 | 50 | 33 | 320 | 1 1/4-20F4OHG5S | 1 1/4-20F4OHMG5SS | 140 | 140 |

Parker Adapter are delivered with NBR elastomeric seals as standard. For more details on other seal materials see page O60.

Order codes shown are part of our current manufacturing programme.

Imperial and metric parts may vary in hexagon dimensions.

$$\frac{\text{PN (bar)}}{10} = \text{PN (MPa)}$$

Do not create drawings from these dimensions, they are subject to change and ISO manufacturing allowances.

F8OHG5 Male female thread adapter

Male metric thread O-ring + retaining ring / Female UN/UNF thread – O-ring (ISO 11926-1)

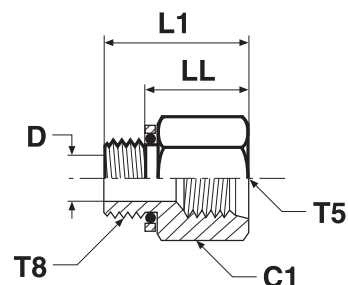

| Thread Metric T8 | Thread UN/UNF-2B T5 | C1 mm | D mm | L1 mm | LL mm | Weight (steel) g/1 piece | Adapter Steel | Adapter Stainless Steel | PN (bar) | |
|------------------------|---------------------------|----------|---------|----------|----------|--------------------------------|----------------------|----------------------------|----------|-----|
| | | | | | | | | | S | SS |
| M 10×1.0 | 7/16-20 | 17.5 | 4 | 27 | 19 | 27 | M10-4F8OHG5S | M10-4F8OHG5SS | 350 | 315 |
| M 14×1.5 | 9/16-18 | 20.6 | 7 | 30 | 22 | 45 | M14-6F8OHG5S | M14-6F8OHG5SS | 350 | 315 |
| M 16×1.5 | 3/4-16 | 25.4 | 9 | 33 | 23 | 73 | M16-8F8OHG5S | M16-8F8OHG5SS | 350 | 280 |
| M 22×1.5 | 7/8-14 | 28.6 | 13 | 38 | 25 | 111 | M22-10F8OHG5S | M22-10F8OHG5SS | 240 | 210 |
| M 27×2.0 | 1 1/16-12 | 35.0 | 16 | 48 | 33 | 170 | M27-12F8OHG5S | M27-12F8OHG5SS | 240 | 210 |
| M 33×2.0 | 1 5/16-12 | 41.3 | 22 | 49 | 34 | 250 | M33-16F8OHG5S | M33-16F8OHG5SS | 140 | 140 |
| M 42×2.0 | 1 5/8-12 | 50.8 | 28 | 49 | 33 | 320 | M42-20F8OHG5S | M42-20F8OHG5SS | 140 | 140 |

Parker Adapter are delivered with NBR elastomeric seals as standard. For more details on other seal materials see page O60.

Order codes shown are part of our current manufacturing programme.

Imperial and metric parts may vary in hexagon dimensions.

$$\frac{\text{PN (bar)}}{10} = \text{PN (MPa)}$$

Do not create drawings from these dimensions, they are subject to change and ISO manufacturing allowances.



Adapters

HMK4 Union

BSPP 60° Cone end (ISO 8434-6)

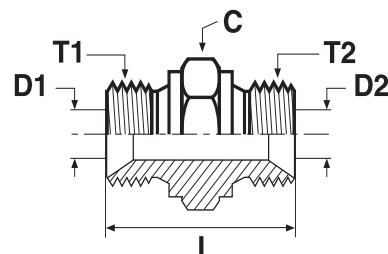

| Thread BSPP T1 | Thread BSPP T2 | C mm | D1 mm | D2 mm | L mm | Weight (steel) g/1 piece | Adapter Steel | Adapter Stainless Steel | PN (bar) | |
|----------------------|----------------------|---------|----------|----------|---------|--------------------------------|-------------------|----------------------------|----------|-----|
| | | | | | | | | | S | SS |
| 1/8-28 | 1/8-28 | 14 | 3.5 | 3.5 | 24 | 15 | 2HMK4S | 2HMK4SS | 350 | 350 |
| 1/4-19 | 1/8-28 | 19 | 4.7 | 3.5 | 28 | 29 | 4-2HMK4S | 4-2HMK4SS | 350 | 350 |
| 1/4-19 | 1/4-19 | 19 | 4.7 | 4.7 | 32 | 35 | 4HMK4S | 4HMK4SS | 350 | 350 |
| 3/8-19 | 1/4-19 | 22 | 7.9 | 4.7 | 33 | 46 | 6-4HMK4S | 6-4HMK4SS | 350 | 350 |
| 3/8-19 | 3/8-19 | 22 | 7.9 | 7.9 | 35 | 51 | 6HMK4S | 6HMK4SS | 350 | 350 |
| 1/2-14 | 1/4-19 | 27 | 11.1 | 4.7 | 37 | 70 | 8-4HMK4S | 8-4HMK4SS | 200 | 200 |
| 1/2-14 | 3/8-19 | 27 | 11.1 | 7.9 | 38 | 76 | 8-6HMK4S | 8-6HMK4SS | 200 | 200 |
| 1/2-14 | 1/2-14 | 27 | 11.1 | 11.1 | 41 | 85 | 8HMK4S | 8HMK4SS | 200 | 200 |
| 5/8-14 | 1/2-14 | 30 | 14.3 | 11.1 | 43 | 106 | 10-8HMK4S | 10-8HMK4SS | 200 | 200 |
| 5/8-14 | 5/8-14 | 30 | 14.3 | 14.3 | 45 | 112 | 10HMK4S | 10HMK4SS | 200 | 200 |
| 3/4-14 | 1/4-19 | 32 | 16.7 | 4.7 | 39 | 92 | 12-4HMK4S | 12-4HMK4SS | 200 | 200 |
| 3/4-14 | 3/8-19 | 32 | 16.7 | 7.9 | 41 | 107 | 12-6HMK4S | 12-6HMK4SS | 200 | 200 |
| 3/4-14 | 1/2-14 | 32 | 16.7 | 11.1 | 43 | 111 | 12-8HMK4S | 12-8HMK4SS | 200 | 200 |
| 3/4-14 | 5/8-14 | 32 | 16.7 | 14.3 | 45 | 106 | 12-10HMK4S | 12-10HMK4SS | 200 | 200 |
| 3/4-14 | 3/4-14 | 32 | 16.7 | 16.7 | 45 | 124 | 12HMK4S | 12HMK4SS | 200 | 200 |
| 1-11 | 1/2-14 | 41 | 22.2 | 11.1 | 47 | 175 | 16-8HMK4S | 16-8HMK4SS | 120 | 120 |
| 1-11 | 5/8-14 | 41 | 22.2 | 14.3 | 49 | 188 | 16-10HMK4S | 16-10HMK4SS | 120 | 120 |
| 1-11 | 3/4-14 | 41 | 22.2 | 16.7 | 49 | 190 | 16-12HMK4S | 16-12HMK4SS | 120 | 120 |
| 1-11 | 1-11 | 41 | 22.2 | 22.2 | 52 | 199 | 16HMK4S | 16HMK4SS | 120 | 120 |
| 1 1/4-11 | 3/4-14 | 50 | 28.6 | 16.7 | 57 | 259 | 20-12HMK4S | 20-12HMK4SS | 105 | 105 |
| 1 1/4-11 | 1-11 | 50 | 28.6 | 22.2 | 60 | 383 | 20-16HMK4S | 20-16HMK4SS | 105 | 105 |
| 1 1/4-11 | 1 1/4-11 | 50 | 28.6 | 28.6 | 61 | 405 | 20HMK4S | 20HMK4SS | 105 | 105 |
| 1 1/2-11 | 3/4-14 | 55 | 33.3 | 16.7 | 61 | 501 | 24-12HMK4S | 24-12HMK4SS | 105 | 105 |
| 1 1/2-11 | 1-11 | 55 | 33.3 | 22.2 | 64 | 417 | 24-16HMK4S | 24-16HMK4SS | 105 | 105 |
| 1 1/2-11 | 1 1/4-11 | 55 | 33.3 | 28.6 | 65 | 410 | 24-20HMK4S | 24-20HMK4SS | 105 | 105 |
| 1 1/2-11 | 1 1/2-11 | 55 | 33.3 | 33.3 | 67 | 534 | 24HMK4S | 24HMK4SS | 105 | 105 |
| 2-11 | 1 1/2-11 | 70 | 46.0 | 33.3 | 73 | 660 | 32-24HMK4S | 32-24HMK4SS | 70 | 70 |
| 2-11 | 2-11 | 70 | 46.0 | 46.0 | 76 | 719 | 32HMK4S | 32HMK4SS | 70 | 70 |

Order codes shown are part of our current manufacturing programme.

Imperial and metric parts may vary in hexagon dimensions.

$$\frac{\text{PN (bar)}}{10} = \text{PN (MPa)}$$

Do not create drawings from these dimensions, they are subject to change and ISO manufacturing allowances.

WMK4WL4NM Bulkhead union

BSPP 60° Cone end (ISO 8434-6)

*Supplied with locknut

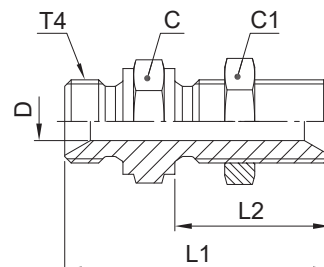

| Thread BSPP T4 | L1 mm | L2 mm | C mm | C1 mm | D mm | Weight (steel) g/1 piece | Adapter Steel | Adapter Stainless Steel | PN (bar) | |
|----------------------|----------|----------|---------|----------|---------|--------------------------------|---------------------|----------------------------|----------|-----|
| | | | | | | | | | S | SS |
| 1/4-19 | 49 | 28 | 19 | 19 | 4.7 | 57 | 4WMK4WL4NMS | 4WMK4WL4NMSS | 350 | 350 |
| 3/8-19 | 55 | 32 | 22 | 22 | 7.9 | 84 | 6WMK4WL4NMS | 6WMK4WL4NMSS | 350 | 350 |
| 1/2-14 | 62 | 35 | 27 | 27 | 11.1 | 122 | 8WMK4WL4NMS | 8WMK4WL4NMSS | 200 | 200 |
| 5/8-14 | 64 | 35 | 30 | 30 | 14.3 | 146 | 10WMK4WL4NMS | 10WMK4WL4NMSS | 200 | 200 |
| 3/4-14 | 67 | 38 | 32 | 36 | 16.7 | 209 | 12WMK4WL4NMS | 12WMK4WL4NMSS | 200 | 200 |
| 1-11 | 74 | 41 | 41 | 41 | 22.2 | 328 | 16WMK4WL4NMS | 16WMK4WL4NMSS | 120 | 120 |
| 1 1/4-11 | 85 | 44 | 50 | 50 | 28.6 | 507 | 20WMK4WL4NMS | 20WMK4WL4NMSS | 105 | 105 |
| 1 1/2-11 | 93 | 48 | 55 | 55 | 33.3 | 609 | 24WMK4WL4NMS | 24WMK4WL4NMSS | 105 | 105 |

Order codes shown are part of our current manufacturing programme.

Imperial and metric parts may vary in hexagon dimensions.

For the version without locknut, please delete "WL4NM" (e.g. 16WMK4)

$$\frac{\text{PN (bar)}}{10} = \text{PN (MPa)}$$

Do not create drawings from these dimensions, they are subject to change and ISO manufacturing allowances.

Maximum bulkhead wallthickness

| Thread BSPP | Bulkhead union Max. thickness mm |
|----------------|--|
| 1/4 | 9.5 |
| 3/8 | 12.5 |
| 1/2 | 12.4 |
| 5/8 | 10.8 |
| 3/4 | 13.4 |
| 1 | 10.1 |
| 1 1/4 | 12.1 |
| 1 1/2 | 14.1 |

Adapters

EMK4 Union elbow

BSPP 60° Cone end (ISO 8434-6)

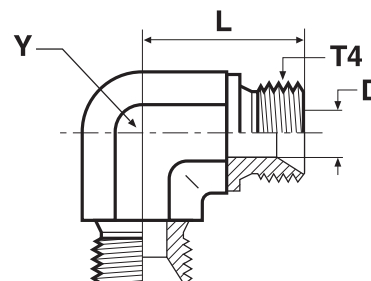

| Thread BSPP T4 | D mm | L mm | Y mm | Weight (steel) g/1 piece | Adapter Steel | Adapter Stainless Steel | PN (bar) | |
|----------------------|---------|---------|---------|--------------------------------|------------------|----------------------------|----------|-----|
| | | | | | | | S | SS |
| 1/8-28 | 3.5 | 17 | 11 | 21 | 2EMK4S | 2EMK4SS | 350 | 350 |
| 1/4-19 | 4.7 | 24 | 14 | 45 | 4EMK4S | 4EMK4SS | 350 | 350 |
| 3/8-19 | 7.9 | 27 | 19 | 85 | 6EMK4S | 6EMK4SS | 350 | 350 |
| 1/2-14 | 11.1 | 32 | 22 | 123 | 8EMK4S | 8EMK4SS | 200 | 200 |
| 5/8-14 | 14.3 | 34 | 22 | 109 | 10EMK4S | 10EMK4SS | 200 | 200 |
| 3/4-14 | 16.7 | 36 | 27 | 178 | 12EMK4S | 12EMK4SS | 200 | 200 |
| 1-11 | 22.2 | 42 | 33 | 288 | 16EMK4S | 16EMK4SS | 120 | 120 |
| 1 1/4-11 | 28.6 | 48 | 41 | 512 | 20EMK4S | 20EMK4SS | 105 | 105 |
| 1 1/2-11 | 33.3 | 54 | 48 | 824 | 24EMK4S | 24EMK4SS | 105 | 105 |

Do not create drawings from these dimensions, they are subject to change and ISO manufacturing allowances.

JMK4 Union tee

BSPP 60° Cone end (ISO 8434-6)

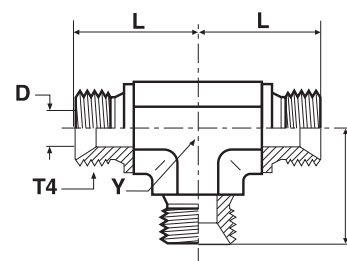

| Thread BSPP T4 | D mm | L mm | Y mm | Weight (steel) g/1 piece | Adapter Steel | Adapter Stainless Steel | PN (bar) | |
|----------------------|---------|---------|---------|--------------------------------|------------------|----------------------------|----------|-----|
| | | | | | | | S | SS |
| 1/8-28 | 3.5 | 17 | 11 | 33 | 2JMK4S | 2JMK4SS | 350 | 350 |
| 1/4-19 | 4.7 | 24 | 14 | 61 | 4JMK4S | 4JMK4SS | 350 | 350 |
| 3/8-19 | 7.9 | 27 | 19 | 105 | 6JMK4S | 6JMK4SS | 350 | 350 |
| 1/2-14 | 11.1 | 32 | 22 | 157 | 8JMK4S | 8JMK4SS | 200 | 200 |
| 5/8-14 | 14.3 | 34 | 22 | 145 | 10JMK4S | 10JMK4SS | 200 | 200 |
| 3/4-14 | 16.7 | 36 | 27 | 258 | 12JMK4S | 12JMK4SS | 200 | 200 |
| 1-11 | 22.2 | 42 | 33 | 591 | 16JMK4S | 16JMK4SS | 120 | 120 |
| 1 1/4-11 | 28.6 | 48 | 41 | 646 | 20JMK4S | 20JMK4SS | 105 | 105 |
| 1 1/2-11 | 33.3 | 54 | 48 | 940 | 24JMK4S | 24JMK4SS | 105 | 105 |

Order codes shown are part of our current manufacturing programme.

Imperial and metric parts may vary in hexagon dimensions.

$$\frac{\text{PN (bar)}}{10} = \text{PN (MPa)}$$

Do not create drawings from these dimensions, they are subject to change and ISO manufacturing allowances.

PNMK4 Plug

BSPP 60° Cone plug (ISO 8434-6)

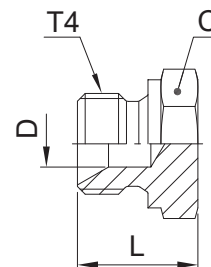

| Thread BSPP T4 | C mm | D mm | L mm | Weight (steel) g/1 piece | Adapter Steel | Adapter Stainless Steel | PN (bar) | |
|----------------------|---------|---------|---------|--------------------------------|------------------|----------------------------|----------|-----|
| | | | | | | | S | SS |
| 1/8-28 | 14 | 3.5 | 14 | 11 | 2PNMK4S | 2PNMK4SS | 350 | 350 |
| 1/4-19 | 19 | 4.7 | 19 | 22 | 4PNMK4S | 4PNMK4SS | 350 | 350 |
| 3/8-19 | 22 | 7.9 | 21 | 38 | 6PNMK4S | 6PNMK4SS | 350 | 350 |
| 1/2-14 | 27 | 11.1 | 24 | 66 | 8PNMK4S | 8PNMK4SS | 200 | 200 |
| 5/8-14 | 30 | 14.3 | 27 | 76 | 10PNMK4S | 10PNMK4SS | 200 | 200 |
| 3/4-14 | 32 | 16.7 | 27 | 106 | 12PNMK4S | 12PNMK4SS | 200 | 200 |
| 1-11 | 41 | 22.2 | 30 | 170 | 16PNMK4S | 16PNMK4SS | 120 | 120 |
| 1 1/4-11 | 50 | 28.6 | 39 | 316 | 20PNMK4S | 20PNMK4SS | 105 | 105 |
| 1 1/2-11 | 55 | 33.3 | 43 | 386 | 24PNMK4S | 24PNMK4SS | 105 | 105 |
| 2-11 | 70 | 46.0 | 48 | 650 | 32PNMK4S | 32PNMK4SS | 70 | 70 |

Order codes shown are part of our current manufacturing programme.

Imperial and metric parts may vary in hexagon dimensions.

$$\frac{\text{PN (bar)}}{10} = \text{PN (MPa)}$$

Do not create drawings from these dimensions, they are subject to change and ISO manufacturing allowances.



Adapters

F6MK4 Swivel male stud

BSPP 60° cone end (ISO 8434-6) / BSPP 60° Female swivel end (ISO 8434-6)

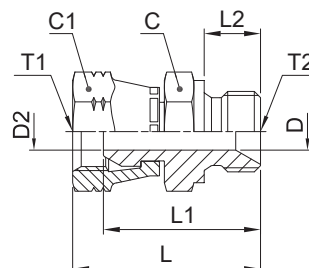

| Thread BSPP T1 | Thread BSPP T2 | C mm | C1 mm | D mm | D2 mm | L mm | L1 mm | L2 mm | Weight (steel) g/1 piece | Adapter Steel | Adapter Stainless Steel | PN (bar) | |
|----------------------|----------------------|---------|----------|---------|----------|---------|----------|----------|--------------------------------|--------------------|----------------------------|----------|-----|
| | | | | | | | | | | | | S | SS |
| 1/4-19 | 1/4-19 | 19 | 19 | 4.7 | 4.7 | 37 | 31 | 11 | 44 | 4-4F6MK4S | 4-4F6MK4SS | 350 | 350 |
| 1/4-19 | 3/8-19 | 22 | 19 | 7.9 | 4.7 | 39 | 34 | 12 | 61 | 4-6F6MK4S | 4-6F6MK4SS | 350 | 350 |
| 1/4-19 | 1/2-14 | 27 | 19 | 11.1 | 4.7 | 42 | 36 | 14 | 75 | 4-8F6MK4S | 4-8F6MK4SS | 200 | 200 |
| 3/8-19 | 1/4-19 | 19 | 22 | 4.7 | 4.7 | 38 | 32 | 11 | 59 | 6-4F6MK4S | 6-4F6MK4SS | 350 | 350 |
| 3/8-19 | 3/8-19 | 22 | 22 | 7.9 | 7.9 | 40 | 34 | 12 | 71 | 6-6F6MK4S | 6-6F6MK4SS | 350 | 350 |
| 3/8-19 | 1/2-14 | 27 | 22 | 11.1 | 7.9 | 44 | 37 | 14 | 92 | 6-8F6MK4S | 6-8F6MK4SS | 200 | 200 |
| 1/2-14 | 3/8-19 | 22 | 27 | 7.9 | 7.9 | 44 | 37 | 12 | 102 | 8-6F6MK4S | 8-6F6MK4SS | 200 | 200 |
| 1/2-14 | 1/2-14 | 27 | 27 | 11.1 | 11.1 | 46 | 39 | 14 | 143 | 8-8F6MK4S | 8-8F6MK4SS | 200 | 200 |
| 1/2-14 | 3/4-14 | 32 | 27 | 16.7 | 11.1 | 49 | 42 | 16 | 157 | 8-12F6MK4S | 8-12F6MK4SS | 200 | 200 |
| 3/4-14 | 1/2-14 | 27 | 32 | 11.1 | 11.1 | 48 | 39 | 14 | 171 | 12-8F6MK4S | 12-8F6MK4SS | 200 | 200 |
| 3/4-14 | 3/4-14 | 32 | 32 | 16.7 | 16.7 | 50 | 41 | 16 | 165 | 12-12F6MK4S | 12-12F6MK4SS | 200 | 200 |
| 3/4-14 | 1-11 | 41 | 32 | 22.2 | 16.7 | 54 | 45 | 19 | 261 | 12-16F6MK4S | 12-16F6MK4SS | 120 | 120 |
| 1-11 | 3/4-14 | 32 | 41 | 16.7 | 16.7 | 54 | 43 | 16 | 250 | 16-12F6MK4S | 16-12F6MK4SS | 120 | 120 |
| 1-11 | 1-11 | 41 | 41 | 22.2 | 22.2 | 57 | 46 | 19 | 300 | 16-16F6MK4S | 16-16F6MK4SS | 120 | 120 |
| 1-11 | 1-11 | 50 | 50 | 28.6 | 28.6 | 71 | 61 | 20 | 528 | 20-20F6MK4S | 20-20F6MK4SS | 120 | 120 |

Order codes shown are part of our current manufacturing programme.

Imperial and metric parts may vary in hexagon dimensions.

$$\frac{\text{PN (bar)}}{10} = \text{PN (MPa)}$$

Do not create drawings from these dimensions, they are subject to change and ISO manufacturing allowances.

C6MK4 Swivel nut elbow

BSPP 60° cone end (ISO 8434-6) / BSPP 60° Female swivel end (ISO 8434-6)

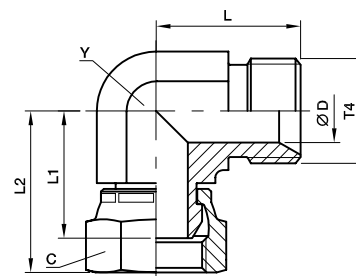

| Thread BSPP T4 | C mm | D mm | L mm | L1 mm | L2 mm | Y mm | Weight (steel) g/1 piece | Adapter Steel | Adapter Stainless Steel | PN (bar) | |
|----------------------|---------|---------|---------|----------|----------|---------|--------------------------------|------------------|----------------------------|----------|-----|
| | | | | | | | | | | S | SS |
| 1/8-28 | 14 | 3.5 | 17 | 18 | 23 | 11 | 26 | 2C6MK4S | 2C6MK4SS | 350 | 350 |
| 1/4-19 | 19 | 4.7 | 24 | 25 | 31 | 14 | 62 | 4C6MK4S | 4C6MK4SS | 350 | 350 |
| 3/8-19 | 22 | 7.9 | 27 | 26 | 33 | 19 | 104 | 6C6MK4S | 6C6MK4SS | 350 | 350 |
| 1/2-14 | 27 | 11.1 | 32 | 32 | 39 | 22 | 159 | 8C6MK4S | 8C6MK4SS | 200 | 200 |
| 5/8-14 | 30 | 14.3 | 34 | 30 | 40 | 22 | 158 | 10C6MK4S | 10C6MK4SS | 200 | 200 |
| 3/4-14 | 32 | 16.7 | 36 | 33 | 42 | 27 | 226 | 12C6MK4S | 12C6MK4SS | 200 | 200 |
| 1-11 | 41 | 22.2 | 42 | 38 | 49 | 33 | 377 | 16C6MK4S | 16C6MK4SS | 120 | 120 |
| 1 1/4-11 | 50 | 28.6 | 48 | 48 | 58 | 41 | 650 | 20C6MK4S | 20C6MK4SS | 105 | 105 |
| 1 1/2-11 | 60 | 33.3 | 54 | 50 | 63 | 48 | 999 | 24C6MK4S | 24C6MK4SS | 105 | 105 |

Order codes shown are part of our current manufacturing programme.

Imperial and metric parts may vary in hexagon dimensions.

$$\frac{\text{PN (bar)}}{10} = \text{PN (MPa)}$$

Do not create drawings from these dimensions, they are subject to change and ISO manufacturing allowances.



Adapters

R6MK4 Swivel nut run tee

BSPP 60° Cone ends (ISO 8434-6) / BSPP 60° Female swivel end (ISO 8434-6)

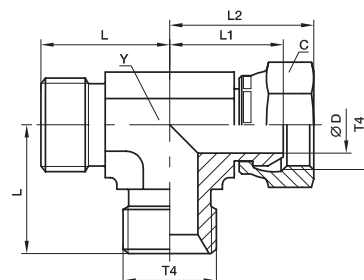

| Thread BSPP T4 | C mm | D mm | L mm | L1 mm | L2 mm | Y mm | Weight (steel) g/1 piece | Adapter Steel | Adapter Stainless Steel | PN (bar) | |
|----------------------|---------|---------|---------|----------|----------|---------|--------------------------------|------------------|----------------------------|----------|-----|
| | | | | | | | | | | S | SS |
| 1/8-28 | 14 | 3.5 | 17 | 18 | 23 | 11 | 29 | 2R6MK4S | 2R6MK4SS | 350 | 350 |
| 1/4-19 | 19 | 4.7 | 24 | 25 | 31 | 14 | 77 | 4R6MK4S | 4R6MK4SS | 350 | 350 |
| 3/8-19 | 22 | 7.9 | 27 | 26 | 33 | 19 | 128 | 6R6MK4S | 6R6MK4SS | 350 | 350 |
| 1/2-14 | 27 | 11.1 | 32 | 32 | 39 | 22 | 203 | 8R6MK4S | 8R6MK4SS | 200 | 200 |
| 5/8-14 | 30 | 14.3 | 34 | 30 | 40 | 22 | 274 | 10R6MK4S | 10R6MK4SS | 200 | 200 |
| 3/4-14 | 32 | 16.7 | 36 | 33 | 42 | 27 | 274 | 12R6MK4S | 12R6MK4SS | 200 | 200 |
| 1-11 | 41 | 22.2 | 42 | 38 | 49 | 33 | 456 | 16R6MK4S | 16R6MK4SS | 120 | 120 |
| 1 1/4-11 | 50 | 28.6 | 48 | 48 | 58 | 41 | 801 | 20R6MK4S | 20R6MK4SS | 105 | 105 |

Order codes shown are part of our current manufacturing programme.

Imperial and metric parts may vary in hexagon dimensions.

$$\frac{\text{PN (bar)}}{10} = \text{PN (MPa)}$$

Do not create drawings from these dimensions, they are subject to change and ISO manufacturing allowances.

S6MK4 Swivel nut branch tee

BSPP 60° Cone ends (ISO 8434-6) / BSPP 60° Female swivel end (ISO 8434-6)

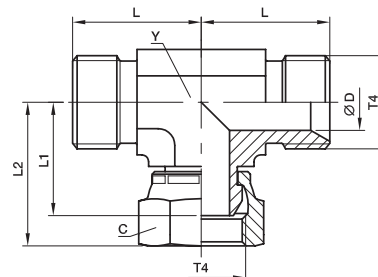

| Thread BSPP T4 | C mm | D mm | L mm | L1 mm | L2 mm | Y mm | Weight (steel) g/1 piece | Adapter Steel | Adapter Stainless Steel | PN (bar) | |
|----------------------|---------|---------|---------|----------|----------|---------|--------------------------------|------------------|----------------------------|----------|-----|
| | | | | | | | | | | S | SS |
| 1/8-28 | 14 | 3.5 | 17 | 18 | 23 | 11 | 33 | 2S6MK4S | 2S6MK4SS | 350 | 350 |
| 1/4-19 | 19 | 4.7 | 24 | 25 | 31 | 14 | 77 | 4S6MK4S | 4S6MK4SS | 350 | 350 |
| 3/8-19 | 22 | 7.9 | 27 | 26 | 33 | 19 | 126 | 6S6MK4S | 6S6MK4SS | 350 | 350 |
| 1/2-14 | 27 | 11.1 | 32 | 32 | 39 | 22 | 191 | 8S6MK4S | 8S6MK4SS | 200 | 200 |
| 5/8-14 | 30 | 14.3 | 34 | 30 | 40 | 22 | 209 | 10S6MK4S | 10S6MK4SS | 200 | 200 |
| 3/4-14 | 32 | 16.7 | 36 | 33 | 42 | 27 | 286 | 12S6MK4S | 12S6MK4SS | 200 | 200 |
| 1-11 | 41 | 22.2 | 42 | 38 | 49 | 33 | 493 | 16S6MK4S | 16S6MK4SS | 120 | 120 |
| 1 1/4-11 | 50 | 28.6 | 48 | 48 | 58 | 41 | 796 | 20S6MK4S | 20S6MK4SS | 105 | 105 |

Order codes shown are part of our current manufacturing programme.

Imperial and metric parts may vary in hexagon dimensions.

$$\frac{\text{PN (bar)}}{10} = \text{PN (MPa)}$$

Do not create drawings from these dimensions, they are subject to change and ISO manufacturing allowances.



Adapters

H6MK4 Swivel nut union

BSPP 60° Female swivel ends (ISO 8434-6)

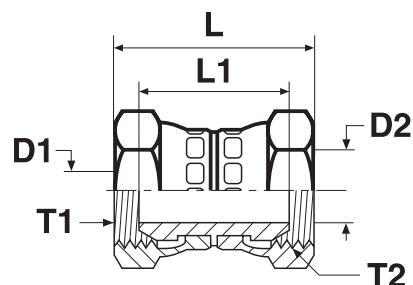

| Thread BSPP T1 | Thread BSPP T2 | D1 mm | D2 mm | L mm | L1 mm | Weight (steel) g/1 piece | Adapter Steel | Adapter Stainless Steel | PN (bar) | |
|----------------------|----------------------|----------|----------|---------|----------|--------------------------------|-------------------|----------------------------|----------|-----|
| | | | | | | | | | S | SS |
| 1/4-19 | 1/4-19 | 4.7 | 4.7 | 38 | 27 | 50 | 4H6MK4S | 4H6MK4SS | 350 | 350 |
| 3/8-19 | 1/4-19 | 7.9 | 4.7 | 40 | 28 | 61 | 6-4H6MK4S | 6-4H6MK4SS | 350 | 350 |
| 3/8-19 | 3/8-19 | 7.9 | 7.9 | 42 | 29 | 73 | 6H6MK4S | 6H6MK4SS | 350 | 350 |
| 1/2-14 | 1/4-19 | 11.1 | 4.7 | 43 | 30 | 85 | 8-4H6MK4S | 8-4H6MK4SS | 200 | 200 |
| 1/2-14 | 3/8-19 | 11.1 | 7.9 | 44 | 31 | 96 | 8-6H6MK4S | 8-6H6MK4SS | 200 | 200 |
| 1/2-14 | 1/2-14 | 11.1 | 11.1 | 47 | 33 | 107 | 8H6MK4S | 8H6MK4SS | 200 | 200 |
| 5/8-14 | 5/8-14 | 14.3 | 14.3 | 48 | 29 | 130 | 10H6MK4S | 10H6MK4SS | 200 | 200 |
| 3/4-14 | 1/2-14 | 16.7 | 11.1 | 49 | 33 | 152 | 12-8H6MK4S | 12-8H6MK4SS | 200 | 200 |
| 3/4-14 | 3/4-14 | 16.7 | 16.7 | 50 | 32 | 167 | 12H6MK4S | 12H6MK4SS | 200 | 200 |
| 1-11 | 1-11 | 22.2 | 22.2 | 57 | 35 | 201 | 16H6MK4S | 16H6MK4SS | 120 | 120 |
| 1 1/4-11 | 1 1/4-11 | 28.6 | 28.6 | 66 | 45 | 340 | 20H6MK4S | 20H6MK4SS | 105 | 105 |
| 1 1/2-11 | 1 1/2-11 | 33.3 | 33.3 | 70 | 43 | 583 | 24H6MK4S | 24H6MK4SS | 105 | 105 |

Order codes shown are part of our current manufacturing programme.

Imperial and metric parts may vary in hexagon dimensions.

$$\frac{\text{PN (bar)}}{10} = \text{PN (MPa)}$$

Do not create drawings from these dimensions, they are subject to change and ISO manufacturing allowances.

E6MK4 Swivel nut elbow

BSPP 60° Female swivel ends (ISO 8434-6)

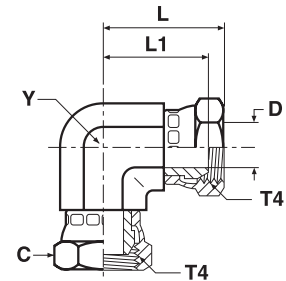

| Thread BSPP T4 | C mm | D mm | L mm | L1 mm | Y mm | Weight (steel) g/1 piece | Adapter Steel | Adapter Stainless Steel | PN (bar) | |
|----------------------|---------|---------|---------|----------|---------|--------------------------------|------------------|----------------------------|----------|-----|
| | | | | | | | | | S | SS |
| 1/4-19 | 19 | 4.7 | 31 | 25 | 14 | 90 | 4E6MK4S | 4E6MK4SS | 350 | 350 |
| 3/8-19 | 22 | 7.9 | 33 | 26 | 19 | 127 | 6E6MK4S | 6E6MK4SS | 350 | 350 |
| 1/2-14 | 27 | 11.1 | 39 | 32 | 22 | 225 | 8E6MK4S | 8E6MK4SS | 200 | 200 |
| 5/8-14 | 30 | 14.3 | 39 | 30 | 22 | 203 | 10E6MK4S | 10E6MK4SS | 200 | 200 |
| 3/4-14 | 32 | 16.7 | 42 | 33 | 27 | 263 | 12E6MK4S | 12E6MK4SS | 200 | 200 |
| 1-11 | 41 | 22.2 | 49 | 38 | 33 | 667 | 16E6MK4S | 16E6MK4SS | 120 | 120 |
| 1 1/4-11 | 50 | 28.6 | 58 | 48 | 41 | 795 | 20E6MK4S | 20E6MK4SS | 105 | 105 |
| 1 1/2-11 | 60 | 33.3 | 63 | 50 | 48 | 1219 | 24E6MK4S | 24E6MK4SS | 105 | 105 |

Order codes shown are part of our current manufacturing programme.

Imperial and metric parts may vary in hexagon dimensions.

$$\frac{\text{PN (bar)}}{10} = \text{PN (MPa)}$$

Do not create drawings from these dimensions, they are subject to change and ISO manufacturing allowances.



Adapters

J6MK4 Swivel nut tee

BSPP 60° Female swivel ends (ISO 8434-6)

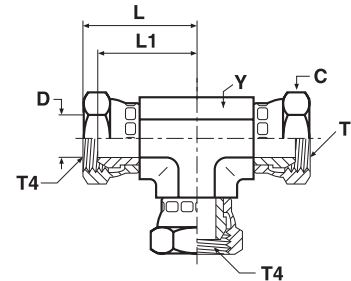

| Thread BSPP T4 | C mm | D mm | L mm | L1 mm | Y mm | Weight (steel) g/1 piece | Adapter Steel | Adapter Stainless Steel | PN (bar) | |
|----------------------|---------|---------|---------|----------|---------|--------------------------------|------------------|----------------------------|----------|-----|
| | | | | | | | | | S | SS |
| 1/4-19 | 19 | 4.7 | 31 | 25 | 14 | 119 | 4J6MK4S | 4J6MK4SS | 350 | 350 |
| 3/8-19 | 22 | 7.9 | 33 | 26 | 19 | 195 | 6J6MK4S | 6J6MK4SS | 350 | 350 |
| 1/2-14 | 27 | 11.1 | 39 | 32 | 22 | 267 | 8J6MK4S | 8J6MK4SS | 200 | 200 |
| 5/8-14 | 30 | 14.3 | 39 | 30 | 22 | 300 | 10J6MK4S | 10J6MK4SS | 200 | 200 |
| 3/4-14 | 32 | 16.7 | 42 | 33 | 27 | 398 | 12J6MK4S | 12J6MK4SS | 200 | 200 |
| 1-11 | 41 | 22.2 | 49 | 38 | 33 | 620 | 16J6MK4S | 16J6MK4SS | 120 | 120 |
| 1 1/4-11 | 50 | 28.6 | 58 | 48 | 41 | 1050 | 20J6MK4S | 20J6MK4SS | 105 | 105 |

Order codes shown are part of our current manufacturing programme.

Imperial and metric parts may vary in hexagon dimensions.

$$\frac{\text{PN (bar)}}{10} = \text{PN (MPa)}$$

Do not create drawings from these dimensions, they are subject to change and ISO manufacturing allowances.

G4MK4 Female connector

BSPP 60° Cone end (ISO8434-6) / Female BSPP thread (ISO1179-1)

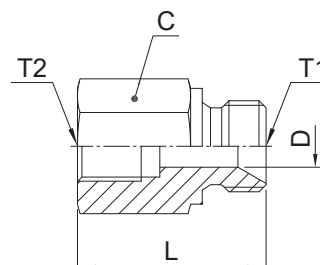

| Thread BSPP T1 | Thread BSPP T2 | C mm | D mm | L mm | Weight (steel) g/1 piece | Adapter Steel | Adapter Stainless Steel | PN (bar) | |
|----------------------|----------------------|---------|---------|---------|--------------------------------|--------------------|----------------------------|----------|-----|
| | | | | | | | | S | SS |
| 1/4-19 | 1/4-19 | 19 | 4.7 | 34 | 47 | 4-4G4MK4S | 4-4G4MK4SS | 350 | 350 |
| 3/8-19 | 1/4-19 | 22 | 7.9 | 36 | 74 | 6G4MK4S | 6G4MK4SS | 350 | 350 |
| 3/8-19 | 3/8-19 | 27 | 7.9 | 35 | 75 | 6-6G4MK4S | 6-6G4MK4SS | 200 | 200 |
| 1/2-14 | 1/4-19 | 27 | 11.1 | 38 | 77 | 8-4G4MK4S | 8-4G4MK4SS | 200 | 200 |
| 1/2-14 | 3/8-19 | 27 | 11.1 | 40 | 102 | 8G4MK4S | 8G4MK4SS | 200 | 200 |
| 1/2-14 | 1/2-14 | 27 | 11.1 | 46 | 120 | 8-8G4MK4S | 8-8G4MK4SS | 200 | 200 |
| 3/4-14 | 1/4-19 | 32 | 16.7 | 40 | 180 | 12-4G4MK4S | 12-4G4MK4SS | 200 | 200 |
| 3/4-14 | 3/8-19 | 32 | 16.7 | 42 | 167 | 12-6G4MK4S | 12-6G4MK4SS | 200 | 200 |
| 3/4-14 | 1/2-14 | 32 | 16.7 | 48 | 209 | 12-8G4MK4S | 12-8G4MK4SS | 200 | 200 |
| 3/4-14 | 3/4-14 | 36 | 16.7 | 46 | 188 | 12G4MK4S | 12G4MK4SS | 200 | 200 |
| 1-11 | 1/4-19 | 41 | 22.2 | 43 | 298 | 16-4G4MK4S | 16-4G4MK4SS | 120 | 120 |
| 1-11 | 3/8-19 | 41 | 22.2 | 45 | 287 | 16-6G4MK4S | 16-6G4MK4SS | 120 | 120 |
| 1-11 | 1/2-14 | 41 | 22.2 | 51 | 275 | 16-8G4MK4S | 16-8G4MK4SS | 120 | 120 |
| 1-11 | 3/4-14 | 41 | 22.2 | 52 | 360 | 16-12G4MK4S | 16-12G4MK4SS | 120 | 120 |

Order codes shown are part of our current manufacturing programme.

Imperial and metric parts may vary in hexagon dimensions.

PN (bar) = PN (MPa)
10

Do not create drawings from these dimensions, they are subject to change and ISO manufacturing allowances.



Adapters

F3MK4 Male stud connector

BSPP 60° Cone end (ISO 8434-6) / Male BSPT thread (ISO 7)

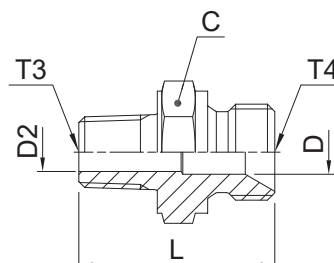

| Thread BSPP T4 | Thread BSPT T3 | C mm | D mm | D2 mm | L mm | Weight (steel) g/1 piece | Adapter Steel | Adapter Stainless Steel | PN (bar) | |
|----------------------|----------------------|---------|---------|----------|---------|--------------------------------|--------------------|----------------------------|----------|-----|
| | | | | | | | | | S | SS |
| 1/8-28 | 1/8-28 | 14 | 3.5 | 3.5 | 25 | 15 | 2F3MK4S | 2F3MK4SS | 315 | 315 |
| 1/8-28 | 1/4-19 | 14 | 3.5 | 7.0 | 29 | 28 | 2-4F3MK4S | 2-4F3MK4SS | 315 | 315 |
| 1/4-19 | 1/4-19 | 19 | 4.7 | 4.7 | 34 | 31 | 4-4F3MK4S | 4-4F3MK4SS | 315 | 315 |
| 1/4-19 | 1/8-28 | 19 | 4.7 | 4.7 | 29 | 27 | 4F3MK4S | 4F3MK4SS | 315 | 315 |
| 1/4-19 | 3/8-19 | 19 | 4.7 | 10.0 | 34 | 44 | 4-6F3MK4S | 4-6F3MK4SS | 315 | 315 |
| 3/8-19 | 3/8-19 | 22 | 7.9 | 7.9 | 35 | 52 | 6-6F3MK4S | 6-6F3MK4SS | 315 | 315 |
| 3/8-19 | 1/2-14 | 22 | 7.9 | 13.5 | 40 | 68 | 6-8F3MK4S | 6-8F3MK4SS | 160 | 160 |
| 3/8-19 | 1/4-19 | 22 | 7.9 | 7.0 | 35 | 48 | 6F3MK4S | 6F3MK4SS | 315 | 315 |
| 1/2-14 | 1/2-14 | 27 | 11.1 | 11.1 | 44 | 79 | 8-8F3MK4S | 8-8F3MK4SS | 160 | 160 |
| 1/2-14 | 3/8-19 | 27 | 11.1 | 10.0 | 39 | 68 | 8F3MK4S | 8F3MK4SS | 200 | 200 |
| 5/8-14 | 1/2-14 | 30 | 14.3 | 13.5 | 46 | 101 | 10F3MK4S | 10F3MK4SS | 200 | 200 |
| 5/8-14 | 3/4-14 | 30 | 14.3 | 14.3 | 47 | 102 | 10-12F3MK4S | 10-12F3MK4SS | 160 | 160 |
| 3/4-14 | 1/2-14 | 32 | 16.7 | 13.5 | 46 | 111 | 12-8F3MK4S | 12-8F3MK4SS | 315 | 315 |
| 3/4-14 | 3/4-14 | 32 | 16.7 | 16.7 | 46 | 126 | 12F3MK4S | 12F3MK4SS | 160 | 160 |
| 3/4-14 | 1-14 | 36 | 16.7 | 24.0 | 51 | 242 | 12-16F3MK4S | 12-16F3MK4SS | 120 | 120 |
| 1-11 | 3/4-14 | 41 | 22.2 | 18.0 | 50 | 173 | 16-12F3MK4S | 16-12F3MK4SS | 120 | 120 |
| 1-11 | 1-11 | 41 | 22.2 | 22.2 | 55 | 219 | 16F3MK4S | 16F3MK4SS | 120 | 120 |
| 1 1/4-11 | 1 1/4-11 | 50 | 28.6 | 32.0 | 64 | 337 | 20F3MK4S | 20F3MK4SS | 105 | 105 |
| 1 1/2-11 | 1 1/2-11 | 55 | 33.3 | 33.3 | 69 | 497 | 24F3MK4S | 24F3MK4SS | 105 | 105 |

Order codes shown are part of our current manufacturing programme.

Imperial and metric parts may vary in hexagon dimensions.

$$\frac{\text{PN (bar)}}{10} = \text{PN (MPa)}$$

Do not create drawings from these dimensions, they are subject to change and ISO manufacturing allowances.

FNMK4 Cap

BSPP 60° Cone female swivel cap end

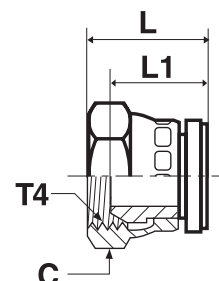

| Thread BSPP T4 | C mm | L mm | L1 mm | Weight (steel) g/1 piece | Adapter Steel | Adapter Stainless Steel | PN (bar) | |
|----------------------|---------|---------|----------|--------------------------------|------------------|----------------------------|----------|-----|
| | | | | | | | S | SS |
| 1/8-28 | 14 | 16 | 11 | 19 | 2FNMK4S | 2FNMK4SS | 350 | 350 |
| 1/4-19 | 19 | 20 | 15 | 23 | 4FNMK4S | 4FNMK4SS | 350 | 350 |
| 3/8-19 | 22 | 22 | 15 | 43 | 6FNMK4S | 6FNMK4SS | 350 | 350 |
| 1/2-14 | 27 | 25 | 18 | 64 | 8FNMK4S | 8FNMK4SS | 200 | 200 |
| 5/8-14 | 30 | 25 | 16 | 80 | 10FNMK4S | 10FNMK4SS | 200 | 200 |
| 3/4-14 | 32 | 26 | 17 | 115 | 12FNMK4S | 12FNMK4SS | 200 | 200 |
| 1-11 | 41 | 30 | 19 | 154 | 16FNMK4S | 16FNMK4SS | 120 | 120 |
| 1 1/4-11 | 50 | 34 | 24 | 345 | 20FNMK4S | 20FNMK4SS | 105 | 105 |
| 1 1/2-11 | 60 | 36 | 23 | 500 | 24FNMK4S | 24FNMK4SS | 105 | 105 |

Order codes shown are part of our current manufacturing programme.

Imperial and metric parts may vary in hexagon dimensions.

$$\frac{\text{PN (bar)}}{10} = \text{PN (MPa)}$$

Do not create drawings from these dimensions, they are subject to change and ISO manufacturing allowances.



Adapters

FMK4 Male stud connector

BSPP 60° Cone end (ISO 8434-6) / Male NPTF* thread (SAE J476)

*Stainless Steel = NPT to prevent galling

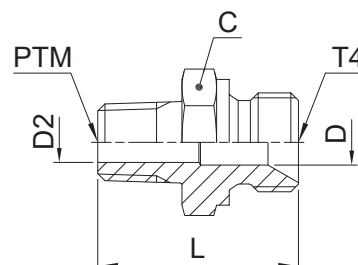

| Thread BSPP T4 | Thread NPT/NPTF PTM | C mm | D mm | D2 mm | L mm | Weight (steel) g/1 piece | Adapter Steel | Adapter Stainless Steel | PN (bar) | |
|----------------------|---------------------------|---------|---------|----------|---------|--------------------------------|-------------------|----------------------------|----------|-----|
| | | | | | | | | | S | SS |
| 1/8-28 | 1/8-28 | 14 | 3.5 | 3.5 | 24 | 17 | 2FMK4S | 2FMK4SS | 350 | 350 |
| 1/8-28 | 1/4-19 | 14 | 3.5 | 3.5 | 29 | 21 | 2-4FMK4S | 2-4FMK4SS | 350 | 350 |
| 1/4-19 | 1/8-28 | 19 | 4.7 | 4.7 | 29 | 24 | 4FMK4S | 4FMK4SS | 350 | 350 |
| 1/4-19 | 1/4-19 | 19 | 4.7 | 4.7 | 33 | 33 | 4-4FMK4S | 4-4FMK4SS | 350 | 350 |
| 1/4-19 | 3/8-19 | 19 | 4.7 | 4.7 | 33 | 41 | 4-6FMK4S | 4-6FMK4SS | 350 | 350 |
| 1/4-19 | 1/2-14 | 22 | 4.7 | 4.7 | 40 | 80 | 4-8FMK4S | 4-8FMK4SS | 350 | 350 |
| 3/8-19 | 1/4-19 | 22 | 7.9 | 7.0 | 35 | 45 | 6FMK4S | 6FMK4SS | 350 | 350 |
| 3/8-19 | 3/8-19 | 22 | 7.9 | 7.9 | 35 | 50 | 6-6FMK4S | 6-6FMK4SS | 350 | 350 |
| 3/8-19 | 1/2-14 | 22 | 7.9 | 7.9 | 40 | 77 | 6-8FMK4S | 6-8FMK4SS | 350 | 350 |
| 1/2-14 | 3/8-19 | 27 | 11.1 | 10.0 | 39 | 48 | 8FMK4S | 8FMK4SS | 200 | 200 |
| 1/2-14 | 1/2-14 | 27 | 11.1 | 11.1 | 43 | 93 | 8-8FMK4S | 8-8FMK4SS | 200 | 200 |
| 1/2-14 | 3/4-14 | 27 | 11.1 | 11.1 | 43 | 95 | 8-12FMK4S | 8-12FMK4SS | 200 | 200 |
| 3/4-14 | 1/2-14 | 32 | 16.7 | 13.5 | 46 | 112 | 12-8FMK4S | 12-8FMK4SS | 200 | 200 |
| 3/4-14 | 3/4-14 | 32 | 16.7 | 16.7 | 46 | 124 | 12FMK4S | 12FMK4SS | 200 | 200 |
| 3/4-14 | 1-11 | 36 | 16.7 | 16.7 | 51 | 150 | 12-16FMK4S | 12-16FMK4SS | 200 | 200 |
| 1-11 | 3/4-14 | 41 | 22.2 | 18.0 | 50 | 188 | 16-12FMK4S | 16-12FMK4SS | 120 | 120 |
| 1-11 | 1-11 | 41 | 22.2 | 22.2 | 55 | 234 | 16FMK4S | 16FMK4SS | 120 | 120 |
| 1 1/4-11 | 1 1/4-11 | 50 | 28.6 | 28.6 | 64 | 360 | 20FMK4S | 20FMK4SS | 105 | 105 |
| 1 1/2-11 | 1 1/2-11 | 55 | 33.3 | 38.0 | 69 | 510 | 24FMK4S | 24FMK4SS | 105 | 105 |

Order codes shown are part of our current manufacturing programme.

Imperial and metric parts may vary in hexagon dimensions.

$\frac{\text{PN (bar)}}{10} = \text{PN (MPa)}$

Do not create drawings from these dimensions, they are subject to change and ISO manufacturing allowances.

GG44M Female thread coupling

Female BSPP thread (ISO 1179-1)

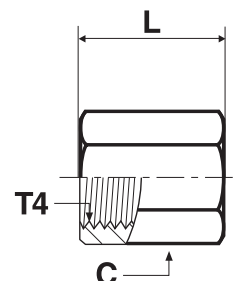

| Thread BSPP T4 | C mm | L mm | Weight (steel) g/1 piece | Adapter Steel | Adapter Stainless Steel | PN (bar) | |
|----------------------|---------|---------|--------------------------------|------------------|----------------------------|----------|-----|
| | | | | | | S | SS |
| 1/8-28 | 14 | 19 | 16 | 1/8GG44MS | 1/8GG44MSS | 420 | 420 |
| 1/4-19 | 17 | 28 | 30 | 1/4GG44MS | 1/4GG44MSS | 420 | 420 |
| 3/8-19 | 22 | 28 | 47 | 3/8GG44MS | 3/8GG44MSS | 420 | 420 |
| 1/2-14 | 27 | 33 | 78 | 1/2GG44MS | 1/2GG44MSS | 350 | 350 |
| 3/4-14 | 32 | 37 | 105 | 3/4GG44MS | 3/4GG44MSS | 280 | 280 |
| 1-11 | 46 | 42 | 341 | 1GG44MS | 1GG44MSS | 210 | 210 |

Order codes shown are part of our current manufacturing programme.

Imperial and metric parts may vary in hexagon dimensions.

$$\frac{\text{PN (bar)}}{10} = \text{PN (MPa)}$$

Do not create drawings from these dimensions, they are subject to change and ISO manufacturing allowances.



Adapters

MMO444M Female thread tee

Female BSPP threads (ISO 1179-1)

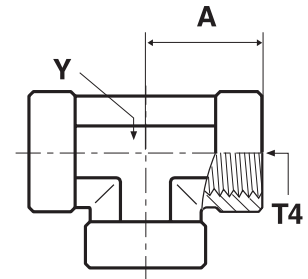

| Thread BSPP T4 | A mm | Y mm | Weight (steel) g/1 piece | Adapter Steel | PN (bar) |
|----------------------|---------|---------|--------------------------------|--------------------|-------------|
| 1/4-19 | 22 | 19 | 74 | 1/4MMO444MS | 350 |
| 3/8-19 | 26 | 22 | 111 | 3/8MMO444MS | 315 |
| 1/2-14 | 31 | 27 | 177 | 1/2MMO444MS | 210 |
| 3/4-14 | 40 | 33 | 294 | 3/4MMO444MS | 210 |
| 1-11 | 46 | 41 | 567 | 1MMO444MS | 120 |

Order codes shown are part of our current manufacturing programme.

Imperial and metric parts may vary in hexagon dimensions.

$$\frac{\text{PN (bar)}}{10} = \text{PN (MPa)}$$

Do not create drawings from these dimensions, they are subject to change and ISO manufacturing allowances.

PTR34M Thread reducer

Male BSPT thread (ISO 7) / Female BSPP thread (ISO 1179-1)

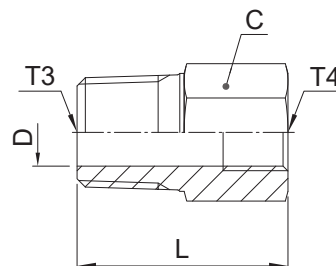

| Thread BSPT T3 | Thread BSPP T4 | C mm | D mm | L mm | Weight (steel) g/1 piece | Adapter Steel | Adapter Stainless Steel | PN (bar) | |
|----------------------|----------------------|---------|---------|---------|--------------------------------|------------------|----------------------------|----------|-----|
| | | | | | | | | S | SS |
| 1/4-19 | 1/8-28 | 14 | 7.0 | 28 | 16 | 1/4X1/8PTR34MS | 1/4X1/8PTR34MSS | 315 | 315 |
| 3/8-19 | 1/4-19 | 19 | 10.0 | 33 | 44 | 3/8X1/4PTR34MS | 3/8X1/4PTR34MSS | 315 | 315 |
| 1/2-14 | 1/4-19 | 22 | 11.7 | 39 | 71 | 1/2X1/4PTR34MS | 1/2X1/4PTR34MSS | 315 | 315 |
| 1/2-14 | 3/8-19 | 22 | 13.5 | 39 | 48 | 1/2X3/8PTR34MS | 1/2X3/8PTR34MSS | 315 | 315 |
| 3/4-14 | 1/4-19 | 27 | 11.7 | 39 | 108 | 3/4X1/4PTR34MS | 3/4X1/4PTR34MSS | 280 | 280 |
| 3/4-14 | 3/8-19 | 27 | 18.0 | 39 | 127 | 3/4X3/8PTR34MS | 3/4X3/8PTR34MSS | 280 | 280 |
| 3/4-14 | 1/2-14 | 27 | 18.0 | 42 | 94 | 3/4X1/2PTR34MS | 3/4X1/2PTR34MSS | 280 | 280 |
| 1-11 | 3/8-19 | 36 | 24.0 | 40 | 185 | 1X3/8PTR34MS | 1X3/8PTR34MSS | 210 | 210 |
| 1-11 | 1/2-14 | 36 | 24.0 | 48 | 224 | 1X1/2PTR34MS | 1X1/2PTR34MSS | 210 | 210 |
| 1-11 | 3/4-14 | 36 | 24.0 | 49 | 186 | 1X3/4PTR34MS | 1X3/4PTR34MSS | 210 | 210 |

Order codes shown are part of our current manufacturing programme.

Imperial and metric parts may vary in hexagon dimensions.

$\frac{\text{PN (bar)}}{10} = \text{PN (MPa)}$

Do not create drawings from these dimensions, they are subject to change and ISO manufacturing allowances.



Adapters

FF33M Male nipple

Male BSPT thread (ISO 7)

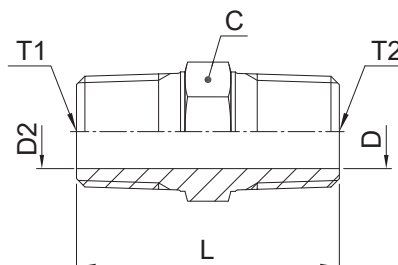

| Thread BSPT T1 | Thread BSPT T2 | C mm | D mm | D2 mm | L mm | Weight (steel) g/1 piece | Adapter Steel | Adapter Stainless Steel | PN (bar) | |
|----------------------|----------------------|---------|---------|----------|---------|--------------------------------|------------------|----------------------------|----------|-----|
| | | | | | | | | | S | SS |
| 1/8-28 | 1/8-28 | 11 | 5.0 | 5.0 | 27 | 12 | 1/8FF33MS | 1/8FF33MSS | 315 | 315 |
| 1/4-19 | 1/8-28 | 14 | 5.0 | 5.0 | 32 | 25 | 1/4X1/8FF33MS | 1/4X1/8FF33MSS | 315 | 315 |
| 1/4-19 | 1/4-19 | 14 | 7.0 | 7.0 | 37 | 25 | 1/4FF33MS | 1/4FF33MSS | 315 | 315 |
| 3/8-19 | 1/4-19 | 17 | 7.0 | 7.0 | 37 | 42 | 3/8X1/4FF33MS | 3/8X1/4FF33MSS | 315 | 315 |
| 3/8-19 | 3/8-19 | 17 | 10.0 | 10.0 | 37 | 30 | 3/8FF33MS | 3/8FF33MSS | 315 | 315 |
| 1/2-14 | 1/4-19 | 22 | 7.0 | 7.0 | 43 | 68 | 1/2X1/4FF33MS | 1/2X1/4FF33MSS | 315 | 315 |
| 1/2-14 | 3/8-19 | 22 | 10.3 | 10.3 | 43 | 67 | 1/2X3/8FF33MS | 1/2X3/8FF33MSS | 315 | 315 |
| 1/2-14 | 1/2-14 | 22 | 13.5 | 13.5 | 48 | 72 | 1/2FF33MS | 1/2FF33MSS | 315 | 315 |
| 3/4-14 | 1/2-14 | 27 | 13.5 | 13.5 | 50 | 123 | 3/4X1/2FF33MS | 3/4X1/2FF33MSS | 160 | 160 |
| 3/4-14 | 3/4-14 | 27 | 18.0 | 18.0 | 50 | 110 | 3/4FF33MS | 3/4FF33MSS | 160 | 160 |
| 1-11 | 3/4-14 | 36 | 18.0 | 18.0 | 55 | 215 | 1X3/4FF33MS | 1X3/4FF33MSS | 160 | 160 |
| 1-11 | 1-11 | 36 | 23.8 | 23.8 | 59 | 190 | 1FF33MS | 1FF33MSS | 160 | 160 |

Order codes shown are part of our current manufacturing programme.

Imperial and metric parts may vary in hexagon dimensions.

$$\frac{\text{PN (bar)}}{10} = \text{PN (MPa)}$$

Do not create drawings from these dimensions, they are subject to change and ISO manufacturing allowances.

HP3M Hexagon head plug

Male BSPT thread (ISO 7)

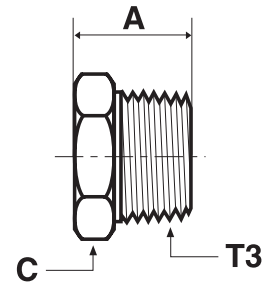

| Thread BSPT T3 | A mm | C mm | Weight (steel) g/1 piece | Adapter Steel | Adapter Stainless Steel | PN (bar) | |
|----------------------|---------|---------|--------------------------------|------------------|----------------------------|----------|-----|
| | | | | | | S | SS |
| 1/8-28 | 14 | 11 | 9 | 1/8HP3MS | 1/8HP3MSS | 315 | 315 |
| 1/4-19 | 19 | 14 | 16 | 1/4HP3MS | 1/4HP3MSS | 315 | 315 |
| 3/8-19 | 20 | 19 | 35 | 3/8HP3MS | 3/8HP3MSS | 315 | 315 |
| 1/2-14 | 25 | 22 | 52 | 1/2HP3MS | 1/2HP3MSS | 315 | 315 |
| 3/4-14 | 27 | 27 | 85 | 3/4HP3MS | 3/4HP3MSS | 160 | 160 |
| 1-11 | 32 | 36 | 134 | 1HP3MS | 1HP3MSS | 160 | 160 |

Order codes shown are part of our current manufacturing programme.

Imperial and metric parts may vary in hexagon dimensions.

$$\frac{\text{PN (bar)}}{10} = \text{PN (MPa)}$$

Do not create drawings from these dimensions, they are subject to change and ISO manufacturing allowances.



Adapters

0107 Swivel male stud

Male NPTF* thread (SAE J476) / NPSM Female swivel end (SAE J516)

SAE 140130

*Stainless Steel = NPT to prevent galling

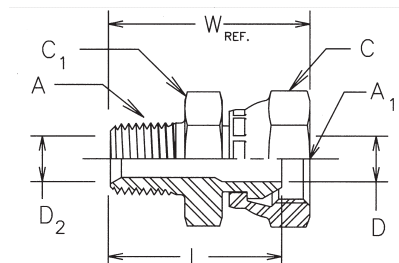

| Thread NPTF A | Thread NPSM A1 | C mm | C1 mm | D mm | D2 mm | L mm | W mm | Weight (steel) g/1 piece | Adapter Steel | Adapter Stainless Steel | PN (bar) | |
|---------------------|----------------------|---------|----------|---------|----------|---------|---------|--------------------------------|------------------|----------------------------|----------|-----|
| | | | | | | | | | | | S | SS |
| 1/8-27 | 1/8-27 | 14.3 | 14.3 | 4.0 | 4.8 | 24 | 28 | 23 | 0107-2-2 | 0107-2-2-SS | 350 | 350 |
| 1/8-27 | 1/4-18 | 17.5 | 16.0 | 4.8 | 4.8 | 27 | 32 | 33 | 0107-2-4 | 0107-2-4-SS | 350 | 350 |
| 1/4-18 | 1/4-18 | 17.5 | 17.5 | 5.6 | 7.1 | 32 | 36 | 40 | 0107-4-4 | 0107-4-4-SS | 350 | 350 |
| 1/4-18 | 3/8-18 | 22.2 | 20.6 | 7.1 | 7.1 | 32 | 37 | 57 | 0107-4-6 | 0107-4-6-SS | 280 | 280 |
| 1/4-18 | 1/2-14 | 25.4 | 23.8 | 11.9 | 7.1 | 37 | 44 | 91 | 0107-4-8 | 0107-4-8-SS | 245 | 245 |
| 3/8-18 | 1/4-18 | 17.5 | 17.5 | 5.6 | 10.3 | 33 | 38 | 48 | 0107-6-4 | 0107-6-4-SS | 350 | 350 |
| 3/8-18 | 3/8-18 | 22.2 | 22.2 | 8.7 | 10.3 | 33 | 38 | 62 | 0107-6-6 | 0107-6-6-SS | 280 | 280 |
| 3/8-18 | 1/2-14 | 25.4 | 23.8 | 10.3 | 10.3 | 37 | 44 | 97 | 0107-6-8 | 0107-6-8-SS | 245 | 245 |
| 1/2-14 | 3/8-18 | 22.2 | 22.2 | 8.7 | 13.5 | 38 | 43 | 76 | 0107-8-6 | 0107-8-6-SS | 280 | 280 |
| 1/2-14 | 1/2-14 | 25.4 | 25.4 | 11.9 | 13.5 | 41 | 49 | 109 | 0107-8-8 | 0107-8-8-SS | 245 | 245 |
| 1/2-14 | 3/4-14 | 31.8 | 31.8 | 13.5 | 13.5 | 43 | 52 | 167 | 0107-8-12 | 0107-8-12-SS | 140 | 140 |
| 3/4-14 | 1/2-14 | 25.4 | 28.6 | 11.9 | 18.3 | 41 | 49 | 122 | 0107-12-8 | 0107-12-8-SS | 245 | 245 |
| 3/4-14 | 3/4-14 | 31.8 | 31.8 | 16.3 | 18.3 | 43 | 52 | 154 | 0107-12-12 | 0107-12-12-SS | 140 | 140 |
| 3/4-14 | 1-11.5 | 38.0 | 38.0 | 21.4 | 18.3 | 46 | 55 | 247 | 0107-12-16 | 0107-12-16-SS | 120 | 120 |
| 1-11.5 | 3/4-14 | 31.8 | 35.0 | 16.3 | 23.8 | 49 | 58 | 217 | 0107-16-12 | 0107-16-12-SS | 140 | 140 |
| 1-11.5 | 1-11.5 | 38.0 | 38.0 | 21.4 | 23.8 | 51 | 60 | 238 | 0107-16-16 | 0107-16-16-SS | 120 | 120 |
| 1-11.5 | 1 1/4-11.5 | 47.6 | 44.5 | 29.0 | 23.8 | 51 | 61 | 298 | 0107-16-20 | 0107-16-20-SS | 120 | 120 |
| 1 1/4-11.5 | 1-11.5 | 38.0 | 47.6 | 21.4 | 31.8 | 53 | 63 | 356 | 0107-20-16 | 0107-20-16-SS | 120 | 120 |
| 1 1/4-11.5 | 1 1/4-11.5 | 47.6 | 47.6 | 29.0 | 31.8 | 53 | 63 | 390 | 0107-20-20 | 0107-20-20-SS | 120 | 120 |
| 1 1/2-11.5 | 1 1/2-11.5 | 54.0 | 54.0 | 34.5 | 38.1 | 56 | 66 | 498 | 0107-24-24 | 0107-24-24-SS | 85 | 85 |
| 2-11.5 | 2-11.5 | 66.7 | 66.7 | 46.1 | 49.2 | 60 | 71 | 749 | 0107-32-32 | 0107-32-32-SS | 75 | 75 |

Order codes shown are part of our current manufacturing programme.

Imperial and metric parts may vary in hexagon dimensions.

PN (bar) = PN (MPa)
10

Do not create drawings from these dimensions, they are subject to change and ISO manufacturing allowances.

2107 Swivel male elbow

Male NPTF* thread (SAE J476) / NPSM Female swivel end (SAE J516)

SAE 140230

*Stainless Steel = NPT to prevent galling

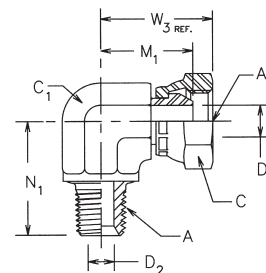

| Thread NPTF A | Thread NPSM A1 | C mm | C1 mm | D mm | D2 mm | M1 mm | N1 mm | W3 mm | Weight (steel) g/1 piece | Adapter Steel | Adapter Stainless Steel | PN (bar) | |
|---------------------|----------------------|---------|----------|---------|----------|----------|----------|----------|--------------------------------|-------------------|----------------------------|----------|-----|
| | | | | | | | | | | | | S | SS |
| 1/8-27 | 1/8-27 | 14.3 | 11.0 | 4.0 | 4.8 | 18 | 18 | 22 | 28 | 2107-2-2 | 2107-2-2-SS | 350 | 350 |
| 1/4-18 | 1/4-18 | 17.5 | 14.0 | 5.6 | 7.1 | 22 | 28 | 27 | 55 | 2107-4-4 | 2107-4-4-SS | 350 | 350 |
| 1/4-18 | 3/8-18 | 22.2 | 19.0 | 8.7 | 7.1 | 25 | 28 | 33 | 94 | 2107-4-6 | 2107-4-6-SS | 280 | 280 |
| 3/8-18 | 1/4-18 | 17.5 | 19.0 | 5.6 | 10.3 | 25 | 31 | 30 | 88 | 2107-6-4 | 2107-6-4-SS | 350 | 350 |
| 3/8-18 | 3/8-18 | 22.2 | 19.0 | 8.7 | 10.3 | 25 | 31 | 33 | 90 | 2107-6-6 | 2107-6-6-SS | 280 | 280 |
| 3/8-18 | 1/2-14 | 25.4 | 19.0 | 11.9 | 10.3 | 26 | 31 | 34 | 107 | 2107-6-8 | 2107-6-8-SS | 245 | 245 |
| 1/2-14 | 3/8-18 | 22.2 | 22.0 | 8.7 | 13.5 | 27 | 37 | 34 | 130 | 2107-8-6 | 2107-8-6-SS | 280 | 280 |
| 1/2-14 | 1/2-14 | 25.4 | 22.0 | 11.9 | 13.5 | 28 | 37 | 36 | 139 | 2107-8-8 | 2107-8-8-SS | 245 | 245 |
| 1/2-14 | 3/4-14 | 31.8 | 27.0 | 16.3 | 13.5 | 33 | 37 | 42 | 221 | 2107-8-12 | 2107-8-12-SS | 140 | 140 |
| 3/4-14 | 3/8-18 | 22.2 | 27.0 | 8.7 | 18.3 | 30 | 40 | 38 | 227 | 2107-12-6 | 2107-12-6-SS | 280 | 280 |
| 3/4-14 | 1/2-14 | 25.4 | 27.0 | 11.9 | 18.3 | 32 | 40 | 39 | 191 | 2107-12-8 | 2107-12-8-SS | 245 | 245 |
| 3/4-14 | 3/4-14 | 31.8 | 27.0 | 16.3 | 18.3 | 33 | 40 | 42 | 225 | 2107-12-12 | 2107-12-12-SS | 140 | 140 |
| 1-11.5 | 3/4-14 | 31.8 | 33.3 | 16.3 | 23.8 | 37 | 50 | 46 | 374 | 2107-16-12 | 2107-16-12-SS | 140 | 140 |
| 1-11.5 | 1-11.5 | 38.0 | 33.3 | 21.4 | 23.8 | 39 | 50 | 49 | 361 | 2107-16-16 | 2107-16-16-SS | 120 | 120 |
| 1 1/4-11.5 | 1 1/4-11.5 | 47.6 | 41.0 | 29.0 | 31.8 | 44 | 61 | 54 | 794 | 2107-20-20 | 2107-20-20-SS | 120 | 120 |
| 1 1/2-11.5 | 1 1/2-11.5 | 54.0 | 47.6 | 34.5 | 38.1 | 48 | 67 | 59 | 782 | 2107-24-24 | 2107-24-24-SS | 85 | 85 |
| 2-11.5 | 2-11.5 | 66.7 | 63.5 | 46.1 | 49.2 | 58 | 76 | 69 | 1910 | 2107-32-32 | 2107-32-32-SS | 75 | 75 |

Order codes shown are part of our current manufacturing programme.

Imperial and metric parts may vary in hexagon dimensions.

$$\frac{\text{PN (bar)}}{10} = \text{PN (MPa)}$$

Do not create drawings from these dimensions, they are subject to change and ISO manufacturing allowances.



Adapters

3107 Swivel male 45° elbow

Male NPTF* thread (SAE J476) / NPSM Female swivel end (SAE J516)

SAE 140330

*Stainless Steel = NPT to prevent galling

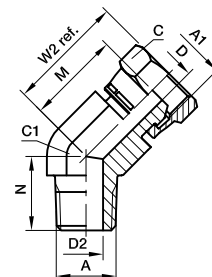

| Thread NPTF A | Thread NPSM A1 | C mm | C1 mm | D mm | D2 mm | M mm | N mm | W2 mm | Weight (steel) g/1 piece | Adapter Steel | Adapter Stainless Steel | PN (bar) | |
|---------------------|----------------------|---------|----------|---------|----------|---------|---------|----------|--------------------------------|-------------------|----------------------------|----------|-----|
| | | | | | | | | | | | | S | SS |
| 1/8-27 | 1/8-27 | 14.3 | 11.0 | 4.0 | 4.8 | 16 | 13 | 20 | 21 | 3107-2-2 | | 350 | — |
| 1/4-18 | 1/4-18 | 17.5 | 14.0 | 5.6 | 7.1 | 19 | 22 | 23 | 44 | 3107-4-4 | 3107-4-4-SS | 350 | 350 |
| 3/8-18 | 3/8-18 | 22.2 | 19.0 | 8.7 | 10.3 | 21 | 24 | 28 | 80 | 3107-6-6 | 3107-6-6-SS | 280 | 280 |
| 1/2-14 | 3/8-18 | 22.2 | 22.0 | 8.7 | 13.5 | 21 | 30 | 28 | 110 | 3107-8-6 | 3107-8-6-SS | 280 | 280 |
| 1/2-14 | 1/2-14 | 25.4 | 22.0 | 11.9 | 13.5 | 22 | 30 | 30 | 114 | 3107-8-8 | 3107-8-8-SS | 245 | 245 |
| 1/2-14 | 3/4-14 | 31.8 | 27.0 | 16.3 | 13.5 | 23 | 38 | 31 | 144 | 3107-8-12 | 3107-8-12-SS | 140 | 140 |
| 3/4-14 | 1/2-14 | 25.4 | 27.0 | 11.9 | 18.3 | 24 | 31 | 31 | 153 | 3107-12-8 | 3107-12-8-SS | 245 | 245 |
| 3/4-14 | 3/4-14 | 31.8 | 27.0 | 16.3 | 18.3 | 26 | 31 | 35 | 172 | 3107-12-12 | 3107-12-12-SS | 140 | 140 |
| 1-11.5 | 3/4-14 | 31.8 | 33.3 | 16.3 | 23.8 | 28 | 38 | 37 | 245 | 3107-16-12 | 3107-16-12-SS | 140 | 140 |
| 1-11.5 | 1-11.5 | 38.0 | 33.3 | 21.4 | 23.8 | 29 | 38 | 39 | 368 | 3107-16-16 | 3107-16-16-SS | 120 | 120 |
| 1 1/4-11.5 | 1 1/4-11.5 | 47.6 | 41.0 | 29.0 | 31.8 | 31 | 42 | 41 | 619 | 3107-20-20 | 3107-20-20-SS | 120 | 120 |
| 1 1/2-11.5 | 1 1/2-11.5 | 54.0 | 47.6 | 34.5 | 38.1 | 34 | 45 | 45 | 719 | 3107-24-24 | 3107-24-24-SS | 85 | 85 |
| 2-11.5 | 2-11.5 | 66.7 | 63.5 | 46.1 | 49.2 | 37 | 54 | 48 | 1372 | 3107-32-32 | 3107-32-32-SS | 75 | 75 |

Order codes shown are part of our current manufacturing programme.

Imperial and metric parts may vary in hexagon dimensions.

$$\frac{\text{PN (bar)}}{10} = \text{PN (MPa)}$$

Do not create drawings from these dimensions, they are subject to change and ISO manufacturing allowances.

0207 Female connector

Female NPTF* thread (SAE J476) / NPSM Female swivel end (SAE J516)

SAE 140131

*Stainless Steel = NPT to prevent galling

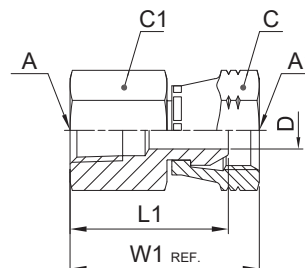

| Thread NPTF A | Thread NPSM A1 | C mm | C1 mm | D mm | L1 mm | W1 mm | Weight (steel) g/1 piece | Adapter Steel | Adapter Stainless Steel | PN (bar) | |
|---------------------|----------------------|---------|----------|---------|----------|----------|--------------------------------|-------------------|----------------------------|----------|-----|
| | | | | | | | | | | S | SS |
| 1/8-27 | 1/8-27 | 14.3 | 14.3 | 4.0 | 22 | 26 | 15 | 0207-2-2 | 0207-2-2-SS | 350 | 350 |
| 1/4-18 | 1/4-18 | 17.5 | 17.5 | 5.6 | 32 | 36 | 44 | 0207-4-4 | 0207-4-4-SS | 350 | 350 |
| 3/8-18 | 1/4-18 | 17.5 | 22.2 | 5.6 | 33 | 38 | 52 | 0207-6-4 | 0207-6-4-SS | 350 | 350 |
| 3/8-18 | 3/8-18 | 22.2 | 22.2 | 8.7 | 33 | 38 | 81 | 0207-6-6 | 0207-6-6-SS | 280 | 280 |
| 1/2-14 | 3/8-18 | 22.2 | 25.4 | 8.7 | 39 | 44 | 121 | 0207-8-6 | 0207-8-6-SS | 280 | 280 |
| 1/2-14 | 1/2-14 | 25.4 | 25.4 | 11.9 | 38 | 46 | 119 | 0207-8-8 | 0207-8-8-SS | 245 | 245 |
| 3/4-14 | 3/4-14 | 31.8 | 31.8 | 16.3 | 41 | 50 | 161 | 0207-12-12 | 0207-12-12-SS | 140 | 140 |
| 1-11.5 | 1-11.5 | 38.0 | 38.0 | 21.4 | 51 | 60 | 162 | 0207-16-16 | 0207-16-16-SS | 120 | 120 |
| 1 1/4-11.5 | 1 1/4-11.5 | 47.6 | 47.6 | 29.0 | 51 | 61 | 378 | 0207-20-20 | 0207-20-20-SS | 120 | 120 |
| 1 1/2-11.5 | 1 1/2-11.5 | 54.0 | 54.0 | 34.5 | 51 | 62 | 446 | 0207-24-24 | 0207-24-24-SS | 85 | 85 |
| 2-11.5 | 2-11.5 | 66.7 | 66.7 | 46.1 | 54 | 65 | 707 | 0207-32-32 | 0207-32-32-SS | 75 | 75 |

Order codes shown are part of our current manufacturing programme.

Imperial and metric parts may vary in hexagon dimensions.

$\frac{PN \text{ (bar)}}{10} = PN \text{ (MPa)}$

Do not create drawings from these dimensions, they are subject to change and ISO manufacturing allowances.



Adapters

2207 Female elbow

Female NPTF* thread (SAE J476) / NPSM Female swivel end (SAE J516)

SAE 140231

*Stainless Steel = NPT to prevent galling

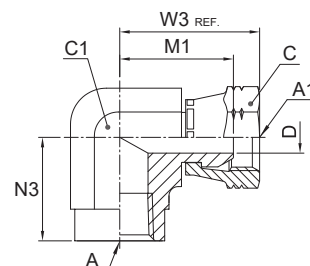

| Thread NPTF A | Thread NPSM A1 | C mm | C1 mm | D mm | M1 mm | W3 mm | N3 mm | Weight (steel) g/1 piece | Adapter Steel | Adapter Stainless Steel | PN (bar) | |
|---------------------|----------------------|---------|----------|---------|----------|----------|----------|--------------------------------|-------------------|----------------------------|----------|-----|
| | | | | | | | | | | | S | SS |
| 1/8-27 | 1/8-27 | 14.3 | 14.0 | 4.0 | 20 | 24 | 17 | 37 | 2207-2-2 | 2207-2-2-SS | 350 | 350 |
| 1/4-18 | 1/4-18 | 17.5 | 19.0 | 5.6 | 25 | 30 | 22 | 98 | 2207-4-4 | 2207-4-4-SS | 350 | 350 |
| 3/8-18 | 3/8-18 | 22.2 | 22.0 | 8.7 | 27 | 32 | 26 | 152 | 2207-6-6 | 2207-6-6-SS | 280 | 280 |
| 1/2-14 | 1/2-14 | 25.4 | 27.0 | 11.9 | 32 | 39 | 31 | 246 | 2207-8-8 | 2207-8-8-SS | 245 | 245 |
| 3/4-14 | 3/4-14 | 31.8 | 33.3 | 16.3 | 37 | 46 | 35 | 313 | 2207-12-12 | 2207-12-12-SS | 140 | 140 |
| 1-11.5 | 1-11.5 | 38.0 | 41.0 | 21.4 | 44 | 53 | 41 | 530 | 2207-16-16 | 2207-16-16-SS | 120 | 120 |
| 1 1/4-11.5 | 1 1/4-11.5 | 47.6 | 47.6 | 29.0 | 47 | 56 | 43 | 1159 | 2207-20-20 | 2207-20-20-SS | 120 | 120 |
| 1 1/2-11.5 | 1 1/2-11.5 | 54.0 | 63.5 | 34.5 | 61 | 72 | 53 | 1679 | 2207-24-24 | 2207-24-24-SS | 85 | 85 |
| 2-11.5 | 2-11.5 | 66.7 | 71.5 | 46.1 | 65 | 76 | 61 | 2136 | 2207-32-32 | 2207-32-32-SS | 75 | 75 |

Order codes shown are part of our current manufacturing programme.

Imperial and metric parts may vary in hexagon dimensions.

$$\frac{\text{PN (bar)}}{10} = \text{PN (MPa)}$$

Do not create drawings from these dimensions, they are subject to change and ISO manufacturing allowances.

0507 Swivel male stud

Male UN/UNF thread O-ring (ISO 11926) / NPSM Female swivel end (SAE J516)
SAE 140157

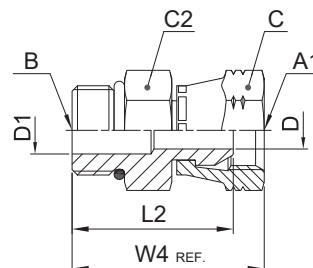

| Thread UN/UNF-2A B | Thread NPSM A1 | C mm | C2 mm | D mm | D1 mm | L2 mm | W4 mm | Weight (steel) g/1 piece | Adapter Steel | PN (bar) |
|--------------------------|----------------------|---------|----------|---------|----------|----------|----------|--------------------------------|-------------------|-------------|
| 7/16-20 | 1/4-18 | 17.5 | 14.3 | 5.6 | 5.6 | 29 | 34 | 32 | 0507-4-4 | 350 |
| 9/16-18 | 1/4-18 | 17.5 | 17.5 | 5.6 | 5.6 | 30 | 34 | 45 | 0507-6-4 | 350 |
| 9/16-18 | 3/8-18 | 22.2 | 17.5 | 8.7 | 8.7 | 30 | 35 | 48 | 0507-6-6 | 280 |
| 9/16-18 | 1/2-14 | 25.4 | 19.0 | 7.5 | 7.5 | 33 | 40 | 76 | 0507-6-8 | 245 |
| 3/4-16 | 1/4-18 | 17.5 | 22.2 | 5.6 | 9.9 | 32 | 36 | 65 | 0507-8-4 | 350 |
| 3/4-16 | 3/8-18 | 22.2 | 22.2 | 8.7 | 8.7 | 32 | 37 | 69 | 0507-8-6 | 280 |
| 3/4-16 | 1/2-14 | 25.4 | 22.2 | 9.9 | 9.9 | 32 | 40 | 83 | 0507-8-8 | 245 |
| 3/4-16 | 3/4-14 | 31.8 | 25.4 | 16.3 | 9.9 | 37 | 46 | 137 | 0507-8-12 | 140 |
| 7/8-14 | 1/2-14 | 25.4 | 25.4 | 11.9 | 11.9 | 37 | 44 | 98 | 0507-10-8 | 245 |
| 1 1/16-12 | 1/2-14 | 25.4 | 31.8 | 11.9 | 11.9 | 40 | 48 | 157 | 0507-12-8 | 245 |
| 1 1/16-12 | 3/4-14 | 31.8 | 31.8 | 16.3 | 16.3 | 41 | 50 | 200 | 0507-12-12 | 140 |
| 1 5/16-12 | 1-11.5 | 38.0 | 38.0 | 21.4 | 21.4 | 45 | 54 | 317 | 0507-16-16 | 120 |
| 1 5/8-12 | 1 1/4-11.5 | 47.6 | 47.6 | 27.4 | 27.4 | 47 | 56 | 398 | 0507-20-20 | 120 |
| 1 7/8-12 | 1 1/2-11.5 | 54.0 | 54.0 | 33.3 | 33.3 | 50 | 61 | 498 | 0507-24-24 | 85 |
| 2 1/2-12 | 2-11.5 | 66.7 | 70.0 | 45.2 | 45.2 | 52 | 63 | 749 | 0507-32-32 | 75 |

Parker Adapter are delivered with NBR elastomeric seals as standard. For more details on other seal materials see page O60.

Order codes shown are part of our current manufacturing programme.

Imperial and metric parts may vary in hexagon dimensions.

$$\frac{\text{PN (bar)}}{10} = \text{PN (MPa)}$$

Do not create drawings from these dimensions, they are subject to change and ISO manufacturing allowances.



Adapters

2507 Swivel male elbow

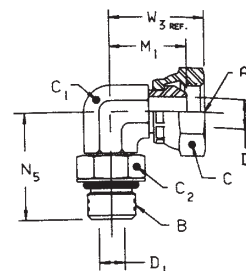
 Male UN/UNF thread O-ring (ISO 11926) / NPSM Female swivel end (SAE J516)
 SAE 140257

| Thread UN/UNF-2A B | Thread NPSM A1 | C mm | C1 mm | C2 mm | D mm | D1 mm | M1 mm | W3 mm | N5 mm | Weight (steel) g/1 piece | Adapter Steel | PN (bar) |
|--------------------------|----------------------|---------|----------|----------|---------|----------|----------|----------|----------|--------------------------------|-------------------|-------------|
| 7/16-20 | 1/4-18 | 17.5 | 11.0 | 14.3 | 5.6 | 4.4 | 20 | 25 | 26 | 42 | 2507-4-4 | 350 |
| 9/16-18 | 1/4-18 | 17.5 | 14.0 | 17.6 | 5.6 | 7.5 | 22 | 27 | 31 | 56 | 2507-6-4 | 350 |
| 9/16-18 | 3/8-18 | 22.2 | 14.0 | 17.6 | 8.7 | 7.5 | 22 | 28 | 31 | 56 | 2507-6-6 | 280 |
| 9/16-18 | 1/2-14 | 19.0 | 19.0 | 17.6 | 11.9 | 7.5 | 26 | 34 | 36 | 65 | 2507-6-8 | 245 |
| 3/4-16 | 3/8-18 | 22.2 | 19.0 | 22.2 | 8.7 | 9.9 | 25 | 30 | 37 | 119 | 2507-8-6 | 280 |
| 3/4-16 | 1/2-14 | 25.4 | 19.0 | 22.2 | 11.9 | 9.9 | 26 | 34 | 37 | 119 | 2507-8-8 | 245 |
| 3/4-16 | 3/4-14 | 31.8 | 27.0 | 22.2 | 16.0 | 9.9 | 33 | 42 | 41 | 174 | 2507-8-12 | 140 |
| 7/8-14 | 3/8-18 | 22.2 | 22.0 | 25.4 | 8.7 | 12.3 | 27 | 32 | 43 | 164 | 2507-10-6 | 280 |
| 7/8-14 | 1/2-14 | 25.4 | 22.0 | 25.4 | 11.9 | 12.3 | 28 | 36 | 43 | 178 | 2507-10-8 | 245 |
| 7/8-14 | 3/4-14 | 31.8 | 27.0 | 25.4 | 16.3 | 12.3 | 33 | 42 | 45 | 243 | 2507-10-12 | 140 |
| 1 1/16-12 | 1/2-14 | 25.4 | 27.0 | 31.8 | 11.9 | 15.5 | 31 | 38 | 49 | 193 | 2507-12-8 | 245 |
| 1 1/16-12 | 3/4-14 | 31.8 | 27.0 | 31.8 | 16.3 | 15.5 | 33 | 42 | 49 | 283 | 2507-12-12 | 140 |
| 1 5/16-12 | 1-11.5 | 38.0 | 33.3 | 38.0 | 21.4 | 21.4 | 39 | 49 | 53 | 525 | 2507-16-16 | 120 |
| 1 5/8-12 | 1 1/4-11.5 | 47.6 | 41.3 | 47.6 | 29.0 | 27.4 | 45 | 55 | 57 | 530 | 2507-20-20 | 120 |
| 1 7/8-12 | 1 1/2-11.5 | 54.0 | 47.6 | 54.0 | 34.5 | 33.3 | 48 | 59 | 61 | 600 | 2507-24-24 | 85 |

Parker Adapter are delivered with NBR elastomeric seals as standard. For more details on other seal materials see page O60.

Order codes shown are part of our current manufacturing programme.

Imperial and metric parts may vary in hexagon dimensions.

$$\frac{\text{PN (bar)}}{10} = \text{PN (MPa)}$$

Do not create drawings from these dimensions, they are subject to change and ISO manufacturing allowances.

3507 Swivel male 45° elbow

Male UN/UNF thread O-ring (ISO 11926) / NPSM Female swivel end (SAE J516)
SAE 140357

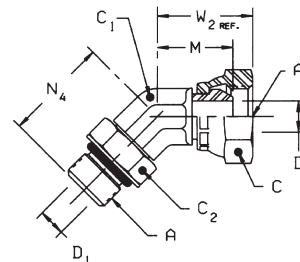

| Thread UN/UNF-2A A | Thread NPSM A1 | C mm | C1 mm | C2 mm | D mm | D1 mm | M mm | W2 mm | N4 mm | Weight (steel) g/1 piece | Adapter Steel | PN (bar) |
|--------------------------|----------------------|---------|----------|----------|---------|----------|---------|----------|----------|--------------------------------|-------------------|-------------|
| 7/16-20 | 1/4-18 | 17.5 | 11.0 | 14.3 | 5.6 | 4.4 | 16 | 20 | 27 | 41 | 3507-4-4 | 350 |
| 9/16-18 | 3/8-18 | 22.2 | 14.0 | 17.5 | 8.7 | 7.5 | 21 | 26 | 29 | 62 | 3507-6-6 | 280 |
| 3/4-16 | 3/8-18 | 22.2 | 19.0 | 22.2 | 8.7 | 9.9 | 21 | 26 | 33 | 106 | 3507-8-6 | 280 |
| 3/4-16 | 1/2-14 | 25.4 | 19.0 | 22.2 | 11.9 | 9.9 | 21 | 30 | 33 | 141 | 3507-8-8 | 245 |
| 3/4-16 | 3/4-14 | 31.8 | 27.0 | 22.2 | 16.3 | 9.9 | 26 | 35 | 36 | 226 | 3507-8-12 | 140 |
| 7/8-14 | 1/2-14 | 25.4 | 22.0 | 25.4 | 11.9 | 12.3 | 22 | 30 | 39 | 154 | 3507-10-8 | 245 |
| 1 1/16-12 | 3/4-14 | 31.8 | 27.0 | 31.8 | 16.3 | 15.5 | 26 | 35 | 44 | 208 | 3507-12-12 | 140 |
| 1 5/16-12 | 1-11.5 | 38.0 | 33.3 | 38.0 | 21.4 | 21.4 | 29 | 39 | 47 | 408 | 3507-16-16 | 120 |

Parker Adapter are delivered with NBR elastomeric seals as standard. For more details on other seal materials see page O60.

Order codes shown are part of our current manufacturing programme.

Imperial and metric parts may vary in hexagon dimensions.

$$\frac{\text{PN (bar)}}{10} = \text{PN (MPa)}$$

Do not create drawings from these dimensions, they are subject to change and ISO manufacturing allowances.



Adapters

F3T4 Male stud connector

JIS BSPP 60° cone adapters (JIS B8363) / Male BSPT thread (ISO 7)

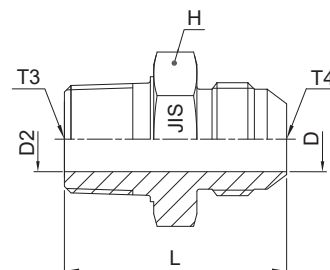

| Thread BSPP T4 | Thread BSPT T3 | D mm | D2 mm | H mm | L mm | Weight (steel) g/1 piece | Adapter Steel | Adapter Stainless Steel | PN (bar) | |
|----------------------|----------------------|---------|----------|---------|---------|--------------------------------|------------------|----------------------------|----------|-----|
| | | | | | | | | | S | SS |
| 1/4-19 | 1/4-19 | 4.5 | 4.5 | 19.0 | 37 | 41 | 4F3T4S | 4F3MT4SS | 315 | 315 |
| 1/4-19 | 3/8-19 | 4.5 | 4.5 | 22.2 | 38 | 61 | 4-6F3T4S | 4-6F3MT4SS | 315 | 315 |
| 3/8-19 | 1/4-19 | 7.0 | 7.0 | 22.2 | 40 | 57 | 6-4F3T4S | 6-4F3MT4SS | 315 | 315 |
| 3/8-19 | 3/8-19 | 7.0 | 7.0 | 22.2 | 40 | 66 | 6F3T4S | 6F3MT4SS | 315 | 315 |
| 1/2-14 | 3/8-19 | 10.3 | 10.3 | 27.0 | 43 | 88 | 8-6F3T4S | 8-6F3MT4SS | 315 | 315 |
| 1/2-14 | 1/2-14 | 11.0 | 11.0 | 27.0 | 48 | 105 | 8F3T4S | 8F3MT4SS | 315 | 200 |
| 3/4-14 | 3/4-14 | 15.9 | 15.9 | 36.5 | 53 | 334 | 12F3T4S | 12F3MT4SS | 160 | 160 |
| 1-11 | 1-11 | 21.0 | 21.0 | 41.3 | 58 | 268 | 16F3T4S | 16F3MT4SS | 120 | 120 |

Order codes shown are part of our current manufacturing programme.

Imperial and metric parts may vary in hexagon dimensions.

$$\frac{\text{PN (bar)}}{10} = \text{PN (MPa)}$$

Do not create drawings from these dimensions, they are subject to change and ISO manufacturing allowances.

C3T4 Male elbow

JIS BSPP 60° cone adapters (JIS B8363) / Male BSPT thread (ISO 7)

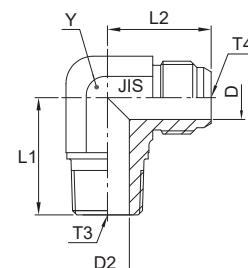

| Thread BSPP T4 | Thread BSPT T3 | D mm | D2 mm | L1 mm | L2 mm | Y mm | Weight (steel) g/1 piece | Adapter Steel | PN (bar) |
|----------------------|----------------------|---------|----------|----------|----------|---------|--------------------------------|------------------|-------------|
| 1/4-19 | 1/4-19 | 4.5 | 4.5 | 25 | 25 | 14.0 | 41 | 4C3T4S | 315 |
| 3/8-19 | 3/8-19 | 7.0 | 7.0 | 30 | 29 | 19.0 | 74 | 6C3T4S | 315 |
| 1/2-14 | 1/2-14 | 11.0 | 11.0 | 36 | 34 | 22.0 | 131 | 8C3T4S | 200 |
| 3/4-14 | 3/4-14 | 15.9 | 15.9 | 43 | 38 | 27.0 | 146 | 12C3T4S | 160 |
| 1-11 | 1-11 | 21.0 | 21.0 | 50 | 44 | 33.3 | 398 | 16C3T4S | 120 |

Do not create drawings from these dimensions, they are subject to change and ISO manufacturing allowances.

V3T4 Male 45° elbow

JIS BSPP 30° Flare end (JIS B8363) / Male BSPT thread (ISO 7)

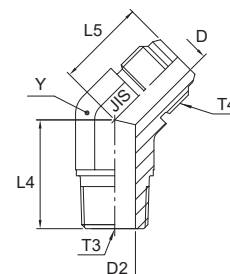

| Thread BSPP T4 | Thread BSPT T3 | D mm | D2 mm | L4 mm | L5 mm | Y mm | Weight (steel) g/1 piece | Adapter Steel | PN (bar) |
|----------------------|----------------------|---------|----------|----------|----------|---------|--------------------------------|------------------|-------------|
| 1/4-19 | 1/4-19 | 4.5 | 4.5 | 19 | 22 | 14.0 | 33 | 4V3T4S | 315 |
| 3/8-19 | 3/8-19 | 7.0 | 7.0 | 22 | 25 | 19.0 | 64 | 6V3T4S | 315 |
| 1/2-14 | 1/2-14 | 11.0 | 11.0 | 27 | 28 | 22.0 | 112 | 8V3T4S | 200 |
| 3/4-14 | 3/4-14 | 15.9 | 15.9 | 30 | 32 | 27.0 | 162 | 12V3T4S | 160 |
| 1-11 | 1-11 | 21.0 | 21.0 | 35 | 32 | 33.3 | 256 | 16V3T4S | 120 |

Order codes shown are part of our current manufacturing programme.
Imperial and metric parts may vary in hexagon dimensions.

$$\frac{\text{PN (bar)}}{10} = \text{PN (MPa)}$$

Do not create drawings from these dimensions, they are subject to change and ISO manufacturing allowances.

Adapters

HP4 Union

JIS BSPP 60° cone end (JIS B8363)

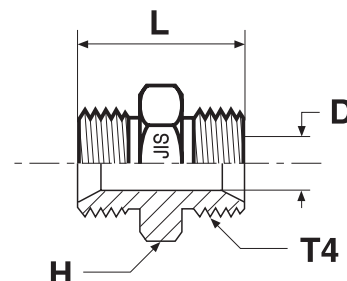

| Thread BSPP T4 | D mm | H mm | L mm | Weight (steel) g/1 piece | Adapter Steel | PN (bar) | | |
|----------------------|---------|---------|---------|--------------------------------|------------------|----------------------------|-----|-----|
| | | | | | | Adapter Stainless Steel | S | SS |
| 1/4-19 | 4.5 | 19.0 | 34 | 40 | 4HP4S | 4HMP4SS | 350 | 350 |
| 3/8-19 | 7.0 | 22.2 | 38 | 91 | 6HP4S | 6HMP4SS | 350 | 350 |
| 1/2-14 | 11.0 | 27.0 | 46 | 159 | 8HP4S | 8HMP4SS | 200 | 200 |
| 3/4-14 | 15.9 | 36.5 | 52 | 186 | 12HP4S | 12HMP4SS | 200 | 200 |
| 1-11 | 21.0 | 41.3 | 58 | 290 | 16HP4S | 16HMP4SS | 120 | 120 |

Do not create drawings from these dimensions, they are subject to change and ISO manufacturing allowances.

HP46 Swivel female union

JIS BSPP 60° Cone swivel female end (JIS B8363)

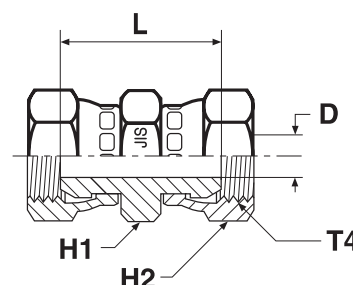

| Thread BSPP T4 | D mm | H1 mm | H2 mm | L mm | Weight (steel) g/1 piece | Adapter Steel | PN (bar) |
|----------------------|---------|----------|----------|---------|--------------------------------|------------------|-------------|
| | | | | | | | |
| 3/8-19 | 7.0 | 22.2 | 22.2 | 35 | 49 | 6HP46S | 350 |
| 1/2-14 | 11.0 | 27.0 | 27.0 | 38 | 77 | 8HP46S | 200 |
| 3/4-14 | 15.9 | 36.5 | 36.5 | 40 | 114 | 12HP46S | 200 |
| 1-11 | 21.0 | 41.3 | 41.3 | 46 | 180 | 16HP46S | 120 |

Order codes shown are part of our current manufacturing programme.
Imperial and metric parts may vary in hexagon dimensions.

$$\frac{\text{PN (bar)}}{10} = \text{PN (MPa)}$$

Do not create drawings from these dimensions, they are subject to change and ISO manufacturing allowances.

F3P4 Male stud connector

JIS BSPP 60° Cone end (JIS B8363) / Male BSPT thread (ISO 7)

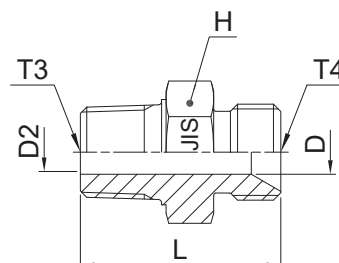

| Thread BSPP T4 | Thread BSPT T3 | D mm | D2 mm | H mm | L mm | Weight (steel) g/1 piece | Adapter Steel | Adapter Stainless Steel | PN (bar) | |
|----------------------|----------------------|---------|----------|---------|---------|--------------------------------|------------------|----------------------------|----------|-----|
| | | | | | | | | | S | SS |
| 1/4-19 | 1/4-19 | 4.5 | 4.5 | 19.0 | 37 | 47 | 4F3P4S | 4F3MP4SS | 315 | 315 |
| 3/8-19 | 3/8-19 | 7.0 | 7.0 | 22.2 | 38 | 67 | 6F3P4S | 6F3MP4SS | 315 | 315 |
| 1/2-14 | 1/2-14 | 11.0 | 11.0 | 27.0 | 46 | 109 | 8F3P4S | 8F3MP4SS | 200 | 200 |
| 3/4-14 | 3/4-14 | 15.9 | 15.9 | 36.5 | 52 | 195 | 12F3P4S | 12F3MP4SS | 160 | 160 |
| 1-11 | 1-11 | 21.0 | 21.0 | 41.3 | 58 | 292 | 16F3P4S | 16F3MP4SS | 120 | 120 |

Do not create drawings from these dimensions, they are subject to change and ISO manufacturing allowances.

C3P4 Male 90° elbow

JIS BSPP 60° cone end (JIS B8363) / Male BSPT thread (ISO 7)

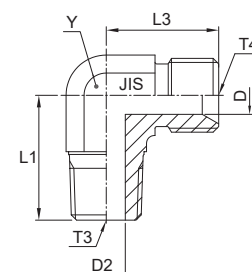

| Thread BSPP T4 | Thread BSPT T3 | D mm | D2 mm | L1 mm | L3 mm | Y mm | Weight (steel) g/1 piece | Adapter Steel | PN (bar) |
|----------------------|----------------------|---------|----------|----------|----------|---------|--------------------------------|------------------|-------------|
| | | | | | | | | | |
| 3/8-19 | 3/8-19 | 7.0 | 7.0 | 30 | 29 | 19.0 | 97 | 6C3P4S | 315 |
| 1/2-14 | 1/2-14 | 11.0 | 11.0 | 36 | 33 | 22.0 | 147 | 8C3P4S | 200 |
| 3/4-14 | 3/4-14 | 15.9 | 15.9 | 43 | 40 | 27.0 | 206 | 12C3P4S | 160 |
| 1-11 | 1-11 | 21.0 | 21.0 | 50 | 44 | 33.3 | 434 | 16C3P4S | 120 |

Order codes shown are part of our current manufacturing programme.
Imperial and metric parts may vary in hexagon dimensions.

$\frac{\text{PN (bar)}}{10} = \text{PN (MPa)}$

Do not create drawings from these dimensions, they are subject to change and ISO manufacturing allowances.

Adapters

V3P4 Male 45° elbow

JIS BSPP 60° Cone end (JIS B8363) / Male BSPT thread (ISO 7)

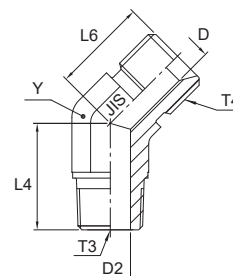

| Thread BSPP T4 | Thread BSPT T3 | D mm | D2 mm | L4 mm | L6 mm | Y mm | Weight (steel) g/1 piece | Adapter Steel | PN (bar) |
|----------------|----------------|------|-------|-------|-------|------|--------------------------|----------------|----------|
| 1/4-19 | 1/4-19 | 4.5 | 4.5 | 19 | 21 | 14.0 | 36 | 4V3P4S | 350 |
| 3/8-19 | 3/8-19 | 7.0 | 7.0 | 22 | 23 | 19.0 | 65 | 6V3P4S | 350 |
| 1/2-14 | 1/2-14 | 11.0 | 11.0 | 27 | 27 | 22.0 | 122 | 8V3P4S | 200 |
| 3/4-14 | 3/4-14 | 15.9 | 15.9 | 30 | 30 | 27.0 | 159 | 12V3P4S | 200 |
| 1-11 | 1-11 | 21.0 | 21.0 | 35 | 33 | 33.3 | 412 | 16V3P4S | 120 |

Do not create drawings from these dimensions, they are subject to change and ISO manufacturing allowances.

F63P4 Swivel male stud

JIS BSPP 60° Cone swivel female end (JIS B8363) / Male BSPT thread (ISO 7)

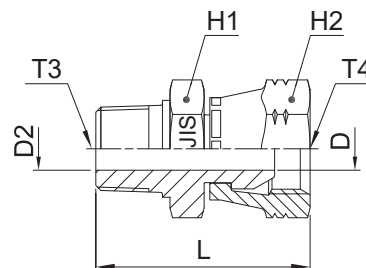

| Thread BSPT T3 | Thread BSPP T4 | D mm | D2 mm | H1 mm | H2 mm | L mm | Weight (steel) g/1 piece | Adapter Steel | Adapter Stainless Steel | PN (bar) | |
|----------------|----------------|------|-------|-------|-------|------|--------------------------|-----------------|-------------------------|----------|-----|
| | | | | | | | | | | S | SS |
| 1/4-19 | 1/4-19 | 4.5 | 4.5 | 19.0 | 19.0 | 33 | 41 | 4F63P4S | 4F63MP4SS | 315 | 315 |
| 3/8-19 | 3/8-19 | 7.0 | 7.0 | 22.2 | 22.2 | 37 | 70 | 6F63P4S | 6F63MP4SS | 315 | 315 |
| 1/2-14 | 1/2-14 | 11.0 | 11.0 | 27.0 | 27.0 | 42 | 122 | 8F63P4S | 8F63MP4SS | 200 | 200 |
| 3/4-14 | 3/4-14 | 15.9 | 15.9 | 36.5 | 36.5 | 47 | 254 | 12F63P4S | 12F63MP4SS | 160 | 160 |
| 1-11 | 1-11 | 21.0 | 21.0 | 41.3 | 41.3 | 52 | 367 | 16F63P4S | 16F63MP4SS | 120 | 120 |

Order codes shown are part of our current manufacturing programme.
Imperial and metric parts may vary in hexagon dimensions.

$\frac{\text{PN (bar)}}{10} = \text{PN (MPa)}$

Do not create drawings from these dimensions, they are subject to change and ISO manufacturing allowances.

G63P4 Female swivel connector

JIS BSPP 30° Flare swivel female end (JIS B8363) / Female BSPT thread (ISO 7)

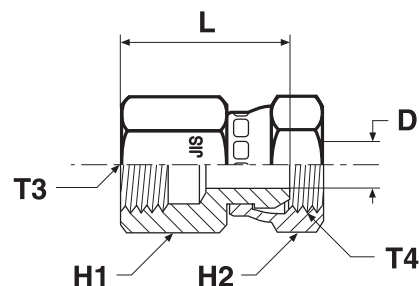

| Thread BSPT T3 | Thread BSPP T4 | D mm | H1 mm | H2 mm | L mm | Weight (steel) g/1 piece | Adapter Steel | PN (bar) |
|----------------|----------------|------|-------|-------|------|--------------------------|-----------------|----------|
| 1/4-19 | 1/4-19 | 4.5 | 19.0 | 19.0 | 30 | 36 | 4G63P4S | 315 |
| 3/8-19 | 3/8-19 | 7.0 | 22.2 | 22.2 | 33 | 49 | 6G63P4S | 315 |
| 1/2-14 | 1/2-14 | 11.0 | 27.0 | 27.0 | 36 | 73 | 8G63P4S | 200 |
| 3/4-14 | 3/4-14 | 15.9 | 36.5 | 36.5 | 38 | 163 | 12G63P4S | 160 |
| 1-11 | 1-11 | 21.0 | 41.3 | 41.3 | 46 | 195 | 16G63P4S | 120 |

Do not create drawings from these dimensions, they are subject to change and ISO manufacturing allowances.

G3P4 Female stud connector

JIS BSPP 30° Flare end (JIS B8363) / Female BSPT thread (ISO 7)

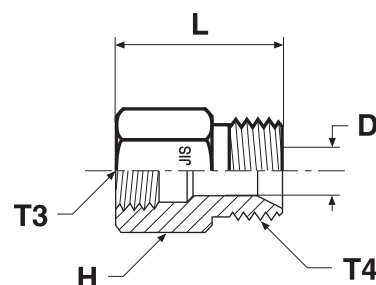

| Thread BSPT T3 | Thread BSPP T4 | D mm | H mm | L mm | Weight (steel) g/1 piece | Adapter Steel | PN (bar) |
|----------------|----------------|------|------|------|--------------------------|----------------|----------|
| 1/4-19 | 1/4-19 | 4.5 | 19.0 | 31 | 40 | 4G3P4S | 315 |
| 3/8-19 | 3/8-19 | 7.0 | 22.2 | 34 | 55 | 6G3P4S | 315 |
| 1/2-14 | 1/2-14 | 11.0 | 27.0 | 40 | 141 | 8G3P4S | 200 |
| 3/4-14 | 3/4-14 | 15.9 | 36.5 | 44 | 159 | 12G3P4S | 160 |
| 1-11 | 1-11 | 21.0 | 41.3 | 49 | 225 | 16G3P4S | 120 |

Order codes shown are part of our current manufacturing programme. Imperial and metric parts may vary in hexagon dimensions.

$\frac{\text{PN (bar)}}{10} = \text{PN (MPa)}$

Do not create drawings from these dimensions, they are subject to change and ISO manufacturing allowances.

Adapters

Spare parts guide – Triple-Lok® retaining rings and seals

BSPP male threads – ISO 1179

| BSPP Thread | ED seal Order code | | O-ring order code* | | O-ring ID × section mm | Retainer ring Order code Steel | Retainer ring Order code Stainless Steel |
|-------------|--------------------|--------------|--------------------|--------------|------------------------|--------------------------------|--|
| | NBR | FKM | NBR | FKM | | | |
| 1/8 | ED10X1X | ED10X1VITX | 6-002-N552-9 | 6-002-V894-9 | 8.00 × 2.00 | 8207-1/8 | 8207SS1/8 |
| 1/4 | ED14X1.5X | ED14X1.5VITX | 2-111-N552-9 | 2-111-V894-9 | 10.77 × 2.62 | 8207-1/4 | 8207SS1/4A |
| 3/8 | ED3/8X | ED3/8VITX | 2-113-N552-9 | 2-113-V894-9 | 13.94 × 2.62 | 8207-3/8 | 8207SS3/8A |
| 1/2 | ED1/2X | ED1/2VITX | 5-256-N552-9 | 5-256-V894-9 | 17.96 × 2.62 | 8207-1/2 | 8207SS1/2 |
| 3/4 | ED26X1.5X | ED26X1.5VITX | 2-119-N552-9 | 2-119-V894-9 | 23.47 × 2.62 | 8207-3/4 | 8207SS3/4 |
| 1 | ED33X2X | ED33X2VITX | 2-217-N552-9 | 2-217-V894-9 | 29.74 × 3.53 | 8207-1 | 8207SS1A |
| 1 1/4 | ED42X2X | ED42X2VITX | 2-222-N552-9 | 2-222-V894-9 | 37.69 × 3.53 | 8207-1-1/4 | 8207SS1 1/4 |
| 1 1/2 | ED48X2X | ED48X2VITX | 2-224-N552-9 | 2-224-V894-9 | 44.04 × 3.53 | 8207-1-1/2 | 8207SS1 1/2 |

Typical fittings using these parts: PTR44M / RI-ED / F4OHG5 etc.

* Must be used with correct retainer ring

Metric male threads – ISO 9974

| Metric Thread | ED seal order code | | O-ring Order code* | | O-ring ID × section mm | Retainer ring Order code Steel | Retainer ring Order code Stainless Steel |
|---------------|--------------------|--------------|--------------------|--------------|------------------------|--------------------------------|--|
| | NBR | FKM | NBR | FKM | | | |
| M 10×1.0 | ED10X1X | ED10X1VITX | 6-074-N552-9 | 6-074-V894-9 | 8.00 × 1.50 | M10RR | RRM10X1SS |
| M 12×1.5 | ED12X1.5X | ED12x1.5VITX | 2-012-N552-9 | 2-012-V894-9 | 9.25 × 1.78 | M12RR | RRM12X1.5SS |
| M 14×1.5 | ED14X1.5X | ED14X1.5VITX | 2-013-N552-9 | 2-013-V894-9 | 10.82 × 1.78 | M14RR | RRM14X1.5SS |
| M 16×1.5 | ED16X1.5X | ED16X1.5VITX | 3-907-N552-9 | 3-907-V894-9 | 13.46 × 2.08 | M16RR | RRM16X1.5SS |
| M 18×1.5 | ED18X1.5X | ED18X1.5VITX | 2-114-N552-9 | 2-114-V894-9 | 15.54 × 2.62 | M18RR | RRM18X1.5SS |
| M 22×2.0 | ED22X1.5X | ED22X1.5VITX | 2-018-N552-9 | 2-018-V894-9 | 18.77 × 1.78 | M22RR | RRM22X1.5SS |
| M 27×2.0 | ED26X1.5X** | ED26X1.5VITX | 2-119-N552-9 | 2-119-V894-9 | 23.47 × 2.62 | M27RR | RRM27X2SS |
| M 33×2.0 | ED33X2X | ED33X2VITX | 2-122-N552-9 | 2-122-V894-9 | 28.24 × 2.62 | M33RR | RRM33X2SS |
| M 42×2.0 | ED42X2X | ED42X2VITX | 2-128-N552-9 | 2-128-V894-9 | 37.77 × 2.62 | M42RR | RRM42X2SS |
| M 48×2.0 | ED48X2X | ED48X2VITX | 2-132-N552-9 | 2-132-V894-9 | 44.12 × 2.62 | M48RR | RRM48X2SS |

Typical fittings using these parts: F8OHG5 / VSTI MED etc.

* Must be used with correct retainer ring ** Same seal used for M 26×1.5 and M 27×2.0 Threads

UN / UNF male threads – ISO 11926

| UN / UNF Thread | Dash size | O-ring Order code | | O-Ring ID × section (mm) |
|-----------------|-----------|-------------------|--------------|--------------------------|
| | | NBR | FKM | |
| 5/16-24 | 2 | 3-902-N552-9 | 3-902-V894-9 | 6.07 × 1.63 |
| 3/8-24 | 3 | 3-903-N552-9 | 3-903-V894-9 | 7.65 × 1.63 |
| 7/16-20 | 4 | 3-904-N552-9 | 3-904-V894-9 | 8.92 × 1.83 |
| 1/2-20 | 5 | 3-905-N552-9 | 3-905-V894-9 | 10.52 × 1.83 |
| 9/16-18 | 6 | 3-906-N552-9 | 3-906-V894-9 | 11.89 × 1.98 |
| 3/4-16 | 8 | 3-908-N552-9 | 3-908-V894-9 | 16.36 × 2.21 |
| 7/8-14 | 10 | 3-910-N552-9 | 3-910-V894-9 | 19.18 × 2.46 |
| 1 1/16-12 | 12 | 3-912-N552-9 | 3-912-V894-9 | 23.47 × 2.95 |
| 1 3/16-12 | 14 | 3-914-N552-9 | 3-914-V894-9 | 26.59 × 2.95 |
| 1 5/16-12 | 16 | 3-916-N552-9 | 3-916-V894-9 | 29.74 × 2.95 |
| 1 5/8-12 | 20 | 3-920-N552-9 | 3-920-V894-9 | 37.47 × 3.00 |
| 1 7/8-12 | 24 | 3-924-N552-9 | 3-924-V894-9 | 43.69 × 3.00 |
| 2 1/2-12 | 32 | 3-932-N552-9 | 3-932-V894-9 | 59.36 × 3.00 |

Typical fittings using these parts: F5OG / P5ON / F5OHAO etc.

Metric male threads – ISO 6149

| Metric Thread | O-ring Order code | | O-Ring ID × section (mm) |
|---------------|-------------------|--------------|--------------------------|
| | NBR | FKM | |
| M 10×1.0 | 6-345-N552-9 | 6-345-V894-9 | 8.20 × 1.50 |
| M 12×1.5 | 6-346-N552-9 | 6-346-V894-9 | 9.40 × 2.10 |
| M 14×1.5 | 6-347-N552-9 | 6-347-V894-9 | 11.40 × 2.10 |
| M 16×1.5 | 6-348-N552-9 | 6-348-V894-9 | 13.40 × 2.10 |
| M 18×1.5 | 6-349-N552-9 | 6-349-V894-9 | 15.40 × 2.10 |
| M 22×1.5 | 6-350-N552-9 | 6-350-V894-9 | 19.40 × 2.10 |
| M 27×2.0 | 6-351-N552-9 | 6-351-V894-9 | 23.70 × 2.80 |
| M 33×2.0 | 6-352-N552-9 | 6-352-V894-9 | 29.70 × 2.80 |
| M 42×2.0 | 6-353-N552-9 | 6-353-V894-9 | 38.70 × 2.80 |
| M 48×2.0 | 6-354-N552-9 | 6-354-V894-9 | 46.70 × 2.80 |

Typical fittings using these parts: VSTI-OR etc.

BSPP Bonded Seal

| BSPP Thread Size | O.D. (mm) | I.D. (mm) | W (mm) | Material | | | Order code |
|------------------|-----------|-----------|--------|----------|----|---|------------|
| | | | | S* | SS | B | |
| 1/8-28 | 15.9 | 10.4 | 2.0 | • | | | D9DT-2 |
| 1/4-19 | 20.6 | 13.7 | 2.0 | • | | | D9DT-4 |
| 3/8-19 | 23.8 | 17.3 | 2.0 | • | | | D9DT-6 |
| 1/2-14 | 28.6 | 21.5 | 2.3 | • | | | D9DT-8 |
| 5/8-14 | 31.8 | 23.5 | 2.3 | • | | | D9DT-10 |
| 3/4-14 | 34.9 | 27.1 | 2.3 | • | | | D9DT-12 |
| 1-11 | 42.8 | 33.9 | 2.3 | • | | | D9DT-16 |
| 1 1/4-11 | 52.4 | 42.9 | 3.3 | • | | | D9DT-20 |
| 1 1/2-11 | 58.6 | 48.4 | 3.3 | • | | | D9DT-24 |

Used on K4 Style Straight Fittings as a Port Seal. For use with ISO 1179 / DIN 3852-2 port.

* NBR is the standard elastomer compound - 90-durometer Nitrile Zinc plated steel ring

Other seal compounds available on request for alternative applications

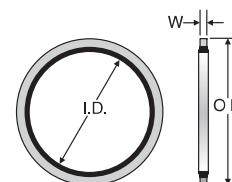



Ermeto Original Valves

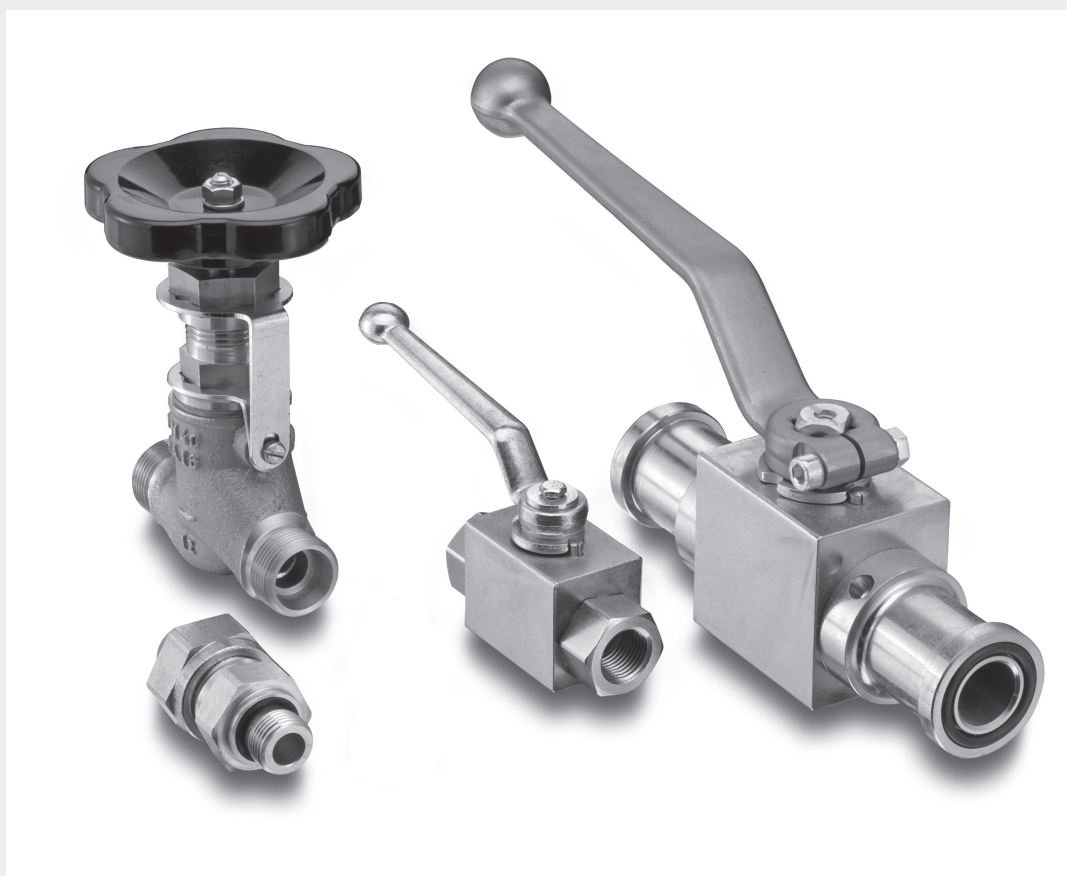

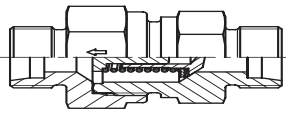
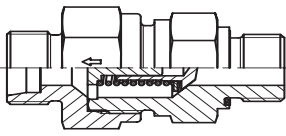
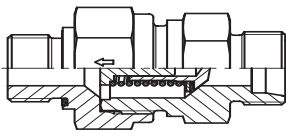
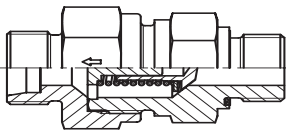
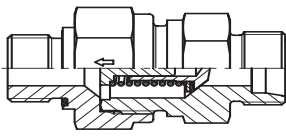
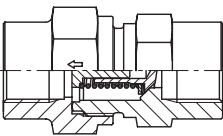
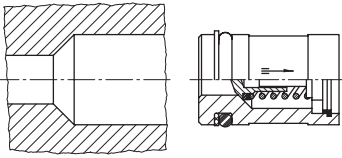
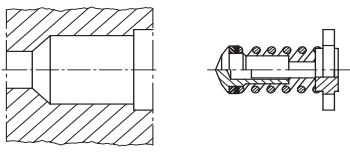

Visual index Non return valves

| | |
|--|--|
| <p>RHD / p. P13</p>  <p>EO 24° cone end / EO 24° cone end</p> | |
| <p>RHV-R-ED / p. P14</p>  <p>EO 24° cone end / Male BSPP thread – ED-seal (ISO 1179)</p> | <p>RHZ-R-ED / p. P15</p>  <p>Male BSPP thread – ED-seal (ISO 1179) / EO 24° cone end</p> |
| <p>RHV-M-ED / p. P16</p>  <p>EO 24° cone end / Male metric thread – ED-seal (ISO 9974)</p> | <p>RHZ-M-ED / p. P17</p>  <p>Male metric thread – ED-seal (ISO 9974) / EO 24° cone end</p> |
| <p>RHDI / p. P18</p>  <p>Female BSPP thread (ISO 1179-1) / Female BSPP thread (ISO 1179-1)</p> | |
| <p>RVP / p. P19</p>  <p>Non return valve cartridge</p> | |
| <p>I-TL / p. P20</p>  <p>Internal parts of non return valve</p> | |

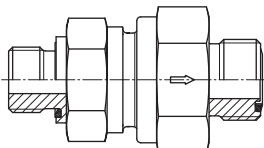
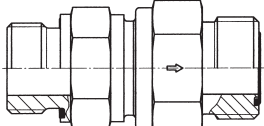
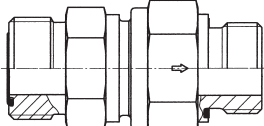
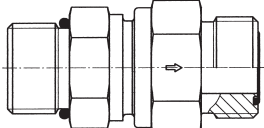
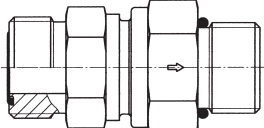
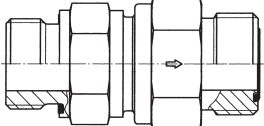
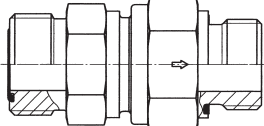

Visual index Non return valves with O-Lok® connections

| | |
|---|--|
| <p>RHDMLOS / p. P22</p>  <p>O-Lok® ORFS end / O-Lok® ORFS end</p> | |
| <p>RHV42EDMLOS / p. P23</p>  <p>Male BSPP thread – ED-seal (ISO 1179) / O-Lok® ORFS end</p> | <p>RHZ42EDMLOS / p. P24</p>  <p>O-Lok® ORFS end / Male BSPP thread – ED-seal (ISO 1179)</p> |
| <p>RHV50MLOS / p. P25</p>  <p>Male UN/UNF thread– O-ring (ISO 11926) / O-Lok® ORFS end</p> | <p>RHZ50MLOS / p. P26</p>  <p>O-Lok® ORFS end / Male UN/UNF thread– O-ring (ISO 11926)</p> |
| <p>RHV82EDMLOS / p. P27</p>  <p>Male metric thread – ED-seal (ISO 9974) / O-Lok® ORFS end</p> | <p>RHZ82EDMLOS / p. P28</p>  <p>O-Lok® ORFS end / Male metric thread – ED-seal (ISO 9974)</p> |



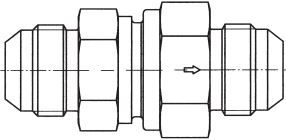
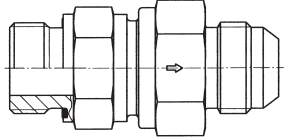
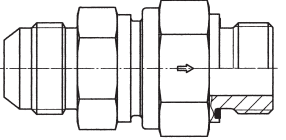
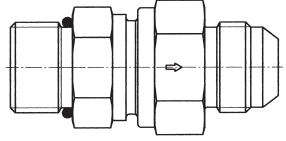
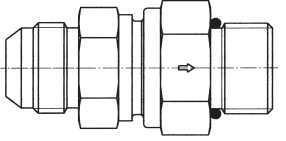
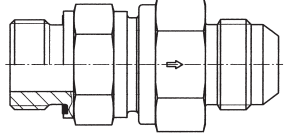
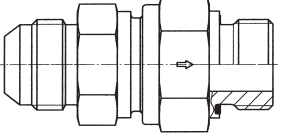

Visual index Non return valves with Triple-Lok® connections

| | |
|--|---|
| <p>RHDMTXS / p. P29</p>  <p>Triple-Lok® 37° flare end / Triple-Lok® 37° flare end</p> | |
| <p>RHV42EDMXS / p. P30</p>  <p>Male BSPP thread – ED-seal (ISO 1179) / Triple-Lok® 37° flare end</p> | <p>RHZ42EDMXS / p. P31</p>  <p>Triple-Lok® 37° flare end / Male BSPP thread – ED-seal (ISO 1179)</p> |
| <p>RHV50MXS / p. P32</p>  <p>Male UN/UNF thread – O-ring (ISO 11926) / Triple-Lok® 37° flare end</p> | <p>RHZ50MXS / p. P33</p>  <p>Triple-Lok® 37° flare end / Male UN/UNF thread – O-ring (ISO 11926)</p> |
| <p>RHV82EDMXS / p. P34</p>  <p>Male metric thread – ED-seal (ISO 9974) / Triple-Lok® 37° flare end</p> | <p>RHZ82EDMXS / p. P35</p>  <p>Triple-Lok® 37° flare end / Male metric thread – ED-seal (ISO 9974)</p> |

Visual index 2-way ball valves

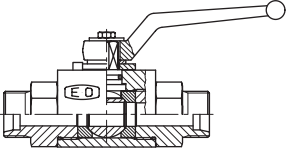
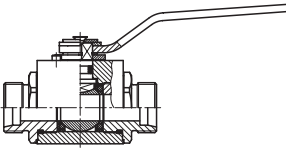
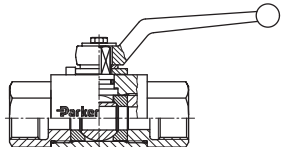
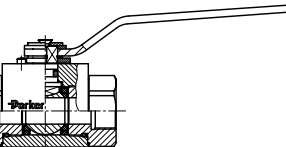
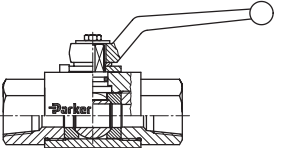
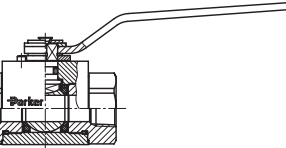
| | |
|--|---|
|  <p>KH (Steel CF) p. P40</p> <p>EO 24° cone end</p> |  <p>KH (Stainless steel 71) p. P41</p> <p>EO 24° cone end</p> |
|  <p>KH-BSPP (Steel CF) p. P42</p> <p>Female BSPP thread (ISO 1179-1)</p> |  <p>KH-BSPP (Stainless steel 71) p. P43</p> <p>Female BSPP thread (ISO 1179-1)</p> |
|  <p>KH-NPT (Steel CF) p. P44</p> <p>Female NPT thread (SAE 476)</p> |  <p>KH-NPT (Stainless steel 71) p. P45</p> <p>Female NPT thread (SAE 476)</p> |

Visual index 3-way ball valves

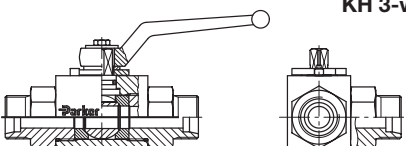
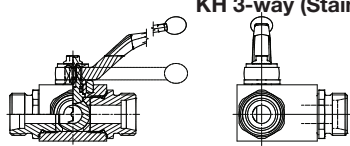
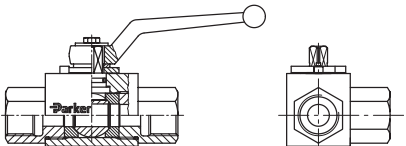
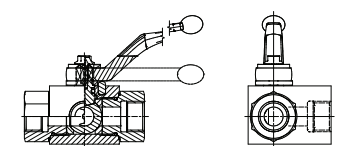
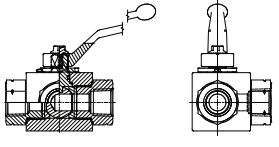
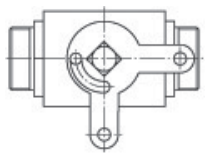
| | |
|--|---|
|  <p>KH 3-way (Steel CF) p. P46</p> <p>EO 24° cone end</p> |  <p>KH 3-way (Stainless steel 71) p. P47</p> <p>EO 24° cone end</p> |
|  <p>KH 3-way BSPP (Steel CF) p. P48</p> <p>Female BSPP thread (ISO 1179-1)</p> |  <p>KH 3-way BSPP (Stainless steel 71) p. P49</p> <p>Female BSPP thread (ISO 1179-1)</p> |
|  <p>KH 3-way NPT (Steel CF) p. P50</p> <p>Female NPT thread (SAE 476)</p> |  <p>KHLOCKING p. P51</p> <p>Locking Devices for Two-Way and Multiway ball valves</p> |





Valves

Visual index SAE ball valves

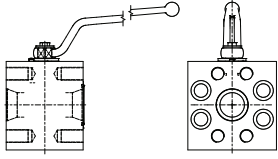
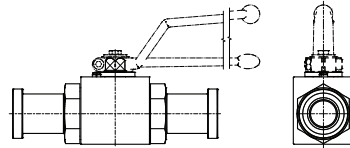
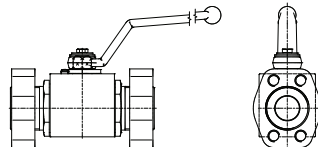
| | |
|--|--|
|  <p>KH-B1V (Steel CF) p. P52</p> <p>Ball valve with SAE Flange connection</p> |  <p>KH-A (Steel CF) p. P53</p> <p>Ball valve with SAE Flange connection</p> |
|  <p>KH-T (Steel CF) p. P54</p> <p>Ball valve with SAE Flange connection ISO 6162 (1/2)</p> | <p>More flange ball valves see catalogue 4162</p> |

Visual index ball valves for block structure

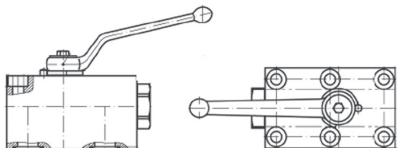
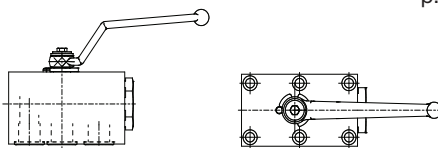
| | |
|---|---|
|  <p>KHBLOCK p. P55</p> <p>2-way ball valve for block structure</p> |  <p>KHBLOCK -3-way p. P56</p> <p>3-way ball valve for block structure</p> |
|---|---|

Visual index Flow Control Valves

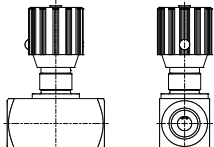
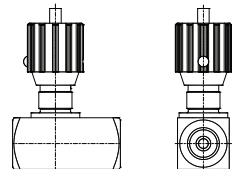
| | |
|--|--|
|  <p>RDV p. P58</p> <p>Flow Control Valve (Female BSPP thread ISO 1179-1)</p> |  <p>RDVR p. P59</p> <p>Flow Control Check Valve (Female BSPP thread ISO 1179-1)</p> |
|--|--|

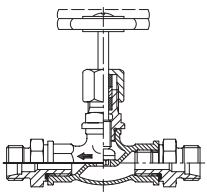
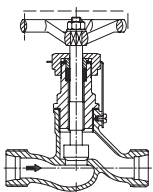
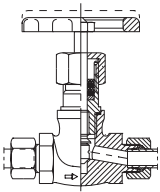
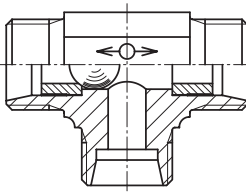
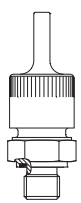

Visual index shut off valves

| | |
|--|--|
|  <p>DV p. P60</p> <p>EO 24° cone end</p> |  <p>LD p. P61</p> <p>EO 24° cone end</p> |
|  <p>VDHA p. P62</p> <p>EO tube end</p> |  <p>WV p. P63</p> <p>EO 24° cone end</p> |
|  <p>ELA/ELAE p. P64/P65</p> <p>Air-bleed valves</p> | |



Valves

Range of non return valves, alternating valves and hand-operated shut off valves

Non-return valves with nominal pressure ratings up to PN 420 bar:

- with tube connection both ends: RHD
- with tube connection to male stud: RHV/RHZ
- with female thread both ends: RHDl
- valve cartridges: RVP
- valve internal parts: I-TL
- leakage rate hydraulic testing under test pressure: 1 drop per minute

Alternating valves:

- for nominal pressure ratings up to PN 160 WV
- leakage rate hydraulic testing under test pressure: 20 drops per minute

Shut-off valves:

- for high pressure ratings up to PN 630 bar VDHA

Design:

1. For materials, permissible working pressures, temperatures, flow medium torques for male studs etc. see relevant pages of the catalogue.
2. Tube connection ends must be assembled according to the Parker EO/EO-2 assembly instructions.
3. The valve bodies must be held rigidly during assembly of the tube connection ends.
4. Test pressures for non return valves: PN in conformance with O.D. information see chapter C.
5. Pressure drop values please see p. C12 and diagrams.

Caution!

Please note the admissible pressure ratings for the EO-tube ends.

Notes:

To assess the suitability of valves for specific applications, please advise us of the exact specification of the medium to be used, max. working pressure incl. pressure peaks, temperature and frequency of valve operations. If water is used, indicate type of water or additives, if any.

RHD/V/Z non return valve

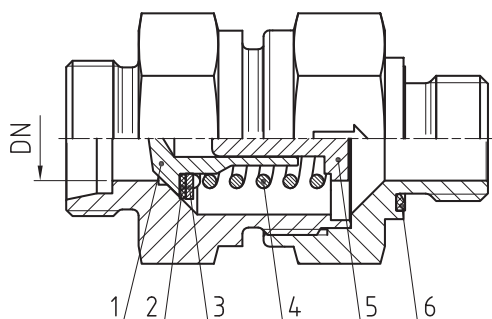

Design with sealing edge:
Size 06L and 08L / 06S and 08S
and all sizes in stainless steel with a PTFDE sealing disc.

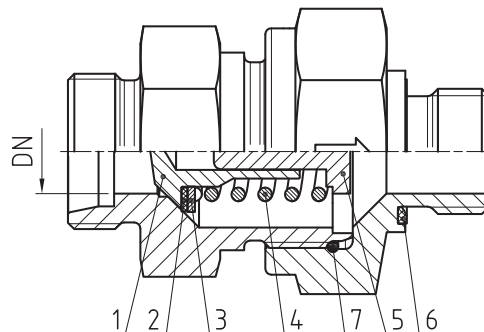

Design with O-ring (item. 7):
Sizes 10L, 12L, 15L, 18L, 22L, 28L, 35L and 42L
as well as 10S, 12S, 14S, 16S, 20S, 25S, 30S and 38S with a
sealing disc out of NBR (steel) or FKM (stainless steel).



RHD



RHV



RHZ

- 1: poppet
- 2: sealing disc
- 3: cover disc
- 4: spring
- 5: passage disc
- 6: Eolastic-sealing
- 7: O-ring

DN = Nominal diameter (mm)

Characteristics:

Poppet check valve with a 90° valve seat with an elastomere sealing disc. Poppet stop for controlled valve opening. Damped opening action to minimize shock and noise. No reduction of cross section. Maximum flow velocity not more than 8 m/sec. Sealing of male stud thread by Eolastic soft seal with types RHV and RHZ.

Opening pressure:

Standard 1 bar (on request also 0.2, 0.5, 2, 3, 4, 5 and 6 bar are available; please specify on order). For working pressure see appropriate tables. Cracking pressure tolerance: $\pm 20\%$.

Material:

- Steel zinc-plated (CF Cr[VI]-free), seals in NBR (e.g. Perbunan), or (FKM) on request.

Perbunan = registered trademark of Bayer

- Stainless steel valves have FKM as standard. (Up to 3 bar cracking pressure)

- Brass-valves (CuZn35Ni2 2.0540) with internals (1.4571) available on request. (Up to 3 bar cracking pressure)

Assembly:

See assembly instructions for EO/EO 2 connections. Non-return valves are all packaged against contamination.

P

Media:

Hydraulic oil, low flammability hydraulic fluids (except for types HFC: for HFD types; FKM seals are necessary). Air pressure tested (please indicate on order). Not suitable for steam, combustible/explosive gases, or oxygen. For water applications, please consult Parker with details of water and any additives.

Valves

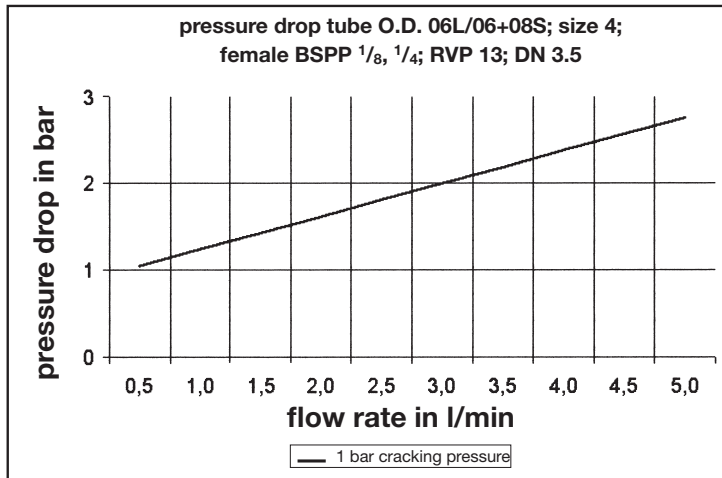

In all diagrams is the peak value of the flow rate in l/min. relating to the maximum permissible flow velocity of 8 m/sec.

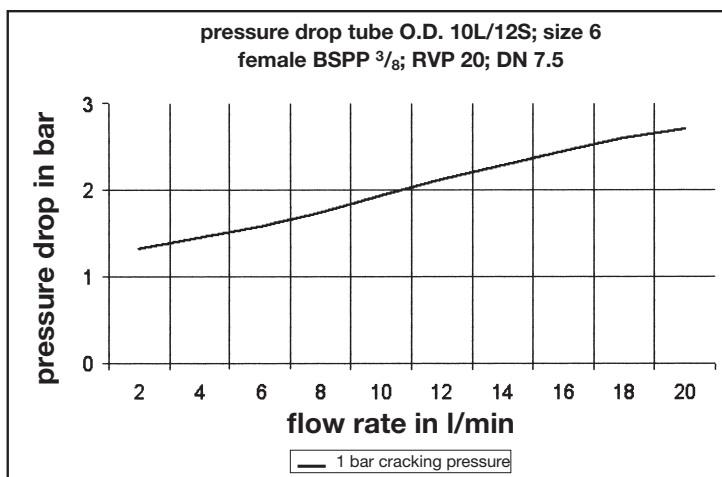
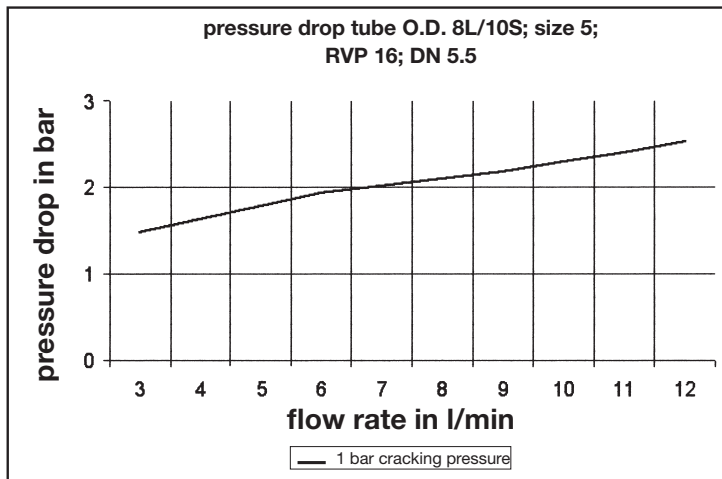

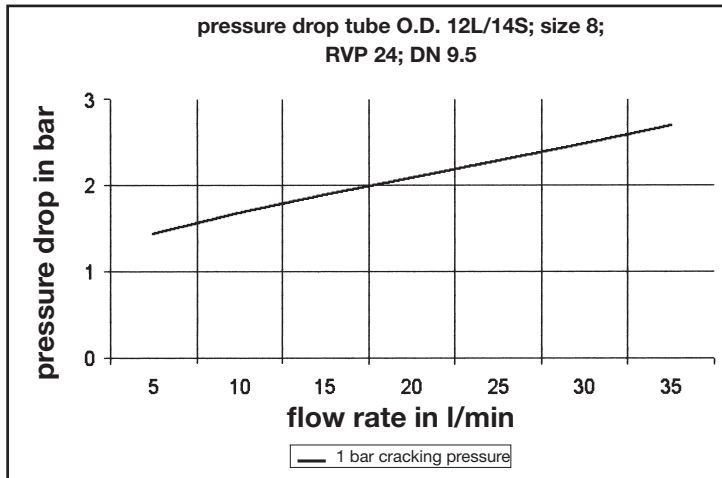

In all diagrams is the peak value of the flow rate in l/min. relating to the maximum permissible flow velocity of 8 m/sec.

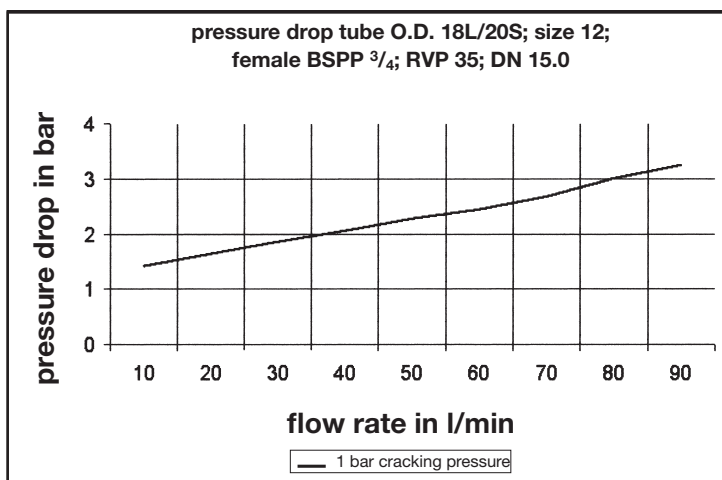
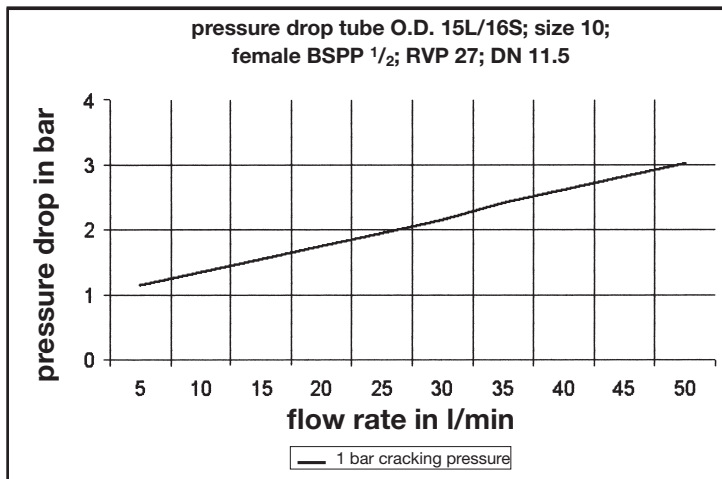

Valves

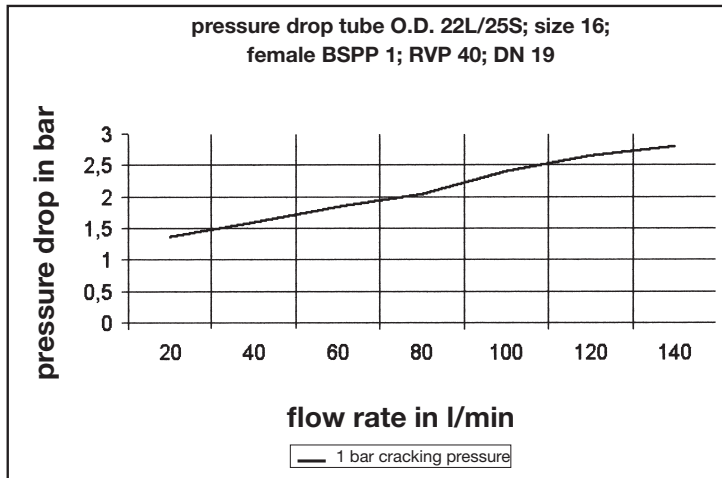

In all diagrams is the peak value of the flow rate in l/min. relating to the maximum permissible flow velocity of 8 m/sec.

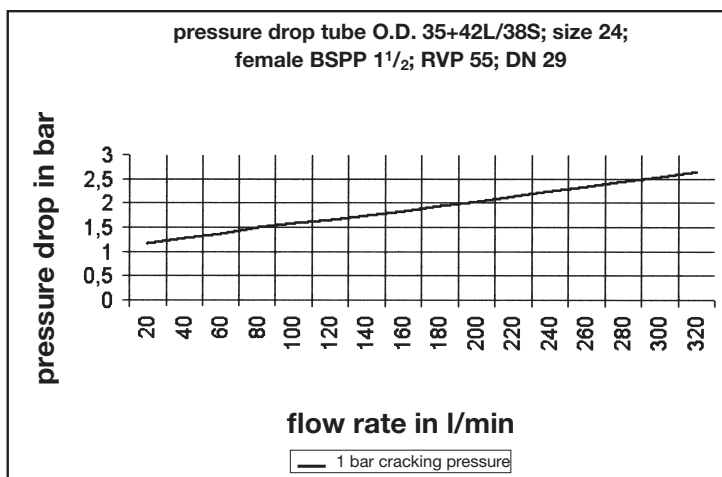
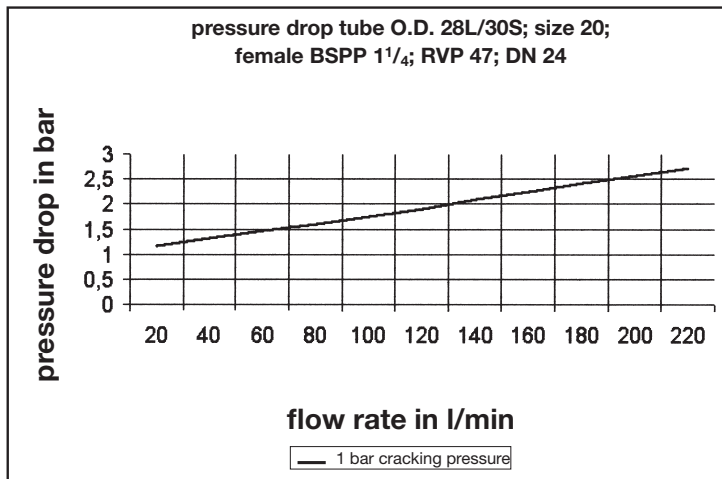



RHD Non return valve

EO 24° cone end / EO 24° cone end

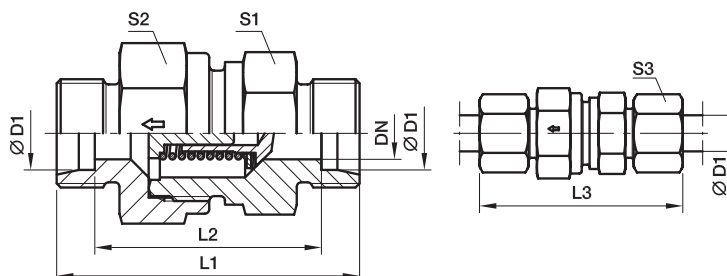

| Series | D1 | CF DN | 71 DN | L1 | L2 | L3 | S1 | CF S2 | 71 S2 | S3 | Weight g/1 piece | Order code* | PN (bar) ¹⁾ | |
|-----------------|--------|----------|----------|-------|------|-------|----|----------|----------|----|---------------------|------------------|------------------------|-----|
| | | | | | | | | | | | | | CF | 71 |
| L ³⁾ | 06 | 3.5 | 3.5 | 43.0 | 29.0 | 58.0 | 17 | 17 | 17 | 14 | 46 | RHD06LOMD | 400 | 250 |
| | 08 | 5.5 | 5.5 | 44.0 | 30.0 | 59.0 | 19 | 19 | 19 | 17 | 61 | RHD08LOMD | 400 | 250 |
| | 10 | 7.5 | 7.5 | 55.0 | 40.5 | 69.5 | 22 | 24 | 24 | 19 | 104 | RHD10LOMD | 400 | 250 |
| | 12 | 9.5 | 9.5 | 58.0 | 43.5 | 72.5 | 27 | 30 | 30 | 22 | 166 | RHD12LOMD | 400 | 250 |
| | 15 | 11.0 | 11.5 | 62.0 | 47.5 | 77.5 | 27 | 32 | 32 | 27 | 192 | RHD15LOMD | 400 | 250 |
| | 18 | 14.0 | 14.0 | 67.0 | 51.5 | 83.5 | 36 | 41 | 36 | 32 | 292 | RHD18LOMD | 400 | 160 |
| | 22 | 18.0 | 18.0 | 77.0 | 61.5 | 93.5 | 41 | 46 | 46 | 36 | 472 | RHD22LOMD | 250 | 160 |
| | 28 | 23.0 | 23.0 | 85.0 | 69.5 | 102.5 | 50 | 55 | 55 | 41 | 746 | RHD28LOMD | 250 | 100 |
| | 35 | 29.0 | 29.0 | 96.0 | 74.0 | 117.5 | 60 | 65 | 60 | 50 | 1062 | RHD35LOMD | 250 | 100 |
| | 42 | 29.0 | 29.0 | 96.0 | 74.0 | 119.0 | 65 | 70 | 70 | 60 | 1518 | RHD42LOMD | 250 | 100 |
| S ⁴⁾ | 06 | 3.5 | 3.5 | 48.5 | 34.5 | 63.5 | 19 | 19 | 19 | 17 | 70 | RHD06SOMD | 420 | 400 |
| | 08 | 3.5 | 3.5 | 48.5 | 34.5 | 63.5 | 19 | 19 | 19 | 19 | 74 | RHD08SOMD | 420 | 400 |
| | 10 | 5.5 | 5.5 | 55.5 | 40.5 | 72.5 | 22 | 24 | 24 | 22 | 121 | RHD10SOMD | 420 | 400 |
| | 12 | 7.5 | 7.5 | 57.5 | 42.5 | 74.5 | 24 | 27 | 27 | 24 | 148 | RHD12SOMD | 420 | 400 |
| | 16 | 11.0 | 11.5 | 68.0 | 50.5 | 86.5 | 32 | 36 | 36 | 30 | 286 | RHD16SOMD | 420 | 315 |
| | 20 | 15.0 | 15.0 | 76.0 | 54.5 | 97.5 | 41 | 50 | 46 | 36 | 506 | RHD20SOMD | 420 | 250 |
| | 25 | 19.0 | 19.0 | 83.0 | 58.5 | 106.5 | 46 | 55 | 50 | 46 | 639 | RHD25SOMD | 420 | 250 |
| | 30 | 24.0 | 24.0 | 97.0 | 69.5 | 122.5 | 60 | 60 | 60 | 50 | 1157 | RHD30SOMD | 250 | 250 |
| | 38 | 29.0 | 29.0 | 108.0 | 75.5 | 136.5 | 65 | 70 | 70 | 60 | 1650 | RHD38SOMD | 250 | 250 |

¹⁾ Pressure shown = item deliverable

³⁾ L = light series; ⁴⁾ S = heavy series

PN (bar) = PN (MPa)
10

Delivery without nut and ring. Information on ordering complete fittings or alternative sealing materials see page 17.



| Order code suffixes | | | |
|---------------------------------|-----------------------------|-------------|---|
| Material | Suffix surface and material | Example | Standard sealing material (no additional suffix needed) |
| Steel, zinc plated, Cr(VI)-free | CF | RHD06LOMDCF | NBR |
| Stainless steel | 71 | RHD06LOMD71 | VIT |

*Please add the **suffixes** below according to the material/surface required.



Valves

RHV-R-ED Non return valve

EO 24° cone end / Male BSPP thread – ED-seal (ISO 1179)

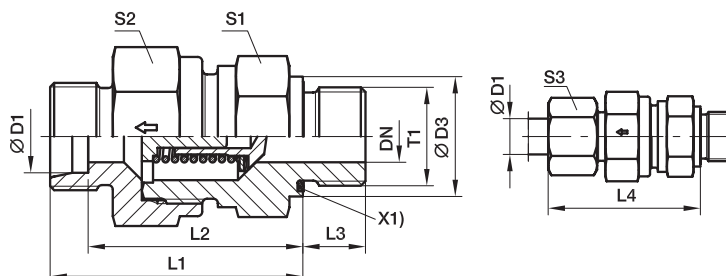

X1) Eolastic sealing

| Series | D1 | T1 | CF DN | 71 DN | D3 | L1 | L2 | L3 | L4 | S1 | CF S2 | 71 S2 | S3 | Weight g/1 piece | Order code* | PN (bar) ¹⁾ | |
|-----------------|-----------|-----------|-------|-------|------|------|------|-------|------|----|-------|-------|------|------------------|-------------|------------------------|-----|
| | | | | | | | | | | | | | | | | CF | 71 |
| L ³⁾ | 06 | G 1/8 A | 3.5 | 3.5 | 14 | 35.0 | 28.0 | 8 | 42.5 | 17 | 17 | 17 | 14 | 47 | RHV06LREDO | 400 | 250 |
| | 08 | G 1/4 A | 5.5 | 5.5 | 19 | 37.0 | 30.0 | 12 | 44.5 | 19 | 19 | 19 | 17 | 62 | RHV08LREDO | 400 | 250 |
| | 10 | G 1/4 A | 7.5 | 7.5 | 19 | 46.0 | 38.5 | 12 | 53.0 | 22 | 24 | 24 | 19 | 105 | RHV10LREDO | 400 | 250 |
| | 12 | G 3/8 A | 9.5 | 9.5 | 22 | 50.0 | 42.5 | 12 | 57.0 | 27 | 30 | 30 | 22 | 175 | RHV12LREDO | 400 | 250 |
| | 15 | G 1/2 A | 11.0 | 11.5 | 27 | 53.0 | 45.5 | 14 | 60.5 | 27 | 32 | 32 | 27 | 205 | RHV15LREDO | 400 | 250 |
| | 18 | G 1/2 A | 14.0 | 14.0 | 27 | 58.0 | 50.0 | 14 | 66.0 | 36 | 41 | 36 | 32 | 294 | RHV18LREDO | 400 | 160 |
| | 22 | G 3/4 A | 18.0 | 18.0 | 32 | 63.0 | 55.0 | 16 | 71.0 | 41 | 46 | 46 | 36 | 450 | RHV22LREDO | 250 | 160 |
| | 28 | G 1 A | 23.0 | 23.0 | 40 | 71.0 | 63.0 | 18 | 79.5 | 50 | 55 | 55 | 41 | 720 | RHV28LREDO | 250 | 100 |
| S ⁴⁾ | 35 | G 1 1/4 A | 29.0 | 29.0 | 50 | 80.0 | 69.0 | 20 | 90.5 | 60 | 65 | 65 | 50 | 1050 | RHV35LREDO | 250 | 100 |
| | 42 | G 1 1/2 A | 29.0 | 29.0 | 55 | 80.0 | 68.5 | 22 | 91.0 | 65 | 70 | 70 | 60 | 1560 | RHV42LREDO | 250 | 100 |
| | 06 | G 1/4 A | 3.5 | 3.5 | 19 | 38.5 | 31.5 | 12 | 46.0 | 19 | 19 | 19 | 17 | 73 | RHV06SREDO | 420 | 400 |
| | 08 | G 1/4 A | 3.5 | 3.5 | 19 | 38.5 | 31.5 | 12 | 46.0 | 19 | 19 | 19 | 19 | 79 | RHV08SREDO | 420 | 400 |
| | 10 | G 3/8 A | 5.5 | 5.5 | 22 | 45.5 | 38.0 | 12 | 54.0 | 22 | 24 | 24 | 22 | 132 | RHV10SREDO | 420 | 400 |
| | 12 | G 3/8 A | 7.5 | 7.5 | 22 | 48.5 | 41.0 | 12 | 57.0 | 24 | 27 | 27 | 24 | 153 | RHV12SREDO | 420 | 400 |
| | 16 | G 1/2 A | 11.0 | 11.5 | 27 | 57.0 | 48.0 | 14 | 66.0 | 32 | 36 | 36 | 30 | 293 | RHV16SREDO | 420 | 315 |
| | 20 | G 3/4 A | 15.0 | 15.0 | 32 | 63.0 | 52.0 | 16 | 73.5 | 41 | 50 | 46 | 36 | 511 | RHV20SREDO | 420 | 250 |
| | 25 | G 1 A | 19.0 | 19.0 | 40 | 67.0 | 54.5 | 18 | 78.5 | 46 | 55 | 50 | 46 | 648 | RHV25SREDO | 420 | 250 |
| | 30 | G 1 1/4 A | 24.0 | 24.0 | 50 | 78.0 | 64.0 | 20 | 90.5 | 60 | 60 | 60 | 50 | 1176 | RHV30SREDO | 250 | 250 |
| 38 | G 1 1/2 A | 29.0 | 29.0 | 55 | 86.0 | 69.5 | 22 | 100.0 | 65 | 70 | 70 | 60 | 1624 | RHV38SREDO | 250 | 250 | |

¹⁾ Pressure shown = item deliverable

³⁾ L = light series; ⁴⁾ S = heavy series

 $\frac{\text{PN (bar)}}{10} = \text{PN (MPa)}$

Delivery without nut and ring. Information on ordering complete fittings or alternative sealing materials see page 17.

*Please add the suffixes below according to the material/surface required.

| Order code suffixes | | | |
|---------------------------------|-----------------------------|------------|---|
| Material | Suffix surface and material | Example | Standard sealing material (no additional suffix needed) |
| Steel, zinc plated, Cr(VI)-free | CF | RHV06LREDO | NBR |
| Stainless steel | 71 | RHV06LREDO | VIT |



RHZ-R-ED Non return valve

Male BSPP thread – ED-seal (ISO 1179) / EO 24° cone end

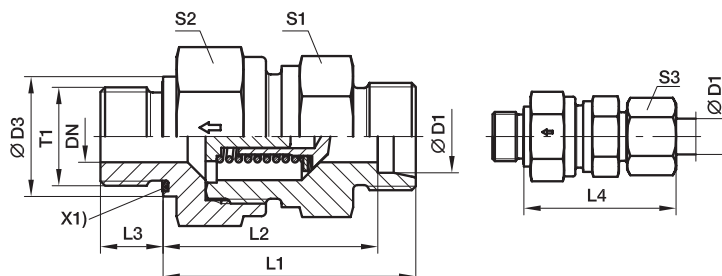

X1) Eolastic sealing

| Series | D1 | T1 | CF DN | 71 DN | D3 | L1 | L2 | L3 | L4 | S1 | CF S2 | 71 S2 | S3 | Weight g/1 piece | Order code* | PN (bar) ¹⁾ | |
|-----------------|----|-----------|-------|-------|----|------|------|----|-------|----|-------|-------|----|------------------|--------------|------------------------|-----|
| | | | | | | | | | | | | | | | | CF | 71 |
| L ³⁾ | 06 | G 1/8 A | 3.5 | 3.5 | 14 | 33.5 | 26.5 | 8 | 41.0 | 17 | 17 | 17 | 14 | 44 | RHZ06LREDOMD | 400 | 250 |
| | 08 | G 1/4 A | 5.5 | 5.5 | 19 | 35.5 | 28.5 | 12 | 43.0 | 19 | 19 | 19 | 17 | 59 | RHZ08LREDOMD | 400 | 250 |
| | 10 | G 1/4 A | 7.5 | 7.5 | 19 | 46.0 | 38.5 | 12 | 53.0 | 22 | 24 | 24 | 19 | 125 | RHZ10LREDOMD | 400 | 250 |
| | 12 | G 3/8 A | 9.5 | 9.5 | 22 | 48.0 | 40.5 | 12 | 55.0 | 27 | 30 | 30 | 22 | 161 | RHZ12LREDOMD | 400 | 250 |
| | 15 | G 1/2 A | 11.0 | 11.5 | 27 | 50.0 | 42.5 | 14 | 57.5 | 27 | 32 | 32 | 27 | 186 | RHZ15LREDOMD | 400 | 250 |
| | 18 | G 1/2 A | 14.0 | 14.0 | 27 | 56.0 | 48.0 | 14 | 64.0 | 36 | 41 | 36 | 32 | 275 | RHZ18LREDOMD | 400 | 160 |
| | 22 | G 3/4 A | 18.0 | 18.0 | 32 | 64.0 | 56.0 | 16 | 72.0 | 41 | 46 | 46 | 36 | 463 | RHZ22LREDOMD | 250 | 160 |
| | 28 | G 1 A | 23.0 | 23.0 | 40 | 72.0 | 64.0 | 18 | 80.5 | 50 | 55 | 55 | 41 | 721 | RHZ28LREDOMD | 250 | 100 |
| | 35 | G 1 1/4 A | 29.0 | 29.0 | 50 | 81.0 | 70.0 | 20 | 91.5 | 60 | 65 | 65 | 50 | 1073 | RHZ35LREDOMD | 250 | 100 |
| | 42 | G 1 1/2 A | 29.0 | 29.0 | 55 | 82.0 | 70.5 | 22 | 93.0 | 65 | 70 | 70 | 60 | 1602 | RHZ42LREDOMD | 250 | 100 |
| S ⁴⁾ | 06 | G 1/4 A | 3.5 | 3.5 | 19 | 38.5 | 31.5 | 12 | 46.0 | 19 | 19 | 19 | 17 | 71 | RHZ06SREDOMD | 420 | 400 |
| | 08 | G 1/4 A | 3.5 | 3.5 | 19 | 38.5 | 31.5 | 12 | 46.0 | 19 | 19 | 19 | 19 | 74 | RHZ08SREDOMD | 420 | 400 |
| | 10 | G 3/8 A | 5.5 | 5.5 | 22 | 45.5 | 38.0 | 12 | 54.0 | 22 | 24 | 24 | 22 | 128 | RHZ10SREDOMD | 420 | 400 |
| | 12 | G 3/8 A | 7.5 | 7.5 | 22 | 48.5 | 41.0 | 12 | 57.0 | 24 | 27 | 27 | 24 | 152 | RHZ12SREDOMD | 420 | 400 |
| | 16 | G 1/2 A | 11.0 | 11.5 | 27 | 55.0 | 46.0 | 14 | 64.0 | 32 | 36 | 36 | 30 | 275 | RHZ16SREDOMD | 420 | 315 |
| | 20 | G 3/4 A | 15.0 | 15.0 | 32 | 61.0 | 50.0 | 16 | 71.5 | 41 | 50 | 46 | 36 | 490 | RHZ20SREDOMD | 420 | 250 |
| | 25 | G 1 A | 19.0 | 19.0 | 40 | 67.0 | 54.5 | 18 | 78.5 | 46 | 55 | 50 | 46 | 647 | RHZ25SREDOMD | 420 | 250 |
| | 30 | G 1 1/4 A | 24.0 | 24.0 | 50 | 78.0 | 64.0 | 20 | 90.5 | 60 | 60 | 60 | 50 | 1180 | RHZ30SREDOMD | 250 | 250 |
| | 38 | G 1 1/2 A | 29.0 | 29.0 | 55 | 88.0 | 71.5 | 22 | 102.0 | 65 | 70 | 70 | 60 | 1670 | RHZ38SREDOMD | 250 | 250 |

¹⁾ Pressure shown = item deliverable

³⁾ L = light series; ⁴⁾ S = heavy series

PN (bar) = PN (MPa)
10

Delivery without nut and ring. Information on ordering complete fittings or alternative sealing materials see page 17.



*Please add the suffixes below according to the material/ surface required.

| Order code suffixes | | | |
|---------------------------------|-----------------------------|----------------|---|
| Material | Suffix surface and material | Example | Standard sealing material (no additional suffix needed) |
| Steel, zinc plated, Cr(VI)-free | CF | RHZ06LREDOMDCF | NBR |
| Stainless steel | 71 | RHZ06LREDOMD71 | VIT |



Valves

RHV-M-ED Non return valve

EO 24° cone end / Male metric thread – ED-seal (ISO 9974)

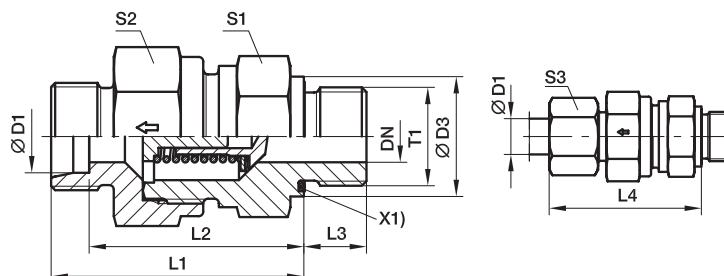

X1) Eolastic sealing

| Series | D1 | T1 | CF DN | 71 DN | D3 | L1 | L2 | L3 | L4 | S1 | CF S2 | 71 S2 | S3 | Weight g/1 piece | Order code* | PN (bar) ¹⁾ | |
|-----------------|----|----------|-------|-------|----|------|------|----|-------|----|-------|-------|----|------------------|--------------|------------------------|-----|
| | | | | | | | | | | | | | | | | CF | 71 |
| L ³⁾ | 06 | M 10×1.0 | 3.5 | 3.5 | 14 | 35.0 | 28.0 | 8 | 42.5 | 17 | 17 | 17 | 14 | 46 | RHV06LMEDOMD | 400 | 250 |
| | 08 | M 12×1.5 | 5.5 | 5.5 | 17 | 37.0 | 29.5 | 12 | 43.5 | 19 | 19 | 19 | 17 | 58 | RHV08LMEDOMD | 400 | 250 |
| | 10 | M 14×1.5 | 7.5 | 7.5 | 19 | 46.0 | 38.5 | 12 | 53.0 | 22 | 24 | 44 | 19 | 108 | RHV10LMEDOMD | 400 | 250 |
| | 12 | M 16×1.5 | 9.5 | 9.5 | 22 | 50.0 | 42.5 | 12 | 57.0 | 27 | 30 | 30 | 22 | 173 | RHV12LMEDOMD | 400 | 250 |
| | 15 | M 18×1.5 | 11.0 | 11.5 | 24 | 53.0 | 45.5 | 12 | 60.5 | 27 | 32 | 32 | 27 | 192 | RHV15LMEDOMD | 400 | 250 |
| | 18 | M 22×1.5 | 14.0 | 14.0 | 27 | 58.0 | 50.0 | 14 | 66.0 | 36 | 41 | 36 | 32 | 298 | RHV18LMEDOMD | 400 | 160 |
| | 22 | M 26×1.5 | 18.0 | 18.0 | 32 | 63.0 | 55.0 | 16 | 71.0 | 41 | 46 | 46 | 36 | 446 | RHV22LMEDOMD | 250 | 160 |
| | 28 | M 33×2.0 | 23.0 | 23.0 | 40 | 71.0 | 63.0 | 18 | 79.5 | 50 | 55 | 55 | 41 | 722 | RHV28LMEDOMD | 250 | 100 |
| | 35 | M 42×2.0 | 29.0 | 29.0 | 50 | 80.0 | 69.0 | 20 | 90.5 | 60 | 65 | 65 | 50 | 1053 | RHV35LMEDOMD | 250 | 100 |
| | 42 | M 48×2.0 | 29.0 | 29.0 | 55 | 80.0 | 68.5 | 22 | 91.0 | 65 | 70 | 70 | 60 | 1563 | RHV42LMEDOMD | 250 | 100 |
| S ⁴⁾ | 06 | M 12×1.5 | 3.5 | 3.5 | 17 | 38.5 | 31.5 | 12 | 46.0 | 19 | 19 | 19 | 17 | 70 | RHV06SMEDOMD | 420 | 400 |
| | 08 | M 14×1.5 | 3.5 | 3.5 | 19 | 38.5 | 31.5 | 12 | 46.0 | 19 | 19 | 19 | 19 | 76 | RHV08SMEDOMD | 420 | 400 |
| | 10 | M 16×1.5 | 5.5 | 5.5 | 22 | 45.5 | 38.0 | 12 | 54.0 | 22 | 24 | 24 | 22 | 124 | RHV10SMEDOMD | 420 | 400 |
| | 12 | M 18×1.5 | 7.5 | 7.5 | 24 | 48.5 | 41.0 | 12 | 57.0 | 24 | 27 | 27 | 24 | 157 | RHV12SMEDOMD | 420 | 400 |
| | 16 | M 22×1.5 | 11.0 | 11.5 | 27 | 57.0 | 48.0 | 14 | 66.0 | 32 | 36 | 36 | 30 | 296 | RHV16SMEDOMD | 420 | 315 |
| | 20 | M 27×2.0 | 15.0 | 15.0 | 32 | 63.0 | 52.0 | 16 | 73.5 | 41 | 50 | 46 | 36 | 521 | RHV20SMEDOMD | 420 | 250 |
| | 25 | M 33×2.0 | 19.0 | 19.0 | 40 | 67.0 | 54.5 | 18 | 78.5 | 46 | 55 | 50 | 46 | 648 | RHV25SMEDOMD | 420 | 250 |
| | 30 | M 42×2.0 | 24.0 | 24.0 | 50 | 78.0 | 64.0 | 20 | 90.5 | 60 | 60 | 60 | 50 | 1178 | RHV30SMEDOMD | 250 | 250 |
| | 38 | M 48×2.0 | 29.0 | 29.0 | 55 | 86.0 | 69.5 | 22 | 100.0 | 65 | 70 | 70 | 60 | 1627 | RHV38SMEDOMD | 250 | 250 |

¹⁾ Pressure shown = item deliverable

³⁾ L = light series; ⁴⁾ S = heavy series

 $\frac{\text{PN (bar)}}{10} = \text{PN (MPa)}$

Delivery without nut and ring. Information on ordering complete fittings or alternative sealing materials see page 17.

*Please add the **suffixes** below according to the material/surface required.

| Order code suffixes | | | |
|---------------------------------|-----------------------------|----------------|---|
| Material | Suffix surface and material | Example | Standard sealing material (no additional suffix needed) |
| Steel, zinc plated, Cr(VI)-free | CF | RHV06LMEDOMDCF | NBR |
| Stainless steel | 71 | RHV06LMEDOMD71 | VIT |



RHZ-M-ED Non return valve

Male metric thread – ED-seal (ISO 9974) / EO 24° cone end

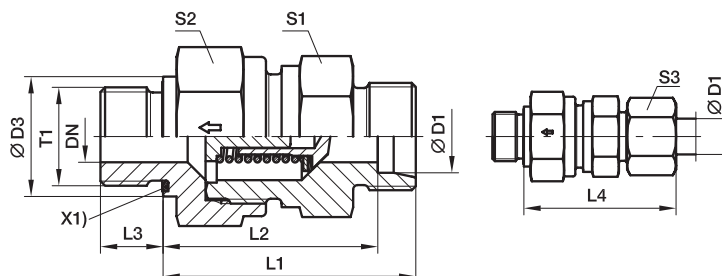

X1) Eolastic sealing

| Series | D1 | T1 | CF DN | 71 DN | D3 | L1 | L2 | L3 | L4 | S1 | CF S2 | 71 S2 | S3 | Weight g/1 piece | Order code* | PN (bar) ¹⁾ | |
|-----------------|----------|----------|-------|-------|------|------|------|------|-------|----|-------|-------|------|------------------|--------------|------------------------|-----|
| | | | | | | | | | | | | | | | | CF | 71 |
| L ³⁾ | 06 | M 10×1.0 | 3.5 | 3.5 | 14 | 33.5 | 26.5 | 8 | 41.0 | 17 | 17 | 17 | 14 | 44 | RHZ06LMEDOMD | 400 | 250 |
| | 08 | M 12×1.5 | 5.5 | 5.5 | 17 | 35.5 | 28.5 | 12 | 43.0 | 19 | 19 | 19 | 17 | 58 | RHZ08LMEDOMD | 400 | 250 |
| | 10 | M 14×1.5 | 7.5 | 7.5 | 19 | 46.0 | 38.5 | 12 | 53.0 | 22 | 24 | 24 | 19 | 104 | RHZ10LMEDOMD | 400 | 250 |
| | 12 | M 16×1.5 | 9.5 | 9.5 | 22 | 48.0 | 40.5 | 12 | 55.0 | 27 | 30 | 30 | 22 | 169 | RHZ12LMEDOMD | 400 | 250 |
| | 15 | M 18×1.5 | 11.0 | 11.5 | 24 | 50.0 | 42.5 | 12 | 57.5 | 27 | 32 | 32 | 27 | 174 | RHZ15LMEDOMD | 400 | 250 |
| | 18 | M 22×1.5 | 14.0 | 14.0 | 27 | 56.0 | 48.0 | 14 | 64.0 | 36 | 41 | 36 | 32 | 279 | RHZ18LMEDOMD | 400 | 160 |
| | 22 | M 26×1.5 | 18.0 | 18.0 | 32 | 64.0 | 56.0 | 16 | 72.0 | 41 | 46 | 46 | 36 | 459 | RHZ22LMEDOMD | 250 | 160 |
| | 28 | M 33×2.0 | 23.0 | 23.0 | 40 | 72.0 | 64.0 | 18 | 80.5 | 50 | 55 | 55 | 41 | 721 | RHZ28LMEDOMD | 250 | 100 |
| | 35 | M 42×2.0 | 29.0 | 29.0 | 50 | 81.0 | 70.0 | 20 | 91.5 | 60 | 65 | 65 | 50 | 1078 | RHZ35LMEDOMD | 250 | 100 |
| 42 | M 48×2.0 | 29.0 | 29.0 | 55 | 82.0 | 70.5 | 22 | 93.0 | 65 | 70 | 70 | 60 | 1601 | RHZ42LMEDOMD | 250 | 100 | |
| S ⁴⁾ | 06 | M 12×1.5 | 3.5 | 3.5 | 17 | 38.5 | 31.5 | 12 | 46.0 | 19 | 19 | 19 | 17 | 70 | RHZ06SMEDOMD | 420 | 400 |
| | 08 | M 14×1.5 | 3.5 | 3.5 | 19 | 38.5 | 31.5 | 12 | 46.0 | 19 | 19 | 19 | 19 | 75 | RHZ08SMEDOMD | 420 | 400 |
| | 10 | M 16×1.5 | 5.5 | 5.5 | 22 | 45.5 | 38.0 | 12 | 54.0 | 22 | 24 | 24 | 22 | 123 | RHZ10SMEDOMD | 420 | 400 |
| | 12 | M 18×1.5 | 7.5 | 7.5 | 24 | 48.5 | 41.0 | 12 | 57.0 | 24 | 27 | 27 | 24 | 157 | RHZ12SMEDOMD | 420 | 400 |
| | 16 | M 22×1.5 | 11.0 | 11.5 | 27 | 55.0 | 46.0 | 14 | 64.0 | 32 | 36 | 36 | 30 | 279 | RHZ16SMEDOMD | 420 | 315 |
| | 20 | M 27×2.0 | 15.0 | 15.0 | 32 | 61.0 | 50.0 | 16 | 71.5 | 41 | 50 | 46 | 36 | 487 | RHZ20SMEDOMD | 420 | 250 |
| | 25 | M 33×2.0 | 19.0 | 19.0 | 40 | 67.0 | 54.5 | 18 | 78.5 | 46 | 55 | 50 | 46 | 647 | RHZ25SMEDOMD | 420 | 250 |
| | 30 | M 42×2.0 | 24.0 | 24.0 | 50 | 78.0 | 64.0 | 20 | 90.5 | 60 | 60 | 60 | 50 | 1180 | RHZ30SMEDOMD | 250 | 250 |
| | 38 | M 48×2.0 | 29.0 | 29.0 | 55 | 88.0 | 71.5 | 22 | 102.0 | 65 | 70 | 70 | 60 | 1669 | RHZ38SMEDOMD | 250 | 250 |

¹⁾ Pressure shown = item deliverable

³⁾ L = light series; ⁴⁾ S = heavy series

PN (bar) = PN (MPa)
10

Delivery without nut and ring. Information on ordering complete fittings or alternative sealing materials see page 17.



*Please add the suffixes below according to the material/surface required.

| Order code suffixes | | | |
|---------------------------------|-----------------------------|----------------|---|
| Material | Suffix surface and material | Example | Standard sealing material (no additional suffix needed) |
| Steel, zinc plated, Cr(VI)-free | CF | RHZ06LMEDOMDCF | NBR |
| Stainless steel | 71 | RHZ06LMEDOMD71 | VIT |



Valves

RHDI Non return valve

Female BSPP thread (ISO 1179-1) / Female BSPP thread (ISO 1179-1)

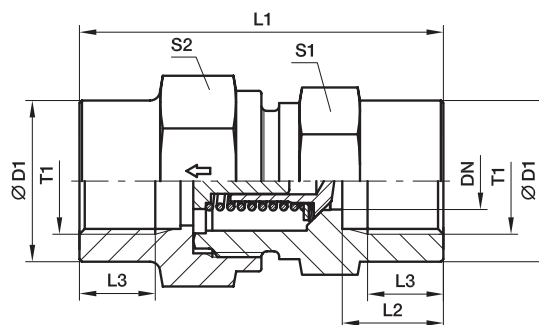

| Series | T1 | DN | D1 | L1 | L2 | L3 | S1 | S2 | Weight g/1 piece | Order code* | PN (bar) ¹⁾ | |
|-----------------|---------|------|-------|-------|------|------|----|------|---------------------|-----------------|------------------------|-----|
| | | | | | | | | | | | CF | 71 |
| L ³⁾ | G 1/8 | 3.5 | 19 | 42.5 | 12.0 | 8.0 | 19 | 19 | 76 | RHDI1/8 | 400 | 400 |
| | G 1/4 | 3.5 | 19 | 51.0 | 16.0 | 12.0 | 19 | 19 | 82 | RHDI1/4 | 400 | 400 |
| | G 3/8 | 7.5 | 24 | 60.0 | 17.0 | 12.0 | 24 | 27 | 157 | RHDI3/8 | 400 | 400 |
| | G 1/2 | 11.5 | 32 | 72.0 | 20.0 | 15.0 | 32 | 36 | 344 | RHDI1/2 | 315 | 315 |
| | G 3/4 | 15.0 | 41 | 84.0 | 22.0 | 16.5 | 41 | 46 | 664 | RHDI3/4 | 250 | 250 |
| | G 1 | 19.0 | 46 | 95.0 | 25.5 | 19.0 | 46 | 50 | 821 | RHDI1 | 250 | 250 |
| | G 1 1/4 | 24.0 | 60 | 110.0 | 28.0 | 21.5 | 60 | 60 | 1581 | RHDI11/4 | 250 | 250 |
| G 1 1/2 | 29.0 | 65 | 114.0 | 28.5 | 22.0 | 65 | 70 | 1919 | RHDI11/2 | 250 | 250 | |

¹⁾ Pressure shown = item deliverable

³⁾ L = light series

 $\frac{\text{PN (bar)}}{10} = \text{PN (MPa)}$

Delivery without nut and ring. Information on ordering complete fittings or alternative sealing materials see page 17.

| Order code suffixes | | | |
|---------------------------------|-----------------------------|-----------|---|
| Material | Suffix surface and material | Example | Standard sealing material (no additional suffix needed) |
| Steel, zinc plated, Cr(VI)-free | CF | RHDI1/8CF | NBR |
| Stainless steel | 71 | RHDI1/871 | VIT |

*Please add the **suffixes** below according to the material/surface required.

RVP Non return valve cartridge

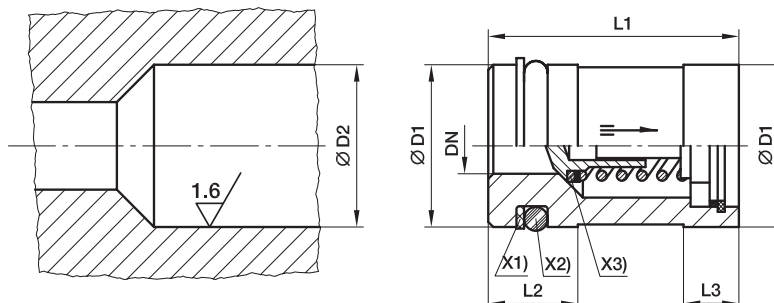

- X1) Supporting ring PTFE
- X2) O-ring NBR
- X3) Sealing disc NBR

| Valve ITL | DN | D1 | D2 | L1 ± 0,15 | L2 | L3 | O-ring | Supporting ring | Weight g/1 piece | Order code* | PN (bar) ¹⁾ | |
|-------------|------|----------------|---------------------------------|--------------|------|------|----------|-----------------|---------------------|--------------|------------------------|-----|
| | | | | | | | | | | | CF | 71 |
| 6-L/6 & 8-S | 3.5 | 12.945 ± 0.055 | 13 ^{+0.12 +0.05} | 23.15 | 9.5 | 6.0 | 8.3×2.4 | SRA 13-2.05-1.0 | 21 | RVP13 | 420 | 400 |
| 8-L/10-S | 5.5 | 15.945 ± 0.055 | 16 ^{+0.12 +0.05} | 26.65 | 9.5 | 6.5 | 11.3×2.4 | SRA 16-2.05-1.0 | 32 | RVP16 | 420 | 400 |
| 10-L/12-S | 7.5 | 19.935 ± 0.065 | 20 ^{+0.142 +0.065} | 30.15 | 9.5 | 6.5 | 15.3×2.4 | SRA 20-2.05-1.0 | 54 | RVP20 | 420 | 400 |
| 12-L/14-S | 9.5 | 23.935 ± 0.065 | 24 ^{+0.149 +0.065} | 35.15 | 12.0 | 7.5 | 18.2×3 | SRA 24-2.6-1.0 | 80 | RVP24 | 420 | 315 |
| 15-L/16-S | 11.5 | 26.935 ± 0.065 | 27 ^{+0.149 +0.065} | 38.15 | 12.0 | 7.5 | 21.2×3 | SRA 27-2.6-1.0 | 105 | RVP27 | 420 | 315 |
| 18-L/20-S | 15.0 | 34.92 ± 0.08 | 35 ^{+0.18 +0.08} | 44.65 | 12.0 | 9.5 | 29.2×3 | SRA 35-2.5-1.0 | 204 | RVP35 | 420 | 250 |
| 22-L/25-S | 19.0 | 39.92 ± 0.08 | 40 ^{+0.18 +0.08} | 50.65 | 12.0 | 11.0 | 34.2×3 | SRA 40-2.5-1.0 | 275 | RVP40 | 420 | 250 |
| 28-L/30-S | 24.0 | 46.92 ± 0.08 | 47 ^{+0.18 +0.08} | 60.15 | 13.0 | 13.0 | 41.0×3 | SRA 47-2.6-1.5 | 412 | RVP47 | 250 | 250 |
| 35-L/38-S | 29.0 | 54.905 ± 0.095 | 55 ^{+0.22 +0.01} | 70.15 | 16.0 | 13.0 | 44.2×5.7 | SRA 55-5.1-1.5 | 607 | RVP55 | 250 | 250 |

¹⁾ Pressure shown = item deliverable

$$\frac{\text{PN (bar)}}{10} = \text{PN (MPa)}$$

Delivery without nut and ring. Information on ordering complete fittings or alternative sealing materials see page 17.

P

*Please add the **suffixes** below according to the material/surface required.

| Order code suffixes | | | |
|---------------------------------|-----------------------------|---------|---|
| Material | Suffix surface and material | Example | Standard sealing material (no additional suffix needed) |
| Steel, zinc plated, Cr(VI)-free | CF | RVP13CF | NBR |
| Stainless steel | 71 | RVP1371 | VIT |

Valves

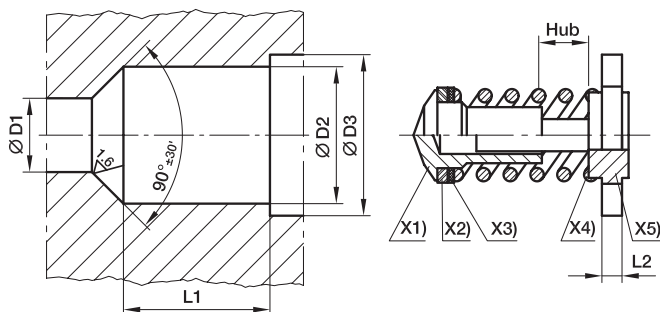
I-TL Internal parts of non return valve

- X1) poppet
- X2) sealing disc (smooth side to the poppet)
- X3) cover disc
- X4) spring
- X5) passage disc

| Series | Tube O.D. | D1 ^{+0.1} | D2 ^{+0.1} | D3 ^{+0.1} | L1 ^{+0.1} | L2 | Hub | Weight g/1 piece | Order code* | PN (bar) ¹⁾ | |
|--------|-----------|--------------------|--------------------|--------------------|--------------------|-----|-----|------------------|----------------------|------------------------|----|
| | | | | | | | | | | CF | 71 |
| L/S/S | 06/06/08 | 3.5 | 7.5 | 8.6 | 8.2 | 2.0 | 1.0 | 2 | ITL06L/06+08S | * | * |
| L/S | 08/10 | 5.5 | 10.2 | 11.6 | 11.0 | 2.0 | 1.7 | 4 | ITL08L/10S | * | * |
| L/S | 10/12 | 7.5 | 13.0 | 14.1 | 14.0 | 2.0 | 2.3 | 7 | ITL10L/12S | * | * |
| L/S | 12/14 | 9.5 | 16.7 | 18.1 | 16.5 | 2.5 | 2.9 | 13 | ITL12L/14S | * | * |
| L/S | 15/16 | 11.5 | 19.5 | 20.6 | 19.0 | 2.5 | 3.5 | 18 | ITL15L/16S | * | * |
| L/S | 18/20 | 15.0 | 25.2 | 27.1 | 22.5 | 3.0 | 4.4 | 37 | ITL18L/20S | * | * |
| L/S | 22/25 | 19.0 | 30.8 | 32.6 | 27.0 | 3.0 | 5.5 | 54 | ITL22L/25S | * | * |
| L/S | 28/30 | 24.0 | 38.6 | 40.6 | 32.5 | 3.5 | 7.3 | 107 | ITL28L/30S | * | * |
| L/L/S | 35/38/42 | 29.0 | 45.7 | 48.1 | 37.5 | 3.5 | 8.9 | 144 | ITL35L+42/38S | * | * |

* = item deliverable

Delivery without nut and ring. Information on ordering complete fittings or alternative sealing materials see page I7.

*Please add the **suffixes** below according to the material/ surface required.

| Order code suffixes | | | |
|---------------------------------|-----------------------------|-----------------|---|
| Material | Suffix surface and material | Example | Standard sealing material (no additional suffix needed) |
| Steel, zinc plated, Cr(VI)-free | CF | ITL06L/06+08S | NBR |
| Stainless steel | 71 | ITL06L71/06+08S | VIT |

RHD/V/Z Non return valves with O-Lok® or Triple-Lok® connections

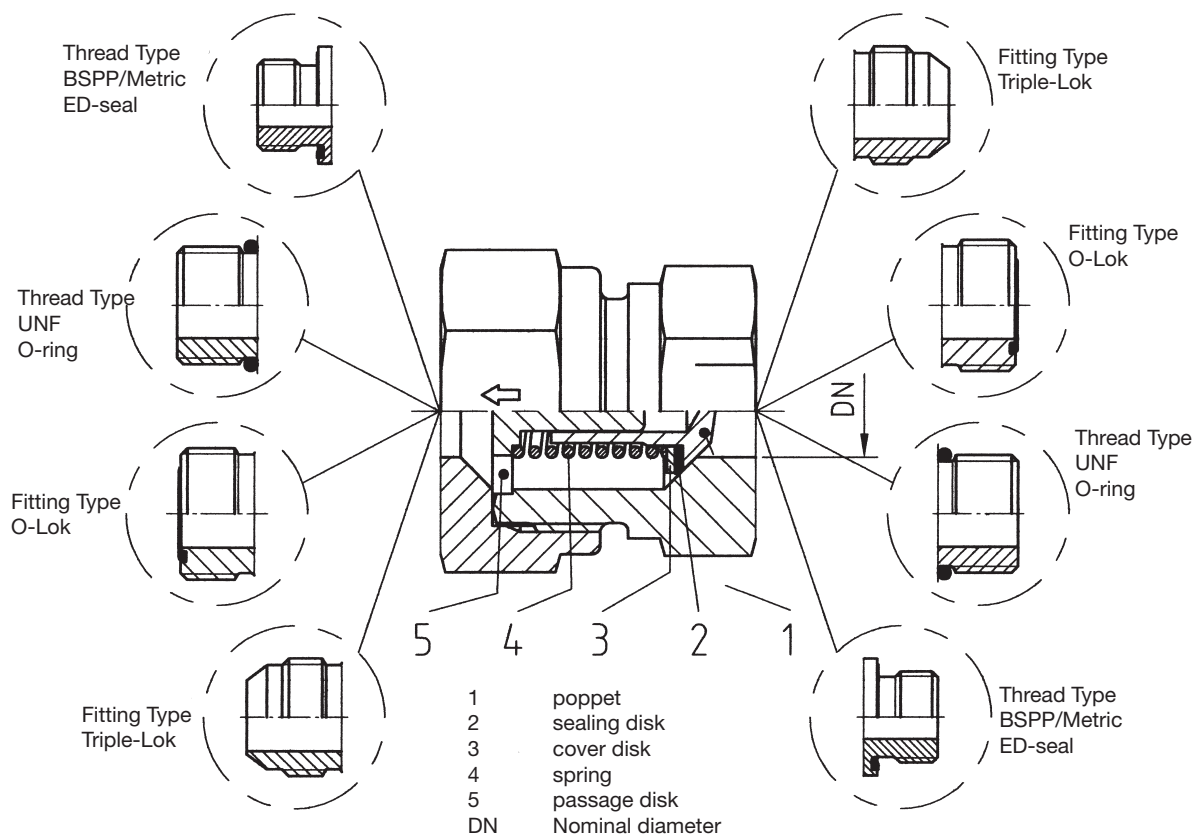

Material:

- Steel zinc-plated CF Cr(VI)-free, seals in NBR (e.g. Perbunan)
- Internal parts in stainless steel with FKM also available on request.

Perbunan = registered trademark of Bayer



Valves

RHDMLOS Non return valve

O-Lok® ORFS end / O-Lok® ORFS end

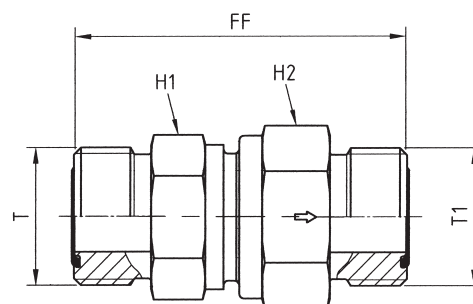

| Tube 1 O.D. | | Tube 2 O.D. | | ORFS (UN/UNF) thread T | ORFS (UN/UNF) thread T1 | H1 | H2 | FF | DN (Nom. diam.) | Weight g/1 piece | Order code* | PN (bar) ¹⁾ |
|----------------|-----------|----------------|-----------|---------------------------------|----------------------------------|----|----|------|-----------------------|---------------------|------------------|---------------------------|
| mm | Inch | mm | Inch | | | | | | | | | CF |
| 6 | 1/4 | 6 | 1/4 | 9/16-18 UNF | 9/16-18 UNF | 19 | 19 | 44.5 | 3.5 | 108 | 4RHDMLOS | 420 |
| 8, 10 | 5/16, 3/8 | 8, 10 | 5/16, 3/8 | 11/16-16 UNF | 11/16-16 UNF | 22 | 24 | 53.5 | 5.5 | 188 | 6RHDMLOS | 420 |
| 12 | 1/2 | 12 | 1/2 | 13/16-16 UNF | 13/16-16 UNF | 24 | 27 | 59.5 | 7.5 | 223 | 8RHDMLOS | 420 |
| 14, 15, 16 | 5/8 | 14, 15, 16 | 5/8 | 1-14 UNF | 1-14 UNF | 32 | 36 | 70.5 | 11.5 | 428 | 10RHDMLOS | 420 |
| 18, 20 | 3/4 | 18, 20 | 3/4 | 1 3/16-12 UNF | 1 3/16-12 UNF | 41 | 46 | 77.5 | 15.0 | 731 | 12RHDMLOS | 420 |
| 22, 25 | 1 | 22, 25 | 1 | 1 7/16-12 UNF | 1 7/16-12 UNF | 46 | 50 | 81.5 | 19.0 | 1076 | 16RHDMLOS | 420 |
| 28, 30, 32 | 1 1/4 | 28, 30, 32 | 1 1/4 | 1 11/16-12 UNF | 1 11/16-12 UNF | 60 | 60 | 91.5 | 24.0 | 1630 | 20RHDMLOS | 250 |
| 35, 38 | 1 1/2 | 35, 38 | 1 1/2 | 2-12 UNF | 2-12 UNF | 65 | 70 | 98.5 | 29.0 | 2362 | 24RHDMLOS | 250 |

1) Pressure shown = item deliverable

$$\frac{\text{PN (bar)}}{10} = \text{PN (MPa)}$$

Information on ordering complete fittings or alternative sealing materials see page 17.

*Please add the **suffixes** below according to the material/surface required.

| Order code suffixes | | | |
|---------------------------------|-----------------------------|-------------|---|
| Material | Suffix surface and material | Example | Standard sealing material (no additional suffix needed) |
| Steel, zinc plated, Cr(VI)-free | CF | 4RHDMLOS CF | NBR |



RHV42EDMLOS Non return valve

Male BSPP thread – ED-seal (ISO 1179) / O-Lok® ORFS end

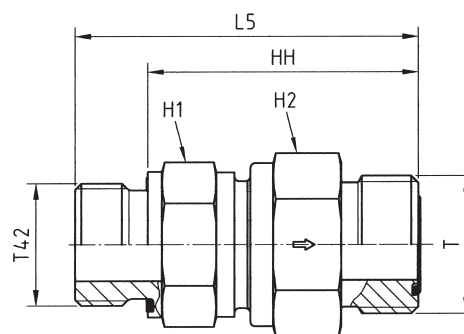

| Tube O.D. | | BSPP thread T42 | ORFS (UN/UNF) T | H1 | H2 | L5 | HH | DN (Nom. diam.) | Weight g/1 piece | Order code* | PN (bar) ¹⁾ CF |
|------------|-----------|--------------------|--------------------|----|----|-------|------|-----------------|------------------|----------------------|------------------------------|
| mm | Inch | | | | | | | | | | |
| 6 | 1/4 | G 1/8 | 9/16-18 UNF | 19 | 19 | 44.5 | 36.5 | 3.5 | 92 | 4RHV42EDMLOS | 420 |
| 8, 10 | 5/16, 3/8 | G 1/4 | 11/16-16 UNF | 24 | 27 | 56.5 | 44.5 | 6.5 | 165 | 6RHV42EDMLOS | 420 |
| 12 | 1/2 | G 3/8 | 13/16-16 UNF | 24 | 27 | 61.5 | 49.5 | 7.5 | 191 | 8RHV42EDMLOS | 420 |
| 14, 15, 16 | 5/8 | G 1/2 | 1-14 UNF | 32 | 36 | 70.0 | 56.0 | 11.5 | 366 | 10RHV42EDMLOS | 420 |
| 18, 20 | 3/4 | G 3/4 | 1 3/16-12 UNF | 41 | 46 | 77.5 | 63.5 | 15.0 | 631 | 12RHV42EDMLOS | 420 |
| 22, 25 | 1 | G 1 | 1 7/16-12 UNF | 46 | 50 | 84.0 | 66.0 | 19.0 | 863 | 16RHV42EDMLOS | 420 |
| 28, 30, 32 | 1 1/4 | G 1 1/4 | 1 11/16-12 UNF | 60 | 60 | 95.0 | 75.0 | 24.0 | 1403 | 20RHV42EDMLOS | 250 |
| 35, 38 | 1 1/2 | G 1 1/2 | 2-12 UNF | 65 | 70 | 105.0 | 83.0 | 29.0 | 1969 | 24RHV42EDMLOS | 250 |

¹⁾ Pressure shown = item deliverable

$\frac{PN \text{ (bar)}}{10} = PN \text{ (MPa)}$

Information on ordering complete fittings or alternative sealing materials see page 17.

P

*Please add the **suffixes** below according to the material/ surface required.

| Order code suffixes | | | |
|---------------------------------|-----------------------------|----------------|---|
| Material | Suffix surface and material | Example | Standard sealing material (no additional suffix needed) |
| Steel, zinc plated, Cr(VI)-free | CF | 4RHV42EDMLOSCF | NBR |

Valves

RHZ42EDMLOS Non return valve

O-Lok® ORFS end / Male BSPP thread – ED-seal (ISO 1179)

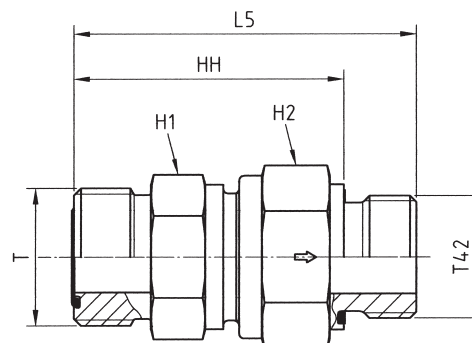

| Tube O.D. | | BSPP thread T42 | ORFS (UN/UNF) thread T | H1 | H2 | L5 | HH | DN (Nom. diam.) | Weight g/1 piece | Order code* | PN (bar) ¹⁾ |
|------------|-----------|--------------------|---------------------------|----|----|-------|------|-----------------|------------------|----------------------|------------------------|
| mm | Inch | | | | | | | | | | CF |
| 6 | 1/4 | G 1/8 | 9/16-18 UNF | 19 | 19 | 44.5 | 36.5 | 3.5 | 91 | 4RHZ42EDMLOS | 420 |
| 8, 10 | 5/16, 3/8 | G 1/4 | 11/16-16 UNF | 24 | 27 | 56.5 | 44.5 | 6.5 | 161 | 6RHZ42EDMLOS | 420 |
| 12 | 1/2 | G 3/8 | 13/16-16 UNF | 24 | 27 | 61.5 | 49.5 | 7.5 | 190 | 8RHZ42EDMLOS | 420 |
| 14, 15, 16 | 5/8 | G 1/2 | 1-14 UNF | 32 | 36 | 70.0 | 56.0 | 11.5 | 348 | 10RHZ42EDMLOS | 420 |
| 18, 20 | 3/4 | G 3/4 | 1 3/16-12 UNF | 41 | 46 | 77.5 | 53.5 | 15.0 | 634 | 12RHZ42EDMLOS | 420 |
| 22, 25 | 1 | G 1 | 1 7/16-12 UNF | 46 | 50 | 84.0 | 66.0 | 19.0 | 863 | 16RHZ42EDMLOS | 420 |
| 28, 30, 32 | 1 1/4 | G 1 1/4 | 1 11/16-12 UNF | 60 | 60 | 95.0 | 75.0 | 24.0 | 1397 | 20RHZ42EDMLOS | 250 |
| 35, 38 | 1 1/2 | G 1 1/2 | 2-12 UNF | 65 | 70 | 105.0 | 83.0 | 29.0 | 2001 | 24RHZ42EDMLOS | 250 |

¹⁾Pressure shown = item deliverable

 $\frac{\text{PN (bar)}}{10} = \text{PN (MPa)}$

Information on ordering complete fittings or alternative sealing materials see page 17.

*Please add the **suffixes** below according to the material/surface required.

| Order code suffixes | | | |
|---------------------------------|-----------------------------|----------------|---|
| Material | Suffix surface and material | Example | Standard sealing material (no additional suffix needed) |
| Steel, zinc plated, Cr(VI)-free | CF | 4RHZ42EDMLOSCF | NBR |



RHV50MLOS Non return valve

Male UN/UNF thread – O-ring (ISO 11926) / O-Lok® ORFS end

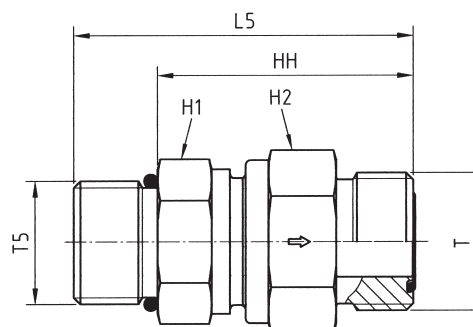

| Tube O.D. | | UNF male thread T5 | ORFS (UN/UNF) thread T | H1 | H2 | L5 | HH | DN (Nom. diam.) | Weight g/1 piece | Order code* | PN (bar) ¹⁾ |
|------------|-----------|--------------------|------------------------|----|----|------|------|-----------------|------------------|--------------------|------------------------|
| mm | Inch | | | | | | | | | | CF |
| 6 | 1/4 | 7/16-20 UNF | 9/16-18 UNF | 19 | 19 | 45.5 | 34.5 | 3.5 | 92 | 4RHV50MLOS | 420 |
| 8, 10 | 5/16, 3/8 | 9/16-18 UNF | 11/16-16 UNF | 22 | 24 | 54.5 | 42.5 | 5.5 | 165 | 6RHV50MLOS | 420 |
| 12 | 1/2 | 3/4-16 UNF | 13/16-16 UNF | 24 | 27 | 60.5 | 46.5 | 5.5 | 165 | 8RHV50MLOS | 420 |
| 14, 15, 16 | 5/8 | 7/8-14 UNF | 1-14 UNF | 32 | 36 | 71.0 | 55.0 | 11.5 | 366 | 10RHV50MLOS | 420 |
| 18, 20 | 3/4 | 1 1/16-12 UN | 1 3/16-12 UNF | 41 | 46 | 79.0 | 60.5 | 15.0 | 631 | 12RHV50MLOS | 420 |
| 22, 25 | 1 | 1 5/16-12 UN | 1 7/16-12 UNF | 46 | 50 | 82.5 | 64.0 | 19.0 | 863 | 16RHV50MLOS | 420 |
| 28, 30, 32 | 1 1/4 | 1 5/8-12 UN | 1 11/16-12 UNF | 60 | 60 | 92.5 | 74.0 | 24.0 | 1403 | 20RHV50MLOS | 250 |
| 35, 38 | 1 1/2 | 1 7/8-12 UN | 2-12 UNF | 65 | 70 | 99.5 | 81.0 | 29.0 | 1969 | 24RHV50MLOS | 250 |

¹⁾ Pressure shown = item deliverable

$\frac{PN \text{ (bar)}}{10} = PN \text{ (MPa)}$

Information on ordering complete fittings or alternative sealing materials see page 17.

P

*Please add the **suffixes** below according to the material/ surface required.

| Order code suffixes | | | |
|---------------------------------|-----------------------------|-------------|---|
| Material | Suffix surface and material | Example | Standard sealing material (no additional suffix needed) |
| Steel, zinc plated, Cr(VI)-free | CF | RHV50MLOSCF | NBR |

Valves

RHZ50MLOS Non return valve

O-Lok® ORFS end / Male UN/UNF thread – O-ring (ISO 11926)

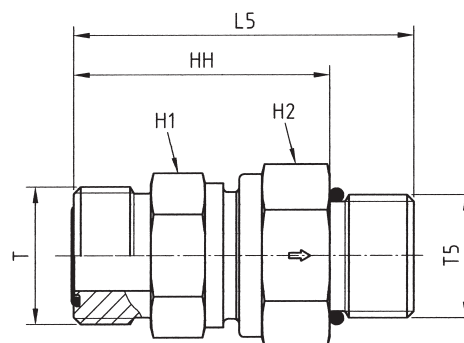

| Tube O.D. | | UNF male thread T5 | ORFS (UN/UNF) thread T | H1 | H2 | L5 | HH | DN (Nom. diam.) | Weight g/1 piece | Order code* | PN (bar) ¹⁾ |
|------------|-----------|--------------------|------------------------|----|----|------|------|-----------------|------------------|--------------------|------------------------|
| mm | Inch | | | | | | | | | | CF |
| 6 | 1/4 | 7/16-20 UNF | 9/16-18 UNF | 19 | 19 | 45.5 | 34.5 | 3.5 | 91 | 4RHZ50MLOS | 420 |
| 8, 10 | 5/16, 3/8 | 9/16-18 UNF | 11/16-16 UNF | 22 | 24 | 54.5 | 42.5 | 5.5 | 161 | 6RHZ50MLOS | 420 |
| 12 | 1/2 | 3/4-16 UNF | 13/16-16 UNF | 24 | 27 | 60.5 | 46.5 | 5.5 | 161 | 8RHZ50MLOS | 420 |
| 14, 15, 16 | 5/8 | 7/8-14 UNF | 1-14 UNF | 32 | 36 | 71.0 | 55.0 | 11.5 | 348 | 10RHZ50MLOS | 420 |
| 18, 20 | 3/4 | 1 1/16-12 UN | 1 3/16-12 UNF | 41 | 46 | 79.0 | 60.5 | 15.0 | 634 | 12RHZ50MLOS | 420 |
| 22, 25 | 1 | 1 5/16-12 UN | 1 7/16-12 UNF | 46 | 50 | 82.5 | 64.0 | 19.0 | 863 | 16RHZ50MLOS | 420 |
| 28, 30, 32 | 1 1/4 | 1 5/8-12 UN | 1 11/16-12 UNF | 60 | 60 | 92.5 | 74.0 | 24.0 | 1397 | 20RHZ50MLOS | 250 |
| 35, 38 | 1 1/2 | 1 7/8-12 UN | 2-12 UNF | 65 | 70 | 99.5 | 81.0 | 29.0 | 2001 | 24RHZ50MLOS | 250 |

¹⁾ Pressure shown = item deliverable

$$\frac{\text{PN (bar)}}{10} = \text{PN (MPa)}$$

Information on ordering complete fittings or alternative sealing materials see page 17.

*Please add the **suffixes** below according to the material/ surface required.

| Order code suffixes | | | |
|---------------------------------|-----------------------------|--------------|---|
| Material | Suffix surface and material | Example | Standard sealing material (no additional suffix needed) |
| Steel, zinc plated, Cr(VI)-free | CF | 4RHZ50MLOSCF | NBR |



RHV82EDMLOS Non return valve

Male metric thread – ED-seal (ISO 9974) / O-Lok® ORFS end

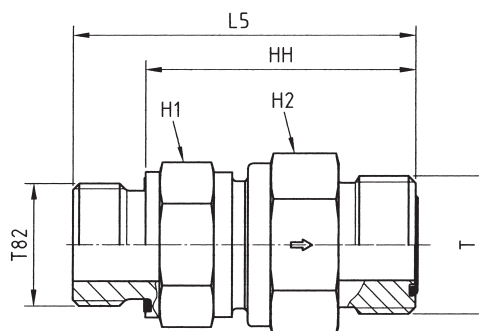

| Tube O.D. | | metric thread T82 | ORFS (UN/UNF) thread T | H1 | H2 | L5 | HH | DN (Nom. diam.) | Weight g/1 piece | Order code* | PN (bar) ¹⁾ |
|------------|-----------|-------------------|------------------------|----|----|-------|------|-----------------|------------------|-------------------------|------------------------|
| mm | Inch | | | | | | | | | | CF |
| 6 | 1/4 | M 12×1.5 | 9/16-18 UNF | 19 | 19 | 48.5 | 36.5 | 3.5 | 89 | 4M12RHV82EDMLOS | 420 |
| 8, 10 | 5/16, 3/8 | M 16×1.5 | 11/16-16 UNF | 22 | 24 | 56.5 | 44.5 | 5.5 | 157 | 6M16RHV82EDMLOS | 420 |
| 12 | 1/2 | M 18×1.5 | 13/16-16 UNF | 24 | 27 | 61.5 | 49.5 | 7.5 | 195 | 8M18RHV82EDMLOS | 420 |
| 14, 15, 16 | 5/8 | M 22×1.5 | 1-14 UNF | 32 | 36 | 72.0 | 58.0 | 11.5 | 369 | 10M22RHV82EDMLOS | 420 |
| | | | 1 3/16-12 UNF | 41 | 46 | 79.5 | 63.5 | 15.0 | 628 | 12M27RHV82EDMLOS | 420 |
| 22, 25 | 1 | M 33×2.0 | 1 7/16-12 UNF | 46 | 50 | 84.0 | 66.0 | 19.0 | 867 | 16M33RHV82EDMLOS | 420 |
| 28, 30, 32 | 1 1/4 | M 42×2.0 | 1 11/16-12 UNF | 60 | 60 | 95.0 | 75.0 | 24.0 | 1409 | 20M42RHV82EDMLOS | 250 |
| 35, 38 | 1 1/2 | M 48×2.0 | 2-12 UNF | 65 | 70 | 103.0 | 81.0 | 29.0 | 1970 | 24M48RHV82EDMLOS | 250 |

¹⁾ Pressure shown = item deliverable

$\frac{\text{PN (bar)}}{10} = \text{PN (MPa)}$

Information on ordering complete fittings or alternative sealing materials see page 17.

*Please add the **suffixes** below according to the material/surface required.

| Order code suffixes | | | |
|---------------------------------|-----------------------------|-----------------|---|
| Material | Suffix surface and material | Example | Standard sealing material (no additional suffix needed) |
| Steel, zinc plated, Cr(VI)-free | CF | 4M12RHV82EDMLOS | NBR |

Valves

RHZ82EDMLOS Non return valve

O-Lok® ORFS end / Male metric thread – ED-seal (ISO 9974)

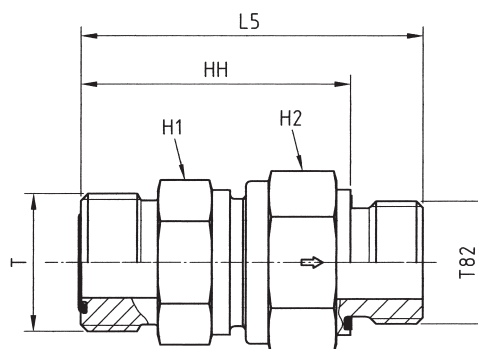

| Tube O.D. | | metric thread T82 | ORFS (UN/UNF) thread T | H1 | H2 | L5 | HH | DN (Nom. diam.) | Weight g/1 piece | Order code* | PN (bar) ¹⁾ |
|------------|-----------|-------------------|------------------------|----|----|-------|------|-----------------|------------------|-------------------------|------------------------|
| mm | Inch | | | | | | | | | | CF |
| 6 | 1/4 | M 12×1.5 | 9/16-18 UNF | 19 | 19 | 48.5 | 36.5 | 3.5 | 89 | 4M12RHZ82EDMLOS | 420 |
| 8, 10 | 5/16, 3/8 | M 16×1.5 | 11/16-16 UNF | 24 | 27 | 59.1 | 47.1 | 7.5 | 156 | 6M16RHZ82EDMLOS | 420 |
| 12 | 1/2 | M 18×1.5 | 13/16-16 UNF | 24 | 27 | 61.5 | 49.5 | 7.5 | 195 | 8M18RHZ82EDMLOS | 420 |
| 14, 15, 16 | 5/8 | M 22×1.5 | 1-14 UNF | 32 | 36 | 70.0 | 56.0 | 11.5 | 352 | 10M22RHZ82EDMLOS | 420 |
| 18, 20 | 3/4 | M 27×2.0 | 1 3/16-12 UNF | 41 | 46 | 77.5 | 61.5 | 15.0 | 608 | 12M27RHZ82EDMLOS | 420 |
| 22, 25 | 1 | M 33×2.0 | 1 7/16-12 UNF | 46 | 50 | 84.0 | 66.0 | 19.0 | 965 | 16M33RHZ82EDMLOS | 420 |
| 28, 30, 32 | 1 1/4 | M 42×2.0 | 1 11/16-12 UNF | 60 | 60 | 95.0 | 75.0 | 24.0 | 1396 | 20M42RHZ82EDMLOS | 250 |
| 35, 38 | 1 1/2 | M 48×2.0 | 2-12 UNF | 65 | 70 | 115.0 | 93.0 | 29.0 | 1978 | 24M48RHZ82EDMLOS | 250 |

¹⁾Pressure shown = item deliverable

$$\frac{\text{PN (bar)}}{10} = \text{PN (MPa)}$$

Information on ordering complete fittings or alternative sealing materials see page I7.

*Please add the **suffixes** below according to the material/surface required.

| Order code suffixes | | | |
|---------------------------------|-----------------------------|-------------------|---|
| Material | Suffix surface and material | Example | Standard sealing material (no additional suffix needed) |
| Steel, zinc plated, Cr(VI)-free | CF | 4M12RHZ82EDMLOSCF | NBR |



RHDMTXS Non return valve

Triple-Lok® 37° flare end / Triple-Lok® 37° flare end

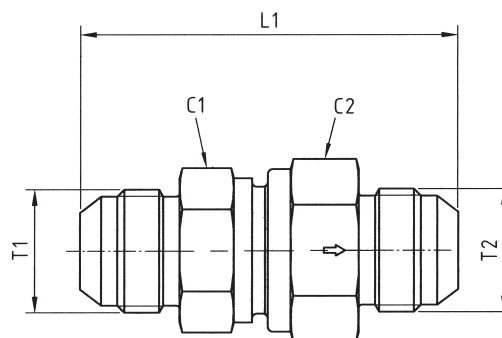

| Tube 1 O.D. | | Tube 2 O.D. | | Thread JIC SAE T1 | Thread JIC SAE T2 | C1 | C2 | L1 | DN (Nom. diam.) | Weight g/1 piece | Order code* | PN (bar) ¹⁾ CF |
|----------------|-------|----------------|-------|----------------------------|----------------------------|----|----|-------|-----------------------|---------------------|------------------|---------------------------------|
| mm | Inch | mm | Inch | | | | | | | | | |
| 6 | 1/4 | 6 | 1/4 | 7/16-20 UNF | 7/16-20 UNF | 19 | 19 | 52.5 | 3.5 | 108 | 4RHDMTXS | 420 |
| 8 | 5/16 | 8 | 5/16 | 1/2-20 UNF | 1/2-20 UNF | 22 | 24 | 59.5 | 5.5 | 188 | 5RHDMTXS | 420 |
| 10 | 3/8 | 10 | 3/8 | 9/16-18 UNF | 9/16-18 UNF | 24 | 27 | 61.5 | 7.5 | 223 | 6RHDMTXS | 420 |
| 12 | 1/2 | 12 | 1/2 | 3/4-16 UNF | 3/4-16 UNF | 27 | 32 | 69.5 | 9.5 | 324 | 8RHDMTXS | 420 |
| 14, 15, 16 | 5/8 | 14, 15, 16 | 5/8 | 7/8-14 UNF | 7/8-14 UNF | 32 | 36 | 78.5 | 11.5 | 428 | 10RHDMTXS | 350 |
| 18, 20 | 3/4 | 18, 20 | 3/4 | 1 1/16-12 UN | 1 1/16-12 UN | 41 | 46 | 87.5 | 15.0 | 731 | 12RHDMTXS | 350 |
| 25 | 1 | 25 | 1 | 1 5/16-12 UN | 1 5/16-12 UN | 46 | 50 | 92.5 | 19.0 | 1076 | 16RHDMTXS | 280 |
| 28, 30, 32 | 1 1/4 | 28, 30, 32 | 1 1/4 | 1 5/8-12 UN | 1 5/8-12 UN | 60 | 60 | 105.5 | 24.0 | 1630 | 20RHDMTXS | 250 |
| 35, 38 | 1 1/2 | 35, 38 | 1 1/2 | 1 7/8-12 UN | 1 7/8-12 UN | 65 | 70 | 118.5 | 29.0 | 2362 | 24RHDMTXS | 210 |

¹⁾ Pressure shown = item deliverable

$$\frac{\text{PN (bar)}}{10} = \text{PN (MPa)}$$

Information on ordering complete fittings or alternative sealing materials see page 17.

P

*Please add the **suffixes** below according to the material/surface required.

| Order code suffixes | | | |
|---------------------------------|-----------------------------|-------------|---|
| Material | Suffix surface and material | Example | Standard sealing material (no additional suffix needed) |
| Steel, zinc plated, Cr(VI)-free | CF | 4RHDMTXS CF | NBR |

Valves

RHV42EDMXS Non return valve

Male BSPP thread – ED-seal (ISO 1179) / Triple-Lok® 37° flare end

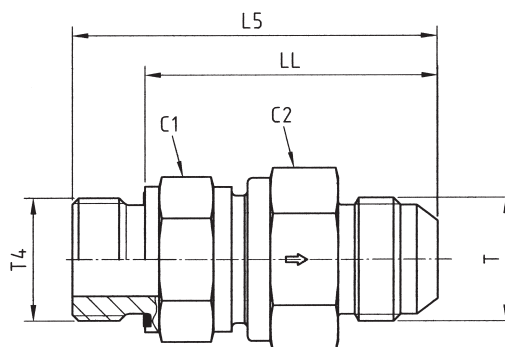

| Tube O.D. | | BSPP thread T4 | Thread JIC SAE T | C1 | C2 | L5 | LL | DN (Nom. diam.) | Weight g/1 piece | Order code* | PN (bar) ¹⁾ |
|------------|-------|-------------------|------------------------|----|----|-------|------|--------------------|---------------------|----------------------|---------------------------|
| mm | Inch | | | | | | | | | | CF |
| 6 | 1/4 | G 1/8 | 7/16-20 UNF | 19 | 19 | 48.0 | 40.0 | 3.5 | 92 | 4RHV42EDMXS | 420 |
| 8 | 5/16 | G 1/4 | 1/2-20 UNF | 22 | 24 | 59.5 | 47.5 | 5.5 | 165 | 5-4RHV42EDMXS | 420 |
| 10 | 3/8 | G 1/4 | 9/16-18 UNF | 24 | 27 | 62.0 | 50.0 | 7.5 | 191 | 6RHV42EDMXS | 420 |
| 12 | 1/2 | G 3/8 | 3/4-16 UNF | 27 | 32 | 67.0 | 55.0 | 9.5 | 277 | 8RHV42EDMXS | 420 |
| 14, 15, 16 | 5/8 | G 1/2 | 7/8-14 UNF | 32 | 36 | 76.0 | 62.0 | 11.5 | 366 | 10RHV42EDMXS | 350 |
| 18, 20 | 3/4 | G 3/4 | 1 1/16-12 UN | 41 | 46 | 84.5 | 68.5 | 15.0 | 631 | 12RHV42EDMXS | 350 |
| 25 | 1 | G 1 | 1 5/16-12 UN | 46 | 50 | 89.5 | 71.5 | 19.0 | 863 | 16RHV42EDMXS | 280 |
| 28, 30, 32 | 1 1/4 | G 1 1/4 | 1 5/8-12 UN | 60 | 60 | 102.0 | 82.0 | 24.0 | 1403 | 20RHV42EDMXS | 250 |
| 35, 38 | 1 1/2 | G 1 1/2 | 1 7/8-12 UN | 65 | 70 | 113.0 | 91.0 | 29.0 | 1969 | 24RHV42EDMXS | 210 |

¹⁾Pressure shown = item deliverable

$$\frac{\text{PN (bar)}}{10} = \text{PN (MPa)}$$

Information on ordering complete fittings or alternative sealing materials see page I7.

*Please add the **suffixes** below according to the material/surface required.

| Order code suffixes | | | |
|---------------------------------|-----------------------------|---------------|---|
| Material | Suffix surface and material | Example | Standard sealing material (no additional suffix needed) |
| Steel, zinc plated, Cr(VI)-free | CF | 4RHV42EDMXSCF | NBR |



RHZ42EDMXS Non return valve

Triple-Lok® 37° flare end / Male BSPP thread – ED-seal (ISO 1179)

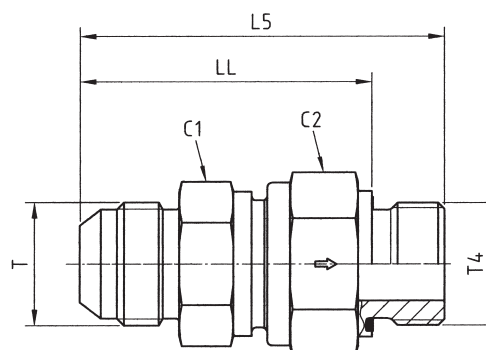

| Tube O.D. | | BSPP thread T4 | Thread JIC SAE T | C1 | C2 | L5 | LL | DN (Nom. diam.) | Weight g/1 piece | Order code* | PN (bar) ¹⁾ |
|------------|-------|-------------------|------------------------|----|----|-------|------|--------------------|---------------------|----------------------|---------------------------|
| mm | Inch | | | | | | | | | | CF |
| 6 | 1/4 | G 1/8 | 7/16-20 UNF | 19 | 19 | 48.0 | 40.0 | 3.5 | 89 | 4RHZ42EDMXS | 420 |
| 8 | 5/16 | G 1/4 | 1/2-20 UNF | 22 | 24 | 59.0 | 47.0 | 5.5 | 156 | 5-4RHZ42EDMXS | 420 |
| 10 | 3/8 | G 1/4 | 9/16-18 UNF | 24 | 27 | 62.0 | 50.0 | 7.5 | 190 | 6RHZ42EDMXS | 420 |
| 12 | 1/2 | G 3/8 | 3/4-16 UNF | 27 | 32 | 66.0 | 54.0 | 9.5 | 278 | 8RHZ42EDMXS | 420 |
| 14, 15, 16 | 5/8 | G 1/2 | 7/8-14 UNF | 32 | 36 | 74.0 | 60.0 | 11.5 | 348 | 10RHZ42EDMXS | 350 |
| 18, 20 | 3/4 | G 3/4 | 1 1/16-12 UN | 41 | 46 | 82.5 | 66.5 | 15.0 | 634 | 12RHZ42EDMXS | 350 |
| 25 | 1 | G 1 | 1 5/16-12 UN | 46 | 50 | 89.5 | 71.5 | 19.0 | 863 | 16RHZ42EDMXS | 280 |
| 28, 30, 32 | 1 1/4 | G 1 1/4 | 1 5/8-12 UN | 60 | 60 | 102.0 | 82.0 | 24.0 | 1397 | 20RHZ42EDMXS | 250 |
| 35, 38 | 1 1/2 | G 1 1/2 | 1 7/8-12 UN | 65 | 70 | 115.0 | 93.0 | 29.0 | 2001 | 24RHZ42EDMXS | 210 |

¹⁾Pressure shown = item deliverable

$$\frac{\text{PN (bar)}}{10} = \text{PN (MPa)}$$

Information on ordering complete fittings or alternative sealing materials see page I7.

P

*Please add the **suffixes** below according to the material/surface required.

| Order code suffixes | | | |
|---------------------------------|-----------------------------|---------------|---|
| Material | Suffix surface and material | Example | Standard sealing material (no additional suffix needed) |
| Steel, zinc plated, Cr(VI)-free | CF | 4RHZ42EDMXSCF | NBR |

Valves

RHV5OMXS Non return valve

Male UN/UNF thread – O-ring (ISO 11926) / Triple-Lok® 37° flare end

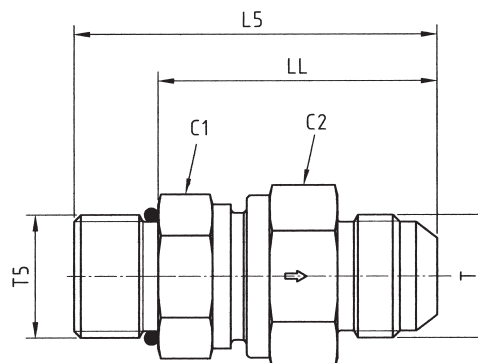

| Tube O.D. | | Thread UNF T5 | Thread JIC SAE T | C1 | C2 | L5 | LL | DN (Nom. diam.) | Weight g/1 piece | Order code* | PN (bar) ¹⁾ |
|------------|-------|---------------|------------------|----|----|-------|------|-----------------|------------------|-------------------|------------------------|
| mm | Inch | | | | | | | | | | CF |
| 6 | 1/4 | 7/16-20 UNF | 7/16-20 UNF | 19 | 19 | 49.5 | 38.5 | 3.5 | 92 | 4RHV5OMXS | 420 |
| 8 | 5/16 | 1/2-20 UNF | 1/2-20 UNF | 22 | 24 | 56.5 | 45.5 | 5.5 | 165 | 5RHV5OMXS | 420 |
| 10 | 3/8 | 9/16-18 UNF | 9/16-18 UNF | 24 | 27 | 59.5 | 47.5 | 7.5 | 191 | 6RHV5OMXS | 420 |
| 12 | 1/2 | 3/4-16 UNF | 3/4-16 UNF | 27 | 32 | 66.5 | 52.5 | 9.5 | 277 | 8RHV5OMXS | 420 |
| 14, 15, 16 | 5/8 | 7/8-14 UNF | 7/8-14 UNF | 32 | 36 | 75.0 | 59.0 | 11.5 | 366 | 10RHV5OMXS | 350 |
| 18, 20 | 3/4 | 1 1/16-12 UN | 1 1/16-12 UN | 41 | 46 | 84.0 | 65.5 | 15.0 | 631 | 12RHV5OMXS | 350 |
| 25 | 1 | 1 5/16-12 UN | 1 5/16-12 UN | 46 | 50 | 88.0 | 69.5 | 19.0 | 863 | 16RHV5OMXS | 280 |
| 28, 30, 32 | 1 1/4 | 1 5/8-12 UN | 1 5/8-12 UN | 60 | 60 | 99.5 | 81.0 | 24.0 | 1403 | 20RHV5OMXS | 250 |
| 35, 38 | 1 1/2 | 1 7/8-12 UN | 1 7/8-12 UN | 65 | 70 | 109.5 | 91.0 | 29.0 | 1969 | 24RHV5OMXS | 210 |

¹⁾Pressure shown = item deliverable

$$\frac{\text{PN (bar)}}{10} = \text{PN (MPa)}$$

Information on ordering complete fittings or alternative sealing materials see page 17.

*Please add the **suffixes** below according to the material/surface required.

| Order code suffixes | | | |
|---------------------------------|-----------------------------|------------------------|---|
| Material | Suffix surface and material | Example | Standard sealing material (no additional suffix needed) |
| Steel, zinc plated, Cr(VI)-free | CF | RHV5OMXS ^{CF} | NBR |



RHZ5OMXS Non return valve

Triple-Lok® 37° flare end / Male UN/UNF thread – O-ring (ISO 11926)

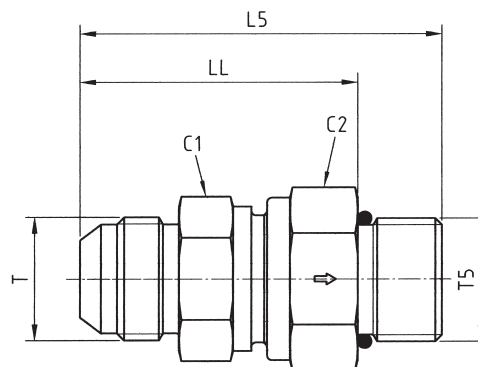

| Tube O.D. | | Thread UNF T5 | Thread JIC SAE T | C1 | C2 | L5 | LL | DN (Nom. diam.) | Weight g/1 piece | Order code* | PN (bar) ¹⁾ |
|------------|-------|---------------|------------------|----|----|-------|------|-----------------|------------------|-------------------|------------------------|
| mm | Inch | | | | | | | | | | CF |
| 6 | 1/4 | 7/16-20 UNF | 7/16-18 UNF | 19 | 19 | 49.5 | 38.5 | 3.5 | 91 | 4RHZ5OMXS | 420 |
| 8 | 5/16 | 1/2-20 UNF | 1/2-20 UNF | 22 | 24 | 56.5 | 45.5 | 5.5 | 161 | 5RHZ5OMXS | 420 |
| 10 | 3/8 | 9/16-18 UNF | 9/16-18 UNF | 24 | 27 | 59.5 | 47.5 | 7.5 | 190 | 6RHZ5OMXS | 420 |
| 12 | 1/2 | 3/4-16 UNF | 3/4-16 UNF | 27 | 32 | 66.5 | 52.5 | 9.5 | 278 | 8RHZ5OMXS | 420 |
| 14, 15, 16 | 5/8 | 7/8-14 UNF | 7/8-14 UNF | 32 | 36 | 75.0 | 59.0 | 11.5 | 348 | 10RHZ5OMXS | 350 |
| 18, 20 | 3/4 | 1 1/16-12 UN | 1 1/16-12 UN | 41 | 46 | 84.0 | 65.5 | 15.0 | 634 | 12RHZ5OMXS | 350 |
| 25 | 1 | 1 5/16-12 UN | 1 5/16-12 UN | 46 | 50 | 88.0 | 69.5 | 19.0 | 863 | 16RHZ5OMXS | 280 |
| 28, 30, 32 | 1 1/4 | 1 5/8-12 UN | 1 5/8-12 UN | 60 | 60 | 107.0 | 81.0 | 24.0 | 1397 | 20RHZ5OMXS | 250 |
| 35, 38 | 1 1/2 | 1 7/8-12 UN | 1 7/8-12 UN | 65 | 70 | 109.5 | 91.0 | 29.0 | 2001 | 24RHZ5OMXS | 210 |

¹⁾ Pressure shown = item deliverable

$$\frac{\text{PN (bar)}}{10} = \text{PN (MPa)}$$

Information on ordering complete fittings or alternative sealing materials see page 17.

P

*Please add the **suffixes** below according to the material/ surface required.

| Order code suffixes | | | |
|---------------------------------|-----------------------------|-------------------------|---|
| Material | Suffix surface and material | Example | Standard sealing material (no additional suffix needed) |
| Steel, zinc plated, Cr(VI)-free | CF | 4RHZ5OMXS ^{CF} | NBR |



Valves

RHV82EDMXS Non return valve

Male metric thread – ED-seal (ISO 9974) / Triple-Lok® 37° flare end

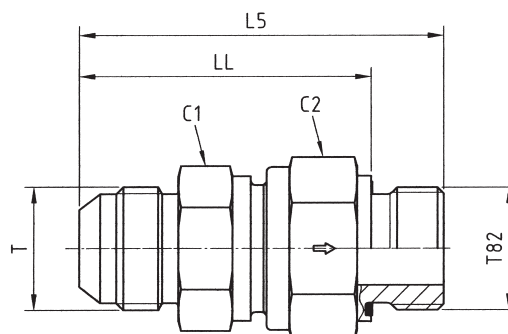

| Tube O.D. | | Metric thread T82 | Thread JIC SAE T | C1 | C2 | L5 | LL | DN (Nom. diam.) | Weight g/1 piece | Order code* | PN (bar) ¹⁾ |
|------------|-------|-------------------|------------------|----|----|-------|------|-----------------|------------------|------------------------|------------------------|
| mm | Inch | | | | | | | | | | CF |
| 6 | 1/4 | M 10×1.0 | 7/16-20 UNF | 19 | 19 | 48.0 | 40.0 | 3.5 | 89 | 4M10RHV82EDMXS | 420 |
| 8 | 5/16 | M 12×1.5 | 1/2-20 UNF | 22 | 24 | 59.5 | 47.5 | 5.5 | 157 | 5M12RHV82EDMXS | 420 |
| 10 | 3/8 | M 14×1.5 | 9/16-18 UNF | 24 | 27 | 62.0 | 50.0 | 7.5 | 195 | 6M14RHV82EDMXS | 420 |
| 12 | 1/2 | M 16×1.5 | 3/4-16 UNF | 27 | 32 | 67.0 | 55.0 | 9.5 | 274 | 8M16RHV82EDMXS | 420 |
| 14, 15, 16 | 5/8 | M 18×1.5 | 7/8-14 UNF | 32 | 36 | 73.5 | 61.5 | 11.5 | 369 | 10M18RHV82EDMXS | 350 |
| 18, 20 | 3/4 | M 27×2.0 | 1 1/16-12 UN | 41 | 46 | 84.5 | 68.5 | 15.0 | 628 | 12M27RHV82EDMXS | 350 |
| 25 | 1 | M 33×2.0 | 1 5/16-12 UN | 46 | 50 | 89.5 | 71.5 | 19.0 | 867 | 16M33RHV82EDMXS | 280 |
| 28, 30, 32 | 1 1/4 | M 42×2.0 | 1 5/8-12 UN | 60 | 60 | 102.0 | 82.0 | 24.0 | 1409 | 20M42RHV82EDMXS | 250 |
| 35, 38 | 1 1/2 | M 48×2.0 | 1 7/8-12 UN | 65 | 70 | 113.0 | 91.0 | 29.0 | 1970 | 24M48RHV82EDMXS | 210 |

¹⁾Pressure shown = item deliverable

$$\frac{\text{PN (bar)}}{10} = \text{PN (MPa)}$$

Information on ordering complete fittings or alternative sealing materials see page 17.

*Please add the **suffixes** below according to the material/surface required.

| Order code suffixes | | | |
|---------------------------------|-----------------------------|------------------|---|
| Material | Suffix surface and material | Example | Standard sealing material (no additional suffix needed) |
| Steel, zinc plated, Cr(VI)-free | CF | 4M10RHV82EDMXSCF | NBR |



RHZ82EDMXS Non return valve

Triple-Lok® 37° flare end / Male metric thread – ED-seal (ISO 9974)

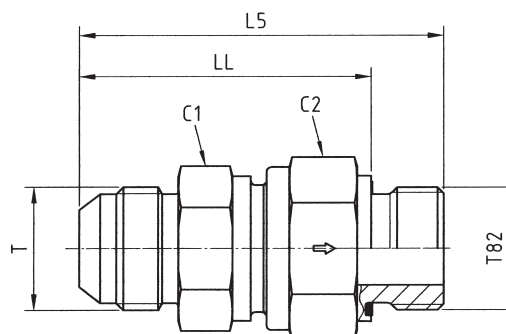

| Tube O.D. | | Metric thread T82 | Thread JIC SAE T | C1 | C2 | L5 | LL | DN (Nom. diam.) | Weight g/1 piece | Order code* | PN (bar) ¹⁾ |
|------------|-------|-------------------|------------------|----|----|-------|------|-----------------|------------------|------------------------|------------------------|
| mm | Inch | | | | | | | | | | CF |
| 6 | 1/4 | M 10×1.0 | 7/16-20 UNF | 19 | 19 | 48.0 | 40.0 | 3.5 | 89 | 4M10RHZ82EDMXS | 420 |
| 8 | 5/16 | M 12×1.5 | 1/2-20 UNF | 22 | 24 | 59.5 | 47.5 | 5.5 | 156 | 5M12RHZ82EDMXS | 420 |
| 10 | 3/8 | M 14×1.5 | 9/16-18 UNF | 24 | 27 | 62.0 | 50.0 | 7.5 | 195 | 6M14RHZ82EDMXS | 420 |
| 12 | 1/2 | M 16×1.5 | 3/4-16 UNF | 27 | 32 | 66.0 | 54.0 | 9.5 | 272 | 8M16RHZ82EDMXS | 420 |
| 14, 15, 16 | 5/8 | M 18×1.5 | 7/8-14 UNF | 32 | 36 | 71.5 | 59.5 | 11.5 | 352 | 10M18RHZ82EDMXS | 350 |
| 18, 20 | 3/4 | M 27×2.0 | 1 1/16-12 UN | 41 | 46 | 82.5 | 66.5 | 15.0 | 608 | 12M27RHZ82EDMXS | 350 |
| 25 | 1 | M 33×2.0 | 1 5/16-12 UN | 46 | 50 | 89.5 | 71.5 | 19.0 | 965 | 16M33RHZ82EDMXS | 280 |
| 28, 30, 32 | 1 1/4 | M 42×2.0 | 1 5/8-12 UN | 60 | 60 | 102.0 | 82.0 | 24.0 | 1396 | 20M42RHZ82EDMXS | 250 |
| 35, 38 | 1 1/2 | M 48×2.0 | 1 7/8-12 UN | 65 | 70 | 115.0 | 93.0 | 29.0 | 1807 | 24M48RHZ82EDMXS | 210 |

¹⁾Pressure shown = item deliverable

$$\frac{\text{PN (bar)}}{10} = \text{PN (MPa)}$$

Information on ordering complete fittings or alternative sealing materials see page 17.

P

*Please add the **suffixes** below according to the material/surface required.

| Order code suffixes | | | |
|---------------------------------|-----------------------------|------------------|---|
| Material | Suffix surface and material | Example | Standard sealing material (no additional suffix needed) |
| Steel, zinc plated, Cr(VI)-free | CF | 4M10RHZ82EDMXSCF | NBR |

Ball valves

Technical data ball valves

Leakage rate

0 drops/bubbles per min. (DIN EN 12266 and ISO 5208)

The pressure ratings PN for ball- and shut off- valves include design factor 1.5 for the body and 1.1 for the ball seat (according to DIN EN 12266 and ISO 5208).

Steel Ball Valves

Materials:

Body: Steel, Cr(VI)-free plated
Ball: Hardchrome plated carbon steel
Stem: Steel, Cr(VI)-free plated

Seals:

Ball seat: POM
Stem seal: NBR
According to application, different seal combinations are available.

Temperature range:*

-10 up to +100 °C.

Stainless Steel Ball Valves

Materials:

Body: Stainless steel
Ball: Stainless steel
Connectors: Stainless steel

Seals:

Ball seat: POM
Stem seal: NBR
According to application, different seal combinations are available.

Temperature range:

-30 up to +100°C.

(Caution: reduced pressure ratings, see pages P37ff).

Applications:

Suitable for petroleum based hydraulic fluid, lubricants and fuel oil.

Different media and applications on request*

Caution!

Please note the admissible pressure ratings for the tube connection. Ball valves are not suitable for use as flow restriction.

*Remarks:

For clarification of the suitability of the ball valves for different media and applications please provide the following data: system pressure, medium, temperature, possible pressure peaks (including pressure and frequency) and possible operation with full differential pressure.

Certifications and approvals

On demand

3.1 Material certificate (DIN EN 10204)
3.1 Pressure test (DIN EN 10204)
3.2 Certificate (DIN EN 10204)
DNV/GL
ABS
BV
Other certificates on request

Additional components and custom designs

on request

Locking devices (P51)
Levers
Actuators
Limit switches
Ball valves for gas applications
Ball valve combinations
High pressure/High temperature ball valves
Fire safe/ATEX
Custom made special blocks



Material properties

Material of body, connections, ball and stem

| | Pressure reduction in % in relation to permitted system temperature in °C | | | | | | | | | | | | | |
|-----------------|---|------|------|------|------|------|----|------|------|-------|-------|-------|-------|-------|
| | -60° | -50° | -40° | -30° | -20° | -10° | 0° | +20° | +80° | +100° | +120° | +130° | +150° | +200° |
| Steel | 0% | | | | | | | | | | | | | |
| Low alloy steel | 25% | | | | 0% | | | | | | | | | |
| Stainless steel | 0% | | | | | | | | | | 11% | | | |
| Duplex | 0% | | | | | | | | | | 20% | | | |

Sealing material ball seat

| | Pressure reduction in % in relation to permitted system temperature in °C | | | | | | | | | | | | | |
|-------------------------|---|------|------|------|------|------|----|------|------|-------|-------|-------|-------|-------|
| | -60° | -50° | -40° | -30° | -20° | -10° | 0° | +20° | +80° | +100° | +120° | +130° | +150° | +200° |
| POM | 0% | | | | | | | | | | | | | |
| PEEK natural (unfilled) | see separate table on page P38 | | | | | | | | | | | | | |
| PEEK (graphite filled) | see separate table on page P38 | | | | | | | | | | | | | |
| PTFE | see separate table on page P38 | | | | | | | | | | | | | |

Sealing material stem and adapter

| | Pressure reduction in % in relation to permitted system temperature in °C | | | | | | | | | | | | | |
|------|---|------|------|------|------|------|----|------|------|-------|-------|-------|-------|-------|
| | -60° | -50° | -40° | -30° | -20° | -10° | 0° | +20° | +80° | +100° | +120° | +130° | +150° | +200° |
| NBR | 0% | | | | | | | | | | | | | |
| FKM | 0% | | | | | | | | | | | | | |
| EPDM | 0% | | | | | | | | | | | | | |
| PTFE | see separate table on page P38 | | | | | | | | | | | | | |

■ permitted system temperature

■ system temperature not permitted

P

Example

| KH18LPEEK/FKM71X | Application temperature: max. 180 °C | Formula: |
|-----------------------------------|--------------------------------------|----------------------------------|
| PN = 420 bar | | P _{max} (180°C) = 95bar |
| Body: 1.4571 | Pressure reduction body: 11% | |
| Ball Seat: PEEK (graphite filled) | Pressure ball seat: 95 bar | |
| O-ring: FKM | Pressure reduction O-ring: 0% | |

Ball valves

PEEK/PTFE Pressure / Temperature Diagram

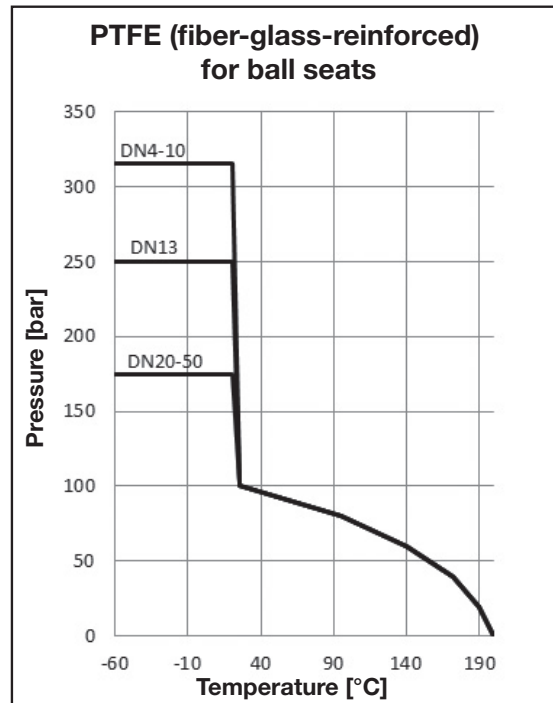
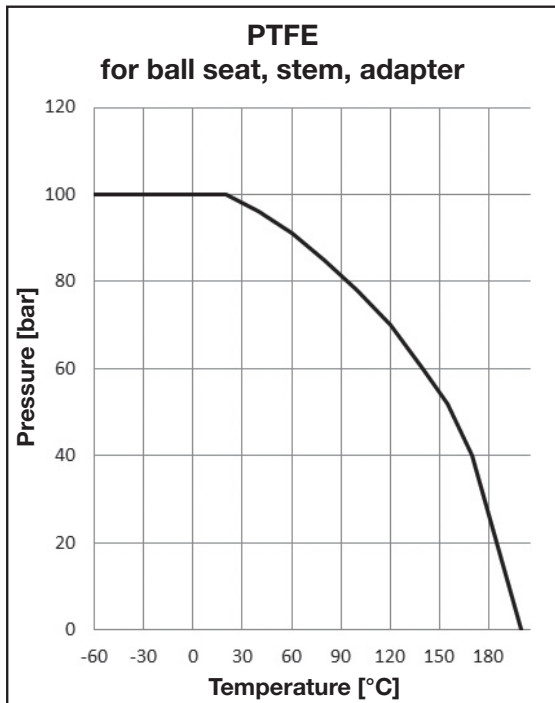
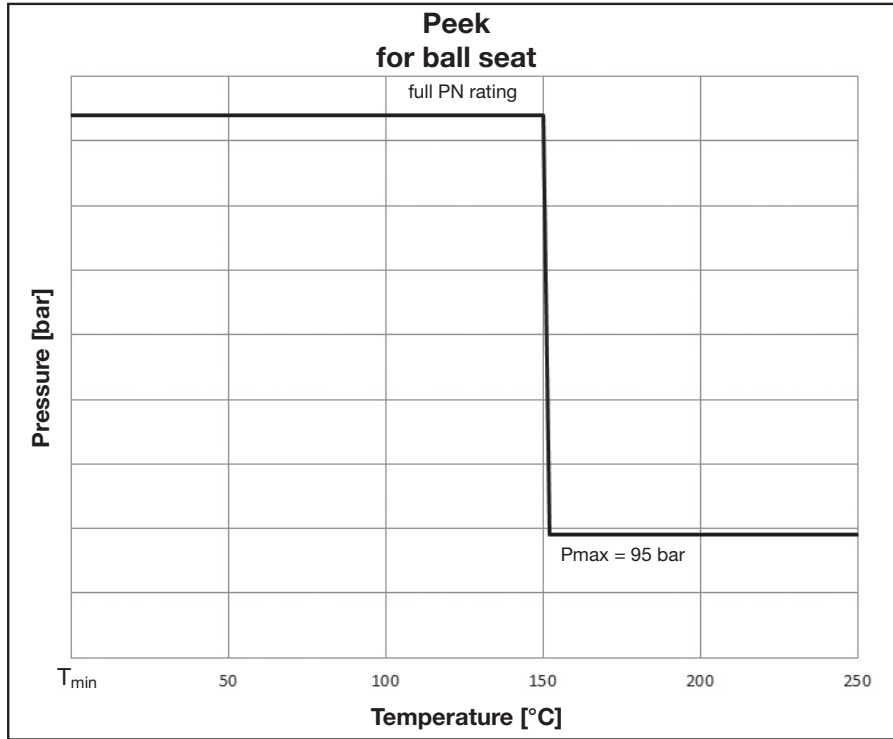



Ball valves

Index

| |
|--|
| |
| |
| |
| |
| |
| |
| |
| |
| |
| |
| |
| |
| |
| |
| |
| |
| |
| |
| |
| |
| |
| |
| |
| |



Ball valves



Index

KH 2-way ball valve steel

EO 24° cone end

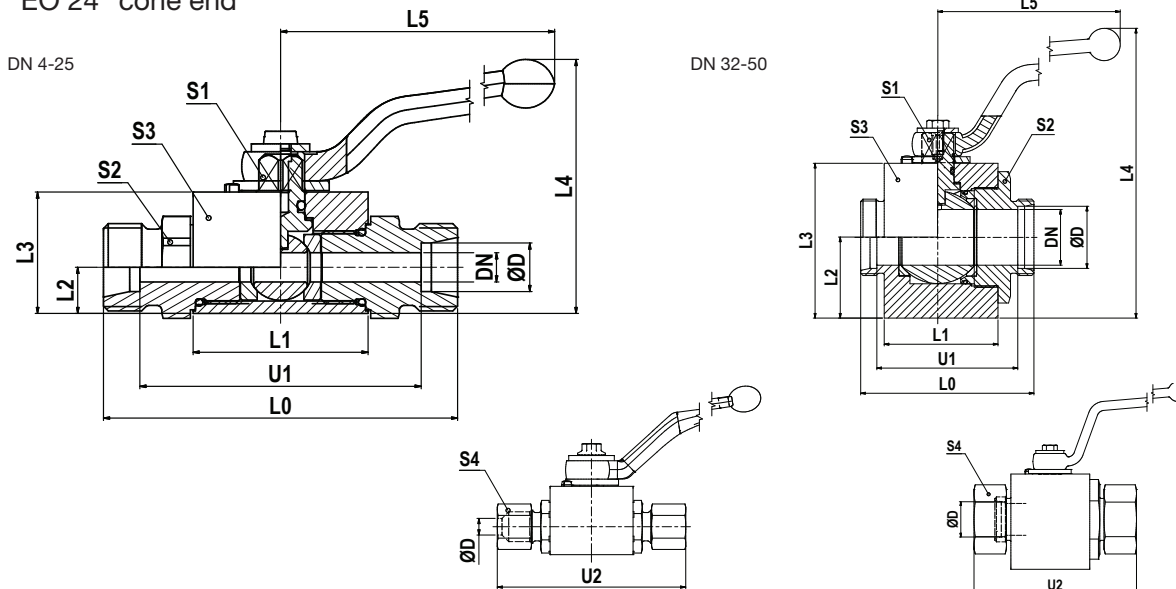

| Series | D ⊕ | DN | L0 | L1 | L2 | L3 | L4 | L5 | U1 | U2 | S1 | S2 | S3 | S4 | Weight g/1 piece | Order code | PN (bar) | |
|-----------------|-----------------|-------|-----|------|------|-----|-------|------|-----|-----|----|----|------|----|---------------------|--------------|-------------|-----|
| L ¹⁾ | 06 | 4 | 67 | 36.0 | 9.5 | 25 | 54.5 | 76 | 53 | 82 | 7 | 19 | 20 | 14 | 195 | KH06LCFX | 500 | |
| | 08 | 6 | 67 | 36.0 | 9.5 | 25 | 54.5 | 76 | 53 | 82 | 7 | 19 | 20 | 17 | 190 | KH08LCFX | 500 | |
| | 10 | 8 | 75 | 45.0 | 14.5 | 35 | 67.5 | 100 | 61 | 90 | 8 | 24 | 30 | 19 | 420 | KH10LCFX | 500 | |
| | 12 | 10 | 75 | 45.0 | 14.5 | 35 | 67.5 | 100 | 61 | 90 | 8 | 24 | 30 | 22 | 410 | KH12LCFX | 500 | |
| | 15 | 13 | 83 | 51.0 | 17.0 | 40 | 93.0 | 113 | 69 | 99 | 10 | 30 | 35 | 27 | 631 | KH15LCFX | 500 | |
| | 18 | 16 | 82 | 50.0 | 20.0 | 45 | 98.0 | 113 | 67 | 99 | 10 | 36 | 45 | 32 | 850 | KH18LCFX | 420 | |
| | 22 | 20 | 99 | 60.0 | 24.0 | 55 | 120.0 | 171 | 84 | 116 | 14 | 41 | 45 | 36 | 1210 | KH22LCFX | 420 | |
| | 28 | 25 | 108 | 70.0 | 26.0 | 60 | 125.0 | 171 | 93 | 126 | 14 | 50 | 55 | 41 | 1750 | KH28LCFX | 420 | |
| | 35 | 32/25 | 116 | 70.0 | 26.0 | 60 | 125.0 | 171 | 95 | 138 | 14 | 50 | 55 | 50 | 1820 | KH35LDN25CFX | 420 | |
| | 35 | 32 | 121 | 79.0 | 48.5 | 94 | 187.0 | 228 | 100 | 143 | 17 | 60 | Ø97 | 50 | 4888 | KH35LCFX | 420 | |
| | 42 | 40/25 | 121 | 70.0 | 26.0 | 60 | 125.0 | 171 | 99 | 144 | 14 | 55 | 55 | 60 | 1940 | KH42LDN25CFX | 420 | |
| | 42 | 40 | 118 | 77.5 | 53.5 | 104 | 197.0 | 228 | 96 | 141 | 17 | 75 | Ø107 | 60 | 5590 | KH42LCFX | 420 | |
| | S ²⁾ | 08 | 5 | 73 | 36.0 | 9.5 | 25 | 54.5 | 76 | 59 | 88 | 7 | 19 | 20 | 19 | 214 | KH08SCFX | 500 |
| | | 10 | 6 | 73 | 36.0 | 9.5 | 25 | 54.5 | 76 | 58 | 90 | 7 | 19 | 20 | 22 | 220 | KH10SCFX | 500 |
| 12 | | 8 | 77 | 45.0 | 14.5 | 35 | 67.5 | 100 | 62 | 94 | 8 | 24 | 30 | 24 | 430 | KH12SCFX | 500 | |
| 14 | | 10 | 81 | 45.0 | 14.5 | 35 | 67.5 | 100 | 65 | 100 | 8 | 24 | 30 | 27 | 440 | KH14SCFX | 500 | |
| 16 | | 13 | 87 | 51.0 | 17.0 | 40 | 93.0 | 113 | 70 | 106 | 10 | 30 | 35 | 30 | 649 | KH16SCFX | 500 | |
| 20 | | 16 | 90 | 50.0 | 20.0 | 45 | 98.0 | 113 | 69 | 112 | 10 | 36 | 45 | 36 | 900 | KH20SCFX | 420 | |
| 25 | | 20 | 107 | 60.0 | 24.0 | 55 | 120.0 | 171 | 83 | 131 | 14 | 41 | 45 | 46 | 1290 | KH25SCFX | 420 | |
| 30 | | 25 | 120 | 70.0 | 26.0 | 60 | 125.0 | 171 | 93 | 146 | 14 | 50 | 55 | 50 | 1880 | KH30SCFX | 420 | |
| 38 | | 32/25 | 134 | 70.0 | 26.0 | 60 | 125.0 | 171 | 102 | 163 | 14 | 55 | 55 | 60 | 1950 | KH38SDN25CFX | 420 | |
| 38 | | 32 | 127 | 73.0 | 48.5 | 94 | 187.0 | 228 | 95 | 156 | 17 | 60 | Ø97 | 60 | 4740 | KH38SCFX | 420 | |

¹⁾L = light series; ²⁾S = heavy series

$\frac{\text{PN (bar)}}{10} = \text{PN (MPa)}$

Delivery without nut and ring.

| Order code suffixes | | | |
|---------------------------------|-----------------------------|----------|---|
| Material | Suffix surface and material | Example | Standard sealing material (no additional suffix needed) |
| Steel, zinc plated, Cr(VI)-free | CF | KH06LCFX | POM / NBR |



KH 2-way ball valve stainless steel

EO 24° cone end

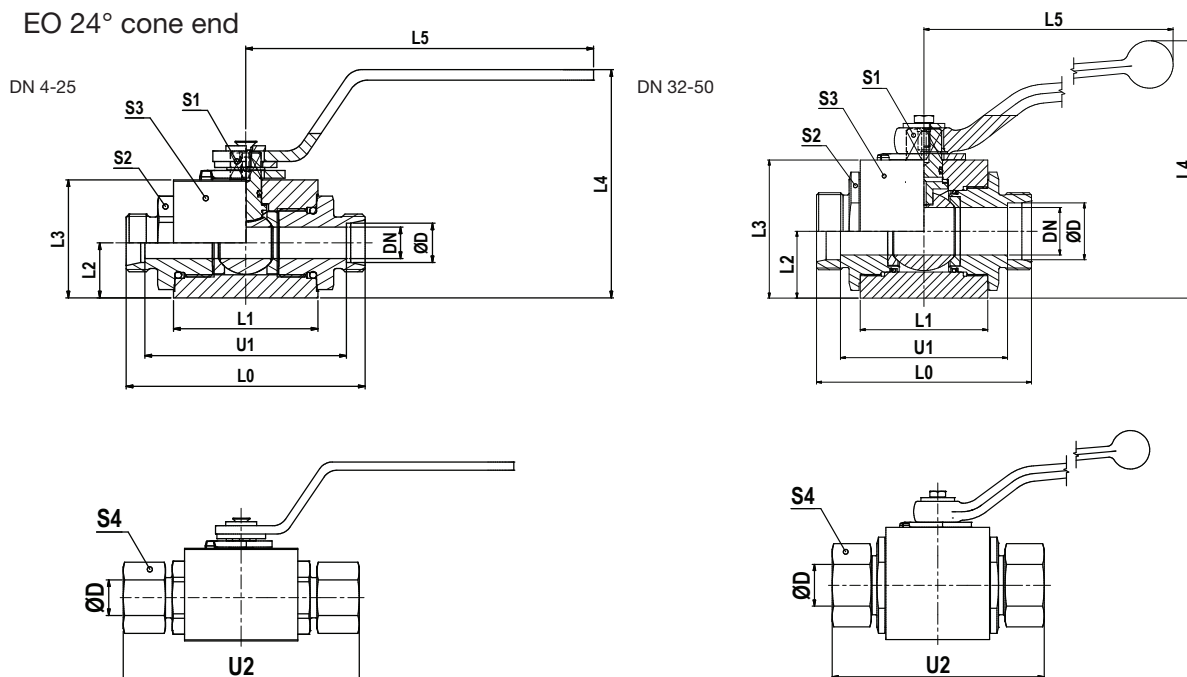

| Series | D | DN | L0 | L1 | L2 | L3 | L4 | L5 | U1 | U2 | S1 | S2 | S3 | S4 | Weight g/1 piece | Order code | PN (bar) |
|-----------------|----|-----|------|------|------|-------|-------|-------|-------|-----|----|------|------|------|---------------------|-----------------|-------------|
| L ¹⁾ | 06 | 4 | 73 | 41.5 | 13.5 | 30.0 | 54 | 80.0 | 58.5 | 88 | 7 | 22 | 30 | 14 | 391 | KH06L71X | 500 |
| | 08 | 6 | 73 | 41.5 | 13.5 | 30.0 | 54 | 80.0 | 58.5 | 88 | 7 | 22 | 30 | 17 | 392 | KH08L71X | 500 |
| | 10 | 8 | 87 | 53.0 | 18.0 | 40.0 | 82 | 132.5 | 73.0 | 102 | 8 | 30 | 40 | 19 | 833 | KH10L71X | 500 |
| | 12 | 10 | 87 | 53.0 | 18.0 | 40.0 | 82 | 132.5 | 73.0 | 102 | 8 | 30 | 40 | 22 | 812 | KH12L71X | 500 |
| | 15 | 12 | 91 | 55.0 | 21.0 | 45.0 | 87 | 132.5 | 76.5 | 107 | 10 | 32 | 45 | 27 | 1018 | KH15L71X | 500 |
| | 18 | 12 | 91 | 55.0 | 21.0 | 45.0 | 87 | 132.5 | 75.5 | 108 | 10 | 32 | 45 | 32 | 1059 | KH18L71X | 500 |
| | 22 | 20 | 105 | 65.0 | 31.0 | 65.0 | 118 | 190.0 | 89.5 | 122 | 14 | 46 | 65 | 36 | 2427 | KH22L71X | 400 |
| | 28 | 25 | 112 | 71.0 | 38.0 | 75.0 | 128 | 190.0 | 96.5 | 130 | 14 | 50 | 75 | 41 | 3313 | KH28L71X | 400 |
| | 35 | 32 | 145 | 86.0 | 45.0 | 93.0 | 174 | 320.0 | 123.5 | 167 | 19 | 70 | Ø100 | 50 | 6230 | KH35L71X | 400 |
| | 42 | 40 | 150 | 92.0 | 52.0 | 104.5 | 185 | 320.0 | 127.5 | 173 | 19 | 80 | Ø110 | 60 | 7706 | KH42L71X | 400 |
| S ²⁾ | 08 | 4 | 76 | 41.5 | 13.5 | 30.0 | 54 | 80.0 | 61.5 | 91 | 7 | 22 | 30 | 19 | 390 | KH08S71X | 500 |
| | 10 | 6 | 76 | 41.5 | 13.5 | 30.0 | 54 | 80.0 | 60.5 | 91 | 7 | 22 | 30 | 22 | 406 | KH10S71X | 500 |
| | 12 | 8 | 89 | 53.0 | 18.0 | 40.0 | 82 | 132.5 | 74.0 | 106 | 8 | 30 | 40 | 24 | 855 | KH12S71X | 500 |
| | 14 | 10 | 93 | 53.0 | 18.0 | 40.0 | 82 | 132.5 | 77.0 | 112 | 8 | 30 | 40 | 27 | 850 | KH14S71X | 500 |
| | 16 | 12 | 96 | 55.0 | 21.0 | 45.0 | 87 | 132.5 | 78.5 | 115 | 10 | 32 | 45 | 30 | 1050 | KH16S71X | 500 |
| | 20 | 12 | 99 | 55.0 | 21.0 | 45.0 | 87 | 132.5 | 77.5 | 121 | 10 | 32 | 45 | 36 | 1090 | KH20S71X | 500 |
| | 25 | 20 | 113 | 65.0 | 31.0 | 65.0 | 118 | 190.0 | 88.5 | 137 | 14 | 46 | 65 | 46 | 2490 | KH25S71X | 400 |
| | 30 | 25 | 124 | 71.0 | 38.0 | 75.0 | 128 | 190.0 | 96.5 | 150 | 14 | 50 | 75 | 50 | 3430 | KH30S71X | 400 |
| 38 | 32 | 145 | 86.0 | 45.0 | 93.0 | 174 | 320.0 | 112.5 | 174 | 19 | 70 | Ø100 | 60 | 5881 | KH38S71X | 400 | |

1) L = light series; 2) S = heavy series

$$\frac{PN \text{ (bar)}}{10} = PN \text{ (MPa)}$$

Delivery without nut and ring.

| Order code suffixes | | | |
|---------------------|-----------------------------|----------|---|
| Material | Suffix surface and material | Example | Standard sealing material (no additional suffix needed) |
| Stainless Steel | 71 | KH06L71X | POM / NBR |



Ball valves

KH 2-way BSPP ball valve steel

Female BSPP thread (ISO 1179-1)

DN 4-25

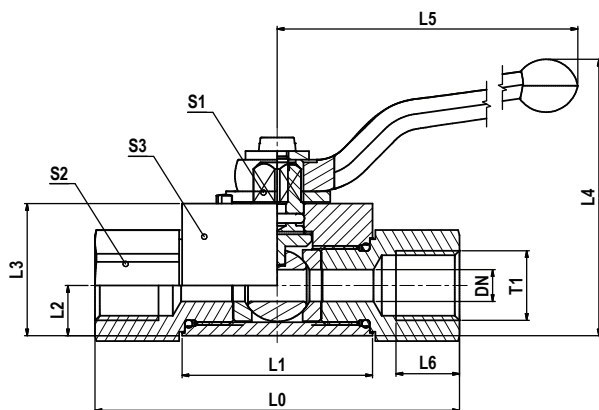

DN 32-50

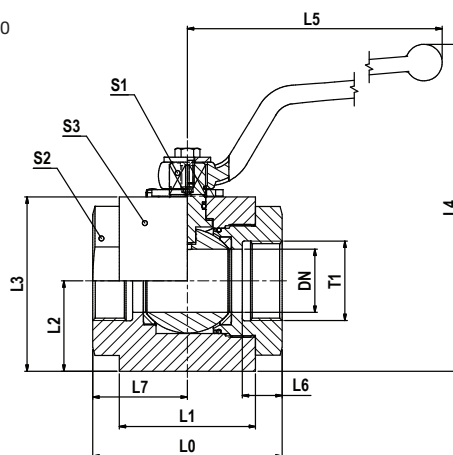

| T1 | DN | L0 | L1 | L2 | L3 | L4 | L5 | L6 | L7 | S1 | S2 | S3 | Weight g/1 piece | Order code | PN (bar) |
|---------|-------|-----|-----|------|-------|-------|-----|----|----|----|----|------|---------------------|----------------------|-------------|
| G 1/8 | 5 | 69 | 36 | 9.5 | 25.0 | 54.5 | 76 | 12 | - | 7 | 19 | 20 | 220 | KH1/8CFX | 500 |
| G 1/4 | 6 | 69 | 36 | 9.5 | 25.0 | 54.5 | 76 | 12 | - | 7 | 19 | 20 | 210 | KH1/4CFX | 500 |
| G 3/8 | 10 | 73 | 45 | 14.5 | 35.0 | 67.5 | 100 | 14 | - | 8 | 24 | 30 | 430 | KH3/8CFX | 500 |
| G 1/2 | 13 | 82 | 51 | 17.0 | 40.0 | 93.0 | 113 | 15 | - | 10 | 30 | 35 | 670 | KH1/2CFX | 500 |
| G 5/8 | 16 | 88 | 50 | 20.0 | 45.0 | 98.0 | 113 | 18 | - | 10 | 36 | 45 | 973 | KH5/8CFX | 420 |
| G 3/4 | 20 | 93 | 60 | 24.0 | 55.0 | 120.0 | 171 | 18 | - | 14 | 41 | 45 | 1280 | KH3/4CFX | 420 |
| G 1 | 25 | 115 | 70 | 26.0 | 60.0 | 125.0 | 171 | 20 | - | 14 | 50 | 55 | 1982 | KH1CFX | 420 |
| G 1 1/4 | 32 | 110 | 80 | 48.5 | 94.0 | 187.0 | 228 | 22 | 55 | 17 | 60 | Ø97 | 4888 | KH11/4CFX | 420 |
| G 1 1/4 | 32/25 | 134 | 70 | 26.0 | 60.0 | 125.0 | 171 | 22 | - | 14 | 50 | 55 | 2066 | KH11/4DN25CFX | 420 |
| G 1 1/2 | 40 | 114 | 82 | 53.5 | 104.0 | 197.0 | 228 | 24 | 57 | 17 | 75 | Ø107 | 6330 | KH11/2CFX | 420 |
| G 1 1/2 | 40/25 | 139 | 70 | 26.0 | 60.0 | 125.0 | 171 | 24 | - | 14 | 55 | 55 | 2200 | KH11/2DN25CFX | 420 |
| G 2 | 50 | 133 | 100 | 61.5 | 119.5 | 211.5 | 306 | 26 | 65 | 17 | 85 | Ø123 | 9220 | KH2CFX | 420 |

$$\frac{\text{PN (bar)}}{10} = \text{PN (MPa)}$$

| Order code suffixes | | | |
|---------------------------------|-----------------------------|----------|---|
| Material | Suffix surface and material | Example | Standard sealing material (no additional suffix needed) |
| Steel, zinc plated, Cr(VI)-free | CF | KH1/8CFX | POM / NBR |



KH 2-way BSPP ball valve stainless steel

Female BSPP thread (ISO 1179-1)

DN 4-25

DN 32-50

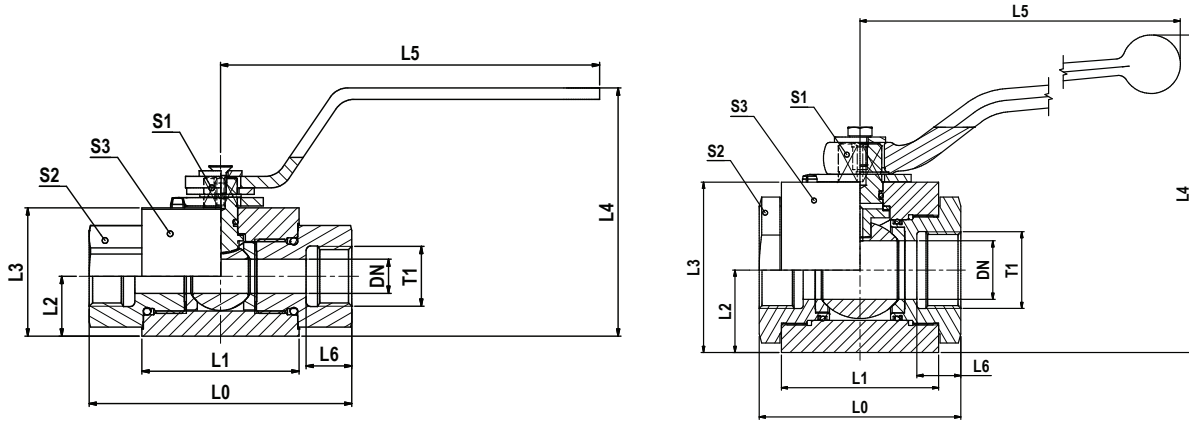

| T1 | DN | L0 | L1 | L2 | L3 | L4 | L5 | L6 | S1 | S2 | S3 | Weight g/1 piece | Order code | PN (bar) |
|---------|----|-----|------|------|-------|-----|-------|------|----|----|------|---------------------|------------------|----------|
| G 1/8 | 4 | 69 | 41.5 | 13.5 | 30.0 | 54 | 80.0 | 11.0 | 7 | 22 | 30 | 420 | KH1/871X | 500 |
| G 1/4 | 6 | 75 | 41.5 | 13.5 | 30.0 | 54 | 80.0 | 14.0 | 7 | 22 | 30 | 427 | KH1/471X | 500 |
| G 3/8 | 10 | 86 | 53.0 | 18.0 | 40.0 | 82 | 132.5 | 14.0 | 8 | 30 | 40 | 902 | KH3/871X | 500 |
| G 1/2 | 12 | 92 | 55.0 | 21.0 | 45.0 | 87 | 132.5 | 16.0 | 10 | 32 | 45 | 1100 | KH1/271X | 500 |
| G 3/4 | 20 | 111 | 65.0 | 31.0 | 65.0 | 118 | 190.0 | 18.0 | 14 | 46 | 65 | 2699 | KH3/471X | 400 |
| G 1 | 25 | 122 | 71.0 | 38.0 | 75.0 | 128 | 190.0 | 20.0 | 14 | 50 | 75 | 3620 | KH171X | 400 |
| G 1 1/4 | 32 | 110 | 86.0 | 45.0 | 93.0 | 174 | 320.0 | 24.0 | 19 | 70 | Ø100 | 5688 | KH11/471X | 400 |
| G 1 1/2 | 40 | 120 | 92.0 | 52.0 | 104.5 | 185 | 320.0 | 26.0 | 19 | 80 | Ø110 | 7379 | KH11/271X | 400 |
| G 2 | 50 | 140 | 97.0 | 59.5 | 119.5 | 201 | 320.0 | 27.5 | 19 | 95 | Ø125 | 10086 | KH271X | 400 |

$\frac{\text{PN (bar)}}{10} = \text{PN (MPa)}$



| Order code suffixes | | | |
|---------------------|-----------------------------|----------|---|
| Material | Suffix surface and material | Example | Standard sealing material (no additional suffix needed) |
| Stainless Steel | 71 | KH1/871X | POM / NBR |



Ball valves

KH 2-way NPT ball valve steel

Female NPT thread (SAE 476)

DN 4-25

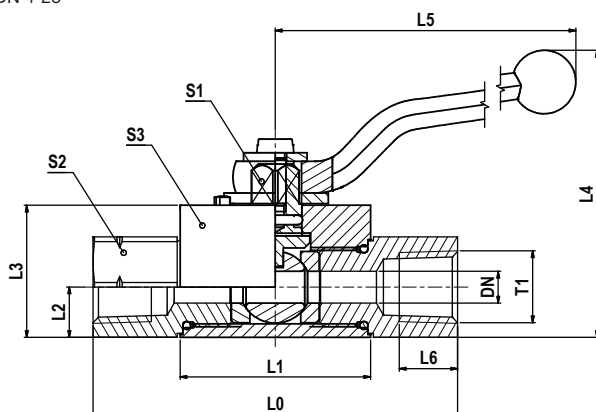

DN 32-50

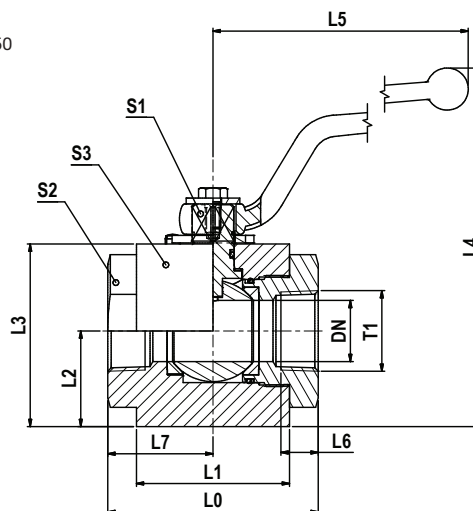

| T1 | DN | L0 | L1 | L2 | L3 | L4 | L5 | L6 | L7 | S1 | S2 | S3 | Weight g/1 piece | Order code | PN (bar) |
|----------------|----|-----|-----|------|-------|-------|-----|------|----|----|----|------|---------------------|---------------------|-------------|
| 1/8-27 NPT | 5 | 69 | 36 | 9.5 | 25.0 | 55.0 | 76 | 7.0 | - | 7 | 19 | 20 | 225 | KH1/8NPTCFX | 500 |
| 1/4-18 NPT | 6 | 69 | 36 | 9.5 | 25.0 | 55.0 | 76 | 11.0 | - | 7 | 19 | 20 | 210 | KH1/4NPTCFX | 500 |
| 3/8-18 NPT | 10 | 73 | 45 | 14.5 | 35.0 | 68.0 | 100 | 11.5 | - | 8 | 24 | 30 | 430 | KH3/8NPTCFX | 500 |
| 1/2-14 NPT | 13 | 82 | 51 | 17.0 | 40.0 | 93.0 | 113 | 15.0 | - | 10 | 30 | 35 | 670 | KH1/2NPTCFX | 500 |
| 3/4-14 NPT | 20 | 93 | 60 | 24.0 | 55.0 | 120.0 | 171 | 16.0 | - | 14 | 41 | 45 | 1300 | KH3/4NPTCFX | 420 |
| 1-11.5 NPT | 25 | 115 | 70 | 26.0 | 60.0 | 125.0 | 171 | 19.0 | - | 14 | 50 | 55 | 2000 | KH1NPTCFX | 420 |
| 1 1/4-11.5 NPT | 32 | 110 | 80 | 48.5 | 94.0 | 187.0 | 228 | 19.5 | 55 | 17 | 60 | Ø97 | 4888 | KH11/4NPTCFX | 420 |
| 1 1/2-11.5 NPT | 40 | 114 | 82 | 53.5 | 104.0 | 197.0 | 228 | 19.5 | 57 | 17 | 75 | Ø107 | 5590 | KH11/2NPTCFX | 420 |
| 2-11.5 NPT | 50 | 133 | 100 | 61.5 | 119.5 | 211.5 | 306 | 22.0 | 65 | 17 | 85 | Ø123 | 9220 | KH2NPTCFX | 420 |

 $\frac{PN \text{ (bar)}}{10} = PN \text{ (MPa)}$

| Order code suffixes | | | |
|---------------------------------|-----------------------------|-------------|---|
| Material | Suffix surface and material | Example | Standard sealing material (no additional suffix needed) |
| Steel, zinc plated, Cr(VI)-free | CF | KH1/8NPTCFX | POM / NBR |



KH 2-way NPT ball valve stainless steel

Female NPT thread (SAE 476)

DN 4-25

DN 32-50

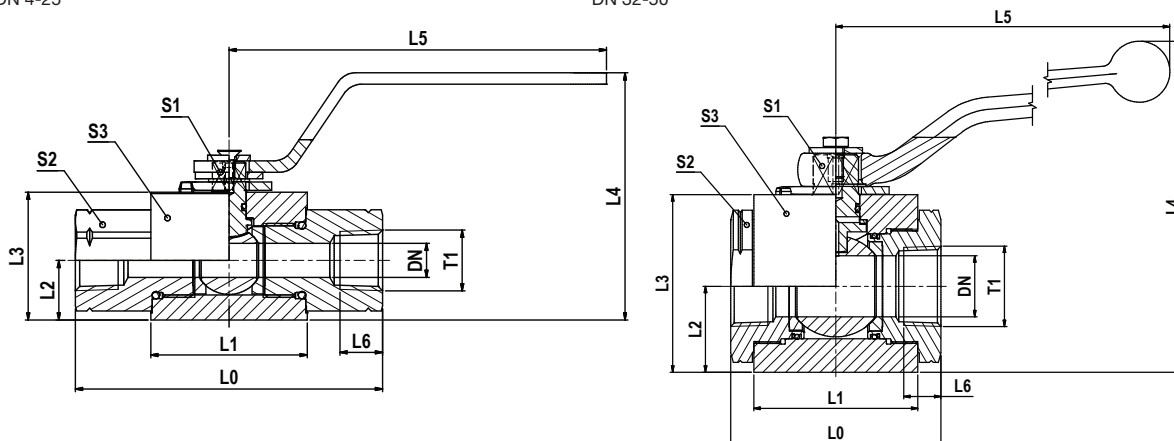

| T1 | DN | L0 | L1 | L2 | L3 | L4 | L5 | L6 | S1 | S2 | S3 | Weight g/1 piece | Order code | PN (bar) |
|----------------|----|-----|------|------|-------|-----|-------|------|----|----|------|---------------------|---------------------|----------|
| 1/8-27 NPT | 4 | 82 | 41.5 | 13.5 | 30.0 | 54 | 80.0 | 8.0 | 7 | 22 | 30 | 431 | KH1/8NPT71X | 500 |
| 1/4-18 NPT | 6 | 82 | 41.5 | 13.5 | 30.0 | 54 | 80.0 | 11.5 | 7 | 22 | 30 | 436 | KH1/4NPT71X | 500 |
| 3/8-18 NPT | 10 | 95 | 53.0 | 18.0 | 40.0 | 82 | 132.5 | 11.5 | 8 | 30 | 40 | 956 | KH3/8NPT71X | 500 |
| 1/2-14 NPT | 12 | 108 | 55.0 | 21.0 | 45.0 | 87 | 132.5 | 15.0 | 10 | 32 | 45 | 1204 | KH1/2NPT71X | 500 |
| 3/4-14 NPT | 20 | 111 | 65.0 | 31.0 | 65.0 | 118 | 190.0 | 16.0 | 14 | 46 | 65 | 2723 | KH3/4NPT71X | 400 |
| 1-11.5 NPT | 25 | 122 | 71.0 | 38.0 | 75.0 | 128 | 190.0 | 19.0 | 14 | 50 | 75 | 3646 | KH1NPT71X | 400 |
| 1 1/4-11.5 NPT | 32 | 110 | 86.0 | 45.0 | 93.0 | 174 | 320.0 | 19.5 | 19 | 70 | Ø100 | 5887 | KH11/4NPT71X | 400 |
| 1 1/2-11.5 NPT | 40 | 120 | 92.0 | 52.0 | 104.5 | 185 | 320.0 | 19.5 | 19 | 80 | Ø110 | 7430 | KH11/2NPT71X | 400 |
| 2-11.5 NPT | 50 | 140 | 97.0 | 59.5 | 119.5 | 201 | 320.0 | 25.0 | 19 | 95 | Ø125 | 10100 | KH2NPT71X | 400 |

$\frac{PN \text{ (bar)}}{10} = PN \text{ (MPa)}$

P

| Order code suffixes | | | |
|---------------------|-----------------------------|-------------|---|
| Material | Suffix surface and material | Example | Standard sealing material (no additional suffix needed) |
| Stainless steel | 71 | KH1/8NPT71X | POM / NBR |



Ball valves

KH 3-way compact ball valve steel

EO 24° cone end

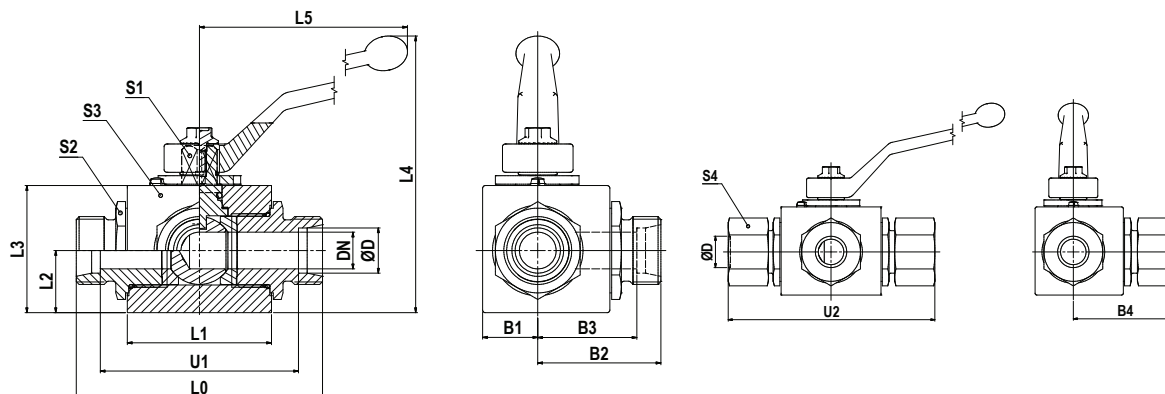

By default 3-way ball valves are manufactured as L-Bore version. Alternative design on request. Pressure inlet only from center port (connector 2).

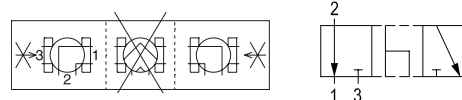

| Series | D | DN | L0 | L1 | L2 | L3 | L4 | L5 | U1 | U2 | B1 | B2 | B3 | B4 | S1 | S2 | S3 | S4 | Weight g/1 piece | Order code | PN (bar) |
|-----------------|----|-------|-----|----|------|----|-------|-----|-----|-----|------|------|------|------|----|----|----|----|---------------------|-------------------------|-------------|
| L ¹⁾ | 06 | 4 | 67 | 36 | 14.5 | 30 | 59.5 | 76 | 53 | 82 | 12.0 | 33.5 | 26.5 | 41.0 | 7 | 19 | 30 | 14 | 320 | KH3/2-06LCFX | 500 |
| | 08 | 6 | 67 | 36 | 14.5 | 30 | 59.5 | 76 | 53 | 82 | 12.0 | 33.5 | 26.5 | 41.0 | 7 | 19 | 30 | 17 | 320 | KH3/2-08LCFX | 500 |
| | 10 | 8 | 75 | 45 | 14.5 | 35 | 67.5 | 100 | 61 | 90 | 17.5 | 37.5 | 30.5 | 45.0 | 8 | 24 | 40 | 19 | 550 | KH3/2-10LCFX | 500 |
| | 12 | 10 | 75 | 45 | 14.5 | 35 | 67.5 | 100 | 61 | 90 | 17.5 | 37.5 | 30.5 | 45.0 | 8 | 24 | 40 | 22 | 550 | KH3/2-12LCFX | 500 |
| | 15 | 13 | 83 | 51 | 22.0 | 45 | 98.0 | 113 | 69 | 99 | 19.5 | 41.5 | 34.5 | 49.5 | 10 | 30 | 45 | 27 | 890 | KH3/2-15LCFX | 500 |
| | 18 | 16 | 82 | 50 | 25.0 | 50 | 103.0 | 113 | 67 | 99 | 25.0 | 41.0 | 33.5 | 49.5 | 10 | 36 | 50 | 32 | 1050 | KH3/2-18LCFX | 400 |
| | 22 | 20 | 99 | 60 | 29.0 | 60 | 125.0 | 171 | 84 | 116 | 23.5 | 51.0 | 43.5 | 58.0 | 14 | 41 | 55 | 36 | 1610 | KH3/2-22LCFX | 400 |
| | 28 | 25 | 108 | 70 | 31.0 | 65 | 130.0 | 171 | 93 | 126 | 30.0 | 54.0 | 46.5 | 63.0 | 14 | 50 | 65 | 41 | 2270 | KH3/2-28LCFX | 400 |
| | 35 | 32/25 | 116 | 70 | 31.0 | 65 | 130.0 | 171 | 95 | 138 | 30.0 | 58.0 | 47.5 | 69.5 | 14 | 50 | 65 | 50 | 2480 | KH3/2-35LDN25CFX | 400 |
| | 42 | 40/25 | 121 | 70 | 31.0 | 65 | 130.0 | 171 | 99 | 144 | 30.0 | 60.5 | 49.5 | 71.5 | 14 | 55 | 65 | 60 | 2600 | KH3/2-42LDN25CFX | 400 |
| S ²⁾ | 08 | 5 | 73 | 36 | 14.5 | 30 | 54.5 | 76 | 59 | 88 | 12.0 | 36.5 | 29.5 | 44.0 | 7 | 19 | 30 | 19 | 350 | KH3/2-08SCFX | 500 |
| | 10 | 6 | 73 | 36 | 14.5 | 30 | 54.5 | 76 | 58 | 90 | 12.0 | 36.5 | 29.0 | 45.0 | 7 | 19 | 30 | 22 | 350 | KH3/2-10SCFX | 500 |
| | 12 | 8 | 77 | 45 | 14.5 | 35 | 67.5 | 100 | 62 | 94 | 17.5 | 38.5 | 31.0 | 47.0 | 8 | 24 | 40 | 24 | 570 | KH3/2-12SCFX | 500 |
| | 14 | 10 | 81 | 45 | 14.5 | 35 | 67.5 | 100 | 65 | 100 | 17.5 | 40.5 | 32.5 | 50.0 | 8 | 24 | 40 | 27 | 570 | KH3/2-14SCFX | 500 |
| | 16 | 13 | 87 | 51 | 22.0 | 45 | 98.0 | 113 | 70 | 106 | 19.5 | 43.5 | 35.0 | 53.0 | 10 | 30 | 45 | 30 | 910 | KH3/2-16SCFX | 500 |
| | 20 | 16 | 90 | 50 | 25.0 | 50 | 103.0 | 113 | 69 | 112 | 25.0 | 45.0 | 34.5 | 56.0 | 10 | 36 | 50 | 36 | 1120 | KH3/2-20SCFX | 400 |
| | 25 | 20 | 107 | 60 | 29.0 | 60 | 125.0 | 171 | 83 | 131 | 23.5 | 55.0 | 43.0 | 65.5 | 14 | 41 | 55 | 46 | 1720 | KH3/2-25SCFX | 400 |
| | 30 | 25 | 120 | 70 | 31.0 | 65 | 130.0 | 171 | 93 | 146 | 30.0 | 60.0 | 46.5 | 73.0 | 14 | 50 | 65 | 50 | 2440 | KH3/2-30SCFX | 400 |
| | 38 | 32/25 | 134 | 70 | 31.0 | 65 | 130.0 | 171 | 102 | 163 | 30.0 | 67.0 | 51.0 | 81.5 | 14 | 55 | 65 | 60 | 2950 | KH3/2-38SDN25CFX | 400 |

¹⁾L = light series; ²⁾S = heavy series

$$\frac{\text{PN (bar)}}{10} = \text{PN (MPa)}$$

Delivery without nut and ring.

| Order code suffixes | | | |
|---------------------------------|-----------------------------|--------------|---|
| Material | Suffix surface and material | Example | Standard sealing material (no additional suffix needed) |
| Steel, zinc plated, Cr(VI)-free | CF | KH3/2-06LCFX | POM / NBR |



KH 3-way compact ball valve stainless steel

EO 24° cone end

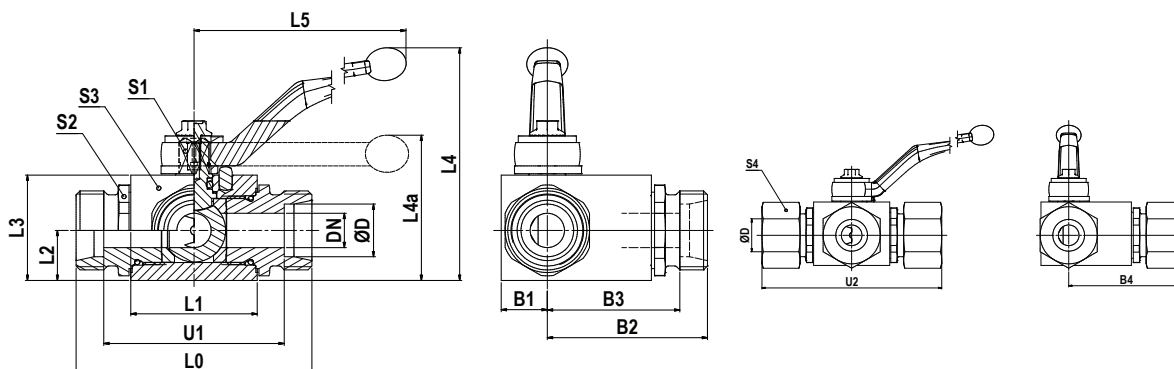

By default 3-way ball valves are manufactured as L-Bore version. Alternative design on request. Pressure inlet only from center port (connector 2).

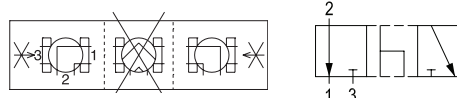

| Series | D | DN | L0 | L1 | L2 | L3 | L4 | L4a | L5 | U1 | B1 | B2 | B3 | B4 | S1 | S2 | S3 | S4 | Weight g/1 piece | Order code | PN (bar) |
|-----------------|-----------------|-----|-----|------|------|------|----|-----|-----|------|------|------|-------|-------|------|------|------|------|-------------------------|---------------------|---------------------|
| L ¹⁾ | 06 | 4 | 67 | 40 | 13.5 | 33 | 82 | | 115 | 53 | 13.0 | 50.0 | 43.0 | 57.5 | 9 | 22 | 47.5 | 14 | 500 | KH3/2-06L71X | 500 |
| | 08 | 6 | 67 | 40 | 13.5 | 33 | 82 | | 115 | 53 | 13.0 | 51.5 | 44.5 | 59.5 | 9 | 22 | 47.5 | 17 | 520 | KH3/2-08L71X | 500 |
| | 10 | 8 | 74 | 40 | 13.5 | 33 | 82 | | 115 | 60 | 13.0 | 52.5 | 45.5 | 60.5 | 9 | 22 | 47.5 | 19 | 540 | KH3/2-10L71X | 500 |
| | 12 | 10 | 74 | 43 | 17.5 | 38 | 86 | | 115 | 60 | 16.0 | 55.5 | 48.5 | 63.0 | 9 | 27 | 52.0 | 22 | 730 | KH3/2-12L71X | 500 |
| | 15 | 13 | 82 | 48 | 19.0 | 40 | 89 | | 115 | 68 | 17.5 | 60.5 | 53.5 | 68.5 | 9 | 30 | 57.0 | 27 | 850 | KH3/2-15L71X | 500 |
| | 18 | 16 | 82 | 48 | 19.0 | 40 | 89 | | 115 | 67 | 17.5 | 61.5 | 54.0 | 70.5 | 9 | 30 | 57.0 | 32 | 890 | KH3/2-18L71X | 500 |
| | 22 | 20 | 101 | 62 | 24.5 | 57 | | 79 | 200 | 86 | 24.5 | 71.5 | 64.0 | 80.5 | 14 | 41 | 72.0 | 36 | 1870 | KH3/2-22L71X | 315 |
| | 28 | 25 | 108 | 66 | 29.5 | 65 | | 87 | 200 | 93 | 29.0 | 81.5 | 74.0 | 90.5 | 14 | 50 | 85.5 | 41 | 2450 | KH3/2-28L71X | 315 |
| | 35 | 25 | 112 | 66 | 29.5 | 65 | | 87 | 200 | 91 | 29.0 | 85.0 | 74.5 | 96.0 | 14 | 50 | 86.0 | 50 | 2900 | KH3/2-35L71X | 315 |
| | S ²⁾ | 08 | 4 | 73 | 40 | 13.5 | 33 | 82 | | 115 | 59 | 13.0 | 56.5 | 49.5 | 64.5 | 9 | 22 | 47.5 | 19 | 520 | KH3/2-18L71X |
| 10 | | 6 | 73 | 40 | 13.5 | 33 | 82 | | 115 | 58 | 13.0 | 56.5 | 49.0 | 65.5 | 9 | 22 | 47.5 | 22 | 540 | KH3/2-10S71X | 500 |
| 12 | | 8 | 76 | 40 | 13.5 | 33 | 82 | | 115 | 61 | 13.0 | 58.5 | 51.0 | 67.5 | 9 | 22 | 47.5 | 24 | 560 | KH3/2-12S71X | 500 |
| 14 | | 10 | 80 | 43 | 17.5 | 38 | 86 | | 115 | 64 | 16.0 | 62.5 | 54.5 | 72.0 | 9 | 27 | 52.0 | 27 | 730 | KH3/2-14S71X | 500 |
| 16 | | 13 | 86 | 48 | 19.0 | 40 | 89 | | 115 | 69 | 17.5 | 66.5 | 58.0 | 76.5 | 9 | 30 | 57.0 | 30 | 860 | KH3/2-16S71X | 500 |
| 20 | | 13 | 90 | 48 | 19.0 | 40 | 89 | | 115 | 69 | 17.5 | 70.5 | 60.0 | 81.5 | 9 | 32 | 57.0 | 36 | 940 | KH3/2-20S71X | 500 |
| 25 | | 20 | 109 | 62 | 24.5 | 57 | | 79 | 200 | 85 | 24.5 | 82.5 | 70.5 | 94.5 | 14 | 41 | 72.0 | 46 | 1950 | KH3/2-25S71X | 315 |
| 30 | | 25 | 120 | 66 | 29.5 | 65 | | 87 | 200 | 93 | 29.0 | 93.5 | 80.0 | 106.5 | 14 | 50 | 85.5 | 50 | 2650 | KH3/2-30S71X | 315 |
| 38 | 32/25 | 124 | 66 | 29.5 | 65 | | 87 | 200 | 92 | 29.0 | 99.0 | 83.0 | 114.0 | 14 | 55 | 86.0 | 60 | 3100 | KH3/2-38SDN2571X | 315 | |

¹⁾L = light series; ²⁾S = heavy series

$\frac{PN \text{ (bar)}}{10} = PN \text{ (MPa)}$

Delivery without nut and ring.

| Order code suffixes | | | |
|---------------------|-----------------------------|--------------|---|
| Material | Suffix surface and material | Example | Standard sealing material (no additional suffix needed) |
| Stainless steel | 71 | KH3/2-06L71X | POM / NBR |



Ball valves

KH 3-way compact BSPP ball valve steel

Female BSPP thread (ISO 1179-1)

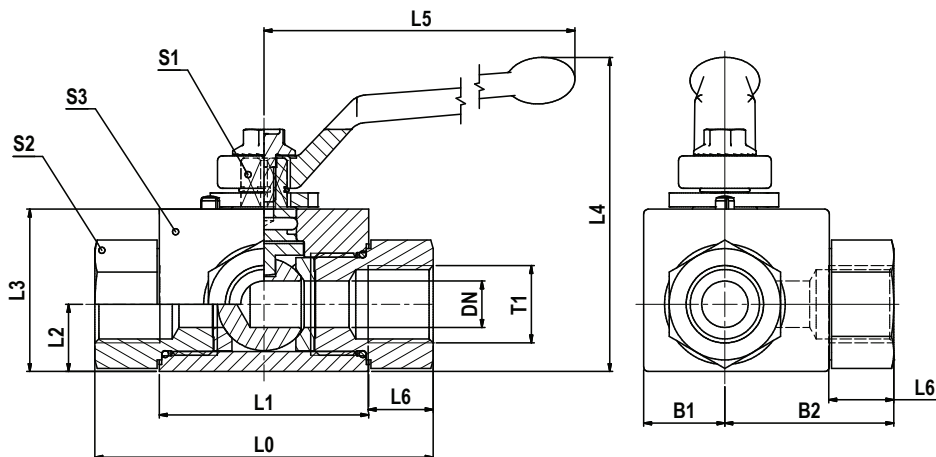

By default 3-way ball valves are manufactured as L-Bore version. Alternative design on request. Pressure inlet only from center port (connector 2).

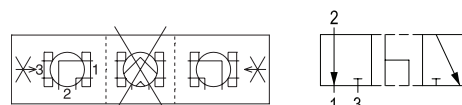

| T1 | DN | L0 | L1 | L2 | L3 | L4 | L5 | L6 | B1 | B2 | S1 | S2 | S3 | Weight g/1 piece | Order code | PN (bar) |
|---------|-------|-----|----|------|----|-------|-----|----|------|------|----|----|----|---------------------|--------------------------|-------------|
| G 1/8 | 5 | 69 | 36 | 14.5 | 30 | 59.5 | 76 | 12 | 12.0 | 34.5 | 7 | 19 | 30 | 370 | KH3/2-1/8CFX | 500 |
| G 1/4 | 6 | 69 | 36 | 14.5 | 30 | 59.5 | 76 | 12 | 12.0 | 34.5 | 7 | 19 | 30 | 340 | KH3/2-1/4CFX | 500 |
| G 3/8 | 10 | 73 | 45 | 14.5 | 35 | 67.5 | 100 | 14 | 17.5 | 36.5 | 8 | 24 | 40 | 570 | KH3/2-3/8CFX | 500 |
| G 1/2 | 13 | 82 | 51 | 22.0 | 45 | 98.0 | 113 | 15 | 19.5 | 41.0 | 10 | 30 | 45 | 940 | KH3/2-1/2CFX | 500 |
| G 5/8 | 16 | 88 | 50 | 25.0 | 50 | 103.0 | 113 | 18 | 25.0 | 44.0 | 10 | 36 | 50 | 1240 | KH3/2-5/8CFX | 400 |
| G 3/4 | 20 | 93 | 60 | 29.0 | 60 | 125.0 | 171 | 18 | 23.5 | 48.0 | 14 | 41 | 55 | 1720 | KH3/2-3/4CFX | 400 |
| G 1 | 25 | 115 | 70 | 31.0 | 65 | 130.0 | 171 | 20 | 30.0 | 57.5 | 14 | 50 | 65 | 2650 | KH3/2-1CFX | 400 |
| G 1 1/4 | 32/25 | 134 | 70 | 31.0 | 65 | 130.0 | 171 | 22 | 30.0 | 67.0 | 14 | 50 | 65 | 2710 | KH3/2-11/4DN25CFX | 400 |
| G 1 1/2 | 40/25 | 139 | 70 | 31.0 | 65 | 130.0 | 171 | 24 | 30.0 | 69.5 | 14 | 55 | 65 | 2910 | KH3/2-11/2DN25CFX | 400 |

$$\frac{\text{PN (bar)}}{10} = \text{PN (MPa)}$$

| Order code suffixes | | | |
|---------------------------------|-----------------------------|--------------|---|
| Material | Suffix surface and material | Example | Standard sealing material (no additional suffix needed) |
| Steel, zinc plated, Cr(VI)-free | CF | KH3/2-1/8CFX | POM / NBR |



KH 3-way compact BSPP ball valve stainless steel

Female BSPP thread (ISO 1179-1)

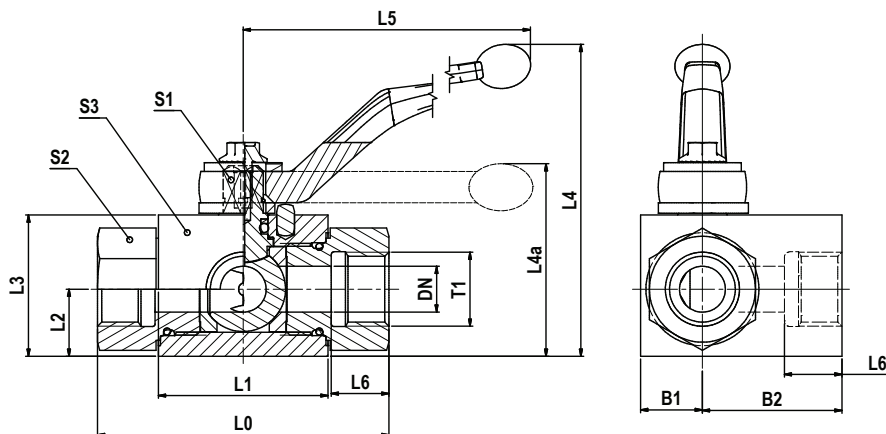

By default 3-way ball valves are manufactured as L-Bore version. Alternative design on request. Pressure inlet only from center port (connector 2).

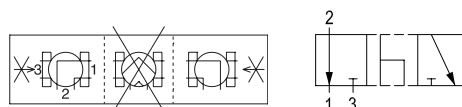

| T1 | DN | L0 | L1 | L2 | L3 | L4 | L4a | L5 | L6 | B1 | B2 | S1 | S2 | S3 | Weight g/1 piece | Order code | PN (bar) |
|---------|----|-----|-----|------|-------|----|-----|-----|------|------|------|----|----|-------|---------------------|----------------------|-------------|
| G 1/8 | 5 | 69 | 40 | 13.5 | 33.0 | 82 | | 115 | 10.0 | 13.0 | 34.5 | 9 | 22 | 47.5 | 550 | KH3/2-1/871X | 500 |
| G 1/4 | 6 | 69 | 40 | 13.5 | 33.0 | 82 | | 115 | 14.0 | 13.0 | 34.5 | 9 | 22 | 47.5 | 550 | KH3/2-1/471X | 500 |
| G 3/8 | 10 | 72 | 43 | 17.5 | 38.0 | 86 | | 115 | 14.0 | 16.0 | 36.0 | 9 | 27 | 52.0 | 770 | KH3/2-3/871X | 500 |
| G 1/2 | 13 | 83 | 48 | 19.0 | 40.0 | 89 | | 115 | 16.5 | 17.5 | 39.5 | 9 | 30 | 57.0 | 900 | KH3/2-1/271X | 500 |
| G 3/4 | 20 | 95 | 62 | 24.5 | 57.0 | | 79 | 200 | 18.0 | 24.5 | 47.5 | 14 | 41 | 72.0 | 1950 | KH3/2-3/471X | 315 |
| G 1 | 25 | 113 | 66 | 29.5 | 65.0 | | 87 | 200 | 20.0 | 29.0 | 56.5 | 14 | 50 | 85.5 | 2400 | KH3/2-171X | 315 |
| G 1 1/4 | 30 | 111 | 81 | 39.0 | 84.5 | | 115 | 320 | 22.0 | 39.0 | 55.0 | 17 | 60 | 94.0 | 5400 | KH3/2-11/471X | 350 |
| G 1 1/2 | 38 | 130 | 104 | 53.0 | 106.0 | | 136 | 320 | 24.0 | 53.0 | 65.0 | 17 | 75 | 118.0 | 9400 | KH3/2-11/271X | 350 |
| G 2 | 48 | 150 | 118 | 58.0 | 116.0 | | 146 | 320 | 26.0 | 58.0 | 75.0 | 17 | 95 | 133.0 | 13000 | KH3/2-271X | 350 |

$\frac{PN \text{ (bar)}}{10} = PN \text{ (MPa)}$

P

| Order code suffixes | | | |
|---------------------|-----------------------------|--------------|---|
| Material | Suffix surface and material | Example | Standard sealing material (no additional suffix needed) |
| Stainless steel | 71 | KH3/2-1/871X | POM / NBR |

Ball valves

KH 3-way compact NPT ball valve steel

Female NPT thread (SAE 476)

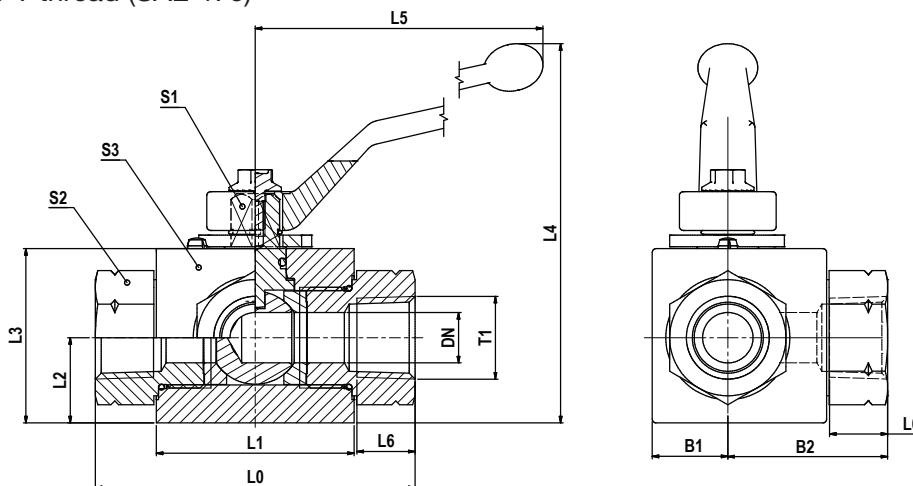

By default 3-way ball valves are manufactured as L-Bore version. Alternative design on request. Pressure inlet only from center port (connector 2).

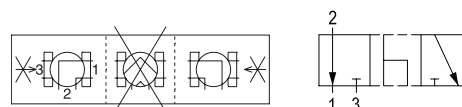

| T1 | DN | L0 | L1 | L2 | L3 | L4 | L5 | L6 | B1 | B2 | S1 | S2 | S3 | Weight g/1 piece | Order code | PN (bar) |
|----------------|-------|-----|----|------|----|-------|-----|------|------|------|----|----|----|---------------------|-----------------------------|-------------|
| 1/8-27 NPT | 5 | 69 | 36 | 14.5 | 30 | 59.5 | 76 | 7.0 | 12.0 | 34.5 | 7 | 19 | 30 | 370 | KH3/2-1/8NPTCFX | 500 |
| 1/4-18 NPT | 6 | 69 | 36 | 14.5 | 30 | 59.5 | 76 | 10.0 | 12.0 | 34.5 | 7 | 19 | 30 | 340 | KH3/2-1/4NPTCFX | 500 |
| 3/8-18 NPT | 10 | 73 | 45 | 14.5 | 35 | 67.5 | 100 | 11.5 | 17.5 | 36.5 | 8 | 24 | 40 | 570 | KH3/2-3/8NPTCFX | 500 |
| 1/2-14 NPT | 13 | 82 | 51 | 22.0 | 45 | 98.0 | 113 | 15.0 | 19.5 | 41.0 | 10 | 30 | 45 | 940 | KH3/2-1/2NPTCFX | 500 |
| 3/4-14 NPT | 20 | 93 | 60 | 29.0 | 60 | 125.0 | 171 | 16.0 | 23.5 | 48.0 | 14 | 41 | 55 | 1720 | KH3/2-3/4NPTCFX | 400 |
| 1-11.5 NPT | 25 | 115 | 70 | 31.0 | 65 | 130.0 | 171 | 19.0 | 30.0 | 57.5 | 14 | 50 | 65 | 2650 | KH3/2-1NPTCFX | 400 |
| 1 1/4-11.5 NPT | 32/25 | 134 | 70 | 31.0 | 65 | 130.0 | 171 | 19.5 | 30.0 | 67.0 | 14 | 50 | 65 | 2710 | KH3/2-11/4NPTDN25CFX | 400 |
| 1 1/2-11.5 NPT | 40/25 | 139 | 70 | 31.0 | 65 | 130.0 | 171 | 19.5 | 30.0 | 69.5 | 14 | 55 | 65 | 2910 | KH3/2-11/2NPTDN25CFX | 400 |

$$\frac{\text{PN (bar)}}{10} = \text{PN (MPa)}$$

Also available in stainless steel with different dimensions, e.g. KH3/2-1/8NPT71X

| Order code suffixes | | | |
|---------------------------------|-----------------------------|-----------------|---|
| Material | Suffix surface and material | Example | Standard sealing material (no additional suffix needed) |
| Steel, zinc plated, Cr(VI)-free | CF | KH3/2-1/8NPTCFX | POM / NBR |

KH – Locking Devices for Two Way and Multiway ball valves

with floating ball – steel and stainless steel

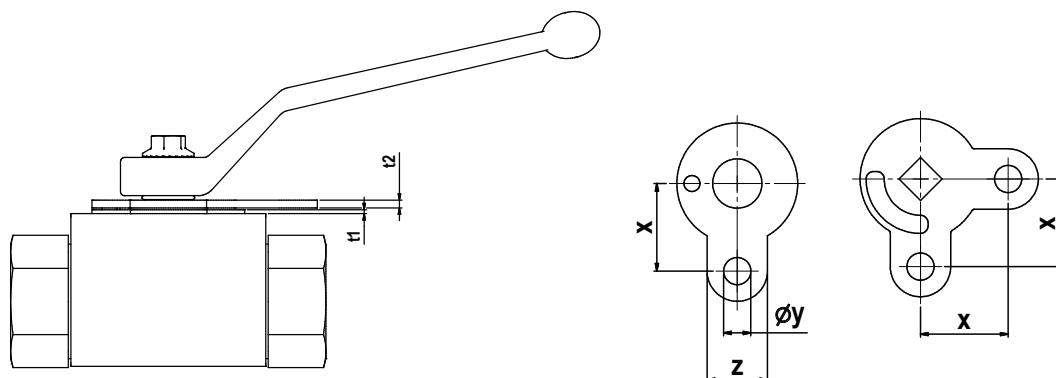

| DN | t1 | t2 | z | y | X | Order code Steel | Order code Stainless steel |
|----------|-----|-----|----|---|------|---------------------|-------------------------------|
| 4/6 | 0.5 | 1.5 | 20 | 9 | 21.5 | KHLOCKINGD.SIZE1X | KHLOCKINGD.SIZE171X |
| 8/10 | 1.0 | 2.0 | 20 | 9 | 26.5 | KHLOCKINGD.SIZE2X | KHLOCKINGD.SIZE271X |
| 12 | 1.0 | 2.0 | 20 | 9 | 29.0 | KHLOCKINGD.SIZE3X | KHLOCKINGD.SIZE371X |
| 20/25 | 1.5 | 2.0 | 20 | 9 | 44.0 | KHLOCKINGD.SIZE5X | KHLOCKINGD.SIZE571X |
| 32/40/50 | 1.5 | 2.0 | 20 | 9 | 54.0 | KHLOCKINGD.SIZE6X | - |
| 32/40/50 | 1.5 | 1.5 | 20 | 9 | 54.0 | - | KHLOCKINGD.SIZE671X |

Disassembly

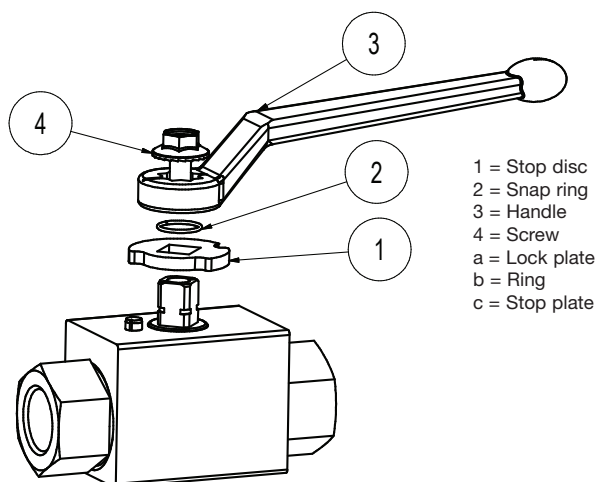

Assembly

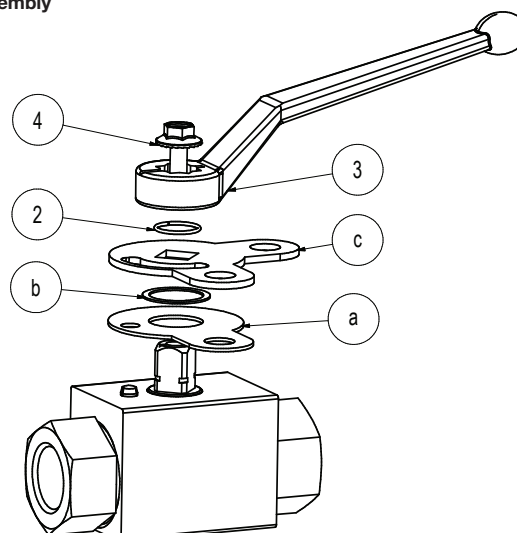

P

*Locking Devices are not suitable for 3/2 Way stainless steel ball valves. Alternative version on request.

Flange ball valves

KH-B Ball valve - SAE Flange connection (3000/6000 PSI)

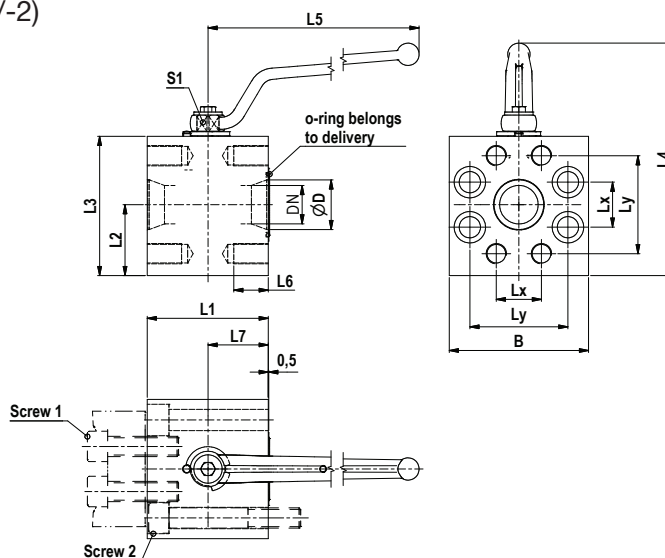
SAE Flange connection (ISO 6162-1/-2)



Pressure applications only with connected flanges!
Screws and flanges not included

3000 PSI Series

| SAE Inch | DN | D | L1 | L2 | L3 | L4 | L5 | L6 | L7 | Lx | Ly | B | S1 | M | Screw 1 | Screw 2 | O-ring | Weight (Steel) kg | Order code Steel | PN (bar) |
|-------------|----|----|-----|------|-------|-----|-----|----|------|------|------|-------|----|-----|-------------|--------------|------------|----------------------|---------------------|-------------|
| 1/2 | 13 | 13 | 68 | 30.0 | 58.0 | 109 | 115 | 15 | 34.0 | 17.5 | 38.1 | 58.0 | 9 | M08 | M8x30-10.9 | M8x70-10.9 | 18.64x3.53 | 1.57 | KH12B1V32CF | 350 |
| 3/4 | 20 | 20 | 70 | 37.5 | 75.0 | 146 | 171 | 17 | 35.0 | 22.2 | 47.6 | 75.0 | 14 | M10 | M10x30-10.9 | M10x80-10.9 | 24.99x3.53 | 2.76 | KH20B1V33CF | 350 |
| 1 | 25 | 25 | 78 | 44.0 | 84.5 | 155 | 171 | 17 | 39.0 | 26.2 | 52.4 | 84.5 | 14 | M10 | M10x30-10.9 | M10x80-10.9 | 32.92x3.53 | 3.85 | KH25B1V34CF | 320 |
| 1 1/4 | 25 | 32 | 90 | 50.0 | 100.0 | 171 | 171 | 21 | 45.0 | 30.2 | 58.7 | 100.0 | 14 | M10 | M10x30-10.9 | M10x90-10.9 | 37.96x3.53 | 6.35 | KH32B1V35CF | 280 |
| 1 1/2 | 32 | 38 | 99 | 60.0 | 120.0 | 214 | 306 | 21 | 49.5 | 35.7 | 69.9 | 120.0 | 17 | M12 | M12x35-10.9 | M12x100-10.9 | 47.22x3.53 | 10.40 | KH40B1V36CF | 210 |
| 2 | 38 | 49 | 120 | 70.0 | 137.5 | 232 | 306 | 21 | 60.0 | 42.9 | 77.8 | 137.5 | 17 | M12 | M12x35-10.9 | M12x120-10.9 | 56.74x3.53 | 16.00 | KH50B1V38CF | 210 |

6000 PSI Series

| SAE Inch | DN | D | L1 | L2 | L3 | L4 | L5 | L6 | L7 | Lx | Ly | B | S1 | M | Screw 1 | Screw 2 | O-ring | Weight (Steel) kg | Order code Steel | PN (bar) |
|-------------|----|----|-----|------|-------|-----|-----|----|------|------|------|-------|----|-----|-------------|--------------|------------|----------------------|---------------------|-------------|
| 1/2 | 13 | 13 | 68 | 30.0 | 58.0 | 109 | 115 | 15 | 34.0 | 18.2 | 40.5 | 58.0 | 9 | M08 | M8x30-10.9 | M8x70-10.9 | 18.64x3.53 | 1.57 | KH12B1V62CF | 420 |
| 3/4 | 20 | 20 | 70 | 37.5 | 75.0 | 146 | 171 | 17 | 35.0 | 23.8 | 50.8 | 75.0 | 14 | M10 | M10x35-10.9 | M10x80-10.9 | 24.99x3.53 | 2.73 | KH20B1V63CF | 420 |
| 1 | 25 | 25 | 78 | 44.0 | 84.5 | 155 | 171 | 21 | 39.0 | 27.8 | 57.2 | 84.5 | 14 | M12 | M12x45-10.9 | M12x80-10.9 | 32.92x3.53 | 3.63 | KH25B1V64CF | 420 |
| 1 1/4 | 25 | 32 | 90 | 50.0 | 100.0 | 171 | 171 | 20 | 45.0 | 31.8 | 66.7 | 100.0 | 14 | M12 | M12x45-10.9 | M12x90-10.9 | 37.96x3.53 | 6.25 | KH32B1V65CF | 420 |
| 1 1/2 | 32 | 38 | 99 | 60.0 | 120.0 | 214 | 306 | 27 | 49.5 | 36.5 | 79.4 | 120.0 | 17 | M16 | M16x55-10.9 | M16x100-10.9 | 47.22x3.53 | 9.76 | KH40B1V66CF | 420 |
| 2 | 38 | 49 | 120 | 70.0 | 137.5 | 232 | 306 | 34 | 60.0 | 44.5 | 96.8 | 137.5 | 17 | M20 | M20x70-10.9 | M20x130-10.9 | 56.74x3.53 | 14.74 | KH50B1V68CF | 420 |

$$\frac{\text{PN (bar)}}{10} = \text{PN (MPa)}$$

More flange ball valves see catalogue 4162.

| Order code suffixes | | | |
|---------------------------------|-----------------------------|-------------|---|
| Material | Suffix surface and material | Example | Standard sealing material (no additional suffix needed) |
| Steel, zinc plated, Cr(VI)-free | CF | KH12B1V62CF | POM / NBR |
| Stainless steel | 71 | KH12B1V6271 | POM / NBR |



KH-A Ball valve - SAE Flange adapter connection

SAE Flange adapter (ISO 6162-1/-2)

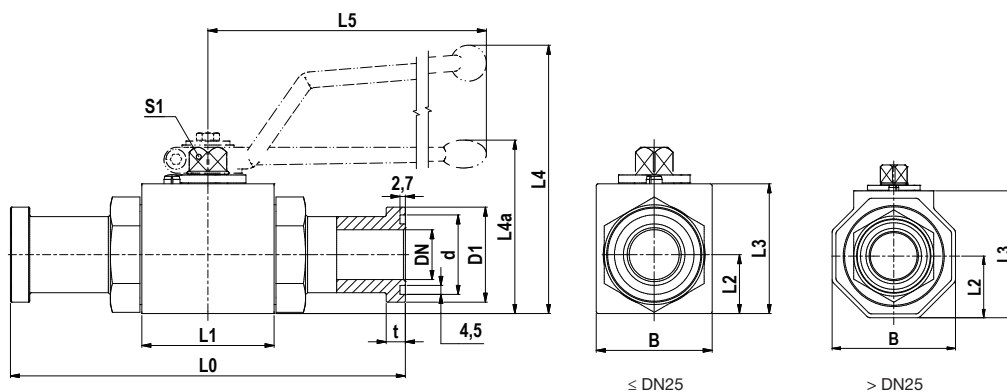

3000 PSI Series

| SAE Inch | DN | L0 | L1 | L2 | L3 | L4 | L4a | L5 | B | D1 | d | t | S1 | Weight (steel)/kg | Order code | PN (bar) |
|-------------|----|-----|-----|------|-----|----|-----|-----|-----|------|------|-----|----|----------------------|------------------|-------------|
| 1/2 | 13 | 151 | 48 | 19.0 | 40 | 89 | | 115 | 35 | 30.2 | 25.5 | 6.8 | 9 | 0.85 | KH12A32CF | 350 |
| 3/4 | 20 | 162 | 62 | 24.5 | 57 | | 79 | 200 | 49 | 38.1 | 31.9 | 6.8 | 14 | 1.87 | KH20A33CF | 350 |
| 1 | 25 | 178 | 66 | 29.5 | 65 | | 87 | 200 | 58 | 44.4 | 39.8 | 8.1 | 14 | 2.70 | KH25A34CF | 315 |
| 1 1/4 | 32 | 191 | 80 | 40.5 | 86 | | 107 | 320 | 81 | 50.8 | 44.6 | 8.1 | 17 | 4.22 | KH32A35CF | 280 |
| 1 1/2 | 38 | 231 | 85 | 50.0 | 103 | | 124 | 320 | 100 | 60.3 | 54.1 | 8.1 | 17 | 6.54 | KH40A36CF | 210 |
| 2 | 48 | 232 | 100 | 59.0 | 117 | | 138 | 320 | 118 | 71.4 | 63.6 | 9.6 | 17 | 9.29 | KH50A38CF | 210 |

6000 PSI Series

| SAE Inch | DN | L0 | L1 | L2 | L3 | L4 | L4a | L5 | B | D1 | d | t | S1 | Weight (steel)/kg | Order code | PN (bar) |
|-------------|----|-----|-----|------|-----|----|-----|-----|-----|------|------|------|----|----------------------|------------------|-------------|
| 1/2 | 13 | 151 | 48 | 19.0 | 40 | 89 | | 115 | 35 | 31.8 | 25.5 | 7.9 | 9 | 0.90 | KH12A62CF | 420 |
| 3/4 | 20 | 174 | 62 | 24.5 | 57 | | 79 | 200 | 49 | 41.3 | 31.9 | 8.9 | 14 | 1.99 | KH20A63CF | 420 |
| 1 | 25 | 206 | 74 | 34.5 | 70 | | 92 | 200 | 70 | 47.6 | 39.8 | 9.6 | 14 | 3.66 | KH25A64CF | 420 |
| 1 1/4 | 32 | 223 | 80 | 40.5 | 86 | | 107 | 320 | 81 | 54.0 | 44.6 | 10.4 | 17 | 4.72 | KH32A65CF | 420 |
| 1 1/2 | 40 | 281 | 85 | 50.0 | 103 | | 124 | 320 | 100 | 63.5 | 54.1 | 12.7 | 17 | 7.49 | KH40A66CF | 420 |
| 2 | 48 | 316 | 100 | 59.0 | 117 | | 138 | 320 | 118 | 79.4 | 63.6 | 12.7 | 17 | 11.39 | KH50A68CF | 420 |

$$\frac{\text{PN (bar)}}{10} = \text{PN (MPa)}$$

Also available in stainless steel with different dimensions, e.g. KH12A3271

Handles are part of the delivery.

O-rings are part of the delivery.

More flange ball valves see catalogue 4162.

| Order code suffixes | | | |
|---------------------------------|-----------------------------|-----------|---|
| Material | Suffix surface and material | Example | Standard sealing material (no additional suffix needed) |
| Steel, zinc plated, Cr(VI)-free | CF | KH12A62CF | POM / NBR |



Flange ball valves

KH-T Ball valve - SAE Flange connection ISO 6162 (1/2)

SAE Flange connection (ISO 6162-1/-2)

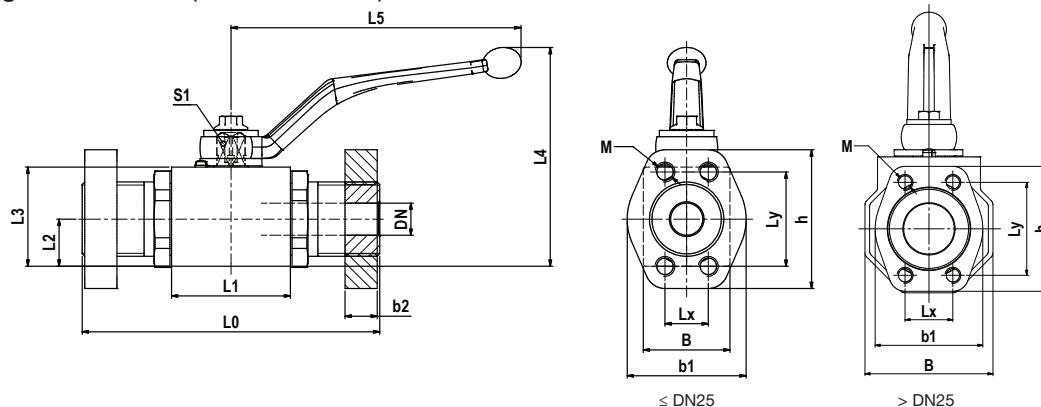
3000 PSI series

| SAE Inch | DN | L0 | L1 | L2 | L3 | L4 | L5 | B | Lx | Ly | b1 | b2 | h | M | S1 | O-ring | Weight (Steel) kg | Order code | PN (bar) |
|-------------|-------|-----|-----|------|-----|-----|-----|-----|------|------|-----|----|-----|-----|----|------------|----------------------|--------------------------|-------------|
| 1/2 | 13 | 120 | 48 | 19.0 | 40 | 89 | 115 | 35 | 17.5 | 38.1 | 48 | 13 | 56 | M08 | 9 | 18.64x3.53 | 1.5 | KH-T-308-13CF | 350 |
| 3/4 | 20 | 136 | 62 | 24.5 | 57 | 127 | 171 | 49 | 22.2 | 47.6 | 50 | 14 | 65 | M10 | 14 | 24.99x3.53 | 3.0 | KH-T-312-20CF | 315 |
| 1 | 25 | 148 | 66 | 29.5 | 65 | 135 | 171 | 58 | 26.2 | 52.4 | 60 | 16 | 70 | M10 | 14 | 32.92x3.53 | 4.5 | KH-T-316-25CF | 315 |
| 1 1/4 | 32 | 172 | 80 | 40.5 | 86 | 180 | 306 | 81 | 30.2 | 58.7 | 68 | 16 | 79 | M10 | 17 | 37.69x3.53 | 7.5 | KH-T-320-32CF | 280 |
| 1 1/4 | 32 | 172 | 80 | 40.5 | 86 | 180 | 306 | 81 | 30.2 | 58.7 | 68 | 16 | 79 | M12 | 17 | 37.69x3.53 | 7.5 | KH-T-320-32TM12CF | 210 |
| 1 1/2 | 40 | 177 | 85 | 50.0 | 103 | 197 | 306 | 100 | 35.7 | 69.9 | 78 | 16 | 93 | M12 | 17 | 47.22x3.53 | 11.1 | KH-T-324-40CF | 210 |
| 2 | 50 | 196 | 100 | 59.0 | 117 | 211 | 306 | 118 | 42.9 | 77.8 | 90 | 16 | 102 | M12 | 17 | 56.74x3.53 | 19.3 | KH-T-332-50CF | 210 |
| 2 1/2 | 50/65 | 196 | 100 | 59.0 | 117 | 211 | 306 | 118 | 50.8 | 88.9 | 105 | 19 | 114 | M12 | 17 | 69.44x3.53 | 19.9 | KH-T-340-50CF | 175 |

6000 PSI series

| SAE Inch | DN | L0 | L1 | L2 | L3 | L4 | L5 | B | Lx | Ly | b1 | b2 | h | M | S1 | O-ring | Weight kg | Order code | PN (bar) |
|-------------|----|-----|-----|------|-----|-----|-----|-----|------|------|-----|----|-----|-----|----|------------|--------------|--------------------------|-------------|
| 1/2 | 13 | 120 | 48 | 19.0 | 40 | 89 | 115 | 35 | 18.2 | 40.5 | 48 | 16 | 56 | M08 | 9 | 18.64x3.53 | 1.6 | KH-T-608-13CF | 420 |
| 3/4 | 20 | 136 | 62 | 24.5 | 57 | 127 | 171 | 49 | 23.8 | 50.8 | 60 | 19 | 71 | M10 | 14 | 24.99x3.53 | 3.3 | KH-T-612-20CF | 420 |
| 1 | 25 | 156 | 74 | 34.5 | 70 | 140 | 171 | 70 | 27.8 | 57.2 | 70 | 24 | 81 | M12 | 14 | 32.92x3.53 | 5.0 | KH-T-616-25CF | 420 |
| 1 1/4 | 32 | 172 | 80 | 40.5 | 86 | 180 | 306 | 81 | 31.8 | 66.7 | 78 | 27 | 95 | M12 | 17 | 37.69x3.53 | 8.5 | KH-T-620-32CF | 420 |
| 1 1/4 | 32 | 172 | 80 | 40.5 | 86 | 180 | 306 | 81 | 31.8 | 66.7 | 78 | 27 | 95 | M14 | 17 | 37.69x3.53 | 8.5 | KH-T-620-32TM14CF | 420 |
| 1 1/2 | 40 | 177 | 85 | 50.0 | 103 | 197 | 306 | 100 | 36.5 | 79.4 | 94 | 30 | 112 | M16 | 17 | 47.22x3.53 | 12.2 | KH-T-624-40CF | 420 |
| 2 | 50 | 196 | 100 | 59.0 | 117 | 211 | 306 | 118 | 44.5 | 96.8 | 114 | 35 | 134 | M20 | 17 | 56.74x3.53 | 21.5 | KH-T-632-50CF | 420 |

Also available in stainless steel with different dimensions, e.g. KH-T-308-13SS

More flange ball valves see catalogue 4162.

| Order code suffixes | | | |
|---------------------------------|-----------------------------|---------------|---|
| Material | Suffix surface and material | Example | Standard sealing material (no additional suffix needed) |
| Steel, zinc plated, Cr(VI)-free | CF | KH-T-308-13CF | POM / NBR |

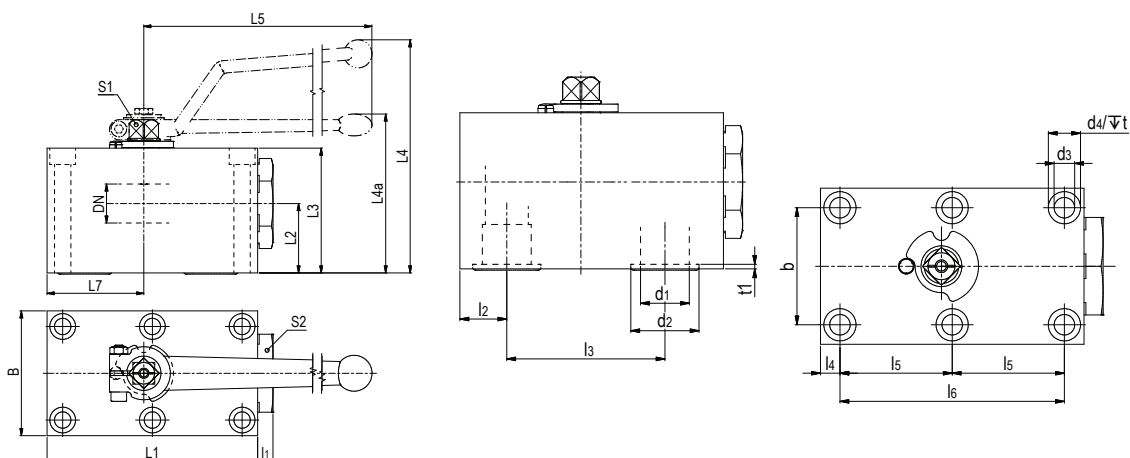
KHBLOCK 2-way manifold ball valve

| DN | L1 | L2 | L3 | L4 | L4a | L5 | L7 | l1 | l2 | l3 | l4 | l5 | l6 | b | B | d1 | d2 | d3 | d4 | t | t1 |
|----|-----|------|-----|------------|-----|-----|-------|----|------|-----|------|------|-----|-----|-----|------|------|------|------|------|-----|
| 6 | 57 | 19.5 | 35 | 67 | | 80 | 26.0 | 6 | 8.5 | 35 | 8.5 | 17.5 | 35 | 27 | 40 | 6.0 | 11.8 | 6.5 | 10.5 | 7.0 | 2.0 |
| 10 | 70 | 24.5 | 45 | 96 | | 115 | 29.0 | 10 | 10.0 | 44 | 7.5 | 27.5 | 55 | 40 | 55 | 9.5 | 14.9 | 8.4 | 13.5 | 8.5 | 2.0 |
| 12 | 98 | 34.0 | 55 | 104 | | 115 | 42.5 | 10 | 16.0 | 58 | 7.5 | 41.5 | 83 | 45 | 60 | 13.0 | 24.9 | 8.4 | 13.5 | 7.0 | 2.0 |
| 20 | 117 | 37.5 | 70 | | 92 | 200 | 51.0 | 10 | 20.0 | 69 | 10.0 | 48.5 | 97 | 51 | 70 | 20.0 | 29.0 | 10.5 | 16.5 | 10.5 | 2.0 |
| 25 | 135 | 44.5 | 80 | | 102 | 200 | 62.0 | 10 | 24.0 | 81 | 10.0 | 57.5 | 115 | 60 | 80 | 25.0 | 34.9 | 10.5 | 16.5 | 10.5 | 2.5 |
| 32 | 165 | 54.5 | 100 | on request | 130 | 320 | 75.0 | 11 | 29.0 | 96 | 12.0 | 68.0 | 136 | 78 | 100 | 32.0 | 40.0 | 13.0 | 19.0 | 12.0 | 2.0 |
| 40 | 200 | 57.0 | 110 | | 140 | 320 | 84.5 | 17 | 28.5 | 112 | 28.5 | 56.0 | 112 | 95 | 130 | 38.0 | 47.7 | 16.5 | 25.0 | 19.0 | 2.5 |
| 50 | 240 | 71.0 | 129 | | 159 | 320 | 106.0 | 15 | 38.0 | 136 | 38.0 | 68.0 | 136 | 112 | 150 | 48.0 | 59.8 | 21.0 | 31.0 | 21.5 | 2.5 |

| DN | S1 | S2 | Hexagon Screws | Torque for screws | O-ring | Weight kg | Order code steel | PN (bar) |
|----|----|----|-------------------|-------------------|------------|-----------|----------------------|----------|
| 6 | 7 | 19 | 6x M6x40 - 12.9 | 14 | 7x2.5 | 0.60 | KHBLOCKDN6CF | 500 |
| 10 | 9 | 30 | 6x M8x40 - 12.9 | 35 | 10x2.5 | 1.30 | KHBLOCKDN10CF | 500 |
| 12 | 9 | 32 | 6x M8x60 - 12.9 | 35 | 20x2.5 | 2.30 | KHBLOCKDN12CF | 420 |
| 20 | 14 | 46 | 6x M10x80 - 12.9 | 70 | 23.47x2.62 | 3.92 | KHBLOCKDN20CF | 420 |
| 25 | 14 | 50 | 6x M10x90 - 12.9 | 70 | 29x3 | 5.68 | KHBLOCKDN25CF | 420 |
| 32 | 17 | 70 | 6x M12x110 - 12.9 | 110 | 34.59x2.62 | 11.00 | KHBLOCKDN32CF | 420 |
| 40 | 17 | 80 | 6x M16x120 - 12.9 | 300 | 42x3 | 18.78 | KHBLOCKDN40CF | 420 |
| 50 | 17 | 90 | 6x M20x140 - 12.9 | 600 | 54x3 | 29.70 | KHBLOCKDN50CF | 420 |

Tmin/Tmax Steel -20°C / 100°C
 Tmin/Tmax Stainless steel -30°C / 100°C

Handles are part of the delivery.
 O-ring are part of the delivery.
 Screws are not part of the delivery.



| Order code suffixes | | | |
|---------------------------------|-----------------------------|---------------|---|
| Material | Suffix surface and material | Example | Standard sealing material (no additional suffix needed) |
| Steel, zinc plated, Cr(VI)-free | CF | KHBLOCKDN10CF | POM / NBR |
| Stainless steel | 71 | KHBLOCKDN1071 | POM / NBR |

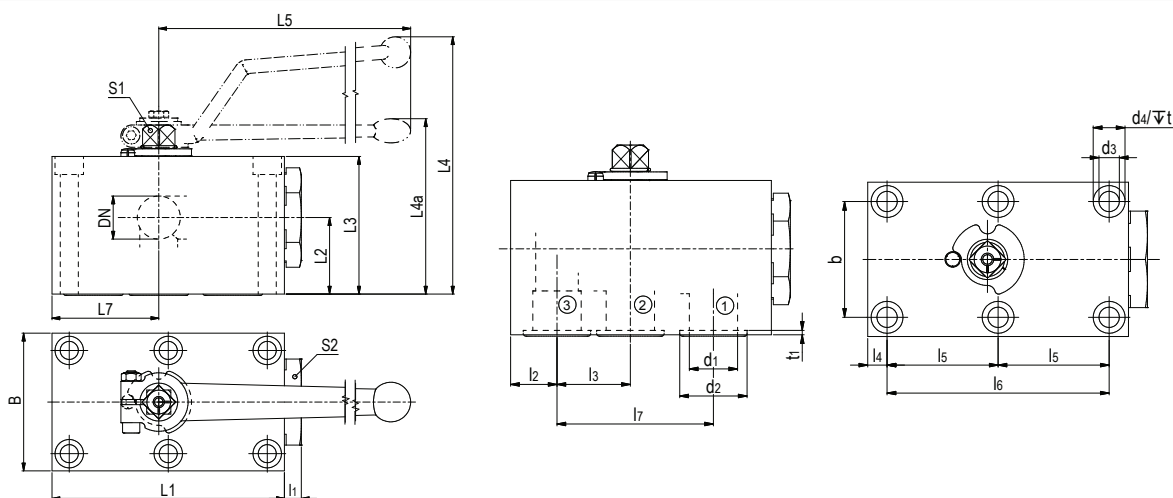

Ball valves for block structure

KHBLOCK 3-way manifold ball valve

Pressure inlet only from center port (connector 2)

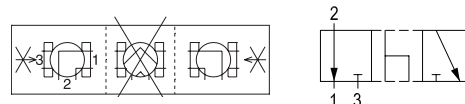

| DN | L1 | L2 | L3 | L4 | L4* | L5 | L7 | l1 | l2 | l3 | l4 | l5 | l6 | l7 | b | B | d1 | d2 | d3 | d4 |
|----|-----|------|-----|------------|-----|-----|-------|----|------|------|------|------|-----|-----|-----|-----|------|------|------|------|
| 6 | 57 | 19.5 | 35 | 67 | | 80 | 26.0 | 6 | 8.5 | 17.5 | 8.5 | | 35 | 35 | 27 | 40 | 6.0 | 12.0 | 6.5 | 10.5 |
| 10 | 70 | 24.5 | 45 | 93 | | 115 | 29.0 | 10 | 10.0 | 19.0 | 7.5 | | 55 | 44 | 40 | 55 | 9.5 | 15.0 | 8.5 | 13.5 |
| 12 | 98 | 34.0 | 55 | 104 | | 115 | 42.5 | 10 | 16.0 | 26.5 | 7.5 | 41.5 | 83 | 58 | 45 | 60 | 13.0 | 25.0 | 8.5 | 13.5 |
| 20 | 117 | 37.5 | 70 | on request | 92 | 200 | 51.0 | 10 | 20.0 | 31.0 | 10.0 | 48.5 | 97 | 69 | 51 | 70 | 20.0 | 29.0 | 10.5 | 16.5 |
| 25 | 135 | 44.5 | 80 | | 102 | 200 | 62.0 | 10 | 24.0 | 38.0 | 10.0 | 57.5 | 115 | 81 | 60 | 80 | 25.0 | 35.0 | 10.5 | 16.5 |
| 32 | 165 | 54.5 | 100 | | 130 | 320 | 75.0 | 11 | 29.0 | 46.0 | 12.0 | 68.0 | 136 | 96 | 78 | 100 | 32.0 | 40.0 | 13.0 | 19.0 |
| 40 | 200 | 57.0 | 110 | | 140 | 320 | 84.5 | 17 | 28.5 | 56.0 | 28.5 | 56.0 | 112 | 112 | 95 | 130 | 38.0 | 47.5 | 16.5 | 25.0 |
| 50 | 240 | 71.0 | 129 | | 159 | 320 | 106.0 | 15 | 38.0 | 68.0 | 38.0 | 68.0 | 136 | 136 | 112 | 150 | 48.0 | 60.0 | 21.0 | 31.0 |

| DN | t | t1 | S1 | S2 | Hexagon screws | Torque for screws | O-ring | Weight kg | Order code steel | PN (bar) |
|----|------|-----|----|----|-------------------|-------------------|------------|-----------|-------------------------|----------|
| 6 | 7.0 | 2.0 | 7 | 19 | 4x M6x40 - 12.9 | 14 | 7x2.5 | 0.60 | KHBLOCK3/2DN6CF | 500 |
| 10 | 8.5 | 2.0 | 9 | 30 | 4x M8x40 - 12.9 | 35 | 10x2.5 | 1.30 | KHBLOCK3/2DN10CF | 500 |
| 12 | 7.0 | 2.0 | 9 | 32 | 6x M8x60 - 12.9 | 35 | 20x2.5 | 2.32 | KHBLOCK3/2DN12CF | 420 |
| 20 | 10.5 | 2.0 | 14 | 46 | 6x M10x80 - 12.9 | 70 | 23.47x2.62 | 3.90 | KHBLOCK3/2DN20CF | 420 |
| 25 | 10.5 | 2.5 | 14 | 50 | 6x M10x90 - 12.9 | 70 | 29x3 | 5.68 | KHBLOCK3/2DN25CF | 420 |
| 32 | 12.0 | 2.0 | 17 | 70 | 6x M12x110 - 12.9 | 110 | 34.59x2.62 | 11.00 | KHBLOCK3/2DN32CF | 420 |
| 40 | 19.0 | 2.5 | 17 | 80 | 6x M16x120 - 12.9 | 300 | 42x3 | 18.70 | KHBLOCK3/2DN40CF | 420 |
| 50 | 21.5 | 2.5 | 17 | 90 | 6x M20x140 - 12.9 | 600 | 54x3 | 28.80 | KHBLOCK3/2DN50CF | 420 |

Tmin/Tmax Steel -20°C / 100°C

Tmin/Tmax Stainless steel -30°C / 100°C

Handles are part of the delivery.

O-ring are part of the delivery.

Screws are not part of the delivery.

| Order code suffixes | | | |
|---------------------------------|-----------------------------|-----------------|---|
| Material | Suffix surface and material | Example | Standard sealing material (no additional suffix needed) |
| Steel, zinc plated, Cr(VI)-free | CF | KHBLOCK3/2DN6CF | POM / NBR |
| Stainless steel | 71 | KHBLOCK3/2DN671 | POM / NBR |



Technical data flow control valves

Leakage rate

Flow control valves: Max. 0.01 x DN mm³/sec - Test medium water (DIN EN 12266)

Check valves: Max. 1.0 x DN mm³/sec - Test medium water (DIN EN 12266)

Flow control valves can not be used as shut off devices. Small leakage rates are possible in closed position.

The pressure ratings PN for flow control valves include design factor 1.5 (according DIN 3230 T5 and ISO 5208).

Steel Flow control valves

Material:

Body: Steel, Cr(VI)-free plated

Seals:

O-ring: NBR

According to application, different seal combinations are available*

Temperature range:

-20 up to +100 °C.

Cracking pressure:

0.5 bar (optional 4.5 bar)

Stainless Steel Flow control valves

Material:

Body: Stainless steel

Seals:

O-ring: NBR

According to application, different seal combinations are available.*

Temperature range:

-30 up to +100 °C.

Cracking pressure:

0.5 bar (optional 4.5 bar)

Caution!

Please note the admissible pressure ratings of connection components!

*Remarks:

For clarification of the suitability of the restriction valves for different media and applications please provide the following data: system pressure, medium, temperature, possible pressure peaks (including pressure and frequency) and possible operation with full differential pressure.



Flow control valves

RDV Flow Control Valve

Female BSPP thread (ISO 1179-1)

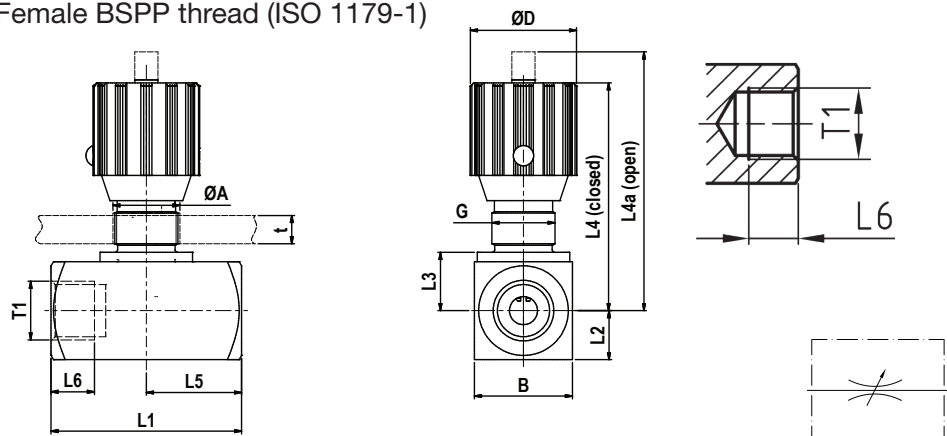

| T1 | L1 | L2 | L3 | L4 | L4a | L5 | L6 | B | D | A | G | tmax | Order code steel | PN (bar) |
|---------|-----|------|------|-----|-----|----|------|----|----|----|------|------|-------------------|----------|
| G 1/8 | 38 | 8.0 | 10.0 | 51 | 56 | 19 | 9.0 | 16 | 24 | 13 | Pg7 | 4 | RDV1/8CFX | 350 |
| G 1/4 | 48 | 12.5 | 14.5 | 65 | 71 | 24 | 12.0 | 25 | 29 | 19 | Pg11 | 7 | RDV1/4CFX | 350 |
| G 3/8 | 58 | 15.0 | 17.0 | 68 | 75 | 29 | 13.5 | 30 | 29 | 19 | Pg11 | 7 | RDV3/8CFX | 350 |
| G 1/2 | 68 | 17.5 | 21.0 | 82 | 92 | 34 | 14.5 | 35 | 38 | 23 | Pg16 | 7 | RDV1/2CFX | 350 |
| G 3/4 | 78 | 22.5 | 26.0 | 96 | 106 | 39 | 17.5 | 45 | 38 | 23 | Pg16 | 7 | RDV3/4CFX | 350 |
| G 1 | 108 | 25.0 | 30.0 | 121 | 134 | 54 | 19.5 | 50 | 49 | 38 | Pg29 | 10 | RDV1CFX | 350 |
| G 1 1/4 | 108 | 30.0 | 35.0 | 126 | 139 | 54 | 21.5 | 60 | 49 | 38 | Pg29 | 10 | RDV11/4CFX | 350 |
| G 1 1/2 | 108 | 35.0 | 40.0 | 131 | 144 | 54 | 23.5 | 70 | 49 | 38 | Pg29 | 10 | RDV11/2CFX | 350 |
| G 2 | 120 | 45.0 | 50.0 | 141 | 154 | 60 | 25.5 | 90 | 49 | 38 | Pg29 | 10 | RDV2CFX | 350 |

Flow control valves should not be used as shut-off device.
NPT and UNF connections on request.

| Order code suffixes | | | |
|---------------------------------|-----------------------------|-----------|---|
| Material | Suffix surface and material | Example | Standard sealing material (no additional suffix needed) |
| Steel, zinc plated, Cr(VI)-free | CF | RDV1/8CFX | POM / NBR |
| Stainless steel | 71 | RDV1/871X | POM / NBR |



RDVR Flow Control Check Valve

Female BSPP thread (ISO 1179-1)

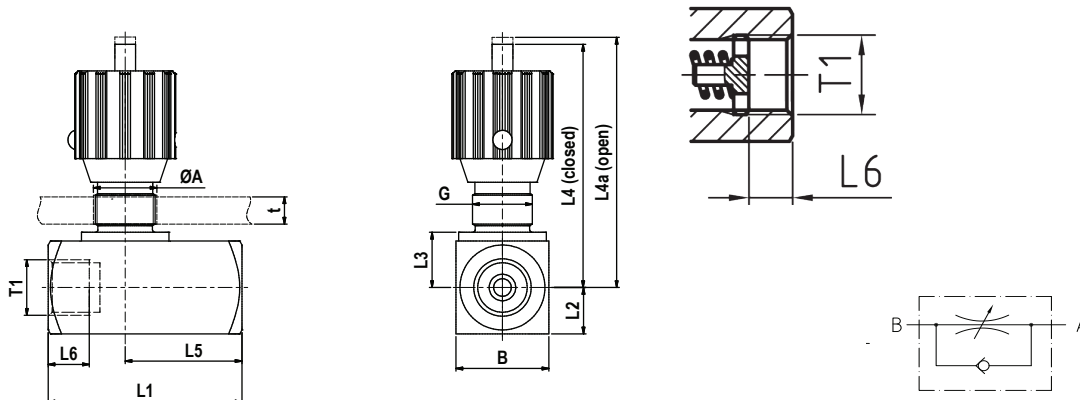

| T1 | L1 | L2 | L3 | L4 | L4a | L5 | L6 | B | D | A | G | tmax | Order code steel | PN (bar) |
|---------|-----|------|------|-----|-----|-------|------|----|----|----|------|------|--------------------|----------|
| G 1/8 | 45 | 8.0 | 10.0 | 51 | 56 | 26.0 | 9.5 | 16 | 24 | 13 | Pg7 | 4 | RDVR1/8CFX | 350 |
| G 1/4 | 55 | 12.5 | 14.5 | 65 | 71 | 33.5 | 13.5 | 25 | 29 | 19 | Pg11 | 7 | RDVR1/4CFX | 350 |
| G 3/8 | 65 | 15.0 | 17.0 | 68 | 75 | 41.0 | 13.5 | 30 | 29 | 19 | Pg11 | 7 | RDVR3/8CFX | 350 |
| G 1/2 | 73 | 17.5 | 21.0 | 82 | 92 | 44.0 | 15.5 | 35 | 38 | 23 | Pg16 | 7 | RDVR1/2CFX | 350 |
| G 3/4 | 88 | 22.5 | 26.0 | 96 | 106 | 57.0 | 17.5 | 45 | 38 | 23 | Pg16 | 7 | RDVR3/4CFX | 350 |
| G 1 | 127 | 25.0 | 30.0 | 121 | 134 | 77.0 | 19.5 | 50 | 49 | 38 | Pg29 | 10 | RDVR1CFX | 350 |
| G 1 1/4 | 143 | 30.0 | 35.0 | 126 | 139 | 93.0 | 21.5 | 60 | 49 | 38 | Pg29 | 10 | RDVR11/4CFX | 350 |
| G 1 1/2 | 143 | 35.0 | 40.0 | 131 | 144 | 91.0 | 23.5 | 70 | 49 | 38 | Pg29 | 10 | RDVR11/2CFX | 350 |
| G 2 | 165 | 45.0 | 50.0 | 141 | 154 | 111.0 | 25.5 | 90 | 49 | 38 | Pg29 | 10 | RDVR2CFX | 350 |

Flow control valves should not be used as shut-off device.
NPT and UNF connections on request.

P

| Order code suffixes | | | |
|---------------------------------|-----------------------------|------------|---|
| Material | Suffix surface and material | Example | Standard sealing material (no additional suffix needed) |
| Steel, zinc plated, Cr(VI)-free | CF | RDVR1/8CFX | POM / NBR |
| Stainless steel | 71 | RDVR1/871X | POM / NBR |

Shut off valves

DV Shut-off valve PN 10 – Casing DIN 3512

EO 24° cone end / EO 24° cone end

(with internal threaded spindle)

For cold and warm water* up to 80°C, compressed air, mineral oils and fuel oils types EL and L, 6 bar and up to 80°C.

The pressure specification PN for hand-operated

shut-off valves applies to the design

factor 1,5 (according DIN 3230 T5

and ISO 5208).

Caution!

Please note the admissible pressure ratings for the EO-tube ends.

DVAE

EO tube end ⇒ male BSPP

DVAA

male BSPP ⇐ EO tube end

DV-valves with male BSPP thread on request.

*Indicate type of water or additive if any

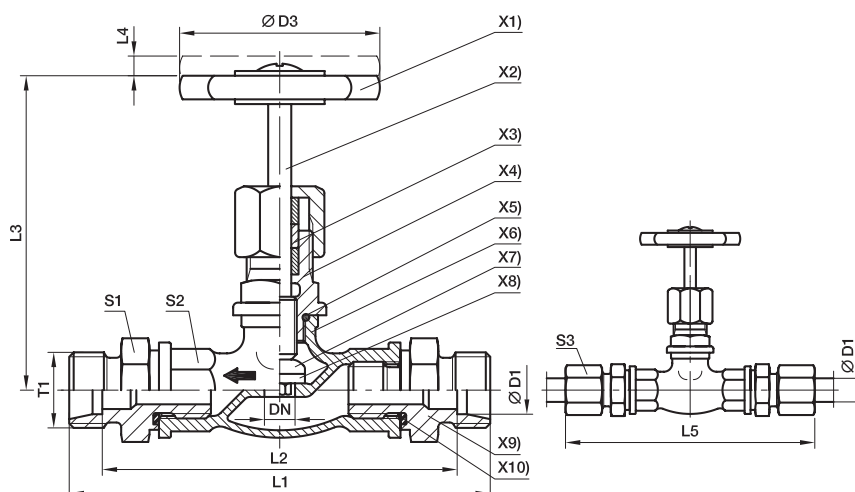

- X1) **Hand wheel:** material: Polyamid
- X2) **Spindle:** material: Brass 2.0401
- X3) **Stuffing boxpacking:** PTFE Compound
- X4) **Haed piece:** material: Brass 2.0401
- X5) **Sealing:** O-ring NBR (e.g. Perbunan)
- X6) **Casing:** material: Brass 2.0340.02
- X7) **Valve cone:** material: Brass 2.0401
- X8) **Shut-off sealing:** NBR (e.g. Perbunan)
- X9) **Male stud fitting:** material: Brass 2.0540
- X10) **Sealing:** Eolastic-sealing NBR (e.g. Perbunan)

| Series | D1 | T1 | DN | D3 | L1 | L2 | L3 | L4 | L5 | S1 | S2 | S3 | Weight g/1 piece | Order code* | PN (bar) ¹⁾ without surface |
|-----------------|----|----------|----|----|-----|-----|-----|----|-----|----|----|----|---------------------|---------------|--|
| L ³⁾ | 06 | M 12x1.5 | 5 | 50 | 102 | 88 | 63 | 7 | 117 | 22 | 21 | 14 | 313 | DV06LX | 10 |
| | 08 | M 14x1.5 | 6 | 50 | 102 | 88 | 63 | 7 | 117 | 22 | 21 | 17 | 305 | DV08LX | 10 |
| | 10 | M 16x1.5 | 8 | 50 | 104 | 90 | 63 | 7 | 119 | 22 | 21 | 19 | 308 | DV10LX | 10 |
| | 12 | M 18x1.5 | 10 | 50 | 104 | 90 | 63 | 7 | 119 | 22 | 21 | 22 | 304 | DV12LX | 10 |
| | 15 | M 22x1.5 | 12 | 50 | 107 | 93 | 65 | 8 | 123 | 27 | 25 | 27 | 426 | DV15LX | 10 |
| | 18 | M 26x1.5 | 16 | 50 | 109 | 94 | 67 | 8 | 126 | 27 | 25 | 32 | 434 | DV18LX | 10 |
| | 22 | M 30x2.0 | 20 | 60 | 123 | 108 | 67 | 8 | 140 | 32 | 32 | 36 | 670 | DV22LX | 10 |
| | 28 | M 36x2.0 | 25 | 60 | 140 | 125 | 95 | 10 | 158 | 41 | 38 | 41 | 1030 | DV28LX | 10 |
| | 35 | M 45x2.0 | 32 | 70 | 166 | 145 | 102 | 10 | 188 | 50 | 47 | 50 | 1640 | DV35LX | 10 |

1) Pressure shown = item deliverable

3) L = light series

$$\frac{\text{PN (bar)}}{10} = \text{PN (MPa)}$$

Delivery without nut and ring. Information on ordering complete fittings or alternative sealing materials see page 17.

 *Please add the **suffixes** below according to the material/surface required.

| Order code suffixes | | | |
|---------------------|-----------------------------|---------|---|
| Material | Suffix surface and material | Example | Standard sealing material (no additional suffix needed) |
| Brass 2.0340.02 | without | DV06LX | PTFE / NBR |



LD Shut-off valve PN 40

EO 24° cone end / EO 24° cone end

(with internal threaded spindle)

For hydraulic oil, mineral, oil, fuel oil, Diesel, water* etc. Temperature up to 150°C. For steam up to 10 bar.

For compressed air up to 35 bar on request. CS DIN 86501 Rg.-N.

The pressure specification PN for hand-operated shut-off valves applies to the design factor 1,5 (according to DIN 3230 T5 and ISO 5208).

Caution!

Please note the admissible pressure ratings for the EO-tube ends.

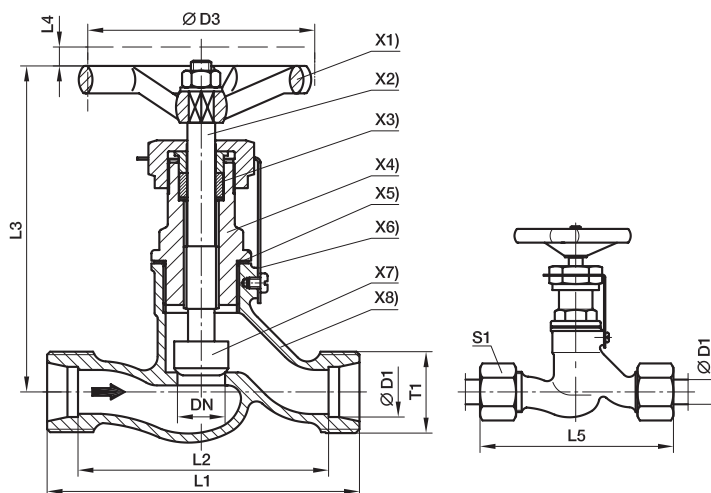

- X1) **Hand wheel:** Plastic material typ 74 according to DIN 388 Form C
- X2) **Spindle:** with internal thread. Material: Cu Zn 35 Ni 2
- X3) **Stuffing box packing:** Graphite
- X4) **Head piece:** material: Cu Zn 39 Pb 3
- X5) **Sealing:** Copper ring
- X6) **Locking plates:** material: St. 37/zinc plated
- X7) **Valve cone:** loose tip material: Cu Zn 35 Ni 2
- X8) **Casing:** material: G-Cu Sn 5Zn Pb (Rg 5 according to DIN 1705)

EO-tube connection:

for **copper** tubes nuts, cutting and locking rings of brass

Attention:

for **steel** tubes: nuts, progressive rings of steel **specify when ordering**
We recommend pre-installation in hardened pre-installation body (see assembly instructions)

| Series | D1 | T1 | DN | D3 | L1 | L2 | L3 | L4 | L5 | S1 | Weight g/1 piece | Order code* | PN (bar) ¹⁾ without surface |
|-----------------|----|----------|----|-----|-----|-----|-----|----|-----|----|------------------|---------------|--|
| S ⁴⁾ | 10 | M 18×1.5 | 6 | 63 | 60 | 45 | 98 | 7 | 77 | 22 | 383 | LD10SX | 40 |
| | 12 | M 20×1.5 | 8 | 63 | 64 | 49 | 98 | 7 | 81 | 24 | 401 | LD12SX | 40 |
| | 14 | M 22×1.5 | 10 | 63 | 70 | 54 | 98 | 7 | 89 | 27 | 417 | LD14SX | 40 |
| | 16 | M 24×1.5 | 12 | 80 | 84 | 67 | 110 | 9 | 103 | 30 | 631 | LD16SX | 40 |
| | 20 | M 30×2.0 | 16 | 80 | 90 | 69 | 110 | 9 | 112 | 36 | 688 | LD20SX | 40 |
| | 25 | M 36×2.0 | 20 | 100 | 110 | 86 | 129 | 12 | 134 | 46 | 1191 | LD25SX | 40 |
| | 30 | M 42×2.0 | 25 | 100 | 120 | 93 | 129 | 12 | 146 | 50 | 1322 | LD30SX | 40 |
| | 38 | M 52×2.0 | 32 | 100 | 140 | 108 | 158 | 12 | 169 | 60 | 2268 | LD38SX | 40 |

¹⁾ Pressure shown = item deliverable

⁴⁾ S = heavy series

$$\frac{PN \text{ (bar)}}{10} = PN \text{ (MPa)}$$

Delivery without nut and ring. Information on ordering complete fittings or alternative sealing materials see page 17.

*Please add the **suffixes** below according to the material/ surface required.

| Order code suffixes | | | |
|------------------------|-----------------------------|---------|---|
| Material | Suffix surface and material | Example | Standard sealing material (no additional suffix needed) |
| Gunmetal (Rg 5) 2.1096 | without | LD10SX | Graphit / Metal |



Shut off valves

VDHA High pressure valve

EO tube end / EO tube end

with internal threaded spindle and body of low grade forged stainless steel
 The pressure specification PN for hand-operated shut-off valves applies to the design factor 1,5 (according DIN 3230 T5 and ISO 5208).

Caution!

Please note the admissible pressure ratings for the EO-tube ends.

Temperatures up to 400°C according to tube material (consider pressure drop with temperatures above 50°C)

Required pressure reductions

| temperature | 50°C | 100°C | 200°C | 300°C | 400°C |
|---------------------|------|-------|-------|-------|-------|
| pressure reductions | 6% | 15% | 37% | 60% | 84% |

Intermediate values are to be interpolated.

Applications:

For water, steam, hot and cold oils (not for gases, oxygen etc.) on mineral oil based grease.
 For compressed air up to 50°C. For corrosive media, acids, fire resistant fluid etc.

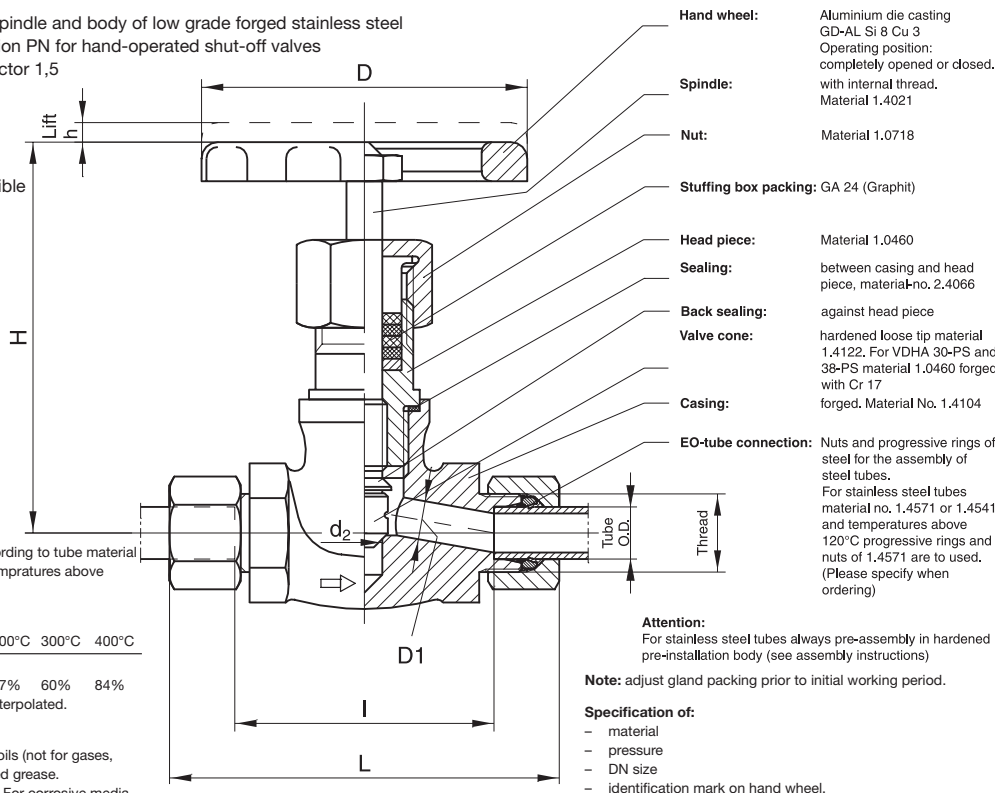

| Series | D1 | PN (bar) | DN | Thread | d2 | H | L | I | h | D | Weight g/1 piece | With Nut and Ring | |
|-----------------|----|----------|----|----------|------|-----|-----|-----|----|-----|------------------|---------------------|-----------|
| | | | | | | | | | | | | Dry Technology EO-2 | PSR steel |
| S ⁴⁾ | 06 | 630 | 4 | M 14×1.5 | 9.5 | 120 | 95 | 66 | 6 | 100 | 891 | VDHA06ZS | VDHA06S |
| | 08 | 630 | 5 | M 16×1.5 | 9.5 | 120 | 95 | 66 | 6 | 100 | 917 | VDHA08ZS | VDHA08S |
| | 10 | 630 | 7 | M 18×1.5 | 9.5 | 120 | 97 | 65 | 6 | 100 | 937 | VDHA10ZS | VDHA10S |
| | 12 | 630 | 8 | M 20×1.5 | 9.5 | 120 | 97 | 65 | 6 | 100 | 940 | VDHA12ZS | VDHA12S |
| | 14 | 630 | 10 | M 22×1.5 | 9.5 | 120 | 119 | 84 | 6 | 100 | 1194 | VDHA14ZS | VDHA14S |
| | 16 | 400 | 11 | M 24×1.5 | 9.5 | 120 | 119 | 83 | 6 | 100 | 1209 | VDHA16ZS | VDHA16S |
| | 20 | 400 | 13 | M 30×2.0 | 11.0 | 120 | 122 | 79 | 6 | 100 | 1292 | VDHA20ZS | VDHA20S |
| | 25 | 400 | 17 | M 36×2.0 | 12.0 | 143 | 154 | 106 | 9 | 125 | 2013 | VDHA25ZS | VDHA25S |
| | 30 | 250 | 19 | M 42×2.0 | 22.5 | 164 | 156 | 103 | 12 | 125 | 2596 | VDHA30ZS | VDHA30S |
| | 38 | 250 | 25 | M 52×2.0 | 26.5 | 198 | 179 | 118 | 12 | 180 | 4972 | VDHA38ZS | VDHA38S |

¹⁾ Pressure shown = item deliverable

⁴⁾ S = heavy series

$$\frac{PN \text{ (bar)}}{10} = PN \text{ (MPa)}$$



WV Alternating valve

EO 24° cone end / EO 24° cone end / EQ 24° cone end

These valves permit the passage of flow from either inlet 1 or 2 to the outlet port whilst shutting of the inlet port not in use. The shutting off, of an inlet is achieved by a floating ball bearing which moves by the pressure of the flow.

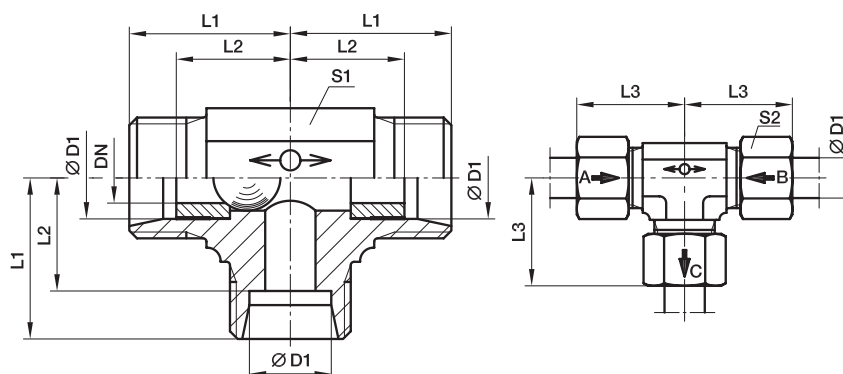

Material: steel
Surface finish: Cr(VI)-free.

Valves are not recommended for compressed air and gases.
WV-valves are not to be used in connection with weld nipples, swivel nuts etc. where there is no contact with a shoulder stop in the inner cone.

Temperature range without pressure reductions: -40°C up to +120°C.

Recommended fitting position as shown in the picture.

Leakage rate for alternating valves hydraulic test
with test pressure = P_{max} : approx. 20 drops (test period of 1 minute).

Directions of flow:

$D_1 \rightarrow D_3 = D_2$ closed
 $D_2 \rightarrow D_3 = D_1$ closed

| Series | D1 | T1 | DN | L1 | L2 | L3 | S1 | S2 | Weight g/1 piece | Order code* | PN (bar) ¹⁾ CF |
|-----------------|----|----------|------|----|----|----|----|----|---------------------|-----------------|---------------------------------|
| L ³⁾ | 8 | M 14x1.5 | 4.5 | 21 | 14 | 29 | 14 | 17 | 53 | WV08LOMD | 160 |
| | 10 | M 16x1.5 | 6.0 | 22 | 15 | 30 | 17 | 19 | 73 | WV10LOMD | 160 |
| | 12 | M 18x1.5 | 7.5 | 24 | 17 | 32 | 19 | 22 | 96 | WV12LOMD | 160 |
| | 15 | M 22x1.5 | 10.0 | 28 | 21 | 36 | 19 | 27 | 134 | WV15LOMD | 160 |

¹⁾Pressure shown = item deliverable

³⁾L = light series

$\frac{PN \text{ (bar)}}{10} = PN \text{ (MPa)}$

Delivery without nut and ring. Information on ordering complete fittings or alternative sealing materials see page 17.

P

*Please add the **suffixes**
below according to the material/
surface required.

| Order code suffixes | | | |
|---------------------------------|-----------------------------------|------------|--|
| Material | Suffix surface and material | Example | Standard sealing material (no additional suffix needed) |
| Steel, zinc plated, Cr(VI)-free | CF | WV08LOMDCF | Steel ball |

Valves

ELA air-bleed valves

Hydraulic systems can effectively be bled with ELA air-bleed valves.

Easily installed – maintenance-free – almost unlimited service life – simple – safe – reliable – efficient.
The system can be operated immediately. No control irregularities due to air contamination of the pressure medium.
Cost saving, as non-productive de-aeration time is saved.

Air bleed between: – opening pressure 0.05 bar
– closing pressure ≥ 0.5 bar

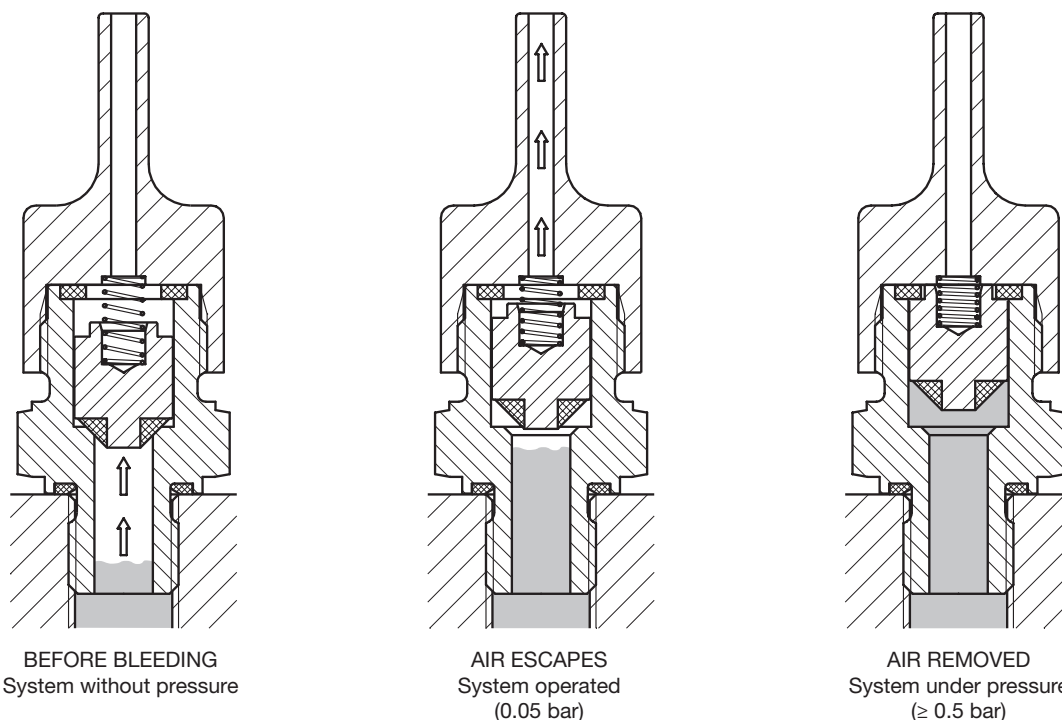

The principle of the air-bleed valve is based on the difference in behaviour of gases and liquids under pressure because of their dependence on viscosity. A piston, housed in the bore of the body with defined clearance, effects the opening and closing of the valve on start-up or shut-down of the system. On setting the system in operation, the accumulated air escapes until the liquid column of the pressure medium reaches the piston. The pressure of the liquid lifts the piston against the upper, high pressure seal, securely closing the air-vent (slight oil discharge may occur). When pressure is released the spring releases the piston reopening the air-vent, whereupon the procedure may be repeated. The special piston design prevents any intake of air in case of partial vacuum.

The air bleed valve should be connected vertical, at the highest point of the hydraulic system or in places where air accumulation may occur.

ELA air-bleed valves are available only for mineral oil based fluids, and within the temperature limits of -20°C to $+90^{\circ}\text{C}$.



ELA Air-bleed valves

Male BSPP thread with Eolastic seal

| PN (bar) | Dry Technology Steel | Weight g/1 piece |
|-------------|-------------------------|---------------------|
| 400 | ELA1/4EDCF | 109 |

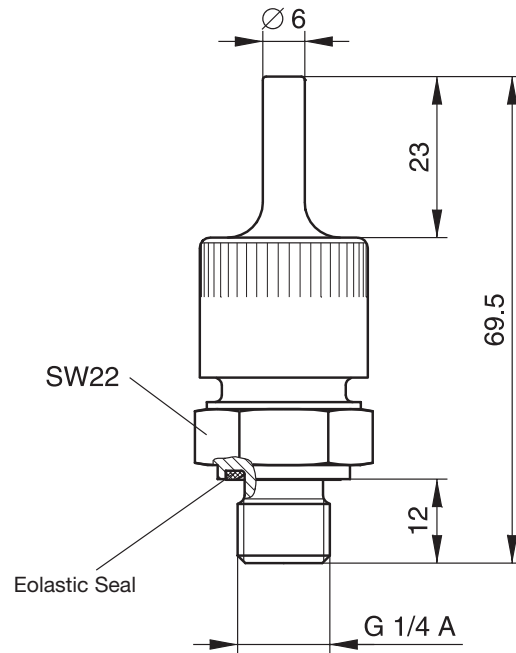

EO Swivel

| PN (bar) | Dry Technology Steel | Weight g/1 piece |
|-------------|-------------------------|---------------------|
| 315 | ELAE10LCF | 125 |

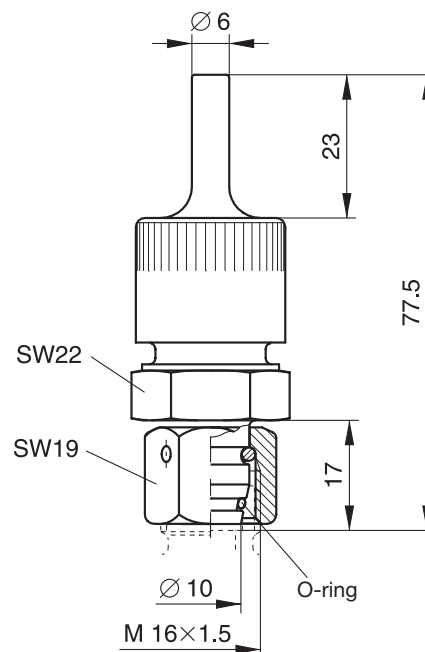

P



Ermeto Original *Rotary fittings*





Rotary fittings

Visual index EO rotary fittings

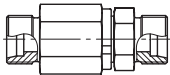
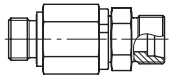
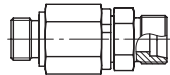
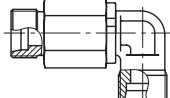
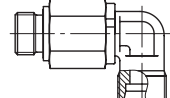
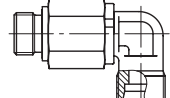
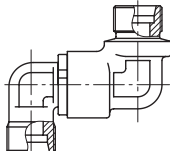
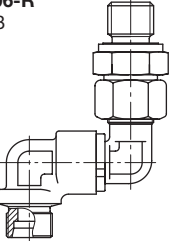
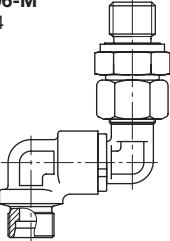
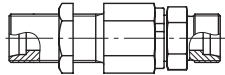
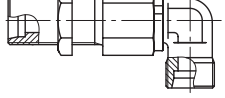
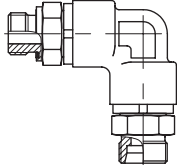
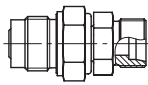
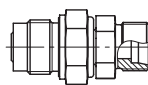
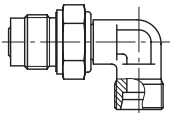
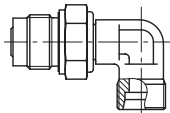
| | | |
|---|---|---|
| <p>DG 101 p. Q6</p>  <p>EO 24° cone end / EO 24° cone end</p> | <p>DG 102-R p. Q7</p>  <p>Male BSPP thread – ED-seal (ISO 1179) / EO 24° cone end</p> | <p>DG 102-M p. Q8</p>  <p>Male metric thread – ED-seal (ISO 1179) / EO 24° cone end</p> |
| <p>DG 103 p. Q9</p>  <p>EO 24° cone end / EO 24° cone end</p> | <p>DG 104-R p. Q10</p>  <p>Male BSPP thread – ED-seal (ISO 1179) / EO 24° cone end</p> | <p>DG 104-M p. Q11</p>  <p>Male metric thread – ED-seal (ISO 1179) / EO 24° cone end</p> |
| <p>DG 105 p. Q12</p>  <p>EO 24° cone end / EO 24° cone end</p> | <p>DG 106-R p. Q13</p>  <p>Male BSPP thread – ED-seal (ISO 1179) / EO 24° cone end</p> | <p>DG 106-M p. Q14</p>  <p>Male metric thread – ED-seal (ISO 1179) / EO 24° cone end</p> |
| <p>DG 107 p. Q15</p>  <p>EO 24° cone end / EO 24° cone end</p> | <p>DG 108 p. Q16</p>  <p>EO 24° cone end / EO 24° cone end</p> | <p>DG 208 p. Q17</p>  <p>Male BSPP thread – ED-seal (ISO 1179) / EO 24° cone end</p> |
| <p>DVGE-R p. Q18</p>  <p>Male BSPP thread – ED-seal / EO 24° cone end</p> | <p>DVGE-M p. Q19</p>  <p>Male metric thread – ED-seal / EO 24° cone end</p> | |
| <p>DVWE-R p. Q20</p>  <p>Male BSPP thread – ED-seal / EO 24° cone end</p> | <p>DVWE-M p. Q21</p>  <p>Male metric thread – ED-seal / EO 24° cone end</p> | |



DG Ball bearing rotary fittings

For working pressures up to 420 bar.
Favourable pressure/RPM ratio

Application:

Connecting a fixed point to a rotating, swinging or moving machine part via hoses.
To prevent torsion and to avoid small hose radius.

Flow media:

Hydraulic oils and lubricants on mineral oil base.
Also for hydraulic fluids HETG and HEES.
Not suitable for corrosive and HFC-fluids or gases.

Construction:

Compact, maintenance-free construction, service-proved. Combined ball and plain bearing with constant lubrication. Low starting torque. Wear-resistant annular piston sealings.

Materials:

Casing, body nut of steel, annular piston sealing: POM (e. g. Delrin)/FKM. Elastic sealing: NBR (e.g. Perbunan), also available in FKM.

Surface:

Cr(VI)-free.

Nominal temperatures:

-40° C up to +95°C.

Warehousing:

Ball bearing rotary fittings can be stocked for 6 months. Warehousing up to 1 year is possible with storage conditions acc. to DIN 7716.

Perbunan = registered trademark of Bayer

Construction systems:

8 different versions with one rotational axis. Multiaxial rotary couplings on request. Tube connections according to DIN 2353, series S.
Maximum working pressure 420 bar (peak pressure)
Male stud sealing by Eolastic seals of NBR.
Male stud with metric parallel or BSPP thread.

Assembly instructions:

The life of a rotary fitting depends considerably on a stress-free line connection. Therefore the direct connection with tubes is to be avoided.
For connection of hoses the use of swivel nut fittings (DIN 3865) is recommended.
We recommend short, straight hose lines (free hose length approx. 5× hose O.D.). Thus shocks, vibrations etc. are absorbed.

Attention!

Maximum permissible flowrate of media: 8 m/s.

Number of revolutions and starting torques:

Chart 1

| Tube O.D. | DN Nominal diameter (mm) | Permissible number of revolutions (rpm.) under a working pressure of | | | | | | | Initial torque at 250 bar/Nm |
|-----------|--------------------------|--|--------|---------|---------|---------|---------|---------|------------------------------|
| | | 25 bar | 64 bar | 100 bar | 160 bar | 250 bar | 350 bar | 420 bar | |
| 6 8 | 5.0 | 1.600 | 800 | 400 | 200 | 150 | 90 | 90 | max. 0.5 |
| 12 16 | 9.5 | 1.000 | 600 | 300 | 180 | 120 | 90 | 90 | max. 3.0 |
| 20 25 | 16.0 | 500 | 250 | 120 | 60 | 40 | 20 | 20 | max. 3.5 |
| 30 38 | 26.0 | 300 | 150 | 100 | 50 | 20 | 10 | 10 | max. 5.0 |



Rotary fittings

DG Ball bearing rotary fittings

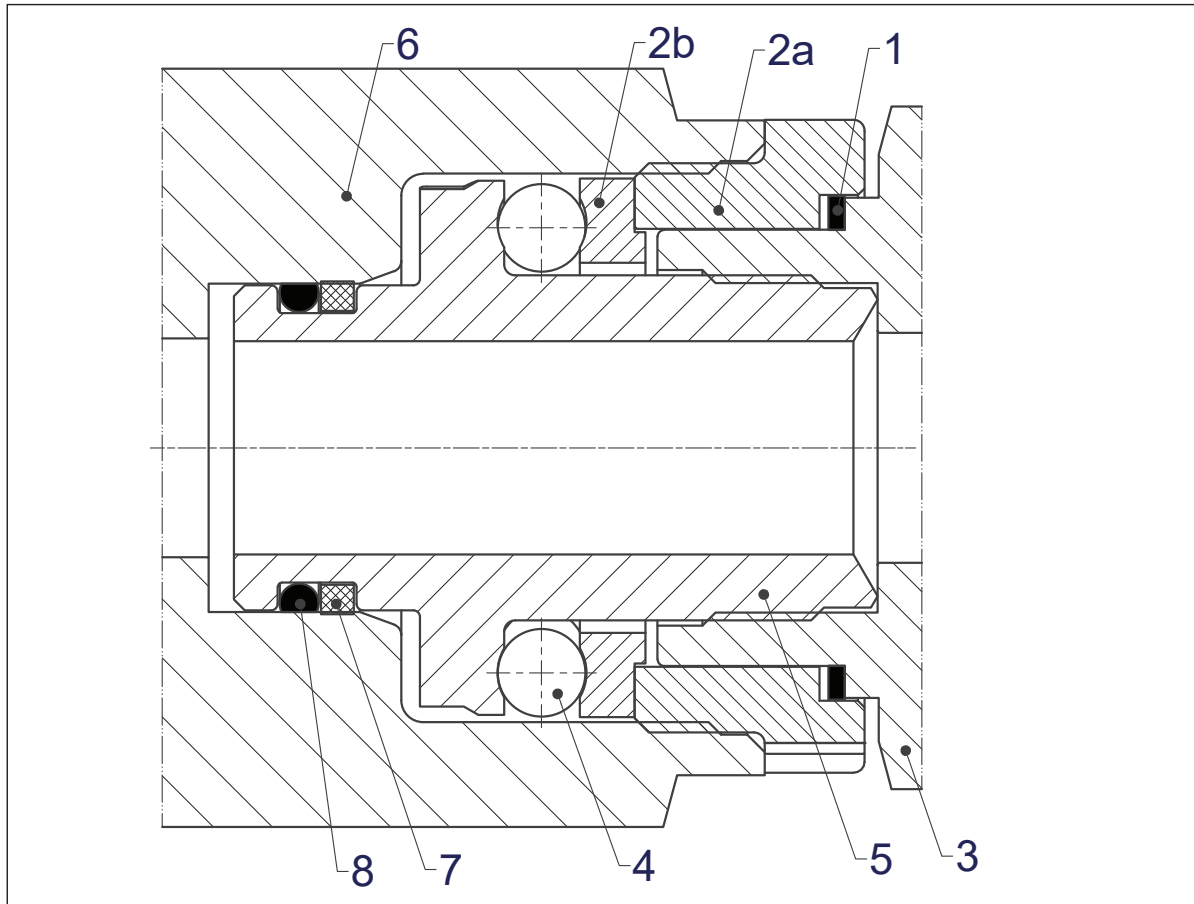

| | |
|----------|---------------|
| 8 | Sealing ring |
| 7 | Back-up ring |
| 6 | Lower part |
| 5 | Pivot |
| 4 | Ball |
| 3 | Upper part |
| 2b | Ball race 2 |
| 2a | Ball race 1 |
| 1 | dust seal |
| position | specification |



Plain bearing rotary fittings

for slow rotating, swinging or moving machine parts up to 40 bar (series L) or up to 100 bar (series S).

Application:

Connecting a fixed point to a rotating, swinging or moving machine part via hoses.
To prevent torsion and to avoid small hose radius.

Flow media:

Hydraulic oils and lubricants on mineral oil base.
Also for hydraulic fluids HETG and HEES.
Not suitable for corrosive and HFC-fluids or gases.

Nominal temperature:

For sealings of NBR:
-35° C up to +100° C.
For sealings of FKM:
-25° C up to +120° C.

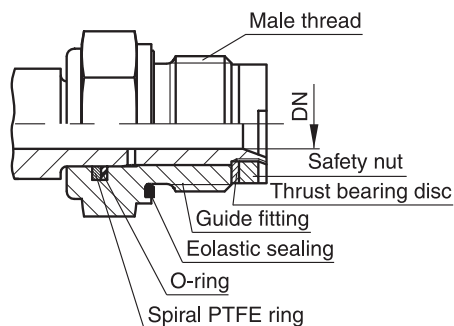

| Tube O.D. | | DN Nominal diameter mm |
|-----------|---------|------------------------------|
| 06L | 06S | 4 |
| 08L | 08S | 5 |
| 10L | 10S | 6 |
| 12L | 12S | 8 |
| 15L | 14S 16S | 10 |
| 18L 22L | 20S 25S | 16 |
| 28L | 30S | 22 |
| 35L | 43L 38S | 25 |

Construction:

Compact, maintenance-free construction, service-proved.

Materials:

Casing, body nut and progressive ring of steel. Sealing of NBR (Perbunan), on request of FKM.
Plain bearing rotary fittings are not available in stainless steel or brass.

Surface:

Cr(VI)-free.

Construction-system:

Series L, tube O. D. 6 to 35 mm, working pressure (PN): 40 bar
Series S, tube O. D. 6 to 38 mm, working pressure (PN): 100 bar
Tube connection according to DIN 2353, ISO 8434-1.
Male stud with metric thread and BSP thread.
Sealing of male stud by Eolastic-seals.

Perbunan = registered trademark of Bayer

Number of revolutions:

| Series | L | | | | | | | | | |
|------------------|----|----|----|----|----|----|----|----|----|----|
| Tube O.D. | 6 | 8 | 10 | 12 | 15 | 18 | 22 | 28 | 35 | |
| Permiss. no. rpm | 28 | 28 | 21 | 17 | 13 | 10 | 10 | 7 | 7 | |
| Series | S | | | | | | | | | |
| Tube O.D. | 6 | 8 | 10 | 12 | 14 | 16 | 20 | 25 | 30 | 38 |
| Permiss. no rpm | 11 | 11 | 9 | 7 | 5 | 5 | 4 | 4 | 3 | 3 |

Assembly instruction:

The life of a rotary fitting depends considerably on a stress-free line connection. Therefore the direct connection with tubes is to be avoided.

For connection of hoses use of swivel nut connections (DIN 3865) is recommended.

We recommend short, straight hose lines (free hose length approx. 5x hose O. D.). Thus shocks, vibrations etc. are absorbed.



Rotary fittings

DG 101 Straight ball bearing rotary union

EO 24° cone end / EO 24° cone end

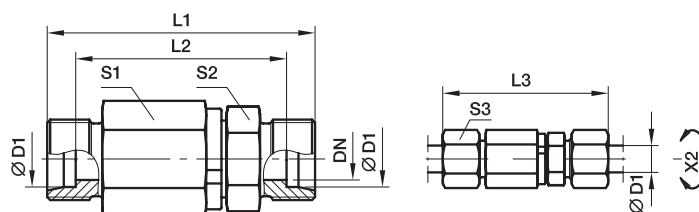

X2) Axis

| Series | D1 | DN | L1 | L2 | L3 | S1 | S2 | S3 | Weight g/1 piece | Order code* | PN (bar) ¹⁾ |
|-----------------|--------|------|-----|----|-----|----|----|----|---------------------|-----------------------|---------------------------|
| S ⁴⁾ | 06 | 5.0 | 61 | 47 | 76 | 22 | 17 | 17 | 113 | DG101/06SHDOMD | 420 |
| | 08 | 5.0 | 61 | 47 | 76 | 22 | 17 | 19 | 118 | DG101/08SHDOMD | 420 |
| | 12 | 9.5 | 72 | 57 | 89 | 30 | 24 | 24 | 258 | DG101/12SHDOMD | 420 |
| | 16 | 9.5 | 74 | 57 | 93 | 30 | 27 | 30 | 264 | DG101/16SHDOMD | 420 |
| | 20 | 16.0 | 92 | 71 | 114 | 41 | 36 | 36 | 578 | DG101/20HDSOMD | 420 |
| | 25 | 16.0 | 96 | 72 | 120 | 41 | 41 | 46 | 652 | DG101/25SHDOMD | 420 |
| | 30 | 26.0 | 109 | 82 | 135 | 60 | 46 | 50 | 1321 | DG101/30SHDOMD | 420 |
| | 38 | 26.0 | 104 | 82 | 143 | 60 | 55 | 60 | 1509 | DG101/38SHDOMD | 420 |

¹⁾Pressure shown = item deliverable

⁴⁾S = heavy series

 $\frac{\text{PN (bar)}}{10} = \text{PN (MPa)}$
Delivery without nut and ring. Information on ordering complete fittings or alternative sealing materials see page I7.

*Please add the **suffixes** below according to the material/surface required.

| Order code suffixes | | | |
|---------------------------------|-----------------------------|----------------|---|
| Material | Suffix surface and material | Example | Standard sealing material (no additional suffix needed) |
| Steel, zinc plated, Cr(VI)-free | CF | DG101/06SOMDCF | VIT |



DG 102-R Straight male stud ball bearing rotary union

Male BSPP thread – ED-seal (ISO 1179) / EO 24° cone end

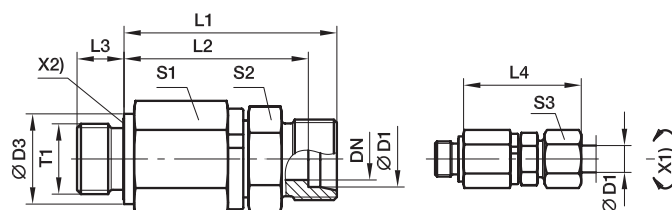

X1) Axis
X2) Eolastic-sealing

| Series | D1 | T1 | DN | D3 | L1 | L2 | L3 | L4 | S1 | S2 | S3 | Weight g/1 piece | Order code* | PN (bar) ¹⁾ |
|-----------------|-----------|-----------|------|----|------|------|-------|-------|----|----|------|------------------------|------------------------|---------------------------|
| S ⁴⁾ | 06 | G 1/4 A | 5.0 | 19 | 49 | 42.0 | 12 | 57.0 | 22 | 17 | 17 | 110 | DG102/06SRHDOMD | 420 |
| | 08 | G 1/4 A | 5.0 | 19 | 49 | 42.0 | 12 | 57.0 | 22 | 17 | 19 | 116 | DG102/08SRHDOMD | 420 |
| | 12 | G 3/8 A | 9.5 | 24 | 60 | 52.5 | 12 | 69.0 | 30 | 24 | 24 | 243 | DG102/12SRHDOMD | 420 |
| | 16 | G 1/2 A | 9.5 | 27 | 60 | 51.5 | 14 | 70.0 | 30 | 27 | 30 | 256 | DG102/16SRHDOMD | 420 |
| | 20 | G 3/4 A | 16.0 | 32 | 76 | 65.5 | 16 | 87.5 | 41 | 36 | 36 | 558 | DG102/20SRHDOMD | 420 |
| | 25 | G 1 A | 16.0 | 40 | 78 | 66.0 | 18 | 90.5 | 41 | 41 | 46 | 853 | DG102/25SRHDOMD | 420 |
| | 30 | G 1 1/4 A | 26.0 | 50 | 89 | 75.5 | 20 | 102.0 | 60 | 46 | 50 | 1312 | DG102/30SRHDOMD | 420 |
| 38 | G 1 1/2 A | 26.0 | 55 | 92 | 76.0 | 22 | 107.0 | 60 | 55 | 60 | 1494 | DG102/38SRHDOMD | 420 | |

¹⁾ Pressure shown = item deliverable

⁴⁾ S = heavy series

$\frac{PN \text{ (bar)}}{10} = PN \text{ (MPa)}$

Delivery without nut and ring. Information on ordering complete fittings or alternative sealing materials see page 17.



*Please add the **suffixes** below according to the material/surface required.

| Order code suffixes | | | |
|---------------------------------|-----------------------------|----------------|---|
| Material | Suffix surface and material | Example | Standard sealing material (no additional suffix needed) |
| Steel, zinc plated, Cr(VI)-free | CF | DG102/06SRMDCF | VIT/NBR |

Rotary fittings

DG 102-M Straight male stud ball bearing rotary union

Male metric thread – ED-seal (ISO 9974) / EO 24° cone end

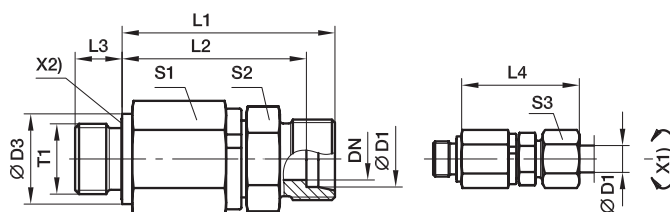
 X1) Axis
 X2) Eolastic-sealing

| Series | D1 | T1 | DN | D3 | L1 | L2 | L3 | L4 | S1 | S2 | S3 | Weight g/1 piece | Order code* | PN (bar) ¹⁾ |
|-----------------|----|----------|------|----|----|------|----|-------|----|----|----|---------------------|-----------------|---------------------------|
| S ⁴⁾ | 06 | M 14×1.5 | 5.0 | 19 | 49 | 42.0 | 12 | 57.0 | 22 | 17 | 17 | 110 | DG102/06SMHDOMD | 420 |
| | 08 | M 14×1.5 | 5.0 | 19 | 49 | 42.0 | 12 | 57.0 | 22 | 17 | 19 | 116 | DG102/08SMHDOMD | 420 |
| | 12 | M 18×1.5 | 9.5 | 24 | 60 | 52.5 | 12 | 69.0 | 30 | 24 | 24 | 243 | DG102/12SMHDOMD | 420 |
| | 16 | M 22×1.5 | 9.5 | 27 | 60 | 51.5 | 14 | 70.0 | 30 | 27 | 30 | 256 | DG102/16SMHDOMD | 420 |
| | 20 | M 27×2.0 | 16.0 | 32 | 76 | 65.5 | 16 | 87.5 | 41 | 36 | 36 | 558 | DG102/20SMHDOMD | 420 |
| | 25 | M 33×2.0 | 16.0 | 40 | 78 | 66.0 | 18 | 90.5 | 41 | 41 | 46 | 853 | DG102/25SMHDOMD | 420 |
| | 30 | M 42×2.0 | 26.0 | 50 | 89 | 75.5 | 20 | 102.0 | 60 | 46 | 50 | 1312 | DG102/30SMHDOMD | 420 |
| | 38 | M 48×2.0 | 26.0 | 55 | 92 | 76.0 | 22 | 107.0 | 60 | 55 | 60 | 1494 | DG102/38SMHDOMD | 420 |

¹⁾Pressure shown = item deliverable

⁴⁾S = heavy series

 $\frac{PN \text{ (bar)}}{10} = PN \text{ (MPa)}$
Delivery without nut and ring. Information on ordering complete fittings or alternative sealing materials see page 17.

 *Please add the **suffixes**
 below according to the material/
 surface required.

| Order code suffixes | | | |
|---------------------------------|-----------------------------------|-----------------|---|
| Material | Suffix surface and material | Example | Standard sealing material (no additional suffix needed) |
| Steel, zinc plated, Cr(VI)-free | CF | DG102/06SMOMDCF | VIT/NBR |



DG 103 Elbow ball bearing rotary union

EO 24° cone end / EO 24° cone end

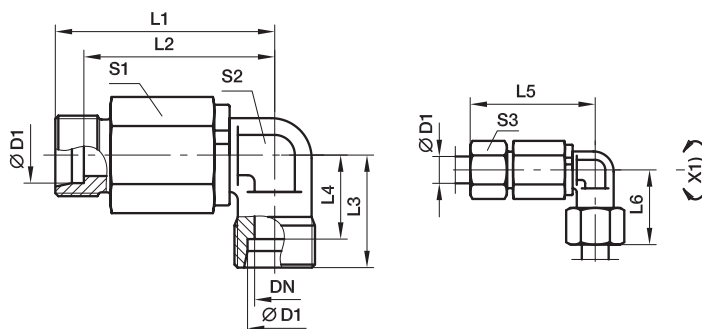

X2) Axis

| Series | D1 | DN | L1 | L2 | L3 | L4 | L5 | L6 | S1 | S2 | S3 | Weight g/1 piece | Order code* | PN (bar) ¹⁾ |
|-----------------|--------|-------|-------|------|------|------|------|------|----|----|------|---------------------|----------------|---------------------------|
| S ⁴⁾ | 06 | 5.0 | 51.5 | 59.0 | 23 | 16.0 | 44.5 | 16.0 | 22 | 17 | 17 | 134 | DG103/06SHDOMD | 420 |
| | 08 | 5.0 | 51.5 | 59.0 | 24 | 17.0 | 44.5 | 17.0 | 22 | 17 | 19 | 141 | DG103/08SHDOMD | 420 |
| | 12 | 9.5 | 63.0 | 72.0 | 29 | 21.5 | 55.5 | 21.5 | 30 | 22 | 24 | 296 | DG103/12SHDOMD | 420 |
| | 16 | 9.5 | 63.0 | 73.0 | 33 | 24.5 | 54.5 | 24.5 | 30 | 22 | 30 | 298 | DG103/16SHDOMD | 420 |
| | 20 | 16.0 | 83.0 | 94.5 | 37 | 26.5 | 72.5 | 26.5 | 41 | 36 | 36 | 772 | DG103/20SHDOMD | 420 |
| 25 | 16.0 | 83.0 | 95.5 | 42 | 30.0 | 71.0 | 30.0 | 41 | 36 | 46 | 803 | DG103/25SHDOMD | 420 | |
| 30 | 26.0 | 102.5 | 116.0 | 49 | 35.5 | 89.0 | 35.5 | 60 | 50 | 50 | 1722 | DG103/30SHDOMD | 420 | |
| 38 | 26.0 | 102.5 | 117.0 | 57 | 41.0 | 86.5 | 41.0 | 60 | 50 | 60 | 1931 | DG103/38SHDOMD | 420 | |

¹⁾ Pressure shown = item deliverable

⁴⁾ S = heavy series

$\frac{PN \text{ (bar)}}{10} = PN \text{ (MPa)}$

Delivery without nut and ring. Information on ordering complete fittings or alternative sealing materials see page 17.



*Please add the **suffixes** below according to the material/ surface required.

| Order code suffixes | | | |
|---------------------------------|-----------------------------|----------------|---|
| Material | Suffix surface and material | Example | Standard sealing material (no additional suffix needed) |
| Steel, zinc plated, Cr(VI)-free | CF | DG103/06SOMDCF | VIT |



Rotary fittings

DG 104-R Elbow male stud ball bearing rotary union

Male BSPP thread – ED-seal (ISO 1179) / EO 24° cone end

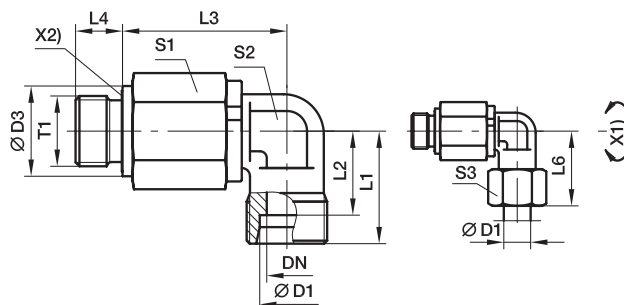
 X1) Axis
 X2) Elastoc-sealing

| Series | D1 | T1 | DN | D3 | L1 | L2 | L3 | L4 | L6 | S1 | S2 | S3 | Weight g/1 piece | Order code* | PN (bar) ¹⁾ |
|-----------------|----|-----------|------|----|----|------|------|----|----|----|----|----|---------------------|-----------------|---------------------------|
| S ⁴⁾ | 06 | G 1/4 A | 5.0 | 19 | 23 | 16.0 | 39.5 | 12 | 31 | 22 | 17 | 17 | 131 | DG104/06SRHDOMD | 420 |
| | 08 | G 1/4 A | 5.0 | 19 | 24 | 17.0 | 39.5 | 12 | 32 | 22 | 17 | 19 | 135 | DG104/08SRHDOMD | 420 |
| | 12 | G 3/8 A | 9.5 | 22 | 29 | 21.5 | 51.0 | 12 | 38 | 30 | 22 | 24 | 284 | DG104/12SRHDOMD | 420 |
| | 16 | G 1/2 A | 9.5 | 27 | 33 | 24.5 | 49.0 | 14 | 43 | 30 | 22 | 30 | 284 | DG104/16SRHDOMD | 420 |
| | 20 | G 3/4 A | 16.0 | 32 | 37 | 26.5 | 67.0 | 16 | 48 | 41 | 36 | 36 | 752 | DG104/20SRHDOMD | 420 |
| | 25 | G 1 A | 16.0 | 40 | 42 | 30.0 | 65.0 | 18 | 54 | 41 | 36 | 46 | 789 | DG104/25SRHDOMD | 420 |
| | 30 | G 1 1/4 A | 26.0 | 50 | 49 | 35.5 | 82.5 | 20 | 62 | 60 | 50 | 50 | 1713 | DG104/30SRHDOMD | 420 |
| | 38 | G 1 1/2 A | 26.0 | 55 | 57 | 41.0 | 80.5 | 22 | 72 | 60 | 50 | 60 | 1915 | DG104/38SRHDOMD | 420 |

¹⁾ Pressure shown = item deliverable

⁴⁾ S = heavy series

 $\frac{\text{PN (bar)}}{10} = \text{PN (MPa)}$

Delivery without nut and ring. Information on ordering complete fittings or alternative sealing materials see page 17.

 *Please add the **suffixes** below according to the material/surface required.

| Order code suffixes | | | |
|---------------------------------|-----------------------------|------------------|---|
| Material | Suffix surface and material | Example | Standard sealing material (no additional suffix needed) |
| Steel, zinc plated, Cr(VI)-free | CF | DG104/06SRHOMDCF | VIT/NBR |



DG 104-M Elbow male stud ball bearing rotary union

Male metric thread – ED-seal (ISO 9974) / EO 24° cone end

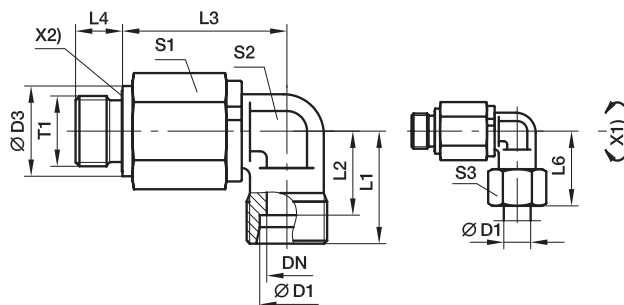

X1) Axis
X2) Eolastic-sealing

| Series | D1 | T1 | DN | D3 | L1 | L2 | L3 | L4 | L6 | S1 | S2 | S3 | Weight g/1 piece | Order code* | PN (bar) ¹⁾ |
|-----------------|----|----------|------|----|----|------|------|----|----|----|----|----|---------------------|-----------------|---------------------------|
| S ⁴⁾ | 06 | M 14×1.5 | 5.0 | 19 | 23 | 16.0 | 39.5 | 12 | 31 | 22 | 17 | 17 | 132 | DG104/06SMHDOMD | 420 |
| | 08 | M 14×1.5 | 5.0 | 19 | 24 | 17.0 | 39.5 | 12 | 32 | 22 | 17 | 19 | 136 | DG104/08SMHDOMD | 420 |
| | 12 | M 18×1.5 | 9.5 | 22 | 29 | 21.5 | 51.0 | 12 | 38 | 30 | 22 | 24 | 286 | DG104/12SMHDOMD | 420 |
| | 16 | M 22×1.5 | 9.5 | 27 | 33 | 24.5 | 49.0 | 14 | 43 | 30 | 22 | 30 | 287 | DG104/16SMHDOMD | 420 |
| | 20 | M 27×2.0 | 16.0 | 32 | 37 | 26.5 | 67.0 | 16 | 48 | 41 | 36 | 36 | 752 | DG104/20SMHDOMD | 420 |
| | 25 | M 33×2.0 | 16.0 | 40 | 42 | 30.0 | 65.0 | 18 | 54 | 41 | 36 | 46 | 788 | DG104/25SMHDOMD | 420 |
| | 30 | M 42×2.0 | 26.0 | 50 | 49 | 35.5 | 82.5 | 20 | 62 | 60 | 50 | 50 | 1717 | DG104/30SMHDOMD | 420 |
| | 38 | M 48×2.0 | 26.0 | 55 | 57 | 41.0 | 80.5 | 22 | 72 | 60 | 50 | 60 | 1913 | DG104/38SMHDOMD | 420 |

¹⁾ Pressure shown = item deliverable

⁴⁾ S = heavy series

$\frac{PN \text{ (bar)}}{10} = PN \text{ (MPa)}$

Delivery without nut and ring. Information on ordering complete fittings or alternative sealing materials see page 17.



*Please add the **suffixes** below according to the material/ surface required.

| Order code suffixes | | | |
|---------------------------------|-----------------------------|-----------------|---|
| Material | Suffix surface and material | Example | Standard sealing material (no additional suffix needed) |
| Steel, zinc plated, Cr(VI)-free | CF | DG104/06SMOMDCF | VIT/NBR |

Rotary fittings

DG 105 Double elbow ball bearing rotary union

EO 24° cone end / EO 24° cone end

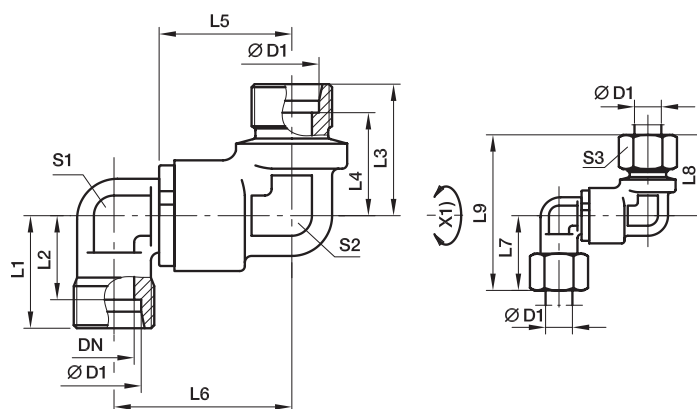

X1) Axis

| Series | D1 | DN | L1 | L2 | L3 | L4 | L5 | L6 | L7 | L8 | L9 | S1 | S2 | S3 | Weight g/1 piece | Order code* | PN (bar) ¹⁾ |
|-----------------|----|------|------|------|----|------|----|-----|------|----|----|----|----|------|---------------------|-----------------------|---------------------------|
| S ⁴⁾ | 12 | 9.5 | 39.5 | 26.5 | 43 | 21.5 | 38 | 81 | 53.0 | 24 | 22 | 24 | 29 | 50.5 | 384 | DG105/12SHDOMD | 420 |
| | 16 | 9.5 | 39.5 | 25.5 | 44 | 24.5 | 43 | 87 | 53.0 | 30 | 22 | 24 | 33 | 52.5 | 377 | DG105/16SHDOMD | 420 |
| | 20 | 16.0 | 56.5 | 39.5 | 61 | 26.5 | 48 | 109 | 76.0 | 36 | 36 | 32 | 37 | 71.5 | 1015 | DG105/20SHDOMD | 420 |
| | 25 | 16.0 | 56.5 | 38.0 | 62 | 30.0 | 54 | 116 | 76.0 | 46 | 36 | 32 | 42 | 74.0 | 1034 | DG105/25SHDOMD | 420 |
| | 30 | 26.0 | 65.0 | 44.5 | 71 | 35.5 | 62 | 133 | 92.5 | 50 | 50 | 50 | 49 | 84.5 | 2344 | DG105/30SHDOMD | 420 |
| | 38 | 26.0 | 65.0 | 42.0 | 73 | 41.0 | 72 | 145 | 92.5 | 60 | 50 | 50 | 57 | 89.0 | 2485 | DG105/38SHDOMD | 420 |

¹⁾ Pressure shown = item deliverable

⁴⁾ S = heavy series

 $\frac{\text{PN (bar)}}{10} = \text{PN (MPa)}$
Delivery without nut and ring. Information on ordering complete fittings or alternative sealing materials see page 17.

*Please add the **suffixes** below according to the material/surface required.

| Order code suffixes | | | |
|---------------------------------|-----------------------------|----------------|---|
| Material | Suffix surface and material | Example | Standard sealing material (no additional suffix needed) |
| Steel, zinc plated, Cr(VI)-free | CF | DG105/12SOMDCF | VIT |



DG 106-R Double elbow male stud ball bearing rotary union

Male BSPP thread – ED-seal (ISO 1179) / EO 24° cone end
(Adjustable at male thread axis, consisting of DG105 + EGE)

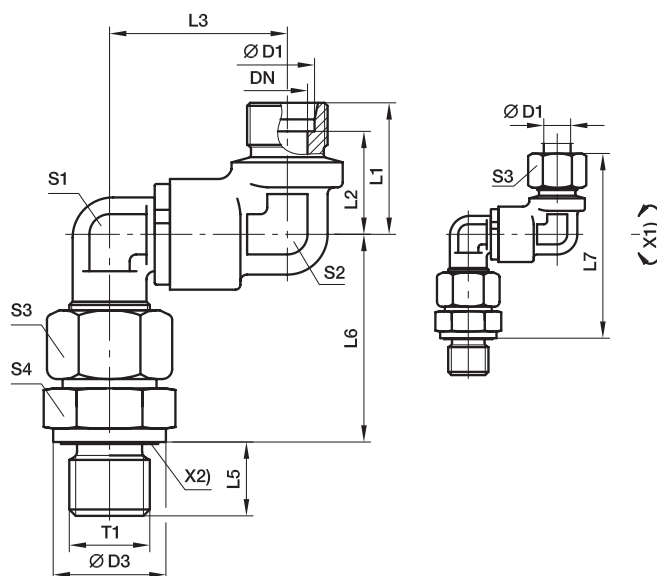

X1) Axis
X2) Eolastic-sealing

| Series | D1 | T1 | DN | D3 | L1 | L2 | L3 | L5 | L6 | L7 | S1 | S2 | S3 | S4 | Weight g/1 piece | Order code* | PN (bar) ¹⁾ |
|-----------------|----|-----------|------|----|----|------|------|----|-------|-----|----|----|----|----|---------------------|------------------------|---------------------------|
| S ⁴⁾ | 12 | G 3/8 A | 9.5 | 24 | 34 | 26.5 | 53.0 | 12 | 55.5 | 99 | 24 | 22 | 24 | 22 | 484 | DG106/12SRHDOMD | 420 |
| | 16 | G 1/2 A | 9.5 | 27 | 34 | 25.5 | 53.0 | 14 | 61.5 | 105 | 24 | 24 | 30 | 27 | 547 | DG106/16SRHDOMD | 420 |
| | 20 | G 3/4 A | 16.0 | 32 | 50 | 39.5 | 76.0 | 16 | 69.5 | 131 | 36 | 32 | 36 | 32 | 1288 | DG106/20SRHDOMD | 420 |
| | 25 | G 1 A | 16.0 | 40 | 50 | 38.0 | 76.0 | 18 | 78.0 | 140 | 36 | 32 | 46 | 41 | 1528 | DG106/25SRHDOMD | 420 |
| | 30 | G 1 1/4 A | 26.0 | 50 | 58 | 44.5 | 92.5 | 20 | 86.5 | 158 | 50 | 50 | 50 | 50 | 3004 | DG106/30SRHDOMD | 420 |
| | 38 | G 1 1/2 A | 26.0 | 55 | 58 | 42.0 | 92.5 | 22 | 101.0 | 174 | 50 | 50 | 60 | 55 | 3419 | DG106/38SRHDOMD | 420 |

¹⁾ Pressure shown = item deliverable

⁴⁾ S = heavy series

PN (bar) = PN (MPa) / 10

Delivery without nut and ring. Information on ordering complete fittings or alternative sealing materials see page 17.



*Please add the **suffixes** below according to the material/ surface required.

| Order code suffixes | | | |
|---------------------------------|-----------------------------|-----------------|---|
| Material | Suffix surface and material | Example | Standard sealing material (no additional suffix needed) |
| Steel, zinc plated, Cr(VI)-free | CF | DG106/06SROMDCF | VIT/NBR |



Rotary fittings



Index

DG 106-M Double elbow male stud ball bearing rotary union

Male metric thread – ED-seal (ISO 9974) / EO 24° cone end
(Adjustable at male thread axis, consisting of DG105 + EGE)

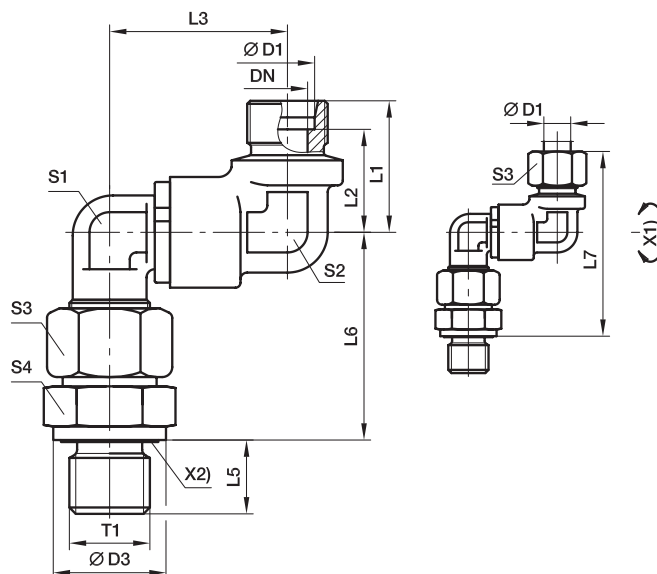

X1) Axis
X2) Eolastic-sealing

| Series | D1 | T1 | DN | D3 | L1 | L2 | L3 | L5 | L6 | L7 | S1 | S2 | S3 | S4 | Weight g/1 piece | Order code* | PN (bar) ¹⁾ |
|-----------------|----|----------|------|----|----|------|------|----|-------|-----|----|----|----|----|---------------------|------------------------|---------------------------|
| S ⁴⁾ | 12 | M 18×1.5 | 9.5 | 24 | 34 | 26.5 | 53.0 | 12 | 55.5 | 99 | 24 | 22 | 24 | 24 | 495 | DG106/12SMHDOMD | 420 |
| | 16 | M 22×1.5 | 9.5 | 27 | 34 | 25.5 | 53.0 | 14 | 61.5 | 105 | 24 | 24 | 30 | 27 | 551 | DG106/16SMHDOMD | 420 |
| | 20 | M 27×2.0 | 16.0 | 32 | 50 | 39.5 | 76.0 | 16 | 69.5 | 131 | 36 | 32 | 36 | 32 | 1289 | DG106/20SMHDOMD | 420 |
| | 25 | M 33×2.0 | 16.0 | 40 | 50 | 38.0 | 76.0 | 18 | 78.0 | 140 | 36 | 32 | 46 | 41 | 1532 | DG106/25SMHDOMD | 420 |
| | 30 | M 42×2.0 | 26.0 | 50 | 58 | 44.5 | 92.5 | 20 | 86.5 | 158 | 50 | 50 | 50 | 50 | 3007 | DG106/30SMHDOMD | 420 |
| | 38 | M 48×2.0 | 26.0 | 55 | 58 | 42.0 | 92.5 | 22 | 101.0 | 174 | 50 | 50 | 60 | 55 | 3441 | DG106/38SMHDOMD | 420 |

¹⁾ Pressure shown = item deliverable

⁴⁾ S = heavy series

PN (bar)
10 = PN (MPa)

Delivery without nut and ring. Information on ordering complete fittings or alternative sealing materials see page 17.

*Please add the **suffixes** below according to the material/ surface required.

| Order code suffixes | | | |
|---------------------------------|-----------------------------|-----------------|---|
| Material | Suffix surface and material | Example | Standard sealing material (no additional suffix needed) |
| Steel, zinc plated, Cr(VI)-free | CF | DG106/06SMOMDCF | VIT/NBR |





DG 107 Straight bulkhead ball bearing rotary union

EO 24° cone end / EO 24° cone end

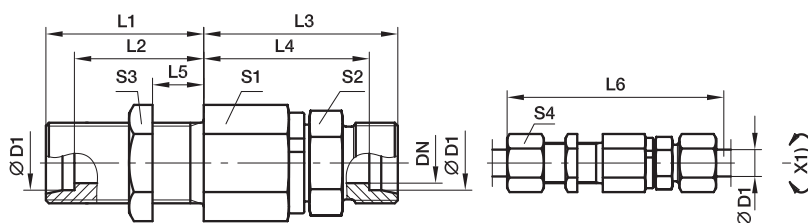

X1) Axis

| Series | D1 | DN | T1 | L1 | L2 | L3 | L4 | L5 | L6 | S1 | S2 | S3 | S4 | Weight g/1 piece | Order code* | PN (bar) ¹⁾ |
|-----------------|----|------|----------|----|------|----|------|----|-----|----|----|----|----|---------------------|-----------------------|---------------------------|
| S ⁴⁾ | 06 | 5.0 | M 14×1.5 | 23 | 16.0 | 49 | 42.0 | 5 | 87 | 22 | 17 | 19 | 17 | 134 | DG107/06SHDOMD | 420 |
| | 08 | 5.0 | M 16×1.5 | 23 | 16.0 | 49 | 42.0 | 5 | 87 | 22 | 17 | 22 | 19 | 143 | DG107/08SHDOMD | 420 |
| | 12 | 9.5 | M 20×1.5 | 23 | 15.5 | 60 | 52.5 | 5 | 100 | 30 | 24 | 27 | 24 | 291 | DG107/12SHDOMD | 420 |
| | 16 | 9.5 | M 24×1.5 | 26 | 17.5 | 60 | 51.5 | 5 | 105 | 30 | 27 | 32 | 30 | 328 | DG107/16SHDOMD | 420 |
| | 20 | 16.0 | M 30×2.0 | 39 | 28.5 | 76 | 65.5 | 15 | 137 | 41 | 36 | 41 | 36 | 710 | DG107/20SHDOMD | 420 |
| | 25 | 16.0 | M 36×2.0 | 42 | 30.0 | 78 | 66.0 | 15 | 144 | 41 | 41 | 46 | 46 | 847 | DG107/25SHDOMD | 420 |
| | 30 | 26.0 | M 42×2.0 | 44 | 30.5 | 89 | 75.5 | 15 | 159 | 60 | 46 | 50 | 50 | 1533 | DG107/30SHDOMD | 420 |
| | 38 | 26.0 | M 52×2.0 | 47 | 31.0 | 92 | 76.0 | 15 | 168 | 60 | 55 | 65 | 60 | 1930 | DG107/38SHDOMD | 420 |

¹⁾Pressure shown = item deliverable

⁴⁾S = heavy series

$$\frac{\text{PN (bar)}}{10} = \text{PN (MPa)}$$
Delivery without nut and ring. Information on ordering complete fittings or alternative sealing materials see page 17.



*Please add the **suffixes** below according to the material/surface required.

| Order code suffixes | | | |
|---------------------------------|-----------------------------|----------------|---|
| Material | Suffix surface and material | Example | Standard sealing material (no additional suffix needed) |
| Steel, zinc plated, Cr(VI)-free | CF | DG107/06SOMDCF | VIT |

Rotary fittings

DG 108 Elbow bulkhead ball bearing rotary union

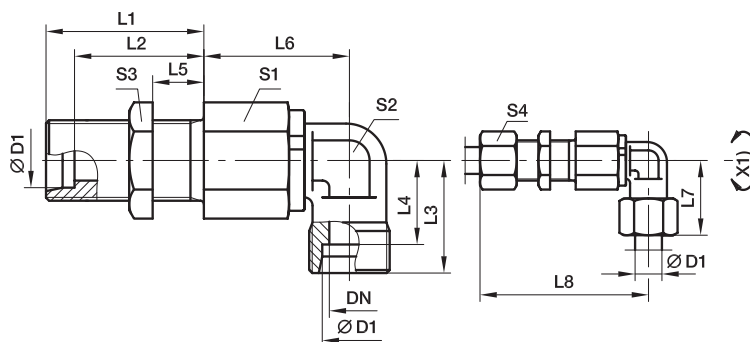
EO 24° cone end / EO 24° cone end



X1) Axis

| Series | D1 | DN | T1 | L1 | L2 | L3 | L4 | L5 | L6 | L7 | L8 | S1 | S2 | S3 | S4 | Weight g/1 piece | Order code* | PN (bar) ¹⁾ |
|-----------------|----|------|----------|----|------|----|------|----|------|----|-------|----|----|----|----|---------------------|----------------|---------------------------|
| S ⁴⁾ | 06 | 5.0 | M 14×1.5 | 23 | 16.0 | 23 | 16.0 | 5 | 39.5 | 31 | 70.0 | 22 | 17 | 19 | 17 | 154 | DG108/06SHDOMD | 420 |
| | 08 | 5.0 | M 16×1.5 | 23 | 16.0 | 23 | 17.0 | 5 | 39.5 | 32 | 70.0 | 22 | 17 | 22 | 19 | 166 | DG108/08SHDOMD | 420 |
| | 12 | 9.5 | M 20×1.5 | 23 | 15.5 | 29 | 21.5 | 5 | 51.0 | 38 | 83.0 | 30 | 22 | 27 | 24 | 333 | DG108/12SHDOMD | 420 |
| | 16 | 9.5 | M 24×1.5 | 26 | 17.5 | 33 | 24.5 | 5 | 49.0 | 43 | 85.0 | 30 | 22 | 32 | 30 | 354 | DG108/16SHDOMD | 420 |
| | 20 | 16.0 | M 30×2.0 | 39 | 28.5 | 37 | 26.5 | 15 | 67.0 | 48 | 117.5 | 41 | 36 | 41 | 36 | 904 | DG108/20SHDOMD | 420 |
| | 25 | 16.0 | M 36×2.0 | 42 | 30.0 | 42 | 30.0 | 15 | 65.0 | 54 | 119.5 | 41 | 36 | 46 | 45 | 999 | DG108/25SHDOMD | 420 |
| | 30 | 26.0 | M 42×2.0 | 44 | 30.5 | 49 | 35.5 | 15 | 82.5 | 62 | 140.0 | 60 | 50 | 50 | 50 | 1935 | DG108/30SHDOMD | 420 |
| | 38 | 26.0 | M 52×2.0 | 47 | 31.0 | 57 | 41.0 | 15 | 80.5 | 72 | 142.0 | 60 | 50 | 65 | 60 | 2351 | DG108/38SHDOMD | 420 |

¹⁾Pressure shown = item deliverable

⁴⁾S = heavy series

 $\frac{\text{PN (bar)}}{10} = \text{PN (MPa)}$

Delivery without nut and ring. Information on ordering complete fittings or alternative sealing materials see page 17.

*Please add the **suffixes** below according to the material/surface required.

| Order code suffixes | | | |
|---------------------------------|-----------------------------|----------------|---|
| Material | Suffix surface and material | Example | Standard sealing material (no additional suffix needed) |
| Steel, zinc plated, Cr(VI)-free | CF | DG108/06SOMDCF | VIT |



DG 208-R Double elbow male stud ball bearing rotary union

Male BSPP thread – ED-seal (ISO 1179) / EO 24° cone end

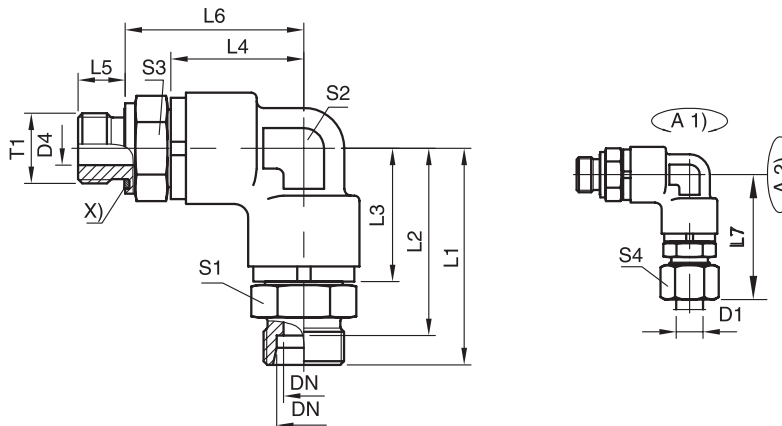

| Series | D1 | T1 | DN | L1 | L2 | L3 | L4 | L5 | L6 | L7 | S1 | S2 | S3 | S4 | Order code* | PN (bar) ¹⁾ |
|-----------------|----|-----------|----|-------|------|------|------|----|------|-------|----|----|----|----|-----------------|------------------------|
| S ⁴⁾ | 12 | G 3/8 A | 8 | 61.8 | 54.3 | 39.8 | 39.8 | 12 | 52.5 | 70.3 | 24 | 24 | 24 | 24 | DG208/12SRHDOMD | 420 |
| | 16 | G 1/2 A | 12 | 64.5 | 56.5 | 39.8 | 39.8 | 14 | 53.0 | 73.5 | 27 | 24 | 27 | 30 | DG208/16SRHDOMD | 420 |
| | 20 | G 3/4 A | 16 | 84.5 | 74.5 | 56.5 | 56.5 | 16 | 71.5 | 95.5 | 36 | 32 | 36 | 36 | DG208/20SRHDOMD | 420 |
| | 25 | G 1 A | 16 | 89.5 | 77.5 | 56.5 | 56.5 | 18 | 74.5 | 100.5 | 41 | 32 | 41 | 46 | DG208/25SRHDOMD | 420 |
| | 38 | G 1 1/2 A | 32 | 104.0 | 88.0 | 65.3 | 65.3 | 22 | 85.3 | 121.5 | 55 | 50 | 55 | 60 | DG208/38SRHDOMD | 420 |

¹⁾ Pressure shown = item deliverable

⁴⁾ S = heavy series

$$\frac{PN \text{ (bar)}}{10} = PN \text{ (MPa)}$$

Delivery without nut and ring. Information on ordering complete fittings or alternative sealing materials see page 17.



*Please add the **suffixes** below according to the material/ surface required.

| Order code suffixes | | | |
|---------------------------------|-----------------------------|----------------|---|
| Material | Suffix surface and material | Example | Standard sealing material (no additional suffix needed) |
| Steel, zinc plated, Cr(VI)-free | CF | DG208/12SRMDCF | VIT |



Rotary fittings

DVGE-R Straight male stud plain bearing rotary union

Male BSPP thread – ED-seal / EO 24° cone end

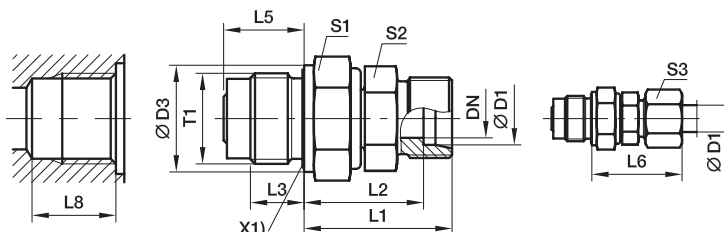

X1) Eolastic-sealing

 L8 larger than DIN 3852
chart page Q22

| Series | D1 | T1 | DN | D3 | L1 | L2 | L3 | L5 | L6 | S1 | S2 | S3 | Weight g/1 piece | Order code* | PN (bar) ¹⁾ | |
|-----------------|----|-----------|----|----|------|------|----|------|----|----|----|----|---------------------|--------------------|------------------------|-----|
| | | | | | | | | | | | | | | | CF | VIT |
| L ³⁾ | 06 | G 1/4 A | 4 | 19 | 28.0 | 21.0 | 12 | 18.0 | 40 | 19 | 12 | 14 | 43 | DVGE06LROMD | 40 | 40 |
| | 08 | G 1/4 A | 5 | 19 | 28.0 | 21.0 | 12 | 18.0 | 40 | 19 | 14 | 17 | 44 | DVGE08LROMD | 40 | 40 |
| | 10 | G 3/8 A | 6 | 22 | 32.0 | 25.0 | 12 | 18.0 | 40 | 24 | 17 | 19 | 74 | DVGE10LROMD | 40 | 40 |
| | 12 | G 1/2 A | 8 | 27 | 34.0 | 27.0 | 14 | 21.0 | 42 | 27 | 19 | 22 | 116 | DVGE12LROMD | 40 | 40 |
| | 15 | G 3/4 A | 10 | 32 | 39.0 | 32.0 | 16 | 24.0 | 47 | 32 | 24 | 27 | 214 | DVGE15LROMD | 40 | 40 |
| | 18 | G 1 A | 16 | 40 | 42.5 | 35.0 | 18 | 27.5 | 51 | 41 | 27 | 32 | 337 | DVGE18LROMD | 40 | 40 |
| | 22 | G 1 A | 16 | 40 | 46.5 | 39.0 | 18 | 27.5 | 55 | 41 | 32 | 36 | 376 | DVGE22LROMD | 40 | 40 |
| | 28 | G 1 1/4 A | 22 | 50 | 48.0 | 40.5 | 20 | 31.0 | 57 | 50 | 41 | 41 | 586 | DVGE28LROMD | 40 | 40 |
| | 35 | G 1 1/2 A | 25 | 55 | 55.0 | 44.5 | 22 | 35.0 | 66 | 55 | 46 | 50 | 868 | DVGE35LROMD | 40 | 40 |
| S ⁴⁾ | 06 | G 1/4 A | 4 | 19 | 30.0 | 23.0 | 12 | 18.0 | 38 | 19 | 14 | 17 | 50 | DVGE06SROMD | 100 | 100 |
| | 08 | G 1/4 A | 5 | 19 | 31.0 | 24.0 | 12 | 18.0 | 39 | 19 | 17 | 19 | 55 | DVGE08SROMD | 100 | 100 |
| | 10 | G 3/8 A | 6 | 22 | 34.0 | 26.5 | 12 | 18.0 | 43 | 24 | 19 | 22 | 85 | DVGE10SROMD | 100 | 100 |
| | 12 | G 1/2 A | 8 | 27 | 36.0 | 28.5 | 14 | 21.0 | 45 | 27 | 22 | 24 | 134 | DVGE12SROMD | 100 | 100 |
| | 14 | G 3/4 A | 10 | 32 | 41.0 | 33.0 | 16 | 24.0 | 51 | 32 | 24 | 27 | 220 | DVGE14SROMD | 100 | 100 |
| | 16 | G 3/4 A | 10 | 32 | 42.0 | 33.5 | 16 | 24.0 | 52 | 32 | 27 | 30 | 230 | DVGE16SROMD | 100 | 100 |
| | 20 | G 1 A | 16 | 40 | 48.5 | 38.0 | 18 | 27.5 | 60 | 41 | 32 | 36 | 385 | DVGE20SROMD | 100 | 100 |
| | 25 | G 1 A | 16 | 40 | 52.5 | 40.5 | 18 | 27.5 | 65 | 41 | 41 | 46 | 483 | DVGE25SROMD | 100 | 100 |
| | 30 | G 1 1/4 A | 22 | 50 | 55.0 | 41.5 | 20 | 31.0 | 68 | 50 | 46 | 50 | 691 | DVGE30SROMD | 100 | 100 |
| | 38 | G 1 1/2 A | 25 | 55 | 63.0 | 47.0 | 22 | 35.0 | 78 | 55 | 55 | 60 | 1080 | DVGE38SROMD | 100 | 100 |

¹⁾ Pressure shown = item deliverable

³⁾ L = light series; ⁴⁾ S = heavy series

$$\frac{\text{PN (bar)}}{10} = \text{PN (MPa)}$$

Delivery without nut and ring. Information on ordering complete fittings or alternative sealing materials see page 17.

 *Please add the **suffixes**
below according to the material/
surface required.

| Order code suffixes | | | |
|---------------------------------|-----------------------------|------------------|---|
| Material | Suffix surface and material | Example | Standard sealing material (no additional suffix needed) |
| Steel, zinc plated, Cr(VI)-free | CF | DVGE06LROMDCF | NBR |
| FKM | VITCF | DVGE06LROMDVITCF | |



DVGE-M Straight male stud plain bearing rotary union

Male metric thread – ED-seal / EO 24° cone end

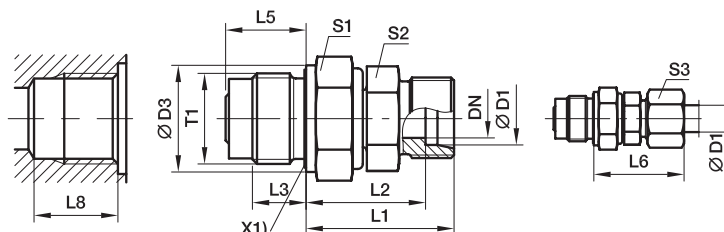

X1) Eolastic-sealing

L8 larger than DIN 3852
chart page Q22

| Series | D1 | T1 | DN | D3 | L1 | L2 | L3 | L5 | L6 | S1 | S2 | S3 | Weight g/1 piece | Order code* | PN (bar) ¹⁾ | |
|-----------------|----------|----------|----|------|------|------|------|------|----|----|----|------|---------------------|-------------|------------------------|-----|
| | | | | | | | | | | | | | | | CF | VIT |
| L ³⁾ | 06 | M 14×1.5 | 4 | 19 | 27.0 | 20.0 | 12 | 18.0 | 27 | 19 | 12 | 14 | 44 | DVGE06LMOMD | 40 | 40 |
| | 08 | M 14×1.5 | 5 | 19 | 28.0 | 21.0 | 12 | 18.0 | 29 | 19 | 12 | 17 | 45 | DVGE08LMOMD | 40 | 40 |
| | 10 | M 18×1.5 | 6 | 24 | 33.0 | 26.0 | 12 | 18.0 | 30 | 24 | 14 | 19 | 87 | DVGE10LMOMD | 40 | 40 |
| | 12 | M 22×1.5 | 8 | 27 | 34.0 | 27.0 | 14 | 21.0 | 32 | 27 | 17 | 22 | 120 | DVGE12LMOMD | 40 | 40 |
| | 15 | M 27×2.0 | 10 | 32 | 40.0 | 33.0 | 16 | 24.0 | 36 | 32 | 19 | 27 | 215 | DVGE15LMOMD | 40 | 40 |
| | 18 | M 33×2.0 | 16 | 40 | 45.0 | 37.5 | 18 | 27.5 | 40 | 41 | 27 | 32 | 349 | DVGE18LMOMD | 40 | 40 |
| | 22 | M 33×2.0 | 16 | 40 | 47.0 | 39.5 | 18 | 27.5 | 44 | 41 | 27 | 36 | 383 | DVGE22LMOMD | 40 | 40 |
| | 28 | M 42×2.0 | 22 | 50 | 51.5 | 44.0 | 20 | 31.0 | 47 | 50 | 36 | 41 | 590 | DVGE28LMOMD | 40 | 40 |
| 35 | M 48×2.0 | 25 | 55 | 64.5 | 54.0 | 22 | 35.0 | 56 | 55 | 41 | 50 | 876 | DVGE35LMOMD | 40 | 40 | |
| S ⁴⁾ | 06 | M 14×1.5 | 4 | 19 | 28.0 | 21.0 | 12 | 18.0 | 31 | 19 | 12 | 17 | 51 | DVGE06SMOMD | 100 | 100 |
| | 08 | M 14×1.5 | 5 | 19 | 29.0 | 22.0 | 12 | 18.0 | 32 | 19 | 14 | 19 | 56 | DVGE08SMOMD | 100 | 100 |
| | 10 | M 18×1.5 | 6 | 24 | 34.5 | 27.0 | 12 | 18.0 | 34 | 24 | 17 | 22 | 98 | DVGE10SMOMD | 100 | 100 |
| | 12 | M 22×1.5 | 8 | 27 | 35.5 | 28.0 | 14 | 21.0 | 38 | 27 | 17 | 24 | 139 | DVGE12SMOMD | 100 | 100 |
| | 16 | M 27×2.0 | 10 | 32 | 42.5 | 34.0 | 16 | 24.0 | 43 | 32 | 24 | 30 | 239 | DVGE16SMOMD | 100 | 100 |
| | 20 | M 33×2.0 | 16 | 40 | 50.0 | 39.5 | 18 | 27.5 | 48 | 41 | 27 | 36 | 385 | DVGE20SMOMD | 100 | 100 |
| | 25 | M 33×2.0 | 16 | 40 | 54.5 | 42.5 | 18 | 27.5 | 54 | 41 | 36 | 46 | 494 | DVGE25SMOMD | 100 | 100 |
| | 30 | M 42×2.0 | 22 | 50 | 61.5 | 48.0 | 20 | 31.0 | 62 | 50 | 41 | 50 | 695 | DVGE30SMOMD | 100 | 100 |
| 38 | M 48×2.0 | 25 | 55 | 71.0 | 55.0 | 22 | 35.0 | 72 | 55 | 50 | 60 | 1088 | DVGE38SMOMD | 100 | 100 | |

¹⁾ Pressure shown = item deliverable

³⁾ L = light series; ⁴⁾ S = heavy series

PN (bar) = PN (MPa)
10

Delivery without nut and ring. Information on ordering complete fittings or alternative sealing materials see page 17.



*Please add the **suffixes**
below according to the material/
surface required.

| Order code suffixes | | | |
|---------------------------------|-----------------------------|------------------|---|
| Material | Suffix surface and material | Example | Standard sealing material (no additional suffix needed) |
| Steel, zinc plated, Cr(VI)-free | CF | DVGE06LMOMDCF | NBR |
| FKM | VITCF | DVGE06LMOMDVITCF | |

Rotary fittings

DVWE-R Elbow male stud plain bearing rotary union

Male BSPP thread – ED-seal / EO 24° cone end

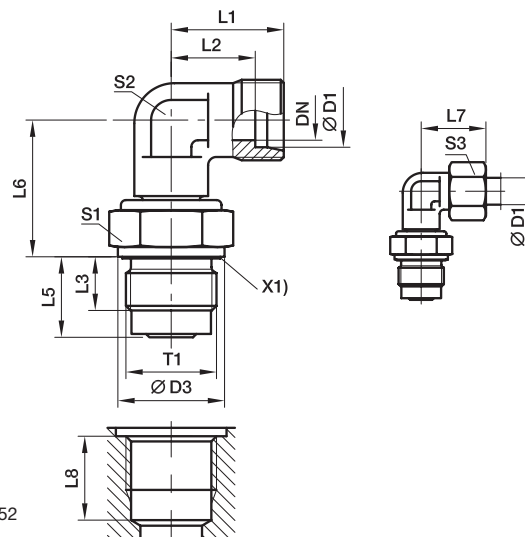

X1) Eolastic-sealing

 L8 larger than DIN 3852
chart page Q22

| Series | D1 | T1 | DN | D3 | L1 | L2 | L3 | L5 | L6 | L7 | S1 | S2 | S3 | Weight g/1 piece | Order code* | PN (bar) ¹⁾ | |
|-----------------|-----------|-----------|----|----|------|------|------|------|------|----|----|----|------|---------------------|-------------|------------------------|-----|
| | | | | | | | | | | | | | | | | CF | VIT |
| L ³⁾ | 06 | G 1/4 A | 4 | 19 | 19 | 12.0 | 12 | 18.0 | 20.0 | 27 | 19 | 12 | 14 | 50 | DVWE06LROMD | 40 | 40 |
| | 08 | G 1/4 A | 5 | 19 | 21 | 14.0 | 12 | 18.0 | 21.0 | 29 | 19 | 12 | 17 | 50 | DVWE08LROMD | 40 | 40 |
| | 10 | G 3/8 A | 6 | 22 | 22 | 15.0 | 12 | 18.0 | 26.0 | 30 | 24 | 14 | 19 | 83 | DVWE10LROMD | 40 | 40 |
| | 12 | G 1/2 A | 8 | 27 | 24 | 17.0 | 14 | 21.0 | 27.0 | 32 | 27 | 17 | 22 | 129 | DVWE12LROMD | 40 | 40 |
| | 15 | G 3/4 A | 10 | 32 | 28 | 21.0 | 16 | 24.0 | 33.0 | 36 | 32 | 19 | 27 | 232 | DVWE15LROMD | 40 | 40 |
| | 18 | G 1 A | 16 | 40 | 31 | 23.5 | 18 | 27.5 | 37.5 | 40 | 41 | 27 | 32 | 393 | DVWE18LROMD | 40 | 40 |
| | 22 | G 1 A | 16 | 40 | 35 | 27.5 | 18 | 27.5 | 39.5 | 44 | 41 | 27 | 36 | 406 | DVWE22LROMD | 40 | 40 |
| | 28 | G 1 1/4 A | 22 | 50 | 38 | 30.5 | 20 | 31.0 | 44.0 | 47 | 50 | 36 | 41 | 664 | DVWE28LROMD | 40 | 40 |
| 35 | G 1 1/2 A | 25 | 55 | 45 | 34.5 | 22 | 35.0 | 54.0 | 56 | 55 | 41 | 50 | 1005 | DVWE35LROMD | 40 | 40 | |
| S ⁴⁾ | 06 | G 1/4 A | 4 | 19 | 23 | 16.0 | 12 | 18.0 | 21.0 | 31 | 19 | 12 | 17 | 58 | DVWE06SROMD | 100 | 100 |
| | 08 | G 1/4 A | 5 | 19 | 24 | 17.0 | 12 | 18.0 | 22.0 | 32 | 19 | 14 | 19 | 65 | DVWE08SROMD | 100 | 100 |
| | 10 | G 3/8 A | 6 | 22 | 25 | 17.5 | 12 | 18.0 | 27.0 | 34 | 24 | 17 | 22 | 103 | DVWE10SROMD | 100 | 100 |
| | 12 | G 1/2 A | 8 | 27 | 29 | 21.5 | 14 | 21.0 | 28.0 | 38 | 27 | 17 | 24 | 152 | DVWE12SROMD | 100 | 100 |
| | 14 | G 3/4 A | 10 | 32 | 30 | 22.0 | 16 | 24.0 | 33.0 | 40 | 32 | 19 | 27 | 236 | DVWE14SROMD | 100 | 100 |
| | 16 | G 3/4 A | 10 | 32 | 33 | 24.5 | 16 | 24.0 | 34.0 | 43 | 32 | 24 | 30 | 276 | DVWE16SROMD | 100 | 100 |
| | 20 | G 1 A | 16 | 40 | 37 | 26.5 | 18 | 27.5 | 39.5 | 48 | 41 | 27 | 36 | 415 | DVWE20SROMD | 100 | 100 |
| | 25 | G 1 A | 16 | 40 | 42 | 30.0 | 18 | 27.5 | 42.5 | 54 | 41 | 36 | 46 | 569 | DVWE25SROMD | 100 | 100 |
| | 30 | G 1 1/4 A | 22 | 50 | 49 | 35.5 | 20 | 31.0 | 48.0 | 62 | 50 | 41 | 50 | 886 | DVWE30SROMD | 100 | 100 |
| | 38 | G 1 1/2 A | 25 | 55 | 57 | 41.0 | 22 | 35.0 | 55.0 | 72 | 55 | 50 | 60 | 1375 | DVWE38SROMD | 100 | 100 |

¹⁾ Pressure shown = item deliverable

³⁾ L = light series; ⁴⁾ S = heavy series

$$\frac{\text{PN (bar)}}{10} = \text{PN (MPa)}$$

Delivery without nut and ring. Information on ordering complete fittings or alternative sealing materials see page 17.

 *Please add the **suffixes** below according to the material/ surface required.

| Order code suffixes | | | |
|---------------------------------|-----------------------------|------------------|---|
| Material | Suffix surface and material | Example | Standard sealing material (no additional suffix needed) |
| Steel, zinc plated, Cr(VI)-free | CF | DVWE06LROMDCF | NBR |
| FKM | VITCF | DVWE06LROMDVITCF | |



DVWE-M Elbow male stud plain bearing rotary union

Male metric thread – ED-seal / EO 24° cone end

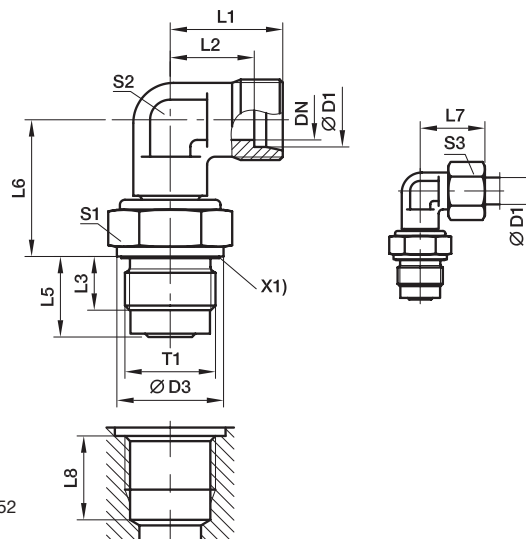

X1) Eolastic-sealing

L8 larger than DIN 3852 chart page Q22

| Series | D1 | T1 | DN | D3 | L1 | L2 | L3 | L5 | L6 | L7 | S1 | S2 | S3 | Weight g/1 piece | Order code* | PN (bar) ¹⁾ | |
|-----------------|----------|----------|----|----|------|------|------|------|------|----|----|----|------|---------------------|-------------|------------------------|-----|
| | | | | | | | | | | | | | | | | CF | VIT |
| L ³⁾ | 06 | M 14×1.5 | 4 | 19 | 19 | 12.0 | 12 | 18.0 | 20.0 | 27 | 19 | 12 | 14 | 51 | DVWE06LMOMD | 40 | 40 |
| | 08 | M 14×1.5 | 5 | 19 | 21 | 14.0 | 12 | 18.0 | 21.0 | 29 | 19 | 12 | 17 | 51 | DVWE08LMOMD | 40 | 40 |
| | 10 | M 18×1.5 | 6 | 24 | 22 | 15.0 | 12 | 18.0 | 26.0 | 30 | 24 | 14 | 19 | 92 | DVWE10LMOMD | 40 | 40 |
| | 12 | M 22×1.5 | 8 | 27 | 24 | 17.0 | 14 | 21.0 | 27.0 | 32 | 27 | 17 | 22 | 160 | DVWE12LMOMD | 40 | 40 |
| | 15 | M 27×2.0 | 10 | 32 | 28 | 21.0 | 16 | 24.0 | 33.0 | 36 | 32 | 19 | 27 | 236 | DVWE15LMOMD | 40 | 40 |
| | 18 | M 33×2.0 | 16 | 40 | 31 | 23.5 | 18 | 27.5 | 37.5 | 40 | 41 | 27 | 32 | 405 | DVWE18LMOMD | 40 | 40 |
| | 22 | M 33×2.0 | 16 | 40 | 35 | 27.5 | 18 | 27.5 | 39.5 | 44 | 41 | 27 | 36 | 409 | DVWE22LMOMD | 40 | 40 |
| | 28 | M 42×2.0 | 22 | 50 | 38 | 30.5 | 20 | 31.0 | 44.0 | 47 | 50 | 36 | 41 | 660 | DVWE28LMOMD | 40 | 40 |
| 35 | M 48×2.0 | 25 | 55 | 45 | 34.5 | 22 | 35.0 | 54.0 | 56 | 55 | 41 | 50 | 1012 | DVWE35LMOMD | 40 | 40 | |
| S ⁴⁾ | 06 | M 14×1.5 | 4 | 19 | 23 | 16.0 | 12 | 18.0 | 21.0 | 31 | 19 | 12 | 17 | 59 | DVWE06SMOMD | 100 | 100 |
| | 08 | M 14×1.5 | 5 | 19 | 24 | 17.0 | 12 | 18.0 | 22.0 | 32 | 19 | 14 | 19 | 66 | DVWE08SMOMD | 100 | 100 |
| | 10 | M 18×1.5 | 6 | 24 | 25 | 17.5 | 12 | 18.0 | 27.0 | 34 | 24 | 17 | 22 | 113 | DVWE10SMOMD | 100 | 100 |
| | 12 | M 22×1.5 | 8 | 27 | 29 | 21.5 | 14 | 21.0 | 28.0 | 38 | 27 | 17 | 24 | 153 | DVWE12SMOMD | 100 | 100 |
| | 16 | M 27×2.0 | 10 | 32 | 33 | 24.5 | 16 | 24.0 | 34.0 | 43 | 32 | 24 | 30 | 284 | DVWE16SMOMD | 100 | 100 |
| | 20 | M 33×2.0 | 16 | 40 | 37 | 26.5 | 18 | 27.5 | 39.5 | 48 | 41 | 27 | 36 | 427 | DVWE20SMOMD | 100 | 100 |
| | 25 | M 33×2.0 | 16 | 40 | 42 | 30.0 | 18 | 27.5 | 42.5 | 54 | 41 | 36 | 46 | 581 | DVWE25SMOMD | 100 | 100 |
| | 30 | M 42×2.0 | 22 | 50 | 49 | 35.5 | 20 | 31.0 | 48.0 | 62 | 50 | 41 | 50 | 898 | DVWE30SMOMD | 100 | 100 |
| 38 | M 48×2.0 | 25 | 55 | 57 | 41.0 | 22 | 35.0 | 55.0 | 72 | 55 | 50 | 60 | 1373 | DVWE38SMOMD | 100 | 100 | |

¹⁾ Pressure shown = item deliverable

³⁾ L = light series; ⁴⁾ S = heavy series

$\frac{PN \text{ (bar)}}{10} = PN \text{ (MPa)}$

Delivery without nut and ring. Information on ordering complete fittings or alternative sealing materials see page 17.

*Please add the **suffixes** below according to the material/surface required.

| Order code suffixes | | | |
|---------------------------------|-----------------------------|------------------|---|
| Material | Suffix surface and material | Example | Standard sealing material (no additional suffix needed) |
| Steel, zinc plated, Cr(VI)-free | CF | DVWE06LMOMDCF | NBR |
| FKM | VITCF | DVWE06LMOMDVITCF | |



Port tapping for plain bearing rotary fittings DVGE and DVWE

Port tapping form X
according to DIN 3852, part 1 and part 2
(for parallel male studs)

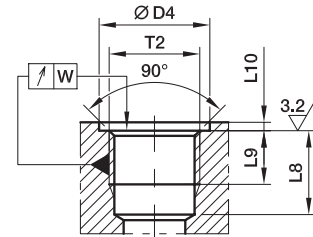

| Thread d1 | d4 small +0.4 | a ₁ max | L9 min | L8 min | W |
|--------------|------------------|-----------------------|-----------|-----------|-----|
| M 14×1.5 | 20 | 1.5 | 12 | 19.0 | 0.1 |
| M 18×1.5 | 25 ²⁾ | 2.0 | 12 | 19.0 | 0.1 |
| M 22×1.5 | 28 | 2.5 | 14 | 22.0 | 0.1 |
| M 27×2.0 | 33 | 2.5 | 16 | 25.0 | 0.2 |
| M 33×2.0 | 41 ²⁾ | 2.5 | 18 | 28.5 | 0.2 |
| M 42×2.0 | 51 ²⁾ | 2.5 | 20 | 32.0 | 0.2 |
| M 48×2.0 | 56 | 2.5 | 22 | 36.0 | 0.2 |
| G 1/4 A | 20 ²⁾ | 1.5 | 12 | 19.0 | 0.1 |
| G 3/8 A | 23 | 2.0 | 12 | 19.0 | 0.1 |
| G 1/2 A | 28 ²⁾ | 2.5 | 14 | 22.0 | 0.1 |
| G 3/4 A | 33 | 2.5 | 16 | 25.0 | 0.2 |
| G 1 A | 41 ²⁾ | 2.5 | 18 | 28.5 | 0.2 |
| G 1 1/4 A | 51 ²⁾ | 2.5 | 20 | 32.0 | 0.2 |
| G 1 1/2 A | 56 | 2.5 | 22 | 36.0 | 0.2 |

¹⁾ Not in DIN 3852

²⁾ Different from DIN 3852



***SensoControl®
Test Points
Diagnostic-
Test equipment
Industrial Products***



Parker SensoControl®

Visual index

Series 1

Test point fitting with pin-lock

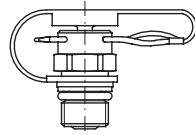

EMA1
p. R4

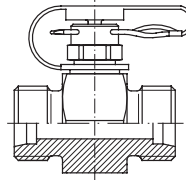

GMA1
p. R5

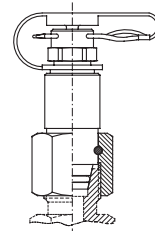

VKA1
p. R6

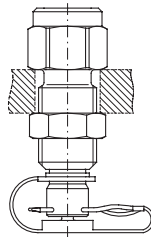

MAV ... MA1
p. R7

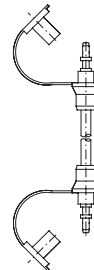

SMA1
p. R7

Series 3

Test point with threaded connection
M 16x2

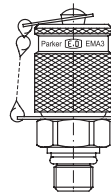

EMA3
p. R8

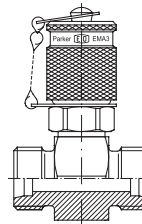

GMA3
p. R9

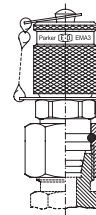

VKA3
p. R10

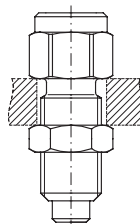

MAV ... MA3
p. R11

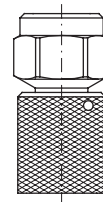

MAVMD ... MA3
p. R11

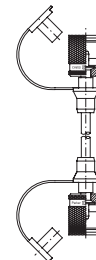

SMA3
p. R11

SensoControl®

Product range

Diagnostic/Industrial

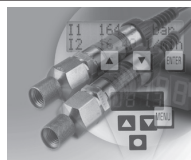

p. R12

EMA1/EMA3-Test Point fitting

- For pressure monitoring and checking on high, low and negative pressure systems.
- For bleeding cylinders and hydraulic systems.
- For taking samples on high, low and negative pressure systems.

Advantages:

- Leakfree connection before valve is open
- Sturdy, safe constructions for small dimensions
- Easy handling
- Simple connection of measuring, control and switching devices
- Coupling under pressure up to 400 bar is possible with screw couplings
- Nominal pressures up to 630 bar
- Self locking metal guard cap, vibration resistant

Sealing system of the primary seal:

EMA1 by ball non-return valve.

EMA3 by cone seal with O-ring.

The new EMA3 sealing system guarantees minimum leakage rates.

The screw-on Cap (EMA3), and pin lock (EMA1) types both employ an O-ring seal as secondary sealing with the hose attached.

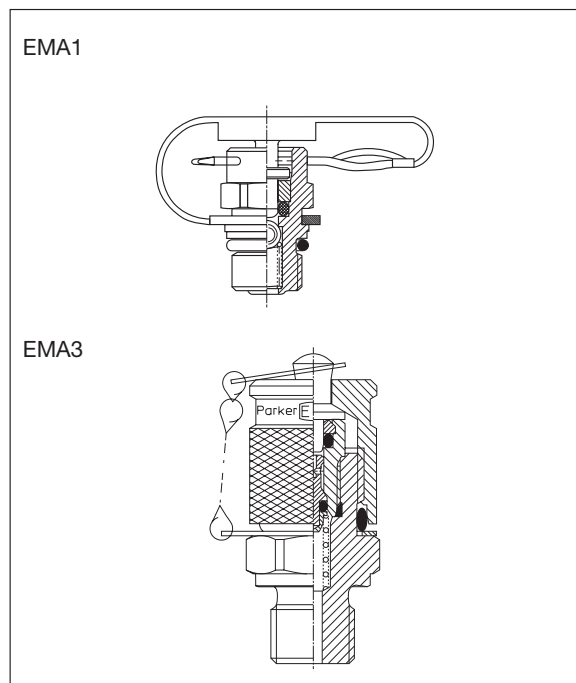

Differences between EMA1 and EMA3 types

- sealing system (see previous section)
- Test hose connection by plug-in coupling in EMA1
Test hose connection by threaded connection in EMA3
- Working pressures (see section advantages)

Working pressure

- EMA3 types up to 630 bar
- EMA1 types up to 400 bar
- Max. working pressure 630 bar for GMA, VKA and EMA... the recommended working pressure of fitting manufacturer has to be applied
- Joining under pressure up to 400 bar max.
- The allowable nominal pressures of each Test-Point are shown on the product pages.

Materials and Temperatures:

- Steel, zinc plated, Cr(VI)-free
- Stainless Steel, material 1.4571
- Seals:
- FKM (Temperature range -20 to +200°C)
- EPDM Ethylene Propylene (for Break Fluid) (Temperature range -40 to +150°C)
- Internal seals are always FKM
- Hose:
- Polyamide (Temperature range: -35°C ... 100°C max.)
- Stainless Steel FKM only

Media:

- Suitable for hydraulic oils and other mineral oil based fluids (Please pay attention to the sealing materials used!)
- For use in conjunction with other liquid media please consult Parker

Standards

ISO15171-2



Perbunan = registered trademark of Bayer

Parker SensoControl® Test Points

EMA1 Test point fitting with pin-lock

Series 1

Male stud thread: BSP, metric

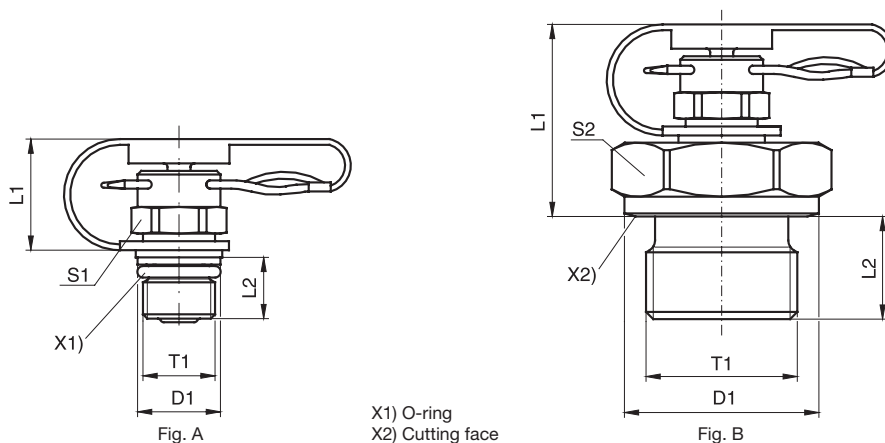

| T1 | D1 | L1 | L2 | S1 | S2 | Fig. | Weight g/1 piece | Order code* | PN (bar) ¹⁾ CF | DF** |
|----------|------|------|------|----|----|------|---------------------|--------------------|------------------------------|------|
| M 12×1.5 | 17.0 | 32.0 | 12.0 | | 19 | B | 53 | EMA1/12X1.5 | 400 | 4 |
| M 14×1.5 | 19.0 | 32.0 | 12.0 | | 19 | B | 56 | EMA1/14X1.5 | 400 | 4 |
| M 16×1.5 | 21.0 | 25.0 | 12.0 | | 22 | B | 47 | EMA1/16X1.5 | 400 | 4 |
| G 1/8 | 14.0 | 32.5 | 8.0 | | 17 | B | 41 | EMA1/1/8 | 400 | 4 |
| G 1/4 | 18.0 | 32.0 | 12.0 | | 19 | B | 54 | EMA1/1/4 | 400 | 4 |
| G 3/8 | 22.0 | 27.5 | 12.0 | | 22 | B | 55 | EMA1/3/8 | 400 | 4 |
| G 1/2 | 26.0 | 27.5 | 14.0 | | 27 | B | 78 | EMA1/1/2 | 400 | 4 |
| M 08×1.0 | 9.5 | 17.5 | 8.4 | 12 | | A | 16 | EMA1/8X1OR | 400 | 4 |
| M 10×1.0 | 11.5 | 18.0 | 8.0 | 12 | | A | 18 | EMA1/10X1OR | 400 | 4 |
| M 10×1.0 | 14.0 | 32.5 | 8.0 | | 17 | B | 42 | EMA1/10X1 | 400 | 4 |

**DF = Design Factor

¹⁾Pressure shown = item deliverable

$\frac{PN \text{ (bar)}}{10} = PN \text{ (MPa)}$

*Please add the **suffixes** below according to the material/surface required.

| Order code suffixes | | | |
|---------------------------------|-----------------------------|---------------|---|
| Material | Suffix surface and material | Example | Standard sealing material (no additional suffix needed) |
| Steel, zinc plated, Cr(VI)-free | CF | EMA1/12X1.5CF | NBR |

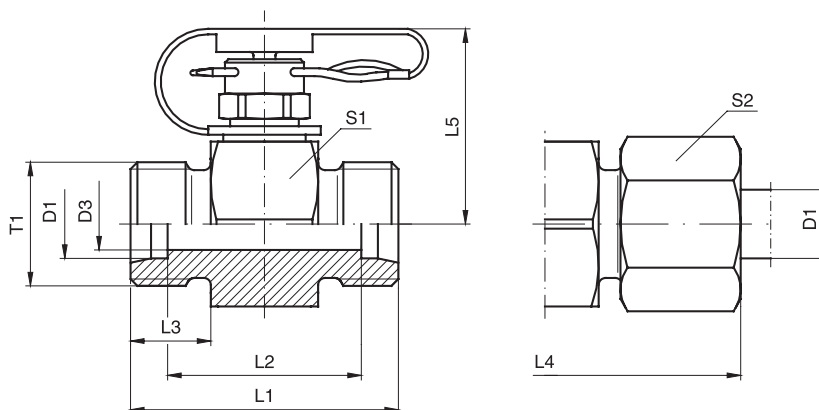
GMA1 Straight test point fitting with pin-lock
Series 1

| Series | D1 | T1 | D3 | L1 | L2 | L3 | L4 | L5 | S1 | S2 | Weight g/1 piece | Order code* | PN (bar) ¹⁾ CF | DF** | |
|-----------------|----|----------|----------|----|----|----|----|------|------|----|---------------------|--------------------|------------------------------|------|---|
| L ³⁾ | 06 | M 12×1.5 | 4 | 35 | 21 | 10 | 51 | 29.0 | 24 | 14 | 73 | GMA1/06LOMD | 315 | 4 | |
| | 08 | M 14×1.5 | 6 | 35 | 21 | 10 | 51 | 29.0 | 24 | 17 | 75 | GMA1/08LOMD | 315 | 4 | |
| | 10 | M 16×1.5 | 7 | 37 | 23 | 11 | 53 | 29.0 | 24 | 19 | 80 | GMA1/10LOMD | 315 | 4 | |
| | 12 | M 18×1.5 | 8 | 37 | 23 | 11 | 53 | 30.5 | 24 | 22 | 96 | GMA1/12LOMD | 315 | 4 | |
| | 15 | M 22×1.5 | 11 | 39 | 25 | 12 | 55 | 32.0 | 30 | 27 | 121 | GMA1/15LOMD | 315 | 4 | |
| | 18 | M 26×1.5 | 14 | 39 | 24 | 12 | 57 | 33.0 | 32 | 32 | 139 | GMA1/18LOMD | 315 | 4 | |
| | 22 | M 30×2.0 | 18 | 43 | 28 | 14 | 61 | 35.0 | 36 | 36 | 171 | GMA1/22LOMD | 160 | 4 | |
| S ⁴⁾ | 06 | M 14×1.5 | 4 | 39 | 25 | 12 | 55 | 29.0 | 24 | 17 | 82 | GMA1/06SOMD | 400 | 4 | |
| | 08 | M 16×1.5 | 5 | 39 | 25 | 12 | 55 | 29.0 | 24 | 19 | 88 | GMA1/08SOMD | 400 | 4 | |
| | 10 | M 18×1.5 | 7 | 39 | 24 | 12 | 57 | 29.0 | 24 | 22 | 90 | GMA1/10SOMD | 400 | 4 | |
| | 12 | M 20×1.5 | 7 | 39 | 24 | 12 | 57 | 29.0 | 24 | 24 | 96 | GMA1/12SOMD | 400 | 4 | |
| | 14 | M 22×1.5 | 10 | 43 | 27 | 14 | 63 | 30.5 | 27 | 27 | 121 | GMA1/14SOMD | 400 | 4 | |
| | 16 | M 24×1.5 | 11 | 43 | 26 | 14 | 63 | 32.0 | 30 | 30 | 138 | GMA1/16SOMD | 400 | 4 | |
| | | 20 | M 30×2.0 | 15 | 47 | 26 | 16 | 69 | 35.0 | 36 | 36 | 222 | GMA1/20SOMD | 400 | 4 |

**DF = Design Factor

1) Pressure shown = item deliverable

3) L = light series; 4) S = heavy series

$$\frac{\text{PN (bar)}}{10} = \text{PN (MPa)}$$
Delivery without nut and ring. Information on ordering complete fittings or alternative sealing materials see page I7.
R

 *Please add the **suffixes**
below according to the material/
surface required.

| Order code suffixes | | | |
|---------------------------------|-----------------------------------|---------------|---|
| Material | Suffix surface and material | Example | Standard sealing material (no additional suffix needed) |
| Steel, zinc plated, Cr(VI)-free | CF | GMA1/06LOMDCF | NBR |

Parker SensoControl® Test Points

VKA1 Test point fitting with pin lock for cones

Series 1

With 24° cone swivel nut connection

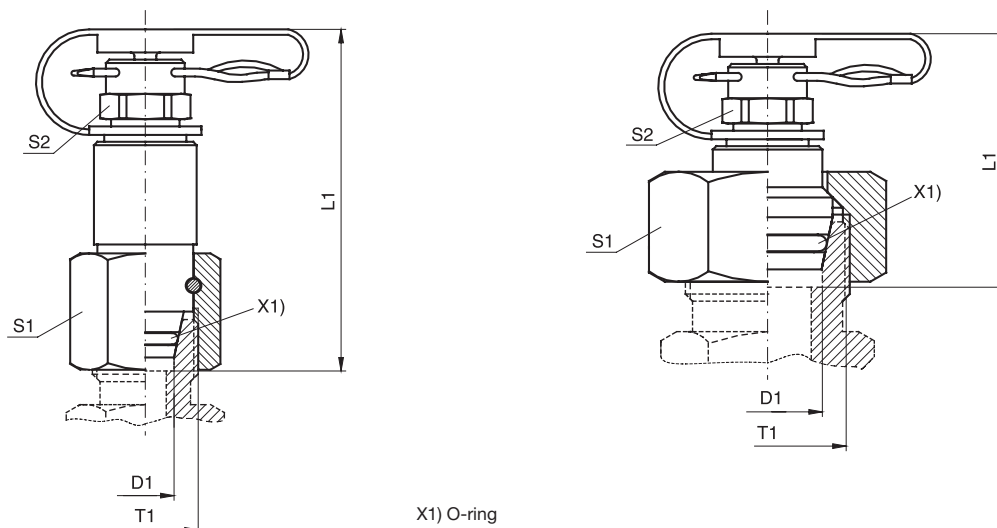

X1) O-ring

| Series | D1 | T1 | L1 | S1 | S2 | Fig. | Weight g/1 piece | Order code* | PN (bar) ¹⁾ CF | DF** |
|-----------------|----|----------|----|----|----|------|------------------|-----------------|------------------------------|------|
| L ³⁾ | 06 | M 12×1.5 | 48 | 14 | 12 | A | 44 | VKA1/06L | 315 | 4 |
| | 08 | M 14×1.5 | 49 | 17 | 12 | A | 54 | VKA1/08L | 315 | 4 |
| | 10 | M 16×1.5 | 50 | 19 | 12 | A | 68 | VKA1/10L | 315 | 4 |
| | 12 | M 18×1.5 | 51 | 22 | 12 | A | 81 | VKA1/12L | 315 | 4 |
| | 15 | M 22×1.5 | 39 | 27 | 12 | B | 82 | VKA1/15L | 315 | 4 |
| | 18 | M 26×1.5 | 38 | 32 | 12 | B | 112 | VKA1/18L | 315 | 4 |
| S ⁴⁾ | 06 | M 14×1.5 | 48 | 17 | 12 | A | 51 | VKA1/06S | 400 | 4 |
| | 08 | M 16×1.5 | 50 | 19 | 12 | A | 62 | VKA1/08S | 400 | 4 |
| | 10 | M 18×1.5 | 50 | 22 | 12 | A | 78 | VKA1/10S | 400 | 4 |
| | 12 | M 20×1.5 | 51 | 24 | 12 | A | 100 | VKA1/12S | 400 | 4 |
| | 14 | M 22×1.5 | 39 | 27 | 12 | B | 88 | VKA1/14S | 400 | 4 |
| | 16 | M 24×1.5 | 37 | 30 | 12 | B | 105 | VKA1/16S | 400 | 4 |
| | 20 | M 30×2.0 | 44 | 36 | 12 | B | 174 | VKA1/20S | 400 | 4 |

**DF = Design Factor

¹⁾Pressure shown = item deliverable

³⁾L = light series; ⁴⁾S = heavy series

$\frac{PN \text{ (bar)}}{10} = PN \text{ (MPa)}$

*Please add the **suffixes** below according to the material/ surface required.

| Order code suffixes | | | |
|---------------------------------|-----------------------------|------------|---|
| Material | Suffix surface and material | Example | Standard sealing material (no additional suffix needed) |
| Steel, zinc plated, Cr(VI)-free | CF | VKA1/06LCF | NBR |

MAV-MA1 SMA1 Test Point pressure gauge connector with pin-lock
Test Point high pressure hose with pin-lock **Series 1**

Female thread: BSP
 Sealing: sealing ring DIN 16258

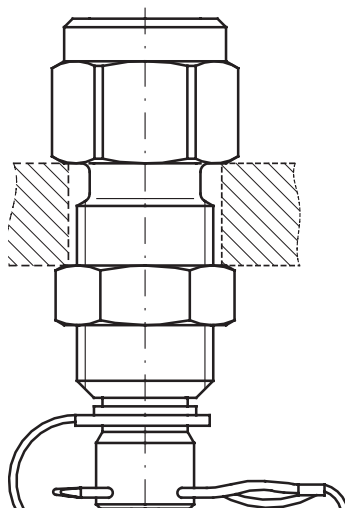

Pressure gauge connector: MAV-MA1

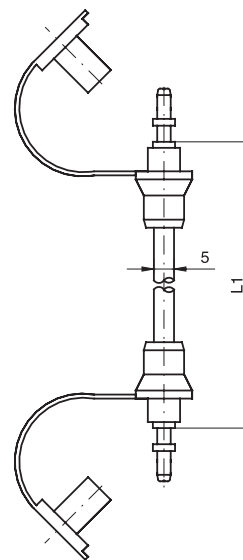

Test hose: SMA1

| T1 | L1 | L2 max. | S1 | S2 | Weight g/1 piece | Order code* | PN (bar) ¹⁾ CF | DF** |
|-------|--------|---------|----|----|------------------|------------------|------------------------------|------|
| G 1/4 | 61.5 | 12 | 19 | 19 | 78 | MAV1/4MA1 | 400 | 4.0 |
| G 1/2 | 72.0 | 12 | 27 | 19 | 135 | MAV1/2MA1 | 400 | 4.0 |
| | 400.0 | | | | 21 | SMA1-400 | 400 | 2.5 |
| | 630.0 | | | | 26 | SMA1-630 | 400 | 2.5 |
| | 800.0 | | | | 26 | SMA1-800 | 400 | 2.5 |
| | 1000.0 | | | | 31 | SMA1-1000 | 400 | 2.5 |
| | 1500.0 | | | | 40 | SMA1-1500 | 400 | 2.5 |
| | 2000.0 | | | | 49 | SMA1-2000 | 400 | 2.5 |
| | 2500.0 | | | | 58 | SMA1-2500 | 400 | 2.5 |
| | 3200.0 | | | | 70 | SMA1-3200 | 400 | 2.5 |
| | 4000.0 | | | | 84 | SMA1-4000 | 400 | 2.5 |

**DF = Design Factor

¹⁾Pressure shown = item deliverable

$$\frac{PN \text{ (bar)}}{10} = PN \text{ (MPa)}$$

*Please add the **suffixes** below according to the material/surface required.

| Order code suffixes | | | |
|---------------------------------|-----------------------------|-------------|---|
| Material | Suffix surface and material | Example | Standard sealing material (no additional suffix needed) |
| Steel, zinc plated, Cr(VI)-free | CF | MAV1/4MA1CF | NBR |

Note hoses with small diameter:

- Min. bending radius r = 20 mm
- Working temperature -20 °C up to 100 °C (short time to +120 °C)
- Hoses are to be protected from fire, from sharp-corners and hot objects.

Temperature factor of pressure rating:

| | |
|------------|-------|
| up to 0 °C | 122 % |
| for 30 °C | 110 % |
| for 50 °C | 100 % |
| for 80 °C | 86 % |
| for 100 °C | 77 % |

For measuring with liquid pressure media please note:

Bleed before connecting tube! By capillary action discharge of the pressure medium is prevented widely.



Parker SensoControl® Test Points

EMA3 Test Point with threaded connection M 16×2
Series 3

Male thread: BSP, metric

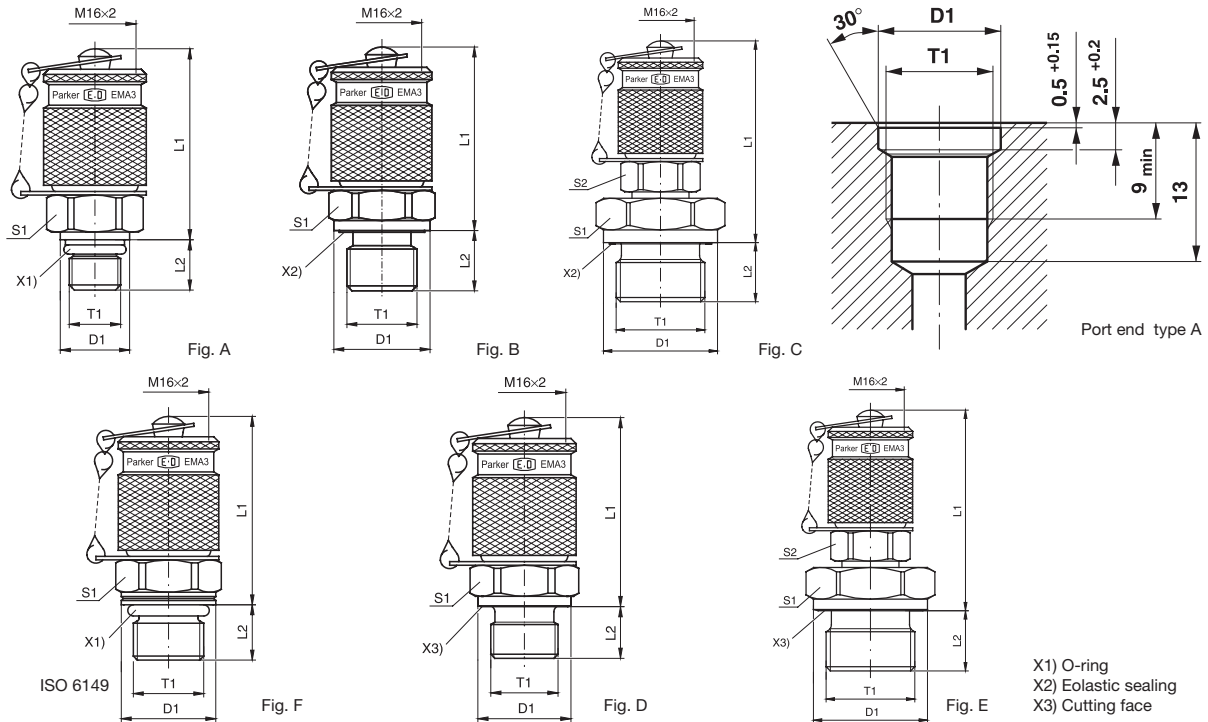

| T1 | D1 | L1 | L2 | S1 | S2 | Fig. | Weight g/1 piece | Order code* | PN (bar) ¹⁾ | | DF** | |
|----------|------|------|------|----|----|------|---------------------|-----------------------|------------------------|-----|------|----|
| | | | | | | | | | CF | 71 | CF | 71 |
| M 08×1.0 | 9.5 | 38.5 | 7.5 | 17 | | A | 66 | EMA3/8X1OR | 250 | | 4.0 | |
| M 10×1.0 | 11.5 | 37.0 | 7.5 | 17 | | A | 70 | EMA3/10X1OR | 630 | 630 | 4.0 | 4 |
| M 14×1.5 | 18.8 | 39.5 | 11.0 | 19 | | F | 79 | EMA3/14X1.5ISO | 630 | 630 | 4.0 | 4 |
| M 10×1.0 | 14.0 | 40.0 | 8.0 | 17 | | D | 67 | EMA3/10X1 | 400 | | 4.0 | |
| M 12×1.5 | 17.0 | 38.0 | 12.0 | 17 | | D | 74 | EMA3/12X1.5 | 400 | | 4.0 | |
| M 14×1.5 | 19.0 | 39.0 | 12.0 | 19 | | D | 78 | EMA3/14X1.5 | 400 | | 4.0 | |
| M 16×1.5 | 21.0 | 40.0 | 12.0 | 22 | | D | 90 | EMA3/16X1.5 | 400 | | 4.0 | |
| G 1/8 | 14.0 | 37.5 | 8.0 | 17 | | D | 70 | EMA3/1/8 | 400 | | 4.0 | |
| G 1/4 | 18.0 | 39.0 | 12.0 | 19 | | D | 77 | EMA3/1/4 | 400 | | 4.0 | |
| G 3/8 | 22.0 | 40.5 | 12.0 | 22 | | D | 91 | EMA3/3/8 | 400 | | 4.0 | |
| G 1/2 | 26.0 | 46.0 | 14.0 | 27 | 17 | E | 137 | EMA3/1/2 | 400 | | 3.4 | |
| G 1/8 | 14.0 | 37.5 | 8.0 | 17 | | B | 72 | EMA3/1/8ED | 400 | 400 | 4.0 | 4 |
| G 1/4 | 19.0 | 39.0 | 12.0 | 19 | | B | 76 | EMA3/1/4ED | 630 | 630 | 4.0 | 4 |
| G 3/8 | 22.0 | 40.5 | 12.0 | 22 | | B | 93 | EMA3/3/8ED | 630 | 630 | 4.0 | 4 |
| M 10×1.0 | 14.0 | 40.0 | 8.0 | 17 | | B | 71 | EMA3/10X1ED | 400 | 400 | 4.0 | 4 |
| M 12×1.5 | 17.0 | 38.0 | 12.0 | 17 | | B | 72 | EMA3/12X1.5ED | 630 | 630 | 4.0 | 4 |
| M 14×1.5 | 19.0 | 39.0 | 12.0 | 19 | | B | 77 | EMA3/14X1.5ED | 400 | 400 | 4.0 | 4 |
| G 1/2 | 27.0 | 46.0 | 14.0 | 27 | 17 | C | 135 | EMA3/1/2ED | 400 | 400 | 4.0 | 4 |

**DF = Design Factor

¹⁾Pressure shown = item deliverable

$$\frac{\text{PN (bar)}}{10} = \text{PN (MPa)}$$

 *Please add the **suffixes** below according to the material/surface required.

| Order code suffixes | | | |
|---------------------------------|-----------------------------|----------------|---|
| Material | Suffix surface and material | Example | Standard sealing material (no additional suffix needed) |
| Steel, zinc plated, Cr(VI)-free | CF | EMA3/10X10ORCF | NBR |
| Stainless Steel | 71 | EMA3/10X10OR71 | VIT |
| Stainless Steel | 316L | EMA3/1/4ED316L | NBR |



GMA3 Straight Test Point with threaded connection M 16×2

Series 3

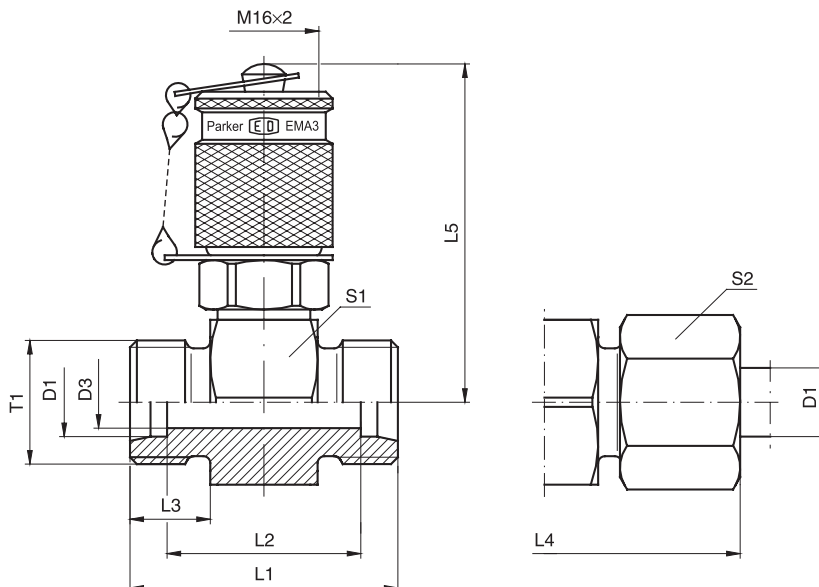

| Series | D1 | T1 | D3 | L1 | L2 | L3 | L4 | L5 | S1 | S2 | Weight g/1 piece | Order code* | PN (bar) ¹⁾ | | DF** | |
|-----------------|----------|----------|----|----|----|----|------|------|----|-----|---------------------|--------------------|------------------------|-----|------|----|
| | | | | | | | | | | | | | CF | 71 | CF | 71 |
| L ³⁾ | 06 | M 12×1.5 | 4 | 35 | 21 | 10 | 51 | 49.0 | 24 | 14 | 126 | GMA3/06LOMD | 315 | 315 | 4 | 4 |
| | 08 | M 14×1.5 | 6 | 35 | 21 | 10 | 51 | 49.0 | 24 | 17 | 128 | GMA3/08LOMD | 315 | 315 | 4 | 4 |
| | 10 | M 16×1.5 | 7 | 37 | 23 | 11 | 53 | 49.0 | 24 | 19 | 132 | GMA3/10LOMD | 315 | 315 | 4 | 4 |
| | 12 | M 18×1.5 | 8 | 37 | 23 | 11 | 53 | 50.5 | 27 | 22 | 145 | GMA3/12LOMD | 315 | 315 | 4 | 4 |
| | 15 | M 22×1.5 | 11 | 39 | 25 | 12 | 55 | 52.0 | 30 | 27 | 174 | GMA3/15LOMD | 315 | 315 | 4 | 4 |
| | 18 | M 26×1.5 | 14 | 39 | 24 | 12 | 57 | 53.0 | 32 | 32 | 192 | GMA3/18LOMD | 315 | 315 | 4 | 4 |
| | 22 | M 30×2.0 | 18 | 43 | 28 | 14 | 61 | 55.0 | 36 | 36 | 220 | GMA3/22LOMD | 160 | 160 | 4 | 4 |
| | 28 | M 36×2.0 | 23 | 43 | 28 | 14 | 61 | 57.5 | 41 | 41 | 259 | GMA3/28LOMD | 160 | 160 | 4 | 4 |
| | 35 | M 45×2.0 | 30 | 47 | 26 | 16 | 69 | 60.0 | 46 | 50 | 363 | GMA3/35LOMD | 160 | 160 | 4 | 4 |
| 42 | M 52×2.0 | 36 | 47 | 25 | 16 | 71 | 64.5 | 55 | 60 | 419 | GMA3/42LOMD | 160 | 160 | 4 | 4 | |
| S ⁴⁾ | 06 | M 14×1.5 | 4 | 39 | 25 | 12 | 55 | 49.0 | 24 | 17 | 137 | GMA3/06SOMD | 630 | 630 | 4 | 4 |
| | 08 | M 16×1.5 | 5 | 39 | 25 | 12 | 55 | 49.0 | 24 | 19 | 141 | GMA3/08SOMD | 630 | 630 | 4 | 4 |
| | 10 | M 18×1.5 | 7 | 39 | 24 | 12 | 57 | 49.0 | 24 | 22 | 141 | GMA3/10SOMD | 630 | 630 | 4 | 4 |
| | 12 | M 20×1.5 | 7 | 39 | 24 | 12 | 57 | 49.0 | 24 | 24 | 150 | GMA3/12SOMD | 630 | 630 | 4 | 4 |
| | 14 | M 22×1.5 | 10 | 43 | 27 | 14 | 63 | 50.5 | 27 | 27 | 172 | GMA3/14SOMD | 630 | 630 | 4 | 4 |
| | 16 | M 24×1.5 | 11 | 43 | 26 | 14 | 63 | 52.0 | 30 | 30 | 195 | GMA3/16SOMD | 400 | 400 | 4 | 4 |
| | 20 | M 30×2.0 | 15 | 47 | 26 | 16 | 69 | 55.0 | 36 | 36 | 254 | GMA3/20SOMD | 400 | 400 | 4 | 4 |
| | 25 | M 36×2.0 | 20 | 51 | 27 | 18 | 75 | 57.5 | 41 | 46 | 329 | GMA3/25SOMD | 400 | 400 | 4 | 4 |
| | 30 | M 42×2.0 | 25 | 55 | 28 | 20 | 81 | 60.0 | 46 | 50 | 412 | GMA3/30SOMD | 400 | 400 | 4 | 4 |
| | 38 | M 52×2.0 | 32 | 61 | 29 | 22 | 91 | 64.5 | 55 | 60 | 616 | GMA3/38SOMD | 315 | 315 | 4 | 4 |

**DF = Design Factor

¹⁾Pressure shown = item deliverable

³⁾L = light series; ⁴⁾S = heavy series

$$\frac{PN \text{ (bar)}}{10} = PN \text{ (MPa)}$$

Delivery without nut and ring.

Information on ordering complete fittings or alternative sealing materials see page 17.

*Please add the **suffixes** below according to the material/surface required.

| Order code suffixes | | | |
|---------------------------------|-----------------------------|---------------|---|
| Material | Suffix surface and material | Example | Standard sealing material (no additional suffix needed) |
| Steel, zinc plated, Cr(VI)-free | CF | GMA3/06LOMDCF | NBR |
| Stainless Steel | 71 | GMA3/06LOMD71 | VIT |



Parker SensoControl® Test Points

VKA3 Test Point for cones with threaded connection M 16×2 Series 3

With 24° cone swivel nut connection

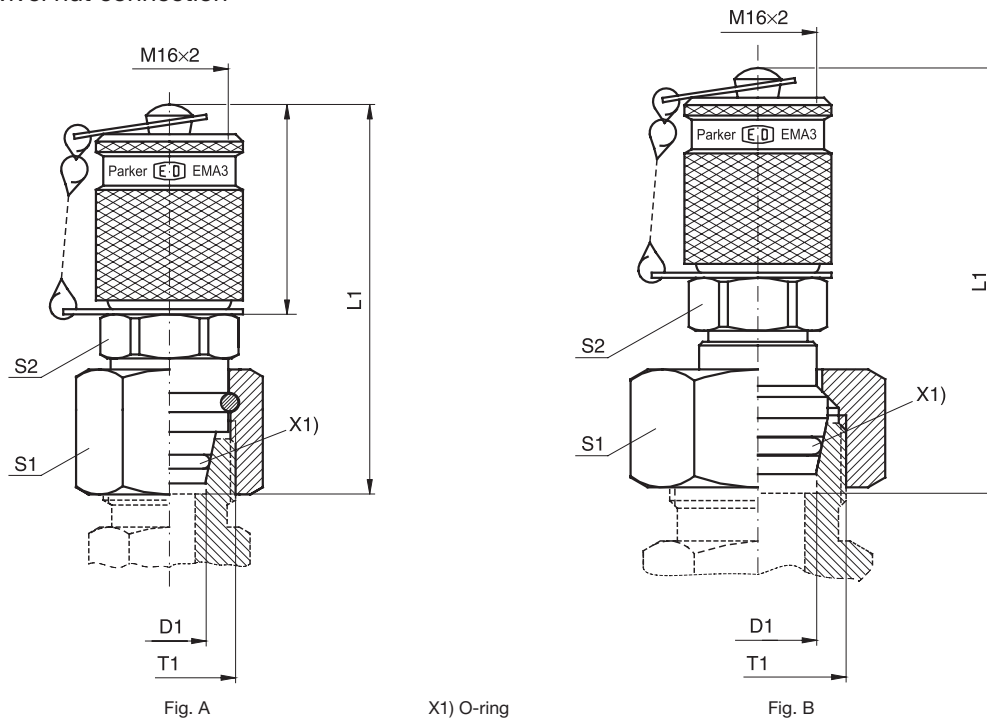

| Series | D1 | T1 | L1 | S1 | S2 | Fig. | Weight g/1 piece | Order code* | PN (bar) ¹⁾ | | DF** | |
|-----------------|----|----------|----|----|----|------|---------------------|-------------|------------------------|-----|------|----|
| | | | | | | | | | CF | 71 | CF | 71 |
| L ³⁾ | 06 | M 12×1.5 | 55 | 14 | 17 | A | 82 | VKA3/06L | 315 | 315 | 4 | 4 |
| | 08 | M 14×1.5 | 51 | 17 | 17 | A | 82 | VKA3/08L | 315 | 315 | 4 | 4 |
| | 10 | M 16×1.5 | 53 | 19 | 17 | A | 93 | VKA3/10L | 315 | 315 | 4 | 4 |
| | 12 | M 18×1.5 | 53 | 22 | 17 | A | 107 | VKA3/12L | 315 | 315 | 4 | 4 |
| | 15 | M 22×1.5 | 59 | 27 | 17 | B | 133 | VKA3/15L | 315 | 315 | 4 | 4 |
| | 18 | M 26×1.5 | 59 | 32 | 17 | B | 163 | VKA3/18L | 315 | 315 | 4 | 4 |
| | 22 | M 30×2.0 | 60 | 36 | 17 | B | 205 | VKA3/22L | 160 | 160 | 4 | 4 |
| | 28 | M 36×2.0 | 64 | 41 | 17 | B | 269 | VKA3/28L | 160 | 160 | 4 | 4 |
| | 35 | M 45×2.0 | 71 | 50 | 17 | B | 411 | VKA3/35L | 160 | 160 | 4 | 4 |
| | 42 | M 52×2.0 | 72 | 60 | 17 | B | 592 | VKA3/42L | 160 | 160 | 4 | 4 |
| S ⁴⁾ | 06 | M 14×1.5 | 50 | 17 | 17 | A | 81 | VKA3/06S | 630 | 630 | 4 | 4 |
| | 08 | M 16×1.5 | 52 | 19 | 17 | A | 88 | VKA3/08S | 630 | 630 | 4 | 4 |
| | 10 | M 18×1.5 | 53 | 22 | 17 | A | 99 | VKA3/10S | 630 | 630 | 4 | 4 |
| | 12 | M 20×1.5 | 54 | 24 | 19 | A | 121 | VKA3/12S | 630 | 630 | 4 | 4 |
| | 14 | M 22×1.5 | 59 | 27 | 17 | B | 136 | VKA3/14S | 630 | 630 | 4 | 4 |
| | 16 | M 24×1.5 | 58 | 30 | 17 | B | 156 | VKA3/16S | 400 | 400 | 4 | 4 |
| | 20 | M 30×2.0 | 65 | 36 | 17 | B | 223 | VKA3/20S | 400 | 400 | 4 | 4 |
| | 25 | M 36×2.0 | 68 | 46 | 17 | B | 367 | VKA3/25S | 400 | 400 | 4 | 4 |
| | 30 | M 42×2.0 | 74 | 50 | 17 | B | 444 | VKA3/30S | 400 | 400 | 4 | 4 |
| | 38 | M 52×2.0 | 81 | 60 | 17 | B | 655 | VKA3/38S | 315 | 315 | 4 | 4 |

**DF = Design Factor

¹⁾ Pressure shown = item deliverable

³⁾ L = light series; ⁴⁾ S = heavy series

 PN (bar)
 10 = PN (MPa)

 *Please add the **suffixes**
 below according to the material/
 surface required.

| Order code suffixes | | | |
|---------------------------------|-----------------------------|------------|---|
| Material | Suffix surface and material | Example | Standard sealing material (no additional suffix needed) |
| Steel, zinc plated, Cr(VI)-free | CF | VKA3/06LCF | NBR |
| Stainless Steel | 71 | VKA3/06L71 | VIT |



MAV...MA3 Test point pressure gauge connector with threaded connection M 16×2
MAVMD...MA3 Test point with threaded connection M 16×2
SMA3 Test point high pressure hose with threaded connection M 16×2 **Series 3**

Female thread: BSP
 Sealing: sealing ring DIN 16258*

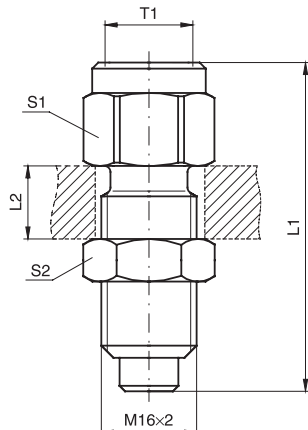

Pressure gauge connector:
MAV...MA3

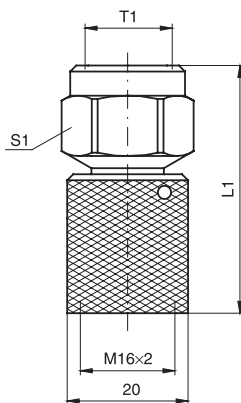

Gauge-Direct-Connector:
MAVMD...MA3

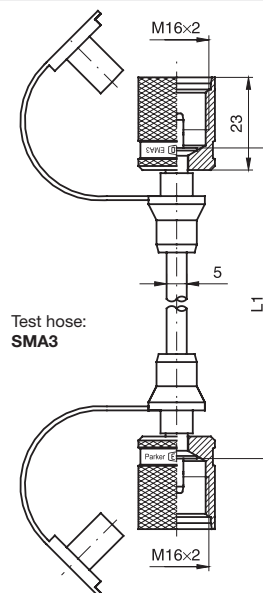

Test hose:
SMA3

| T1 | L1 | L2 max. | S1 | S2 | Weight g/1 piece | Order code* | PN (bar) ¹⁾ CF | DF** |
|-------|--------|---------|----|----|------------------|--------------------|------------------------------|------|
| G 1/4 | 54.0 | 12 | 19 | 19 | 74 | MAV1/4MA3 | 630 | 4.0 |
| G 1/2 | 64.0 | 12 | 27 | 19 | 129 | MAV1/2MA3 | 630 | 4.0 |
| G 1/4 | 41.0 | | 19 | | 61 | MAVMD1/4MA3 | 630 | 4.0 |
| G 1/2 | 51.5 | | 27 | | 103 | MAVMD1/2MA3 | 630 | 4.0 |
| | 200.0 | | | | 73 | SMA3-200 | 630 | 2.5 |
| | 300.0 | | | | 74 | SMA3-300 | 630 | 2.5 |
| | 400.0 | | | | 74 | SMA3-400 | 630 | 2.5 |
| | 630.0 | | | | 79 | SMA3-630 | 630 | 2.5 |
| | 800.0 | | | | 83 | SMA3-800 | 630 | 2.5 |
| | 1000.0 | | | | 87 | SMA3-1000 | 630 | 2.5 |
| | 1500.0 | | | | 95 | SMA3-1500 | 630 | 2.5 |
| | 2000.0 | | | | 105 | SMA3-2000 | 630 | 2.5 |
| | 2500.0 | | | | 110 | SMA3-2500 | 630 | 2.5 |
| | 3200.0 | | | | 125 | SMA3-3200 | 630 | 2.5 |
| | 4000.0 | | | | 137 | SMA3-4000 | 630 | 2.5 |

**DF = Design Factor

¹⁾ Pressure shown = item deliverable

$$\frac{\text{PN (bar)}}{10} = \text{PN (MPa)}$$

*Please add the **suffixes** below according to the material/surface required.

| Order code suffixes | | | |
|---------------------------------|-----------------------------|-------------|---|
| Material | Suffix surface and material | Example | Standard sealing material (no additional suffix needed) |
| Steel, zinc plated, Cr(VI)-free | CF | MAV1/4MA3CF | NBR |

* Sealing rings according to DIN 16258 for steel design of copper, for stainless steel design of stainless steel.

Note hoses with small diameter:

- Min. bending radius r = 20 mm
- Working temperature -20 °C up to 100 °C (short time to +120 °C)
- Hoses are to be protected from fire, from sharp-corners and hot objects.

For measuring with liquid pressure media please note:

Bleed before connecting tube! By capillary action discharge of the pressure medium is prevented widely.

Temperature factor of pressure rating:

| | |
|------------|-------|
| up to 0 °C | 122 % |
| for 30 °C | 110 % |
| for 50 °C | 100 % |
| for 80 °C | 86 % |
| for 100 °C | 77 % |



Parker SensoControl® Diagnostic Products

ServiceJunior



The **ServiceJunior** enables the measurement and display of pressures in a single device. Thanks to the four-digit display, the measurement values are displayed more accurately. Pressure peaks are securely recorded with a sampling rate of 10 ms.

The **ServiceJunior** is characterized by its easy use. With its convincing price-performance ratio, the device offers all the advantages of digital pressure measurement. The measurement of MIN and MAX values enables pressure peaks to be recorded.

Device features:

- Digital pressure measurement and backlit display
- Accuracy $\pm 0.1-0.5$ % FS (FullScale)
- Display with a bar chart (drag indicator) using the peak hold function
- Pressure peak measurement with 10 ms sampling rate
- Easy operation
- Robust and reliable
- Rotating

Parker Serviceman Plus



The new **Parker Serviceman Plus** is a mobile, extremely robust and easy-to-use measurement instrument for numerous measurement tasks in mobile hydraulics and stationary hydraulic plants.

Thanks to the automatic sensor recognition, you can simply clip in pressure, temperature, flow rate and speed sensors and start measurements immediately. No tedious sensor parameterizing required, the measuring ranges are automatically scaled and the measurement unit is shown in the display.

Device features:

- Easy operation
- Robust design with oil-resistant rubber protection
- Plug-&-Play functionality
- Large back-lit display
- New storage concept with a Nano USB stick
- Incl. PC software SensoWin®
- Can be delivered in 2 versions: analog or CAN

Catalogue 4054

Catalogue 4054



R12

Catalogue 4100/UK

Parker SensoControl® Diagnostic Products

 The Parker Service Master *Easy*

The Parker Service Master *Easy* is a multi-channel portable measurement instrument for the simultaneous measurement of important hydraulic units:

It can measure, display, store and process all hydraulic parameters such as pressure, differential pressure, temperature, rotation speed, flow rate and hydraulic performance.

In order to meet the requirements of both modern industry hydraulics and complex mobile hydraulics, different versions are available to the user.

Device features:

- 3-channel and 4-channel versions
- Easy to use thanks to automatic sensor recognition
- PC connection
- Measuring channels
- Integrated memory
- Trigger storage
- Incl. PC software SensoWin®

 The Parker Service Master *Plus*

In machine, plant and vehicle construction, the implementation possibilities of hydraulics are constantly increasing through the combination of hydraulics and electronics. The Parker Service Master *Plus* meets the demands of this development. It has never been easier to measure, display and analyze complex processes. The tried and tested storage process is particularly targeted at the measurement of MIN and MAX values and, in combination with various display options, offers analysis possibilities for problem solving.

Device features:

- Portable multi-function measuring instrument
- Measure, monitor and analyze pressure, temperature, volumetric flow rate and rotation speed.
- Measurements and displays from 26 sensors
- Presentation of measurement values as figures, bars, pointer and curves
- Project templates stored and loaded
- Interfaces: CAN, LAN, USB
- Storage of all measurement values for more than 1 billion values.
- Measurement data (automated recording, storage and analysis via LAN and USB with PC software SensoWin®)

R

Catalogue 4054

Catalogue 4054



R13

Catalogue 4100/UK

Parker SensoControl® Diagnostic Products

PC software SensoWin®



PC software **SensoWin®** is an easy-to-use aid for importing and editing the measurement curves recorded by the **Parker Serviceman Plus**, **The Parker Service Master Easy** or **The Parker Service Master Plus**.

Documentation and certificates are easily and cheaply issued, as PC software **SensoWin®** can serve all possibilities and advantages of Windows.

Device features:

- Easy operation
- Compatible with Windows 2000/XP/VISTA/7 (32- und 64-bit)
- Zoom function
- Conjunction of measurement curves
- Tabular view of measurement values
- Calculation of extreme values
- Cursor function
- Transmission of measurement procedures and documentation print-out
- Export function
- Online measurement

Test-Kit SCJN



Thanks to the **ServiceJunior-Test-Kit**, you can easily check manometers and pressure sensors, configure pressure switches and much more besides.

The Kit consists of a hand pump, with a choice of hydraulic or pneumatic, to produce a definite control pressure, and of a **ServiceJunior** as a reference device. Air, water and oil are used as pressure media.

Device features:

- Easy production of control pressures and adjustment of:
 - manometers
 - pressure sensors
 - pressure switches
 - safety valves
- Also suitable for portable use
- Pneumatic version from -0.95 - 60 bar and hydraulic version from 0 - 700 bar
- No additional power supply required
- Comprehensive adaptor set included

Catalogue 4054

Catalogue 4054



R14

Catalogue 4100/UK

SCMA-FCU-600 Frequency Measurement

With the **SCMA-FCU-600** frequency signals such as turbines, flowmeters and speed sensors with a frequency output can be connected to our portable measuring instruments. Sinusoidal or squarewave signals from 1 Hz to 5 Hz can be processed with a signal amplitude of 40 mV to 10 V. Configuration through USB and PC software.

• Power supply for external sensor

With the **SCMA-FCU-600**, external sensors can be supplied with a voltage of 24 V.

• Analog and CAN outlet

The SCMA-FCU-600 can be connected to the analog or CAN input of our measuring instruments, as desired.

SCMA-VADC-600

Signals such as 0/4...20 mA or 0...10 V from other sensors e. g. for torque, force or displacement, can be connected to our portable measuring instruments

Applications:

- Force/displacement diagram
- Torque-volumetric flow rate characteristic curve

• Current/voltage measurement

Electric currents up to 4 ADC and voltage up to 48 VDC can be measured with this module.

Applications:

- Current consumption at proportional valve
- Measurement of switching states of motors/pumps

R

SCP Pressure Measurement - Analog



Quick response times guarantee a quick identification of disturbing pressure peaks in the hydraulic system. The robust stainless steel construction allows a variety of applications, e. g. in hydraulics, for cooling water or in compressed air systems.

All pressure sensors are delivered with pre-assembled diagnosis adaptors (M16x2). The connection to the hydraulic system is quick and secure. Reduced assembly times.

Device features:

- Small size
- Robust stainless steel design
- Response time of 1 ms
- Pressure peaks logged
- Accuracy $\pm 0.5\%$

SCP Pressure Measurement - CAN



All the advantages of the analog SCP sensors combined with future-proof CAN bus technology. Simple wiring with the quick plug/screw connection SPEEDCON®. Plug-&-Play functionality with minimum configuration effort.

All pressure sensors are delivered with pre-assembled diagnosis adaptors (M16x2). The connection to the hydraulic system is quick and secure. Reduced assembly times.

Device features:

- Small size
- Robust stainless steel design
- Response time of 1 ms
- Pressure peaks logged
- Accuracy $\pm 0.5\%$
- Quick plug/screw connection SPEEDCON®
- Sensor identification light ring
- Suitable for long cable lengths

SCPT Pressure/Temperature Measurement - Analog



Quick response times guarantee a quick identification of disturbing pressure peaks in the hydraulic system. The robust stainless steel construction allows a variety of applications, e. g. in hydraulics, for cooling water or in compressed air systems.

All pressure sensors are delivered with pre-assembled diagnosis adaptors (M16X). The connection to the hydraulic system is quick and secure. Reduced assembly times.

Device features:

- Robust stainless steel design
- Response time of 1 ms
- Pressure peaks logged
- Accuracy $\pm 0.5\%$

SCPT Pressure/Temperature Measurement - CAN



All the advantages of the analog SCPT sensors combined with future-proof CAN bus technology. Simple wiring with the quick plug/screw connection SPEEDCON®. Plug-&-Play functionality with minimum configuration effort.

All pressure sensors are delivered with pre-assembled diagnosis adaptors (M16x2). The connection to the hydraulic system is quick and secure. Reduced assembly times.

Device features:

- Robust stainless steel design
- Response time of 1 ms
- Pressure peaks logged
- Future-proof CAN bus technology
- Simple wiring with SPEEDCON®
- Sensor identification LED
- Suitable for long cable lengths
- Accuracy $\pm 0.5\%$

R

Parker SensoControl® Diagnostic Products

SCT Temperature Measurement - Analog

SCT Temperature Measurement - CAN



Temperature measurements in hydraulics are useful for searching for faults and for avoiding damage following too high temperatures in critical components such as pumps or proportional valves.

In order to carry out a precise temperature measurement, the temperature is measured directly in the pipe or hose line.

The insertion sensors of the SCT-190 series can also be used to measure temperature in SCFT-xxx-02-02 turbine flowmeters.

Device features:

- High pressure-resistant temperature probe
- Temperature measurement up to 1000°C
- Flexible use
- Pressure peaks logged
- Screw-in or bulb sensor



Temperature measurements in hydraulics are useful for searching for faults and for avoiding damage following too high temperatures in critical components such as pumps or proportional valves.

In order to carry out a precise temperature measurement, the temperature is measured directly in the tube or hose line.

The insertion sensors of the SCT-190 series can also be used to measure temperature in SCFT-xxx-02-02 turbine flowmeters.

Device features:

- High pressure-resistant temperature probe for measuring hydraulics
- Temperature measurement up to 150°C
- Flexible use
- Insertion sensor
- Sensor identification light ring
- Accuracy $\pm 0.66\%$
- Quick plug/screw connection SPEEDCON®
- Suitable for long cable lengths

SCRPM Speed Measurement - Analog



Performance data that depends on the rotation speed, such as the delivery rate of regulated pumps, are ideally transmitted along with the pressure and the flow rate measurement of a hydraulic drive.

Contactless speed measurement (optoelectronic principle) is fast and easy to implement.

The rotation speed is measured, e. g. at a drive shaft, and shown on the measuring instrument. No adjustment needed.

Device features:

- Also for contactless rotation speed measurement
- Speed measurements up to 10,000 RPM
- With 3-m fixed cable

SCFT Turbine Flowmeter - Analog



A turbine wheel is driven by the oil flow and thus set in motion. The frequencies produced are processed by a digital electronic device. The influence of disturbing flow effects is thus compensated. With the lower flow resistance Q_R , the hydraulic circulation operates at low loss.

The turbine flowmeter is equipped with an EMA-3 quick connect coupling to measure the pressure. Oil temperatures can be directly measured from the oil flow in the turbine flowmeter. Thus, all the important measured values are gathered in one location.

Device features:

- 6 measuring ranges up to 750 l/min
- Easy assembly
- Resistant to high pressure up to 480 bar
- Low flow resistance
- Integrated pressure and temperature measurement points
- Suitable for reverse mode

R

Parker SensoControl® Diagnostic Products

SCFTT CAN Turbine Flowmeter



A turbine wheel is driven by the oil flow and thus set in motion. The frequencies produced are processed by a digital electronic device. The influence of disturbing flow effects is thus compensated. With the lower flow resistance Q_R , the hydraulic circulation operates at low loss.

The turbine flowmeter is equipped with an EMA-3 quick connect coupling to measure the pressure.

Oil temperatures are directly measured from the oil flow in the turbine flowmeter. Thus, all the important measured values are gathered in one location.

Device features:

- Turbine flowmeter with integrated temperature sensor in CAN bus technology
- 6 measuring ranges up to 750 l/min
- Easy assembly
- Resistant to high pressure up to 480 bar
- Low flow resistance
- Integrated pressure and temperature measurement points
- Suitable for reverse mode
- Simple wiring with SPEEDCON®
- Suitable for long cable lengths
- Sensor identification LED

SCLV Hydraulics Tester - Analog and CAN



Hydraulics testers test the functions of motors, pumps, valves, and hydrostatic drives. These easy-to-handle hydraulic testers can help locate faults in a hydraulic system.

Hydraulic testers can be used for a precise measurement of pressure, temperature, and flow rate when performing maintenance work on hydraulic systems and to locate the source of faults in regulated directional control valves and in the placement of valves.

The pressure loading valve with integrated bursting discs allows pressure to build up progressively to test the flow rate over the whole work area.

Device features:

- 2 measuring ranges up to 750 l/min
- Resistant to high pressure up to 480 bar
- Integrated overload protection
- Reverse mode (flow direction A-B)
- Also with a CAN bus connection
- CAN version with integrated temperature sensor
- Connections for pressure and temperature sensors possible

Catalogue 4054

Catalogue 4054



R20

Catalogue 4100/UK

SCQ Flowmeter - Analog

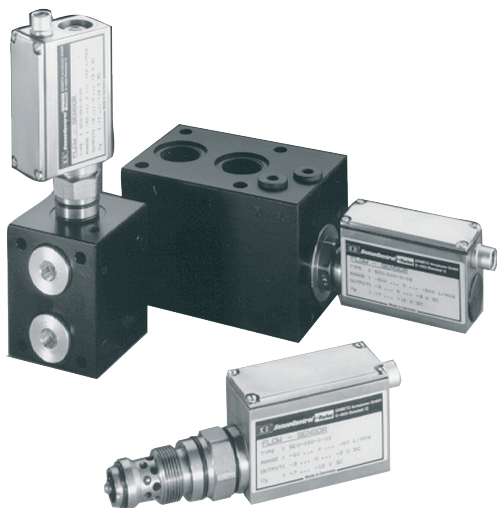

In high pressure hydraulics, a rapid identification of the rate of flow is very important. Thanks to the quick response time of the flowmeter, the dynamic behavior of hydraulic systems can be measured.

The direction indicator is helpful when searching for faults in the hydraulic system.

Quick load changes that cause damage, for example, to valves or pumps, can be identified. Assembly with the connector block allows the combined measurement of p, T, and Q. The IN-LINE adaptor for pipe or hose assembly ensures the quick integration of the flowmeter into the hydraulic system. The robust construction also permits application in extreme conditions, such as a high load change or speeds of pressure increase.

Device features:

- Spring/piston system
- Flowmeter with direction indicator
- Response time ≤ 2 ms
- Compact construction
- Pressure-resistant up to 420 bar
- Wide range of viscosity
- p, T, and Q measurements possible with connector block

SCVF Volume Counter

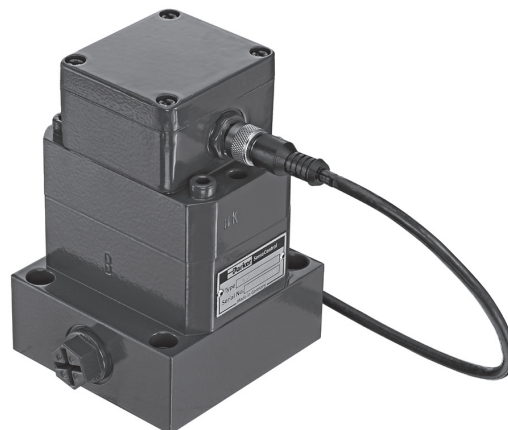

The **SCVF** is a volume counter for highly accurate flow measurements in hydraulic installations. A very precisely worked gear pair is driven by the fluid flow.

The **SCVF** works in a wide range of viscosity. Different thicknesses allow a variety of applications.

Thanks to the wide range of viscosity, all pumpable fluids with a certain degree of lubricity can be measured:

- mineral oils
- hydraulic oils
- grease
- brake fluid (EPDM sealing)
- Skydrol (special version)

If you need to gather exact flow measurements from a wide range of viscosity, the **SCVF** volume counter is the ideal solution.

Device features:

- Measurement principle: volume/gear counter
- 4 measuring ranges up to 300 l/min
- Measurement accuracy ± 0.5 % FS
- Pressure-resistant up to 400 bar
- Wide range of viscosity
- Quiet
- Exact flow measurement over a wide range of viscosity
- Flexible use of different media

R

Parker SensoControl® Automation

SCPSDi Pressure Switch



The **SCPSDi** is an electronic pressure switch with:

- Pressure display
- 2 programmable switching outputs
- Optional analog output signal
- IO-link interface
- VDMA menu navigation

The new construction concept and the resulting assembly possibilities combined with multiple connection options are the most important characteristics of the **SCPSDi**.

This unique scope of functions makes the **SCPSDi** ideal for long-term series use in industrial applications.

Device features:

- IO-Link
- VDMA menu
- ECO Mode
- Rotating >360°
- 180° reversible display
- Analog output V/mA
- Reliable operation thanks to LOCK
- Compact
- Robust
- MPa, bar, PSI
- Metal housing
- Mounting width 35 mm
- Mounting height 78 mm

Controller Family

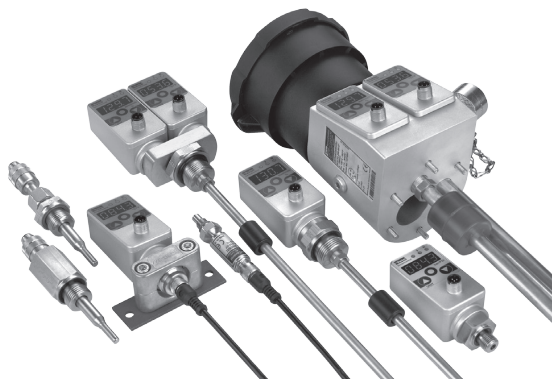

Controllers are used in control, management, and monitoring systems in which switch or analog signals or a display is/are necessary.

The controllers can replace:

- mechanical switches
- mechanical displays (manometers, thermometers, gauge-glasses)
- sensors

and combine all the functions of the above-named components in a single device.

Device features:

- Large display
- Freely adjustable
- Robust metal design
- Compact
- Long term stability
- Reliable
- Resistant to interference

Catalogue 4083

Catalogue 4083



R22

Catalogue 4100/UK

SCPSD PressureController



The PressureController combines the functions of a pressure switch, a pressure sensor, and a display unit:

- Pressure display (manometer)
- Switching outputs
- Analog signal

Simple operation, compact construction and high reliability are the most important characteristics of the PressureController. The PressureController offers exceptional technical data and optimum pressure management, combined with various assembly options. It is therefore ideal for long-term series use in industrial applications.

Each switching output can be configured individually:

- Normally open/normally closed contact
- On/off switching pressures
- Delay times
- Hysteresis/window function
- Attenuation

These comfortable switch functions enable intelligent configurations which are not possible with mechanical switches. Thus, several switches can be replaced by a single controller.

Device features:

- Compact
- Robust
- Reliable
- Easy operation
- Long term stability
- Excellent interference resistance
- Metal housing
- High protection class
- Many versions
- Rotating
- Analog output
- Password
- MPa, bar, PSI



Catalogue 4083

SCTSD TemperatureController

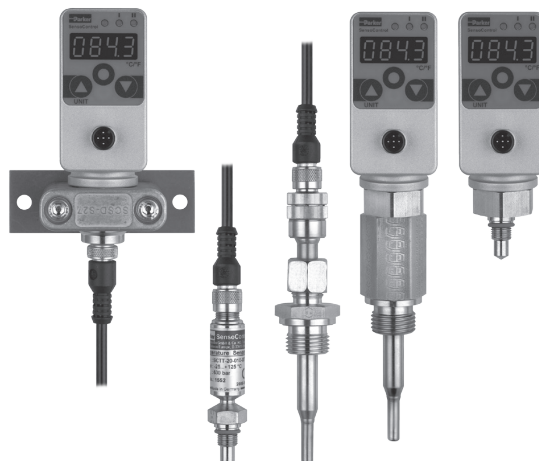

The TemperatureController combines the functions of a temperature switch, a temperature sensor, and a display unit:

- Temperature display (thermometer)
- Switching outputs
- Analog signal

Simple operation, varied functionality, and a modular design are the most important characteristics of the TemperatureController. The TemperatureController offers exceptional technical data and optimum temperature management, combined with various assembly options. It is therefore ideal when the temperature must be safely monitored and clearly displayed.

Each switching output can be configured individually:

- Normally open/normally closed contact
- On/off switching pressures
- Delay times
- Hysteresis/window function
- Time delay

These comfortable switch functions enable intelligent configurations which are not possible with mechanical switches. Thus, several switches can be replaced by a single controller.

Device features:

- Compact
- Robust
- Reliable
- Metal housing
- Modular design
- Many versions
- Analog output
- Rotating
- Password
- °C, °F



Catalogue 4083

Parker SensoControl® Automation

SCTSD-L Combination Switch



The **SCTSD-L** combination switch was devised around the requirements of hydraulic unit constructions and combines the functions of a fixed mechanical level switch with those of a configurable electronic temperature switch with a display.

Level

The tank level is measured by a highly dynamic and fully encapsulated magnetic float and switches the bistable dry reed contacts. The M12 pin assignment is compatible with conventional systems. The level contacts are firmly preset according to normal tank sizes. Two standard switching output versions are available.

Temperature

The temperature is measured via the temperature sensor and assessed by the SCTSD TemperatureController and continually displayed. These comfortable switch functions (e. g. window function) enable intelligent configurations which are not possible with mechanical temperature switches.

Device features:

- Compact construction
- Temperature display
- Individually configurable temperature switch outputs
- Small switching hysteresis
- Preset
 - for standard oils
 - for cooling
 - for shutdown (T_{max})
- Fixed level contacts
- Bistable contacts
- Preset level
 - Warning and shutdown min
 - Shutdown min/max
- Up to 1 m bar length



Catalogue 4083

SCLTSD LevelTempController

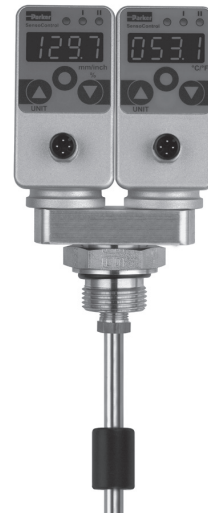

The LevelTempController enables the temperature and the level to be configured and displayed separately on the same platform. When monitoring the tank, this integration of level and temperature functionality opens up many possibilities.

The LevelTempController combines the functions of a level/temperature switch, a level/temperature sensor, and a level/temperature display:

- Level/temperature display
- Switching outputs
- Analog signal

Level

The position of the float is finely graduated (≥ 5 mm) and continually logged and shown in mm or inches in the display. The continual logging of the level means that there is no risk of individual mechanical contacts 'sticking'. This greatly increases the operational safety of the monitored installation.

Temperature

The temperature in the medium is continually logged and shown on the display. As with the LevelController, all switching outputs can be configured individually. In addition, all the comfortable switching functions are available, including the window and hysteresis functions, normally open and normally closed contacts, and an analog output for temperature.

Device features:

- Proven measurement system
- Rotating
- Level display
- mm/inch/% display
- High & low display
- Analog output
- Switching outputs
- One borehole only
- No surge pipe necessary
- Replaces several mechanical switches



Catalogue 4083

SCLSD LevelController



The LevelController combines the functions of a level switch, a level sensor, and a level display:

- Level display (gauge-glass)
- Switching outputs
- Analog signal

The LevelController is best suited for monitoring tank levels.

A variety of applications can be comfortably implemented or subsequently corrected through the menu-driven configuration of the level switching points. As the switching points no longer need to be given when ordering, the usual variability found in mechanical level switches is reduced.

Each switching output can be configured individually:

- Normally open/normally closed contact
- Higher/lower level switching point
- Delay times
- Hysteresis/window function
- Attenuation

These comfortable switch functions enable intelligent configurations which are not possible with mechanical switches. Thus, several switches can be replaced by a single controller.

Device features:

- Proven measurement system
- Level display
- mm/inch/% display
- High & low display
- Analog output
- Switching outputs
- No surge pipe necessary
- Replaces several mechanical switches
- Rotating



Catalogue 4083

SCOTC OilTankController



In addition to the LevelTempController, the OilTankController offers standardized connections for an air filter and a filling coupling.

When monitoring the tank for series use, this integration of level and temperature functionality together with air filter and fill adapter port opens up many possibilities. Only one connecting bore is needed for four functions.

The OilTankController combines the functions of a level/temperature switch, a level/temperature sensor, and a level/temperature display:

- Level/temperature display (Thermometer/gauge-glass)
- Switching outputs
- Analog signal

Each switching output can be configured individually:

A variety of applications can be comfortably implemented or subsequently corrected through the menu-driven configuration of the level switching points. As the switching points no longer need to be given when ordering, the usual variability found in mechanical level switches is reduced.

Device features:

- Proven measurement system
- Level/temperature display
- mm/inch/% display
- High & low display
- One borehole only
- Continual level measurement
- Connection
 - Filling coupling
 - Air filter
 - Negative pressure
- No surge pipe necessary



Catalogue 4083

R

Parker SensoControl® Automation

SCP01 Pressure Sensors



The **SCP01** pressure sensor was designed for the requirements of industrial applications and is used for control, management, or monitoring systems. The **SCP01** is characterized by its compact form, high linearity, and excellent interference resistance. Thanks to its speed of response, the **SCP01** is also used for rapid control processes. The compact stainless steel housing is designed for harsh ambient conditions. All parts in contact with the medium are manufactured from stainless steel and, in combination with welded thin-layer measuring cell, ensure high medium compatibility. All electronic parts are encapsulated as protection against vibrations and humidity.

An EDM hole is integrated in order to ensure an exact pressure measurement free from interference. It minimizes air cavitation and thus protects the measuring cell from any pressure blows or pressure peaks that may occur.

Thanks to its long life, high accuracy, high reliability, and robust stainless steel construction, it is the device best suited for sustained series use in hydraulic applications.

Device features:

- Small construction
- Stainless steel measuring cell
- Stainless steel housing
- Resistant to shock and vibrations
- Wide-ranging media compatibility
- High linearity
- Long term stability
- Medium temperature -40 ... 125 °C
- Up to 1000 bar
- High burst pressure
- 1 ms
- EDM-drilling
- Encapsulated electronic parts

Catalogue 4083

Pressure sensors SCP02



The **SCP02** was specially designed for use in mobile work machines. For this, the **SCP02** has received e1 approval and is manufactured with the latest manufacturing methods, in accordance with ISO/TS 16949.

Its resistance to shock and vibrations, EMC properties, power supply, and wider temperature range have been designed for this area of application.

Thanks to its speed of response, the **SCP02** can also be used for rapid control processes.

The compact stainless steel housing and the plastic plug enable use in harsh ambient conditions, such as are found in mobile hydraulics.

All parts in contact with the medium are manufactured from stainless steel (1.4548) and, in combination with the welded thin-layer measuring cell, ensure high medium compatibility.

An EDM hole is integrated in order to ensure an exact pressure measurement free from interference. It minimizes air cavitation and thus protects the measuring cell from any pressure blows or pressure peaks that may occur.

Device features:

- Small construction
- Stainless steel measuring cell
- Stainless steel housing
- Resistant to shock and vibrations
- High degree of protection
- E1 road approval
- Medium temperature -40 ... 150 °C
- Up to 1000 bar
- 1 ms
- Up to 36 V wiring systems



Catalogue 4083

SCPS01 Pressure Switch



The **SCPS01** electronic pressure switch was conceived for use in series machines.

In order to make assembly more straightforward, the pressure switches can be pre-programmed to client-specific values upon request. Time-consuming adjustments or configuration under pressure are therefore unnecessary. The system manufacturer can configure the pressure switches by software. This excludes the possibility of an unauthorized end user manipulating the switch.

The pressure switches do not contain any mechanical moving parts. All parts in contact with the medium are made out of stainless steel and, in combination with the welded thin-layer measuring cell, ensure high medium compatibility. A cushioning mechanism can be optionally integrated in the medium inlet. The stainless steel housing enables use in extremely harsh ambient conditions.

In order to ensure a wide field of use, the EMC properties and shock and vibration resistance are configured for use in mobile work machines. The e-1 approval even permits the **SCPS01** to be installed in vehicles used on public roads.

Thanks to their robust and compact construction, combined with their long-term stability and attractive price, the **SCPS01** are the alternative to mechanical pressure switches.

Device features:

- Long life
- No re-adjustment
- Engineered for harsh environments
- Precise switching



Catalogue 4083

SCP-EX Pressure Sensors



The **SCP-EX** can be configured for Zone 1 and conforms with Directive 94/9/EC. Thanks to the appropriate protective circuits, polarity reversal protection, overvoltage protection, and power dissipation limitation will be activated in the case of a fault. Its wide-reaching industrial application options are guaranteed through high accuracy and a robust and compact construction.

Various pressure transducers are available thanks to its compatibility with different mechanical and electrical connections.

For Zone 1, in which explosive atmospheres, such as a mix of inflammable compounds in the form of gas, steam, or haze and air, sometimes occur in normal operation. It is essential to adhere to the relevant national safety regulations when assembling, commissioning, and operating these pressure transducers.

Device features:

- Measuring ranges 0 ... 1000 bar
- ATEX approval for Zone 1
 - II 2G Ex ia IIC T4
- Output signal 4 ... 20 mA
- High reliability

R

Catalogue 4083

SCT-150 Temperature Sensors

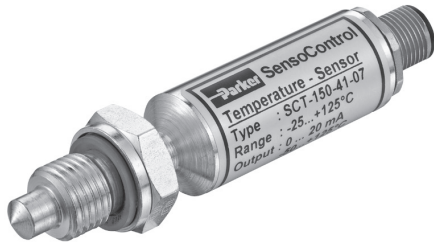

A compact construction and high pressure resistance characterize the **SCT-150** electronic temperature sensor.

If the temperature needs to be measured under high pressure and a compact construction is necessary, the **SCT** can be used.

Thanks to its pressure resistance up to 630 bar, the **SCT** temperature sensor is suited to the needs of hydraulic applications.

It performs precise and quick temperature measurements.

The temperature sensors in the **SCT** series are compatible with the **SCE** panel measuring instruments. This allows the medium temperature as well as the hydraulic pressure to be measured, controlled, and evaluated.

Device features:

- Pressure-resistant up to 630 bar
- Compact construction
- Robust steel housing
- Easy assembly
- -25 °C ... +100 °C

Catalogue 4083

SCE-020 Digital Display Unit



Multiple connections, a flexible display and numerous outlets characterize the **SCE** digital display unit. The **SCE-020** converts analog standard signals (in 0 ... 10 V to 0/4 ... 20 mA ranges) into easily understood measurement values/units.

Thus, the **SCE-020** can easily display any sensor (pressure, temperature, torque, length etc.) desired.

The display can be read from a great distance. In order to present different measuring values, the desired measurement range and the decimal point can be set easily and in a user-friendly way. Additional units are shown on a separate illuminated surface. The power supply can range from 11 to 30 VDC. An adjustable limit value can be monitored through the potential-free switching output. The analog output and the RS232 series interface can forward the signal to a corresponding peripheral device. If different measuring values need to be presented easily and in a flexible manner, the **SCE-020** display unit can be used.

Device features:

- Easily readable digital display:
 - large
 - bright
- Programmable
- Free choice of unit
- Input:
 - current 0/4 ... 20 mA
 - voltage 0 ... 10 V
 - frequency 0 ... 8 kHz
- Switching output
- Loopthrough function:
 - analog output
 - series interface
- Standard housing 96 x 48 mm

Catalogue 4083

SCK Cable



SensoControl® cables are designed according to the requirements of industrial sensors and switches.

M12 cables and M12 plugs are therefore usually

- compact
- screened
- 5-pin

5-pin design

The 5-pin cables are suitable for both 4 and 5-pin connections. 5-pin cables are fully compatible with sensor versions with 4-pin plugs.

This means that a (5-pin) cable design can always be used for pressure switches (Controller Family SCxSD & SCOTC) and sensors irrespective of the plug version and the different number of pins.

The SCK-400-xxx-x5 cables are compatible with all components with M12 plug connections.

Shielding

The screening ensures high interference resistance and operational safety.

- High EMC protection

Device features:

- One cable for everything
- Compact
- Resistant to interference
- Compatible with:
 - sensors
 - controllers
- M12 plugs
- DIN EN 175301 (connector plugs)
- Different lengths

Catalogue 4083

R



 **Ermeto Original
Tubes**

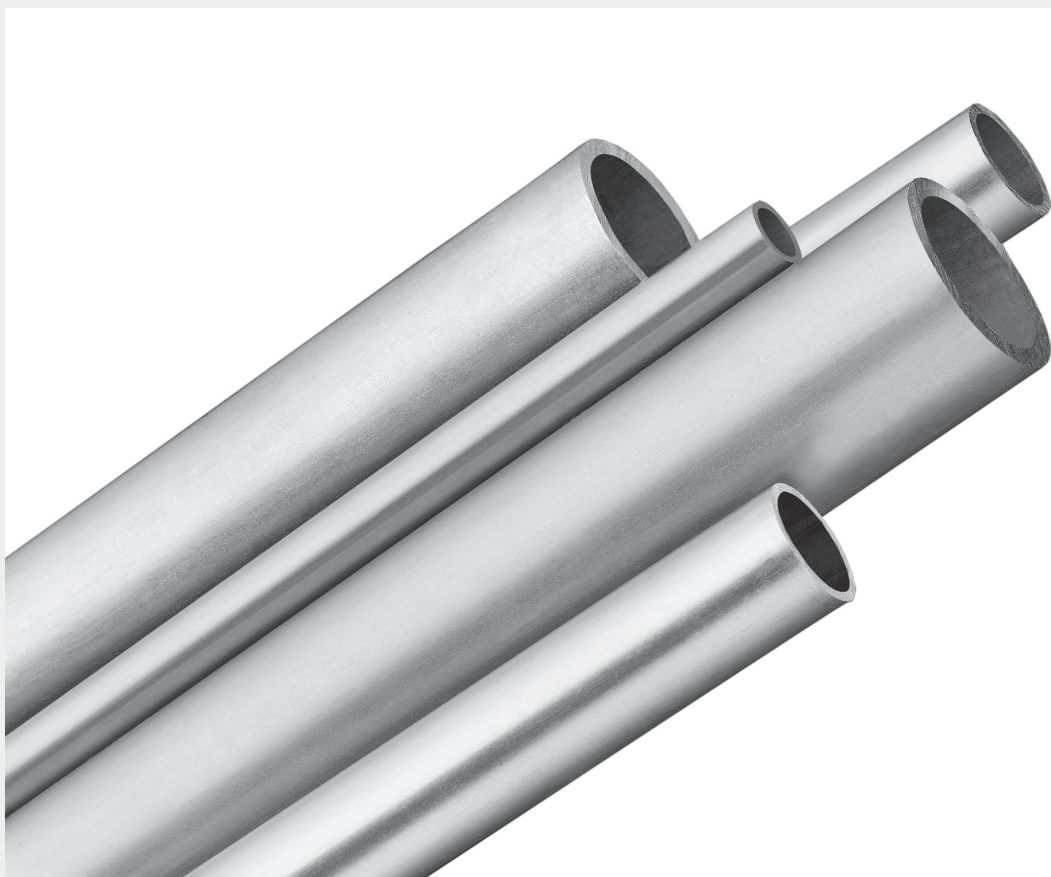

Tubes/tube bends





General recommendations for tubes

1. Steel types, mechanical properties, conditions

Steel types, mechanical properties and conditions of EO steel tubes

| Steel type | Tensile strength Rm | Yield point ReH | Ductile yield A5 (longit.) | Condition |
|--|---|---|----------------------------|--|
| Fine grain E235N acc. to EN 10305-4 (St. 37.4 acc. to DIN 1630/DIN 2391 old designation) | 340 N/mm ² min. 49,000 lb/in ² | 235 N/mm ² min. 34,000 lb/in ² | 25% min. | Seamless, cold drawn, normal annealed, DIN EN 10305-1 and -4 |

Steel types, mechanical properties and conditions of EO stainless steel tubes

| Steel type | Tensile strength Rm | Yield point (1% proof stress) | Ductile yield A5 (longit.) | Condition |
|---------------------------|---|---|----------------------------|---|
| 1.4571 X6CrNiMoTi17122 | 500 N/mm ² min. 72,500 lb/in ² | 245 N/mm ² min. 35,500 lb/in ² | 35% min. | Seamless, cold drawn free of scale, heat treated in accordance with DIN EN 10216-5 tab. 6 |

2. Tests and certifications

All tubes are subjected to a non-destructive leak test and marked accordingly as proof. This marking replaces a works certificate DIN EN 10204-2.2. Test class 1 DIN EN 10216-5 Table 7 applies for tubes made of 1.4571.

3. Recommended bend radius

A bend radius of 3x the external tube diameter is recommended for cold bending of tubes with tube benders or by hand.

4. Welding suitability and weldability

Tubes of E235N are weldable according to usual techniques. Types made of 1.4571 (stainless) are suitable for arc welding. The welding filler should be selected in accordance with DIN EN 1600 and DIN EN 12072 part 1 taking into account the type of application and the welding technique.

5. Approximate calculation of the flow resistance in straight tubelines

The flow resistance and thus the tubeline efficiency is influenced by the tube inside diameter, the volume flow (measured or calculated) and the properties of the medium. Laminar flow should be considered in order to keep losses in the system down to a minimum. The transition from laminar to turbulent flow, which brings an increase in the flow resistance is generally defined by the Reynolds number Re 2320. Since the transition cannot be pinpointed exactly, the transition range can only be determined by measuring. If, for simplified calculation, transition at Re 2320 and a "technically smooth" tube inner surface are assumed, the limit speeds $w_{crit.}$ and the laminar to turbulent flow volume flow $\dot{V}_{crit.}$ when transition takes place, can be estimated according to the following formulas:

$$w_{crit.} = \frac{2.32 \cdot \nu}{d_i} \text{ [m/s]}$$

$$q_{v, crit.} = 0.109 \cdot d_i \cdot \nu \text{ [l/min]}$$

d_i = tube bore Ø in mm

ν = kinematic viscosity in mm²/s

For approximate calculation of the pressure drop in bar/1 m tube length, the following formulas can be used:

1. Laminar range:

$$p_{v=} = \frac{0.32 \cdot w \cdot \nu \cdot \rho}{d_i^2 \cdot 10^3} = \frac{6.79 \cdot q_v \cdot \nu \cdot \rho}{d_i^4 \cdot 10^3} \text{ [bar/1 m]}$$

2. Turbulent range:

$$p_{v=} = \frac{0.281 \cdot w^{1.75} \cdot \nu^{0.25} \cdot \rho}{d_i^{1.25} \cdot 10^3} = \frac{59 \cdot q_v^{1.75} \cdot \nu^{0.25} \cdot \rho}{d_i^{4.75} \cdot 10^3} \text{ [bar/1 m]}$$

w = flow speed in m/s; ν = kinetic viscosity in mm²/s; q_v = volume flow in l/min.; ρ = density of the medium in kg/m³; d_i = pipe internal diameter in mm.

Detailed calculations of the flow resistance require an exact knowledge of the tubeline system and the operating conditions. Refer to the relevant literature for other methods of calculations.

S



Tubes/tube bends

Tube and pipe specification

Recommended carbon steel tubes and pipes

Parker recommends the use of cold drawn seamless and regular annealed (abbreviation +N) hydraulic tubes and pipes acc.: DIN-EN 10305 (old DIN 2391) and ISO 3304
For the assembly of steel fittings, steel tubes made of material E235 (ST37.4 +N) and E355 (ST52.4 +N) are recommended.

- | | |
|-----------------------------|--|
| + precision dimension/shape | + clean inside (no scale) |
| + high pressure capability | + excellent scaling surface after roll flaring |

Recommended stainless steel tubes and pipes

Parker recommends the use of seamless cold drawn stainless steel tubes and pipes acc. to: DIN EN 10216-5, ASTM A269/A213, ASTM A312.

EO precision stainless steel tube meets and exceeds these standards. The tolerances of the pipe outer diameter and wall thickness are even closer to ensure a safe interplay with our fitting systems.

For the assembly of stainless steel tube fittings, EO precision stainless steel tubes made of material 316 Ti and 316L are recommended.

- | | |
|-----------------------------|--|
| + precision dimension/shape | + excellent scaling surface after roll flaring |
| + high pressure capability | |

Welded tubes and pipes

Tubes and pipes acc. to below specification but welded and cold redrawn instead of seamless drawn are usually suitable. Pressure capability might be reduced due to the welding seam zone. Welding seam quality might effect roll flaring surface results.

Hot rolled pipes

Hot rolled pipes are not recommended for the following reasons:
Hot rolled pipes do not have precision dimensions and may slip in machine dies.
They have scales inside and outside. The inside scales effect the cleanliness level of the fluid and reduces fatigue levels. Used in roll flaring process the scales will contaminate the flaring tools (high cleaning effort) and cause poor flare surface quality.

The required maximum working pressure is calculated either acc. to DIN or DNV.

Material specifications & values

| E235+N / St.37.4 (1.0308) acc. to DIN EN 10305-4 | |
|--|-------------------------------------|
| Tensile strength | min. 340 N/mm ² |
| Yield strength | min. 235 N/mm ² |
| Fatigue strength | 225 N/mm ² ¹⁾ |
| Elongation at break | min. 25% |

| E355+N / St.52.4 (1.0580) acc. to DIN EN 10305-4 | |
|--|-------------------------------------|
| Tensile strength | min. 490 N/mm ² |
| Yield strength | min. 355 N/mm ² |
| Fatigue strength | 265 N/mm ² ²⁾ |
| Elongation at break | min. 22 % |

| 316Ti (1.4571) cold drawn (CFA) acc. to DIN EN 10216-5 | |
|--|-------------------------------------|
| Tensile strength | min. 500 N/mm ² |
| 0.2 % proof stress | min. 210 N/mm ² |
| 1 % proof stress | min. 245 N/mm ² |
| Fatigue strength | 220 N/mm ² ²⁾ |
| Elongation at break | min. 35 % |

| 316L (1.4404) cold drawn (CFA) ³⁾ acc. to DIN EN 10216-5 | |
|---|----------------------------|
| Tensile strength | min. 500 N/mm ² |
| 0.2 % proof stress | min. 210 N/mm ² |
| 1 % proof stress | min. 245 N/mm ² |
| Elongation at break | min. 35 % |

| 316L (1.4404) acc. to ASTM A269 / A213 | |
|--|----------------------------|
| Tensile strength | min. 530 N/mm ² |
| Yield strength | min. 276 N/mm ² |
| 0.2 % proof stress / 1.6 ⁴⁾ | 172.5 N/mm ² |

| 316L (1.4404) acc. to ASTM A312 / A530 | |
|--|----------------------------|
| Tensile strength | min. 515 N/mm ² |
| Yield strength | min. 234 N/mm ² |
| 0.2 % proof stress / 1.6 ⁴⁾ | 146 N/mm ² |

¹⁾ DIN 2413, 6.331

²⁾ No standard value, Experience value

³⁾ Strength increase due to cold forming following 1.4571

⁴⁾ Pressure rating calculation based on this mechanical properties require certification according to 3.1 - EN 10204 that confirms the mechanical properties.



Tube calculation for industrial and mobile applications acc. to DIN rules

DIN 2413 I, only for static load

Calculation of working pressure of steel tubes for static stress up to 120°C. Corrosion - additional allowances are not considered for the calculation of pressures. Tubes with a diameter of OD/ID > 2 are calculated for static stress in accordance with DIN 2413 III, but with K = yield strength.

$$P = \frac{20 * K * s * c}{S * D}$$

P = permissible working pressure [bar]
 K = yield strength [N/mm²]
 s = tube wall thickness [mm]
 c = factor for wall thickness allowance
 = 0.8 for Tube-OD 4-5
 = 0.85 for Tube-OD 6-8
 = 0.9 from Tube-OD 10
 = 0.9 for all stainless steel tubes
 S = Safety factor = 1.5
 D = tube outside diameter [mm]

DIN 2413 III, for dynamic load

Calculation of working pressure of steel tubes for dynamic stress up to 120°C. Corrosion - additional allowances are not considered for the calculation of pressures.

$$P = \frac{20 * K * s * c}{S * (D + s * c)}$$

P = permissible working pressure [bar]
 K = fatigue strength [N/mm²]
 s = tube wall thickness [mm]
 c = factor for wall thickness allowance
 = 0.8 for Tube-OD 4-5
 = 0.85 for Tube-OD 6-8
 = 0.9 for Tube-OD 10-80
 = 0.9 for all stainless steel tubes
 S = safety factor = 1.5
 D = tube outside diameter [mm]

Burst pressure calculation

Calculation of static burst pressure for seamless tubes acc. to Faupel-von-Mises.

$$BP = R_{p0.2} * 10^{\frac{2}{3}} * \ln \frac{D}{d} * (2 - \frac{R_{p0.2}}{R_m})$$

BP = Min. static burst pressure [bar]
 R = tensile strength [N/mm²]
 R_{p0.2} = 0.2% proof stress, yield strength [N/mm²]
 D = Tube outside diameter [mm]
 d = Tube inside diameter [mm]

Tube calculation for marine and offshore acc. to DNV rules

Calculation of working pressure of steel and stainless steel tubes for ship building acc. to DNV Part 4, Chapter 6, Section 6.

$$P = \frac{20 * \sigma_t * e * t_0}{D - t_0}$$

P = permissible working pressure [bar]
 BP = approximate burst pressure [bar]
 σ_t = permissible stress [N/mm²]
 calculated from the lower value off:

t₀ = tube wall thickness without allowances [mm]

t_n = tube wall thickness nominal [mm]

a = factor for wall thickness allowance
 = 0.8 for Tube-OD 4-5, 0.85 for Tube-OD 6-8, 0.9 for Tube-OD >=10
 = 0.875 for Schedule Pipes
 = 0.9 for all stainless steel tubes

b = bending allowance

c = corrosion tolerance, c = 0.3 mm for hydraulic steel tube, c = 0 mm for SS tubes

e = strength ratio: for seamless tubes e = 1

D = tube outside diameter [mm]

R_m = min. tensile strength [N/mm²]

K = min. yield strength or min 0.2% proof stress [N/mm²]

Calculation of burst pressure:

$$BP = \frac{20 * R_m * t_n * a}{D - t_n * a}$$

stainless steel:

$$\sigma_t = \frac{R_m}{2.7} \text{ or } \frac{K}{1.6}$$

carbon steel:

$$\sigma_t = \frac{R_m}{2.7} \text{ or } \frac{K}{1.8}$$

$$t_0 = t_n * a - c - b$$

$$b = \frac{1}{2.5} * \frac{D}{R} * t_0$$

$$b = 0.1333 * t_0 \text{ (at } R/D=3) \rightarrow t_0 = \frac{t_n * a - c}{1.1333}$$

S



Tubes/tube bends

Pressure reductions and temperatures

Required pressure reductions (depending on the material) with reference to the catalogue pressures for higher temperatures. Both metal fitting material and elastomeric sealing compound have to be selected according to the temperature range of the system.

DNV may require different pressure reduction based on application

| Material | Pressure reduction of permissible operating temperatures TB in °C | | | | | | | | | | | | | | |
|--------------------------------------|---|-----|-----|-----|-----|------|-------|-------|------|------|------|------|------|------|------|
| | -60 | -54 | -40 | -35 | -25 | +20 | +50 | +100 | +120 | +150 | +175 | +200 | +250 | +300 | +400 |
| Steel components | | | 10% | | | 0% | | | 11% | | 19% | | | | |
| Steel, tubes | | | 10% | | | 0% | | | 19% | | 27% | | | | |
| Stainless steel components | 0% | | | | | 5% | 15% | 23% | | 29% | | 33% | 37% | 42% | |
| Stainless steel, tubes | 0% | | | | | 5.5% | 11.5% | 21.5% | | 29% | | 34% | | | |
| Sealing material NBR (e.g. Perbunan) | | | | | | | | | | | | | | | |
| Sealing material FKM | | | | | | | | | | | | | | | |
| Sealing material Polyurethan (P5008) | | | | | | | | | | | | | | | |

| | |
|--|---|
| | Permissible |
| | Ambient temperature of hydraulic and pneumatic applications |
| | Temperature not permissible |

Calculation example:

Temperature = 200°C

Material = Stainless steel

Pressure reduction = 29%

Pressure reduction tubes = 21.5%

PN tube 16x2.5/71. DIN2413 III = 362 bar

Formula:

$$PN_{200^{\circ}\text{C}} = \frac{400 \text{ bar}}{100\%} \times (100\% - 29\%) = 284 \text{ bar}$$

$$PN_{\text{tube } 200^{\circ}\text{C}} = \frac{362 \text{ bar}}{100\%} \times (100\% - 21.5\%) = 284 \text{ bar}$$

Flow diameter of tube lines

Determining tube sizes for hydraulic systems

Proper tube material, type and size for a given application and type of fitting are critical for efficient and trouble-free operation of the fluid system. Selection of proper tubing involves choosing the right tube material, and determining the optimum tube size (O.D. and wall thickness).

Proper sizing of the tube for various parts of a hydraulic system results in an optimum combination of efficient and cost effective performance.

A tube that is too small causes high fluid velocity, which has many detrimental effects. In pressure lines, it causes high friction losses and turbulence, both resulting in high pressure drops and heat generation. High heat accelerates wear in moving parts and rapid aging of seals and hoses, all resulting in reduced component life. High heat generation also means wasted energy, and hence, low efficiency. Too large tubes increase system cost. Thus, optimum tube sizing is very critical. The following is a simple procedure for sizing tubes.

Determine required flow diameter

Use table to determine recommended flow diameter for the required flow rate and type of line.

The table is based on the following recommended flow rates that are common in the shipbuilding and offshore engineering.

$$\text{Pressure lines} - 3 \rightarrow 7.2 \left[\frac{\text{m}}{\text{s}} \right]$$

$$\text{Return lines} - 2 \rightarrow 4.5 \left[\frac{\text{m}}{\text{s}} \right]$$

$$\text{Suction lines} - 1 \rightarrow 1.8 \left[\frac{\text{m}}{\text{s}} \right]$$

Avoid flow rates > 8 m/s!

The resulting forces are high and can destroy the tube lines. If you desire to use different velocities than the above, use the following formula to determine the required flow diameter.

$$\text{Tube - I.D. [mm]} = 4,61 \times \sqrt{\frac{\text{Flow} \left[\frac{\text{ltr.}}{\text{min}} \right]}{\text{Velocity} \left[\frac{\text{m}}{\text{s}} \right]}}$$

Determine required wall thickness

Use tube/pressure calculation tables shown in the tube chapter to determine recommended wall thickness for the required working pressure and flow diameter of the line.

Therefore choose a working pressure which is equal or higher than the required working pressure.



Flow characteristics

Hydraulic systems are in most cases only rated with a flow velocity defined on the basis of experience. The pressure losses in lines are not taken into account, or measured later on when testing the system. As the pressure losses increase proportionally greater than the flow resistance, it is important to achieve the best rating of the system, so that they are already taken into account when planning the tube connections. Calculation is not as difficult as it is often thought, and this chapter is intended to provide a guideline. Besides, it provides information on how excessive pressure losses can be avoided, because pressure losses result in losses in performance and excessive heat. Noise occurs and possibly cavitation in suction lines.

Medium

All indication given with regard to flow restrictions and to flow properties refer exclusively to liquids. For gaseous media, the variable density of the gas must additionally be taken into account.

Units

c = Flow velocity $\left[\frac{\text{m}}{\text{s}} \right]$

d = Pipe inside diameter [m]

L = Pipe length [m]

ρ = Pressure [Pa], 1 bar = 100000 Pa

\dot{V} = Flow rate $\left[\frac{\text{m}^3}{\text{s}} \right]$, $1 \frac{\text{m}^3}{\text{s}} = 60000 \frac{\text{l}}{\text{min}}$

λ = Pipe friction factor

$\nu(T)$ = Kinematic viscosity of the medium depending on temperature $\left[\frac{\text{m}^2}{\text{s}} \right]$

$\rho(T)$ = Density of the medium depending on temperature $\left[\frac{\text{kg}}{\text{m}^3} \right]$

ζ = Individual pressure loss coefficient

Only base units have been used. This has the advantage that the formula do not contain correction factors and there is no danger of confusion, e.g. that values are used with the wrong unit. In case values are given in other units - the flow rate is e.g. often given in l/min - it is advisable to convert them into the base units before starting calculation.

Pressure losses in pipe lines

To calculate pressure losses in pipe lines, it must first be determined whether there is a laminar or a turbulent flow. Laminar flow is homogenous and without turbulence. In case of turbulent flow, the losses increase much more quickly.

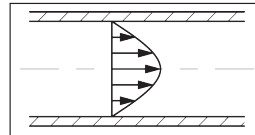

Flow profile with laminar flow

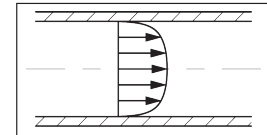

Flow profile with turbulent flow

The kind of flow is defined by the Reynolds' number. With a Reynolds' number of more than 2320, the flow changes to turbulent. The Reynolds' number is calculated according to the formula:

$$Re = \frac{c \cdot d}{\nu(T)}$$

The Reynolds' number is a non-dimensional number. The critical fluid velocity at which the flow regime can change, is thus calculated from:

$$c_{cr} = 2320 \cdot \frac{\nu(T)}{d} \left[\frac{\text{m}}{\text{s}} \right]$$

With a given flow rate, the fluid velocity can be calculated according to the formula:

$$c = \frac{\dot{V} \cdot 4}{d^2 \cdot \pi} \left[\frac{\text{m}}{\text{s}} \right]$$

Subsequently, the pipe friction factor λ can be calculated. The pipe friction factor λ is a function of the Reynolds' number and also depends on the roughness of the pipe. As hydraulically smooth pipes can generally be assumed in hydraulic applications, the pipe friction factor λ is calculated according to the following formula:

$$\text{laminar flow, } (Re < 2320): \lambda = \frac{64}{Re}$$

$$\text{turbulent flow, } (Re > 2320): \lambda = \frac{0.3164}{\sqrt[4]{Re}}$$

Finally, if all factors are known, the pressure loss in a certain pipe line can be calculated according to the formula:

$$\Delta p = \lambda \cdot \frac{L}{d} \cdot \frac{\rho(T) \cdot c^2}{2} \text{ [Pa]}$$

Calculation of individual losses

A hydraulic system does not only incorporate pipes, but also valves, fittings, pipe bends etc. that cause flow losses. These individual losses are often much higher than the pipe losses and are calculated according to the following formula:

$$\Delta p = \zeta \cdot \rho(T) \cdot \frac{c^2}{2} \text{ [Pa]}$$

S



Tubes/tube bends

Seamless EO steel tubes | Material E235+N / St.37.4 (1.0308)

Acc. to DIN EN 10305-4

1. DIN 2413 I: Tubes with a diameter of OD/ID>2 are calculated for static stress in accordance with DIN 2413 III but with K=yield strength.
2. Evaluated in Parker Lab and Test Field. () = Burst pressure (B.P.) acc. to Faupel-von-Mises

| Material E235+N / St.37.4 (1.0308) | | d _a Outer-Ø (mm) | Outer-Ø Tolerance (mm) | s Wall- thickness (mm) | d _i Inner-Ø (mm) | Design pressure | | 2 Burst pressure bar | Weight kg/m |
|---------------------------------------|------------|-----------------------------------|------------------------------|---------------------------------|-----------------------------------|-------------------------------------|-----------------------------------|-------------------------------|----------------|
| Surface Phosphated and oiled | | | | | | 1 DIN 2413 I static PN bar | DIN 2413 III dynamic PN bar | | |
| Order code | | | | | | | | | |
| R04X0.5 | R04X0.5CF | 04 | | 0.50 | 3.0 | 313 | 273 | 1160 | 0.047 |
| | R04X0.75CF | 04 | ±0.08 | 0.75 | 2.5 | 470 | 391 | 1820 | 0.063 |
| R04X1 | R04X1CF | 04 | | 1.00 | 2.0 | 627 | 500 | 2700 | 0.074 |
| | R05X1CF | 05 | ±0.08 | 1.00 | 3.0 | 501 | 414 | 2120 | 0.099 |
| | R06X0.75CF | 06 | | 0.75 | 4.5 | 333 | 288 | 1150 | 0.103 |
| R06X1 | R06X1CF | 06 | ±0.08 | 1.00 | 4.0 | 444 | 372 | 1650 | 0.123 |
| R06X1.5 | R06X1.5CF | 06 | | 1.50 | 3.0 | 666 | 526 | 2550 | 0.166 |
| | R06X2CF | 06 | | 2.00 | 2.0 | 692 | 662 | >3500 | 0.197 |
| R06X2.25 | R06X2.25CF | 06 | | 2.25 | 1.5 | 757 | 725 | >3500 | 0.208 |
| R08X1 | R08X1CF | 08 | | 1.00 | 6.0 | 333 | 288 | 1175 | 0.173 |
| R08X1.5 | R08X1.5CF | 08 | ±0.08 | 1.50 | 5.0 | 499 | 412 | 1925 | 0.240 |
| R08X2 | R08X2CF | 08 | | 2.00 | 4.0 | 666 | 526 | 2500 | 0.296 |
| | R08X2.5CF | 08 | | 2.50 | 3.0 | 658 | 630 | 2650 | 0.339 |
| R10X1 | R10X1CF | 10 | | 1.00 | 8.0 | 282 | 248 | 900 | 0.222 |
| R10X1.5 | R10X1.5CF | 10 | ±0.08 | 1.50 | 7.0 | 423 | 357 | 1450 | 0.314 |
| R10X2 | R10X2CF | 10 | | 2.00 | 6.0 | 564 | 458 | 2025 | 0.395 |
| R10X2.5 | R10X2.5CF | 10 | | 2.50 | 5.0 | 705 | 551 | 2675 | 0.462 |
| | R10X3CF | 10 | | 3.00 | 4.0 | 666 | 638 | >3500 | 0.518 |
| R12X1 | R12X1CF | 12 | | 1.00 | 10.0 | 235 | 209 | 750 | 0.271 |
| R12X1.5 | R12X1.5CF | 12 | ±0.08 | 1.50 | 9.0 | 353 | 303 | 1150 | 0.388 |
| R12X2 | R12X2CF | 12 | | 2.00 | 8.0 | 470 | 391 | 1600 | 0.493 |
| | R12X2.5CF | 12 | | 2.50 | 7.0 | 588 | 474 | 2025 | 0.586 |
| | R12X3CF | 12 | | 3.00 | 6.0 | 705 | 551 | 2600 | 0.666 |
| | R12X3.5CF | 12 | | 3.50 | 5.0 | 651 | 624 | (3109) | 0.734 |
| R14X2 | R14X1.5CF | 14 | ±0.08 | 1.50 | 11.0 | 302 | 264 | 975 | 0.462 |
| | R14X2CF | 14 | | 2.00 | 10.0 | 403 | 342 | 1325 | 0.592 |
| R14X2.5 | R14X2.5CF | 14 | | 2.50 | 9.0 | 504 | 415 | 1650 | 0.709 |
| | R14X3CF | 14 | | 3.00 | 8.0 | 604 | 485 | 2200 | 0.814 |
| R15X1 | R15X1CF | 15 | ±0.08 | 1.00 | 13.0 | 188 | 170 | 575 | 0.345 |
| R15X1.5 | R15X1.5CF | 15 | | 1.50 | 12.0 | 282 | 248 | 950 | 0.499 |
| R15X2 | R15X2CF | 15 | | 2.00 | 11.0 | 376 | 321 | 1275 | 0.641 |
| R16X1.5 | R16X1.5CF | 16 | ±0.08 | 1.50 | 13.0 | 264 | 233 | 850 | 0.536 |
| R16X2 | R16X2CF | 16 | | 2.00 | 12.0 | 353 | 303 | 1175 | 0.691 |
| R16X2.5 | R16X2.5CF | 16 | | 2.50 | 11.0 | 441 | 370 | 1500 | 0.832 |
| R16X3 | R16X3CF | 16 | | 3.00 | 10.0 | 529 | 433 | 1850 | 0.962 |
| R18X1 | R18X1CF | 18 | | 1.00 | 16.0 | 157 | 143 | 450 | 0.419 |
| R18X1.5 | R18X1.5CF | 18 | ±0.08 | 1.50 | 15.0 | 235 | 209 | 700 | 0.610 |
| R18X2 | R18X2CF | 18 | | 2.00 | 14.0 | 313 | 273 | 975 | 0.789 |
| R18X2.5 | R18X2.5CF | 18 | | 2.50 | 13.0 | 392 | 333 | 1300 | 0.956 |
| | R18X3CF | 18 | | 3.00 | 12.0 | 470 | 391 | 1575 | 1.111 |

Surface finish:

- Tubes with I.D. 1.5-5 mm: outside and inside oiled.
- Tubes from 6 mm I.D.: outside and inside phosphated and oiled.

• Cr(VI)-free:

These dimensions are externally thick coat passivated (thickness of coat 8-12µm), inside oiled.

Seamless EO steel tubes (continued) | Material E235+N / St.37.4 (1.0308)

Acc. to DIN EN 10305-4

1. DIN 2413 I: Tubes with a diameter of OD/ID>2 are calculated for static stress in accordance with DIN 2413 III but with K=yield strength.
2. Evaluated in Parker Lab and Test Field.

| Material E235+N / St.37.4 (1.0308) | | d _a Outer-Ø (mm) | Outer-Ø Tolerance (mm) | s Wall- thickness (mm) | d _i Inner-Ø (mm) | Design pressure | | 2 Burst pressure bar | Weight kg/m |
|---------------------------------------|-----------------|-----------------------------------|------------------------------|---------------------------------|-----------------------------------|-------------------------------------|-----------------------------------|-------------------------------|----------------|
| Surface Phosphated and oiled | Cr(VI)- free | | | | | 1 DIN 2413 I static PN bar | DIN 2413 III dynamic PN bar | | |
| Order code | | | | | | | | | |
| R20X2 | R20X1.5CF | 20 | ±0.08 | 1.50 | 17.0 | 212 | 190 | 675 | 0.684 |
| R20X2.5 | R20X2CF | 20 | | 2.00 | 16.0 | 282 | 248 | 900 | 0.888 |
| R20X3 | R20X2.5CF | 20 | | 2.50 | 15.0 | 353 | 303 | 1100 | 1.079 |
| | R20X3CF | 20 | | 3.00 | 14.0 | 423 | 357 | 1400 | 1.258 |
| | R20X3.5CF | 20 | | 3.50 | 13.0 | 494 | 408 | 1650 | 1.424 |
| | R20X4CF | 20 | 4.00 | 12.0 | 564 | 458 | 2000 | 1.578 | |
| R22X1.5 | R22X1.5CF | 22 | ±0.08 | 1.50 | 19.0 | 192 | 173 | 550 | 0.758 |
| R22X2 | R22X2CF | 22 | | 2.00 | 18.0 | 256 | 227 | 775 | 0.986 |
| R22X2.5 | R22X2.5CF | 22 | | 2.50 | 17.0 | 320 | 278 | 1025 | 1.202 |
| | R22X3CF | 22 | | 3.00 | 16.0 | 385 | 328 | 1175 | 1.406 |
| R25X2 | R25X2CF | 25 | ±0.08 | 2.00 | 21.0 | 226 | 201 | 725 | 1.134 |
| R25X2.5 | R25X2.5CF | 25 | | 2.50 | 20.0 | 282 | 248 | 850 | 1.387 |
| R25X3 | R25X3CF | 25 | | 3.00 | 19.0 | 338 | 292 | 1025 | 1.628 |
| R25X4 | R25X4CF | 25 | | 4.00 | 17.0 | 451 | 378 | 1500 | 2.072 |
| | R25X4.5CF | 25 | | 4.50 | 16.0 | 508 | 418 | 1625 | 2.275 |
| R28X1.5 | R28X1.5CF | 28 | ±0.08 | 1.50 | 25.0 | 151 | 138 | 425 | 0.980 |
| R28X2 | R28X2CF | 28 | | 2.00 | 24.0 | 201 | 181 | 600 | 1.282 |
| R28X2.5 | R28X2.5CF | 28 | | 2.50 | 23.0 | 252 | 223 | 750 | 1.572 |
| R28X3 | R28X3CF | 28 | | 3.00 | 22.0 | 302 | 264 | 900 | 1.850 |
| R30X2.5 | R30X2CF | 30 | ±0.08 | 2.00 | 26.0 | 188 | 170 | 575 | 1.381 |
| R30X3 | R30X2.5CF | 30 | | 2.50 | 25.0 | 235 | 209 | 725 | 1.695 |
| R30X4 | R30X3CF | 30 | | 3.00 | 24.0 | 282 | 248 | 850 | 1.998 |
| R30X5 | R30X4CF | 30 | | 4.00 | 22.0 | 376 | 321 | 1175 | 2.565 |
| | R30X5CF | 30 | | 5.00 | 20.0 | 470 | 391 | 1600 | 3.083 |
| R35X2 | R35X2CF | 35 | ±0.15 | 2.00 | 31.0 | 161 | 147 | 450 | 1.628 |
| R35X2.5 | R35X2.5CF | 35 | | 2.50 | 30.0 | 201 | 181 | 600 | 2.004 |
| R35X3 | R35X3CF | 35 | | 3.00 | 29.0 | 242 | 215 | 700 | 2.367 |
| | R35X4CF | 35 | | 4.00 | 27.0 | 322 | 280 | 960 | 3.058 |
| R38X3 | R38X2.5CF | 38 | ±0.15 | 2.50 | 33.0 | 186 | 168 | 550 | 2.189 |
| R38X4 | R38X3CF | 38 | | 3.00 | 32.0 | 223 | 199 | 675 | 2.589 |
| R38X5 | R38X4CF | 38 | | 4.00 | 30.0 | 297 | 260 | 900 | 3.354 |
| | R38X5CF | 38 | | 5.00 | 28.0 | 371 | 318 | 1150 | 4.069 |
| | R38X6CF | 38 | | 6.00 | 26.0 | 445 | 373 | 1425 | 4.735 |
| | R38X7CF | 38 | | 7.00 | 24.0 | 519 | 427 | 1700 | 5.352 |
| R42X2 | R42X2CF | 42 | ±0.20 | 2.00 | 38.0 | 134 | 123 | 375 | 1.973 |
| R42X3 | R42X3CF | 42 | | 3.00 | 36.0 | 201 | 181 | 575 | 2.885 |
| R42X4 | R42X4CF | 42 | | 4.00 | 34.0 | 269 | 237 | 850 | 3.749 |

S
Other sizes on request!



Tubes/tube bends

Seamless EO steel tubes | Material E355+N / St. 52.4 (1.0580)

Acc. to DIN EN 10305-4

1. DIN 2413 I: Tubes with a diameter of OD/ID>2 are calculated for static stress in accordance with DIN 2413 III but with K=yield strength.
2. Burst pressure (B.P.) acc. to Faupel-von-Mises

| Material E355+N / St.52.4 (1.0580) | | d _a Outer-Ø (mm) | Outer-Ø Tolerance (mm) | s Wall- thickness (mm) | d _i Inner-Ø (mm) | Design pressure | | 2 Burst pressure bar | Weight kg/m |
|---------------------------------------|-----------------|-----------------------------------|------------------------------|---------------------------------|-----------------------------------|-------------------------------------|-----------------------------------|-------------------------------|----------------|
| Surface Phosphated and oiled | Cr(VI)- free | | | | | 1 DIN 2413 I static PN bar | DIN 2413 III dynamic PN bar | | |
| Order code | | | | | | | | | |
| | R10X2ST52CF | 10 | ±0.08 | 2.00 | 6.0 | 852 | 539 | 2671 | 0.395 |
| | R12X1.5ST52CF | 12 | ±0.08 | 1.50 | 9.0 | 533 | 357 | 1504 | 0.388 |
| | R12X2ST52CF | 12 | | 2.00 | 8.0 | 710 | 461 | 2120 | 0.493 |
| | R15X1.5ST52CF | 15 | ±0.08 | 1.50 | 12.0 | 426 | 292 | 1167 | 0.499 |
| | R15X2ST52CF | 15 | | 2.00 | 11.0 | 568 | 379 | 1622 | 0.641 |
| R16X2ST52 | R16X1.5ST52CF | 16 | ±0.08 | 1.50 | 13.0 | 399 | 275 | 1086 | 0.536 |
| | R16X2ST52CF | 16 | | 2.00 | 12.0 | 533 | 357 | 1504 | 0.691 |
| | R16X2.5ST52CF | 16 | | 2.50 | 11.0 | 666 | 436 | 1959 | 0.832 |
| | R18X1.5ST52CF | 18 | ±0.08 | 1.50 | 15.0 | 355 | 247 | 953 | 0.610 |
| | R18X2ST52CF | 18 | | 2.00 | 14.0 | 473 | 321 | 1314 | 0.789 |
| | R20X2ST52CF | 20 | ±0.08 | 2.00 | 16.0 | 426 | 292 | 1167 | 0.888 |
| | R20X2.5ST52CF | 20 | | 2.50 | 15.0 | 533 | 357 | 1504 | 1.079 |
| | R20X3ST52CF | 20 | | 3.00 | 14.0 | 639 | 420 | 185 | 1.258 |
| | R22X1.5ST52CF | 22 | ±0.08 | 1.50 | 19.0 | 290 | 204 | 767 | 0.758 |
| | R22X2ST52CF | 22 | | 2.00 | 18.0 | 387 | 267 | 1049 | 0.986 |
| R25X3ST52 | R25X2.5ST52CF | 25 | ±0.08 | 2.50 | 20.0 | 426 | 292 | 1167 | 1.387 |
| | R25X3ST52CF | 25 | | 3.00 | 19.0 | 511 | 344 | 1435 | 1.628 |
| | R25X4ST52CF | 25 | | 4.00 | 17.0 | 682 | 445 | 2016 | 2.072 |
| | R28X2ST52CF | 28 | ±0.08 | 2.00 | 24.0 | 304 | 213 | 806 | 1.282 |
| R30X3ST52 | R30X3ST52CF | 30 | ±0.08 | 3.00 | 24.0 | 426 | 292 | 1167 | 1.998 |
| | R30X4ST52CF | 30 | | 4.00 | 22.0 | 568 | 379 | 1622 | 2.565 |
| | R30X5ST52CF | 30 | | 5.00 | 20.0 | 710 | 461 | 2120 | 3.083 |
| | R35X3ST52CF | 35 | ±0.15 | 3.00 | 29.0 | 365 | 253 | 983 | 2.367 |
| R38X4ST52 | R38X3ST52CF | 38 | ±0.15 | 3.00 | 32.0 | 336 | 234 | 899 | 2.589 |
| | R38X4ST52CF | 38 | | 4.00 | 30.0 | 448 | 306 | 1236 | 3.354 |
| | R38X5ST52CF | 38 | | 5.00 | 28.0 | 561 | 374 | 1597 | 4.069 |
| | R38X6ST52CF | 38 | | 6.00 | 26.0 | 673 | 440 | 1984 | 4.735 |
| | R42X3ST52CF | 42 | ±0.20 | 3.00 | 36.0 | 304 | 213 | 806 | 2.885 |
| | R42X4ST52CF | 42 | | 4.00 | 34.0 | 406 | 279 | 1105 | 3.748 |
| | R42X5ST52CF | 42 | | 5.00 | 32.0 | 507 | 342 | 1422 | 4.562 |

Surface finish:

- Tubes with I.D. 1.5-5 mm: outside and inside oiled.
- Tubes from 6 mm I.D.: outside and inside phosphated and oiled.

• Cr(VI)-free:

These dimensions are externally thick coat passivated (thickness of coat 8-12µm), inside oiled.

Other sizes on request!



Seamless EO stainless steel tubes | Material 316Ti (1.4571)

Acc. to DIN EN 10216-5, DIN EN 10305-1

1. DIN 2413 I: Tubes with a diameter of OD/ID>2 are calculated for static stress in accordance with DIN 2413 III but with K=yield strength.
2. Evaluated in Parker Lab and Test Field. () = Burst pressure (B.P.) acc. to Faupel-von-Mises

| Material 316Ti (1.4571) | d _a Outer-Ø (mm) | Outer-Ø Tolerance (mm) | s Wall- thickness (mm) | d _i Inner-Ø (mm) | Design pressure | | 2 Burst pressure bar | Weight kg/m |
|----------------------------|-----------------------------------|------------------------------|---------------------------------|-----------------------------------|--------------------------------|-------------------|-------------------------------|----------------|
| | | | | | 1 | DIN 2413 III | | |
| | | | | | DIN 2413 I static PN bar | dynamic PN bar | | |
| R04X171 | 04 | ±0.08 | 1.0 | 2.0 | 735 | 539 | (2961) | 0.075 |
| R06X171 | 06 | | 1.0 | 4.0 | 490 | 383 | 1850 | 0.125 |
| R06X1.571 | 06 | ±0.08 | 1.5 | 3.0 | 735 | 539 | 2900 | 0.169 |
| R08X171 | 08 | | 1.0 | 6.0 | 368 | 297 | 1300 | 0.175 |
| R08X1.571 | 08 | ±0.08 | 1.5 | 5.0 | 551 | 424 | 2050 | 0.244 |
| R10X171 | 10 | | 1.0 | 8.0 | 294 | 242 | 950 | 0.225 |
| R10X1.571 | 10 | ±0.08 | 1.5 | 7.0 | 441 | 349 | 1750 | 0.319 |
| R10X271 | 10 | | 2.0 | 6.0 | 588 | 447 | 2400 | 0.401 |
| R12X171 | 12 | | 1.0 | 10.0 | 245 | 205 | 850 | 0.275 |
| R12X1.571 | 12 | ±0.08 | 1.5 | 9.0 | 368 | 297 | 1400 | 0.394 |
| R12X271 | 12 | | 2.0 | 8.0 | 490 | 383 | 1900 | 0.501 |
| R14X1.571 | 14 | | 1.5 | 11.0 | 315 | 258 | 1200 | 0.469 |
| R14X271 | 14 | ±0.08 | 2.0 | 10.0 | 420 | 334 | 1550 | 0.601 |
| R14X2.571 | 14 | | 2.5 | 9.0 | 525 | 406 | 2100 | 0.720 |
| R15X171 | 15 | | 1.0 | 13.0 | 196 | 166 | 675 | 0.351 |
| R15X1.571 | 15 | ±0.08 | 1.5 | 12.0 | 294 | 242 | 1100 | 0.507 |
| R15X271 | 15 | | 2.0 | 11.0 | 392 | 314 | 1400 | 0.651 |
| R16X1.571 | 16 | | 1.5 | 13.0 | 276 | 228 | 950 | 0.545 |
| R16X271 | 16 | ±0.08 | 2.0 | 12.0 | 368 | 297 | 1300 | 0.701 |
| R16X2.571 | 16 | | 2.5 | 11.0 | 459 | 362 | 1850 | 0.845 |
| R16X371 | 16 | | 3.0 | 10.0 | 551 | 424 | 2400 | 0.977 |
| R18X1.571 | 18 | | 1.5 | 15.0 | 245 | 205 | 800 | 0.620 |
| R18X271 | 18 | ±0.08 | 2.0 | 14.0 | 327 | 267 | 1150 | 0.801 |
| R20X271 | 20 | | 2.0 | 16.0 | 294 | 242 | 1050 | 0.901 |
| R20X2.571 | 20 | ±0.08 | 2.5 | 15.0 | 368 | 297 | 1400 | 1.095 |
| R20X371 | 20 | | 3.0 | 14.0 | 441 | 349 | 1800 | 1.277 |
| R22X1.571 | 22 | | 1.5 | 19.0 | 200 | 170 | 650 | 0.770 |
| R22X271 | 22 | ±0.08 | 2.0 | 18.0 | 267 | 222 | 900 | 1.002 |
| R25X271 | 25 | | 2.0 | 21.0 | 235 | 197 | 763 | 1.152 |
| R25X2.571 | 25 | ±0.08 | 2.5 | 20.0 | 294 | 242 | 1050 | 1.408 |
| R25X371 | 25 | | 3.0 | 19.0 | 353 | 286 | 1275 | 1.653 |
| R28X1.571 | 28 | | 1.5 | 25.0 | 158 | 135 | 550 | 0.995 |
| R28X271 | 28 | ±0.08 | 2.0 | 24.0 | 210 | 177 | 700 | 1.302 |
| R28X2.571 | 28 | | 2.5 | 23.0 | 263 | 218 | (840) | 1.596 |
| R30X2.571 | 30 | | 2.5 | 25.0 | 245 | 205 | 850 | 1.722 |
| R30X371 | 30 | ±0.08 | 3.0 | 24.0 | 294 | 242 | 1150 | 2.028 |
| R30X471 | 30 | | 4.0 | 22.0 | 392 | 314 | 1500 | 2.605 |
| R35X271 | 35 | | 2.0 | 31.0 | 168 | 143 | 550 | 1.653 |
| R35X2.571 | 35 | ±0.15 | 2.5 | 30.0 | 210 | 177 | (659) | 2.035 |
| R35X371 | 35 | | 3.0 | 29.0 | 252 | 210 | (803) | 2.404 |
| R38X2.571 | 38 | | 2.5 | 33.0 | 193 | 164 | 628 | 2.222 |
| R38X471 | 38 | ±0.15 | 4.0 | 30.0 | 309 | 254 | 1150 | 3.405 |
| R42X271 | 42 | | 2.0 | 38.0 | 140 | 121 | 475 | 2.003 |
| R42X371 | 42 | ±0.20 | 3.0 | 36.0 | 210 | 177 | 750 | 2.930 |

Other sizes on request!

Tubes/tube bends



Seamless EO stainless steel tubes | Material 316L (1.4404)

Acc. to ASTM A269/A213

1. DIN 2413 I static pressure (W.P.) capability for straight pipe including manufacturing tolerance.
2. Burst pressure (B.P.) acc. to Faupel-von-Mises

| Material 316L (1.4404) | d _a Outer-Ø (mm) | Outer-Ø Tolerance (mm) | s Wall- thickness (mm) | d _i Inner-Ø (mm) | 1 Design pressure | | 2 Burst pressure bar | Weight kg/m | | |
|---------------------------|-----------------------------------|------------------------------|---------------------------------|-----------------------------------|----------------------|-----------------|-------------------------------|----------------|--------------------------------|-----------------------------------|
| | | | | | pickled | bright annealed | | | DIN 2413 I static PN bar | DIN 2413 III dynamic PN bar |
| | | | | | | | | | | |
| | R04X1-316BA | 04 | ±0.08 | 1.0 | 2.0 | 735 | 539 | 2961 | 0.075 | |
| | R06X1-316BA | 06 | ±0.08 | 1.0 | 4.0 | 490 | 383 | 1732 | 0.125 | |
| | R06X1.5-316BA | 06 | | 1.5 | 3.0 | 735 | 539 | 2961 | 0.169 | |
| | R08X1-316BA | 08 | ±0.08 | 1.0 | 6.0 | 368 | 297 | 1229 | 0.175 | |
| | R10X1-316BA | 10 | ±0.08 | 1.0 | 8.0 | 294 | 242 | 953 | 0.225 | |
| | R10X1.5-316BA | 10 | | 1.5 | 7.0 | 441 | 349 | 1524 | 0.319 | |
| | R10X2-316BA | 10 | | 2.0 | 6.0 | 588 | 447 | 2182 | 0.401 | |
| | R12X1-316BA | 12 | ±0.08 | 1.0 | 10.0 | 245 | 205 | 779 | 0.275 | |
| | R12X1.5-316BA | 12 | | 1.5 | 9.0 | 368 | 297 | 1229 | 0.394 | |
| | R12X2-316BA | 12 | | 2.0 | 8.0 | 490 | 383 | 1732 | 0.501 | |
| | R15X1.5-316BA | 15 | ±0.08 | 1.5 | 12.0 | 294 | 242 | 953 | 0.507 | |
| R16X2-316 | | 16 | ±0.08 | 2.0 | 12.0 | 368 | 297 | 1229 | 0.701 | |
| R16X2.5-316 | | 16 | | 2.5 | 11.0 | 459 | 362 | 1601 | 0.845 | |
| R18X1.5-316 | | 18 | ±0.08 | 1.5 | 15.0 | 245 | 205 | 779 | 0.620 | |
| R18X2-316 | | 18 | | 2.0 | 14.0 | 327 | 267 | 1074 | 0.801 | |
| R20X2-316 | | 20 | ±0.08 | 2.0 | 16.0 | 294 | 242 | 953 | 0.901 | |
| R20X2.5-316 | | 20 | | 2.5 | 15.0 | 368 | 297 | 1229 | 1.096 | |
| R22X2-316 | | 22 | ±0.08 | 2.0 | 18.0 | 267 | 222 | 857 | 1.002 | |
| R25X2-316 | | 25 | ±0.08 | 2.0 | 21.0 | 235 | 197 | 745 | 1.152 | |
| R25X2.5-316 | | 25 | | 2.5 | 20.0 | 294 | 242 | 953 | 1.409 | |
| R25X3-316 | | 25 | | 3.0 | 19.0 | 353 | 286 | 1172 | 1.653 | |
| R28X2-316 | | 28 | ±0.08 | 2.0 | 24.0 | 210 | 177 | 659 | 1.302 | |
| R30X2.5-316 | | 30 | ±0.08 | 2.5 | 25.0 | 245 | 205 | 779 | 1.722 | |
| R30X3-316 | | 30 | | 3.0 | 24.0 | 294 | 242 | 953 | 2.028 | |
| R35X3-316 | | 35 | ±0.15 | 3.0 | 29.0 | 252 | 210 | 803 | 2.404 | |
| R38X3-316 | | 38 | ±0.15 | 3.0 | 32.0 | 232 | 195 | 734 | 2.629 | |
| R38X4-316 | | 38 | | 4.0 | 30.0 | 309 | 254 | 1010 | 3.405 | |
| R38X5-316 | | 38 | | 5.0 | 28.0 | 387 | 311 | 1305 | 4.132 | |
| R38X6-316 | | 38 | | 6.0 | 26.0 | 464 | 365 | 1621 | 4.808 | |
| R42X3-316 | | 42 | ±0.20 | 3.0 | 36.0 | 210 | 177 | 659 | 2.930 | |

Other sizes on request!

Seamless EO stainless steel tubes | Material 316L (1.4404)

Acc. to DIN EN 10216-5, DIN EN 10305-1

1. DIN 2413 I: Tubes with a diameter of OD/ID>2 are calculated for static stress in accordance with DIN 2413 III but with K=yield strength.
2. Burst pressure (B.P.) calculation acc. to Faupel-von-Mises

| Material 316 L (1.4404) | d _a Outer-Ø (mm) | | s Wallthickness | | d Inner-Ø (mm) | 1 Design pressure | | 2 Burst pressure bar | Weight kg/m |
|----------------------------|-----------------------------------|-------|--------------------|------|----------------------|--------------------------------|-----------------------------------|-------------------------------|----------------|
| | | | | | | DIN 2413 I static PN bar | DIN 2413 III dynamic PN bar | | |
| | Surface bright annealed | Inch | mm | Inch | mm | | | | |
| Order code | | | | | | | | | |
| R1/8X0.028TP316/L | 1/8 | 3.18 | 0.028 | 0.71 | 1.76 | 659 | 492 | 2538 | 0.044 |
| R3/16X0.035TP316/L | 3/16 | 4.76 | 0.035 | 0.89 | 2.98 | 549 | 422 | 1996 | 0.086 |
| R1/4X0.035TP316/L | 1/4 | 6.35 | 0.035 | 0.89 | 4.57 | 412 | 328 | 1403 | 0.122 |
| R1/4X0.049TP316/L | | | 0.049 | 1.24 | 3.87 | 576 | 440 | 2126 | 0.159 |
| R1/4X0.065TP316/L | | | 0.065 | 1.65 | 3.05 | 619 | 556 | 3135 | 0.194 |
| R3/8X0.035TP316/L | 3/8 | 9.53 | 0.035 | 0.89 | 7.75 | 274 | 227 | 883 | 0.193 |
| R3/8X0.049TP316/L | | | 0.049 | 1.24 | 7.05 | 384 | 309 | 1294 | 0.257 |
| R3/8X0.065TP316/L | | | 0.065 | 1.65 | 6.23 | 510 | 396 | 1818 | 0.326 |
| R1/2X0.035TP316/L | 1/2 | 12.70 | 0.035 | 0.89 | 10.92 | 206 | 174 | 644 | 0.263 |
| R1/2X0.049TP316/L | | | 0.049 | 1.24 | 10.22 | 288 | 238 | 932 | 0.356 |
| R1/2X0.065TP316/L | | | 0.065 | 1.65 | 9.40 | 382 | 307 | 1286 | 0.457 |
| R1/2X0.083TP316/L | | | 0.083 | 2.11 | 8.48 | 488 | 381 | 1724 | 0.560 |
| R5/8X0.049TP316/L | 5/8 | 15.88 | 0.049 | 1.24 | 13.40 | 230 | 193 | 729 | 0.455 |
| R5/8X0.065TP316/L | | | 0.065 | 1.65 | 12.58 | 306 | 251 | 996 | 0.588 |
| R3/4X0.049TP316/L | 3/4 | 19.05 | 0.049 | 1.24 | 16.57 | 192 | 163 | 598 | 0.553 |
| R3/4X0.065TP316/L | | | 0.065 | 1.65 | 15.75 | 255 | 212 | 813 | 0.719 |
| R3/4X0.083TP316/L | | | 0.083 | 2.11 | 14.83 | 325 | 266 | 1069 | 0.895 |
| R3/4X0.095TP316/L | | | 0.095 | 2.41 | 14.23 | 372 | 300 | 1248 | 1.004 |
| R3/4X0.109TP316/L | | | 0.109 | 2.77 | 13.51 | 427 | 339 | 1467 | 1.129 |
| R1X0.065TP316/L | 1 | 25.40 | 0.065 | 1.65 | 22.10 | 191 | 162 | 595 | 0.981 |
| R1X0.083TP316/L | | | 0.083 | 2.11 | 21.18 | 244 | 204 | 775 | 1.231 |
| R1X0.095TP316/L | | | 0.095 | 2.41 | 20.58 | 279 | 231 | 900 | 1.387 |
| R1X0.126TP316/L | | | 0.126 | 3.20 | 19.00 | 370 | 299 | 1240 | 1.779 |

S
Other sizes on request!



Tubes/tube bends

Seamless EO tube bends 90° Material E235N (St. 37.4) and 1.4571

For minimum pressure loss

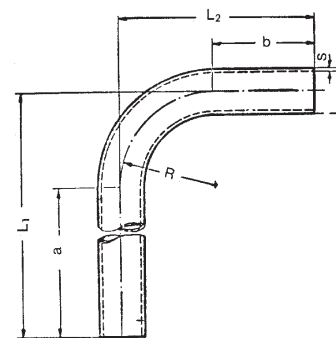

| Order code | | Tube O.D. D | Tolerance ± | Wall- thickness S | Tube I.D. mm | Bending radius R | Leg length | | Length | | Weight kg/piece |
|-------------|------------|-------------------|----------------|-------------------------|--------------------|------------------------|------------|-----|--------|-----|--------------------|
| Cr(VI)-free | 1.4571 | | | | | | a | b | L1 | L2 | |
| RB16X2CF | RB16X271 | 16 | 0.08 | 2.0 | 12 | 30 | 200 | 40 | 230 | 70 | 0.198 |
| RB18X1.5CF | RB18X1.571 | 18 | 0.08 | 1.5 | 15 | 36 | 200 | 35 | 236 | 71 | 0.178 |
| RB20X2CF | | 20 | 0.08 | 2.0 | 16 | 36 | 200 | 45 | 236 | 81 | 0.268 |
| RB20X2.5CF | RB20X2.571 | 20 | 0.08 | 2.5 | 15 | 36 | 200 | 45 | 236 | 81 | 0.326 |
| RB22X1.5CF | | 22 | 0.08 | 1.5 | 19 | 38 | 200 | 40 | 238 | 78 | 0.227 |
| RB22X2CF | RB22X271 | 22 | 0.08 | 2.0 | 18 | 38 | 200 | 40 | 238 | 78 | 0.296 |
| RB25X2CF | | 25 | 0.08 | 2.0 | 21 | 44 | 200 | 50 | 244 | 94 | 0.362 |
| RB25X2.5CF | RB25X2.571 | 25 | 0.08 | 2.5 | 20 | 44 | 200 | 50 | 244 | 94 | 0.442 |
| RB25X3CF | | 25 | 0.08 | 3.0 | 19 | 44 | 200 | 50 | 244 | 94 | 0.519 |
| RB28X1.5CF | | 28 | 0.08 | 1.5 | 25 | 48 | 200 | 50 | 248 | 98 | 0.319 |
| RB28X2CF | RB28X271 | 28 | 0.08 | 2.0 | 24 | 48 | 200 | 50 | 248 | 98 | 0.417 |
| RB28X3CF | | 28 | 0.08 | 3.0 | 22 | 48 | 200 | 50 | 248 | 98 | 0.601 |
| RB30X2.5CF | | 30 | 0.08 | 2.5 | 25 | 50 | 200 | 60 | 250 | 110 | 0.575 |
| RB30X3CF | RB30X371 | 30 | 0.08 | 3.0 | 24 | 50 | 200 | 60 | 250 | 110 | 0.677 |
| RB30X4CF | | 30 | 0.08 | 4.0 | 22 | 50 | 200 | 60 | 250 | 110 | 0.869 |
| RB35X2CF | RB35X271 | 35 | 0.15 | 2.0 | 31 | 60 | 200 | 65 | 260 | 125 | 0.586 |
| RB35X3CF | | 35 | 0.15 | 3.0 | 29 | 60 | 200 | 65 | 260 | 125 | 0.852 |
| RB38X2.5CF | | 38 | 0.15 | 2.5 | 33 | 65 | 200 | 75 | 265 | 140 | 0.827 |
| RB38X3CF | | 38 | 0.15 | 3.0 | 32 | 65 | 200 | 75 | 265 | 140 | 0.979 |
| RB38X4CF | RB38X471 | 38 | 0.15 | 4.0 | 30 | 65 | 200 | 75 | 265 | 140 | 1.268 |
| RB38X5CF | | 38 | 0.15 | 5.0 | 28 | 65 | 200 | 75 | 265 | 140 | 1.538 |
| RB42X2CF | RB42X271 | 42 | 0.20 | 2.0 | 38 | 80 | 200 | 85 | 280 | 165 | 0.809 |
| RB42X3CF | | 42 | 0.20 | 3.0 | 36 | 80 | 200 | 85 | 280 | 165 | 1.183 |
| RB50X6* | | 50 | 0.20 | 6.0 | 38 | 180 | 150 | 150 | 330 | 330 | 3.496 |
| RB65X8* | | 65 | 0.30 | 8.0 | 49 | 180 | 160 | 160 | 330 | 330 | 6.294 |

Tolerances for leg length a, b = ± 2.5 mm

For tube bends, contrary to straight tubes of the same wall thickness there is a higher stress at the inside of the bend and a reduction of the fatigue strength, because of the out-of-round of tube. Details see DIN 2413 III section 4.7.

If the elbow end is cut off to a different length, a recalibration of the tube end may be necessary.

Tube bends material E235N (St. 37.4) are phosphated and oiled. (Yellow chromated on request.)

*phosphated and oiled



EO[®] Ermeto Original *Tube clamps*

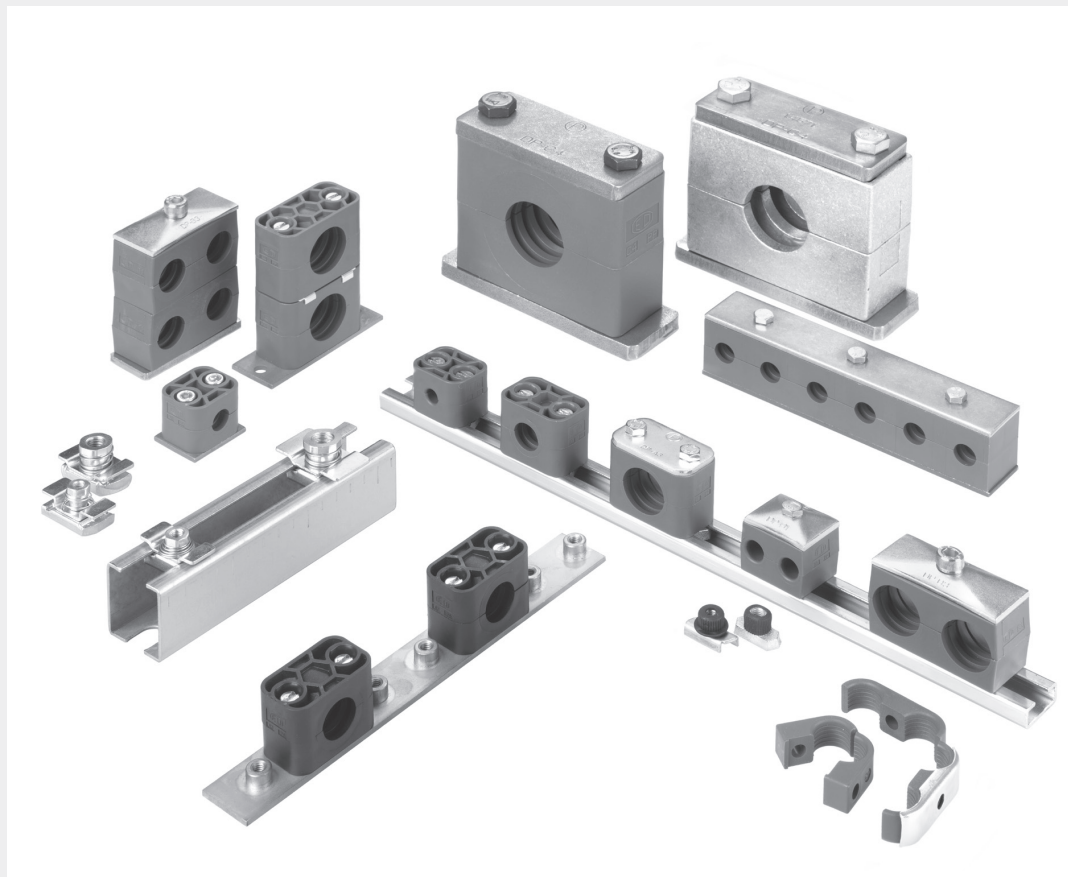



Tube clamps

Content

Technical data T3
 Material properties T4
 Special materials T5
 Assembly instruction T6

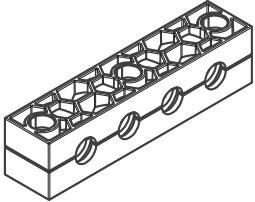
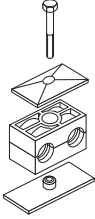
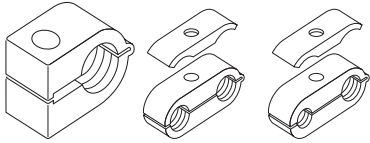
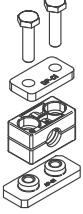
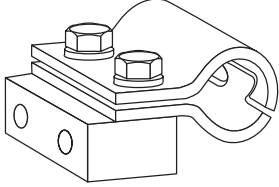
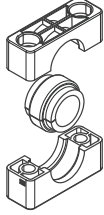
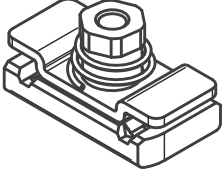
| | | | |
|---|--|-------------------------------------|--|
| Series A Light series (DIN 3015-1) |  <p>T8-T23</p> | Multiclamps |  <p>T38-T43</p> |
| Series B Double series (DIN 3015-3) |  <p>T24-T28</p> | Series O | single double  <p>T44-T45</p> |
| Series C Heavy series (DIN 3015-2) |  <p>T29-T37</p> | Hydraulic steel clamps |  <p>T46-T47</p> |
| | | Tube clamps with Elastomer inlay |  <p>T48-T50</p> |
| | | Fixed adaptor |  <p>T51-T54</p> |



Tube clamps

DIN 3015

Programme:
Tube clamps series A (according to DIN 3015 Part 1)

Available in nine standard sizes for normal mechanical requirements.

- Outer tube diameter for the metric series 4 to 101.8 mm
- Outer tube diameter for the inch-size series R 1/8" to R 3/2"
- Outer tube diameter for the imperial size series 1/4" to 4"

Accessories and construction types

Tube clamps series B (according to DIN 3015 Part 3)

Available as a twin tube clamp in five standard sizes for normal mechanical requirements.

- Outer tube diameter for the metric series 6 to 42 mm
 - Outer tube diameter for the inch-size series R 1/8" to R 1 1/4"
 - Outer tube diameter for the imperial size series 1/4" to 1 1/2"
- Double tube clamps with different tube o.d. are available on request.

Accessories and construction types

Tube clamps series C (according to DIN 3015 Part 2)

Specially designed for high mechanical requirements, and available in ten standard sizes.

- Outer tube diameter for the metric series 6 to 406.4 mm
 - Outer tube diameter for the inch-size series R 1/8" to R 16"
 - Outer tube diameter for the imperial size series 5/16" to 12 3/4"
- Accessories and construction types

Design:

According to DIN 3015:

Both upper and lower clamp-halves are identical. Webs inside the bore of the clamps provide an impact and vibration deadening effect, and absorb the forces towards the direction of the tube axis.

For mounting hoses and cables it is recommended that clamps with a smooth interior surface and without prestress (block height C is reduced by gap height S) are used.

Clamp material:

| | | |
|---------------|---------------------|-------------------|
| Polypropylene | -30°C up to + 90°C | colour dark green |
| Polyamide | -40°C up to + 120°C | colour black |
| Rubber | -50°C up to + 120°C | colour black |
| Aluminium | -40°C up to + 300°C | |

Stainless steel upon request.

Non standard colours upon request.

Special materials

Flame retardant.....p. T5
Corrosion retardant..... p. T5

Resistance to stress:

The remarkable features of **Tube Clamps** are their considerable re-set capability, high tensile strength, as well as their very high output strength and excellent resistance to cold. The choice of design and clamp material depends on the specific demands of the mechanical and thermal requirements.

Order code:

The order code for clamp halves as well as the reference No. for complete tube clamps incorporates the serial indication, material description and interior surface.

In accordance with DIN 3015, clamps always consist of two clamp halves. (1 clamp = 2 clamp halves)

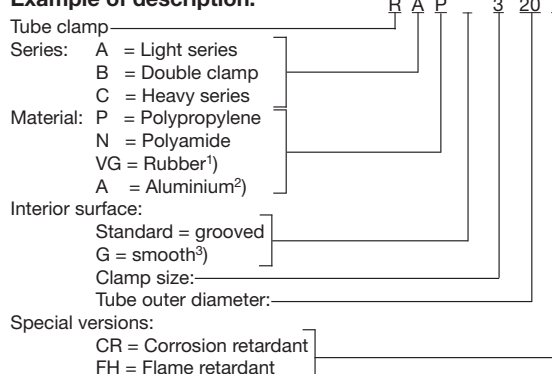
Example of description:

¹⁾ Rubber only available for series A and B, inside smooth and series C grooved design (G).

²⁾ Aluminium only available for series A size 0 to 6 and series C size 1 to 8. Aluminium clamps only available in a grooved design.

³⁾ Inside smooth series A not for size 0.

Inside smooth series C only up to size 8.

Clamps with smooth interior surface and without prestress

Finish of the metal components:

All metal components are available in steel and stainless steel.

Stainless steel quality:

Stainless steel W5 (1.4401 or 1.4571) from stock, W4 (1.4301 or 1.4305) available on request.

Surfaces steel:

As is standard, the steel components have the following surfaces:

| Metal part | Series A+B | | Series C | |
|--------------------------|-------------------------|-------------------------|-------------------------|-------------------------|
| | Bolt | Cr(VI)-free zinc plated | | phosphated |
| Cover plate | Cr(VI)-free zinc plated | | phosphated | Cr(VI)-free zinc plated |
| Welding plate | phosphated | | phosphated | |
| Mounting rail nut | Cr(VI)-free zinc plated | | Cr(VI)-free zinc plated | |
| Mounting rail | plain & oiled | Cr(VI)-free zinc plated | plain & oiled | Cr(VI)-free zinc plated |

Surfaces differing from this are available on request.

Registration:

On request.



Tube clamps

Tube clamps material properties

DIN 3015

| Mechanical properties | Polypropylene (PP) | Polyamide (PA) | Aluminium (Al) | Rubber (TPE) |
|---|--------------------------------------|---------------------------------------|--------------------------|--|
| Density | 0.90 g/cm ³ | 1.10 g/cm ³ | 2.65 g/cm ³ | 0.97 g/cm ³ |
| Impact value at 23 °C | 7 kJ/m ² (ISO 179/1eA) | 8 kJ/mm ² (ISO 179/1eA) | – | – |
| Impact value at -20 °C | 3 kJ/m ² (ISO 179/1eA) | – | – | – |
| Modulus of elasticity | 1.400 N/mm ² (ISO 527) | 2.000 N/mm ² (ISO 527) | 72.000 N/mm ² | – |
| Yield stress. resp. tensile strength (Rm) | 28 N/mm ² (ISO 527) | 50 N/mm ² (ISO 527) | >240 N/mm ² | 5.2 ... 8.8 N/mm ² (ASTM D412) |
| Thermal properties | | | | |
| Temp. resistance | -30 ... +90°C | -40 ... +120°C | -40 ... +300°C | -50 ... +120°C |
| Chemical properties | | | | |
| Weak acids | limited resistant | limited resistant | limited resistant | resistant |
| Weak alkalis | limited resistant | limited resistant | limited resistant | resistant |
| Alcohol | resistant | resistant | resistant | resistant |
| Petrol | limited resistant | resistant | resistant | limited resistant |
| Mineral oils | limited resistant | resistant | resistant | resistant |
| Other oils | resistant | resistant | resistant | resistant |
| Sea Water | resistant | resistant | limited resistant | resistant |

The outlined particulars are approximate values and are only shown for reference, which are not binding, and with regard to possible protection of third parties. They do not exempt you from your own examination of suitability of the products delivered by us. Therefore, these values can only be used in a limited way for guidance only.

The application of the products is carried out outside of our control and, therefore, is exclusively subject to your own area of responsibility. Any claim however would be limited for all damages to the value of the goods supplied by us and in use by you.

It goes without saying, that we guarantee the perfect quality of our products according to our general sales and delivery conditions.



Special materials

Flame retardant clamps for railway vehicles EN 45545-2

Our flame retardant finish is the ideal solution for the transport and railway market. This provides increased safety and efficiency for railway vehicles.

| Material: | Polypropylene (PP-F) | Polyamide (PA-F) | Rubber (TPE-F) |
|---|---------------------------|---------------------------|---------------------------|
| T01 EN ISO 4589-2: Oxygen Index | OI = 38.7 % | OI = 35.5 % | OI = 33.4 % |
| T10.03 EN ISO 5659-2: 25 kW/m ² | D _S max. = 48 | D _S max. = 124 | D _S max. = 79 |
| T12 NF X 70 100-1 & -2: 600°C | CIT _{NLP} = 0.15 | CIT _{NLP} = 0.51 | CIT _{NLP} = 0.15 |
| Compliance of the requirement set R22, 23, 24, 26 for the hazard level: | HL1 - HL2 - HL3 | HL1 - HL2 - HL3 | HL1 - HL2 - HL3 |

The advantages:

- Improved railway vehicle safety
- Flame retardant in accordance with DIN 45545-2, UL 94, DIN 3015, BS 6853, DIN 5510-2, NF F 16-101 NF F 16-101, BS 6853, UL 94
- 2+5 system. Only 2 sizes for tube diameters 6-42 mm
- Plates and rails in steel and stainless steel

Standard compliance:

Flame protected tube clamps DIN 3015 certification in line with:

- BS 6853
- DIN 5510-2
- DIN EN 45545
- UL 94
- NF F 16-101

For the original material polypropylene, the color of the clamp is white, black for polyimid and solid rubber.

Example of description:

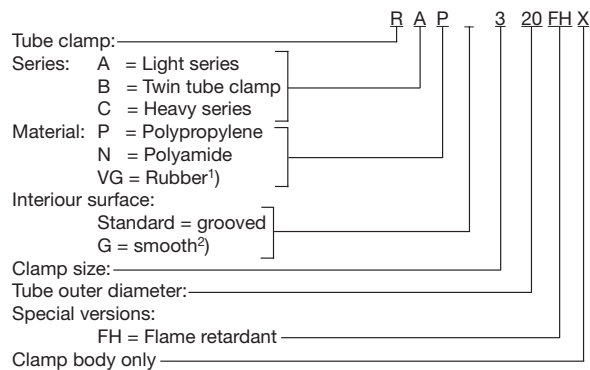

Corrosion retardant clamps

Our anti-corrosion finish is the ideal solution for areas at risk of corrosion.

Anticorrosion was developed on the basis of the approved polypropylene.

A specialised corrosion inhibitor effectively slows down the development of crevice corrosion between the clamp bodies and the tubework.

These corrosion-preventing properties were tested and recorded by salt spray tests in accordance with DIN EN ISO 9227.

Tube clamps made of PP-CR are available in the A+C series of our approved tube clamp range.

The source material is polypropylene, and the colour of the clamps is always slate grey.

Advantages:

- Enormous reduction of crevice corrosion
- Extension of maintenance intervals
- Cost reduction due to extended durability of the tubing

Example of description:

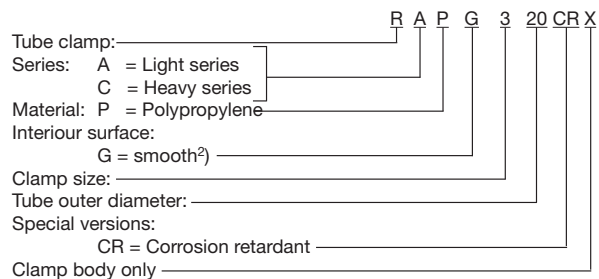

¹⁾ Rubber for series A and B only with smooth interior surface (G).

²⁾ Inside smooth series A not for size 0.

Inside smooth series C only up to size 8.

Clamps with smooth interior surface and without prestress.

Tube clamps

Tube clamps assembly instruction

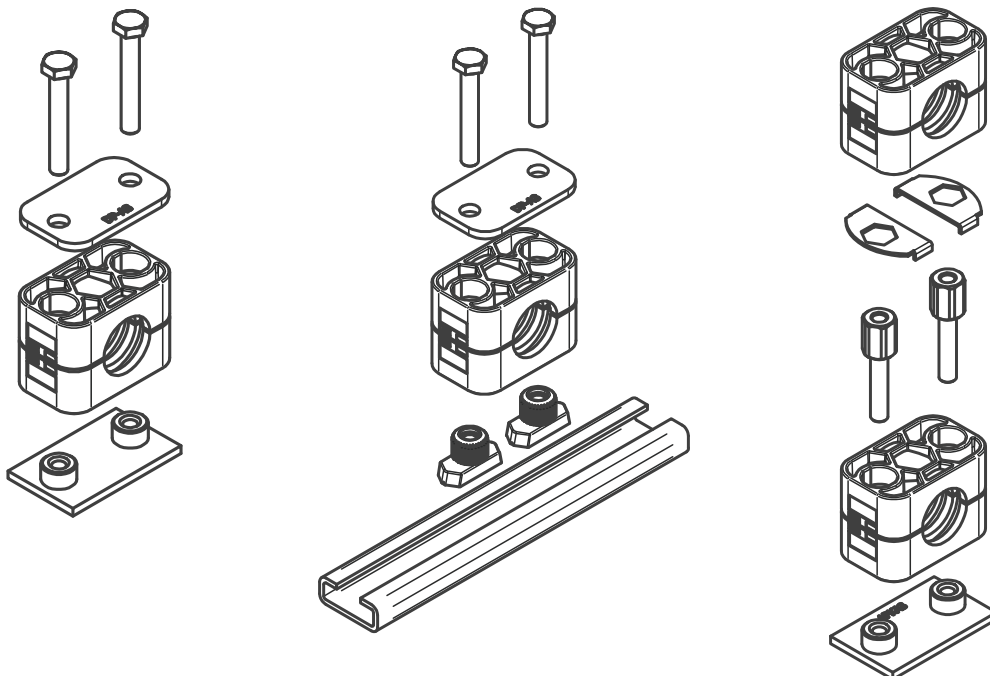
Assembly:
Assembly on to metal welding plates

Place welding plates on a base appropriate for the load. Make sure that the clamps are properly aligned. Clamp lower clamp half onto welding plate, insert tube, place upper clamp half onto lower half and fasten with the screws. Attention must be paid to the bias (after completed assembly, clamp halves may not be in contact)! Do not weld with fitted plastic clamp! Extended welding plates may be screw-fastened to the base.

Assembly on support rails

Support rails are available in four different heights and come in pieces of 1 m or 2 m length, as required. Weld on support rail or screw-fasten with fastening angle bracket. Insert support rail nuts in rail and turn until stoppage. For heavy duty construction series, nuts are simply pushed in. Clamp lower clamp half on support rail nuts, insert tube, place upper clamp half onto lower half and fasten with the screws. Before fastening the screws the clamp may still be positioned. Attention must be paid to the bias (after completed assembly, the clamp halves may not be in contact)!

Construction assembly

Clamps allow the assembly of multiple clamps of the same construction size and of different tube diameters one above the other. The construction assembly is carried out with special fixing screws that are secured against twisting by applying a locking plate. Clamp lower clamp half on welding plate or support rail respectively, insert tube, place upper clamp half on lower half and fasten with fixing screws. The fixing screw juts out from the upper clamp half. The application of a locking late surely fastens the fixing screw and prevents twisting. Clamp on second clamp half on to the fixing screws etc.



Tube clamps

DIN 3015

Screw tightening torque and axial pipe shearing forces

The indicated screw tightening torque and axial pipe shearing forces refer to the assembly with cover plates and outside hexagon bolts according to DIN 931/933.

The axial pipe shearing force (according to DIN 3015, part 10) is an average value, determined by three tests made with a steel pipe according to DIN 2448 of St. 37, for which static friction is assumed (temperature during tests: 23°C). When loading the clamp with the indicated test force (F) in axial pipe direction, the pipe must not slide in the clamp.

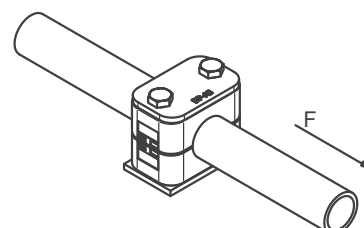

Series A - Light series (DIN 3015, part 1)

| Size | Fixing screw DIN 931/933 | Polypropylene | | Polyamide | | Aluminium | |
|------|-----------------------------|---------------------------------|-------------------------------|---------------------------------|-------------------------------|---------------------------------|-------------------------------|
| | | Screw tightening torque (Nm) | Pipe shearing force F (kN) | Screw tightening torque (Nm) | Pipe shearing force F (kN) | Screw tightening torque (Nm) | Pipe shearing force F (kN) |
| 0 | M6 | 8 | 0.6 | 10 | 0.6 | – | – |
| 1 | M6 | 8 | 1.1 | 10 | 0.7 | 12 | 4.2 |
| 2 | M6 | 8 | 1.2 | 10 | 0.8 | 12 | 4.3 |
| 3 | M6 | 8 | 1.4 | 10 | 1.6 | 12 | 4.8 |
| 4 | M6 | 8 | 1.5 | 10 | 1.7 | 12 | 5.0 |
| 5 | M6 | 8 | 1.9 | 10 | 2.0 | 12 | 7.3 |
| 6 | M6 | 8 | 2.0 | 10 | 2.5 | 12 | 8.9 |
| 7 | M6 | 8 | 2.3 | 10 | 3.2 | – | – |
| 8 | M6 | 8 | 2.6 | 10 | 3.5 | – | – |

Series B - Double series (DIN 3015, part 3)

| Size | Fixing screw DIN 931/933 | Polypropylene | | Polyamide | |
|------|-----------------------------|---------------------------------|-------------------------------|---------------------------------|-------------------------------|
| | | Screw tightening torque (Nm) | Pipe shearing force F (kN) | Screw tightening torque (Nm) | Pipe shearing force F (kN) |
| 1 | M6 | 5 | 0.9 | 6 | 0.9 |
| 2 | M8 | 12 | 2.1 | 12 | 2.2 |
| 3 | M8 | 12 | 1.9 | 12 | 2.0 |
| 4 | M8 | 12 | 2.7 | 12 | 2.9 |
| 5 | M8 | 8 | 1.7 | 8 | 2.5 |

Series C - Heavy series (DIN 3015, part 2)

| Size | Fixing screw DIN 931/933 | Polypropylene | | Polyamide | | Aluminium | |
|------|-----------------------------|---------------------------------|-------------------------------|---------------------------------|-------------------------------|---------------------------------|-------------------------------|
| | | Screw tightening torque (Nm) | Pipe shearing force F (kN) | Screw tightening torque (Nm) | Pipe shearing force F (kN) | Screw tightening torque (Nm) | Pipe shearing force F (kN) |
| 1 | M10 | 12 | 1.6 | 20 | 4.2 | 30 | 12.1 |
| 2 | M10 | 12 | 2.9 | 20 | 4.5 | 30 | 15.1 |
| 3 | M10 | 15 | 3.3 | 25 | 5.1 | 35 | 15.5 |
| 4 | M12 | 30 | 8.2 | 40 | 9.3 | 55 | 29.4 |
| 5 | M16 | 45 | 11.0 | 55 | 15.8 | 120 | 34.8 |
| 6 | M20 | 80 | 14.0 | 150 | 21.0 | 220 | 50.0 |
| 7 | M24 | 110 | 28.0 | 200 | 32.0 | 250 | 70.6 |
| 8 | M30 | 180 | 40.0 | 350 | 48.0 | 500 | 84.5 |
| 9 | M30 | 200 | 119.0 | 370 | 125.0 | 500 | 181.5 |
| 10 | M30 | 270 | 168.0 | 450 | 180.0 | 600 | 244.5 |



For further information on clamp mouting, see page F14 following.



Tube clamps



Index

Tube clamps series A (Light construction series) – Components

DIN 3015, part 1

Order codes for clamp halves:

| Material | Interior surface | Order code |
|---------------|------------------|--------------------------|
| Polypropylene | grooved | RAP |
| | smooth | RAPG |
| Polyamide | grooved | RAN |
| | smooth | RANG |
| Rubber | smooth | RAVG¹⁾ |
| Aluminium | grooved | RAA²⁾ |

(Please exchange as required standard abbreviation RAP in column for "clamp halves")

For flame- or corrosion retardant materials, please refer to page T5.

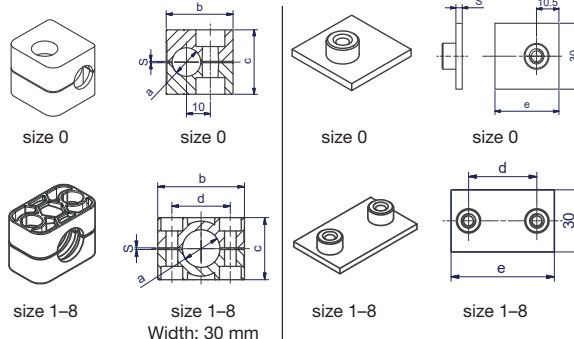

| clamp size | Tube O.D. mm a | Tube NB | Tube O.D. | 1 part 2 clamp halves | | welding plate, short | | |
|------------|-------------------|---------|--------------------|---|------------------------|-----------------------|----------------------|--|
| | | | | RAP... Order code | dimensions: b c d s | APKA... Order code | dimensions: d e s | |
| 0 | 4.0 | G 1/8 | 1/4 5/16 3/8 | RAP004X RAP006X RAP006.4X RAP008X RAP009.5X RAP010X RAP012X | 28 27 - 0.6 | APKA0...* | - 30 3 | |
| | 6.0 | | | | | | | |
| | 6.4 | | | | | | | |
| | 8.0 | | | | | | | |
| | 9.5 | | | | | | | |
| | 10.0 | | | | | | | |
| 1 | 4.0 | G 1/8 | 1/4 5/16 3/8 | RAP104X RAP106X RAP106.4X RAP108X RAP109.5X RAP110X RAP112X | 34 27 20 0.6 | APKA1...* | 20 36 3 | |
| | 6.0 | | | | | | | |
| | 6.4 | | | | | | | |
| | 8.0 | | | | | | | |
| | 9.5 | | | | | | | |
| | 10.0 | | | | | | | |
| 2 | 12.7 | G 1/4 | 1/2 | RAP212.7X RAP213.5X RAP214X RAP215X RAP216X RAP217.2X RAP218X | 42 33 26 0.8 | APKA2...* | 26 42 3 | |
| | 13.5 | | | | | | | |
| | 14.0 | | | | | | | |
| | 15.0 | G 3/8 | 5/8 | RAP319X RAP320X RAP321.3X RAP322X RAP323X RAP325X RAP325.4X | 49 35 33 1.0 | APKA3...* | 33 50 3 | |
| | 16.0 | | | | | | | |
| | 17.2 | | | | | | | |
| 4 | 26.9 | G 3/4 | | RAP426.9X RAP428X RAP430X | 59 42 40 1.2 | APKA4...* | 40 59 3 | |
| | 28.0 | | | | | | | |
| | 30.0 | | | | | | | |
| 5 | 32.0 | G 1 | 1 1/4 | RAP532X RAP533.7X RAP535X RAP538X RAP540X RAP542X | 71 58 52 1.2 | APKA5...* | 52 72 3 | |
| | 33.7 | | | | | | | |
| | 35.0 | | | | | | | |
| | 38.0 | G 1 1/4 | 1 1/2 | | | | | |
| | 40.0 | | | | | | | |
| | 42.0 | | | | | | | |

Continuation see next page ...



Tube clamps series A (Light construction series) – Components (Continued)

DIN 3015, part 1

Order codes for clamp halves:

| Material | Interior surface | Order code |
|---------------|------------------|--------------------------|
| Polypropylene | grooved | RAP |
| | smooth | RAPG |
| Polyamide | grooved | RAN |
| | smooth | RANG |
| Rubber | smooth | RAVG¹⁾ |
| Aluminium | grooved | RAA²⁾ |

(Please exchange as required standard abbreviation RAP in column for "clamp halves")

For flame- or corrosion retardant materials, please refer to page T5.

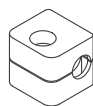

size 0

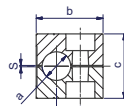

size 0

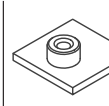

size 0

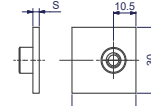

size 0

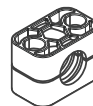

size 1-8

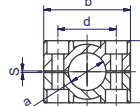

size 1-8

Width: 30 mm

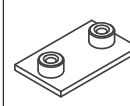

size 1-8

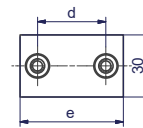

size 1-8

| clamp size | Tube O.D. mm a | Tube NB | Tube O.D. | 1 part 2 clamp halves | | | | | welding plate, short | | | |
|------------|-------------------|---------|-----------|--|------------------------|-------|-----|-----|-------------------------------|----------------------|-----|---|
| | | | | RAP... Order code | dimensions: b c d s | | | | APK A... Order code | dimensions: d e s | | |
| 6 | 44.5 | G 1 1/2 | 1 3/4 | RAP644.5X RAP645X RAP648X RAP650X RAP650.8X RAP652X RAP654X RAP655X RAP657X | 86 | 66 | 66 | 1.2 | APKA6...* | 66 | 88 | 3 |
| | 45.0 | | 2 | | | | | | | | | |
| | 48.0 | | 2 1/4 | | | | | | | | | |
| | 50.0 | | 2 1/4 | | | | | | | | | |
| | 50.8 | | 2 1/2 | | | | | | | | | |
| | 52.0 | | 2 3/4 | | | | | | | | | |
| | 54.0 | | 3 | | | | | | | | | |
| 55.0 | 3 | | | | | | | | | | | |
| 57.0 | 3 | | | | | | | | | | | |
| 7 | 57.2 | G 2 | 2 1/4 | RAP757.2X RAP760.3X RAP763.5X RAP770X RAP773X RAP776.1X | 121 | 93.6 | 94 | 1.6 | APKA7...* | 94 | 122 | 5 |
| | 60.3 | | 2 1/2 | | | | | | | | | |
| | 63.5 | | 2 3/4 | | | | | | | | | |
| | 70.0 | | 3 | | | | | | | | | |
| | 73.0 | | 3 | | | | | | | | | |
| 76.1 | 3 | | | | | | | | | | | |
| 8 | 88.9 | G 3 | 4 | RAP888.9X RAP8101.8X | 147 | 117.6 | 120 | 1.6 | APKA8...* | 120 | 148 | 5 |
| | 101.8 | G 3 1/2 | 4 | | | | | | | | | |

¹⁾ When assembling solid rubber clamps, covering plates, hexagon screws and locking washers must be used.

²⁾ Aluminium sizes 0-6

*Please add the suffix below according to the surface/material required.

| Order code suffixes | | |
|---------------------------------|--------------|------------|
| Surface/material | Suffix | Example |
| Steel, phosphated | X | APKA0X |
| Steel, zinc plated, Cr(VI)-free | VZX | APKA0VZX |
| Stainless Steel 1.4571 | 4571X | APKA04571X |



Tube clamps

Tube clamps series A (Light construction series) – Components

DIN 3015, part 1

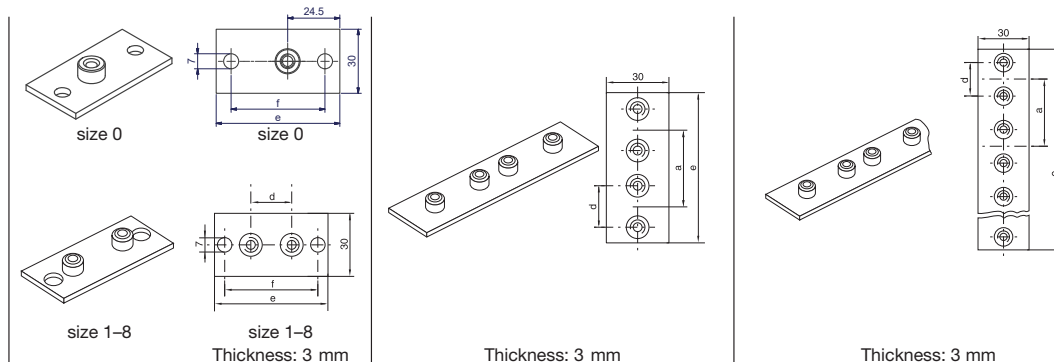

| clamp size | weld/screw plate, long | | | twin welding plate | | | multiple weld plate | | | | | |
|------------|-------------------------------|-------------|-----|--------------------|-------------------------------|-------------|---------------------|-----|---------------------------------|-------------|----|-----|
| | APL A... Order code | dimensions: | | | APD A... Order code | dimensions: | | | APR A... Order code | dimensions: | | |
| | | d | e | f | | d | a | e | | d | a | e |
| 0 | APLA0...* | – | 58 | 44 | APDA0...* | – | 30 | 61 | APRA0...* (10 clamps) | – | 30 | 298 |
| 1 | APLA1...* | 20 | 64 | 50 | APDA1...* | 20 | 35 | 69 | APRA1...* (10 clamps) | 20 | 35 | 349 |
| 2 | APLA2...* | 26 | 70 | 56 | APDA2...* | 26 | 43 | 86 | APRA2...* (10 clamps) | 26 | 43 | 427 |
| 3 | APLA3...* | 33 | 78 | 64 | APDA3...* | 33 | 52 | 104 | APRA3...* (10 clamps) | 33 | 52 | 516 |
| 4 | APLA4...* | 40 | 87 | 73 | APDA4...* | 40 | 60 | 117 | APRA4...* (5 clamps) | 40 | 60 | 297 |
| 5 | APLA5...* | 52 | 100 | 86 | APDA5...* | 52 | 75 | 145 | APRA5...* (5 clamps) | 52 | 75 | 370 |
| 6 | APLA6...* | 66 | 116 | 100 | APDA6...* | 66 | 90 | 176 | APRA6...* (5 clamps) | 66 | 90 | 446 |
| 7 | APLA7...* | 94 | 150 | 136 | | | | | | | | |
| 8 | APLA8...* | 120 | 178 | 162 | | | | | | | | |

*Please add the suffix below according to the surface/material required.

| Order code suffixes | | |
|---------------------------------|--------------|------------|
| Surface/material | Suffix | Example |
| Steel, phosphated | X | APLA0X |
| Steel, zinc plated, Cr(VI)-free | VZX | APLA0VZX |
| Stainless Steel 1.4571 | 4571X | APLA04571X |

Tube clamps series A (Light construction series) – Components

DIN 3015, part 1

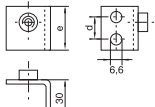
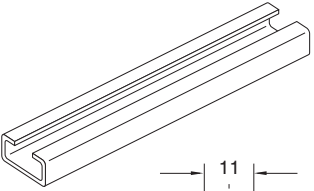
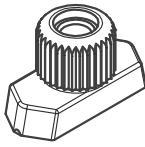
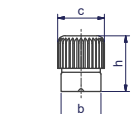
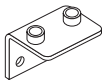
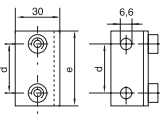
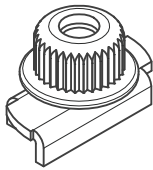
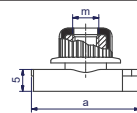
|  <p>size 0</p> | |  <p>size 0</p> | |  <p>1 or 2 mtr</p> |  | |  |
|---|-------------------------|---|--|---|---|--------------------------|---|
|  <p>size 1-6</p> | |  <p>size 1-6 Thickness: 3 mm</p> | | |  <p>With loss protection (See page T54).</p> | |  |
| clamp size | weld plate, angled | | mounting rail | | rail nut | | |
| | APWA A... Order code | dimensions: d e | TS...A/B Order code | dimensions: h | TM...A/B1 Order code | dimensions: a b c m h | |
| 0 | APWA0X APWA04571X | 14 30 | TS11A/B1...* TS11A/B2...* TS14A/B1...* TS14A/B2...* TS30A/B1...* TS30A/B2...* | TS11: 11 TS14: 14 TS30: 30 | TMA/TMB1VERZX TMA/TMB1/4571X | 25.410.4 12 M6 14.5 | |
| 1 | APWA1X APWA14571X | 20 36 | | | | | |
| 2 | APWA2X APWA24571X | 26 42 | | | | | |
| 3 | APWA3X APWA34571X | 33 50 | | | TMA/TMB1WLPVZX TMA/TMB1WLP71X | 24.910.5 12 M6 14.5 | |
| 4 | APWA4X APWA44571X | 40 59 | | | | | |
| 5 | APWA5X APWA54571X | 52 72 | | | | | |
| 6 | APWA6X APWA64571X | 66 88 | | | | | |

*Please add the suffix below according to the surface/material required.

| Order code suffixes | | |
|---------------------------------|------------|-------------|
| Surface/material | Suffix | Example |
| Steel, phosphated | X | TS11A/B1X |
| Steel, zinc plated, Cr(VI)-free | VZX | TS11A/B1VZX |
| Stainless Steel 1.4571 | 71X | TS11A/B171X |



Tube clamps

Tube clamps series A (Light construction series) – Components

DIN 3015, part 1

| clamp size | cover plate | | slot head | | hexagon head | | socket head | |
|------------|-----------------------|--------------------|-----------------------|----------------------|------------------------|----------------------|-----------------------|----------------------|
| | DP A... Order code | dimensions: b d | SL A... Order code | dimensions: d x L | SSL A... Order code | dimensions: d x L | IS A... Order code | dimensions: d x L |
| 0 | DPA0...* | – – | SLA0...* | M 06x20 | SSLA0...* | M 06x30 | ISA0...* | M 06x20 |
| 1 | DPA1...* | 34 20 | SLA0...* | M 06x20 | SSLA0...* | M 06x30 | ISA0...* | M 06x20 |
| 2 | DPA2...* | 40 26 | SLA2...* | M 06x25 | SSLA2/SSB1...* | M 06x35 | ISA2...* | M 06x25 |
| 3 | DPA3...* | 48 33 | SLA3...* | M 06x30 | SSLA3...* | M 06x40 | ISA3...* | M 06x30 |
| 4 | DPA4...* | 57 40 | SLA4...* | M 06x35 | SSLA4...* | M 06x45 | ISA4...* | M 06x35 |
| 5 | DPA5...* | 70 52 | SLA5...* | M 06x50 | SSLA5...* | M 06x60 | ISA5...* | M 06x50 |
| 6 | DPA6...* | 86 66 | SLA6...* | M 06x60 | SSLA6...* | M 06x70 | ISA6...* | M 06x60 |
| 7 | DPA7...* | 120 94 | SLA7...* | M 06x90 | SSLA7...* | M 06x100 | ISA7...* | M 06x90 |
| 8 | DPA8...* | 146 120 | SLA8...* | M 06x110 | SSLA8...* | M 06x125 | ISA8...* | M 06x110 |

*Please add the suffix below according to the surface/material required.

| Order code suffixes | | |
|---------------------------------|--------|-----------|
| Surface/material | Suffix | Example |
| Steel, zinc plated, Cr(VI)-free | X | DPA0X |
| Stainless Steel 1.4571 | 4571X | DPA04571X |

Tube clamps series A (Light construction series) – Components

DIN 3015, part 1

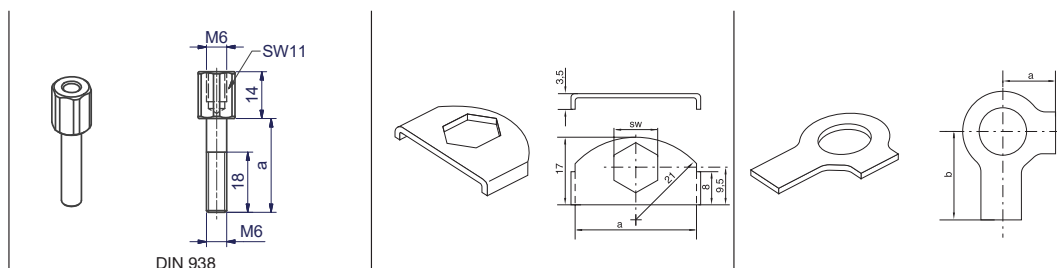

| clamp size | stacking ¹⁾ | | locking plate ¹⁾ | | locking washer ²⁾ | |
|------------|------------------------|------------------|-----------------------------|---------------------|------------------------------|--------------------|
| | AS A... Order code | dimensions: a | SB A Order code | dimensions: a SW | US A Order code | dimensions: a b |
| 0 | ASA0...* (ASB1...*) | 20 | SBA...* | 30 11 | USA/USB1X ³⁾ | 9 18 |
| 1 | ASA0...* (ASB1...*) | 20 | | | | |
| 2 | ASA2...* | 25 | | | | |
| 3 | ASA3...* | 28 | | | | |
| 4 | ASA4...* | 34 | | | | |
| 5 | ASA5...* | 50 | | | | |
| 6 | ASA6...* | 60 | | | | |
| 7 | ASA7...* | 85 | | | | |
| 8 | ASA8...* | 110 | | | | |

¹⁾ The use of stacking bolts necessitates the use of locking plates in the construction assembly.

²⁾ When assembling solid rubber clamps, cover plates, hexagon screws and locking washers must be used.

³⁾ Material = stainless steel 1.4571

*Please add the suffix below according to the surface/material required.

| Order code suffixes | | |
|---------------------------------|--------|-----------|
| Surface/material | Suffix | Example |
| Steel, zinc plated, Cr(VI)-free | X | DPA0X |
| Stainless Steel 1.4571 | 4571X | DPA04571X |



Tube clamps

Tube clamps series A (Light construction series) – Complete range
Order codes for clamp halves:

| Material | Interior surface | Order code |
|---------------|------------------|--------------------|
| Polypropylene | grooved | RAP |
| | smooth | RAPG |
| Polyamide | grooved | RAN |
| | smooth | RANG |
| Rubber | smooth | RAVG ¹⁾ |
| Aluminium | grooved | RAA ²⁾ |

(Please exchange as required standard abbreviation RAP in column for "Order code")

For flame- or corrosion retardant materials, please refer to page T5.

The steel parts of kits 1, 2 and 3 have the following surfaces:

Screws, bushes, cover plates = Cr(VI)-free galvanized

Welding plate = phosphated

Other compositions available on request.

2 clamp halves, weld plate **short**, slot head bolts and bushes

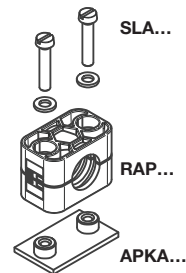

2 clamp halves, weld plate **short**, socket head bolts and bushes

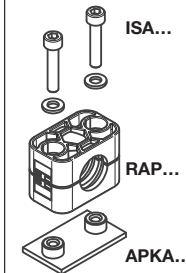

2 clamp halves, weld plate **short**, cover plate hex. head bolts

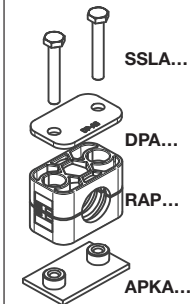

| clamp size | Tube O.D. mm | Tube NB | Tube O.D. | Order code | Order code | Order code |
|-----------------|--------------|---------|--------------------|------------|------------|------------|
| 0 ³⁾ | 4.0 | G 1/8 | 1/4 5/16 3/8 | RAP1-004 | RAP2-004 | RAP3-004 |
| | 6.0 | | | RAP1-006 | RAP2-006 | RAP3-006 |
| | 6.4 | | | RAP1-006.4 | RAP2-006.4 | RAP3-006.4 |
| | 8.0 | | | RAP1-008 | RAP2-008 | RAP3-008 |
| | 9.5 | | | RAP1-009.5 | RAP2-009.5 | RAP3-009.5 |
| | 10.0 | | | RAP1-010 | RAP2-010 | RAP3-010 |
| | 12.0 | | | RAP1-012 | RAP2-012 | RAP3-012 |
| 1 | 4.0 | G 1/8 | 1/4 5/16 3/8 | RAP1-104 | RAP2-104 | RAP3-104 |
| | 6.0 | | | RAP1-106 | RAP2-106 | RAP3-106 |
| | 6.4 | | | RAP1-106.4 | RAP2-106.4 | RAP3-106.4 |
| | 8.0 | | | RAP1-108 | RAP2-108 | RAP3-108 |
| | 9.5 | | | RAP1-109.5 | RAP2-109.5 | RAP3-109.5 |
| | 10.0 | | | RAP1-110 | RAP2-110 | RAP3-110 |
| | 12.0 | | | RAP1-112 | RAP2-112 | RAP3-112 |
| 2 | 12.7 | G 1/4 | 1/2 | RAP1-212.7 | RAP2-212.7 | RAP3-212.7 |
| | 13.5 | | | RAP1-213.5 | RAP2-213.5 | RAP3-213.5 |
| | 14.0 | | | RAP1-214 | RAP2-214 | RAP3-214 |
| | 15.0 | G 3/8 | 5/8 | RAP1-215 | RAP2-215 | RAP3-215 |
| | 16.0 | | | RAP1-216 | RAP2-216 | RAP3-216 |
| | 17.2 | | | RAP1-217.2 | RAP2-217.2 | RAP3-217.2 |
| | 18.0 | | | RAP1-218 | RAP2-218 | RAP3-218 |
| 3 | 19.0 | G 1/2 | 3/4 1 | RAP1-319 | RAP2-319 | RAP3-319 |
| | 20.0 | | | RAP1-320 | RAP2-320 | RAP3-320 |
| | 21.3 | | | RAP1-321.3 | RAP2-321.3 | RAP3-321.3 |
| | 22.0 | | | RAP1-322 | RAP2-322 | RAP3-322 |
| | 23.0 | | | RAP1-323 | RAP2-323 | RAP3-323 |
| | 25.0 | | | RAP1-325 | RAP2-325 | RAP3-325 |
| | 25.4 | | | RAP1-325.4 | RAP2-325.4 | RAP3-325.4 |
| 4 | 26.9 | G 3/4 | | RAP1-426.9 | RAP2-426.9 | RAP3-426.9 |
| | 28.0 | | | RAP1-428 | RAP2-428 | RAP3-428 |
| | 30.0 | | | RAP1-430 | RAP2-430 | RAP3-430 |
| 5 | 32.0 | G 1 | 1 1/4 | RAP1-532 | RAP2-532 | RAP3-532 |
| | 33.7 | | | RAP1-533.7 | RAP2-533.7 | RAP3-533.7 |
| | 35.0 | | | RAP1-535 | RAP2-535 | RAP3-535 |
| | 38.0 | G 1 1/4 | 1 1/2 | RAP1-538 | RAP2-538 | RAP3-538 |
| | 40.0 | | | RAP1-540 | RAP2-540 | RAP3-540 |
| | 42.0 | | | RAP1-542 | RAP2-542 | RAP3-542 |
| 6 | 44.5 | G 1 1/2 | 1 3/4 2 | RAP1-644.5 | RAP2-644.5 | RAP3-644.5 |
| | 45.0 | | | RAP1-645 | RAP2-645 | RAP3-645 |
| | 48.0 | | | RAP1-648 | RAP2-648 | RAP3-648 |
| | 50.0 | | | RAP1-650 | RAP2-650 | RAP3-650 |
| | 50.8 | | | RAP1-650.8 | RAP2-650.8 | RAP3-650.8 |
| | 52.0 | | | RAP1-652 | RAP2-652 | RAP3-652 |
| | 54.0 | | | RAP1-654 | RAP2-654 | RAP3-654 |
| | 55.0 | | | RAP1-655 | RAP2-655 | RAP3-655 |
| | 57.0 | | | RAP1-657 | RAP2-657 | RAP3-657 |

Continuation see next page ...



Tube clamps series A (Light construction series) – Complete range

Order codes for clamp halves:

| Material | Interior surface | Order code |
|---------------|------------------|--------------------------|
| Polypropylene | grooved | RAP |
| | smooth | RAPG |
| Polyamide | grooved | RAN |
| | smooth | RANG |
| Rubber | smooth | RAVG¹⁾ |
| Aluminium | smooth | RAA²⁾ |
| | grooved | |

(Please exchange as required standard abbreviation RAP in column for "Order code")

For flame- or corrosion retardant materials, please refer to page T5.

The steel parts of kits 1, 2 and 3 have the following surfaces:

Screws, bushes, cover plates = Cr(VI)-free galvanized

Welding plate = phosphated

Other compositions available on request.

2 clamp halves, weld plate **short**, slot head bolts and bushes

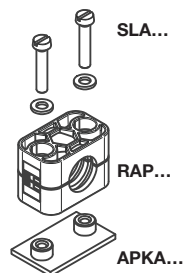

2 clamp halves, weld plate **short**, socket head bolts and bushes

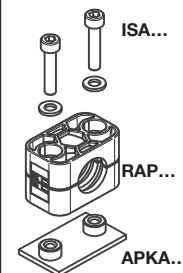

2 clamp halves, weld plate **short**, cover plate hex. head bolts

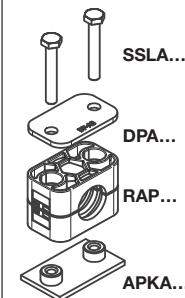

| clamp size | Tube O.D. mm | Tube NB | Tube O.D. | Order code | Order code | Order code |
|------------|--------------|-----------------|-------------------|--------------------|--------------------|--------------------|
| 7 | 57.2 | G 2 | 2 1/4 | RAP1-757.2 | RAP2-757.2 | RAP3-757.2 |
| | 60.3 | | RAP1-760.3 | RAP2-760.3 | RAP3-760.3 | |
| | 63.5 | | RAP1-763.5 | RAP2-763.5 | RAP3-763.5 | |
| | 70.0 | | RAP1-770 | RAP2-770 | RAP3-770 | |
| | 73.0 | RAP1-773 | RAP2-773 | RAP3-773 | | |
| 8 | 76.1 | G 2 1/2 | 3 | RAP1-776.1 | RAP2-776.1 | RAP3-776.1 |
| | 88.9 | G 3 | 4 | RAP1-888.9 | RAP2-888.9 | RAP3-888.9 |
| | 101.8 | | | RAP1-8101.8 | RAP2-8101.8 | RAP3-8101.8 |

Delivery in unassembled individual components.

1) When assembling solid rubber clamps, cover plates, hexagon screws and locking washers must be used.

2) Aluminium size 0-6.

3) Contrary to the illustration size 0 clamps are secured by only one screw.

Tube clamps



Index

Tube clamps series A (Light construction series) – Complete range

Order codes for clamp halves:

| Material | Interior surface | Order code |
|---------------|------------------|--------------------|
| Polypropylene | grooved | RAP |
| | smooth | RAPG |
| Polyamide | grooved | RAN |
| | smooth | RANG |
| Rubber | smooth | RAVG ¹⁾ |
| Aluminium | grooved | RAA ²⁾ |

(Please exchange as required standard abbreviation RAP in column for "Order code")

For flame- or corrosion retardant materials, please refer to page T5.

The steel parts of kits 4, 5 and 6 have the following surfaces:

Screws, bushes, cover plates = Cr(VI)-free galvanized

Welding plate = phosphated

Other compositions available on request.

2 clamp halves, weld/
screw plate, slot head
bolts and bushes

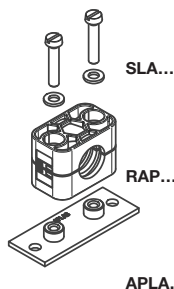

2 clamp halves, weld/
screw plate, socket
head bolts and bushes

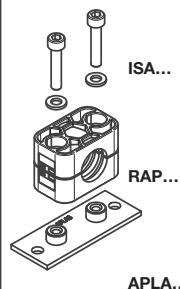

2 clamp halves, weld/
screw plate, cover
plate and hex. head
bolts

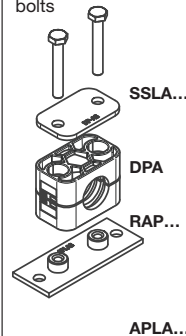

| clamp size | Tube O.D. mm | Tube NB | Tube O.D. | Order code | Order code | Order code |
|-----------------|--------------|----------|--------------------|------------|------------|------------|
| 0 ³⁾ | 4.0 | G 1/8 | 1/4 5/16 3/8 | RAP4-004 | RAP5-004 | RAP6-004 |
| | 6.0 | | | RAP4-006 | RAP5-006 | RAP6-006 |
| | 6.4 | | | RAP4-006.4 | RAP5-006.4 | RAP6-006.4 |
| | 8.0 | | | RAP4-008 | RAP5-008 | RAP6-008 |
| | 9.5 | | | RAP4-009.5 | RAP5-009.5 | RAP6-009.5 |
| | 10.0 | | | RAP4-010 | RAP5-010 | RAP6-010 |
| 1 | 12.0 | G 1/8 | 1/4 5/16 3/8 | RAP4-012 | RAP5-012 | RAP6-012 |
| | 4.0 | | | RAP4-104 | RAP5-104 | RAP6-104 |
| | 6.0 | | | RAP4-106 | RAP5-106 | RAP6-106 |
| | 6.4 | | | RAP4-106.4 | RAP5-106.4 | RAP6-106.4 |
| | 8.0 | | | RAP4-108 | RAP5-108 | RAP6-108 |
| | 9.5 | | | RAP4-109.5 | RAP5-109.5 | RAP6-109.5 |
| 2 | 10.0 | G 3/8 | 1/2 5/8 | RAP4-110 | RAP5-110 | RAP6-110 |
| | 12.0 | | | RAP4-112 | RAP5-112 | RAP6-112 |
| | 12.7 | | | RAP4-212.7 | RAP5-212.7 | RAP6-212.7 |
| | 13.5 | | | RAP4-213.5 | RAP5-213.5 | RAP6-213.5 |
| | 14.0 | | | RAP4-214 | RAP5-214 | RAP6-214 |
| | 15.0 | | | RAP4-215 | RAP5-215 | RAP6-215 |
| 3 | 16.0 | G 1/2 | 3/4 1 | RAP4-216 | RAP5-216 | RAP6-216 |
| | 17.2 | | | RAP4-217.2 | RAP5-217.2 | RAP6-217.2 |
| | 18.0 | | | RAP4-218 | RAP5-218 | RAP6-218 |
| | 19.0 | | | RAP4-319 | RAP5-319 | RAP6-319 |
| | 20.0 | | | RAP4-320 | RAP5-320 | RAP6-320 |
| | 21.3 | | | RAP4-321.3 | RAP5-321.3 | RAP6-321.3 |
| 4 | 22.0 | G 3/4 | 1 1/4 | RAP4-322 | RAP5-322 | RAP6-322 |
| | 23.0 | | | RAP4-323 | RAP5-323 | RAP6-323 |
| | 25.0 | | | RAP4-325 | RAP5-325 | RAP6-325 |
| | 25.4 | | | RAP4-325.4 | RAP5-325.4 | RAP6-325.4 |
| | 26.9 | | | RAP4-426.9 | RAP5-426.9 | RAP6-426.9 |
| | 28.0 | | | RAP4-428 | RAP5-428 | RAP6-428 |
| 5 | 30.0 | G 1 | 1 1/2 | RAP4-430 | RAP5-430 | RAP6-430 |
| | 32.0 | | | RAP4-532 | RAP5-532 | RAP6-532 |
| | 33.7 | | | RAP4-533.7 | RAP5-533.7 | RAP6-533.7 |
| | 35.0 | | | RAP4-535 | RAP5-535 | RAP6-535 |
| | 38.0 | | | RAP4-538 | RAP5-538 | RAP6-538 |
| | 40.0 | | | RAP4-540 | RAP5-540 | RAP6-540 |
| 6 | 42.0 | G 1 1/4 | 1 3/4 2 | RAP4-542 | RAP5-542 | RAP6-542 |
| | 44.5 | | | RAP4-644.5 | RAP5-644.5 | RAP6-644.5 |
| | 45.0 | | | RAP4-645 | RAP5-645 | RAP6-645 |
| | 48.0 | | | RAP4-648 | RAP5-648 | RAP6-648 |
| | 50.0 | | | RAP4-650 | RAP5-650 | RAP6-650 |
| | 50.8 | | | RAP4-650.8 | RAP5-650.8 | RAP6-650.8 |
| | 52.0 | | | RAP4-652 | RAP5-652 | RAP6-652 |
| | 54.0 | | | RAP4-654 | RAP5-654 | RAP6-654 |
| 55.0 | RAP4-655 | RAP5-655 | RAP6-655 | | | |
| 57.0 | RAP4-657 | RAP5-657 | RAP6-657 | | | |

Continuation see next page ...





Tube clamps series A (Light construction series) – Complete range

Order codes for clamp halves:

| Material | Interior surface | Order code |
|---------------|------------------|--------------------------|
| Polypropylene | grooved | RAP |
| | smooth | RAPG |
| Polyamide | grooved | RAN |
| | smooth | RANG |
| Rubber | smooth | RAVG¹⁾ |
| Aluminium | grooved | RAA²⁾ |

(Please exchange as required standard abbreviation RAP in column for "Order code")

For flame- or corrosion retardant materials, please refer to page T5.

The steel parts of kits 4, 5 and 6 have the following surfaces:

Screws, bushes, cover plates = Cr(VI)-free galvanized

Welding plate = phosphated

Other compositions available on request.

2 clamp halves, weld/
screw plate, slot head
bolts and bushes

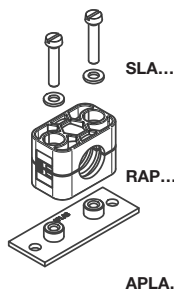

2 clamp halves, weld/
screw plate, socket
head bolts and bushes

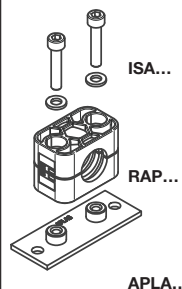

2 clamp halves, weld/
screw plate, cover
plate and hex. head
bolts

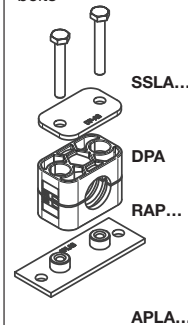

| clamp size | Tube O.D. mm | Tube NB | Tube O.D. | Order code | Order code | Order code |
|------------|--------------|---------|-------------------|--------------------|--------------------|--------------------|
| 7 | 57.2 | G 2 | 2 1/4 | RAP4-757.2 | RAP5-757.2 | RAP6-757.2 |
| | 60.3 | | RAP4-760.3 | RAP5-760.3 | RAP6-760.3 | |
| | 63.5 | | RAP4-763.5 | RAP5-763.5 | RAP6-763.5 | |
| | 70.0 | | RAP4-770 | RAP5-770 | RAP6-770 | |
| | 73.0 | | RAP4-773 | RAP5-773 | RAP6-773 | |
| 8 | 76.1 | G 2 1/2 | 3 | RAP4-776.1 | RAP5-776.1 | RAP6-776.1 |
| | 88.9 | G 3 | 3 1/2 | RAP4-888.9 | RAP5-888.9 | RAP6-888.9 |
| | 101.8 | | 4 | RAP4-8101.8 | RAP5-8101.8 | RAP6-8101.8 |
| | | | | | | |

Delivery in unassembled individual components.

¹⁾ When assembling solid rubber clamps, cover plates, hexagon screws and locking washers must be used.

²⁾ Aluminium size 0-6.

³⁾ Contrary to the illustration size 0 clamps are secured by only one screw.

Tube clamps
Tube clamps series A (Light construction series) – Complete range
Order codes for clamp halves:

| Material | Interior surface | Order code |
|---------------|------------------|--------------------|
| Polypropylene | grooved | RAP |
| | smooth | RAPG |
| Polyamide | grooved | RAN |
| | smooth | RANG |
| Rubber | smooth | RAVG ¹⁾ |
| Aluminium | grooved | RAA ²⁾ |

(Please exchange as required standard abbreviation RAP in column for "Order code")

For flame- or corrosion retardant materials, please refer to page T5.

The steel parts of kits 9, 10 and 12 have the following surfaces:

Screws, bushes, cover plates = Cr(VI)-free galvanized

Welding plate = phosphated

Other compositions available on request.

2 clamp halves, rail nuts, slot head bolts and bushes

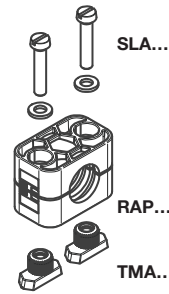

2 clamp halves, rail nuts, socket head bolts and bushes

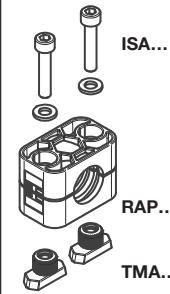

2 clamp halves, rail nuts, cover plate and hex. head bolts

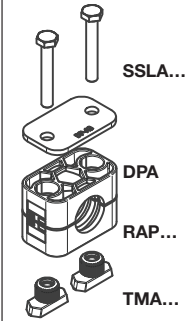

| clamp size | Tube O.D. mm | Tube NB | Tube O.D. | Order code | Order code | Order code |
|-----------------|--------------|-------------|--------------------|------------|-------------|-------------|
| 0 ³⁾ | 4.0 | G 1/8 | 1/4 5/16 3/8 | RAP9-004 | RAP10-004 | RAP12-004 |
| | 6.0 | | | RAP9-006 | RAP10-006 | RAP12-006 |
| | 6.4 | | | RAP9-006.4 | RAP10-006.4 | RAP12-006.4 |
| | 8.0 | | | RAP9-008 | RAP10-008 | RAP12-008 |
| | 9.5 | | | RAP9-009.5 | RAP10-009.5 | RAP12-009.5 |
| | 10.0 | | | RAP9-010 | RAP10-010 | RAP12-010 |
| 12.0 | RAP9-012 | RAP10-012 | RAP12-012 | | | |
| 1 | 4.0 | G 1/8 | 1/4 5/16 3/8 | RAP9-104 | RAP10-104 | RAP12-104 |
| | 6.0 | | | RAP9-106 | RAP10-106 | RAP12-106 |
| | 6.4 | | | RAP9-106.4 | RAP10-106.4 | RAP12-106.4 |
| | 8.0 | | | RAP9-108 | RAP10-108 | RAP12-108 |
| | 9.5 | | | RAP9-109.5 | RAP10-109.5 | RAP12-109.5 |
| | 10.0 | | | RAP9-110 | RAP10-110 | RAP12-110 |
| 12.0 | RAP9-112 | RAP10-112 | RAP12-112 | | | |
| 2 | 12.7 | G 1/4 | 1/2 | RAP9-212.7 | RAP10-212.7 | RAP12-212.7 |
| | 13.5 | | | RAP9-213.5 | RAP10-213.5 | RAP12-213.5 |
| | 14.0 | | | RAP9-214 | RAP10-214 | RAP12-214 |
| | 15.0 | G 3/8 | 5/8 | RAP9-215 | RAP10-215 | RAP12-215 |
| | 16.0 | | | RAP9-216 | RAP10-216 | RAP12-216 |
| | 17.2 | | | RAP9-217.2 | RAP10-217.2 | RAP12-217.2 |
| 18.0 | RAP9-218 | RAP10-218 | RAP12-218 | | | |
| 3 | 19.0 | G 1/2 | 3/4 | RAP9-319 | RAP10-319 | RAP12-319 |
| | 20.0 | | | RAP9-320 | RAP10-320 | RAP12-320 |
| | 21.3 | | | RAP9-321.3 | RAP10-321.3 | RAP12-321.3 |
| | 22.0 | | | RAP9-322 | RAP10-322 | RAP12-322 |
| | 23.0 | | | RAP9-323 | RAP10-323 | RAP12-323 |
| | 25.0 | | | RAP9-325 | RAP10-325 | RAP12-325 |
| 25.4 | RAP9-325.4 | RAP10-325.4 | RAP12-325.4 | | | |
| 4 | 26.9 | G 3/4 | 1 | RAP9-426.9 | RAP10-426.9 | RAP12-426.9 |
| | 28.0 | | | RAP9-428 | RAP10-428 | RAP12-428 |
| | 30.0 | | | RAP9-430 | RAP10-430 | RAP12-430 |
| 5 | 32.0 | G 1 | 1 1/4 | RAP9-532 | RAP10-532 | RAP12-532 |
| | 33.7 | | | RAP9-533.7 | RAP10-533.7 | RAP12-533.7 |
| | 35.0 | | | RAP9-535 | RAP10-535 | RAP12-535 |
| | 38.0 | G 1 1/4 | 1 1/2 | RAP9-538 | RAP10-538 | RAP12-538 |
| | 40.0 | | | RAP9-540 | RAP10-540 | RAP12-540 |
| | 42.0 | | | RAP9-542 | RAP10-542 | RAP12-542 |
| 6 | 44.5 | G 1 1/2 | 1 3/4 | RAP9-644.5 | RAP10-644.5 | RAP12-644.5 |
| | 45.0 | | | RAP9-645 | RAP10-645 | RAP12-645 |
| | 48.0 | | | RAP9-648 | RAP10-648 | RAP12-648 |
| | 50.0 | | | RAP9-650 | RAP10-650 | RAP12-650 |
| | 50.8 | | | RAP9-650.8 | RAP10-650.8 | RAP12-650.8 |
| | 52.0 | | | RAP9-652 | RAP10-652 | RAP12-652 |
| | 54.0 | | | RAP9-654 | RAP10-654 | RAP12-654 |
| | 55.0 | | | RAP9-655 | RAP10-655 | RAP12-655 |
| 57.0 | RAP9-657 | RAP10-657 | RAP12-657 | | | |

Continuation see next page ...



Tube clamps series A (Light construction series) – Complete range

Order codes for clamp halves:

| Material | Interior surface | Order code |
|---------------|------------------|--------------------------|
| Polypropylene | grooved | RAP |
| | smooth | RAPG |
| Polyamide | grooved | RAN |
| | smooth | RANG |
| Rubber | smooth | RAVG¹⁾ |
| Aluminium | grooved | RAA²⁾ |

(Please exchange as required standard abbreviation RAP in column for "Order code")

For flame- or corrosion retardant materials, please refer to page T5.

The steel parts of kits 9, 10 and 12 have the following surfaces:

Screws, bushes, cover plates = Cr(VI)-free galvanized

Welding plate = phosphated

Other compositions available on request.

2 clamp halves, rail nuts, slot head bolts and bushes

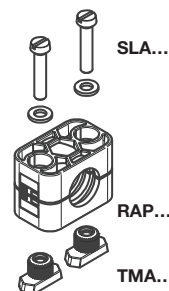

2 clamp halves, rail nuts, socket head bolts and bushes

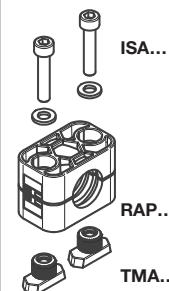

2 clamp halves, rail nuts, cover plate and hex. head bolts

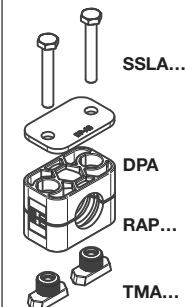

| clamp size | Tube O.D. mm | Tube NB | Tube O.D. | Order code | Order code | Order code |
|------------|--------------|-----------------|-------------------|--------------------|---------------------|---------------------|
| 7 | 57.2 | G 2 | 2 1/4 | RAP9-757.2 | RAP10-757.2 | RAP12-757.2 |
| | 60.3 | | RAP9-760.3 | RAP10-760.3 | RAP12-760.3 | |
| | 63.5 | | RAP9-763.5 | RAP10-763.5 | RAP12-763.5 | |
| | 70.0 | | RAP9-770 | RAP10-770 | RAP12-770 | |
| | 73.0 | RAP9-773 | RAP10-773 | RAP12-773 | | |
| | 76.1 | G 2 1/2 | 3 | RAP9-776.1 | RAP10-776.1 | RAP12-776.1 |
| 8 | 88.9 | G 3 | 3 1/2 | RAP9-888.9 | RAP10-888.9 | RAP12-888.9 |
| | 101.8 | | 4 | RAP9-8101.8 | RAP10-8101.8 | RAP12-8101.8 |

Delivery in unassembled individual components.

¹⁾ When assembling solid rubber clamps, cover plates, hexagon screws and locking washers must be used.

²⁾ Aluminium size 0-6.

³⁾ Contrary to the illustration size 0 clamps are secured by only one screw.

Tube clamps
Tube clamps series A – Complete range
Order codes for clamp halves:

| Material | Interior surface | Order code |
|---------------|------------------|--------------------|
| Polypropylene | grooved | RAP |
| | smooth | RAPG |
| Polyamide | grooved | RAN |
| | smooth | RANG |
| Rubber | smooth | RAVG ¹⁾ |
| Aluminium | grooved | RAA ²⁾ |

(Please exchange as required standard abbreviation RAP in column for "Order code")

For flame- or corrosion retardant materials, please refer to page T5.

The steel parts of kits 13 and 14 have the following surfaces:

Screws, bushes, cover plates = Cr(VI)-free galvanized

Welding plate = phosphated

Other compositions available on request.

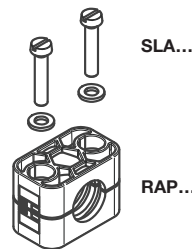
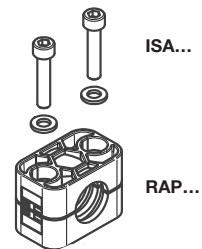
 2 clamp halves, slot
heads and bushes

 2 clamp halves,
socket head bolts and
bushes

| clamp size | Tube O.D. mm | Tube NB | Tube O.D. | Order code | Order code |
|-----------------|--------------|-------------|--------------------|-------------|-------------|
| 0 ³⁾ | 4.0 | G 1/8 | 1/4 5/16 3/8 | RAP13-004 | RAP14-004 |
| | 6.0 | | | RAP13-006 | RAP14-006 |
| | 6.4 | | | RAP13-006.4 | RAP14-006.4 |
| | 8.0 | | | RAP13-008 | RAP14-008 |
| | 9.5 | | | RAP13-009.5 | RAP14-009.5 |
| | 10.0 | | | RAP13-010 | RAP14-010 |
| | 12.0 | | | RAP13-012 | RAP14-012 |
| 1 | 4.0 | G 1/8 | 1/4 5/16 3/8 | RAP13-104 | RAP14-104 |
| | 6.0 | | | RAP13-106 | RAP14-106 |
| | 6.4 | | | RAP13-106.4 | RAP14-106.4 |
| | 8.0 | | | RAP13-108 | RAP14-108 |
| | 9.5 | | | RAP13-109.5 | RAP14-109.5 |
| | 10.0 | | | RAP13-110 | RAP14-110 |
| | 12.0 | | | RAP13-112 | RAP14-112 |
| 2 | 12.7 | G 1/4 | 1/2 | RAP13-212.7 | RAP14-212.7 |
| | 13.5 | | | RAP13-213.5 | RAP14-213.5 |
| | 14.0 | | | RAP13-214 | RAP14-214 |
| | 15.0 | G 3/8 | 5/8 | RAP13-215 | RAP14-215 |
| | 16.0 | | | RAP13-216 | RAP14-216 |
| | 17.2 | | | RAP13-217.2 | RAP14-217.2 |
| | 18.0 | | | RAP13-218 | RAP14-218 |
| 3 | 19.0 | G 1/2 | 3/4 1 | RAP13-319 | RAP14-319 |
| | 20.0 | | | RAP13-320 | RAP14-320 |
| | 21.3 | | | RAP13-321.3 | RAP14-321.3 |
| | 22.0 | | | RAP13-322 | RAP14-322 |
| | 23.0 | | | RAP13-323 | RAP14-323 |
| | 25.0 | | | RAP13-325 | RAP14-325 |
| | 25.4 | | | RAP13-325.4 | RAP14-325.4 |
| 4 | 26.9 | G 3/4 | | RAP13-426.9 | RAP14-426.9 |
| | 28.0 | | | RAP13-428 | RAP14-428 |
| | 30.0 | | | RAP13-430 | RAP14-430 |
| 5 | 32.0 | G 1 | 1 1/4 | RAP13-532 | RAP14-532 |
| | 33.7 | | | RAP13-533.7 | RAP14-533.7 |
| | 35.0 | | | RAP13-535 | RAP14-535 |
| | 38.0 | G 1 1/4 | 1 1/2 | RAP13-538 | RAP14-538 |
| | 40.0 | | | RAP13-540 | RAP14-540 |
| | 42.0 | | | RAP13-542 | RAP14-542 |
| | 6 | | | 44.5 | G 1 1/2 |
| 45.0 | | RAP13-645 | RAP14-645 | | |
| 48.0 | | RAP13-648 | RAP14-648 | | |
| 50.0 | | RAP13-650 | RAP14-650 | | |
| 50.8 | | RAP13-650.8 | RAP14-650.8 | | |
| 52.0 | | RAP13-652 | RAP14-652 | | |
| 54.0 | | RAP13-654 | RAP14-654 | | |
| 55.0 | | RAP13-655 | RAP14-655 | | |
| 57.0 | RAP13-657 | RAP14-657 | | | |

Continuation see next page ...



Tube clamps series A – Complete range

Order codes for clamp halves:

| Material | Interior surface | Order code |
|---------------|------------------|--------------------------|
| Polypropylene | grooved | RAP |
| | smooth | RAPG |
| Polyamide | grooved | RAN |
| | smooth | RANG |
| Rubber | smooth | RAVG¹⁾ |
| Aluminium | grooved | RAA²⁾ |

(Please exchange as required standard abbreviation RAP in column for "Order code")

For flame- or corrosion retardant materials, please refer to page T5.

The steel parts of kits 13 and 14 have the following surfaces:

Screws, bushes, cover plates = Cr(VI)-free galvanized

Welding plate = phosphated

Other compositions available on request.

2 clamp halves, slot heads and bushes

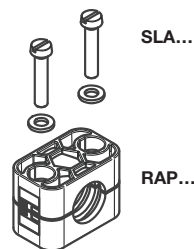

2 clamp halves, socket head bolts and bushes

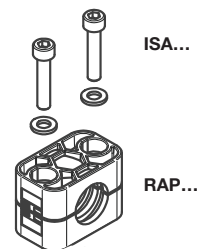

| clamp size | Tube O.D. mm | Tube NB | Tube O.D. | Order code | Order code |
|------------|--------------|---------|--------------------|---------------------|---------------------|
| 7 | 57.2 | G 2 | 2 1/4 | RAP13-757.2 | RAP14-757.2 |
| | 60.3 | | 2 1/2 | RAP13-760.3 | RAP14-760.3 |
| | 63.5 | | 2 3/4 | RAP13-763.5 | RAP14-763.5 |
| | 70.0 | | | RAP13-770 | RAP14-770 |
| | 73.0 | G 2 1/2 | 3 | RAP13-773 | RAP14-773 |
| 76.1 | | | RAP13-776.1 | RAP14-776.1 | |
| 8 | 88.9 | G3 | 3 1/2 | RAP13-888.9 | RAP14-888.9 |
| | 101.8 | | 4 | RAP13-8101.8 | RAP14-8101.8 |

Delivery in unassembled individual components.

¹⁾ When assembling solid rubber clamps, cover plates, hexagon screws and locking washers must be used.

²⁾ Aluminium size 0-6.

³⁾ Contrary to the illustration size 0 clamps are secured by only one screw.

Tube clamps

Tube clamps series A – Complete range

Order codes for clamp halves:

| Material | Interior surface | Order code |
|---------------|------------------|--------------------|
| Polypropylene | grooved | RAP |
| | smooth | RAPG |
| Polyamide | grooved | RAN |
| | smooth | RANG |
| Rubber | smooth | RAVG ¹⁾ |
| Aluminium | grooved | RAA ²⁾ |

(Please exchange as required standard abbreviation RAP in column for "Order code")

For flame- or corrosion retardant materials, please refer to page T5.

The steel parts of kits 16 and 18 have the following surfaces:

Screws, bushes, cover plates = Cr(VI)-free galvanized

Welding plate = phosphated

Other compositions available on request.

2 clamp halves, cover plate and hex. head bolts

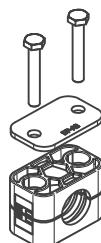

SSLA...

DPA...

RAP...

2 clamp halves, stacking bolts and locking plate

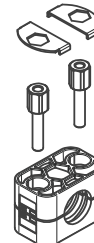

SBA...

ASA...

RAP...

| clamp size | Tube O.D. mm | Tube NB | Tube O.D. | Order code | Order code |
|-----------------|--------------|-----------|--------------------|-------------|-------------|
| 0 ³⁾ | 4.0 | G 1/8 | 1/4 5/16 3/8 | RAP16-004 | RAP18-004 |
| | 6.0 | | | RAP16-006 | RAP18-006 |
| | 6.4 | | | RAP16-006.4 | RAP18-006.4 |
| | 8.0 | | | RAP16-008 | RAP18-008 |
| | 9.5 | | | RAP16-009.5 | RAP18-009.5 |
| | 10.0 | | | RAP16-010 | RAP18-010 |
| 1 | 12.0 | G 1/8 | 3/8 | RAP16-012 | RAP18-012 |
| | 4.0 | | | RAP16-104 | RAP18-104 |
| | 6.0 | | | RAP16-106 | RAP18-106 |
| | 6.4 | | | RAP16-106.4 | RAP18-106.4 |
| | 8.0 | | | RAP16-108 | RAP18-108 |
| | 9.5 | | | RAP16-109.5 | RAP18-109.5 |
| 2 | 10.0 | G 3/8 | 5/8 | RAP16-110 | RAP18-110 |
| | 12.0 | | | RAP16-112 | RAP18-112 |
| | 12.7 | | | RAP16-212.7 | RAP18-212.7 |
| | 13.5 | | | RAP16-213.5 | RAP18-213.5 |
| | 14.0 | | | RAP16-214 | RAP18-214 |
| | 15.0 | | | RAP16-215 | RAP18-215 |
| 3 | 16.0 | G 1/2 | 1 | RAP16-216 | RAP18-216 |
| | 17.2 | | | RAP16-217.2 | RAP18-217.2 |
| | 18.0 | | | RAP16-218 | RAP18-218 |
| | 19.0 | | | RAP16-319 | RAP18-319 |
| | 20.0 | | | RAP16-320 | RAP18-320 |
| | 21.3 | | | RAP16-321.3 | RAP18-321.3 |
| 4 | 22.0 | G 3/4 | 1 1/4 | RAP16-322 | RAP18-322 |
| | 23.0 | | | RAP16-323 | RAP18-323 |
| | 25.0 | | | RAP16-325 | RAP18-325 |
| | 25.4 | | | RAP16-325.4 | RAP18-325.4 |
| | 26.9 | | | RAP16-426.9 | RAP18-426.9 |
| | 28.0 | | | RAP16-428 | RAP18-428 |
| 5 | 30.0 | G 1 | 1 1/2 | RAP16-430 | RAP18-430 |
| | 32.0 | | | RAP16-532 | RAP18-532 |
| | 33.7 | | | RAP16-533.7 | RAP18-533.7 |
| | 35.0 | | | RAP16-535 | RAP18-535 |
| | 38.0 | | | RAP16-538 | RAP18-538 |
| | 40.0 | | | RAP16-540 | RAP18-540 |
| 6 | 42.0 | G 1 1/4 | 2 | RAP16-542 | RAP18-542 |
| | 44.5 | | | RAP16-644.5 | RAP18-644.5 |
| | 45.0 | | | RAP16-645 | RAP18-645 |
| | 48.0 | | | RAP16-648 | RAP18-648 |
| | 50.0 | | | RAP16-650 | RAP18-650 |
| | 50.8 | | | RAP16-650.8 | RAP18-650.8 |
| | 52.0 | | | RAP16-652 | RAP18-652 |
| | 54.0 | | | RAP16-654 | RAP18-654 |
| | 55.0 | | | RAP16-655 | RAP18-655 |
| 57.0 | RAP16-657 | RAP18-657 | | | |

Continuation see next page ...



Tube clamps series A – Complete range

Order codes for clamp halves:

| Material | Interior surface | Order code |
|---------------|------------------|--------------------------|
| Polypropylene | grooved | RAP |
| | smooth | RAPG |
| Polyamide | grooved | RAN |
| | smooth | RANG |
| Rubber | smooth | RAVG¹⁾ |
| Aluminium | grooved | RAA²⁾ |

(Please exchange as required standard abbreviation RAP in column for "Order code")

For flame- or corrosion retardant materials, please refer to page T5.

The steel parts of kits 16 and 18 have the following surfaces:

Screws, bushes, cover plates = Cr(VI)-free galvanized

Welding plate = phosphated

Other compositions available on request.

2 clamp halves, cover plate and hex. head bolts



SSLA

DPA...

RAP...

2 clamp halves, stacking bolts and locking plate



SBA...

ASA...

RAP...

| clamp size | Tube O.D. mm | Tube NB | Tube O.D. | Order code | Order code |
|------------|---------------------|---------------------|--------------------|--------------------|--------------------|
| 7 | 57.2 | G 2 | 2 1/4 | RAP16-757.2 | RAP18-757.2 |
| | 60.3 | | 2 1/2 | RAP16-760.3 | RAP18-760.3 |
| | 63.5 | | 2 3/4 | RAP16-763.5 | RAP18-763.5 |
| | 70.0 | | G 2 1/2 | 3 | RAP16-770 |
| | 73.0 | RAP16-773 | | | RAP18-773 |
| 76.1 | G 3 | 3 1/2 | RAP16-776.1 | RAP18-776.1 | |
| 88.9 | | | 4 | RAP16-888.9 | RAP18-888.9 |
| 101.8 | RAP16-8101.8 | RAP18-8101.8 | | | |

Delivery in unassembled individual components.

¹⁾ When assembling solid rubber clamps, cover plates, hexagon screws and locking washers must be used.

²⁾ Aluminium sizes 0-6.

³⁾ Contrary to the illustration size 0 clamps are secured by only one screw.

Tube clamps

Tube clamps series B (Twin-tube clamps) – Components

DIN 3015, part 3

Order codes for clamp halves:

| Material | Interior surface | Order code |
|---------------|------------------|--------------------|
| Polypropylene | grooved | RBP |
| | smooth | RBPG |
| Polyamide | grooved | RBN |
| | smooth | RBNG |
| Rubber | smooth | RBVG ¹⁾ |

(Please exchange as required standard abbreviation RBP in column for "clamp halves")

For flame- or corrosion retardant materials, please refer to page T5.

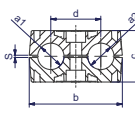
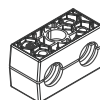

Width: 30 mm

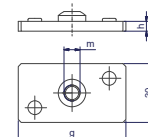
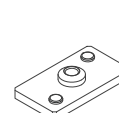

| clamp size | Tube O.D. mm | Tube NB | Tube O.D. | 1 part 2 clamp halves ²⁾ | | | | weld plate with locking device | | | | |
|------------|--------------|---------|--------------------|---|------------------------|------|----|-----------------------------------|----------------------|----------------------|----|---|
| | | | | RBP... Order code | dimensions: b c d s | | | | APB... Order code | dimensions: g m h | | |
| 1 | 6.0 | G 1/8 | 1/4 5/16 3/8 | RBP106X RBP106.4X RBP108X RBP109.5X RBP110X RBP112X | 36 | 27.0 | 20 | 1.0 | APB1...* | 37 | M6 | 3 |
| | 6.4 | | | | | | | | | | | |
| | 8.0 | | | | | | | | | | | |
| | 9.5 | | | | | | | | | | | |
| | 10.0 | | | | | | | | | | | |
| 12.0 | | | | | | | | | | | | |
| 2 | 12.7 | G 1/4 | 1/2 | RBP212.7X RBP213.5X RBP214X RBP215X RBP216X RBP217.2X RBP218X | 53 | 27.4 | 29 | 1.2 | APB2...* | 55 | M8 | 5 |
| | 13.5 | | | | | | | | | | | |
| | 14.0 | | | | | | | | | | | |
| | 15.0 | G 3/8 | 5/8 | RBP319X RBP320X RBP321.3X RBP322X RBP325X RBP325.4X | 67 | 37.0 | 36 | 1.6 | APB3...* | 70 | M8 | 5 |
| | 16.0 | | | | | | | | | | | |
| | 17.2 | | | | | | | | | | | |
| 18.0 | | | | | | | | | | | | |
| 3 | 19.0 | G 1/2 | 3/4 | RBP426.9X RBP428X RBP430X | 82 | 42.0 | 45 | 2.0 | APB4...* | 85 | M8 | 5 |
| | 20.0 | | | | | | | | | | | |
| | 21.3 | | | | | | | | | | | |
| | 22.0 | | | | | | | | | | | |
| 4 | 25.0 | G 3/4 | 1 | RBP532X RBP533.7X RBP535X RBP538X RBP540X RBP542X | 106 | 54.0 | 56 | 2.0 | APB5...* | 110 | M8 | 5 |
| | 25.4 | | | | | | | | | | | |
| | 26.9 | | | | | | | | | | | |
| | 28.0 | | | | | | | | | | | |
| | 30.0 | | | | | | | | | | | |
| 5 | 32.0 | G 1 | 1 1/4 | RBP532X RBP533.7X RBP535X RBP538X RBP540X RBP542X | 106 | 54.0 | 56 | 2.0 | APB5...* | 110 | M8 | 5 |
| | 33.7 | | | | | | | | | | | |
| | 35.0 | | | | | | | | | | | |
| | 38.0 | | | | | | | | | | | |
| | 40.0 | | | | | | | | | | | |
| | 42.0 | | | | | | | | | | | |

¹⁾ When assembling solid rubber clamps, cover plates, hexagon screws and locking washers must be used.

²⁾ Twin-tube clamps with different outer tube diameters upon request.

*Please add the suffix below according to the surface/material required.

| Order code suffixes | | |
|---------------------------------|--------|-----------|
| Surface/material | Suffix | Example |
| Steel, phosphated | X | APB1X |
| Steel, zinc plated, Cr(VI)-free | VZX | APB1VZX |
| Stainless Steel 1.4571 | 4571X | APB14571X |

Tube clamps series B (Twin-tube clamps) – Components

DIN 3015, part 3

| clamp size | weld plate, angled | | mounting rail nut | | | | | | mounting rail nut | | | | | |
|------------|--|-------------------------|---|--------------------------|------|----|----|------|--|--------------------------|------|----|----|------|
| | TS...A/B Order code | dimensions: h | TM Order code | dimensions: a b c m h | | | | | TMA/TMB1... Order code | dimensions: a b c m h | | | | |
| 1 | | | TMA/TMB1VERZX TMA/TMB1/4571X | 25.4 | 10.4 | 12 | M6 | 14.5 | TMA/TMB1WLPVZX TMA/TMB1WLP71X | 25.4 | 10.4 | 12 | M6 | 14.5 |
| 2 | TS11A/B1...* TS11A/B2...* TS14A/B1...* TS14B/B2...* TS30A/B1...* TS30B/B2...* | TS11: TS14: TS30: | TMB2VZX TMB24571X | 25.4 | 10.4 | 14 | M8 | 13.0 | | | | | | |
| 3 | | | | | | | | | | | | | | |
| 4 | | | | | | | | | | | | | | |
| 5 | | | | | | | | | | | | | | |

*Please add the suffix below according to the surface/material required.

| Order code suffixes | | |
|---------------------------------|------------|-------------|
| Surface/material | Suffix | Example |
| Steel, phosphated | X | TS11A/B1X |
| Steel, zinc plated, Cr(VI)-free | VZX | TS11A/B1VZX |
| Stainless Steel 1.4571 | 71X | TS11A/B171X |

T

Tube clamps

Tube clamps series B (Twin-tube clamps) – Components

DIN 3015, part 3

| clamp size | weld plate angled (5 clamps) | | | cover plate | | hexagonal screws | | | |
|------------|----------------------------------|----------------------|-----|-----------------------|--------------------|------------------|-----------------------|----------------------|---------|
| | APR B... Order code | dimensions: d e s | | DP B... Order code | dimensions: b d | | SS B... Order code | dimensions: d x L | |
| 1 | APRB1X APRB1VZX APRB4571X | 40 | 196 | 3 | DPB1...* | 34 | 6.6 | SSLA2/SSB1...* | M 06x35 |
| 2 | APRB2X APRB2VZX APRB24571X | 58 | 288 | 5 | DPB2...* | 51 | 8.6 | SSB2...* | M 08x35 |
| 3 | APRB3X APRB3VZX APRB34571X | 72 | 358 | 5 | DPB3...* | 64 | 8.6 | SSB3...* | M 08x45 |
| 4 | APRB4X APRB4VZX APRB44571X | 90 | 446 | 5 | DPB4...* | 78 | 8.6 | SSB4...* | M 08x50 |
| 5 | APRB5X APRBVZX APRB4571X | 112 | 558 | 5 | DPB5...* | 102 | 8.6 | SSB5...* | M 08x60 |

| clamp size | socket head | | stacking | | locking plate ¹⁾ | | locking washer ²⁾ | |
|------------|------------------------|----------------------|------------------------|-----------------------|-----------------------------|-------------|------------------------------|--------------------|
| | IS B... Order code | dimensions: d x L | AS B... Order code | dimensions: a m SW | SB B... Order code | dim.: SW | US... Order code | dimensions: a b |
| 1 | ISA4...* (ISB1...*) | M 06x35 | ASA0...* (ASB1...*) | 20 M6 11 | SBB1...* | 11 | USA/USB1X ³⁾ | 9 18 |
| 2 | ISB2...* | M 08x35 | ASB2...* | 22 M8 12 | SBB2...* | 12 | USB2X USB271X | 11 20 |
| 3 | ISB3...* | M 08x45 | ASB3...* | 30 M8 12 | | | | |
| 4 | ISB4...* | M 08x50 | ASB4...* | 35 M8 12 | | | | |
| 5 | ISB5...* | M 08x60 | ASB5...* | 47 M8 12 | | | | |

1) The use of stacking screws necessitates the use of locking plates in the construction assembly!

2) When assembling solid rubber clamps, covering plates, hexagon screws and locking washers must be used.

3) Material = Stainless steel 1.4571

*Please add the suffix below according to the surface/material required.

| Order code suffixes | | |
|---------------------------------|--------|-----------|
| Surface/material | Suffix | Example |
| Steel, zinc plated, Cr(VI)-free | X | DPB1X |
| Stainless Steel 1.4571 | 71X | DPB14571X |



Tube clamps series B – Complete range

Order codes for clamp halves:

| Material | Interior surface | Order code |
|---------------|------------------|--------------------|
| Polypropylene | grooved | RBP |
| | smooth | RBPG |
| Polyamide | grooved | RBN |
| | smooth | RBNG |
| Rubber | smooth | RBVG ¹⁾ |

(Please exchange as required standard abbreviation RBP in column for "Order code")

For flame- or corrosion retardant materials, please refer to page T5.

The steel parts of kits 1, 16 and 3 have the following surfaces:

Screws, bushes, cover plates = Cr(VI)-free galvanized

Welding plate = phosphated

Other compositions available on request.

2 clamp halves, weld plate, cover plate, hex. head bolt

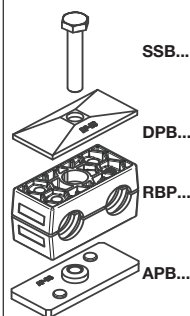

2 clamp halves, cover plate, hex. head bolt

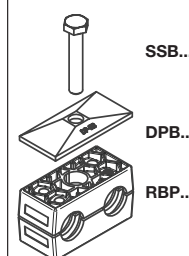

2 clamp halves, weld plate, cover plate, socket head bolt

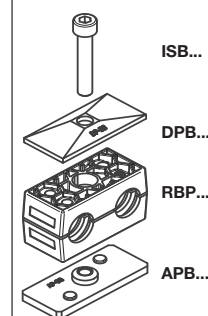

| clamp size | Tube O.D. mm | Tube NB | Tube O.D. | Order code | Order code | Order code | |
|------------|--------------|---------|-----------|------------|-------------|-------------|------------|
| 1 | 6.0 | G 1/8 | 1/4 | RBP1-106 | RBP16-106 | RBP3-106 | |
| | 6.4 | | | RBP1-106.4 | RBP16-106.4 | RBP3-106.4 | |
| | 8.0 | | | RBP1-108 | RBP16-108 | RBP3-108 | |
| | 9.5 | | | RBP1-109.5 | RBP16-109.5 | RBP3-109.5 | |
| | 10.0 | | | RBP1-110 | RBP16-110 | RBP3-110 | |
| | 12.0 | | | RBP1-112 | RBP16-112 | RBP3-112 | |
| 2 | 12.7 | G 1/4 | 1/2 | RBP1-212.7 | RBP16-212.7 | RBP3-212.7 | |
| | 13.5 | | | RBP1-213.5 | RBP16-213.5 | RBP3-213.5 | |
| | 14.0 | | | RBP1-214 | RBP16-214 | RBP3-214 | |
| | 15.0 | | | RBP1-215 | RBP16-215 | RBP3-215 | |
| | 16.0 | G 3/8 | 5/8 | RBP1-216 | RBP16-216 | RBP3-216 | |
| | 17.2 | | | RBP1-217.2 | RBP16-217.2 | RBP3-217.2 | |
| | 18.0 | | | RBP1-218 | RBP16-218 | RBP3-218 | |
| | | | | | | | |
| 3 | 19.0 | G 1/2 | 3/4 | RBP1-319 | RBP16-319 | RBP3-319 | |
| | 20.0 | | | RBP1-320 | RBP16-320 | RBP3-320 | |
| | 21.3 | | | RBP1-321.3 | RBP16-321.3 | RBP3-321.3 | |
| | 22.0 | | | RBP1-322 | RBP16-322 | RBP3-322 | |
| | 25.0 | | | 1 | RBP1-325 | RBP16-325 | RBP3-325 |
| | 25.4 | | | | RBP1-325.4 | RBP16-325.4 | RBP3-325.4 |
| 4 | 26.9 | G 3/4 | | RBP1-426.9 | RBP16-426.9 | RBP3-426.9 | |
| | 28.0 | | | RBP1-428 | RBP16-428 | RBP3-428 | |
| | 30.0 | | | RBP1-430 | RBP16-430 | RBP3-430 | |
| 5 | 32.0 | G 1 | 1 1/4 | RBP1-532 | RBP16-532 | RBP3-532 | |
| | 33.7 | | | RBP1-533.7 | RBP16-533.7 | RBP3-533.7 | |
| | 35.0 | | | RBP1-535 | RBP16-535 | RBP3-535 | |
| | 38.0 | 1 1/2 | RBP1-538 | RBP16-538 | RBP3-538 | | |
| | 40.0 | | RBP1-540 | RBP16-540 | RBP3-540 | | |
| | 42.0 | | RBP1-542 | RBP16-542 | RBP3-542 | | |

Delivery in unassembled individual components.

¹⁾ When assembling solid rubber clamps, covering plates, hexagon screws and locking washers must be used.

Tube clamps

Tube clamps series B – Complete range

Order codes for clamp halves:

| Material | Interior surface | Order code |
|---------------|------------------|--------------------|
| Polypropylene | grooved | RBP |
| | smooth | RBPG |
| Polyamide | grooved | RBN |
| | smooth | RBNG |
| Rubber | smooth | RBVG ¹⁾ |

(Please exchange as required standard abbreviation RBP in column for "Order code")

For flame- or corrosion retardant materials, please refer to page T5.

The steel parts of kits 4, 5 and 8 have the following surfaces:

Screws, bushes, cover plates = Cr(VI)-free galvanized

Welding plate = phosphated

Other compositions available on request.

 2 clamp halves,
rail nut, cover plate,
hex. head bolt

SSB...

DPB...

RBP...

TMB...

 2 clamp halves,
rail nut, cover plate,
socket head bolt

ISB...

DPB...

RBP...

TMB...

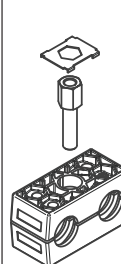
 2 clamp halves,
locking plate,
stacking bolt

SBB...

ASB...

RBP...

| clamp size | Tube O.D. mm | Tube NB | Tube O.D. | Order code | Order code | Order code |
|------------|--------------|----------|-----------|------------|------------|------------|
| 1 | 6.0 | G 1/8 | 1/4 | RBP4-106 | RBP5-106 | RBP8-106 |
| | 6.4 | | | RBP4-106.4 | RBP5-106.4 | RBP8-106.4 |
| | 8.0 | | | RBP4-108 | RBP5-108 | RBP8-108 |
| | 9.5 | | | RBP4-109.5 | RBP5-109.5 | RBP8-109.5 |
| | 10.0 | | | RBP4-110 | RBP5-110 | RBP8-110 |
| | 12.0 | | | RBP4-112 | RBP5-112 | RBP8-112 |
| 2 | 12.7 | G 1/4 | 1/2 | RBP4-212.7 | RBP5-212.7 | RBP8-212.7 |
| | 13.5 | | | RBP4-213.5 | RBP5-213.5 | RBP8-213.5 |
| | 14.0 | | | RBP4-214 | RBP5-214 | RBP8-214 |
| | 15.0 | G 3/8 | 5/8 | RBP4-215 | RBP5-215 | RBP8-215 |
| | 16.0 | | | RBP4-216 | RBP5-216 | RBP8-216 |
| | 17.2 | | | RBP4-217.2 | RBP5-217.2 | RBP8-217.2 |
| 18.0 | RBP4-218 | RBP5-218 | RBP8-218 | | | |
| 3 | 19.0 | G 1/2 | 3/4 | RBP4-319 | RBP5-319 | RBP8-319 |
| | 20.0 | | | RBP4-320 | RBP5-320 | RBP8-320 |
| | 21.3 | | | RBP4-321.3 | RBP5-321.3 | RBP8-321.3 |
| | 22.0 | | | RBP4-322 | RBP5-322 | RBP8-322 |
| | 25.0 | | | RBP4-325 | RBP5-325 | RBP8-325 |
| | 25.4 | | | RBP4-325.4 | RBP5-325.4 | RBP8-325.4 |
| 4 | 26.9 | G 3/4 | 1 | RBP4-426.9 | RBP5-426.9 | RBP8-426.9 |
| | 28.0 | | | RBP4-428 | RBP5-428 | RBP8-428 |
| | 30.0 | | | RBP4-430 | RBP5-430 | RBP8-430 |
| 5 | 32.0 | G 1 | 1 1/4 | RBP4-532 | RBP5-532 | RBP8-532 |
| | 33.7 | | | RBP4-533.7 | RBP5-533.7 | RBP8-533.7 |
| | 35.0 | | | RBP4-535 | RBP5-535 | RBP8-535 |
| | 38.0 | | 1 1/2 | RBP4-538 | RBP5-538 | RBP8-538 |
| | 40.0 | | | RBP4-540 | RBP5-540 | RBP8-540 |
| | 42.0 | | | RBP4-542 | RBP5-542 | RBP8-542 |

Delivery in unassembled individual components.

¹⁾ When assembling solid rubber clamps, covering plates, hexagon screws and locking washers must be used.



Tube clamps series C (Heavy series) – Components

DIN 3015, part 2

Order codes for clamp halves:

| Material | Interior surface | Order code |
|---------------|------------------|----------------------|
| Polypropylene | grooved | RCP |
| | smooth | RCPG ¹⁾ |
| Polyamide | grooved | RCN |
| | smooth | RCNG ¹⁾ |
| Rubber | grooved | RCVR ¹⁾²⁾ |
| | smooth | RCVG ¹⁾²⁾ |
| Aluminium | grooved | RCA |

(Please exchange as required standard abbreviation RCP in column for "clamp halves")

For flame- or corrosion retardant materials, please refer to page T5.

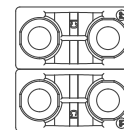
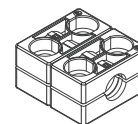
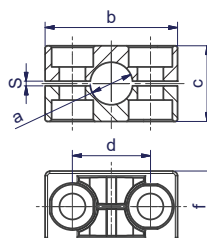
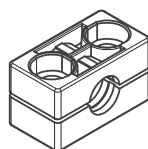

Please order 2x the single clamp (e.g. 2x RCP...)

| clamp size | Tube O.D. mm a | Tube NB | Tube O.D. | 1 part 2 clamp halves | | | | | dimensions: f | |
|------------|----------------------|-----------|-----------|--------------------------|-----|----|----|---|------------------|----|
| | | | | RCP... Order code | b | c | d | s | | f |
| 1 | 6.0 | G 1/8 | 5/16 | RCP106X | 56 | 32 | 33 | 2 | 30 | 60 |
| | 8.0 | | | RCP108X | | | | | | |
| | 9.5 | | RCP109.5X | | | | | | | |
| | 10.0 | | RCP110X | | | | | | | |
| | 12.0 | | RCP112X | | | | | | | |
| | 12.7 | G 1/4 | 1/2 | RCP112.7X | | | | | | |
| | 13.5 | RCP113.5X | | | | | | | | |
| | 14.0 | G 3/8 | 5/8 | RCP114X | | | | | | |
| | 15.0 | | | RCP115X | | | | | | |
| | 16.0 | | | RCP116X | | | | | | |
| | 17.2 | | | RCP117.2X | | | | | | |
| 18.0 | RCP118X | | | | | | | | | |
| 2 | 19.0 | G 1/2 | 3/4 | RCP219X | 71 | 48 | 45 | 2 | 30 | 60 |
| | 20.0 | | | RCP220X | | | | | | |
| | 21.3 | | RCP221.3X | | | | | | | |
| | 22.0 | | RCP222X | | | | | | | |
| | 23.0 | | RCP223X | | | | | | | |
| | 25.0 | G 3/4 | 1 | RCP225X | | | | | | |
| | 25.4 | RCP225.4X | | | | | | | | |
| | 26.9 | RCP226.9X | | | | | | | | |
| | 28.0 | RCP228X | | | | | | | | |
| | 30.0 | RCP230X | | | | | | | | |
| 3 | 30.0 | G 1 | 1 1/4 | RCP330X | 86 | 60 | 60 | 2 | 30 | 60 |
| | 32.0 | | | RCP332X | | | | | | |
| | 33.7 | | RCP333.7X | | | | | | | |
| | 35.0 | | RCP335X | | | | | | | |
| | 38.0 | | RCP338X | | | | | | | |
| | 40.0 | G 1 1/4 | 1 1/2 | RCP340X | | | | | | |
| | 42.0 | RCP342X | | | | | | | | |
| 4 | 38.0 | G 1 1/4 | 1 1/2 | RCP438X | 117 | 90 | 90 | 3 | 45 | 90 |
| | 40.0 | | | RCP440X | | | | | | |
| | 42.0 | | RCP442X | | | | | | | |
| | 45.0 | | RCP445X | | | | | | | |
| | 48.3 | G 1 1/2 | 2 | RCP448.3X | | | | | | |
| | 50.0 | RCP450X | | | | | | | | |
| | 51.0 | RCP451X | | | | | | | | |
| | 52.0 | RCP452X | | | | | | | | |
| | 55.0 | G 2 | 2 1/4 | RCP455X | | | | | | |
| | 57.0 | | | RCP457X | | | | | | |
| | 60.3 | | 2 1/2 | RCP460.3X | | | | | | |
| | 63.0 | | | RCP463X | | | | | | |
| | 65.0 | | RCP465X | | | | | | | |
| | 70.0 | | 2 3/4 | RCP470X | | | | | | |

Continuation see next page ...



Tube clamps

Tube clamps series C (Heavy series) – Components (Continued)

DIN 3015, part 2

Order codes for clamp halves:

| Material | Interior surface | Order code |
|---------------|------------------|----------------------|
| Polypropylene | grooved | RCP |
| | smooth | RCPG ¹⁾ |
| Polyamide | grooved | RCN |
| | smooth | RCNG ¹⁾ |
| Rubber | grooved | RCVR ¹⁾²⁾ |
| | smooth | RCVG ¹⁾²⁾ |
| Aluminium | grooved | RCA |

(Please exchange as required standard abbreviation RCP in column for "clamp halves")
 For flame- or corrosion retardant materials, please refer to page T5.

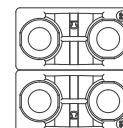
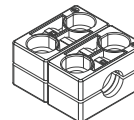
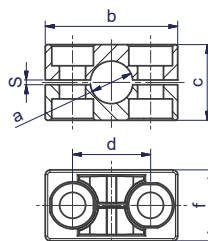
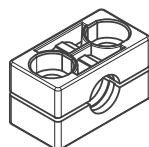

Please order 2x the single clamp (e.g. 2x RCP...)

| clamp size | Tube O.D. mm a | Tube NB | Tube O.D. | 1 part 2 clamp halves | | | | | dimensions: f | | | | | | | | |
|------------|-------------------|------------|-----------|--------------------------|------------|-----|-----|-----|------------------|-----|----------|--------|-----|-----|----|-----|-----|
| | | | | RCP... Order code | b | c | d | s | | f | | | | | | | |
| 5 | 65.0 | G 2 1/2 | 2 3/4 | RCP565X | 154 | 120 | 122 | 5 | 60 | 120 | | | | | | | |
| | 70.0 | | | RCP570X | | | | | | | | | | | | | |
| | 73.0 | | | RCP573X | | | | | | | | | | | | | |
| | 75.0 | | | RCP575X | | | | | | | | | | | | | |
| | 76.1 | | | RCP576.1X | | | | | | | | | | | | | |
| | 80.0 | RCP580X | | | | | | | | | | | | | | | |
| | 82.5 | RCP582.5X | | | | | | | | | | | | | | | |
| | 85.0 | RCP585X | | | | | | | | | | | | | | | |
| | 88.0 | RCP588X | | | | | | | | | | | | | | | |
| | 88.9 | RCP588.9X | | | | | | | | | | | | | | | |
| 90.0 | RCP590X | G 3 | 3 1/2 | | | | | | | | | | | | | | |
| 6 | 90.0 | G 3 1/2 | 4 | RCP690X | 206 | 168 | 168 | 6 | 80 | 160 | | | | | | | |
| | 97.0 | | | RCP697X | | | | | | | | | | | | | |
| | 100.0 | | | RCP6100X | | | | | | | | | | | | | |
| | 101.6 | | | RCP6101.6X | | | | | | | | | | | | | |
| | 108.0 | | | RCP6108X | | | | | | | | | | | | | |
| | 114.3 | RCP6114.3X | | | | | | | | | | | | | | | |
| | 115.0 | RCP6115X | | | | | | | | | | | | | | | |
| | 120.0 | RCP6120X | | | | | | | | | | | | | | | |
| | 127.0 | RCP6127X | G 4 | 4 1/2 | | | | | | | | | | | | | |
| | 7 | 127.0 | G 5 | 5 | | | | | | | RCP7127X | 251 | 200 | 205 | 6 | 90 | 180 |
| 130.0 | | RCP7130X | | | | | | | | | | | | | | | |
| 133.0 | | RCP7133X | | | | | | | | | | | | | | | |
| 140.0 | | RCP7140X | | | | | | | | | | | | | | | |
| 150.0 | | RCP7150X | | | | | | | | | | | | | | | |
| 152.4 | | RCP7152.4X | | | | | | | | | | | | | | | |
| 159.0 | | RCP7159X | | | | | | | | | | | | | | | |
| 165.1 | | RCP7165.1X | | | | | | | | | | | | | | | |
| 168.3 | | RCP7168.3X | G 5 1/2 | 6 | | | | | | | | | | | | | |
| 8 | | 168.3 | G 6 | 6 5/8 | RCP8168.3X | 320 | 270 | 265 | 6 | 120 | 240 | | | | | | |
| | 177.8 | RCP8177.8X | | | | | | | | | | | | | | | |
| | 190.0 | RCP8190X | | | | | | | | | | | | | | | |
| | 193.7 | RCP8193.7X | | | | | | | | | | | | | | | |
| | 203.0 | RCP8203X | | | | | | | | | | | | | | | |
| | 219.1 | RCP8219.1X | | | | | | | | | | | | | | | |
| | 220.0 | RCP8220X | G 6 | 7 | | | | | | | | | | | | | |
| | 9 | 219.1 | G 8 | 8 5/8 | RCP9219.1X | | | | | | | 470 | 410 | 395 | 20 | 162 | 324 |
| | | 244.5 | | | RCP9244.5X | | | | | | | | | | | | |
| | | 273.0 | | | RCP9273X | | | | | | | | | | | | |
| 323.9 | | RCP9323.9X | | | | | | | | | | | | | | | |
| 10 | 355.6 | G 14 | 10 3/4 | RCP10355.6X | 630 | 530 | 534 | 20 | 182 | 364 | | | | | | | |
| | 406.4 | | | RCP10406.4X | | | | | | | G 12 | 12 3/4 | | | | | |

¹⁾ Only sizes 1–8

²⁾ When assembling solid rubber clamps, covering plates, hexagon screws and locking washers must be used.

Tube clamps series C (Heavy series) – Components

DIN 3015, part 2

| clamp size | weld plate | | | | | double weld plate | | | | | weld/screw plate | | | | | mounting rail | | | | |
|------------|-----------------------|-------------|-----|-----|----|-------------------|-----------------------|-------------|-----|-----|------------------|-----|------------------------|-------------|-----|---------------|-----|----|---------------------------------|---------------------------------|
| | AP C... Order code | dimensions: | | | | | APDC... Order code | dimensions: | | | | | APL C... Order code | dimensions: | | | | | TS C... Order code | length: l |
| | | d | f | g | i | m | | d | f | g | i | m | | g | f | i | k | n | | |
| 1 | APC1...* | 33 | 30 | 73 | 8 | M10 | APDC1...* | 33 | 60 | 73 | 8 | M10 | APLC1...* | 113 | 30 | 8 | 85 | 11 | TSC1X TSC1VERZX TSC14571X | 1 m |
| 2 | APC2...* | 45 | 30 | 84 | 8 | M10 | APDC2...* | 45 | 60 | 84 | 8 | M10 | APLC2...* | 125 | 30 | 8 | 97 | 11 | | TSC2X TSC2VERZX TSC24571X |
| 3 | APC3...* | 60 | 30 | 100 | 8 | M10 | APDC3...* | 60 | 60 | 100 | 8 | M10 | APLC3...* | 140 | 30 | 8 | 112 | 11 | | |
| 4 | APC4...* | 90 | 45 | 140 | 10 | M12 | APDC4...* | 90 | 90 | 140 | 10 | M12 | APLC4...* | 190 | 45 | 10 | 160 | 14 | | |
| 5 | APC5...* | 122 | 60 | 180 | 10 | M16 | APDC5...* | 122 | 120 | 180 | 10 | M16 | APLC5...* | 240 | 60 | 10 | 205 | 18 | | |
| 6 | APC6...* | 168 | 80 | 225 | 15 | M20 | APDC6...* | 168 | 160 | 225 | 15 | M20 | APLC6...* | 310 | 80 | 15 | 270 | 22 | | |
| 7 | APC7...* | 205 | 90 | 270 | 15 | M24 | APDC7...* | 205 | 180 | 270 | 15 | M24 | APLC7...* | 370 | 90 | 15 | 320 | 26 | | |
| 8 | APC8...* | 265 | 120 | 340 | 25 | M30 | APDC8...* | 265 | 240 | 340 | 25 | M30 | APLC8...* | 450 | 120 | 25 | 390 | 33 | | |
| 9 | APC9...* | 395 | 160 | 520 | 30 | M30 | APDC9...* | 395 | 330 | 520 | 30 | M30 | | | | | | | | |
| 10 | APC10...* | 534 | 180 | 680 | 30 | M30 | APDC10...* | 534 | 364 | 680 | 30 | M30 | | | | | | | | |

Complete programme range please refer to page T34.

*Please add the suffix below according to the surface/material required.

| Order code suffixes | | |
|---------------------------------|--------|-----------|
| Surface/material | Suffix | Example |
| Steel, phosphated | X | APC1X |
| Steel, zinc plated, Cr(VI)-free | VZX | APC1VZX |
| Stainless Steel 1.4571 | 4571X | APC14571X |

T

Tube clamps

Tube clamps series C (Heavy series) – Components

DIN 3015, part 2

| clamp size | rail nut | | | cover plate | | | | | double cover plate | | | | | hexagon head | | | | |
|------------|-----------------------|-------------|------|-------------|-----------------------|-------------|-----|-----|--------------------|----|------------------------|-------------|-----|--------------|----|----|-----------------------|-------------|
| | TM C... Order code | dimensions: | | | DP C... Order code | dimensions: | | | | | DPD C... Order code | dimensions: | | | | | SS C... Order code | dimensions: |
| | | b | d | m | | b | d | f | i | m | | b | d | f | i | m | | d x L |
| 1 | TMC1VZX TMC14571X | 20 | 12.0 | M10 | DPC1...* | 55 | 33 | 30 | 8 | 11 | DPDC1...* | 55 | 33 | 60 | 8 | 11 | SSC1...* | M 10x40 |
| 2 | | | | | DPC2...* | 70 | 45 | 30 | 8 | 11 | DPDC2...* | 70 | 45 | 60 | 8 | 11 | SSC2...* | M 10x60 |
| 3 | | | | | DPC3...* | 85 | 60 | 30 | 8 | 11 | DPDC3...* | 85 | 60 | 60 | 8 | 11 | SSC3...* | M 10x70 |
| 4 | TMC4VZX TMC44571X | 23 | 12.5 | M12 | DPC4...* | 115 | 90 | 45 | 10 | 14 | DPDC4...* | 115 | 90 | 90 | 10 | 14 | SSC4...* | M 12x100 |
| 5 | - | - | - | - | DPC5...* | 152 | 122 | 60 | 10 | 18 | DPDC5...* | 152 | 122 | 120 | 10 | 18 | SSC5...* | M 16x130 |
| 6 | | | | | DPC6...* | 205 | 168 | 80 | 15 | 22 | DPDC6...* | 205 | 168 | 160 | 15 | 24 | SSC6...* | M 20x190 |
| 7 | | | | | DPC7...* | 251 | 205 | 90 | 15 | 28 | DPDC7...* | 250 | 205 | 180 | 15 | 28 | SSC7...* | M 24x220 |
| 8 | | | | | DPC8...* | 320 | 265 | 120 | 25 | 35 | DPDC8...* | 322 | 265 | 240 | 25 | 35 | SSC8...* | M 30x300 |
| 9 | | | | | DPC9...* | 470 | 395 | 160 | 30 | 35 | DPDC9...* | 466 | 395 | 330 | 30 | 35 | SSC9...* | M 30x450 |
| 10 | | | | | DPC10...* | 630 | 534 | 180 | 30 | 35 | DPDC10...* | 630 | 534 | 360 | 30 | 35 | SSC10...* | M 30x560 |

*Please add the suffix below according to the surface/material required.

| Order code suffixes | | |
|---------------------------------|--------------|-----------|
| Surface/material | Suffix | Example |
| Steel, phosphated | X | DPC1X |
| Steel, zinc plated, Cr(VI)-free | VZX | DPC1VZX |
| Stainless Steel 1.4571 | 4571X | DPC14571X |

Tube clamps series C (Heavy series) – Components

DIN 3015, part 2

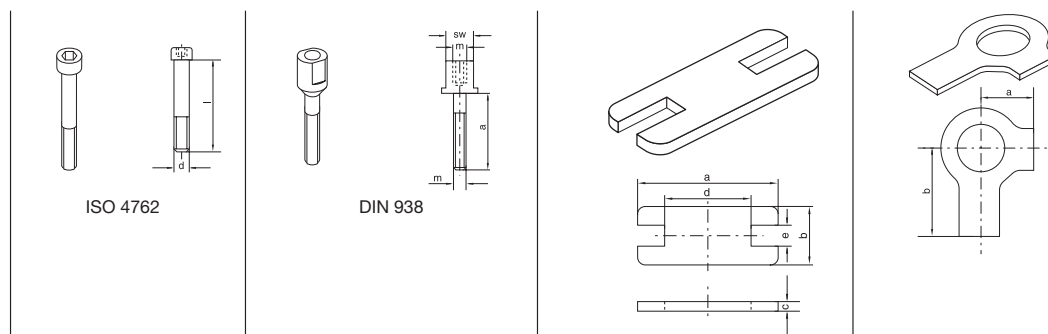

| clamp size | socket head | | stacking | | | locking plate ¹⁾ | | | | | locking washer ²⁾ | | | | |
|------------|-----------------------|----------------------|-----------------------|-------------|-----|-----------------------------|-------------|-----|-----|----|------------------------------|-----------------------|----------------------------------|----|----|
| | IS C... Order code | dimensions: d x L | AS C... Order code | dimensions: | | | dimensions: | | | | | US C... Order code | dimensions: | | |
| | | | | a | m | SW | a | b | c | d | e | | a | b | |
| 1 | ISC1...* | M 10x45 | ASC1...* | 25 | M10 | 15 | SPC1...* | 55 | 30 | 8 | 14 | 15.5 | USC1X ³⁾ USC14571X | 13 | 22 |
| 2 | ISC2...* | M 10x60 | ASC2...* | 40 | M10 | 15 | SPC2...* | 70 | 30 | 8 | 26 | 15.5 | | | |
| 3 | ISC3...* | M 10x70 | ASC3...* | 50 | M10 | 15 | SPC3...* | 85 | 30 | 8 | 41 | 15.5 | | | |
| 4 | ISC4...* | M 12x100 | ASC4...* | 80 | M12 | 17 | SPC4...* | 115 | 45 | 10 | 69 | 17.5 | USC4X ³⁾ USC44571X | 15 | 28 |
| 5 | ISC5...* | M 16x130 | ASC5...* | 110 | M16 | 21 | SPC5...* | 152 | 60 | 10 | 97 | 21.5 | USC5X ³⁾ USC54571X | 18 | 32 |
| 6 | ISC6...* | M 20x190 | ASC6...* | 155 | M20 | 27 | SPC6...* | 205 | 80 | 15 | 137 | 27.5 | USC6X ³⁾ USC64571X | 21 | 36 |
| 7 | ISC7...* | M 24x220 | ASC7...* | 180 | M24 | 30 | SPC7...* | 250 | 90 | 15 | 169 | 30.5 | USC7X ³⁾ USC74571X | 25 | 42 |
| 8 | ISC8...* | M 30x300 | ASC8...* | 250 | M30 | 36 | SPC8...* | 320 | 120 | 25 | 219 | 36.5 | USC8X ³⁾ USC84571X | 32 | 52 |
| 9 | ISC9...* | M 30x450 | | | | | | | | | | | | | |
| 10 | ISC10...* | M 30x560 | | | | | | | | | | | | | |

¹⁾ The use of stacking screws necessitates the use of locking plates in the construction assembly!

²⁾ When assembling solid rubber clamps, covering plates, hexagon screws and locking washers must be used.

³⁾ Material = Steel, zinc plated, Cr(VI)-free

*Please add the suffix below according to the surface/material required.

| Order code suffixes | | |
|---------------------------------|--------|-----------|
| Surface/material | Suffix | Example |
| Steel, phosphated | X | ISC1X |
| Steel, zinc plated, Cr(VI)-free | VZX | ISC1VZX |
| Stainless Steel 1.4571 | 4571X | ISC14571X |

Tube clamps

Tube clamps series C – Complete range

Order codes for clamp halves:

| Material | Interior surface | Order code |
|---------------|------------------|----------------------|
| Polypropylene | grooved | RCP |
| | smooth | RCPG ¹⁾ |
| Polyamide | grooved | RCN |
| | smooth | RCNG ¹⁾ |
| Rubber | grooved | RCVR ¹⁾²⁾ |
| | smooth | RCVG ¹⁾²⁾ |
| Aluminium | grooved | RCA |

(Please exchange as required standard abbreviation RCP in column for "Order code")

For flame- or corrosion retardant materials, please refer to page T5.

The steel parts of kits 1 and 2 are phosphated.

Other compositions available on request.

2 clamp halves, weld plate,
cover plate, hex. head bolt

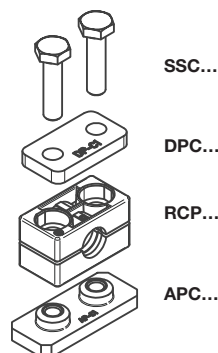

2 clamp halves, weld plate,
cover plate, socket head bolt

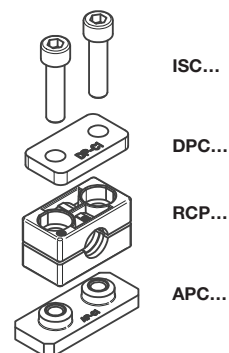

| clamp size | Tube O.D. mm | Tube NB | Tube O.D. | Order code | Order code |
|------------|--------------|----------|------------|------------|------------|
| 1 | 6.0 | G 1/8 | 5/16 | RCP1-106 | RCP2-106 |
| | 8.0 | | | RCP1-108 | RCP2-108 |
| | 9.5 | | RCP1-109.5 | RCP2-109.5 | |
| | 10.0 | | RCP1-110 | RCP2-110 | |
| | 12.0 | G 1/4 | 1/2 | RCP1-112 | RCP2-112 |
| | 12.7 | | | RCP1-112.7 | RCP2-112.7 |
| | 13.5 | | RCP1-113.5 | RCP2-113.5 | |
| | 14.0 | | RCP1-114 | RCP2-114 | |
| | 15.0 | G 3/8 | 5/8 | RCP1-115 | RCP2-115 |
| | 16.0 | | | RCP1-116 | RCP2-116 |
| 17.2 | RCP1-117.2 | | | RCP2-117.2 | |
| 18.0 | RCP1-118 | | | RCP2-118 | |
| 2 | 19.0 | G 1/2 | 3/4 | RCP1-219 | RCP2-219 |
| | 20.0 | | | RCP1-220 | RCP2-220 |
| | 21.3 | | | RCP1-221.3 | RCP2-221.3 |
| | 22.0 | | | RCP1-222 | RCP2-222 |
| | 23.0 | G 3/4 | 1 | RCP1-223 | RCP2-223 |
| | 25.0 | | | RCP1-225 | RCP2-225 |
| | 25.4 | | | RCP1-225.4 | RCP2-225.4 |
| | 26.9 | | | RCP1-226.9 | RCP2-226.9 |
| | 28.0 | | | RCP1-228 | RCP2-228 |
| | 30.0 | | | RCP1-230 | RCP2-230 |
| 3 | 30.0 | G 1 | 1 1/4 | RCP1-330 | RCP2-330 |
| | 32.0 | | | RCP1-332 | RCP2-332 |
| | 33.7 | | | RCP1-333.7 | RCP2-333.7 |
| | 35.0 | | | RCP1-335 | RCP2-335 |
| | 38.0 | G 1 1/4 | 1 1/2 | RCP1-338 | RCP2-338 |
| | 40.0 | | | RCP1-340 | RCP2-340 |
| 42.0 | RCP1-342 | RCP2-342 | | | |
| 4 | 38.0 | G 1 1/4 | 1 1/2 | RCP1-438 | RCP2-438 |
| | 40.0 | | | RCP1-440 | RCP2-440 |
| | 42.0 | | | RCP1-442 | RCP2-442 |
| | 45.0 | | | RCP1-445 | RCP2-445 |
| | 48.3 | G 1 1/2 | 2 | RCP1-448.3 | RCP2-448.3 |
| | 50.0 | | | RCP1-450 | RCP2-450 |
| | 51.0 | G 2 | 2 | RCP1-451 | RCP2-451 |
| | 52.0 | | | RCP1-452 | RCP2-452 |
| | 55.0 | | | RCP1-455 | RCP2-455 |
| | 57.0 | | | RCP1-457 | RCP2-457 |
| | 60.3 | G 2 | 2 1/4 | RCP1-460.3 | RCP2-460.3 |
| | 63.0 | | | RCP1-463 | RCP2-463 |
| | 65.0 | | | RCP1-465 | RCP2-465 |
| | 70.0 | | | RCP1-470 | RCP2-470 |

Continuation see next page ...



Tube clamps series C – Complete range (Continued)

Order codes for clamp halves:

| Material | Interior surface | Order code |
|---------------|------------------|----------------------|
| Polypropylene | grooved | RCP |
| | smooth | RCPG ¹⁾ |
| Polyamide | grooved | RCN |
| | smooth | RCNG ¹⁾ |
| Rubber | grooved | RCVR ¹⁾²⁾ |
| | smooth | RCVG ¹⁾²⁾ |
| Aluminium | grooved | RCA |

(Please exchange as required standard abbreviation RCP in column for "Order code")

For flame- or corrosion retardant materials, please refer to page T5.

The steel parts of kits 1 and 2 are phosphated.

Other compositions available on request.

2 clamp halves, weld plate,
cover plate, hex. head bolt

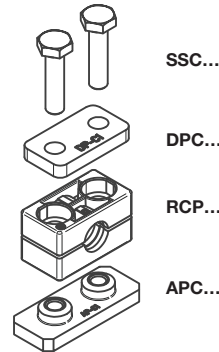

2 clamp halves, weld plate,
cover plate, socket head bolt

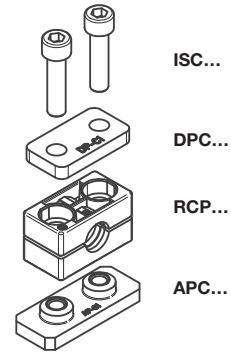

| clamp size | Tube O.D. mm | Tube NB | Tube O.D. | Order code | Order code | |
|------------|--------------|-------------|-------------|--------------|--------------|---|
| 5 | 65.0 | G 2 1/2 | 3 | RCP1-565 | RCP2-565 | |
| | 70.0 | | | RCP1-570 | RCP2-570 | |
| | 73.0 | | | RCP1-573 | RCP2-573 | |
| | 75.0 | | | RCP1-575 | RCP2-575 | |
| | 76.1 | | | RCP1-576.1 | RCP2-576.1 | |
| | 80.0 | | | RCP1-580 | RCP2-580 | |
| | 82.5 | | | RCP1-582.5 | RCP2-582.5 | |
| | 85.0 | | | RCP1-585 | RCP2-585 | |
| | 88.0 | | | RCP1-588 | RCP2-588 | |
| | 88.9 | | | RCP1-588.9 | RCP2-588.9 | |
| 90.0 | RCP1-590 | RCP2-590 | | | | |
| 6 | 90.0 | G 3 1/2 | 4 | RCP1-690 | RCP2-690 | |
| | 97.0 | | | RCP1-697 | RCP2-697 | |
| | 100.0 | | | RCP1-6100 | RCP2-6100 | |
| | 101.6 | | | RCP1-6101.6 | RCP2-6101.6 | |
| | 108.0 | | | RCP1-6108 | RCP2-6108 | |
| | 114.3 | | | RCP1-6114.3 | RCP2-6114.3 | |
| | 115.0 | | | RCP1-6115 | RCP2-6115 | |
| | 120.0 | | | RCP1-6120 | RCP2-6120 | |
| | 127.0 | | | RCP1-6127 | RCP2-6127 | |
| | 7 | | | 127.0 | G 5 | 5 |
| 130.0 | | RCP1-7130 | RCP2-7130 | | | |
| 133.0 | | RCP1-7133 | RCP2-7133 | | | |
| 140.0 | | RCP1-7140 | RCP2-7140 | | | |
| 150.0 | | RCP1-7150 | RCP2-7150 | | | |
| 152.4 | | RCP1-7152.4 | RCP2-7152.4 | | | |
| 159.0 | | RCP1-7159 | RCP2-7159 | | | |
| 165.1 | | RCP1-7165.1 | RCP2-7165.1 | | | |
| 168.3 | | RCP1-7168.3 | RCP2-7168.3 | | | |
| 8 | | 168.3 | G 6 | 6 5/8 | | |
| | 177.8 | RCP1-8177.8 | | | RCP2-8177.8 | |
| | 190.0 | RCP1-8190 | | | RCP2-8190 | |
| | 193.7 | RCP1-8193.7 | | | RCP2-8193.7 | |
| | 203.0 | RCP1-8203 | | | RCP2-8203 | |
| | 219.1 | RCP1-8219.1 | | | RCP2-8219.1 | |
| 220.0 | RCP1-8220 | RCP2-8220 | | | | |
| 9 | 219.1 | G 8 | 8 5/8 | RCP1-9219.1 | RCP2-9219.1 | |
| | 244.5 | | | RCP1-9244.5 | RCP2-9244.5 | |
| | 273.0 | | | RCP1-9273 | RCP2-9273 | |
| | 323.9 | | | RCP1-9323.9 | RCP2-9323.9 | |
| 10 | 355.6 | G 14 | 10 3/4 | RCP1-10355.6 | RCP2-10355.6 | |
| | 406.4 | | | RCP1-10406.4 | RCP2-10406.4 | |

Delivery in unassembled individual components.

¹⁾ Only sizes 1–8

²⁾ When assembling solid rubber clamps, covering plates, hexagon screws and locking washers must be used.



Tube clamps

Tube clamps series C – Complete range

Order codes for clamp halves:

| Material | Interior surface | Order code |
|---------------|------------------|----------------------|
| Polypropylene | grooved | RCP |
| | smooth | RCPG ¹⁾ |
| Polyamide | grooved | RCN |
| | smooth | RCNG ¹⁾ |
| Rubber | grooved | RCVR ¹⁾²⁾ |
| | smooth | RCVG ¹⁾²⁾ |
| Aluminium | grooved | RCA |

(Please exchange as required standard abbreviation RCP in column for "Order code")

For flame- or corrosion retardant materials, please refer to page T5.

The steel parts of kits 3, 4 and 5 have the following surfaces:

Bolts, cover plate, locking plate = phosphated

Rail nuts = Cr(VI)-free galvanized

Other compositions available on request.

2 clamp halves,
rail nuts, cover plate,
hex. head bolts

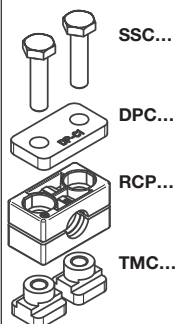

2 clamp halves,
rail nuts, cover plate,
socket head bolts

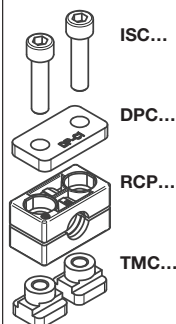

2 clamp halves, lock-
ing plate, stacking
bolts

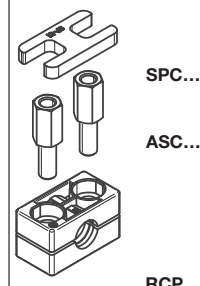

| clamp size | Tube O.D. mm | Tube NB | Tube O.D. | Order code | Order code | Order code |
|------------|--------------|------------|------------|------------|------------|------------|
| 1 | 6.0 | G 1/8 | 5/16 | RCP3-106 | RCP4-106 | RCP5-106 |
| | 8.0 | | | RCP3-108 | RCP4-108 | RCP5-108 |
| | 9.5 | | | RCP3-109.5 | RCP4-109.5 | RCP5-109.5 |
| | 10.0 | | | RCP3-110 | RCP4-110 | RCP5-110 |
| | 12.0 | | | RCP3-112 | RCP4-112 | RCP5-112 |
| | 12.7 | G 1/4 | 1/2 | RCP3-112.7 | RCP4-112.7 | RCP5-112.7 |
| | 13.5 | | | RCP3-113.5 | RCP4-113.5 | RCP5-113.5 |
| | 14.0 | | | RCP3-114 | RCP4-114 | RCP5-114 |
| | 15.0 | G 3/8 | 5/8 | RCP3-115 | RCP4-115 | RCP5-115 |
| | 16.0 | | | RCP3-116 | RCP4-116 | RCP5-116 |
| | 17.2 | | | RCP3-117.2 | RCP4-117.2 | RCP5-117.2 |
| 18.0 | RCP3-118 | | | RCP4-118 | RCP5-118 | |
| 2 | 19.0 | | | G 1/2 | 3/4 | RCP3-219 |
| | 20.0 | RCP3-220 | RCP4-220 | | | RCP5-220 |
| | 21.3 | RCP3-221.3 | RCP4-221.3 | | | RCP5-221.3 |
| | 22.0 | RCP3-222 | RCP4-222 | | | RCP5-222 |
| | 23.0 | RCP3-223 | RCP4-223 | | | RCP5-223 |
| | 25.0 | G 3/4 | 1 | RCP3-225 | RCP4-225 | RCP5-225 |
| | 25.4 | | | RCP3-225.4 | RCP4-225.4 | RCP5-225.4 |
| | 26.9 | | | RCP3-226.9 | RCP4-226.9 | RCP5-226.9 |
| | 28.0 | | | RCP3-228 | RCP4-228 | RCP5-228 |
| | 30.0 | | | RCP3-230 | RCP4-230 | RCP5-230 |
| 3 | 30.0 | G 1 | 1 1/4 | RCP3-330 | RCP4-330 | RCP5-330 |
| | 32.0 | | | RCP3-332 | RCP4-332 | RCP5-332 |
| | 33.7 | | | RCP3-333.7 | RCP4-333.7 | RCP5-333.7 |
| | 35.0 | G 1 1/4 | 1 1/2 | RCP3-335 | RCP4-335 | RCP5-335 |
| | 38.0 | | | RCP3-338 | RCP4-338 | RCP5-338 |
| | 40.0 | | | RCP3-340 | RCP4-340 | RCP5-340 |
| 42.0 | RCP3-342 | RCP4-342 | RCP5-342 | | | |
| 4 | 38.0 | G 1 1/4 | 1 1/2 | RCP3-438 | RCP4-438 | RCP5-438 |
| | 40.0 | | | RCP3-440 | RCP4-440 | RCP5-440 |
| | 42.0 | | | RCP3-442 | RCP4-442 | RCP5-442 |
| | 45.0 | G 1 1/2 | 2 | RCP3-445 | RCP4-445 | RCP5-445 |
| | 48.3 | | | RCP3-448.3 | RCP4-448.3 | RCP5-448.3 |
| | 50.0 | | | RCP3-450 | RCP4-450 | RCP5-450 |
| | 51.0 | G 2 | 2 1/4 | RCP3-451 | RCP4-451 | RCP5-451 |
| | 52.0 | | | RCP3-452 | RCP4-452 | RCP5-452 |
| | 55.0 | | | RCP3-455 | RCP4-455 | RCP5-455 |
| | 57.0 | | | RCP3-457 | RCP4-457 | RCP5-457 |
| | 60.3 | | | RCP3-460.3 | RCP4-460.3 | RCP5-460.3 |
| | 63.0 | 2 1/2 | 2 1/2 | RCP3-463 | RCP4-463 | RCP5-463 |
| | 65.0 | | | RCP3-465 | RCP4-465 | RCP5-465 |
| 70.0 | RCP3-470 | | | RCP4-470 | RCP5-470 | |

Continuation see next page ...



Tube clamps series C – Complete range (Continued)

Order codes for clamp halves:

| Material | Interior surface | Order code |
|---------------|------------------|----------------------|
| Polypropylene | grooved | RCP |
| | smooth | RCPG ¹⁾ |
| Polyamide | grooved | RCN |
| | smooth | RCNG ¹⁾ |
| Rubber | grooved | RCVR ¹⁾²⁾ |
| | smooth | RCVG ¹⁾²⁾ |
| Aluminium | grooved | RCA |

(Please exchange as required standard abbreviation RCP in column for "Order code")

For flame- or corrosion retardant materials, please refer to page T5.

The steel parts of kits 5 are phosphated.

Other compositions available on request.

2 clamp halves, locking plate, stacking bolts

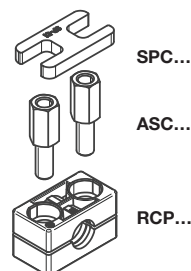

| clamp size | Tube O.D. mm | Tube NB | Tube O.D. | Order code | | | |
|------------|--------------|-------------|-----------|-------------|-----|-------|-------------|
| 5 | 65.0 | G 2 1/2 | 3 | RCP5-565 | | | |
| | 70.0 | | | RCP5-570 | | | |
| | 73.0 | | | RCP5-573 | | | |
| | 75.0 | | | RCP5-575 | | | |
| | 76.1 | | | RCP5-576.1 | | | |
| | 80.0 | | | RCP5-580 | | | |
| | 82.5 | | | RCP5-582.5 | | | |
| | 85.0 | | | RCP5-585 | | | |
| | 88.0 | | | RCP5-588 | | | |
| | 88.9 | | | RCP5-588.9 | | | |
| 6 | 90.0 | G 3 | 3 1/2 | RCP5-590 | | | |
| | 90.0 | | | RCP5-690 | | | |
| | 97.0 | | | RCP5-697 | | | |
| | 100.0 | | | RCP5-710 | | | |
| | 101.6 | | | RCP5-6100 | | | |
| | 108.0 | | | RCP5-6101.6 | | | |
| | 114.3 | | | RCP5-6108 | | | |
| | 115.0 | | | RCP5-6114.3 | | | |
| | 120.0 | | | RCP5-6115 | | | |
| | 127.0 | | | RCP5-6120 | | | |
| 7 | 127.0 | G 3 1/2 | 4 | RCP5-6127 | | | |
| | 127.0 | | | RCP5-7127 | | | |
| | 130.0 | | | RCP5-7130 | | | |
| | 133.0 | | | RCP5-7133 | | | |
| | 140.0 | | | RCP5-7140 | | | |
| | 150.0 | | | RCP5-7150 | | | |
| | 152.4 | | | RCP5-7152.4 | | | |
| | 159.0 | | | RCP5-7159 | | | |
| | 165.1 | | | RCP5-7165.1 | | | |
| | 168.3 | | | RCP5-7168.3 | | | |
| 8 | 168.3 | G 4 | 4 1/4 | RCP5-8168.3 | | | |
| | 177.8 | | | RCP5-8177.8 | | | |
| | 190.0 | | | RCP5-8190 | | | |
| | 193.7 | | | RCP5-8193.7 | | | |
| | 203.0 | | | RCP5-8203 | | | |
| | 219.1 | | | RCP5-8219.1 | | | |
| | 220.0 | | | RCP5-8220 | | | |
| | 220.0 | | | RCP5-8220 | | | |
| | 8 | | | 168.3 | G 5 | 5 | RCP5-8168.3 |
| | | | | 177.8 | | | RCP5-8177.8 |
| 190.0 | | RCP5-8190 | | | | | |
| 193.7 | | RCP5-8193.7 | | | | | |
| 203.0 | | RCP5-8203 | | | | | |
| 219.1 | | RCP5-8219.1 | | | | | |
| 220.0 | | RCP5-8220 | | | | | |
| 220.0 | | RCP5-8220 | | | | | |
| 8 | | 168.3 | G 5 1/2 | 5 1/4 | | | RCP5-8168.3 |
| | | 177.8 | | | | | RCP5-8177.8 |
| | 190.0 | RCP5-8190 | | | | | |
| | 193.7 | RCP5-8193.7 | | | | | |
| | 203.0 | RCP5-8203 | | | | | |
| | 219.1 | RCP5-8219.1 | | | | | |
| | 220.0 | RCP5-8220 | | | | | |
| | 220.0 | RCP5-8220 | | | | | |
| | 8 | 168.3 | | | G 6 | 5 1/2 | RCP5-8168.3 |
| | | 177.8 | | | | | RCP5-8177.8 |
| 190.0 | | RCP5-8190 | | | | | |
| 193.7 | | RCP5-8193.7 | | | | | |
| 203.0 | | RCP5-8203 | | | | | |
| 219.1 | | RCP5-8219.1 | | | | | |
| 220.0 | | RCP5-8220 | | | | | |
| 220.0 | | RCP5-8220 | | | | | |
| 8 | | 168.3 | G 6 | 6 | | | RCP5-8168.3 |
| | | 177.8 | | | | | RCP5-8177.8 |
| | 190.0 | RCP5-8190 | | | | | |
| | 193.7 | RCP5-8193.7 | | | | | |
| | 203.0 | RCP5-8203 | | | | | |
| | 219.1 | RCP5-8219.1 | | | | | |
| | 220.0 | RCP5-8220 | | | | | |
| | 220.0 | RCP5-8220 | | | | | |
| | 8 | 168.3 | | | G 8 | 6 1/4 | RCP5-8168.3 |
| | | 177.8 | | | | | RCP5-8177.8 |
| 190.0 | | RCP5-8190 | | | | | |
| 193.7 | | RCP5-8193.7 | | | | | |
| 203.0 | | RCP5-8203 | | | | | |
| 219.1 | | RCP5-8219.1 | | | | | |
| 220.0 | | RCP5-8220 | | | | | |
| 220.0 | | RCP5-8220 | | | | | |
| 8 | | 168.3 | G 8 | 6 1/2 | | | RCP5-8168.3 |
| | | 177.8 | | | | | RCP5-8177.8 |
| | 190.0 | RCP5-8190 | | | | | |
| | 193.7 | RCP5-8193.7 | | | | | |
| | 203.0 | RCP5-8203 | | | | | |
| | 219.1 | RCP5-8219.1 | | | | | |
| | 220.0 | RCP5-8220 | | | | | |
| | 220.0 | RCP5-8220 | | | | | |
| | 8 | 168.3 | | | G 8 | 6 5/8 | RCP5-8168.3 |
| | | 177.8 | | | | | RCP5-8177.8 |
| 190.0 | | RCP5-8190 | | | | | |
| 193.7 | | RCP5-8193.7 | | | | | |
| 203.0 | | RCP5-8203 | | | | | |
| 219.1 | | RCP5-8219.1 | | | | | |
| 220.0 | | RCP5-8220 | | | | | |
| 220.0 | | RCP5-8220 | | | | | |
| 8 | | 168.3 | G 8 | 7 | | | RCP5-8168.3 |
| | | 177.8 | | | | | RCP5-8177.8 |
| | 190.0 | RCP5-8190 | | | | | |
| | 193.7 | RCP5-8193.7 | | | | | |
| | 203.0 | RCP5-8203 | | | | | |
| | 219.1 | RCP5-8219.1 | | | | | |
| | 220.0 | RCP5-8220 | | | | | |
| | 220.0 | RCP5-8220 | | | | | |
| | 8 | 168.3 | | | G 8 | 7 5/8 | RCP5-8168.3 |
| | | 177.8 | | | | | RCP5-8177.8 |
| 190.0 | | RCP5-8190 | | | | | |
| 193.7 | | RCP5-8193.7 | | | | | |
| 203.0 | | RCP5-8203 | | | | | |
| 219.1 | | RCP5-8219.1 | | | | | |
| 220.0 | | RCP5-8220 | | | | | |
| 220.0 | | RCP5-8220 | | | | | |
| 8 | | 168.3 | G 8 | 8 5/8 | | | RCP5-8168.3 |
| | | 177.8 | | | | | RCP5-8177.8 |
| | 190.0 | RCP5-8190 | | | | | |
| | 193.7 | RCP5-8193.7 | | | | | |
| | 203.0 | RCP5-8203 | | | | | |
| | 219.1 | RCP5-8219.1 | | | | | |
| | 220.0 | RCP5-8220 | | | | | |
| | 220.0 | RCP5-8220 | | | | | |

Delivery in unassembled individual components.

¹⁾ Only sizes 1-8

²⁾ When assembling solid rubber clamps, covering plates, hexagon screws and locking washers must be used.

T

Tube clamps

Multiclamp series A

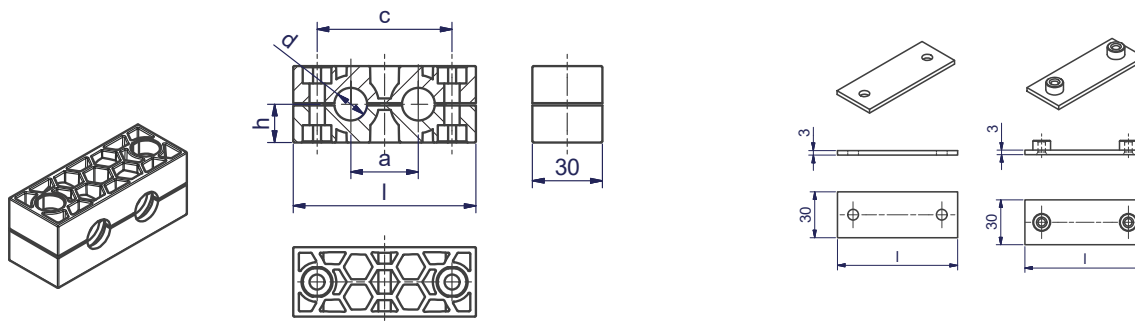

| clamp size | Tube O.D. mm d | Number of tubes | Number of Fastening screws B | 1 part 2 clamp halves RAPM Order code | 2 clamp-halves RAPM-... | | | | cover plate | | weld plate | |
|------------|----------------|-----------------|--|--|-----------------------------------|----|------|------|-------------|---------|------------|---------|
| | | | | | a | c | h | l | Order code | length: | Order code | length: |
| 1 | 6.0 | 2 | 2 | RAPM106B2X RAPM106.4B2X RAPM108B2X RAPM109.5B2X RAPM110B2X RAPM112B2X | 20 | 40 | 13.5 | 60.5 | DPM1B2...* | 60.5 | APM1B2...* | 62.5 |
| | 6.4 | | | | | | | | | | | |
| | 8.0 | | | | | | | | | | | |
| | 9.5 | | | | | | | | | | | |
| | 10.0 | | | | | | | | | | | |
| | 12.0 | | | | | | | | | | | |
| 2 | 10.0 | 2 | 2 | RAPM210B2X RAPM212B2X RAPM212.7B2X RAPM213.5B2X RAPM214B2X RAPM215B2X RAPM216B2X RAPM217.2B2X RAPM218B2X | 29 | 58 | 16.5 | 78.5 | DPM2B2...* | 78.5 | APM2B2...* | 80.5 |
| | 12.0 | | | | | | | | | | | |
| | 12.7 | | | | | | | | | | | |
| | 13.5 | | | | | | | | | | | |
| | 14.0 | | | | | | | | | | | |
| | 15.0 | | | | | | | | | | | |
| | 16.0 | | | | | | | | | | | |
| | 17.2 | | | | | | | | | | | |
| | 18.0 | | | | | | | | | | | |
| 3 | 15.0 | 2 | 2 | RAPM315B2X RAPM316B2X RAPM317.2B2X RAPM318B2X RAPM319B2X RAPM320B2X RAPM321.3B2X RAPM322B2X RAPM323B2X RAPM325B2X RAPM325.4B2X | 36 | 72 | 18.5 | 92.5 | DPM3B2...* | 92.5 | APM3B2...* | 94.5 |
| | 16.0 | | | | | | | | | | | |
| | 17.2 | | | | | | | | | | | |
| | 18.0 | | | | | | | | | | | |
| | 19.0 | | | | | | | | | | | |
| | 20.0 | | | | | | | | | | | |
| | 21.3 | | | | | | | | | | | |
| | 22.0 | | | | | | | | | | | |
| | 23.0 | | | | | | | | | | | |
| | 25.0 | | | | | | | | | | | |
| | 25.4 | | | | | | | | | | | |

Order codes for clamp halves:

| Material | Interior surface | Order code |
|---------------|------------------|---------------------|
| Polypropylene | grooved | RAPM |
| | smooth | RAPGM |
| Polyamide | grooved | RANM |
| | smooth | RANGM |
| Rubber | smooth | RAVGM ¹⁾ |

(Please exchange as required standard abbreviation RAPM in column for "Order code")

For flame- or corrosion retardant materials, please refer to page T5.

Different diameter on request.

¹⁾ When assembling solid rubber clamps, covering plates, hexagon screws and locking washers must be used.

*Please add the suffix below according to the surface/material required.

| Order code suffixes | | |
|---------------------------------|--------|-------------|
| Surface/material | Suffix | Example |
| Steel, phosphated | X | DPM1B2X |
| Steel, zinc plated, Cr(VI)-free | VZX | DPM1B2VZX |
| Stainless Steel 1.4571 | 4571X | DPM1B24571X |

Multiclamp series A

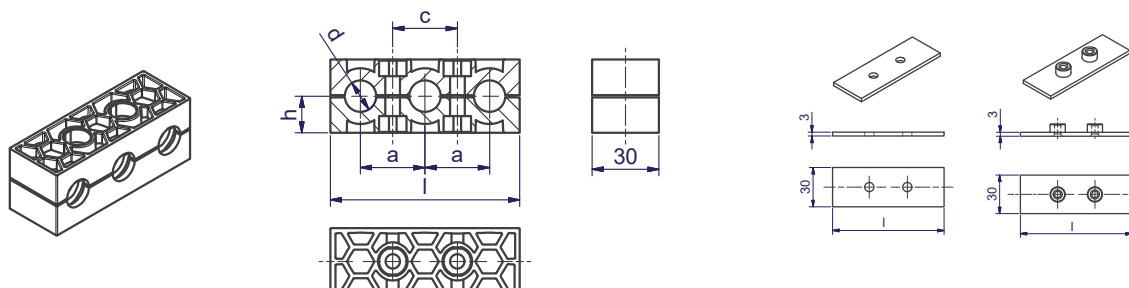

| clamp size | Tube O.D. mm d | Number of tubes | Number of Fastening screws B | 1 part 2 clamp halves RAPM Order code | 2 clamp-halves RAPM-... | | | | cover plate | | weld plate | |
|------------|----------------|-----------------|--|---|-----------------------------------|----|------|-----|-------------------|---------|-------------------|---------|
| | | | | | a | c | h | l | Order code | length: | Order code | length: |
| 1 | 6.0 | 3 | 2 | RAPM106B3X RAPM106.4B3X RAPM108B3X RAPM109.5B3X RAPM110B3X RAPM112B3X | 20 | 20 | 13.5 | 56 | DPM1B3...* | 56 | APM1B3...* | 58 |
| | 6.4 | | | | | | | | | | | |
| | 8.0 | | | | | | | | | | | |
| | 9.5 | | | | | | | | | | | |
| | 10.0 | | | | | | | | | | | |
| | 12.0 | | | | | | | | | | | |
| 2 | 10.0 | 3 | 2 | RAPM210B3X RAPM212B3X RAPM212.7B3X RAPM213.5B3X RAPM214B3X RAPM215B3X RAPM216B3X RAPM217.2B3X RAPM218B3X | 29 | 29 | 16.5 | 85 | DPM2B3...* | 85 | APM2B3...* | 87 |
| | 12.0 | | | | | | | | | | | |
| | 12.7 | | | | | | | | | | | |
| | 13.5 | | | | | | | | | | | |
| | 14.0 | | | | | | | | | | | |
| | 15.0 | | | | | | | | | | | |
| | 16.0 | | | | | | | | | | | |
| | 17.2 | | | | | | | | | | | |
| 18.0 | | | | | | | | | | | | |
| 3 | 15.0 | 3 | 2 | RAPM315B3X RAPM316B3X RAPM317.2B3X RAPM318B3X RAPM319B3X RAPM320B3X RAPM321.3B3X RAPM322B3X RAPM323B3X RAPM325B3X RAPM325.4B3X | 36 | 36 | 18.5 | 106 | DPM3B3...* | 106 | APM3B3...* | 108 |
| | 16.0 | | | | | | | | | | | |
| | 17.2 | | | | | | | | | | | |
| | 18.0 | | | | | | | | | | | |
| | 19.0 | | | | | | | | | | | |
| | 20.0 | | | | | | | | | | | |
| | 21.3 | | | | | | | | | | | |
| | 22.0 | | | | | | | | | | | |
| | 23.0 | | | | | | | | | | | |
| | 25.0 | | | | | | | | | | | |
| | 25.4 | | | | | | | | | | | |

Order codes for clamp halves:

| Material | Interior surface | Order code |
|---------------|------------------|---------------------------|
| Polypropylene | grooved | RAPM |
| | smooth | RAPGM |
| Polyamide | grooved | RANM |
| | smooth | RANGM |
| Rubber | smooth | RAVGM¹⁾ |

(Please exchange as required standard abbreviation RAPM in column for "Order code")

For flame- or corrosion retardant materials, please refer to page T5.

Different diameter on request.

¹⁾ When assembling solid rubber clamps, covering plates, hexagon screws and locking washers must be used.

*Please add the suffix below according to the surface/material required.

| Order code suffixes | | |
|---------------------------------|--------------|-------------|
| Surface/material | Suffix | Example |
| Steel, phosphated | X | DPM1B3X |
| Steel, zinc plated, Cr(VI)-free | VZX | DPM1B3VZX |
| Stainless Steel 1.4571 | 4571X | DPM1B34571X |

T

Tube clamps

Multiclamp series A

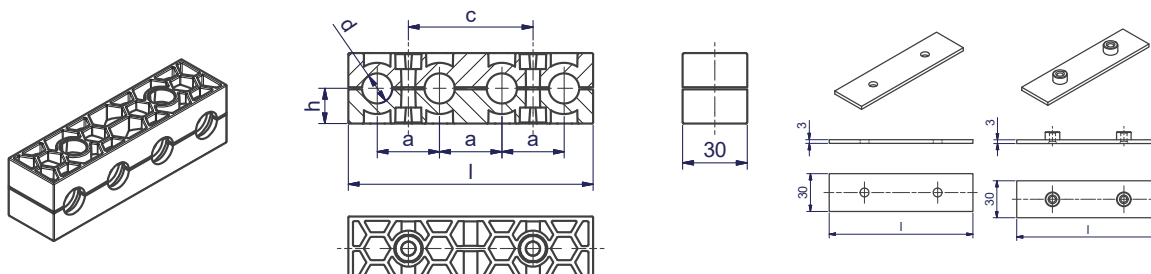

| clamp size | Tube O.D. mm d | Number of tubes | Number of Fastening screws B | 1 part 2 clamp halves RAPM Order code | 2 clamp-halves RAPM-... | | | | cover plate | | weld plate | |
|------------|----------------|-----------------|--|--|-----------------------------------|----|------|-----|-------------|---------|------------|---------|
| | | | | | a | c | h | l | Order code | length: | Order code | length: |
| 1 | 6.0 | 4 | 2 | RAPM106B4X RAPM106.4B4X RAPM108B4X RAPM109.5B4X RAPM110B4X RAPM112B4X | 20 | 40 | 13.5 | 76 | DPM1B4...* | 76 | APM1B4...* | 78 |
| | 6.4 | | | | | | | | | | | |
| | 8.0 | | | | | | | | | | | |
| | 9.5 | | | | | | | | | | | |
| | 10.0 | | | | | | | | | | | |
| | 12.0 | | | | | | | | | | | |
| 2 | 10.0 | 4 | 2 | RAPM210B4X RAPM212B4X RAPM212.7B4X RAPM213.5B4X RAPM214B4X RAPM215B4X RAPM216B4X RAPM217.2B4X RAPM218B4X | 29 | 58 | 16.5 | 114 | DPM2B4...* | 114 | APM2B4...* | 116 |
| | 12.0 | | | | | | | | | | | |
| | 12.7 | | | | | | | | | | | |
| | 13.5 | | | | | | | | | | | |
| | 14.0 | | | | | | | | | | | |
| | 15.0 | | | | | | | | | | | |
| | 16.0 | | | | | | | | | | | |
| | 17.2 | | | | | | | | | | | |
| 18.0 | | | | | | | | | | | | |
| 3 | 15.0 | 4 | 2 | RAPM315B4X RAPM316B4X RAPM317.2B4X RAPM318B4X RAPM319B4X RAPM320B4X RAPM321.3B4X RAPM322B4X RAPM323B4X RAPM325B4X RAPM325.4B4X | 36 | 72 | 18.5 | 142 | DPM3B4...* | 142 | APM3B4...* | 144 |
| | 16.0 | | | | | | | | | | | |
| | 17.2 | | | | | | | | | | | |
| | 18.0 | | | | | | | | | | | |
| | 19.0 | | | | | | | | | | | |
| | 20.0 | | | | | | | | | | | |
| | 21.3 | | | | | | | | | | | |
| | 22.0 | | | | | | | | | | | |
| | 23.0 | | | | | | | | | | | |
| | 25.0 | | | | | | | | | | | |
| | 25.4 | | | | | | | | | | | |

Order codes for clamp halves:

| Material | Interior surface | Order code |
|---------------|------------------|---------------------|
| Polypropylene | grooved | RAPM |
| | smooth | RAPGM |
| Polyamide | grooved | RANM |
| | smooth | RANGM |
| Rubber | smooth | RAVGM ¹⁾ |

(Please exchange as required standard abbreviation RAPM in column for "Order code")

For flame- or corrosion retardant materials, please refer to page T5.

Different diameter on request.

¹⁾ When assembling solid rubber clamps, covering plates, hexagon screws and locking washers must be used.

*Please add the suffix below according to the surface/material required.

| Order code suffixes | | |
|---------------------------------|--------|-------------|
| Surface/material | Suffix | Example |
| Steel, phosphated | X | DPM1B4X |
| Steel, zinc plated, Cr(VI)-free | VZX | DPM1B4VZX |
| Stainless Steel 1.4571 | 4571X | DPM1B44571X |



Multiclamp series A

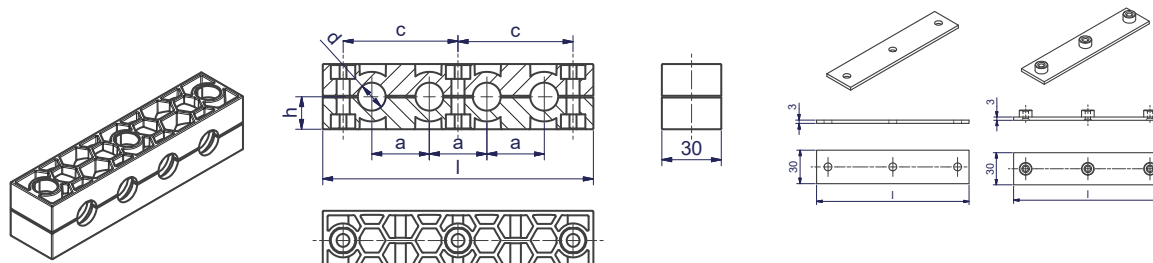

| clamp size | Tube O.D. mm d | Number of tubes | Number of Fastening screws C | 1 part 2 clamp halves RAPM Order code | 2 clamp-halves RAPM-... | | | | cover plate | | weld plate | |
|------------|-------------------|---------------------|--|---|-----------------------------------|----|------|-------|-------------------|---------|-------------------|---------|
| | | | | | a | c | h | l | Order code | length: | Order code | length: |
| 1 | 6.0 | 4 | 3 | RAPM106C4X | 20 | 40 | 13.5 | 100.5 | DPM1C4...* | 100.5 | APM1C4...* | 102.5 |
| | 6.4 | | | RAPM106.4C4X | | | | | | | | |
| | 8.0 | | | RAPM108C4X | | | | | | | | |
| | 9.5 | | | RAPM109.5C4X | | | | | | | | |
| | 10.0 | | | RAPM110C4X | | | | | | | | |
| | 12.0 | | | RAPM112C4X | | | | | | | | |
| 2 | 10.0 | 4 | 3 | RAPM210C4X | 29 | 58 | 16.5 | 136.5 | DPM2C4...* | 136.5 | APM2C4...* | 138.5 |
| | 12.0 | | | RAPM212C4X | | | | | | | | |
| | 12.7 | | | RAPM212.7C4X | | | | | | | | |
| | 13.5 | | | RAPM213.5C4X | | | | | | | | |
| | 14.0 | | | RAPM214C4X | | | | | | | | |
| | 15.0 | | | RAPM215C4X | | | | | | | | |
| | 16.0 | | | RAPM216C4X | | | | | | | | |
| | 17.2 | | | RAPM217.2C4X | | | | | | | | |
| | 18.0 | | | RAPM218C4X | | | | | | | | |
| | 3 | | | 15.0 | | | | | | | | |
| 16.0 | | RAPM316C4X | | | | | | | | | | |
| 17.2 | | RAPM317.2C4X | | | | | | | | | | |
| 18.0 | | RAPM318C4X | | | | | | | | | | |
| 19.0 | | RAPM319C4X | | | | | | | | | | |
| 20.0 | | RAPM320C4X | | | | | | | | | | |
| 21.3 | | RAPM321.3C4X | | | | | | | | | | |
| 22.0 | | RAPM322C4X | | | | | | | | | | |
| 23.0 | | RAPM323C4X | | | | | | | | | | |
| 25.0 | | RAPM325C4X | | | | | | | | | | |
| 25.4 | | RAPM325.4C4X | | | | | | | | | | |

Order codes for clamp halves:

| Material | Interior surface | Order code |
|---------------|------------------|---------------------------|
| Polypropylene | grooved | RAPM |
| | smooth | RAPGM |
| Polyamide | grooved | RANM |
| | smooth | RANGM |
| Rubber | smooth | RAVGM¹⁾ |

(Please exchange as required standard abbreviation RAPM in column for "Order code")

For flame- or corrosion retardant materials, please refer to page T5.

Different diameter on request.

¹⁾ When assembling solid rubber clamps, covering plates, hexagon screws and locking washers must be used.

*Please add the suffix below according to the surface/material required.

| Order code suffixes | | |
|---------------------------------|--------------|-------------|
| Surface/material | Suffix | Example |
| Steel, phosphated | X | DPM1C4X |
| Steel, zinc plated, Cr(VI)-free | VZX | DPM1C4VZX |
| Stainless Steel 1.4571 | 4571X | DPM1C44571X |



Tube clamps

Multiclamp series A

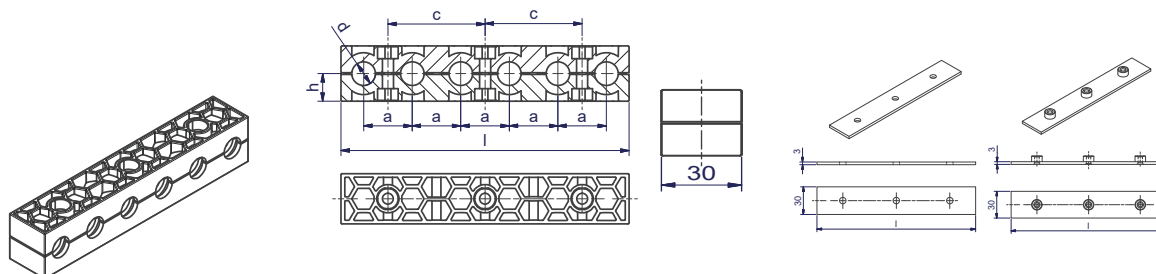

| clamp size | Tube O.D. mm d | Number of tubes | Number of Fastening screws C | 1 part 2 clamp halves RAPM Order code | 2 clamp-halves RAPM-... | | | | cover plate | | weld plate | |
|------------|----------------|-----------------|--|--|-----------------------------------|----|------|-----|-------------|---------|------------|---------|
| | | | | | a | c | h | l | Order code | length: | Order code | length: |
| 1 | 6.0 | 6 | 3 | RAPM106C6X RAPM106.4C6X RAPM108C6X RAPM109.5C6X RAPM110C6X RAPM112C6X | 20 | 40 | 13.5 | 116 | DPM1C6...* | 116 | APM1C6...* | 118 |
| | 6.4 | | | | | | | | | | | |
| | 8.0 | | | | | | | | | | | |
| | 9.5 | | | | | | | | | | | |
| | 10.0 | | | | | | | | | | | |
| | 12.0 | | | | | | | | | | | |
| 2 | 10.0 | 6 | 3 | RAPM210C6X RAPM212C6X RAPM212.7C6X RAPM213.5C6X RAPM214C6X RAPM215C6X RAPM216C6X RAPM217.2C6X RAPM218C6X | 29 | 58 | 16.5 | 172 | DPM2C6...* | 172 | APM2C6...* | 174 |
| | 12.0 | | | | | | | | | | | |
| | 12.7 | | | | | | | | | | | |
| | 13.5 | | | | | | | | | | | |
| | 14.0 | | | | | | | | | | | |
| | 15.0 | | | | | | | | | | | |
| | 16.0 | | | | | | | | | | | |
| | 17.2 | | | | | | | | | | | |
| 18.0 | | | | | | | | | | | | |
| 3 | 15.0 | 6 | 3 | RAPM315C6X RAPM316C6X RAPM317.2C6X RAPM318C6X RAPM319C6X RAPM320C6X RAPM321.3C6X RAPM322C6X RAPM323C6X RAPM325C6X RAPM325.4C6X | 36 | 72 | 18.5 | 214 | DPM3C6...* | 214 | APM3C6...* | 216 |
| | 16.0 | | | | | | | | | | | |
| | 17.2 | | | | | | | | | | | |
| | 18.0 | | | | | | | | | | | |
| | 19.0 | | | | | | | | | | | |
| | 20.0 | | | | | | | | | | | |
| | 21.3 | | | | | | | | | | | |
| | 22.0 | | | | | | | | | | | |
| | 23.0 | | | | | | | | | | | |
| | 25.0 | | | | | | | | | | | |
| | 25.4 | | | | | | | | | | | |

Order codes for clamp halves:

| Material | Interior surface | Order code |
|---------------|------------------|---------------------|
| Polypropylene | grooved | RAPM |
| | smooth | RAPGM |
| Polyamide | grooved | RANM |
| | smooth | RANGM |
| Rubber | smooth | RAVGM ¹⁾ |

(Please exchange as required standard abbreviation RAPM in column for "Order code")

For flame- or corrosion retardant materials, please refer to page T5.

Different diameter on request.

¹⁾ When assembling solid rubber clamps, covering plates, hexagon screws and locking washers must be used.

*Please add the suffix below according to the surface/material required.

| Order code suffixes | | |
|---------------------------------|--------|-------------|
| Surface/material | Suffix | Example |
| Steel, phosphated | X | DPM1C6X |
| Steel, zinc plated, Cr(VI)-free | VZX | DPM1C6VZX |
| Stainless Steel 1.4571 | 4571X | DPM1C64571X |

Multiclamp series A

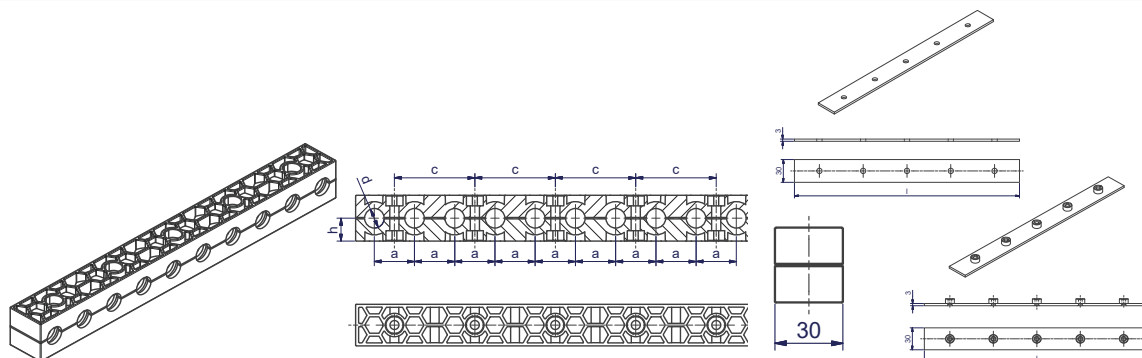

| clamp size | Tube O.D. mm d | Number of tubes | Number of Fastening screws C | 1 part 2 clamp halves RAPM Order code | 2 clamp-halves RAPM-... a c h l | cover plate | | weld plate | |
|------------|----------------|-----------------|--|--|--|--------------------|---------|--------------------|---------|
| | | | | | | Order code | length: | Order code | length: |
| 1 | 6.0 | 10 | 5 | RAPM106E10X RAPM106.4E10X RAPM108E10X RAPM109.5E10X RAPM110E10X RAPM112E10X | 20 40 13.5 196 | DPM1E10...* | 196 | APM1E10...* | 198 |
| | 6.4 | | | | | | | | |
| | 8.0 | | | | | | | | |
| | 9.5 | | | | | | | | |
| | 10.0 | | | | | | | | |
| | 12.0 | | | | | | | | |
| 2 | 10.0 | 10 | 5 | RAPM210E10X RAPM212E10X RAPM212.7E10X RAPM213.5E10X RAPM214E10X RAPM215E10X RAPM216E10X RAPM217.2E10X RAPM218E10X | 29 58 16.5 288 | DPM2E10...* | 288 | APM2E10...* | 300 |
| | 12.0 | | | | | | | | |
| | 12.7 | | | | | | | | |
| | 13.5 | | | | | | | | |
| | 14.0 | | | | | | | | |
| | 15.0 | | | | | | | | |
| | 16.0 | | | | | | | | |
| | 17.2 | | | | | | | | |
| 18.0 | | | | | | | | | |
| 3 | 15.0 | 10 | 5 | RAPM315E10X RAPM316E10X RAPM317.2E10X RAPM318E10X RAPM319E10X RAPM320E10X RAPM321.3E10X RAPM322E10X RAPM323E10X RAPM325E10X RAPM325.4E10X | 36 72 18.5 358 | DPM3E10...* | 358 | APM3E10...* | 360 |
| | 16.0 | | | | | | | | |
| | 17.2 | | | | | | | | |
| | 18.0 | | | | | | | | |
| | 19.0 | | | | | | | | |
| | 20.0 | | | | | | | | |
| | 21.3 | | | | | | | | |
| | 22.0 | | | | | | | | |
| | 23.0 | | | | | | | | |
| | 25.0 | | | | | | | | |
| | 25.4 | | | | | | | | |

Order codes for clamp halves:

| Material | Interior surface | Order code |
|---------------|------------------|---------------------------|
| Polypropylene | grooved | RAPM |
| | smooth | RAPGM |
| Polyamide | grooved | RANM |
| | smooth | RANGM |
| Rubber | smooth | RAVGM¹⁾ |

(Please exchange as required standard abbreviation RAPM in column for "Order code")

For flame- or corrosion retardant materials, please refer to page T5.

Different diameter on request.

¹⁾ When assembling solid rubber clamps, covering plates, hexagon screws and locking washers must be used.

*Please add the suffix below according to the surface/material required.

| Order code suffixes | | |
|---------------------------------|--------------|--------------|
| Surface/material | Suffix | Example |
| Steel, phosphated | X | DPM1E10X |
| Steel, zinc plated, Cr(VI)-free | VZX | DPM1E10VZX |
| Stainless Steel 1.4571 | 4571X | DPM1E104571X |

T

Tube clamps

Tube clamps series O

Order codes for clamps:

| Material | Interior surface | Order code |
|---------------|------------------|------------|
| Polypropylene | smooth | ROP |
| Polyamide | smooth | RON |

Packing standard 100 pieces.

Areas of Application:

- pneumatics
 - automotive technology
 - mechanical engineering
 - measurement and control
 - naval technologie
- also suitable for cables and hoses.

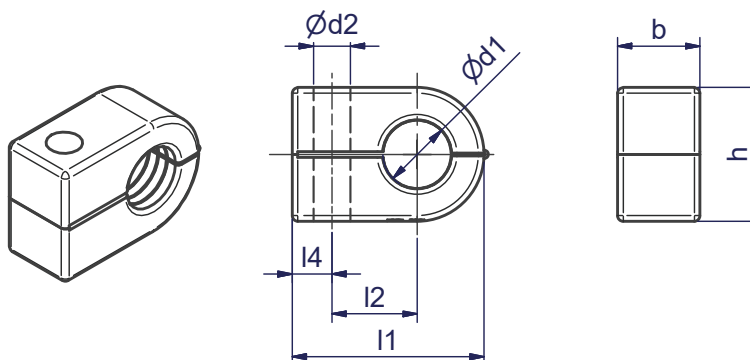

| Clamp-size | Tube Ø d1 | | | Order code | | l1 | l2 | l4 | b | H | Ø d2 | |
|------------|-----------|---------|------|-------------------|---------------|----|----|----|------|------|------|-----------|
| | O.D. mm | Tube NB | Inch | Polypropylene ROP | Polyamide RON | | | | | | | |
| 1 | 6.0 | | 1/4 | ROP106X | RON106X | 23 | 9 | 7 | 14.5 | 13.5 | 6.5 | |
| | 6.4 | | | ROP106.4X | RON106.4X | | | | | | | |
| | 8.0 | | | ROP108X | RON108X | | | | | | | |
| 2 | 8.0 | G 1/8 | 3/8 | ROP208X | RON208X | 27 | 11 | 7 | 14.5 | 18.5 | 6.5 | |
| | 9.5 | | | | ROP209.5X | | | | | | | RON209.5X |
| | 10.0 | | | | ROP210X | | | | | | | RON210X |
| | 12.0 | | | | ROP212X | | | | | | | RON212X |
| | 12.7 | | | | ROP212.7X | | | | | | | RON212.7X |
| 3 | 10.0 | G 1/8 | 1/2 | ROP310X | RON310X | 34 | 15 | 7 | 14.5 | 23.5 | 6.5 | |
| | 12.0 | | | ROP312X | RON312X | | | | | | | |
| | 12.7 | | | ROP312.7X | RON312.7X | | | | | | | |
| | 13.5 | G 1/4 | | ROP313.5X | RON313.5X | | | | | | | |
| | 14.0 | | | ROP314X | RON314X | | | | | | | |
| | 15.0 | | | ROP315X | RON315X | | | | | | | |
| | 16.0 | | | ROP316X | RON316X | | | | | | | |
| 4 | 14.0 | G 3/8 | 5/8 | ROP414X | RON414X | 40 | 19 | 6 | 14.5 | 30.5 | 6.5 | |
| | 15.0 | | | | ROP415X | | | | | | | RON415X |
| | 16.0 | | | | ROP416X | | | | | | | RON416X |
| | 17.2 | | | | ROP417.2X | | | | | | | RON417.2X |
| | 18.0 | | | | ROP418X | | | | | | | RON418X |
| | 19.0 | G 1/2 | 3/4 | ROP419X | RON419X | | | | | | | |
| | 20.0 | | | | ROP420X | | | | | | | RON420X |
| | 21.3 | | | | ROP421.3X | | | | | | | RON421.3X |
| | 22.0 | | | | ROP422X | | | | | | | RON422X |



Double-Tube clamps series O

Order codes for clamps:

| Material | Interior surface | Order code |
|---------------|------------------|------------|
| Polypropylene | smooth | ROPD |
| Polyamide | smooth | ROND |

Different diameter on request.

Packing standard 100 pieces.

Areas of Application:

- pneumatics
 - automotive technology
 - mechanical engineering
 - measurement and control
 - machine tool industry
- also suitable for cables and hoses.

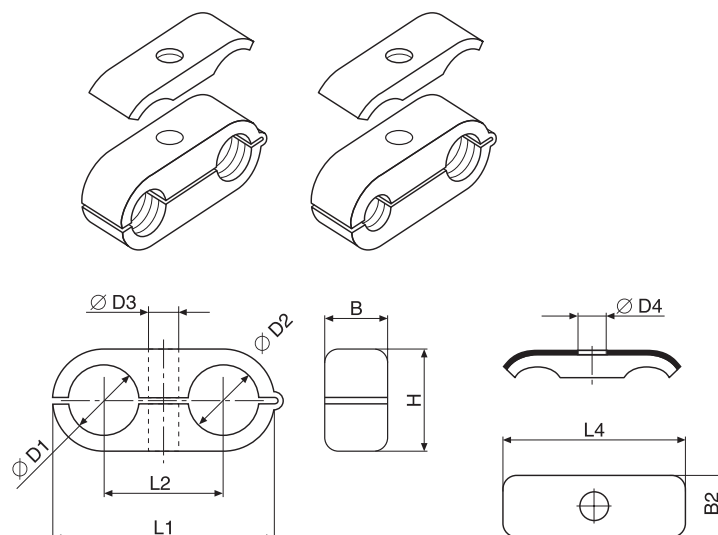

| Clamp-size | Tube O.D. D1/D2 | | | Order code | | Order code | | Order code | | L1 | L2 | B | H | Ø D3 | L4 | B2 | Ø D4 |
|------------|-----------------|---------|-------------------|--------------------|-------------------|---|----|------------|------|------|-----|------|------|------|----|----|-------------------|
| | mm | Tube NB | Inch | Polypropylene ROPD | Polyamide ROND | Cover plate DPO | | | | | | | | | | | |
| 1 | 6.0 | | 1/4 | ROPD106X | ROND106X | DPO1X¹⁾ DPO14571X | 32 | 18 | 14.5 | 13.5 | 6.5 | 29.0 | 16.3 | 6.5 | | | |
| | 6.4 | | | ROPD106.4X | ROND106.4X | | | | | | | | | | | | |
| | 8.0 | | | ROPD108X | ROND108X | | | | | | | | | | | | |
| 2 | 8.0 | 1/8 | 3/8 | ROPD208X | ROND208X | DPO2X¹⁾ DPO24571X | 41 | 22 | 14.5 | 18.5 | 6.5 | 40.0 | 16.3 | 6.5 | | | |
| | 9.5 | | | | ROPD209.5X | | | | | | | | | | | | ROND209.5X |
| | 10.0 | | | | ROPD210X | | | | | | | | | | | | ROND210X |
| | 12.0 | | | | ROPD212X | | | | | | | | | | | | ROND212X |
| | 12.7 | | | | ROPD212.7X | | | | | | | | | | | | ROND212.7X |
| 3 | 10.0 | 1/8 | 1/2 | ROPD310X | ROND310X | DPO3X¹⁾ DPO34571X | 54 | 30 | 14.5 | 23.5 | 6.5 | 50.5 | 16.5 | 6.5 | | | |
| | 12.0 | | | | ROPD312X | | | | | | | | | | | | ROND312X |
| | 12.7 | | | | ROPD312.7X | | | | | | | | | | | | ROND312.7X |
| | 13.5 | 1/4 | ROPD313.5X | ROND313.5X | | | | | | | | | | | | | |
| | 14.0 | | ROPD314X | ROND314X | | | | | | | | | | | | | |
| | 15.0 | | ROPD315X | ROND315X | | | | | | | | | | | | | |
| | 16.0 | | ROPD316X | ROND316X | | | | | | | | | | | | | |
| 4 | 14.0 | 3/8 | 5/8 | ROPD414X | ROND414X | DPO4X¹⁾ DPO44571X | 69 | 38 | 14.5 | 30.5 | 6.5 | 63.0 | 16.5 | 6.5 | | | |
| | 15.0 | | | ROPD415X | ROND415X | | | | | | | | | | | | |
| | 16.0 | | | ROPD416X | ROND416X | | | | | | | | | | | | |
| | 17.2 | | | ROPD417.2X | ROND417.2X | | | | | | | | | | | | |
| | 18.0 | | | ROPD418X | ROND418X | | | | | | | | | | | | |
| | 19.0 | 3/4 | ROPD419X | ROND419X | | | | | | | | | | | | | |
| | 20.0 | | ROPD420X | ROND420X | | | | | | | | | | | | | |
| | 21.3 | | ROPD421.3X | ROND421.3X | | | | | | | | | | | | | |
| | 22.0 | | ROPD422X | ROND422X | | | | | | | | | | | | | |

1) Material = Steel, zinc plated, Cr(VI)-free

T

Tube clamps

Hydraulic steel-clamps

Hydraulic steel-clamps

Order code **HSRS-***

W1: steel coating, Cr(VI)-free

* please add. Ø D

HSRS hydraulic steel-clamps are mainly used in the field of building machinery.

The support-block is welded to the machine body or another component either in upend or flat position. The tube-clamp is screwed on.

The robust construction of the clamp has an impact- and vibration-absorbing effect. The small dimension/height of the clamp allows hydraulic cables to be fitted later on – e. g. for installing additional equipment to building machinery.

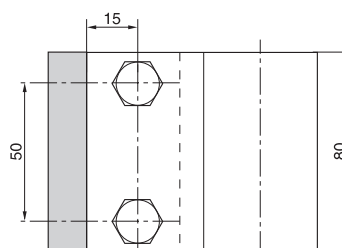
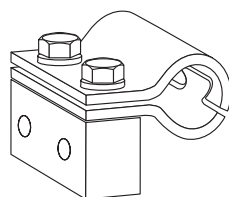
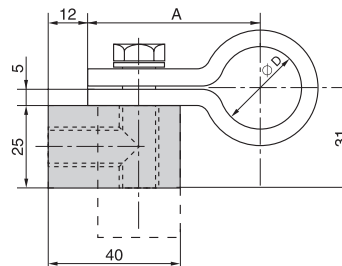
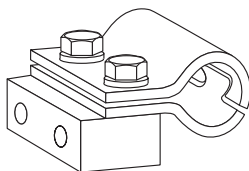

| Order code | | Dimensions | |
|-------------------|---------------------|------------|------|
| Clamp incl. block | Clamp without block | Ø D | A |
| HSRS25 | HSRS3-25CFX | 25 | 52.5 |
| HSRS30 | HSRS3-30CFX | 30 | 55.0 |
| HSRS35 | HSRS3-35CFX | 35 | 57.5 |
| HSRS38 | HSRS3-38CFX | 38 | 59.0 |
| HSRS42 | HSRS3-42CFX | 42 | 61.0 |
| HSRS48 | HSRS3-48CFX | 48 | 64.0 |
| HSRS50 | HSRS3-50CFX | 50 | 65.0 |
| HSRS60 | HSRS3-60CFX | 60 | 70.0 |

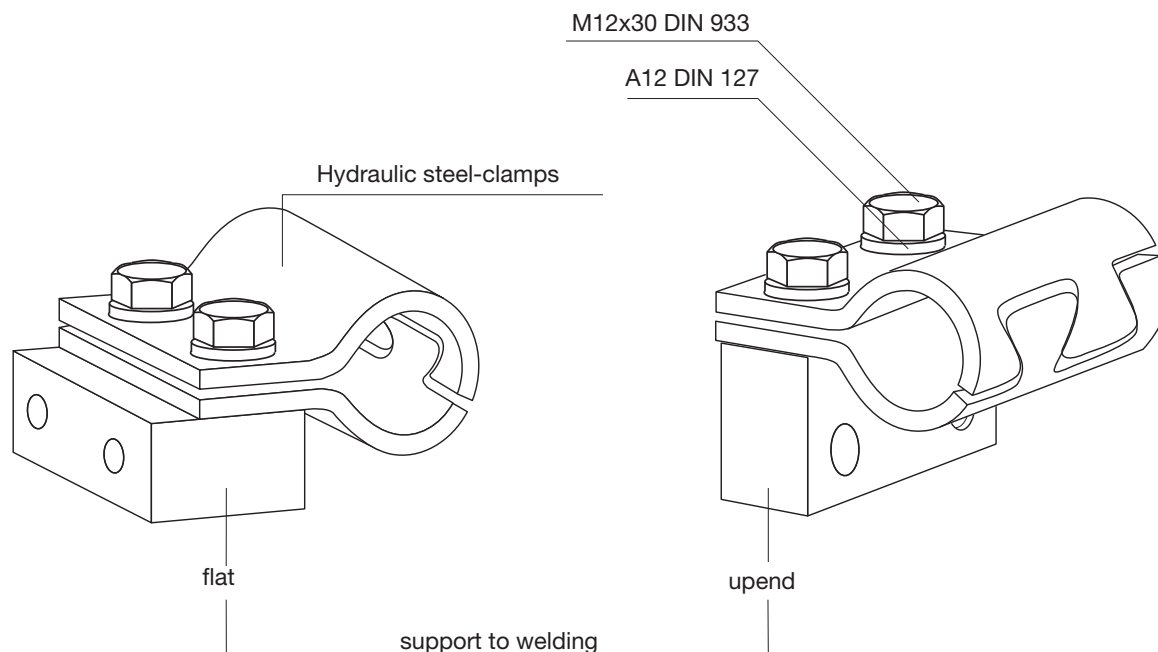



Hydraulic steel-clamps

Elastomere Inlay for HSRS

Order code **EE-***
 * complete outside tube diameter

Hydraulic steel tube clamp HSRS also available with Elastomere inlay

The advantages:

- complete outside tube diameter
- Safe fastening method even for very sensitive tube and hoses lines
- Only one clamp for different tube diameters

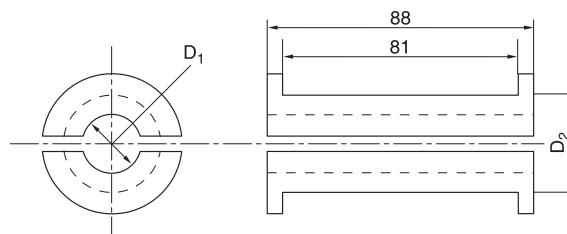

Material:

Santoprene 64 Shore

- high oil and weathering resistance
- temperature stability between -40°C and +120°C

| Order code Elastomere inlay | Nominal size D2 | mm O.D. D1 |
|--------------------------------|--------------------|---------------|
| EE12X | HSRS25 | 12 |
| EE15X | | 15 |
| EE20X | HSRS30 | 20 |
| EE25X | HSRS35 | 25 |
| EE30X | HSRS42 | 30 |
| EE35X | HSRS50 | 35 |
| EE38X | | 38 |
| EE42X | | 42 |
| EE47X | HSRS60 | 47 |
| EE50X | | 50 |

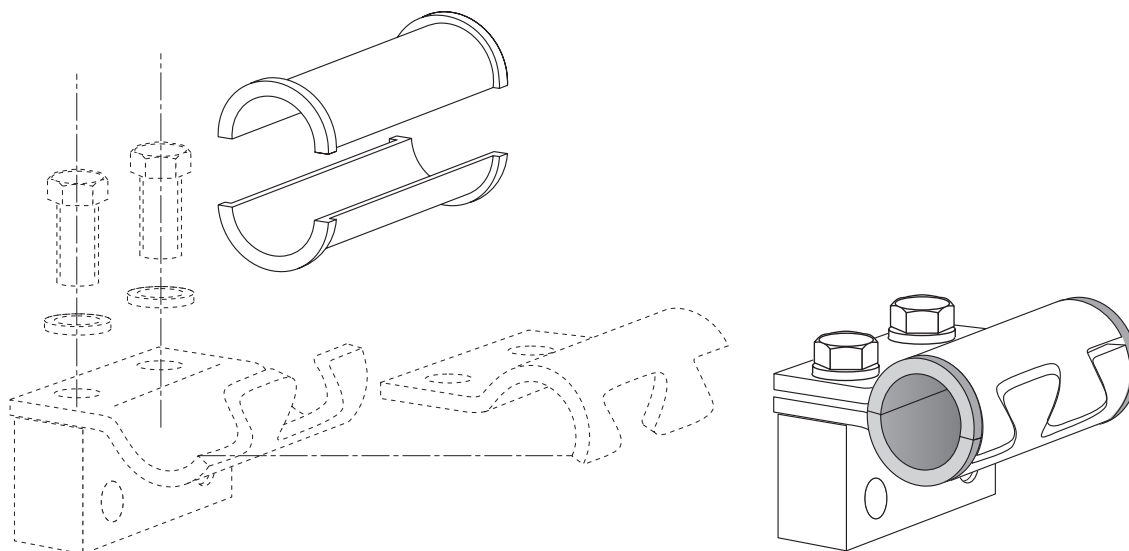

Tube clamps

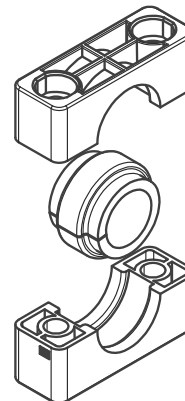
Tube Clamps with Elastomer Inlay Serie A

Clamp-halves
Order codes:

 Polypropylene – **RAPE**

 Polyamide 6 – **RANE**

If required, replace the standard indicator RAPE in the order code columns.

Elastomer Inlay
Order code:

 TPE 73° Shore – **EE***

*complete with clamp size and outside tube diameter

| Clamp size Serie A | Tube O.D. mm | Clamp body | Order code Clamp body with elastomer inlay | Elastomer inlay | |
|-----------------------|-----------------|------------|--|-----------------|--|
| 4 | 6.0 | RAPE4X | RAPE406X | EE206/406X | |
| | 8.0 | | RAPE408X | EE208/408X | |
| | 10.0 | | RAPE410X | EE210/410X | |
| | 12.0 | | RAPE412X | EE212/412X | |
| | 12.7 | | RAPE412.7X | EE212.7/412.7X | |
| | 14.0 | | RAPE414X | EE214/414X | |
| | 15.0 | | RAPE415X | EE215/415X | |
| | 16.0 | | RAPE416X | EE216/416X | |
| | 17.2 | | RAPE417.2X | EE217.2/417.2X | |
| | 18.0 | | RAPE418X | EE218/418X | |
| 19.0 | RAPE419X | EE219/419X | | | |
| 5 | 20.0 | RAPE5X | RAPE520X | EE520X | |
| | 22.0 | | RAPE522X | EE522X | |
| | 25.0 | | RAPE525X | EE525X | |
| | 28.0 | | RAPE528X | EE528X | |
| | 30.0 | | RAPE530X | EE530X | |
| 6 | 20.0 | RAPE6X | RAPE620X | EE320/620X | |
| | 21.3 | | RAPE621.3X | EE321.3/621.3X | |
| | 22.0 | | RAPE622X | EE322/622X | |
| | 23.0 | | RAPE623X | EE323/623X | |
| | 25.0 | | RAPE625X | EE325/625X | |
| | 26.9 | | RAPE626.9X | EE326.9/626.9X | |
| | 28.0 | | RAPE628X | EE328/628X | |
| | 30.0 | | RAPE630X | EE330/630X | |
| | 32.0 | | RAPE632X | EE332/632X | |
| | 35.0 | | RAPE635X | EE635X | |
| | 38.0 | RAPE638X | EE638X | | |
| | 42.0 | RAPE642X | EE642X | | |
| | 45.0 | RAPE645X | EE645X | | |
| | | | RAPE6X | | |

Attention! For clamps with elastomer inlay, the relation of diameter and size is not identical with the profile design or smooth design.

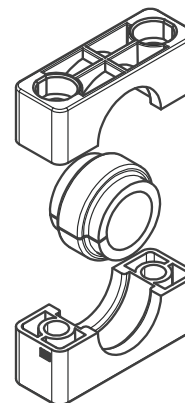

Tube Clamps with Elastomer Inlay Serie C

Clamp-halves
Order codes:

 Polypropylene – **RCPE**

 Polyamide 6 – **RCNE**

If required, replace the standard indicator RCPE in the order code columns.

Elastomer Inlay
Order code:

 TPE 73° Shore – **EE***

*complete with clamp size and outside tube diameter

| Clamp size Serie C | Tube O.D. mm | Clamp body | Order code Clamp body with elastomer inlay | Elastomer inlay |
|-----------------------|-----------------|------------|--|-----------------|
| 2 | 6.0 | RCPE2X | RCPE206X | EE206/406X |
| | 8.0 | | RCPE208X | EE208/408X |
| | 10.0 | | RCPE210X | EE210/410X |
| | 12.0 | | RCPE212X | EE212/412X |
| | 12.7 | | RCPE212.7X | EE212.7/412.7X |
| | 14.0 | | RCPE214X | EE214/414X |
| | 15.0 | | RCPE215X | EE215/415X |
| | 16.0 | | RCPE216X | EE216/416X |
| | 17.2 | | RCPE217.2X | EE217.2/417.2X |
| | 18.0 | | RCPE218X | EE218/418X |
| 19.0 | RCPE219X | EE219/419X | | |
| 3 | 20.0 | RCPE3X | RCPE320X | EE320/620X |
| | 21.3 | | RCPE321.3X | EE321.3/621.3X |
| | 22.0 | | RCPE322X | EE322/622X |
| | 23.0 | | RCPE323X | EE323/623X |
| | 25.0 | | RCPE325X | EE325/625X |
| | 26.9 | | RCPE326.9X | EE326.9/626.9X |
| | 28.0 | | RCPE328X | EE328/628X |
| | 30.0 | | RCPE330X | EE330/630X |
| | 32.0 | | RCPE332X | EE332/632X |
| | 4 | | 32.0 | RCPE4X |
| 33.7 | | RCPE433.7X | EE433.7X | |
| 35.0 | | RCPE435X | EE435X | |
| 38.0 | | RCPE438X | EE438X | |
| 40.0 | | RCPE440X | EE440X | |
| 42.0 | | RCPE442X | EE442X | |
| 45.5 | | RCPE445.5X | EE445.5X | |
| 48.0 | | RCPE448X | EE448X | |
| 51.0 | | RCPE451X | EE451X | |
| 53.4 | | RCPE453.4X | EE453.4X | |
| 56.4 | | RCPE456.4X | EE456.4X | |
| 60.3 | | RCPE460.3X | EE460.3X | |
| 5 | 57.0 | RCPE5X | RCPE557X | EE557X |
| | 60.3 | | RCPE560.3X | EE560.3X |
| | 63.5 | | RCPE563.5X | EE563.5X |
| | 65.0 | | RCPE565X | EE565X |
| | 70.0 | | RCPE570X | EE570X |
| | 73.0 | | RCPE573X | EE573X |
| | 76.1 | | RCPE576.1X | EE576.1X |

Attention! For clamps with elastomer inlay, the relation of diameter and size is not identical with the profile design or smooth design.

Tube Clamps with Elastomer Inlay Serie C

Clamp-halves
Order codes:

 Polypropylene – **RCPE**

 Polyamide 6 – **RCNE**

If required, replace the standard indicator RCPE in the order code columns.

Elastomer Inlay
Order code:

 TPE 73° Shore – **EE***

*complete with clamp size and outside tube diameter

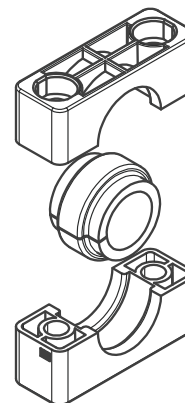

| Clamp size Serie C | Tube O.D. mm | Order code | | |
|-----------------------|-----------------|---------------|------------------------------------|------------------|
| | | Clamp body | Clamp body with elastomer inlay | Elastomer inlay |
| 6 | 80.0 | RCPE6X | RCPE680X | EE680X |
| | 82.5 | | RCPE682.5X | EE682.5X |
| | 88.9 | | RCPE688.9X | EE688.9X |
| | 100.0 | | RCPE6100X | EE6100X |
| | 101.6 | | RCPE6101.6X | EE6101.6X |
| 7 | 101.6 | RCPE7X | RCPE7101.6X | EE7101.6X |
| | 108.0 | | RCPE7108X | EE7108X |
| | 114.3 | | RCPE7114.3X | EE7114.3X |
| | 127.0 | | RCPE7127X | EE7127X |
| | 133.0 | | RCPE7133X | EE7133X |

Attention! For clamps with elastomer inlay, the relation of diameter and size is not identical with the profile design or smooth design.



Fixed Adaptor

Compatibility with channel rails

| Hilti (Channel system MQ for medium load) | Halfen (Medium duty channel system) | Unistrut® |
|--|--|----------------------------------|
| MQ-21, MQ-21U, MQ-21D | HM 41/22, HL 41/22, HM 41/22 D | P1000, P1000T, P1001, P1001T |
| MQ-31 | HZM 41/22, HZL 41/22, HZM 41/22 D | P2000, P2000T |
| MQ-41, MQ-41U, MQ-41D | HM 41/41, HL 41/41, HM 41/41 D | P3300, P3300T10, P3301, P3301T10 |
| MQ-52, MQ-52-72D | HZM 41/41, HZL 41/41, HZM 41/41 D | P4000, P4000T10 |
| MQ-72, MQ-72U | HM 41/62, HL 41/62, HM 41/62 D | P5000T, P5001T, P5500T, P5501T |
| | HM 41/83, HL 41/83 | |

Please contact us to check compatibility with additional types of channel rails.

Fixed Adaptor for Series A

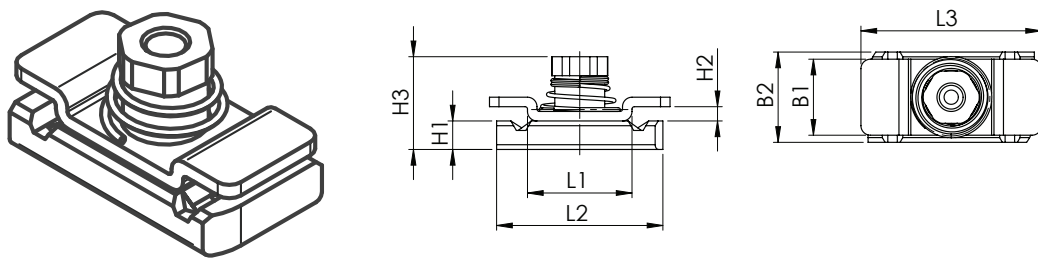

| clamp size | Fixed adaptor BAA/BAB Order code | dimensions: | | | | | | | | |
|------------|---|-------------|----|----|----|----|----|----|------|----|
| | | L1 | L2 | L3 | B1 | B2 | H1 | H2 | H3 | d6 |
| 1 | BAA/BAB1VZX BAA/BAB14571X | 22 | 35 | 38 | 16 | 19 | 6 | 3 | 19.5 | M6 |
| 2 | | | | | | | | | | |
| 3 | | | | | | | | | | |
| 4 | | | | | | | | | | |
| 5 | | | | | | | | | | |
| 6 | | | | | | | | | | |
| 7 | | | | | | | | | | |
| 8 | | | | | | | | | | |

T

Tube clamps

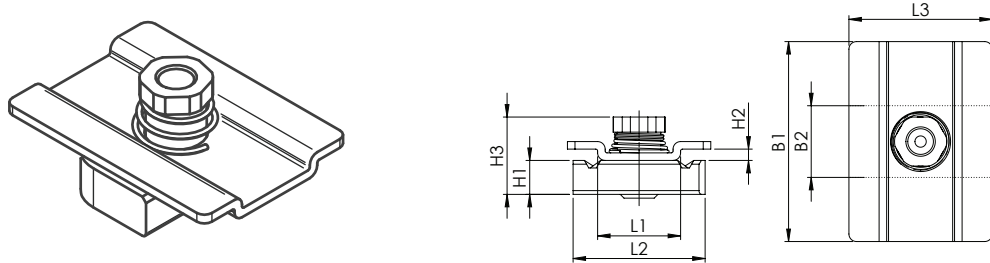
Fixed Adaptor for Series B

| clamp size | Fixed adaptor BAB Order code | dimensions: | | | | | | | | |
|------------|--|-------------|----|----|----|----|----|----|------|----|
| | | L1 | L2 | L3 | B1 | B2 | H1 | H2 | H3 | d6 |
| 1 | BAA/BAB1VZX BAA/BAB14571X | 22 | 35 | 38 | 16 | 19 | 6 | 3 | 19.5 | M6 |
| 2 | BAB2VZX BAB24571X | | | | 53 | | 9 | | | |
| 3 | | | | | 80 | | | | | |
| 4 | BAB4VZX BAB44571X | | | | | | | | | |
| 5 | | | | | | | | | | |

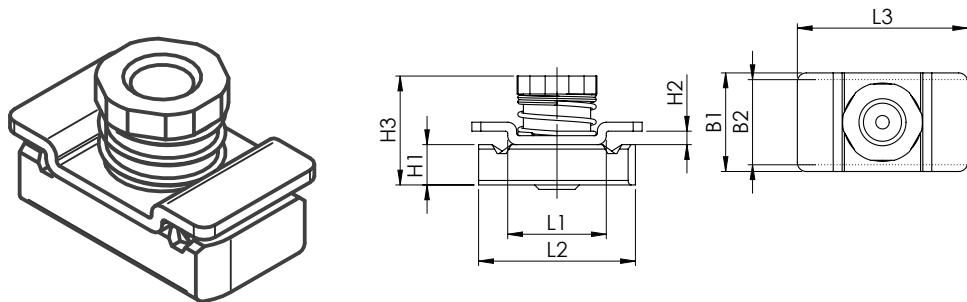
Fixed Adaptor for Series C

| clamp size | Fixed adaptor BAC Order code | dimensions: | | | | | | | | |
|------------|---|-------------|----|----|----|----|----|----|------|-----|
| | | L1 | L2 | L3 | B1 | B2 | H1 | H2 | H3 | d6 |
| 1 | BAC1VZX BAC14571X | 22 | 35 | 38 | 22 | 19 | 9 | 3 | 24.3 | M10 |
| 2 | | | | | | | | | | |
| 3 | | | | | | | | | | |
| 4 | BAC4VZX BAC44571X | | | 45 | 25 | | | | 25.8 | M12 |



Recommended screw lengths when using fixed adaptor for series C

| clamp size | Hexagon head screw (with cover plate) | Hexagon socket head screw (without cover plate) | Stacking bolt |
|------------|---------------------------------------|---|---------------|
| 1 | M10 x 40 | M10 x 20* | M10 x 20* |
| 2 | M10 x 55* | M10 x 35* | M10 x 35* |
| 3 | M10 x 65* | M10 x 50* | M10 x 50* |
| 4 | M12 x 100 | M12 x 75* | M12 x 75* |

*For screws with special length (different from catalogue) price on request.

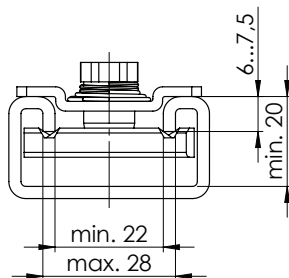

T

Railnut with loss protection

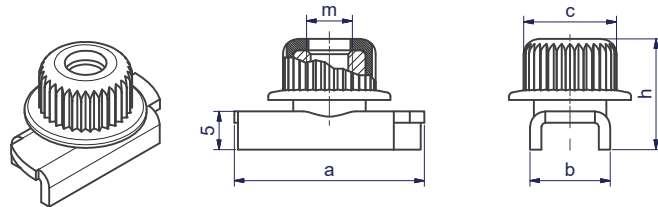

| Rail nut light series TMA/B1 Order code | Dimensions: | | | | |
|--|-------------|------|----|----|------|
| | a | b | c | m | h |
| TMA/TMB1WLPVZX | 24.9 | 10.5 | 12 | M6 | 14.5 |
| TMA/TMB1WLP71X | 24.9 | 10.5 | 12 | M6 | 14.5 |

The big flange prevents that the railnut falls into the rail during installation and has a vibration and sound insulating function.

The rubbercap has an integrated screw locking device. Fast and easy to install, easy to adjust, especially for vertical installations.

Advantages:

- 40% time savings during installation
- Fast and easy to install
- Vibration and sound insulating function
- Especially for vertical installations



Custom Products





What are Custom Products?

Parker – supplier of your wishes – your special is our standard!

Your idea is our Know-How!

Profit of the advantages of our Custom Products:

- Slogans like “single source“ or “vendor-reduction“ are getting more and more important in industry.
- worldwide availability
- Parker TFDE Custom Products is able to offer almost every type of connector, which is not to be found in our catalogues or price-lists.

Following examples could be a suggestion, how your problems could be solved in the future.

Jump sizes



One connector can replace several combinations.

- to shorten assembly-time
- to reduce possible leaks and their costs
- to reduce stock

Extra-long connectors



to avoid long tubes
or adapter-combinations



Unconventional configuration of ends



tube and port end

eg: to connect metric and inch tube ...

Restricted orifice



orifice $\times 0,3 \text{ mm}$

(technical clarification about length of reduced bore in accordance to material necessary)



Industrial Tube Fittings Europe – Alphanumerical index

| Order code | Page | Order code | Page | Order code | Page |
|------------|------|------------|------|----------------|--------|
| 0107 | O46 | C5OMX | K46 | EGE-M-ED | I60 |
| 0207 | O49 | C6BU | L8 | EGE-NPT | I64 |
| 0507 | O51 | C6MK4 | O31 | EGEO | I59 |
| 1004 | H32 | C6MLO | J19 | EGE-R-ED | I61 |
| 2107 | O47 | C6MX | K18 | EL | I30 |
| 210A | H32 | C87OMLO | J38 | ELA/ELAE | P64/65 |
| 2207 | O50 | C87OMX | K45 | EL-M-ED | I71 |
| 226B | H51 | C8OMLO | J42 | EL-R-ED | I72 |
| 226Z | H51 | C8OMX | K49 | EMA1 | R4 |
| 2507 | O52 | CBU | L12 | EMA3 | R8 |
| 3107 | O48 | CC5OLO | J40 | EMK4 | O28 |
| 3507 | O53 | CC5OX | K47 | EMLO | J10 |
| AKL | H7 | CCCTX | K52 | EMTX | K10 |
| AOE4G | O18 | CCTX | K51 | EO2-FORM F3 | H24 |
| AOEG | O18 | CD45 | O10 | EO2-FORM PRO22 | H24 |
| AOEL6 | J18 | CDM | O9 | EO2-FORM SET | I12 |
| AP | N70 | CLO | J43 | EO-KARRYFORM | H25 |
| AS | M3 | CMTX | K50 | EO-KARRYMAT | H11 |
| AS | N35 | CPM | N69 | EOMAT ECO | H13 |
| ASK | M5 | CR | O5 | EOMAT PRO | H21 |
| ASL | N37 | D | I15 | EOMAT UNI | H15 |
| ASR | N34 | DA | I34 | EO-NIROMONT | H49 |
| AV 6/42 | H50 | DD45 | O14 | ES | N39 |
| BAV 6/12 | H51 | DD | O14 | ESL | N41 |
| BBMTX | K22 | DG 101 | Q6 | ESV | M6 |
| BFG | N75 | DG 102-M | Q8 | ET | I29 |
| BFGL | N78 | DG 102-R | Q7 | ET-M-ED | I69 |
| BFW | N76 | DG 103 | Q9 | ET-R-ED | I70 |
| BFW3 | N77 | DG 104-M | Q11 | EV | I28 |
| BFW3-G | N85 | DG 104-R | Q10 | EVGE-M-ED | I62 |
| BFW-G | N80 | DG 105 | Q12 | EVGE-R-ED | I63 |
| BFW-GI | N81 | DG 106-M | Q14 | EVL | I33 |
| BFWL | N79 | DG 106-R | Q13 | EVL-M | I77 |
| BFW-S | N82 | DG 107 | Q15 | EVL-R | I78 |
| BL | J5 | DG 108 | Q16 | EV-M-ED | I67 |
| BML | J5 | DG 208 | Q17 | EV-R-ED | I68 |
| BMTX | K6 | DKA | I128 | EVT | I32 |
| BTX | K5 | DKI | I125 | EVT-M | I75 |
| BU | L5 | DMTX | K75 | EVT-R | I76 |
| BUZ | I116 | DOZ | I121 | EVW | I31 |
| BUZM | I117 | DPR | I16 | EVW-M | I73 |
| BV 20/25 | H53 | DV | P60 | EVW-R | I74 |
| BV 6/18 | H52 | DVGE-M | Q19 | EW | I27 |
| C3MX | K53 | DVGE-R | Q18 | EW-M-ED | I65 |
| C3P4 | O57 | DVWE-M | Q21 | EW-R-ED | I66 |
| C3T4 | O55 | DVWE-R | Q20 | F3HG5 | O23 |
| C4OMLO | J41 | E | I120 | F3MK4 | O38 |
| C4OMX | K48 | E6MK4 | O35 | F3P4 | O57 |
| C5BU | L12 | EBU | L6 | F3T4 | O54 |
| C5OMLO | J39 | ED | I122 | F3MX | K36 |

Alphanumerical index

Industrial Tube Fittings Europe – Alphanumerical index

| Order code | Page | Order code | Page | Order code | Page |
|------------|------|------------|------|------------------|------|
| F42EDMLO | J30 | FUS | N17 | HP46 | O56 |
| F42EDMX | K30 | FUSF | N20 | HP5ON | O22 |
| F4OHG5 | O24 | FUSM | N18 | HPBA | J71 |
| F4OMX | K32 | G | I18 | HPM | O16 |
| F5BU | L10 | G3P4 | O59 | HVM-B | H9 |
| F5OG | O17 | G4MK4 | O37 | I-TL | P20 |
| F5OG5 | O19 | G4MLOSMO | J57 | J6MK4 | O36 |
| F5OHAO | O20 | G4MX | K72 | JBU | L7 |
| F5OMLO | J27 | G4MXMO | K79 | JMK4 | O28 |
| F5OMX | K27 | G5G5JG5 | O20 | JMLO | J11 |
| F63P4 | O58 | G63P4 | O59 | JMTX | K11 |
| F63MX | K44 | G6X | K78 | JX6 | K25 |
| F642EDML | J36 | G87MLO | J56 | K | I24 |
| F642EDMX | K39 | GAI-M | I104 | K6OO4MX | K84 |
| F64OMX | K40 | GAI-NPT | I106 | K6PP4MX | K85 |
| F65OL | J35 | GAI-R | I105 | KARRYFLARE | H34 |
| F65OMX | K38 | GBU | L13 | KD | I127 |
| F682EDML | J37 | GE-M | I54 | KDS | I126 |
| F682EDMX | K41 | GE-M (KEG) | I55 | KH (71) | P41 |
| F687OML | J34 | GE-M-ED | I48 | KH (S) | P40 |
| F687OMX | K37 | GE-NPT | I57 | KH 3/2 (71) | P47 |
| F68OMX | K42 | GEO | I47 | KH 3/2 (S) | P46 |
| F6MK4 | O30 | GE-R | I51 | KH 3/2 BSPP (71) | P49 |
| F6MX | K43 | GE-R (KEG) | I53 | KH 3/2 BSPP (S) | P48 |
| F82EDMLO | J32 | GE-R-ED | I49 | KH 3/2 NPT (S) | P50 |
| F82EDMX | K33 | GE-UNF/UN | I56 | KH-A (S) | P53 |
| F87OMLO | J26 | GFS | N21 | KH BSPP (71) | P43 |
| F87OMX | K26 | GFS-G | N25 | KH BSPP (S) | P42 |
| F8OHG5 | O25 | GFS-N | N27 | KH-B1V-S | P52 |
| F8OMX | K34 | GG | O13 | KHBLOCK | P55 |
| FBU | L11 | GG44M | O41 | KHBLOCK 3/2 | P56 |
| FF33M | O44 | GHP | H19 | KHLOCKING | P51 |
| FF42EDMLO | J31 | GHP PRO | H23 | KH-NPT (71) | P45 |
| FF42EDMX | K31 | GM | I118 | KH-NPT (S) | P44 |
| FF5OMLO | J28 | GMA1 | R5 | KH-T (S) | P54 |
| FF5OMX | K29 | GMA3 | R9 | KLO | J12 |
| FFFM | O6 | GMTX | K73 | KMMOO | O15 |
| FF | O4 | GR | I19 | KONU | H19 |
| FGM | O8 | GZ | I44 | KOR | I39 |
| FHS | N16 | GZR | I45 | KTX | K12 |
| FHSF | N19 | H6MK4 | O34 | L(O)EMQ | N29 |
| FLO | J33 | HBU | L6 | L(O)HQ | N28 |
| FM | I10 | HHP | O16 | L(O)VQ | N30 |
| FMK4 | O40 | HL6 | J25 | LD | P61 |
| FMTX | K35 | HMK4 | O26 | LEE | I80 |
| FNLBA | J69 | HMLO | J9 | LE-M | I100 |
| FNMK4 | O39 | HP4 | O56 | LE-M (KEG) | I103 |
| FNML | J63 | HMTX | K9 | LE-R | I101 |
| FNMTX | K86 | HMX6 | K24 | LE-R (KEG) | I102 |
| FNU | L13 | HP3M | O45 | LOHB3 | J62 |

Industrial Tube Fittings Europe – Alphanumerical index

| Order code | Page | Order code | Page | Order code | Page |
|--------------------------|------|------------------|----------|------------------|------|
| LOHL6..... | J24 | PDFS-G..... | N64 | RHDI..... | P18 |
| LOHMX6..... | J67 | PDFS-S..... | N66 | RHDMLOS..... | P22 |
| LOHMX6..... | K90 | PDSF-B..... | N92 | RHDMTXS..... | P29 |
| LOHU86..... | J68 | PEFF-G..... | N45 | RHV42EDMLOS..... | P23 |
| LUBSS..... | H49 | PEFF-N..... | N48 | RHV42EDMXS..... | P30 |
| M..... | I14 | PF..... | N83 | RHV50MLOS..... | P25 |
| MAV..... | I109 | PFB..... | N84 | RHV50MXS..... | P32 |
| MAVE..... | I110 | PFE..... | N84 | RHV82EDMLOS..... | P27 |
| MAV-MA1..... | R7 | PFF-.S/L..... | N49 | RHV82EDMXS..... | P34 |
| MAV-MA3..... | R11 | PFF-G..... | N42 | RHV-M-ED..... | P16 |
| MAVMD...MA3..... | R11 | PFF-N..... | N46 | RHV-R-ED..... | P14 |
| MMO..... | O15 | PFL..... | N83 | RHZ42EDMLOS..... | P24 |
| MMO444M..... | O42 | PGFS-B..... | N58 | RHZ42EDMXS..... | P31 |
| MMS..... | O12 | PGFS-S..... | N61 | RHZ50MLOS..... | P26 |
| MOK..... | H19 | PMQ..... | N71, N72 | RHZ50MXS..... | P33 |
| MOKEO2..... | H19 | PNLOBA..... | J70 | RHZ82EDMLOS..... | P28 |
| MOKEO2PRO..... | H23 | PNMK4..... | O29 | RHZ82EDMXS..... | P35 |
| MOKPRO..... | H23 | PNMLO..... | J64 | RHZ-M-ED..... | P17 |
| MOKPRORW..... | H23 | PNMTX..... | K87 | RHZ-R-ED..... | P15 |
| MRO..... | O11 | PNU..... | L14 | RI..... | I108 |
| MTX..... | K77 | PORTBOARD A..... | H59 | RI-ED..... | I107 |
| OR..... | I123 | PORTBOARD B..... | H59 | RMTX..... | K70 |
| OTX..... | K76 | PRF..... | N74 | ROV..... | I111 |
| P5ONBA..... | J71 | PSFA-B..... | N89 | RRS..... | O5 |
| P5ONM..... | O21 | PSF-B..... | N91 | RVP..... | P19 |
| PAFG-90G..... | N52 | PSFC..... | N88 | S..... | I17 |
| PAFG-90L..... | N56 | PSFP..... | N90 | S3MX..... | K65 |
| PAFG-90M..... | N50 | PSR..... | I15 | S4OMLO..... | J50 |
| PAFG-90X..... | N54 | PTR34M..... | O43 | S4OMX..... | K62 |
| PAFG-G..... | N51 | PTRM..... | O7 | S5OMLO..... | J49 |
| PAFG-L..... | N55 | PWDA..... | N87 | S5OMX..... | K61 |
| PAFG-X..... | N53 | PWDS-G..... | N86 | S6BU..... | L8 |
| PAFS-90B..... | N59 | R3MX..... | K71 | S6MK4..... | O33 |
| PAFS-90S..... | N63 | R4OMLO..... | J54 | S6MLO..... | J21 |
| PAFS-B..... | N57 | R4OMX..... | K68 | S6MX..... | K20 |
| PAFSF-G..... | N44 | R5OMLO..... | J53 | S87OMLO..... | J48 |
| PAFSF-S..... | N62 | R5OMX..... | K67 | S87OMX..... | K60 |
| PAFS-S..... | N60 | R6BU..... | L9 | S8OMLO..... | J51 |
| PAGL-(G/M)..... | N73 | R6MK4..... | O32 | S8OMX..... | K63 |
| PARFLANGE® 1025..... | H39 | R6MLO..... | J22 | SBR..... | J75 |
| PARFLANGE® 50..... | H41 | R6MX..... | K21 | SKA..... | M7 |
| PARFLANGE® 50 BASIC..... | H42 | R6O4MX..... | K82 | SKA-ORB..... | M10 |
| PARFLANGE® 50 PRO..... | H43 | R6P4MLO..... | J61 | SKAR..... | M8 |
| PARFLARE ECO..... | H35 | R6P4MX..... | K83 | SKA-RB..... | M11 |
| PAR-LOK..... | H54 | R87OMLO..... | J52 | SMA1..... | R7 |
| PCCFF..... | N68 | R87OMX..... | K66 | SMA3..... | R11 |
| PCFF..... | N67 | R8OMLO..... | J55 | SMTX..... | K64 |
| PCFF-G..... | N43 | R8OMX..... | K69 | SV..... | I25 |
| PCFF-N..... | N47 | RED..... | I35 | SWVE..... | I89 |
| PDFS-B..... | N65 | RHD..... | P13 | T..... | I21 |



Alphanumerical index

Industrial Tube Fittings Europe – Alphanumerical index

| Order code | Page | Order code | Page | Order code | Page |
|----------------------|---------|-----------------|----------|------------|------|
| TEE..... | I80 | WBU..... | L7 | | |
| TE-M..... | I96 | WEE..... | I80 | | |
| TE-M (KEG)..... | I99 | WEE-R..... | I79 | | |
| TE-R..... | I97 | WE-M..... | I93 | | |
| TE-R (KEG)..... | I98 | WE-M(KEG)..... | I92 | | |
| TFDE-SAMPLECASE..... | H60 | WEMLO..... | J14 | | |
| TH-M..... | I86 | WEMTX..... | K14 | | |
| TH-M-KDS..... | I85 | WE-NPT..... | I91 | | |
| TH-R..... | I88 | WE-R..... | I94 | | |
| TH-R-KDS..... | I87 | WE-R (KEG)..... | I95 | | |
| TL..... | J7 | WF5OLO..... | J29 | | |
| TPL..... | J6 | WFS..... | N23 | | |
| TR..... | I22 | WFS-G..... | N26 | | |
| TRBU..... | L9 | WGMTX..... | K74 | | |
| TRMLO..... | J23 | WH-M..... | I82 | | |
| TRMTX..... | K23 | WH-M-KDS..... | I81 | | |
| TT4ML..... | J58 | WH-R..... | I84 | | |
| TT4MX..... | K80 | WH-R-KDS..... | I83 | | |
| TT8ML..... | J59 | WJJLO..... | J17 | | |
| TTP4ML..... | J60 | WJJTX..... | K17 | | |
| TTP4MX..... | K81 | WJLO..... | J16 | | |
| TU..... | L5 | WJTX..... | K16 | | |
| TW3L..... | J72 | WLN..... | K91 | | |
| TX..... | K7 | WLNML..... | J72 | | |
| V3MX..... | K59 | WMK4WL4NM..... | O27 | | |
| V3P4..... | O58 | WMLO..... | J13 | | |
| V3T4..... | O55 | WMTX..... | K13 | | |
| V4OMLO..... | J46 | WNLO..... | J15 | | |
| V4OMX..... | K56 | WNTX..... | K15 | | |
| V5OMLO..... | J45 | WSV..... | I26 | | |
| V5OMX..... | K55 | WV..... | P63 | | |
| V6LO..... | J20 | WZK..... | H55 | | |
| V6MX..... | K19 | XEMQ..... | N32 | | |
| V87OMLO..... | J44 | XHML6..... | J66, K89 | | |
| V87OMX..... | K54 | XHMLO..... | J65, K88 | | |
| V8OMLO..... | J47 | XHQ..... | N31 | | |
| V8OMX..... | K57 | XVQ..... | N33 | | |
| VDHA..... | P62 | | | | |
| VEE..... | I80 | | | | |
| VH..... | I119 | | | | |
| VKA..... | I114 | | | | |
| VKA1..... | R6 | | | | |
| VKA3..... | R10 | | | | |
| VKAM..... | I115 | | | | |
| VMTX..... | K58 | | | | |
| VOMO..... | H5 | | | | |
| VSTI M/R-ED..... | I113 | | | | |
| VSTI M-OR..... | I112 | | | | |
| W..... | I20 | | | | |
| WAS..... | M4, N38 | | | | |